

# Remote Condenser

MXG - MC - MF - MAR ice machine models

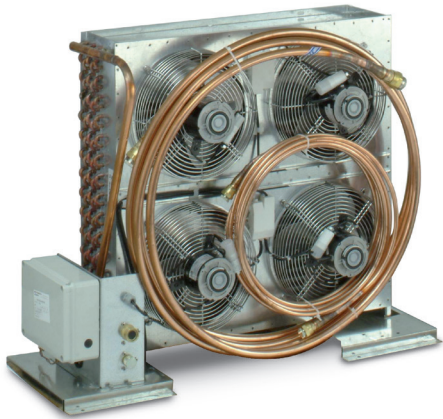

## FEATURES

- Operate in wide outdoor temperature range from +5°C to 50°C.
- Single piping circuit for single unit installation.
- Heavy gauge galvanized steel for corrosion resistance.
- Thermally protected fan motors.
- PVC coated steel fan guards.
- Direct drive fan blades.
- Standard Aero-Quip fittings.
- Maximizes ice production by dissipating heat away from ice machine.
- Minimizes air conditioning load.

## TUBE LINE SETS

Pre-charged, insulated, refrigerant line sets with easy to install quick-connect couplings (10 meters).

OPERATING REQUIREMENTS			REFRIGERANT GAS	VOLTAGE V/Hz/ph
	Minimum	Maximum		
Air temperature for Standard Version	+5°C	+43°C	R404A	230/50/1
Air temperature for Tropical Version	+5°C	+50°C	R448A	
			R449A	
			R452A	
Electrical voltage	-10%	+10%		

Model number	Matching ice machines	Version	Unit size (W x D x H) mm	Unit weight kg	Shipping size (W x D x H) mm	Shipping weight kg
RMTCND 164656J	MXG 438-638 NW 1008 MC 46 MF 56	Standard	603 x 440 x 434	14	660 x 500 x 400	26
RMTCND MF6100J	MXG 938 MF 66	Standard	753 x 440 x 584	22	810 x 650 x 400	35
RMTCND ASK0000	MF 86	Standard	1303 x 440 x 584	40	1350 x 640 x 400	53
RMTCND ASK0002	MAR 306	Standard	1303 x 440 x 584	40	1350 x 640 x 400	53
RMTCND MF6100J	MF 56	Tropical	753 x 440 x 584	22	810 x 650 x 400	35
RMTCND ASK0004	MF 66	Tropical	1303 x 440 x 584	40	1350 x 640 x 400	53
RMTCND ASK0001	MF 86 MAR 306	Tropical	1304 x 440 x 1134	75	1350 x 450 x 1200	84

**IMPORTANT NOTICE:**  
Models and specifications are subject to change without notice. This spec sheet is meant for commercial purpose only. For technical documentation please refer to our service manuals.

Download our free App Scotsman Ice  
[Apple store](#)  
[Google play](#)  
[Windows store](#)

DOWNLOAD

[www.scotsman-ice.it](http://www.scotsman-ice.it)  
[www.scotsman-ice.com](http://www.scotsman-ice.com)

# Remote Condenser

MXG - MC - MF - MAR ice machine models

Remote Condenser

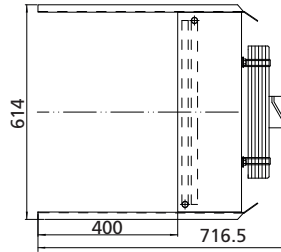
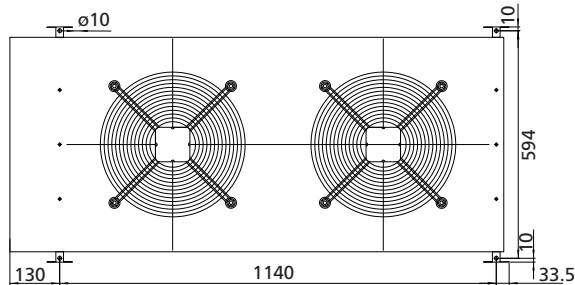

RMTCNDASK000  
RMTCNDASK002  
RMTCNDASK004

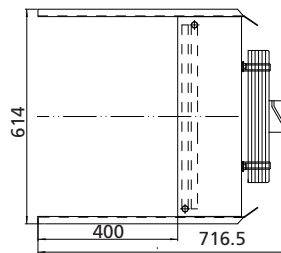
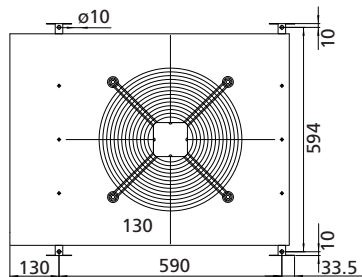

RMTCNDMF6100J

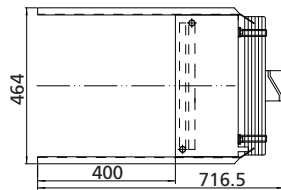
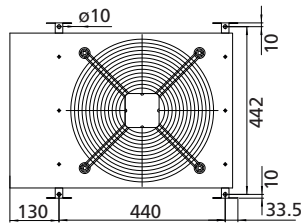

RMTCND164656J

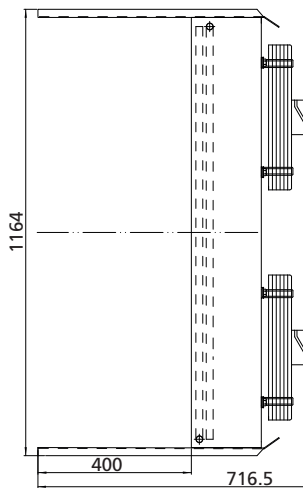
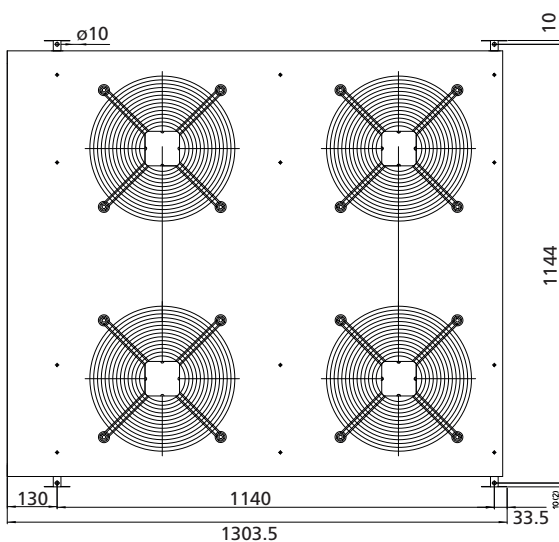

RMTCNDASK0001

Measurement in mm

Model number	kW	Air Flow m3/h	No. fans	Electric consumption W	Amp	dB(A) 10 m
RMTCND 164656J	4,5	2390	1 x 350mm	180	0,8	43
RMTCND MF6100J	10	2160	1 x 350mm	180	0,8	43
RMTCND ASK0000	20	4320	2 x 350mm	360	1,6	46
RMTCND ASK0002	20	4320	2 x 350mm	360	1,6	46
RMTCND ASK0004	20	4320	2 x 350mm	360	1,6	46
RMTCND ASK0001	40	8640	4 x 350mm	720	3,2	49