

# Service Manual

## Air Conditioner

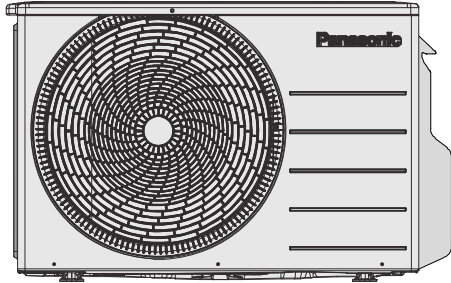

**Outdoor Unit**  
**CU-2TZ41TBE**  
**CU-2TZ50TBE**

**Destination**  
**Europe**  
**Turkey**

Please file and use this manual together with the service manual for Model No. CS-MTZ16TKE CS-TZ20TKEW CS-TZ25TKEW CS-TZ35TKEW CS-TZ42TKEW CS-TZ50TKEW CS-TE20TKEW CS-TE25TKEW CS-TE35TKEW CS-TE42TKEW CS-TE50TKEW CS-TZ20TKEW-1 CS-TZ25TKEW-1 CS-TZ35TKEW-1 CS-TZ42TKEW-1 Order No. PAPAMY1702032CE, PAPAMY1703046CE, PAPAMY1703052CE, PAPAMY1704061CE, PAPAMY1801024CE, PAPAMY1802072CE

### **WARNING**

This service information is designed for experienced repair technicians only and is not designed for use by the general public. It does not contain warnings or cautions to advise non-technical individuals of potential dangers in attempting to service a product. Products powered by electricity should be serviced or repaired only by experienced professional technicians. Any attempt to service or repair the product or products dealt with in this service information by anyone else could result in serious injury or death.

### **IMPORTANT SAFETY NOTICE**

There are special components used in this equipment which are important for safety. These parts are marked by  in the Schematic Diagrams, Circuit Board Diagrams, Exploded Views and Replacement Parts List. It is essential that these critical parts should be replaced with manufacturer's specified parts to prevent shock, fire or other hazards. Do not modify the original design without permission of manufacturer.

### **PRECAUTION OF LOW TEMPERATURE**

In order to avoid frostbite, be assured of no refrigerant leakage during the installation or repairing of refrigerant circuit.

### **CAUTION**

**R32 REFRIGERANT** – This Air Conditioner contains and operates with refrigerant R32.

**THIS PRODUCT MUST ONLY BE INSTALLED OR SERVICED BY QUALIFIED PERSONNEL.**

Refer to Commonwealth, State, Territory and local legislation, regulations, codes, installation & operation manuals, before the installation, maintenance and/or service of this product.



# TABLE OF CONTENTS

	PAGE		PAGE
<b>1. Safety Precautions</b> .....	<b>3</b>	14.13 Compressor Protection Control (Gas leak detection control 1) .....	37
<b>2. Precaution for Using R32 Refrigerant</b> .....	<b>5</b>	14.14 Compressor Protection Control (Gas leak detection control 2) .....	37
<b>3. Specifications</b> .....	<b>9</b>	14.15 Valve close detection control.....	37
3.1 CU-2TZ41TBE.....	9	14.16 Compressor discharge high pressure protection control .....	37
3.2 CU-2TZ50TBE.....	11	14.17 Compressor discharge high temperature protection control .....	38
<b>4. Dimensions</b> .....	<b>16</b>	14.18 Cooling Outdoor Air Temperature Control (Cool).....	38
<b>5. Refrigeration Cycle Diagram</b> .....	<b>17</b>	14.19 Heating Outdoor Air Temperature Control (Heat).....	38
<b>6. Block Diagram</b> .....	<b>18</b>	<b>15. Servicing Mode</b> .....	<b>39</b>
<b>7. Wiring Connection Diagram</b> .....	<b>19</b>	15.1 Pump down operation.....	39
<b>8. Electronic Circuit Diagram</b> .....	<b>20</b>	15.2 Heating only function.....	39
<b>9. Printed Circuit Board</b> .....	<b>21</b>	<b>16. Troubleshooting Guide</b> .....	<b>40</b>
9.1 Main Printed Circuit Board .....	21	16.1 Self Diagnosis Function.....	40
9.2 Noise Filter Printed Circuit Board .....	22	<b>17. Disassembly and Assembly Instructions</b> .....	<b>42</b>
<b>10. Installation Information</b> .....	<b>23</b>	17.1 Outdoor Unit Removal Procedure .....	42
10.1 CU-2TZ41TBE.....	23	<b>18. Technical Data</b> .....	<b>44</b>
10.2 CU-2TZ50TBE.....	24	18.1 Cool Mode Performance Data.....	44
<b>11. Installation Instruction</b> .....	<b>25</b>	18.2 Heat Mode Performance Data.....	52
11.1 Outdoor Unit .....	25	<b>19. Service Data</b> .....	<b>59</b>
<b>12. Operation Control</b> .....	<b>30</b>	19.1 Operation Characteristics (CU-2TZ41TBE) ...	59
12.1 Cooling Operation.....	30	19.2 Operation Characteristics (CU-2Z50TBE).....	71
12.2 Heating Operation .....	31	<b>20. Exploded View and Replacement Parts List</b> .....	<b>91</b>
12.3 Outdoor Quiet Cooling Operation Control .....	31	.....	
<b>13. Simultaneous Operation Control</b> .....	<b>33</b>		
<b>14. Protection Control</b> .....	<b>34</b>		
14.1 Freeze Prevention control (Cool) .....	34		
14.2 Dew Prevention control (Cool) .....	34		
14.3 Electronic Parts Temperature Rise Protection 1 (Cool).....	34		
14.4 Electronic Parts Temperature Rise Protection 2 (Cool).....	34		
14.5 Cooling overload control (Cool).....	35		
14.6 Heating overload control (Heat) .....	35		
14.7 Extreme Low Temperature Compressor low pressure protection control (Heat).....	35		
14.8 Deice Control.....	36		
14.9 Time Delay Safety Control (Restart Control).....	36		
14.10 30 seconds Force Operation .....	36		
14.11 Total Current Control .....	36		
14.12 IPM (power transistor) Protection Control .....	<b>Error! Bookmark not defined.</b>		



• Specifications, designs and contents in this Service Manual are subject to change without notice.

# 1. Safety Precautions





















- Read the following “SAFETY PRECAUTIONS” carefully before installation.
- Electrical work must be installed by a licensed electrician. Be sure to use the correct rating of the power plug and main circuit for the model to be installed.
- The caution items stated here must be followed because these important contents are related to safety. The meaning of each indication used is as below. Incorrect installation due to ignoring of the instruction will cause harm or damage, and the seriousness is classified by the following indications.

 <b>WARNING</b>	This indication shows the possibility of causing death or serious injury.
 <b>CAUTION</b>	This indication shows the possibility of causing injury or damage to properties only.













- The items to be followed are classified by the symbols:

	Symbol with white background denotes item that is PROHIBITED.
 	Symbol with dark background denotes item that must be carried out.











- Carry out test running to confirm that no abnormality occurs after the installation. Then, explain to user the operation, care and maintenance as stated in instructions. Please remind the customer to keep the operating instructions for future reference.
- This appliance is not intended for accessibility by the general public.

 <b>WARNING</b>	
1. Do not use means to accelerate the defrosting process or to clean, other than those recommended by the manufacturer. Any unfit method or using incompatible material may cause product damage, burst and serious injury.	
2. Do not install outdoor unit near handrail of veranda. When installing air-conditioner unit on veranda of a high rise building, child may climb up to outdoor unit and cross over the handrail causing an accident.	
3. Do not use unspecified cord, modified cord, joint cord or extension cord for power supply cord. Do not share the single outlet with other electrical appliances. Poor contact, poor insulation or over current will cause electrical shock or fire.	
4. The appliance shall be stored in a well ventilated room with indoor floor area larger than $A_{min}$ (m <sup>2</sup> ) [refer Table A] and without any continuously operating ignition source. Keep away from open flames, any operating gas appliances or any operating electric heater. Else, it may explode and cause injury or death.	
5. Do not tie up the power supply cord into a bundle by band. Abnormal temperature rise on power supply cord may happen.	
6. Do not insert your fingers or other objects into the unit, high speed rotating fan may cause injury. 	
7. Do not sit or step on the unit, you may fall down accidentally. 	
8. The appliance shall be installed, and/or operated in a room with floor area larger than $A_{min}$ (m <sup>2</sup> ) [refer Table A] and keep away from ignition sources, such as heat/sparks/open flame or hazardous areas such as gas appliances, gas cooking, reticulated gas supply systems or electric cooking appliances, etc.	
9. Keep plastic bag (packaging material) away from small children, it may cling to nose and mouth and prevent breathing.	
10. When installing or relocating air conditioner, do not let any substance other than the specified refrigerant, eg. air etc mix into refrigeration cycle (piping). Mixing of air etc. will cause abnormal high pressure in refrigeration cycle and result in explosion, injury etc.	
11. Do not pierce or burn as the appliance is pressurized. Do not expose the appliance to heat, flame, sparks, or other sources of ignition. Else, it may explode and cause injury or death.	
12. Do not add or replace refrigerant other than specified type. It may cause product damage, burst and injury etc.	
13. Do not perform flare connection inside a building or dwelling or room, when joining the heat exchanger of indoor unit with interconnecting piping. Refrigerant connection inside a building or dwelling or room must be made by brazing or welding. Joint connection of indoor unit by flaring method can only be made at outdoor or at outside of a building or dwelling or room. Flare connection may cause gas leak and flammable atmosphere.	
14. For R32 model, use piping, flare nut and tools which is specified for R32 refrigerant. Using of existing (R22) piping, flare nut and tools may cause abnormally high pressure in the refrigerant cycle (piping), and possibly result in explosion and injury. Thickness for copper pipes used with R32 must be more than 0.8 mm. Never use copper pipes thinner than 0.8 mm. It is desirable that the amount of residual oil less than 40 mg/10 m.	
15. Engage authorized dealer or specialist for installation. If installation done by the user is incorrect, it will cause water leakage, electrical shock or fire.	
16. For refrigeration system work, install according to this installation instructions strictly. If installation is defective, it will cause water leakage, electrical shock or fire.	
17. Use the attached accessories parts and specified parts for installation. Otherwise, it will cause the set to fall, water leakage, fire or electrical shock.	

 **WARNING**



18.	Install at a strong and firm location which is able to withstand weight of the set. If the strength is not enough or installation is not properly done, the set will drop and cause injury.	
19.	For electrical work, follow the national regulation, legislation and this installation instructions. An independent circuit and single outlet must be used. If electrical circuit capacity is not enough or defect found in the electrical work, it will cause electrical shock or fire.	
20.	Do not use joint cable for indoor / outdoor connection cable. Use the specified indoor/outdoor connection cable, refer to instruction <b>CONNECT THE CABLE TO THE INDOOR UNIT</b> and connect tightly for indoor/outdoor connection. Clamp the cable so that no external force will have impact on the terminal. If connection or fixing is not perfect, it will cause heat up or fire at the connection.	
21.	Wire routing must be properly arranged so that control board cover is fixed properly. If control board cover is not fixed perfectly, it will cause fire or electrical shock.	
22.	This equipment is strongly recommended to be installed with Earth Leakage Circuit Breaker (ELCB) or Residual Current Device (RCD), with sensitivity of 30mA at 0.1 sec or less. Otherwise, it may cause electrical shock and fire in case of equipment breakdown or insulation breakdown.	
23.	During installation, install the refrigerant piping properly before running the compressor. Operation of compressor without fixing refrigeration piping and valves at opened position will cause suck-in of air, abnormal high pressure in refrigeration cycle and result in explosion, injury etc.	
24.	During pump down operation, stop the compressor before removing the refrigeration piping. Removal of refrigeration piping while compressor is operating and valves are opened will cause suck-in of air, abnormal high pressure in refrigeration cycle and result in explosion, injury etc.	
25.	Tighten the flare nut with torque wrench according to specified method. If the flare nut is over-tightened, after a long period, the flare may break and cause refrigerant gas leakage.	
26.	After completion of installation, confirm there is no leakage of refrigerant gas. It may generate toxic gas when the refrigerant contacts with fire.	
27.	Ventilate if there is refrigerant gas leakage during operation. It may cause toxic gas when the refrigerant contacts with fire.	
28.	Be aware that refrigerants may not contain an odour.	
29.	This equipment must be properly earthed. Earth line must not be connected to gas pipe, water pipe, earth of lightning rod and telephone. Otherwise, it may cause electrical shock in case of equipment breakdown or insulation breakdown.	

 **CAUTION**

1.	Do not install the unit in a place where leakage of flammable gas may occur. In case gas leaks and accumulates at surrounding of the unit, it may cause fire.	
2.	Prevent liquid or vapor from entering sumps or sewers since vapor is heavier than air and may form suffocating atmospheres.	
3.	Do not release refrigerant during piping work for installation, re-installation and during repairing refrigeration parts. Take care of the liquid refrigerant, it may cause frostbite.	
4.	Do not install this appliance in a laundry room or other location where water may drip from the ceiling, etc.	
5.	Do not touch the sharp aluminium fin, sharp parts may cause injury. 	
6.	Carry out drainage piping as mentioned in installation instructions. If drainage is not perfect, water may enter the room and damage the furniture.	
7.	Select an installation location which is easy for maintenance. Incorrect installation, service or repair of this air conditioner may increase the risk of rupture and this may result in loss damage or injury and/or property.	
8.	Power supply connection to the room air conditioner. Use power supply cord 3 x 1.5 mm <sup>2</sup> type designation 60245 IEC 57 or heavier cord. Connect the power supply cord of the air conditioner to the mains using one of the following method. Power supply point should be in easily accessible place for power disconnection in case of emergency. In some countries, permanent connection of this air conditioner to the power supply is prohibited. 1) Power supply connection to the receptacle using power plug. Use an approved 15/16A power plug with earth pin for the connection to the socket. 2) Power supply connection to a circuit breaker for the permanent connection. Use an approved 16A circuit breaker for the permanent connection. It must be a double pole switch with a minimum 3.0 mm contact gap.	
9.	Installation work. It may need two people to carry out the installation work.	

## 2. Precaution for Using R32 Refrigerant

- The basic installation work procedures are the same as conventional refrigerant (R410A, R22) models. However, pay careful attention to the following points:

 <b>WARNING</b>	
Since the working pressure is higher than that of refrigerant R22 models, some of the piping and installation and service tools are special. (See "2.1. Special tools for R32 (R410A)".)	
1.	Especially, when replacing a refrigerant R22 model with a new refrigerant R32 model, always replace the conventional piping and flare nuts with the R32 and R410A piping and flare nuts on the outdoor unit side. For R32 and R410A, the same flare nut on the outdoor unit side and pipe can be used.
2.	Models that use refrigerant R32 and R410A have a different charging port thread diameter to prevent erroneous charging with refrigerant R22 and for safety. Therefore, check beforehand. [The charging port thread diameter for R32 and R410A is 12.7 mm (1/2 inch).]
3.	Be more careful than R22 so that foreign matter (oil, water, etc.) does not enter the piping. Also, when storing the piping, securely seal the opening by pinching, taping, etc. (Handling of R32 is similar to R410A.)
 <b>CAUTION</b>	
<b>Installation (Space)</b>	
1.	<ul style="list-style-type: none"> <li>Must ensure the installation of pipe-work shall be kept to a minimum. Avoid use dented pipe and do not allow acute bending.</li> <li>Must ensure that pipe-work shall be protected from physical damage.</li> <li>Must comply with national gas regulations, state municipal rules and legislation. Notify relevant authorities in accordance with all applicable regulations.</li> <li>Must ensure mechanical connections be accessible for maintenance purposes.</li> <li>In cases that require mechanical ventilation, ventilation openings shall be kept clear of obstruction.</li> <li>When disposal of the product, do follow to the precautions in #12 and comply with national regulations.</li> </ul> <p>Always contact to local municipal offices for proper handling.</p>
<b>Servicing</b>	
2-1. Service personnel	
<ul style="list-style-type: none"> <li>Any qualified person who is involved with working on or breaking into a refrigerant circuit should hold a current valid certificate from an industry-accredited assessment authority, which authorizes their competence to handle refrigerants safely in accordance with an industry recognized assessment specification.</li> <li>Servicing shall only be performed as recommended by the equipment manufacturer. Maintenance and repair requiring the assistance of other skilled personnel shall be carried out under the supervision of the person competent in the use of flammable refrigerants.</li> <li>Servicing shall be performed only as recommended by the manufacturer.</li> </ul>	
2-2. Work	
<ul style="list-style-type: none"> <li>Prior to beginning work on systems containing flammable refrigerants, safety checks are necessary to ensure that the risk of ignition is minimised.</li> <li>For repair to the refrigerating system, the precautions in #2-2 to #2-8 must be followed before conducting work on the system.</li> <li>Work shall be undertaken under a controlled procedure so as to minimize the risk of a flammable gas or vapour being present while the work is being performed.</li> <li>All maintenance staff and others working in the local area shall be instructed and supervised on the nature of work being carried out.</li> <li>Avoid working in confined spaces.</li> <li>Wear appropriate protective equipment, including respiratory protection, as conditions warrant.</li> <li>Ensure that the conditions within the area have been made safe by limit of use of any flammable material. Keep all sources of ignition and hot metal surfaces away.</li> </ul>	
2.	2-3. Checking for presence of refrigerant
<ul style="list-style-type: none"> <li>The area shall be checked with an appropriate refrigerant detector prior to and during work, to ensure the technician is aware of potentially flammable atmospheres.</li> <li>Ensure that the leak detection equipment being used is suitable for use with flammable refrigerants, i.e. non sparking, adequately sealed or intrinsically safe.</li> <li>In case of leakage/spillage happened, immediately ventilate area and stay upwind and away from spill/release.</li> <li>In case of leakage/spillage happened, do notify persons down wind of the leaking/spill, isolate immediate hazard area and keep unauthorized personnel out.</li> </ul>	
2-4. Presence of fire extinguisher	
<ul style="list-style-type: none"> <li>If any hot work is to be conducted on the refrigeration equipment or any associated parts, appropriate fire extinguishing equipment shall be available at hand.</li> <li>Have a dry powder or CO<sub>2</sub> fire extinguisher adjacent to the charging area.</li> </ul>	
2-5. No ignition sources	
<ul style="list-style-type: none"> <li>No person carrying out work in relation to a refrigeration system which involves exposing any pipe work that contains or has contained flammable refrigerant shall use any sources of ignition in such a manner that it may lead to the risk of fire or explosion. He/She must not be smoking when carrying out such work.</li> <li>All possible ignition sources, including cigarette smoking, should be kept sufficiently far away from the site of installation, repairing, removing and disposal, during which flammable refrigerant can possibly be released to the surrounding space.</li> <li>Prior to work taking place, the area around the equipment is to be surveyed to make sure that there are no flammable hazards or ignition risks.</li> <li>"No Smoking" signs shall be displayed.</li> </ul>	

 **CAUTION**

**2-6. Ventilated area**

- Ensure that the area is in the open or that it is adequately ventilated before breaking into the system or conducting any hot work.
- A degree of ventilation shall continue during the period that the work is carried out.
- The ventilation should safely disperse any released refrigerant and preferably expel it externally into the atmosphere.

**2-7. Checks to the refrigeration equipment**

- Where electrical components are being changed, they shall be fit for the purpose and to the correct specification.
  - At all times the manufacturer's maintenance and service guidelines shall be followed.
  - If in doubt consult the manufacturer's technical department for assistance.
  - The following checks shall be applied to installations using flammable refrigerants.
    - The charge size is in accordance with the room size within which the refrigerant containing parts are installed.
    - The ventilation machinery and outlets are operating adequately and are not obstructed.
    - If an indirect refrigerating circuit is being used, the secondary circuit shall be checked for the presence of refrigerant.
    - Marking to the equipment continues to be visible and legible. Markings and signs that are illegible shall be corrected.
2. - Refrigeration pipe or components are installed in a position where they are unlikely to be exposed to any substance which may corrode refrigerant containing components, unless the components are constructed of materials which are inherently resistant to being corroded or are properly protected against being so corroded.

**2-8. Checks to electrical devices**

- Repair and maintenance to electrical components shall include initial safety checks and component inspection procedures.
- Initial safety checks shall include but not limit to:-
  - That capacitors are discharged: this shall be done in a safe manner to avoid possibility of sparking.
  - That there is no live electrical components and wiring are exposed while charging, recovering or purging the system.
  - That there is continuity of earth bonding.
- At all times the manufacturer's maintenance and service guidelines shall be followed.
- If in doubt consult the manufacturer's technical department for assistance.
- If a fault exists that could compromise safety, then no electrical supply shall be connected to the circuit until it is satisfactorily dealt with.
- If the fault cannot be corrected immediately but it is necessary to continue operation, an adequate temporary solution shall be used.
- The owner of the equipment must be informed or reported so all parties are advised thereafter.

**Repairs to sealed components**

- During repairs to sealed components, all electrical supplies shall be disconnected from the equipment being worked upon prior to any removal of sealed covers, etc.
  - If it is absolutely necessary to have an electrical supply to equipment during servicing, then a permanently operating form of leak detection shall be located at the most critical point to warn of a potentially hazardous situation.
  - Particular attention shall be paid to the following to ensure that by working on electrical components, the casing is not altered in such a way that the level of protection is affected. This shall include damage to cables, excessive number of connections, terminals not made to original specification, damage to seals, incorrect fitting of glands, etc.
3. • Ensure that apparatus is mounted securely.
- Ensure that seals or sealing materials have not degraded such that they no longer serve the purpose of preventing the ingress of flammable atmospheres.
  - Replacement parts shall be in accordance with the manufacturer's specifications.
- NOTE: The use of silicon sealant may inhibit the effectiveness of some types of leak detection equipment.  
Intrinsically safe components do not have to be isolated prior to working on them.

**Repair to intrinsically safe components**

- Do not apply any permanent inductive or capacitance loads to the circuit without ensuring that this will not exceed the permissible voltage and current permitted for the equipment in use.
4. • Intrinsically safe components are the only types that can be worked on while live in the presence of a flammable atmosphere.
- The test apparatus shall be at the correct rating.
  - Replace components only with parts specified by the manufacturer. Unspecified parts by manufacturer may result ignition of refrigerant in the atmosphere from a leak.

**Cabling**

5. • Check that cabling will not be subject to wear, corrosion, excessive pressure, vibration, sharp edges or any other adverse environmental effects.
- The check shall also take into account the effects of aging or continual vibration from sources such as compressors or fans.

**Detection of flammable refrigerants**

6. • Under no circumstances shall potential sources of ignition be used in the searching or detection of refrigerant leaks.
- A halide torch (or any other detector using a naked flame) shall not be used.

**Leak detection methods**

- Electronic leak detectors shall be used to detect flammable refrigerants, but the sensitivity may not be adequate, or may need re-calibration.  
(Detection equipment shall be calibrated in a refrigerant-free area.)
7. • Ensure that the detector is not a potential source of ignition and is suitable for the refrigerant used.
- Leak detection equipment shall be set at a percentage of the LFL of the refrigerant and shall be calibrated to the refrigerant employed and the appropriate percentage of gas (25 % maximum) is confirmed.
  - Leak detection fluids are suitable for use with most refrigerants but the use of detergents containing chlorine shall be avoided as the chlorine may react with the refrigerant and corrode the copper pipe-work.
  - If a leak is suspected, all naked flames shall be removed/extinguished.
  - If a leakage of refrigerant is found which requires brazing, all of the refrigerant shall be recovered from the system, or isolated (by means of shut off valves) in a part of the system remote from the leak. Oxygen free nitrogen (OFN) shall then be purged through the system both before and during the brazing process.

 **CAUTION**

**Removal and evacuation**

• When breaking into the refrigerant circuit to make repairs – or for any other purpose – conventional procedures shall be used. However, it is important that best practice is followed since flammability is a consideration. The following procedure shall be adhered to:

- remove refrigerant -> • purge the circuit with inert gas -> • evacuate -> • purge again with inert gas -> • open the circuit by cutting or brazing
- The refrigerant charge shall be recovered into the correct recovery cylinders.
- The system shall be "flushed" with OFN to render the unit safe.
- 8. • This process may need to be repeated several times.
- Compressed air or oxygen shall not be used for this task.
- Flushing shall be achieved by breaking the vacuum in the system with OFN and continuing to fill until the working pressure is achieved, then venting to atmosphere, and finally pulling down to a vacuum.
- This process shall be repeated until no refrigerant is within the system.
- When the final OFN charge is used, the system shall be vented down to atmospheric pressure to enable work to take place.
- This operation is absolutely vital if brazing operations on the pipe work are to take place.
- Ensure that the outlet for the vacuum pump is not close to any ignition sources and there is ventilation available.

**Charging procedures**

• In addition to conventional charging procedures, the following requirements shall be followed.

- Ensure that contamination of different refrigerants does not occur when using charging equipment.
- Hoses or lines shall be as short as possible to minimize the amount of refrigerant contained in them.
- Cylinders shall be kept upright.
- Ensure that the refrigeration system is earthed prior to charging the system with refrigerant.

9. • Label the system when charging is complete (if not already).

- Extreme care shall be taken not to over fill the refrigeration system.
- Prior to recharging the system it shall be pressure tested with OFN (refer to #7).
- The system shall be leak tested on completion of charging but prior to commissioning.
- A follow up leak test shall be carried out prior to leaving the site.
- Electrostatic charge may accumulate and create a hazardous condition when charging and discharging the refrigerant. To avoid fire or explosion, dissipate static electricity during transfer by grounding and bonding containers and equipment before charging/discharging.

**Decommissioning**

- Before carrying out this procedure, it is essential that the technician is completely familiar with the equipment and all its details.
  - It is recommended good practice that all refrigerants are recovered safely.
  - Prior to the task being carried out, an oil and refrigerant sample shall be taken in case analysis is required prior to re-use of reclaimed refrigerant.
  - It is essential that electrical power is available before the task is commenced.
10. a) Become familiar with the equipment and its operation.
- b) Isolate system electrically.
- c) Before attempting the procedure ensure that:
- *mechanical handling equipment is available, if required, for handling refrigerant cylinders;*
  - *all personal protective equipment is available and being used correctly;*
  - *the recovery process is supervised at all times by a competent person;*
  - *recovery equipment and cylinders conform to the appropriate standards.*
- d) Pump down refrigerant system, if possible.
- e) If a vacuum is not possible, make a manifold so that refrigerant can be removed from various parts of the system.
- Electrostatic charge may accumulate and create a hazardous condition when charging or discharging the refrigerant. To avoid fire or explosion, dissipate static electricity during transfer by grounding and bonding containers and equipment before charging/discharging.
- f) Make sure that cylinder is situated on the scales before recovery takes place.
- g) Start the recovery machine and operate in accordance with manufacturer's instructions.
- h) Do not over fill cylinders. (No more than 80 % volume liquid charge).
- i) Do not exceed the maximum working pressure of the cylinder, even temporarily.
- j) When the cylinders have been filled correctly and the process completed, make sure that the cylinders and the equipment are removed from site promptly and all isolation valves on the equipment are closed off.
- k) Recovered refrigerant shall not be charged into another refrigeration system unless it has been cleaned and checked.

**Labelling**

11. • Equipment shall be labelled stating that it has been de-commissioned and emptied of refrigerant.
- The label shall be dated and signed.
  - Ensure that there are labels on the equipment stating the equipment contains flammable refrigerant.

 CAUTION

**Recovery**

- When removing refrigerant from a system, either for servicing or decommissioning, it is recommended good practice that all refrigerants are removed safely.
- When transferring refrigerant into cylinders, ensure that only appropriate refrigerant recovery cylinders are employed.
- Ensure that the correct number of cylinders for holding the total system charge are available.
- All cylinders to be used are designated for the recovered refrigerant and labelled for that refrigerant (i.e. special cylinders for the recovery of refrigerant).
- Cylinders shall be complete with pressure relief valve and associated shut-off valves in good working order.
- Recovery cylinders are evacuated and, if possible, cooled before recovery occurs.
- The recovery equipment shall be in good working order with a set of instructions concerning the equipment that is at hand and shall be suitable for the recovery of concerning the equipment that is at hand and shall be suitable for the recovery of flammable refrigerants.
- 12. • In addition, a set of calibrated weighing scales shall be available and in good working order.
- Hoses shall be complete with leak-free disconnect couplings and in good condition.
- Before using the recovery machine, check that it is in satisfactory working order, has been properly maintained and that any associated electrical components are sealed to prevent ignition in the event of a refrigerant release.  
Consult manufacturer if in doubt.
- The recovered refrigerant shall be returned to the refrigerant supplier in the correct recovery cylinder, and the relevant Waste Transfer Note arranged.
- Do not mix refrigerants in recovery units and especially not in cylinders.
- If compressors or compressor oils are to be removed, ensure that they have been evacuated to an acceptable level to make certain that flammable refrigerant does not remain within the lubricant.
- The evacuation process shall be carried out prior to returning the compressor to the suppliers.
- Only electric heating to the compressor body shall be employed to accelerate this process.
- When oil is drained from a system, it shall be carried out safely.



## 3. Specifications

### 3.1 CU-2TZ41TBE

Item		Unit	OUTDOOR UNIT	
Indoor Unit Combination			1.6kW + 2.5kW	
Power Source			1 Phase, 230V, 50Hz (Power supply from outdoor unit)	
Cooling Operation	Capacity		kW	4.1 (1.5 ~ 4.7)
			BTU/h	14000 (5120 ~ 16000)
	Electrical Data	Running Current	A	4.60
		Power Input	kW	0.99 (0.27 ~ 1.38)
		EER	W/W	4.14 (5.56 ~ 3.41)
	Annual Energy Consumption (A.E.C)		kWh	495
	Annual Consumption		kWh	202
	Noise	Sound Pressure Level	dB-A (H/L)	48 / -
Sound Power Level		dB (H/L)	63 / -	
Heating Operation	Capacity		kW	4.4 (1.1 ~ 6.3)
			BTU/h	15000 (3750 ~ 21500)
	Electrical Data	Running Current	A	4.60
		Power Input	kW	0.99 (0.22 ~ 1.78)
		COP	W/W	4.44 (5.00 ~ 3.54)
	Annual Consumption		kWh	1139
	Noise	Sound Pressure Level	dB-A (H/L)	50 / -
		Sound Power Level	dB (H/L)	65 / -
Maximum Current		A	11.5	
Maximum Input Power		W	2.60k	
Starting Current		A	4.60	
Dimension	Height	mm	542	
	Width	mm	780 (+70)	
	Depth	mm	289	
Net Weight		kg	35	
Pipe Length Range (1 room)		m	3 ~ 20	
Maximum Pipe Length (Total Room)		m	30	
Piping	Standard Length	m	5	
	Height Difference	m	10	
	Add. Gas Amount	g/m	15	
	Pipe Length for Add. Gas	m	20	
Refrigerant Pipe Diameter	Liquid Side	mm (inch)	6.35 (1/4)	
	Gas Side	mm (inch)	9.52 (3/8)	
Compressor	Type		Hermetic Motor / Rotary	
	Motor Type		Brushless (4-poles)	
	Rated Output	W	900	
Fan Motor	Type		Propeller Fan	
	Motor Type		DC Motor (8-poles)	
	Rated Output	W	40	
Fan Speed	High (Cooling / Heating)	RPM	920 / 890	

Item		Unit	OUTDOOR UNIT		
Heat Exchanger	Type		Plate fin configuration forced draft type		
	Tube Material		Copper		
	Fin Material		Aluminum (Pre Coat)		
	Row / Stage		2 / 24		
	FPI		19		
Air Volume	High (Cooling / Heating)	m <sup>3</sup> /min (ft <sup>3</sup> /min)	33.1 (1170) / 33.1 (1170)		
Refrigerant Control Device			Expansion Valve		
Refrigerant Oil		cm <sup>3</sup>	FW50S (450)		
Refrigerant (R32)		g	900		
			Dry Bulb	Wet Bulb	
Outdoor Operation Range	Cooling	Maximum	°C	46	26
		Minimum	°C	-10	—
	Heating	Maximum	°C	24	18
		Minimum	°C	-15	-16

**Note**

- Specifications are subject to change without notice for further improvement.

### 3.2 CU-2TZ50TBE

Item		Unit	OUTDOOR UNIT	
Indoor Unit Combination			2.5kW + 2.5kW	
Power Source			1 Phase, 230V, 50Hz (Power supply from outdoor unit)	
Cooling Operation	Capacity		kW	5.0 (1.5 ~ 5.4)
			BTU/h	17100 (5120 ~ 18400)
	Electrical Data	Running Current	A	6.00
		Power Input	kW	1.30 (0.27 ~ 1.62)
		EER	W/W	3.85 (5.56 ~ 3.33)
	Annual Energy Consumption (A.E.C)		kWh	650
	Annual Consumption		kWh	250
	Noise	Sound Pressure Level	dB-A (H/L)	50 / -
Sound Power Level		dB (H/L)	65 / -	
Heating Operation	Capacity		kW	5.7 (1.1 ~ 6.4)
			BTU/h	19400 (3750 ~ 21800)
	Electrical Data	Running Current	A	6.00
		Power Input	kW	1.31 (0.22 ~ 1.77)
		COP	W/W	4.35 (5.00 ~ 3.62)
	Annual Consumption		kWh	1500
	Noise	Sound Pressure Level	dB-A (H/L)	52 / -
		Sound Power Level	dB (H/L)	67 / -
Maximum Current		A	12.0	
Maximum Input Power		W	2.73k	
Starting Current		A	6.00	
Dimension	Height	mm	542	
	Width	mm	780 (+70)	
	Depth	mm	289	
Net Weight		kg	35	
Pipe Length Range (1 room)		m	3 ~ 20	
Maximum Pipe Length (Total Room)		m	30	
Piping	Standard Length	m	5	
	Height Difference	m	10	
	Add. Gas Amount	g/m	15	
	Pipe Length for Add. Gas	m	20	
Refrigerant Pipe Diameter	Liquid Side	mm (inch)	6.35 (1/4)	
	Gas Side	mm (inch)	9.52 (3/8)	
Compressor	Type		Hermetic Motor / Rotary	
	Motor Type		Brushless (4-poles)	
	Rated Output	W	900	
Air Circulation	Type		Propeller Fan	
	Motor Type		DC Motor (8-poles)	
	Rated Output	W	40	
Fan Speed	High (Cooling / Heating)	RPM	1000 / 1020	

Item		Unit	OUTDOOR UNIT		
Heat Exchanger	Type		Plate fin configuration forced draft type		
	Tube Material		Copper		
	Fin Material		Aluminum (Pre Coat)		
	Row / Stage		2 / 24		
	FPI		19		
Air Volume	High (Cooling / Heating)	m <sup>3</sup> /min (ft <sup>3</sup> /min)	34.9 (1230) / 34.9 (1230)		
Refrigerant Control Device			Expansion Valve		
Refrigerant Oil		cm <sup>3</sup>	FW50S (450)		
Refrigerant (R32)		g	900		
			Dry Bulb	Wet Bulb	
Outdoor Operation Range	Cooling	Maximum	°C	46	26
		Minimum	°C	-10	—
	Heating	Maximum	°C	24	18
		Minimum	°C	-15	-16

**Note**

- Specifications are subject to change without notice for further improvement.

- **Multi Split Combination Possibility:**

- A single outdoor unit enables air conditioning of up to two separate rooms for CU-2TZ41TBE, CU-2TZ50TBE.

Connectable Indoor Unit			Outdoor Unit				
			CU-2TZ41TBE		CU-2TZ50TBE		
			A	B	A	B	
Wall	1.6kW	CS-MTZ16TKE	•	•	•	•	
	2.0kW	CS-TZ20TKEW-1	•	•	•	•	
		CS-TZ20TKEW					
		CS-TE20TKEW					
	2.5kW	CS-TZ25TKEW-1	•	•	•	•	
		CS-TZ25TKEW					
		CS-TE25TKEW					
	3.5kW	CS-TZ35TKEW-1	•	-	•	•	
		CS-TZ35TKEW					
		CS-TE35TKEW					
	4.2kW	CS-TZ42TKEW-1	-	-	•	-	
		CS-TZ42TKEW					
		CS-TE42TKEW					
	5.0kW	CS-TZ50TKEW	-	-	•	-	
		CS-TE50TKEW					
	Capacity range of connectable indoor units			3.2kW ~ 6.0kW		3.2kW ~ 7.7kW	
	Pipe Length	1-room maximum pipe length (m)		20		20	
		Allowable elevation (m)		10		10	
Total allowable pipe length (m)		30		30			
Total pipe length for maximum chargeless length (m)		20		20			
Additional gas amount over chargeless length (g/m)		15		15			

- Indoor Unit : Combination of all wall mount series CS-MTZ/TZ
- Outdoor Unit : CU-2TZ41TBE

Indoor unit capacity Cooling	Total	Cooling Capacity (kW)				Input Power (W)		EER		ANNUAL ENERGY CONSUMPTION (kWh)	Current, 230V (A)	ERP				MOISTURE REMOVAL VOLUME l/h	
		Room A	Room B	Total	min ~ max	Rating	min ~ max	W/W	CLASS			Pdesign (kW)	SEER		Annual Consumption (kWh)		
													W/W	CLASS			
1 Room	1.6	1.6	1.60		1.60	1.1 ~ 2.3	450	240 ~ 650	3.56	A	225	2.15	-	-	-	-	1.0
	2.0	2.0	2.00		2.00	1.1 ~ 2.9	570	240 ~ 830	3.51	A	285	2.70	-	-	-	-	1.3
	2.5	2.5	2.50		2.50	1.1 ~ 3.5	720	240 ~ 1070	3.47	A	360	3.40	-	-	-	-	1.5
	3.5	3.5	3.50		3.50	1.1 ~ 4.0	1080	240 ~ 1300	3.24	A	540	5.05	-	-	-	-	2.0
2 Room	1.6 + 1.6	3.2	1.60	1.60	3.20	1.5 ~ 4.0	760	270 ~ 1080	4.21	A	380	3.50	3.20	7.10	A++	158	1.0 + 1.0
	1.6 + 2.0	3.6	1.60	2.00	3.60	1.5 ~ 4.5	860	270 ~ 1250	4.19	A	430	4.00	3.60	7.10	A++	177	1.0 + 1.3
	1.6 + 2.5	4.1	1.60	2.50	4.10	1.5 ~ 4.7	990	270 ~ 1380	4.14	A	495	4.60	4.10	7.10	A++	202	1.0 + 1.5
	1.6 + 3.5	5.1	1.30	2.80	4.10	1.5 ~ 4.7	990	270 ~ 1380	4.14	A	495	4.60	4.10	7.10	A++	202	0.8 + 1.6
	2.0 + 2.0	4.0	2.00	2.00	4.00	1.5 ~ 4.7	980	270 ~ 1380	4.08	A	490	4.55	4.00	7.10	A++	197	1.3 + 1.3
	2.0 + 2.5	4.5	1.80	2.30	4.10	1.5 ~ 4.7	990	270 ~ 1380	4.14	A	495	4.60	4.10	7.10	A++	202	1.2 + 1.5
	2.0 + 3.5	5.5	1.50	2.60	4.10	1.5 ~ 4.7	990	270 ~ 1380	4.14	A	495	4.60	4.10	7.10	A++	202	1.0 + 1.6
	2.5 + 2.5	5.0	2.05	2.05	4.10	1.5 ~ 4.7	990	270 ~ 1380	4.14	A	495	4.60	4.10	7.10	A++	202	1.3 + 1.3
2.5 + 3.5	6.0	1.70	2.40	4.10	1.5 ~ 4.7	990	270 ~ 1380	4.14	A	495	4.60	4.10	7.10	A++	202	1.1 + 1.5	

Indoor unit capacity Heating	Total	Heating Capacity (kW)				Input Power (W)		COP		ANNUAL ENERGY CONSUMPTION (kWh)	Current, 230V (A)	ERP				MOISTURE REMOVAL VOLUME l/h	
		Room A	Room B	Total	min ~ max	Rating	min ~ max	W/W	CLASS			Pdesign (kW)	SCOP		Annual Consumption (kWh)		
													W/W	CLASS			
1 Room	1.6	1.6	2.60		2.60	0.7 ~ 3.8	760	180 ~ 1240	3.42	B	380	3.50	-	-	-	-	
	2.0	2.0	3.20		3.20	0.7 ~ 4.8	930	180 ~ 1570	3.44	B	465	4.30	-	-	-	-	
	2.5	2.5	3.60		3.60	0.7 ~ 5.5	1110	180 ~ 1880	3.24	C	555	5.15	-	-	-	-	
	3.5	3.5	4.30		4.30	0.7 ~ 6.2	1260	180 ~ 2000	3.41	B	630	5.85	-	-	-	-	
2 Room	1.6 + 1.6	3.2	2.20	2.20	4.40	1.1 ~ 6.3	1030	220 ~ 1800	4.27	A	515	4.75	3.20	4.30	A+	1041	
	1.6 + 2.0	3.6	1.95	2.45	4.40	1.1 ~ 6.3	990	220 ~ 1780	4.44	A	495	4.60	3.50	4.30	A+	1139	
	1.6 + 2.5	4.1	1.70	2.70	4.40	1.1 ~ 6.3	990	220 ~ 1780	4.44	A	495	4.60	3.50	4.30	A+	1139	
	1.6 + 3.5	5.1	1.40	3.00	4.40	1.1 ~ 6.3	990	220 ~ 1780	4.44	A	495	4.60	3.50	4.30	A+	1139	
	2.0 + 2.0	4.0	2.20	2.20	4.40	1.1 ~ 6.3	980	220 ~ 1760	4.49	A	490	4.55	3.50	4.30	A+	1139	
	2.0 + 2.5	4.5	1.95	2.45	4.40	1.1 ~ 6.3	980	220 ~ 1760	4.49	A	490	4.55	3.50	4.30	A+	1139	
	2.0 + 3.5	5.5	1.60	2.80	4.40	1.1 ~ 6.3	980	220 ~ 1760	4.49	A	490	4.55	3.50	4.30	A+	1139	
	2.5 + 2.5	5.0	2.20	2.20	4.40	1.1 ~ 6.3	980	220 ~ 1760	4.49	A	490	4.55	3.50	4.30	A+	1139	
2.5 + 3.5	6.0	1.85	2.55	4.40	1.1 ~ 6.3	980	220 ~ 1760	4.49	A	490	4.55	3.50	4.30	A+	1139		

- Indoor Unit : Combination of all wall mount series CS-MTZ/TZ
- Outdoor Unit : CU-2TZ50TBE

Indoor unit capacity Cooling	Total	Cooling Capacity (kW)					Input Power (W)		EER		ANNUAL ENERGY CONSUMPTION (kWh)	Current, 230V (A)	ERP				MOISTURE REMOVAL VOLUME l/h
		Room A	Room B	Total	min ~ max	Rating	min ~ max	W/W	CLASS	Pdesign (kW)			SEER		Annual Consumption (kWh)		
													W/W	CLASS			
1 Room	1.6	1.6	1.60		1.60	1.1 ~ 2.3	450	240 ~ 650	3.56	A	225	2.15	-	-	-	-	1.0
	2.0	2.0	2.00		2.00	1.1 ~ 2.9	570	240 ~ 830	3.51	A	285	2.70	-	-	-	-	1.3
	2.5	2.5	2.50		2.50	1.1 ~ 3.5	720	240 ~ 1070	3.47	A	360	3.40	-	-	-	-	1.5
	3.5	3.5	3.50		3.50	1.1 ~ 4.0	1080	240 ~ 1300	3.24	A	540	5.05	-	-	-	-	2.0
	4.2	4.2	4.20		4.20	1.1 ~ 4.5	1450	240 ~ 1600	2.90	C	725	6.80	-	-	-	-	2.4
	5.0	5.0	5.00		5.00	1.2 ~ 5.1	1800	250 ~ 1900	2.78	D	900	8.30	-	-	-	-	2.7
2 Room	1.6 + 1.6	3.2	1.60	1.60	3.20	1.5 ~ 4.0	760	270 ~ 1080	4.21	A	380	3.50	3.20	7.00	A++	160	1.0 + 1.0
	1.6 + 2.0	3.6	1.60	2.00	3.60	1.5 ~ 4.5	860	270 ~ 1250	4.19	A	430	4.00	3.60	7.00	A++	180	1.0 + 1.3
	1.6 + 2.5	4.1	1.60	2.50	4.10	1.5 ~ 5.2	990	270 ~ 1480	4.14	A	495	4.60	4.10	7.00	A++	205	1.0 + 1.5
	1.6 + 3.5	5.1	1.55	3.45	5.00	1.5 ~ 5.2	1300	270 ~ 1480	3.85	A	650	6.00	5.00	7.00	A++	250	1.0 + 2.0
	1.6 + 4.2	5.8	1.40	3.60	5.00	1.5 ~ 5.4	1300	270 ~ 1620	3.85	A	650	6.00	5.00	7.00	A++	250	0.9 + 2.1
	1.6 + 5.0	6.6	1.20	3.80	5.00	1.5 ~ 5.4	1300	270 ~ 1620	3.85	A	650	6.00	5.00	7.00	A++	250	0.7 + 2.2
	2.0 + 2.0	4.0	2.00	2.00	4.00	1.5 ~ 5.0	980	270 ~ 1420	4.08	A	490	4.55	4.00	7.00	A++	200	1.3 + 1.3
	2.0 + 2.5	4.5	2.00	2.50	4.50	1.5 ~ 5.2	1140	270 ~ 1480	3.95	A	570	5.25	4.50	7.00	A++	225	1.3 + 1.5
	2.0 + 3.5	5.5	1.80	3.20	5.00	1.5 ~ 5.4	1300	270 ~ 1620	3.85	A	650	6.00	5.00	7.00	A++	250	1.2 + 1.8
	2.0 + 4.2	6.2	1.60	3.40	5.00	1.5 ~ 5.4	1300	270 ~ 1620	3.85	A	650	6.00	5.00	7.00	A++	250	1.0 + 1.9
	2.0 + 5.0	7.0	1.45	3.55	5.00	1.5 ~ 5.4	1300	270 ~ 1620	3.85	A	650	6.00	5.00	7.00	A++	250	0.9 + 2.1
	2.5 + 2.5	5.0	2.50	2.50	5.00	1.5 ~ 5.4	1300	270 ~ 1620	3.85	A	650	6.00	5.00	7.00	A++	250	1.5 + 1.5
	2.5 + 3.5	6.0	2.10	2.90	5.00	1.5 ~ 5.4	1300	270 ~ 1620	3.85	A	650	6.00	5.00	7.00	A++	250	1.4 + 1.7
	2.5 + 4.2	6.7	1.85	3.15	5.00	1.5 ~ 5.4	1300	270 ~ 1620	3.85	A	650	6.00	5.00	7.00	A++	250	1.2 + 1.8
	2.5 + 5.0	7.5	1.65	3.35	5.00	1.5 ~ 5.4	1300	270 ~ 1620	3.85	A	650	6.00	5.00	7.00	A++	250	1.1 + 1.9
3.5 + 3.5	7.0	2.50	2.50	5.00	1.5 ~ 5.4	1300	270 ~ 1620	3.85	A	650	6.00	5.00	7.00	A++	250	1.5 + 1.5	
3.5 + 4.2	7.7	2.25	2.75	5.00	1.5 ~ 5.4	1300	270 ~ 1620	3.85	A	650	6.00	5.00	7.00	A++	250	1.5 + 1.6	

Indoor unit capacity Heating	Total	Heating Capacity (kW)					Input Power (W)		COP		ANNUAL ENERGY CONSUMPTION (kWh)	Current, 230V (A)	ERP				MOISTURE REMOVAL VOLUME l/h
		Room A	Room B	Total	min ~ max	Rating	min ~ max	W/W	CLASS	Pdesign (kW)			SCOP		Annual Consumption (kWh)		
													W/W	CLASS			
1 Room	1.6	1.6	2.60		2.60	0.7 ~ 3.8	760	180 ~ 1240	3.42	B	380	3.50	-	-	-	-	
	2.0	2.0	3.20		3.20	0.7 ~ 4.8	930	180 ~ 1570	3.44	B	465	4.30	-	-	-	-	
	2.5	2.5	3.60		3.60	0.7 ~ 5.5	1110	180 ~ 1880	3.24	C	555	5.15	-	-	-	-	
	3.5	3.5	4.50		4.50	0.7 ~ 6.2	1340	180 ~ 2000	3.36	C	670	6.20	-	-	-	-	
	4.2	4.2	5.00		5.00	1.1 ~ 6.3	1720	220 ~ 2350	2.91	D	860	7.95	-	-	-	-	
	5.0	5.0	5.30		5.30	1.1 ~ 6.3	1810	220 ~ 2330	2.93	D	905	8.35	-	-	-	-	
2 Room	1.6 + 1.6	3.2	2.65	2.65	5.30	1.1 ~ 6.3	1230	220 ~ 1800	4.31	A	615	5.65	4.00	4.20	A+	1333	
	1.6 + 2.0	3.6	2.45	3.05	5.50	1.1 ~ 6.3	1280	220 ~ 1780	4.30	A	640	5.85	4.20	4.20	A+	1400	
	1.6 + 2.5	4.1	2.15	3.35	5.50	1.1 ~ 6.3	1280	220 ~ 1780	4.30	A	640	5.85	4.20	4.20	A+	1400	
	1.6 + 3.5	5.1	1.75	3.75	5.50	1.1 ~ 6.3	1280	220 ~ 1780	4.30	A	640	5.85	4.20	4.20	A+	1400	
	1.6 + 4.2	5.8	1.55	4.15	5.70	1.1 ~ 6.4	1310	220 ~ 1770	4.35	A	655	6.00	4.50	4.20	A+	1500	
	1.6 + 5.0	6.6	1.40	4.30	5.70	1.1 ~ 6.4	1310	220 ~ 1770	4.35	A	655	6.00	4.50	4.20	A+	1500	
	2.0 + 2.0	4.0	2.75	2.75	5.50	1.1 ~ 6.3	1270	220 ~ 1760	4.33	A	635	5.80	4.20	4.20	A+	1400	
	2.0 + 2.5	4.5	2.45	3.05	5.50	1.1 ~ 6.3	1270	220 ~ 1760	4.33	A	635	5.80	4.20	4.20	A+	1400	
	2.0 + 3.5	5.5	2.05	3.65	5.70	1.1 ~ 6.4	1310	220 ~ 1770	4.35	A	655	6.00	4.50	4.20	A+	1500	
	2.0 + 4.2	6.2	1.85	3.85	5.70	1.1 ~ 6.4	1310	220 ~ 1770	4.35	A	655	6.00	4.50	4.20	A+	1500	
	2.0 + 5.0	7.0	1.65	4.05	5.70	1.1 ~ 6.4	1310	220 ~ 1770	4.35	A	655	6.00	4.50	4.20	A+	1500	
	2.5 + 2.5	5.0	2.85	2.85	5.70	1.1 ~ 6.4	1310	220 ~ 1770	4.35	A	655	6.00	4.50	4.20	A+	1500	
	2.5 + 3.5	6.0	2.35	3.35	5.70	1.1 ~ 6.4	1310	220 ~ 1770	4.35	A	655	6.00	4.50	4.20	A+	1500	
	2.5 + 4.2	6.7	2.15	3.55	5.70	1.1 ~ 6.4	1310	220 ~ 1770	4.35	A	655	6.00	4.50	4.20	A+	1500	
	2.5 + 5.0	7.5	1.90	3.80	5.70	1.1 ~ 6.4	1310	220 ~ 1770	4.35	A	655	6.00	4.50	4.20	A+	1500	
3.5 + 3.5	7.0	2.85	2.85	5.70	1.1 ~ 6.4	1310	220 ~ 1770	4.35	A	655	6.00	4.50	4.20	A+	1500		
3.5 + 4.2	7.7	2.60	3.10	5.70	1.1 ~ 6.4	1310	220 ~ 1770	4.35	A	655	6.00	4.50	4.20	A+	1500		

# 4. Dimensions

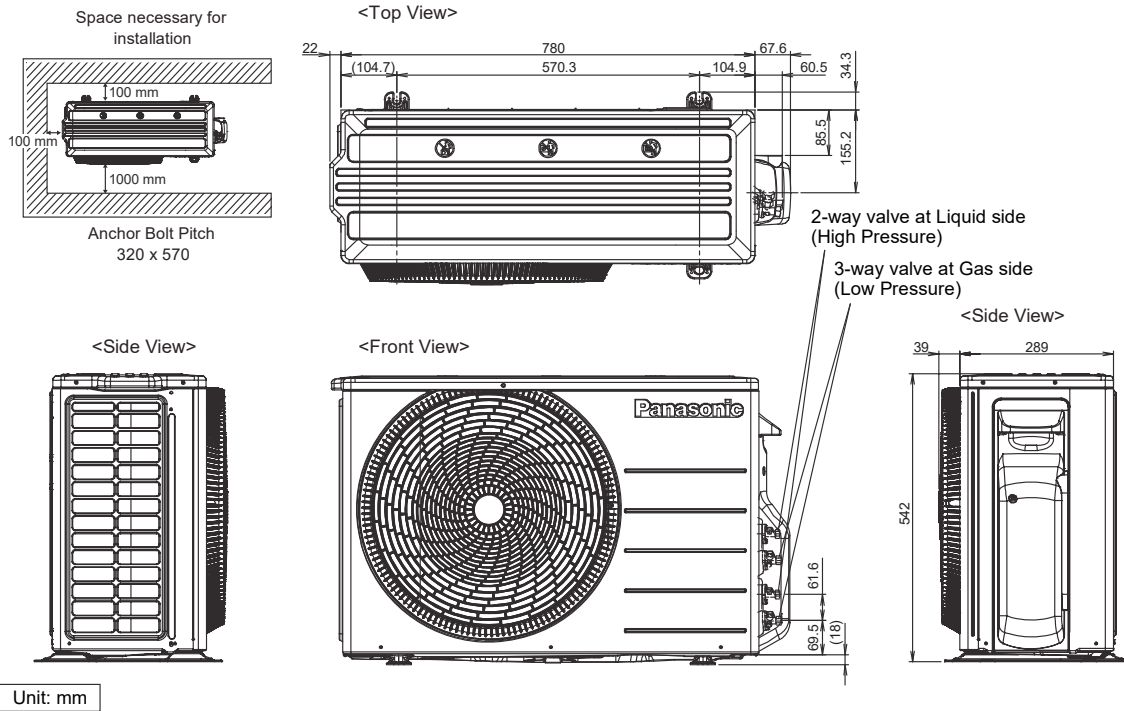



# 5. Refrigeration Cycle Diagram

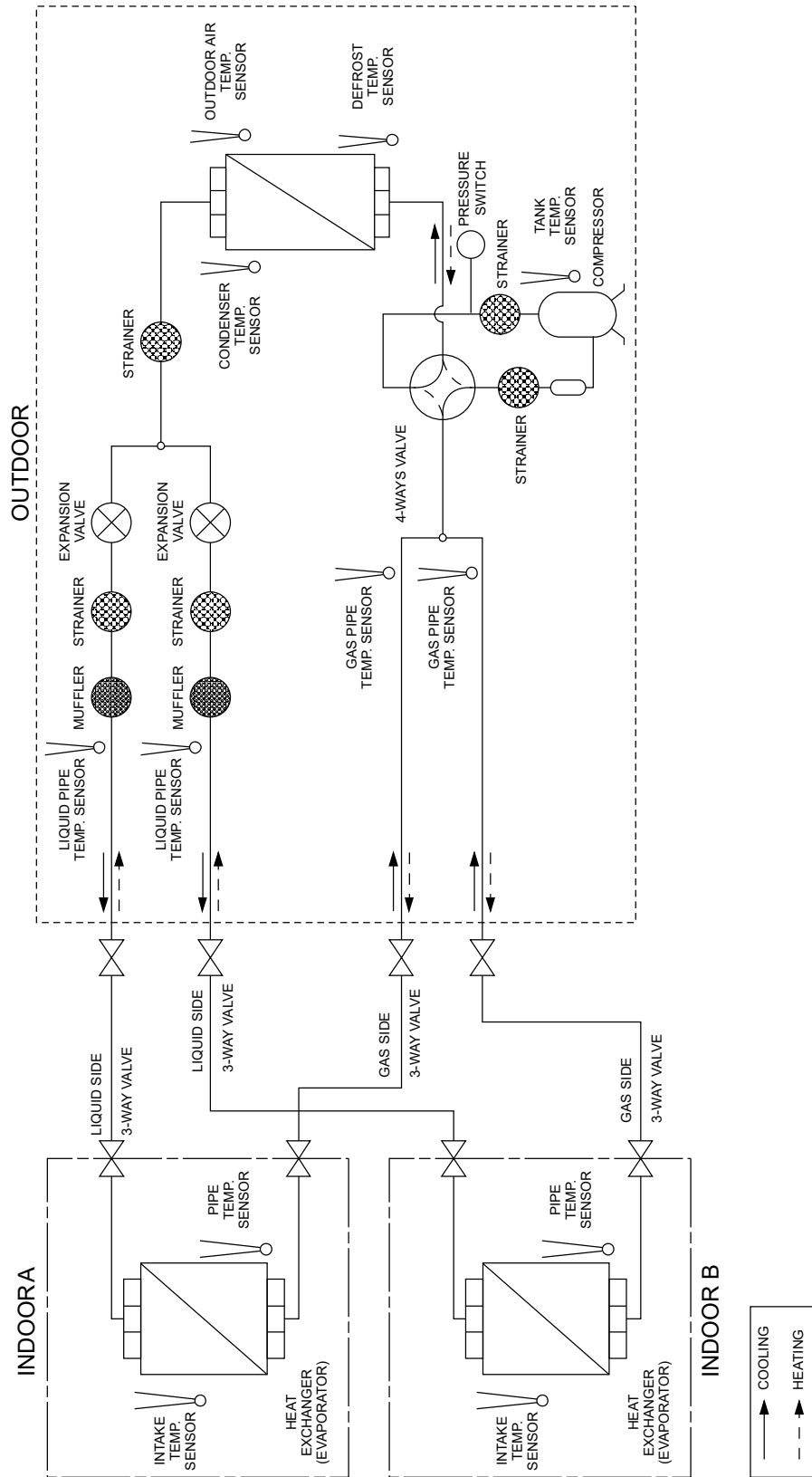

# 6. Block Diagram

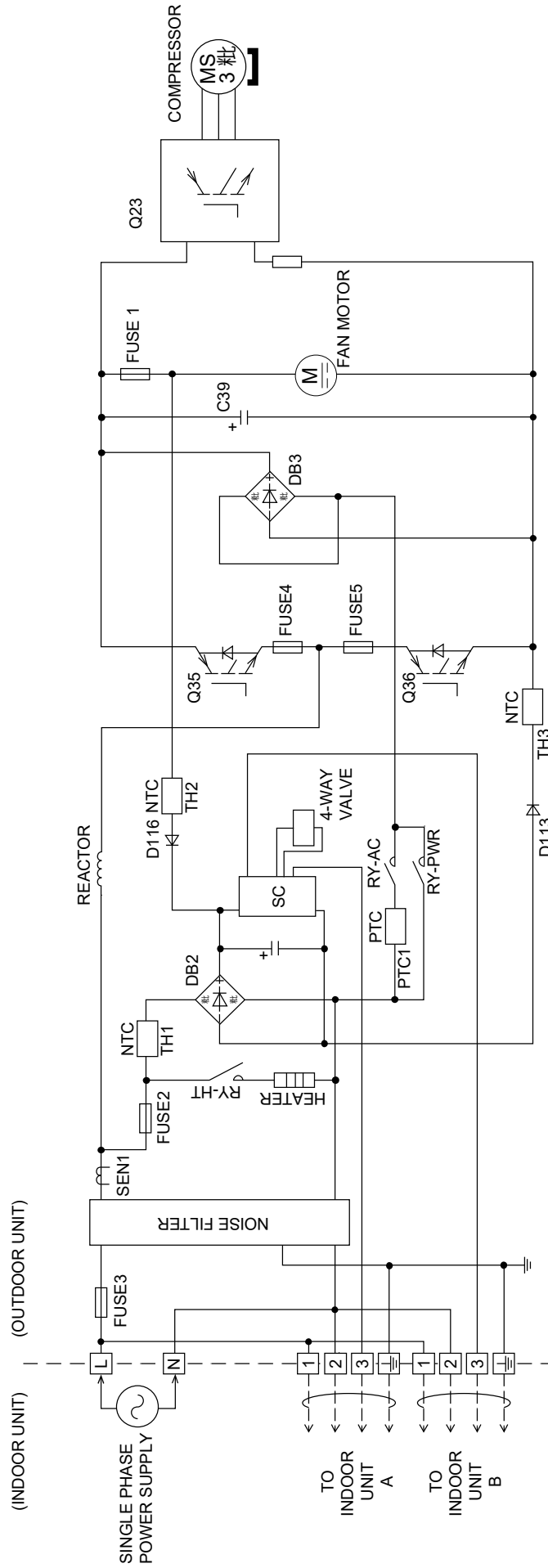

# 7. Wiring Connection Diagram

Resistance of Compressor Windings

CONNECTION	9RD132FA21 (Ω)
U - V	1.897
U - W	1.907
V - W	1.882

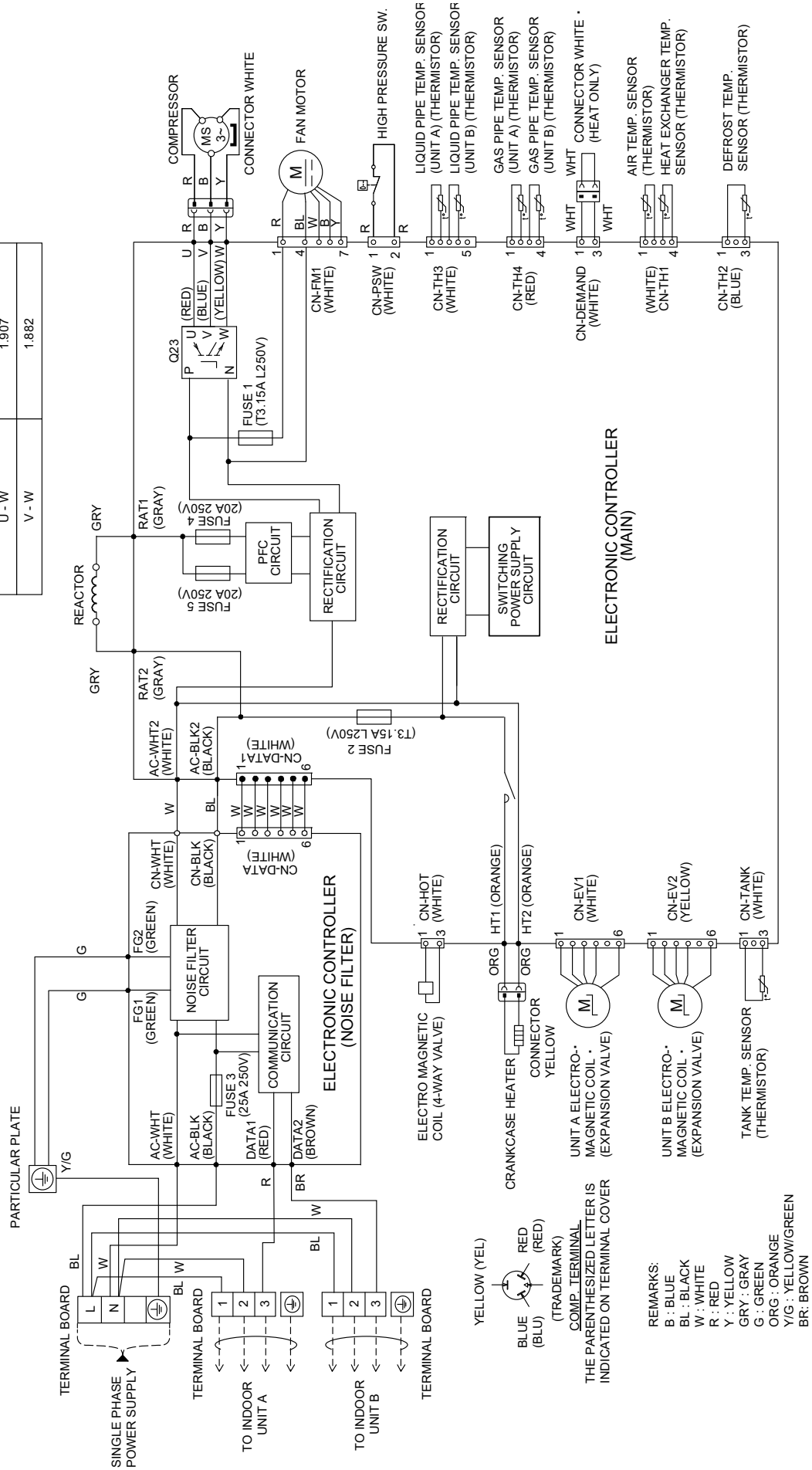

# 8. Electronic Circuit Diagram

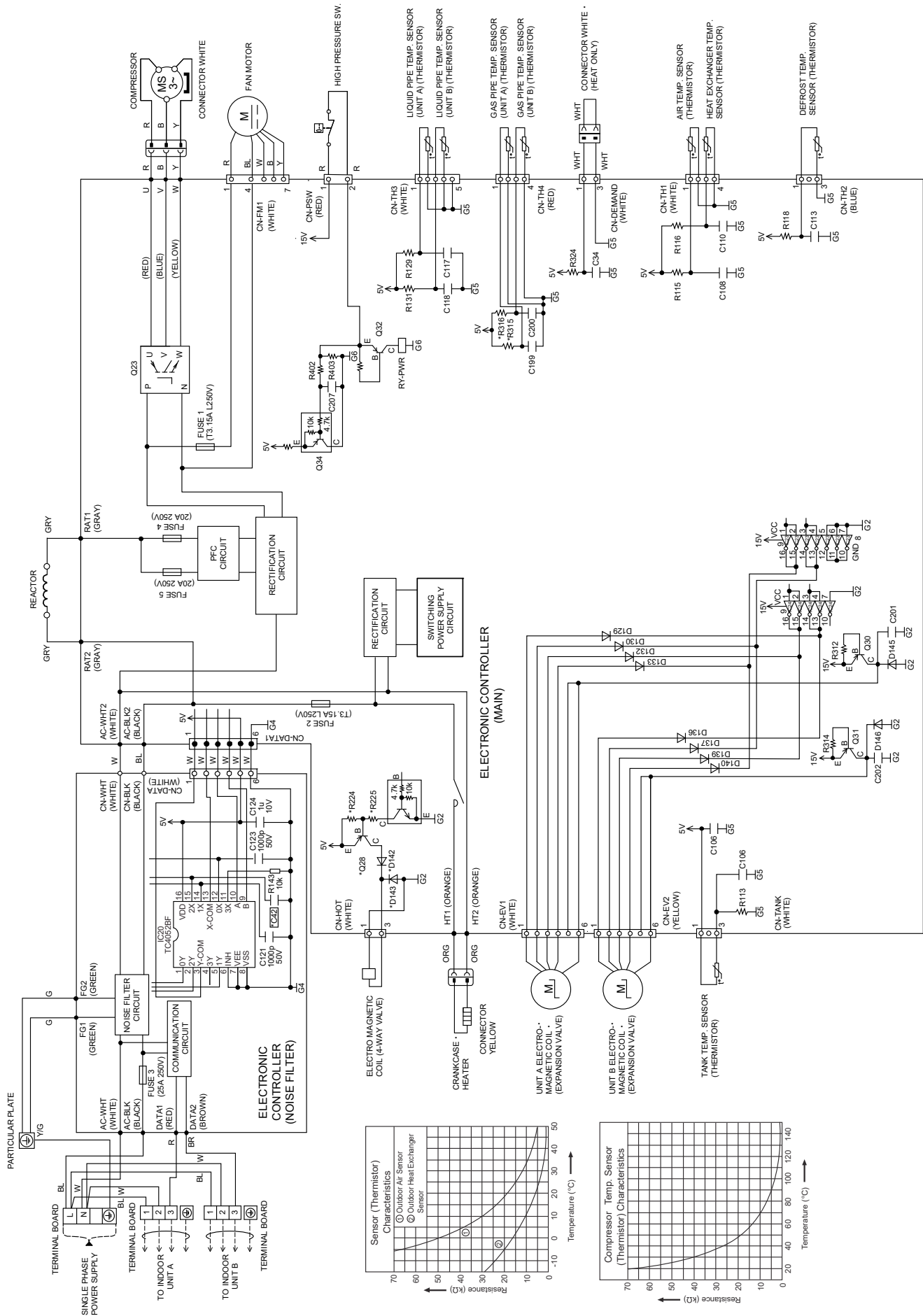

# 9. Printed Circuit Board

## 9.1 Main Printed Circuit Board

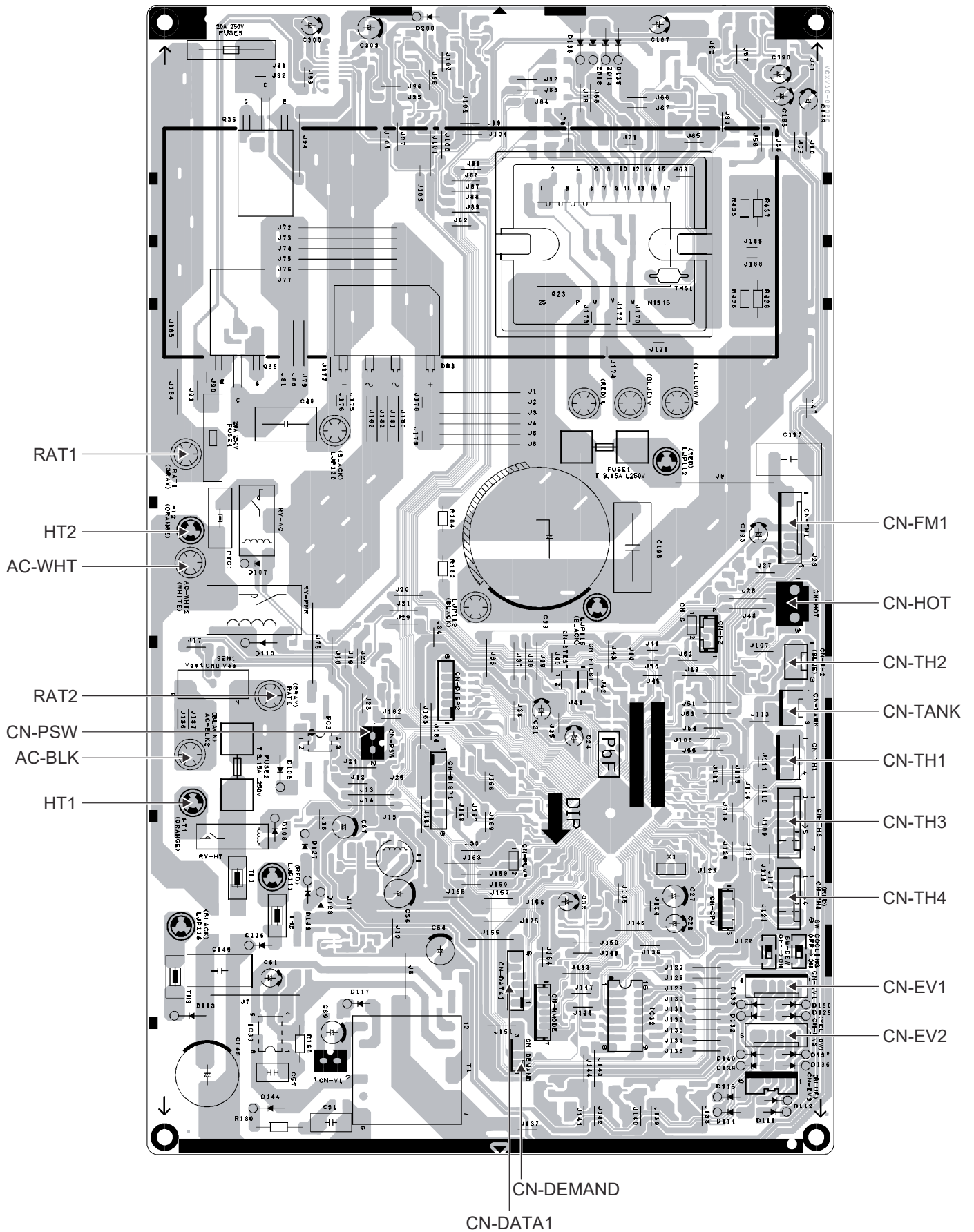

## 9.2 Noise Filter Printed Circuit Board

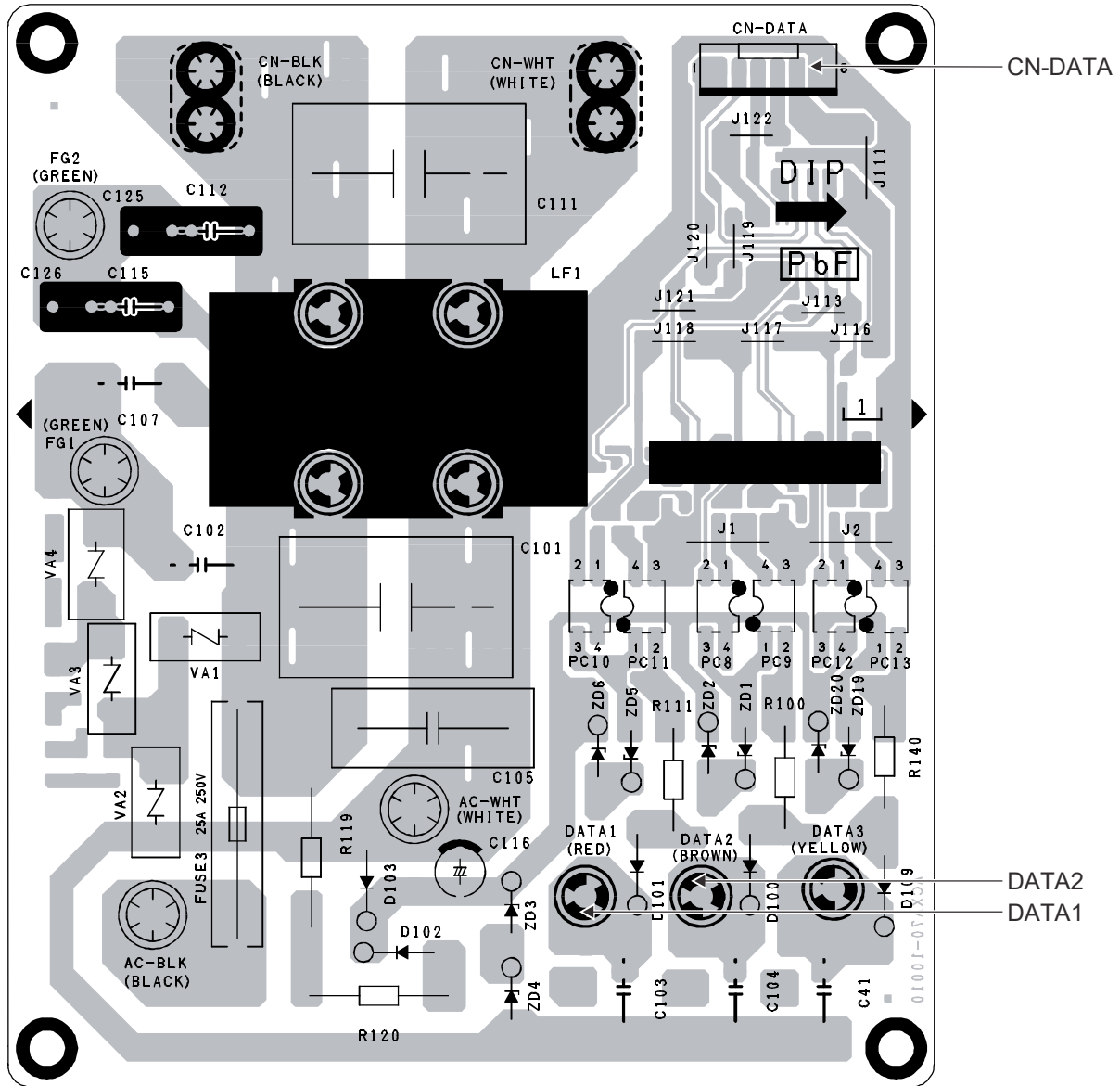

# 10. Installation Information

## 10.1 CU-2TZ41TBE

### 10.1.1 Check Points

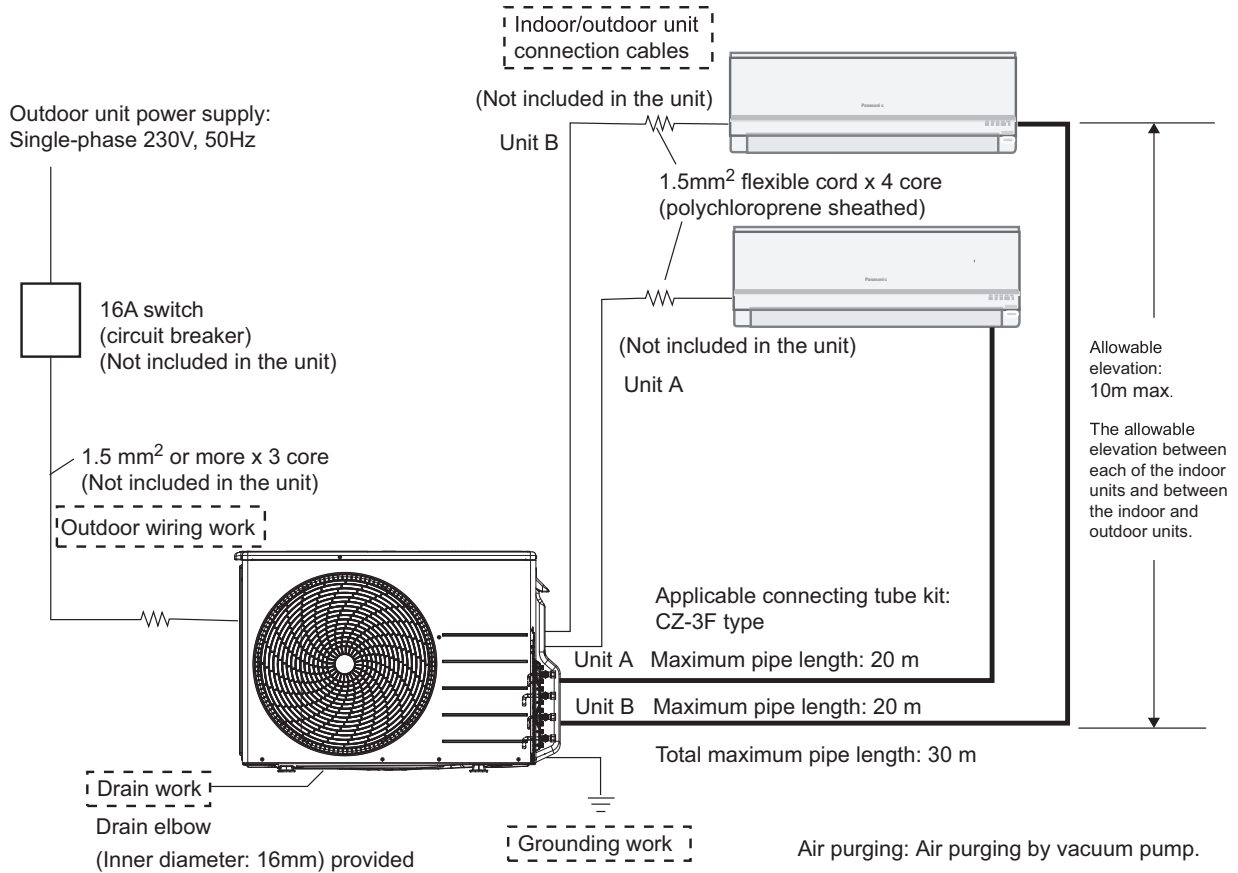

### 10.1.2 The Shapes of the 3-Way Valve Caps of the Outdoor Unit Have Been Changed

- Accompanying the changes in the shapes of the 3-way valve caps, the tightening method has also been changed.
- Firmly tighten the 3-way valve caps by hand, and then tighten them up by another 30 degrees or so (one-twelfth of a full turn) using a spanner or adjustable spanner.

After having firmly tightened the caps by hand,  
tighten them up further using a  
spanner or adjustable spanner.

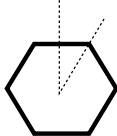

**Caution:**  
Do not use all your strength to tighten up the caps. Doing so may break the caps.

## 10.2 CU-2TZ50TBE

### 10.2.1 Check Points

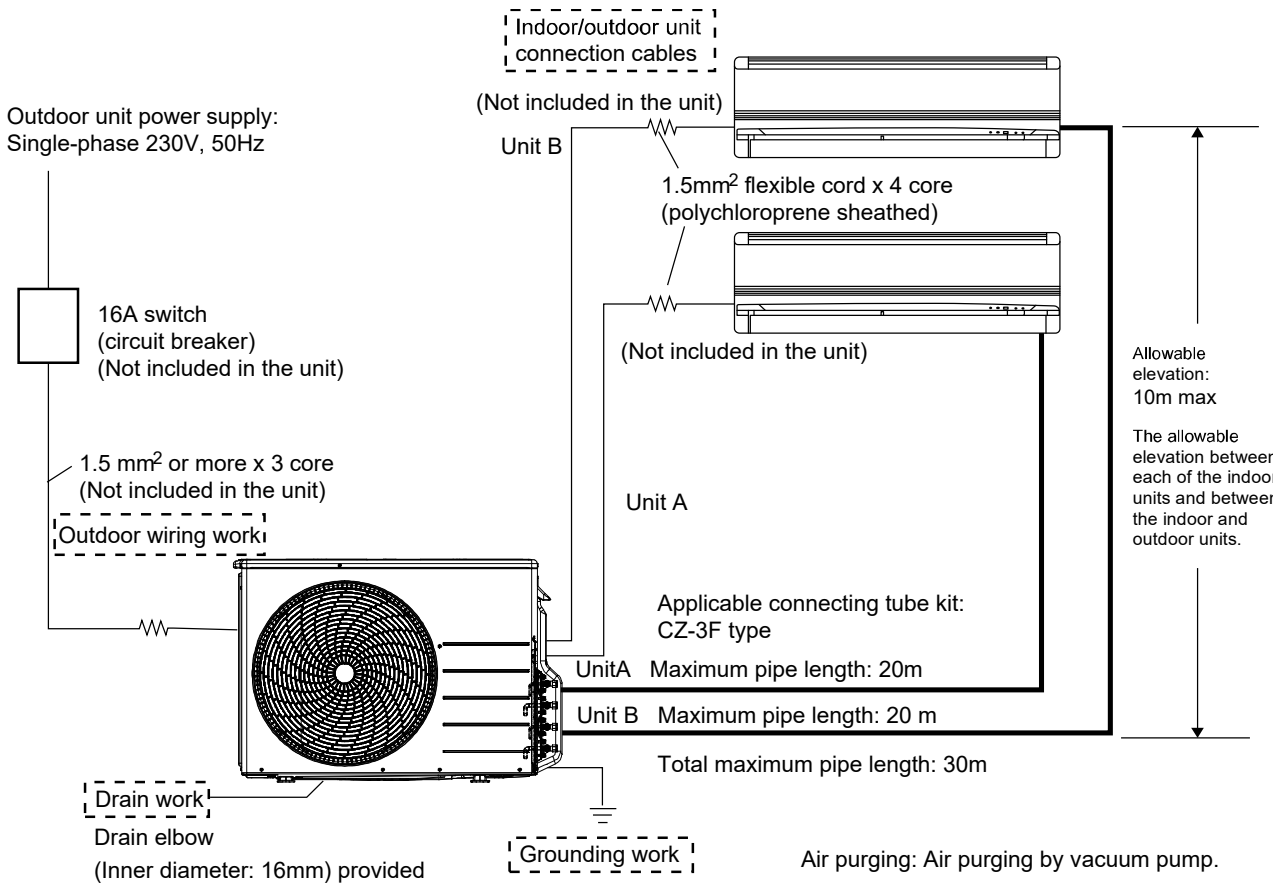

### 10.2.2 The Shapes of the 3-Way Valve Caps of the Outdoor Unit Have Been Changed

- Accompanying the changes in the shapes of the 3-way valve caps, the tightening method has also been changed.
- Firmly tighten the 3-way valve caps by hand, and then tighten them up by another 30 degrees or so (one-twelfth of a full turn) using a spanner or adjustable spanner.

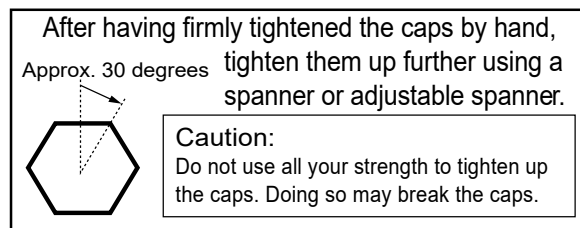



# 11. Installation Instruction

## 11.1 Outdoor Unit

### 11.1.1 Select The Best Location

- If an awning is built over the unit to prevent direct sunlight or rain, be careful that heat radiation from the condenser is not obstructed.
- There should not be any animal or plant which could be affected by hot air discharged.
- Keep the spaces indicated by arrows from wall, ceiling, fence or other obstacles.
- Do not place any obstacles which may cause a short circuit of the discharged air.
- If piping length is over the [piping length for additional gas], additional refrigerant should be added as shown in the table.

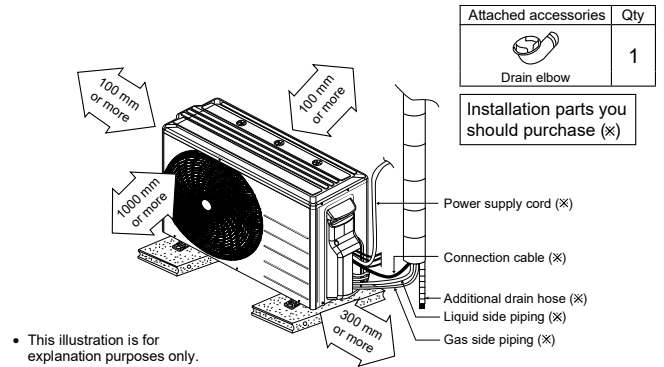

Model	Std. Length (m)	Min. Piping Length (m)	Max. Total Length (m)	Max. Elevation (m)	Maximum Total Piping Length for Add. Gas (m)	Additional Refrigerant (g/m)	Indoor A <sub>min</sub> (m <sup>2</sup> )	
							1.8 m for wall mounted	2.5 m for wall mounted
CU-2TZ41***, CU-2TZ50***	5 m / indoor unit	3 m / indoor unit	30	10	20	15	1.05	0.54

Note:

- (1) It is possible to extend the piping length of one unit up to 20 meters. However, the total piping length must not exceed 30 meters.
- (2) If the length exceeds 20 meters, refrigerant of 15g per meter must be added.

$$A_{\min} = (m_c / (2.5 \times (LFL)^{5/4} \times h_0))^2$$

$A_{\min}$  = Required minimum room area, in m<sup>2</sup>  
 $m_c$  = Refrigerant charge amount in appliance, in kg  
 $LFL$  = Lower flammable limit (0.306 kg/m<sup>3</sup>)  
 $h_0$  = Installation height of the appliance  
 : (1.8 m for wall mounted is standard reference installed height)  
 : (2.5 m for wall mounted is recommended installed height give by manufacturer)

### 11.1.2 Install The Outdoor Unit

- After selecting the best location, start installation to Indoor/Outdoor Unit Installation Diagram.
  1. Fix the unit on concrete or rigid frame firmly and horizontally by bolt nut (ø10 mm).
  2. When installing at roof, please consider strong wind and earthquake. Please fasten the installation stand firmly with bolt or nails.

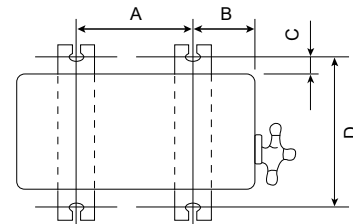

Model	A	B	C	D
CU-2TZ41***, CU-2TZ50***	570 mm	105 mm	18.5 mm	320 mm

### 11.1.3 Connect the Piping

#### 11.1.3.1 Connecting The Piping To Indoor Unit

Please make flare after inserting flare nut (locate at joint portion of tube assembly) onto the copper pipe.

(In case of using long piping)

Connect the piping

- Align the center of piping and sufficiently tighten the flare nut with fingers.
- Further tighten the flare nut with torque wrench in specified torque as stated in the table.

Do not over tighten, over tightening may cause gas leakage.	
Piping size	Torque
6.35 mm (1/4")	[18 N•m (1.8 kgf•m)]
9.52 mm (3/8")	[42 N•m (4.3 kgf•m)]
12.7 mm (1/2")	[55 N•m (5.6 kgf•m)]
15.88 mm (5/8")	[65 N•m (6.6 kgf•m)]
19.05 mm (3/4")	[100 N•m (10.2 kgf•m)]

#### 11.1.3.2 Connecting The Piping To Outdoor Multi

Decide piping length and then cut by using pipe cutter.

Remove burrs from cut edge.

Make flare after inserting the flare nut (locate at valve) onto the copper pipe. Align center of piping to valves and then tighten with torque wrench to the specified torque as stated in the table.

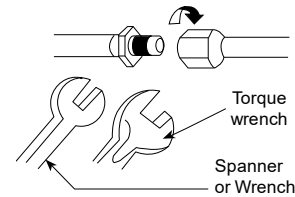

**AIR PURGING METHOD IS PROHIBITED FOR R32 SYSTEM**

#### 11.1.4 Air Tightness Test on the Refrigerating System

Before system charged with refrigerant and before the refrigerating system is put into operation, below site test procedure and acceptance criteria shall be verified by the certified technicians, and/or the installer:-

Step 1: Pressure test for refrigerant leak detection:

1. Steps for pressure test, in accordance to ISO 5149.
2. Evacuate the system from refrigerant before the leak test, attach the gauge manifold set correctly and tightly. Charging hose of Low side connect to Gas side. (Charging hose of High side connect to Liquid side if applicable.)
3. Adjust the knob on the service valves, and regulator on the gauge set, so that test gas can be inserted through the centre manifold of the gauge set.
4. Insert Nitrogen gas into the system through the centre manifold and wait until the pressure within the system to reach about 1MPa (10 BarG) wait for a few hours and monitor the pressure reading on the gauges.
5. Please note that the system's pressure may rise slightly if the test is carried out on mid day, due to temperature rise. The inverse may happen when there is temperature drop at night. However, this variation will be minimal.
6. Waiting time depends on the size of the system. Larger systems may require 12 hours of waiting time. Leak detection within smaller system can be achieved in 4 hours.
7. Check if there is a constant pressure drop. Move to next step "Step 2: Refrigerant leak detection..." if there is any pressure drop. Otherwise, release the Nitrogen gas and, move to "Step 3: Evacuation of the equipment".
8. Next, insert a small amount of same refrigerant into the system through the centre hose, until the pressure reaches about 1MPa (10 BarG).

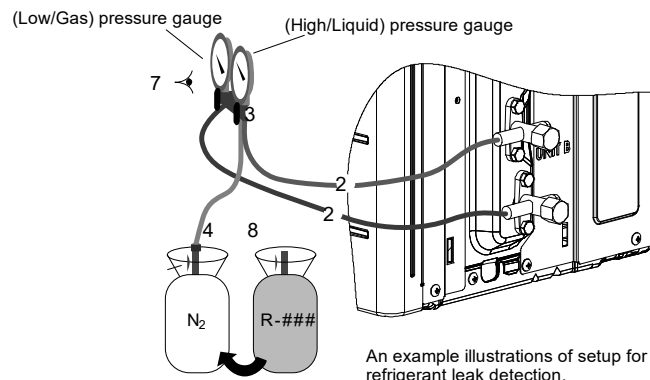

Step 2: Refrigerant leak detection through Electronic halogen leak detector and/or ultrasonic leak detector:

1. Use any one of below detector to check leaking.
  - Electronic halogen leak detector.
    - Switch on the unit.
    - Cover the test area from direct draft.
    - Pass the detection probe near test area and wait for audible and visible signals.
  - Ultrasonic Leak Detector
    - Make sure the area is quiet.
    - Switch on the ultrasonic leak detector.
    - Move the probe along your air conditioning system to test for leaks, and mark for repair.
2. Any leak detected at this level shall be repaired and retested, starting from “Step 1: Pressure test”.

NOTE:

- Always recover the refrigerant and Nitrogen gas into recovery cylinder after completion of a test.
- You must use the detection equipment with Detectable Leak Rate of  $10^{-6}$  Pa.m<sup>3</sup>/s or better.
- Do not use refrigerant as test medium for system with total refrigerant charge more than 5kg.
- Test shall be performed with dry Nitrogen or another non-flammable, non-reactive, dried gas. Oxygen, air or mixtures containing them shall not be used.

Step 3: Evacuation of the equipment:

⊘	Do not purge the air with refrigerants but use a vacuum pump to vacuum the installation.
!	There is no extra refrigerant in the outdoor unit for air purging.

1. Connect a charging hose with a push pin to the Low and High side of a charging set and the service port of the 3-way valve.
  - Be sure to connect the end of the charging hose with the push pin to the service port.
2. Connect the center hose of the charging set to a vacuum pump with check valve, or vacuum pump adaptor.
3. Turn on the power switch of the vacuum pump and make sure that the needle in the gauge moves from 0 cmHg (0 MPa) to -76 cmHg (-0.1 MPa). Then evacuate the air approximately 10 minutes.
4. Close the Low and High side valves of the charging set and turn off the vacuum pump. Make sure that the needle in the gauge does not move after approximately 5 minutes.  
 Note: BE SURE TO FOLLOW THIS PROCEDURE IN ORDER TO AVOID REFRIGERANT GAS LEAKAGE.
5. Disconnect the charging hose from the vacuum pump and from the service port of the 3-way valves.
6. Tighten the service port caps of the 3-way valve at a torque of 18 N•m with a torque wrench.
7. Remove the valve caps of the both 3-way valves. Position both of the valves to “OPEN” using a hexagonal wrench (4 mm).
8. Mount valve caps onto the both 3-way valves.
  - Be sure to check for gas leakage.

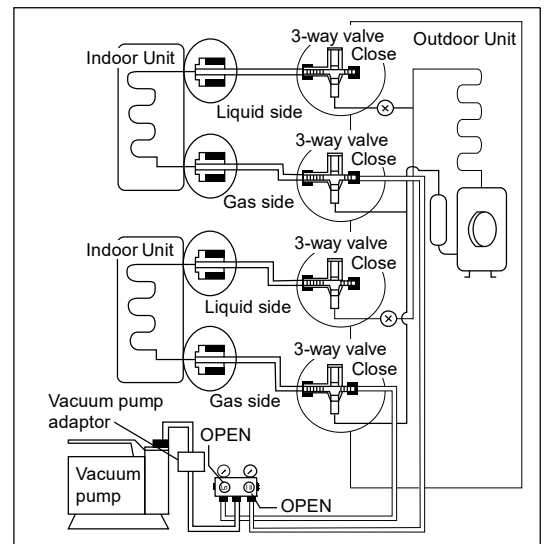

**⚠ CAUTION**

- If gauge needle does not move from 0 cmHg (0 MPa) to -76 cmHg (-0.1 MPa), in step ③ above take the following measure:
- If the leak stops when the piping connections are tightened further, continue working from step ③.
- If the leak does not stop when the connections are retightened, repair location of leak.
- Do not release refrigerant during piping work for installation and reinstallation.
- Take care of the liquid refrigerant, it may cause frostbite.

### 11.1.5 Connect The Cable To The Outdoor Unit

1. Remove the control board cover (metal) from the unit by loosening two screws.
2. Cable connection to the power supply through isolating Devices (Disconnecting means).
  - Connect approved type polychloroprene sheathed **power supply cord** 3 x 1.5 mm<sup>2</sup> type designation 60245 IEC 57 or heavier cord to the terminal board, and connect the others end of the cord to Isolating Devices (Disconnecting means)
3. **Connection cable** between indoor unit and outdoor unit shall be approved polychloroprene sheathed 4 x 1.5 mm<sup>2</sup> flexible cord, type designation 60245 IEC 57 or heavier cord. Allowable connection cable length of each indoor unit shall be 30 m or less.
4. Connect the power supply cord and connecting cable between indoor unit and outdoor unit according to the diagram as shown.

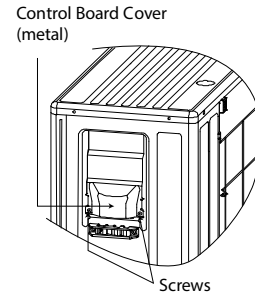

5. Secure the power supply cord and connection cables onto the control board with the holder.
6. Attach the control board cover back to the original position with screw.
7. For wire stripping and connection requirement, refer to the diagram as shown.

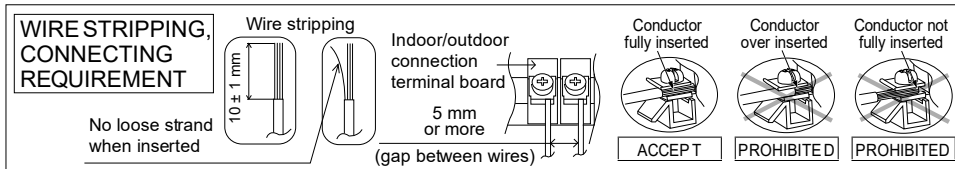
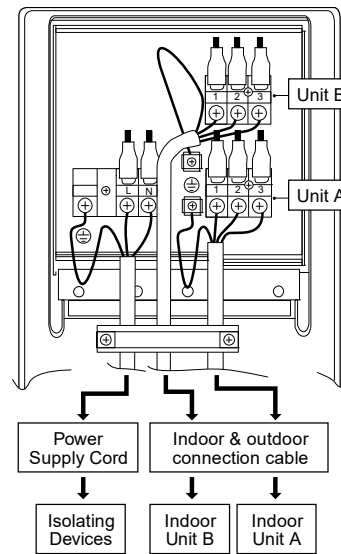
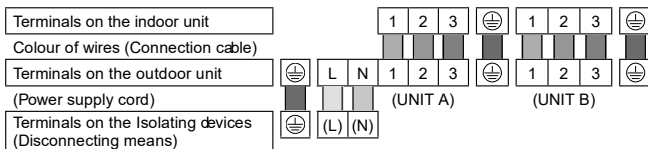

**⚠ WARNING**  
 This equipment must be properly earthed.

- Note: Isolating Devices (Disconnecting means) should have minimum 3.0 mm contact gap.
- Earth wire shall be Yellow/Green (Y/G) in colour and longer than other AC wires for safety reason.

### 11.1.6 Piping Insulation

1. Please carry out insulation at pipe connection portion as mentioned in Indoor/Outdoor Unit Installation Diagram. Please wrap the insulated piping end to prevent water from going inside the piping.
2. If drain hose or connecting piping is in the room (where dew may form), please increase the insulation by using POLY-E FOAM with thickness 6 mm or above.

<b>!</b>	Refrigerant tubing shall be protected against mechanical damage.		
<b>⚠ CAUTION</b>	Use a material with good heat-resistant properties as the heat insulation for the pipes. Be sure to insulate both the gas-side and liquid-side pipes. If the pipes are not adequately insulated, condensation or water leakages may occur.	Liquid-side pipes	Material shall withstand 120°C or higher
		Gas-side pipes	

## CUTTING AND FLARING THE PIPING

1. Please cut using pipe cutter and then remove the burrs.
2. Remove the burrs by using reamer. If burrs is not removed, gas leakage may be caused. Turn the piping end down to avoid the metal powder entering the pipe.
3. Please make flare after inserting the flare nut onto the copper pipes.

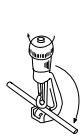

1. To cut

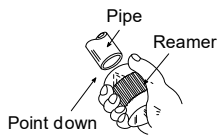

2. To remove burrs

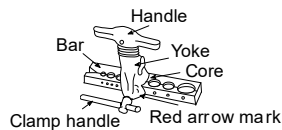

3. To flare

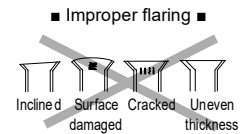
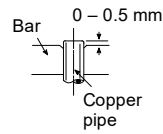

When properly flared, the internal surface of the flare will evenly shine and be of even thickness. Since the flare part comes into contact with the connections, carefully check the flare finish.

### 11.1.7 Disposal Of Outdoor Unit Drain Water

- If a drain elbow is used, the unit should be placed on a stand which is taller than 3 cm.
- If the unit is used in an area where temperature falls below 0°C for 2 or 3 days in succession, it is recommended not to use a drain elbow, for the drain water freezes and the fan will not rotate.

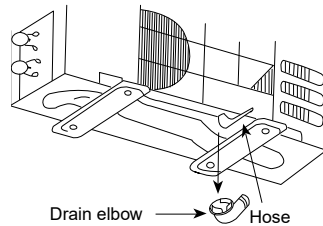

Install the hose at an angle so that the water smoothly flows out.

## 12. Operation Control

### 12.1 Cooling Operation

#### 12.1.1 Outdoor fan control

- When cooling operation is enabled, based on outdoor ambient temperature, fan motor control will be adjusted according to figure below:

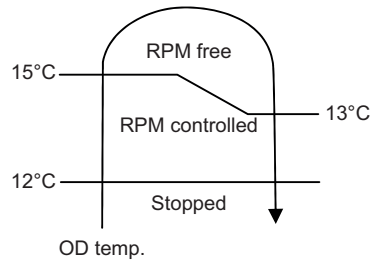

#### 12.1.2 Annual Cooling control

- This control is to enable cooling operation when outdoor ambient temperature is low.
- Control start conditions:
  - Cooling operation is activated with compressor ON.
  - Outdoor ambient temperature is less than 15°C
- Control contents:
  - When the above conditions are fulfilled, based on outdoor pipe temperature, the outdoor fan motor will operate according to figure below:

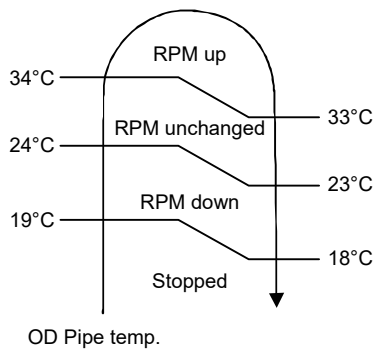

- To improve the judgment accuracy during annual cooling control, outdoor ambient temperature sampling for 2 minutes will be activated every 35 minutes under designated fan speed.
- Control stop conditions:
  - When either one of the start conditions are not complied.

#### 12.1.3 Cooling Powerful Operation 1

- During cooling operation, this control is to concentrate outdoor unit capability to the powerful operation enabled indoor unit by temporary stop the capability supply to low load demand indoor units.
- Operation start condition:
  - Powerful operation ON for targeted indoor unit
- Operation content:
  - If other indoor units (where Powerful operation are OFF) achieve setting temperature continuously for 1 minute after received powerful command from indoor unit, then capability supply to other indoor units are stopped for minimum 3 minutes.  
Capability supply stop period follows powerful operation period.
- Operation stops when comply either one of the following conditions:
  - When other indoor units (where Powerful operation are OFF) is demand for capacity.
  - When the powerful operation is OFF for all indoor units.
  - When Quiet operation received from 1 indoor unit.
  - When protection control starts.

## 12.2 Heating Operation

### 12.2.1 Outdoor fan control

- When heating operation is enabled, based on outdoor ambient temperature, fan motor control will be adjusted according to figure below for Heating overload control:

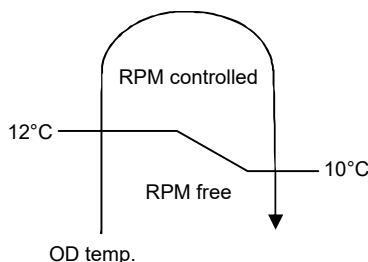

### 12.2.2 Heating Room Temp Sampling Control

- To improve the judgment accuracy, indoor room temperature sampling starts when any indoor unit has stopped capability supplied (heating thermo-off) during heating operation with compressor ON, outdoor unit will send signal to all thermo-off indoor units to ON fan motor and get room temperature sample.
- To prevent discharge temperature drop at indoor units which is ON when sampling the room temperature of heating thermo-off units, the compressor frequency is increased accordingly.
- However, if indoor room temperature is much higher compare to remote control setting temperature, before thermo-off, sampling of corresponding indoor unit will be cancelled.

### 12.2.3 Powerful Operation 2

- During cooling / heating operation, this control is to provide fast cooling / heating operation compare to normal operation.
- Operation start if all condition below are complied:
  - Powerful operation ON for indoor unit.
  - Not under Annual Cooling control.
- Operation content:
  - Outdoor fan speed will adjust automatically.
  - Compressor frequency will adjust automatically.
- Operation stop when comply either one of the follow conditions:
  - When the powerful operation is OFF for all indoor units.
  - When annual cooling control activated.

## 12.3 Outdoor Quiet Cooling Operation Control

- Purpose**  
Provide quiet cooling operation when only 1 indoor in operation.
- Start Condition**
  - Indoor fan speed is lower than Lo fan.
  - Only 1 operation indoor unit.
  - Not in any cooling overload zone.
  - Not during annual cooling
  - Not initial frequency operation.
  - Not during starting control.
  - Not during “Electronic part temperature rise protection by outdoor air & total current”
  - Not during “Electronic part temperature rise protection by total current”
  - Not during “IPM temperature rise prevention control”
  - During cool mode

All conditions above are satisfied and function selection enable.
- Control Contents**  
Compressor frequency and outdoor fan speed maximum limit is set. Adjust accordingly.

	Compressor frequency	Outdoor fan speed
Cool/Quiet	#27 Hz	#400 rpm

- Cancel Condition
  - Indoor fan speed is equal or higher than Lo fan.
  - > 1 operation indoor unit.
  - In any cooling overload zone.
  - During annual cooling
  - Initial frequency operation.
  - During starting control.
  - During “Electronic part temperature rise protection by outdoor air & total current”
  - During “Electronic part temperature rise protection by total current”
  - During “IPM temperature rise prevention control”
  - Not during cool modeWhen any above is satisfied.



### 13. Simultaneous Operation Control

- Operation modes which can be selected using the remote control unit:
  - Automatic, Cooling, Dry, Heating and e-ion operation mode.
- Types of operation modes which can be performed simultaneously
  - Cooling operation and Cooling, Dry or e-ion operation.
  - Heating operation and Heating operation.
- Types of operation modes which cannot be performed simultaneously
  - During cooling operation, heating operation is impossible at another indoor unit in another room.
  - The priority is given to cooling operation if the cooling mode is selected first. In another room where heating mode is selected afterward, the POWER LED blinks to indicate the heating operation is in standby condition, where the fan is stopped hence no discharged air.
  - During heating operation, cooling operation is impossible at another indoor unit in another room.
  - The priority is given to heating operation if the heating mode is selected first. In another room where cooling mode is selected afterward, the POWER LED blinks to indicate the cooling operation is in standby condition, where the fan is stopped hence no discharged air.
- Operation mode priority control
  - The operation mode designated first by the indoor unit has priority.
  - If the priority indoor unit stops operation or initiates the fan operation, the priority is transferred to other indoor units.

“Waiting” denotes the standby status in which the POWER LED blinks (ON for 2.5 seconds and OFF for 0.5 seconds) and the fan is stopped.

		ROOM A	Non Priority Unit (2 <sup>nd</sup> ON)			
		Cooling	Dry	Heating	e-ion	
Priority Unit (1 <sup>st</sup> ON)	Cooling	C	D	Waiting	E	
	Dry	C	C	C	C	
		D	D	D	D	
	Heating	Waiting	Waiting	H	Stop	
	e-ion	H	H	H	H	
	C	D	H	E		
	E	E	Stop	E		

In the e-ion mode, priority is transferred to a non-priority unit.

Note

- C: Cooling operation mode
- D: Dry operation mode
- H: Heating operation mode
- E: e-ion operation mode

## 14. Protection Control

### 14.1 Freeze Prevention control (Cool)

- When received freeze prevention signal from indoor unit, the compressor frequency changes according to indoor heat exchanger temperature.
- When indoor unit request capability OFF due to freeze condition, immediately the capability supply to targeted indoor unit stops.

### 14.2 Dew Prevention control (Cool)

- When received dew prevention signal from indoor unit, which according to indoor intake temperature and indoor heat exchanger temperature the compressor frequency changes.

### 14.3 Electronic Parts Temperature Rise Protection 1 (Cool)

- This control prevents electronic parts temperature rise during cooling overload condition.
- Start conditions:
  - Outdoor ambient temperature is at protection region as shown in figure below:

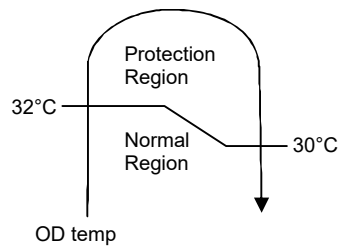

- Outdoor unit total current is above 5.3A.
- Control content
  - Outdoor fan speed is adjusted accordingly.
- Control stop condition
  - When outdoor ambient temperature is back to normal region.
- During this control, outdoor fan speed does not reduce for Quiet operation.

### 14.4 Electronic Parts Temperature Rise Protection 2 (Cool)

- This control prevents electronic parts temperature rise during cooling/dry operation.
- Start conditions:
  - Total current is at protection region as shown in figure below:

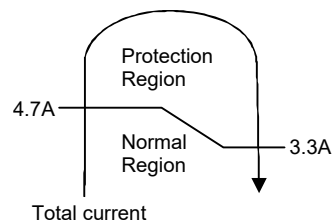

- Control content
  - Outdoor fan speed is adjusted accordingly.
- Control stop conditions
  - When total current is back to normal region.
- During this control, outdoor fan speed does not reduce for Quiet operation.

### 14.5 Cooling overload control (Cool)

- This control detect outdoor pipe temperature and perform the compressor frequency restriction during cooling operation.

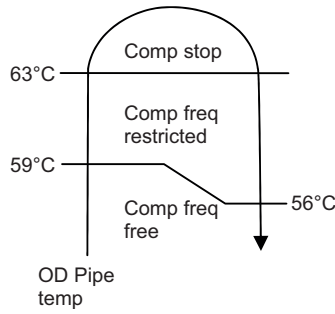

### 14.6 Heating overload control (Heat)

- This control detect indoor pipe temperature and perform the compressor frequency restriction during heating operation.

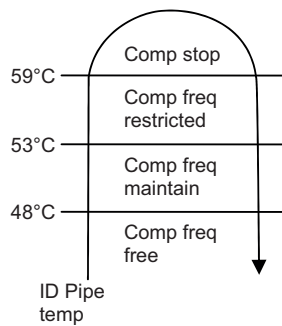

- This control detect outdoor ambient temperature and perform the fan speed adjustment during heating operation.

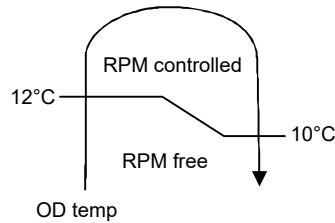

### 14.7 Extreme Low Temperature Compressor low pressure protection control (Heat)

- This control is to prevent low pressure drops too low during extremely low outdoor ambient temperature to improve the compressor reliability.
- During heating operation, when outdoor ambient temperature is in Zone 1, this control will be activated. Compressor frequency restriction will be based on outdoor piping temperature.

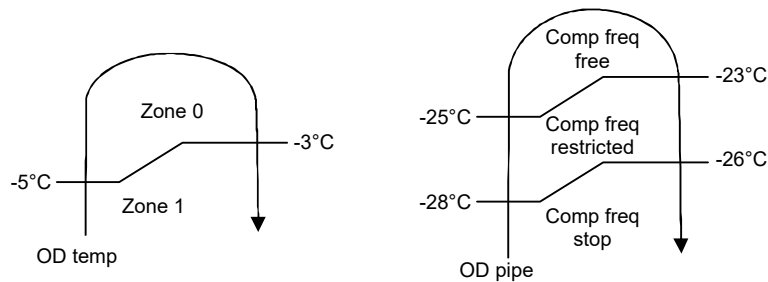

## 14.8 Deice Control

- When outdoor pipe temperature and outdoor air temperature is low, deice operation starts where indoor fan motor and outdoor fan motor stop, indoor unit horizontal vane close and operation LED blink with compressor ON.

## 14.9 Time Delay Safety Control (Restart Control)

- The compressor will not restart within three minutes after compressor is stopped.
- This control is not applicable if the power supply reset or after deice condition.

## 14.10 30 seconds Force Operation

- Once the compressor starts operation, it will not stop its operation for 30 seconds in order to cycle back compressor oil.
- However, it can be stopped using remote control or Auto OFF/ON button at indoor unit.

## 14.11 Total Current Control

- When the outdoor unit total running current (AC) exceeds X value, compressor frequency will decrease.
- If the running current does not exceed X value for 5 seconds, compressor frequency will increase.
- However, if total outdoor unit running current exceeds Y value, compressor will be stopped immediately for 3 minutes.

Model		2TZ41TBE	2TZ50TBE
Cool (X)	A	10.95 A	11.50 A
	B	10.95 A	10.95 A
	C	10.05 A	10.05 A
Heat (X)		11.50 A	11.50 A
Y		15.57 A	15.57 A

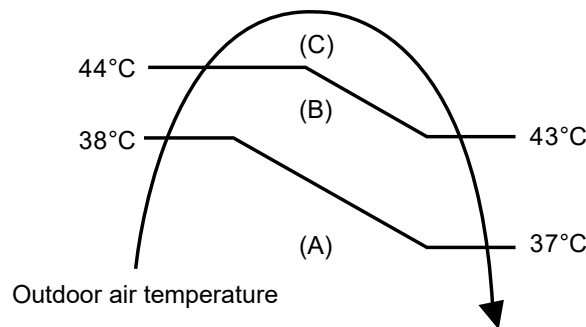

## 14.12 IPM (power transistor) Protection Control

- Overheating Prevention Control
  - If IPM temperature rises to 80°C, outdoor fan speed will be increased.
  - When the IPM temperature rises to 95°C, compressor operation will stop immediately.
  - Compressor operation restarts when temperature decreases to 90°C.
  - If IPM temperature detected less than -30°C, IPM is judged as open circuit ("F96" is indicated).
- DC peak current control
  - When IPM DC current exceeds set value of 30.0 ± 3.0 A, the compressor will stop.
  - If the DC peak current detected within 30 seconds after operation starts, compressor will restart after 1 minute.
  - If the DC peak current detected 30 seconds or more after operation starts, compressor will restart after 2 minutes.
  - Within 30 seconds after compressor restarts, if the DC peak current is exceeded set value continuously for 7 times, all indoor and outdoor relays will be cut off ("F99" is indicated).
- Error reset can be done by power supply reset.

### **14.13 Compressor Protection Control (Gas leak detection control 1)**

- Control start conditions
  - For 5 minutes (Cooling or Soft Dry) or 8 minutes (Heating), the compressor continuously operates and total current is low.
  - During Cooling or Soft Dry operation:  
Indoor intake temperature — indoor piping temperature is below 4°C.
  - During Heating operation:  
Indoor pipe temperature — indoor intake temperature is below 3°C.
  - Not during deice control.
  - Compressor ON with maximum frequency.
- Control content
  - Compressor stops (and restart after 3 minutes)
  - If the conditions above happen 4 times within 60 minutes, the unit will stop operation ("F91" is indicated).

### **14.14 Compressor Protection Control (Gas leak detection control 2)**

- This control detect gas leakage condition to prevent compressor damage.
- Control start condition
  - All connected indoor units capability supply ON.
  - Compressor ON with maximum frequency.
  - Not during annual cooling.
  - Compressor discharge temperature high.
- Control content
  - Compressor OFF during this control ("F91" is memorized in EEPROM)
  - If the above conditions happen 2 times within 60 minutes, indoor units' Timer LED will blinks ("F91" is indicated at all indoor units)

### **14.15 Valve close detection control**

- This control detects 3-way valve close condition to prevent damage to refrigerant cycle.
- Start conditions:
  - For all connected indoor units, if Indoor intake temperature — indoor piping temperature are between -2°C and 2°C continuously for 5 minutes after compressor ON at first cooling operation.
  - The first cooling operation is defined as cooling operation is ON for less than 8 minutes after new installation or after pump down.
- Control content
  - During this control, compressor stop, indoor units' Timer LED will blink. ("F91" is indicated at indoor units)
- Error reset can be done by power supply reset or reset by using remote control.

### **14.16 Compressor discharge high pressure protection control**

- This control protect by using high pressure switch during operation.
- Start conditions
  - High pressure switch is activated (from normally close to open) when outdoor operation mode is cooling or heating during compressor running.
- Control 1 content
  - Compressor stop when high pressure switch is opened and restart after high pressure switch closed. If this condition happen 4 times within 30 minutes, "F94" is indicated.
  - After 30 minutes, counter is reset if this condition does not happen for 4 times.
- Control 1 stop conditions
  - Power supply reset
  - Reset by using remote control

### 14.17 Compressor discharge high temperature protection control

- This control detect/compressor tank temperature and perform the compressor frequency restriction.

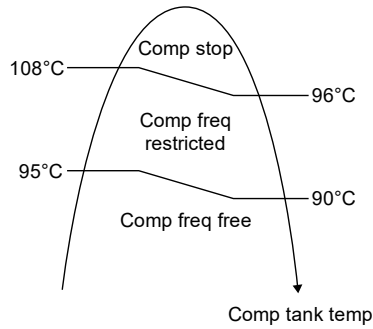

- When the discharge temperature more than 108C, the compressor stops. If this condition happens for 3 times within 30 minutes, "F97" is indicated.

### 14.18 Cooling Outdoor Air Temperature Control (Cool)

- The compressor will be stopped to avoid compressor overloading.

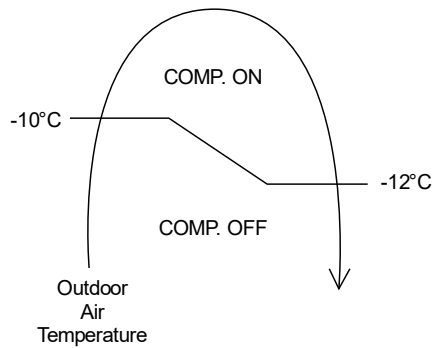

### 14.19 Heating Outdoor Air Temperature Control (Heat)

- The compressor will be stopped to avoid compressor overloading.

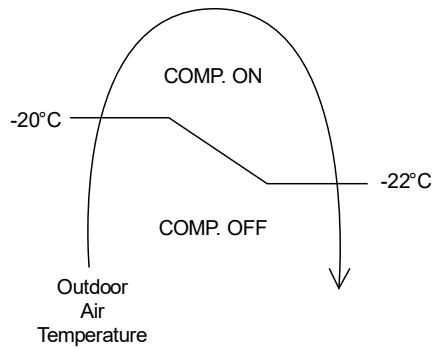

# 15. Servicing Mode

## 15.1 Pump down operation

- Operate the pump down process according to the following procedure
  - Confirm the valve on the liquid side and gas side are open.
  - Short the CN-PUMP button on the Service PCB inside the outdoor unit for more than 5 seconds. Pump down (cooling) operation is performed for 15 minutes.
  - Set the liquid side 3 way valve to close position and wait until the pressure gauge indicates 0.01MPa (0.1kg/cm<sup>2</sup>G).
  - Immediate set the gas side valve to close position and then Short the CN-PUMP button to stop the pump down operation.

NOTE: Pump down operation will stop automatically after 15 minutes if CN-PUMP button is not shorted again. Pump down operation is not started within 3 minutes after compressor is stopped.

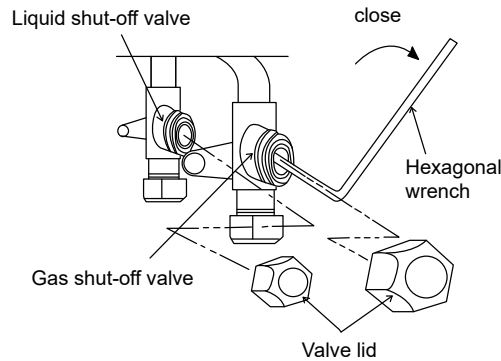

## 15.2 Heating only function

The equipment can be set to heating only operation by some setting on the Outdoor unit main circuit board

- Switch off power supply to the outdoor unit, unplug and remove the lead wire on CN-HEAT.

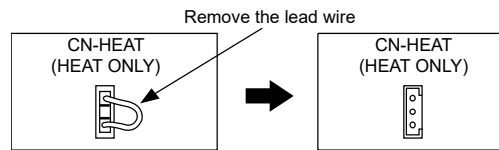

# 16. Troubleshooting Guide

## 16.1 Self Diagnosis Function

Diagnosis display	Abnormality or protection control	Abnormality judgment	Protection operation	Problem	Check location
H11	Indoor/outdoor abnormal communication	After operation for 1 minutes	Indoor fan only operation can start by entering into force cooling operation	Indoor/outdoor communication not establish	<ul style="list-style-type: none"> <li>Indoor/outdoor wire terminal</li> <li>Indoor/outdoor PCB</li> <li>Indoor/outdoor connection wire</li> </ul>
H12	Indoor unit capacity unmatched	90s after power supply	-	Total indoor capability more than maximum limit or less than minimum limit, or number of indoor unit less than two	<ul style="list-style-type: none"> <li>Indoor/outdoor connection wire</li> <li>Indoor/outdoor PCB</li> <li>Specification and combination table in catalogue</li> </ul>
H15	Compressor temperature sensor abnormality	Continuous for 5s	-	Compressor temperature sensor open or short circuit	<ul style="list-style-type: none"> <li>Compressor temperature sensor lead wire and connector</li> </ul>
H16	Outdoor current transformer (CT) abnormality	-	-	Current transformer faulty or compressor faulty	<ul style="list-style-type: none"> <li>Outdoor PCB faulty or compressor faulty</li> </ul>
H27	Outdoor air temperature sensor abnormality	Continuous for 5s	-	Outdoor air temperature sensor open or short circuit	<ul style="list-style-type: none"> <li>Outdoor air temperature sensor lead wire and connector</li> </ul>
H28	Outdoor heat exchanger temperature sensor 1 abnormality	Continuous for 5s	-	Outdoor heat exchanger temperature sensor 1 open or short circuit	<ul style="list-style-type: none"> <li>Outdoor heat exchanger temperature sensor 1 lead wire and connector</li> </ul>
H32	Outdoor heat exchanger temperature sensor 2 abnormality	Continuous for 5s	-	Outdoor heat exchanger temperature sensor 2 open or short circuit	<ul style="list-style-type: none"> <li>Outdoor heat exchanger temperature sensor 2 lead wire and connector</li> </ul>
H33	Indoor/outdoor misconnection abnormality	-	-	Indoor and outdoor rated voltage different	<ul style="list-style-type: none"> <li>Indoor and outdoor units check</li> </ul>
H36	Outdoor gas pipe temperature sensor abnormality	Continuous for 5s	Heating protection operation only	Outdoor gas pipe temperature sensor open or short circuit	<ul style="list-style-type: none"> <li>Outdoor gas pipe temperature sensor lead wire and connector</li> </ul>
H37	Outdoor liquid pipe temperature sensor abnormality	Continuous for 5s	Cooling protection operation only	Outdoor liquid pipe temperature sensor open or short circuit	<ul style="list-style-type: none"> <li>Outdoor liquid pipe temperature sensor lead wire and connector</li> </ul>
H64	Outdoor high pressure sensor abnormality	Continuous for 1 minute	-	High pressure sensor open circuit during compressor stop	<ul style="list-style-type: none"> <li>High pressure sensor</li> <li>Lead wire and connector</li> </ul>
H67	Nanoe abnormality	Nanoe stop for 5 minutes for 3 times	-	Nanoe faulty	<ul style="list-style-type: none"> <li>PCB</li> <li>Nanoe system</li> <li>High voltage</li> </ul>
H70	Light sensor abnormality	Continuous for 24 hours, 15 days	-	Light sensor open or short circuit	<ul style="list-style-type: none"> <li>Light sensor (defective or disconnect)</li> </ul>
H97	Outdoor fan motor mechanism lock	2 times happen within 20 minutes	-	Outdoor fan motor lock or feedback abnormal	<ul style="list-style-type: none"> <li>Outdoor fan motor lead wire and connector</li> <li>Fan motor lock or block</li> </ul>
H98	Indoor high pressure protection	-	-	Indoor high pressure protection (Heating)	<ul style="list-style-type: none"> <li>Check indoor heat exchanger</li> <li>Air filter dirty</li> <li>Air circulation short circuit</li> </ul>
H99	Indoor operating unit freeze protection	-	-	Indoor freeze protection (Cooling)	<ul style="list-style-type: none"> <li>Check indoor heat exchanger</li> <li>Air filter dirty</li> <li>Air circulation short circuit</li> </ul>
F11	4-way valve switching abnormality	4 times happen within 30 minutes	-	4-way valve switching abnormal	<ul style="list-style-type: none"> <li>4-way valve</li> <li>Lead wire and connector</li> </ul>



Diagnosis display	Abnormality or protection control	Abnormality judgment	Protection operation	Problem	Check location
F17	Indoor standby units freezing abnormality	3 times happen within 40 minutes	-	Wrong wiring and connecting pipe, expansion valve leakage	<ul style="list-style-type: none"> <li>Check indoor/outdoor connection wire and pipe</li> <li>Indoor heat exchanger sensor lead wire and connector</li> <li>Expansion valve lead wire and connector</li> </ul>
F90	Power factor correction (PFC) circuit protection	4 times happen within 20 minutes	-	Power factor correction circuit abnormal	<ul style="list-style-type: none"> <li>Outdoor PCB faulty</li> </ul>
F91	Refrigerant cycle abnormality	4 times happen within 60 minutes	-	Refrigeration cycle abnormal	<ul style="list-style-type: none"> <li>Insufficient refrigerant or valve close</li> </ul>
F93	Compressor abnormal revolution	4 times happen within 20 minutes	-	Compressor abnormal evolution	<ul style="list-style-type: none"> <li>Power transistor module faulty or compressor lock</li> </ul>
F94	Compressor discharge pressure overshoot protection	4 times happen within 20 minutes	-	Compressor discharge pressure overshoot	<ul style="list-style-type: none"> <li>Check refrigeration system</li> </ul>
F95	Outdoor cooling high pressure protection	4 occurrences within 20 minutes	-	Cooling high pressure protection	<ul style="list-style-type: none"> <li>Check refrigeration system</li> <li>Outdoor air circuit</li> </ul>
F96	Power transistor module overheating protection	4 times happen within 30 minutes	-	Power transistor module overheat	<ul style="list-style-type: none"> <li>PCB faulty</li> <li>Outdoor air circuit (fan motor)</li> </ul>
F97	Compressor overheating protection	3 times happen within 30 minutes	-	Compressor overheat	<ul style="list-style-type: none"> <li>Insufficient refrigerant</li> </ul>
F98	Total running current protection	3 times happen within 20 minutes	-	Total current protection	<ul style="list-style-type: none"> <li>Check refrigeration system</li> <li>Power source or compressor lock</li> </ul>
F99	Outdoor direct current (DC) peak detection	Continuous happen for 7 times	-	Power transistor module current protection	<ul style="list-style-type: none"> <li>Power transistor module faulty or compressor lock</li> </ul>

# 17. Disassembly and Assembly Instructions

## ⚠ WARNING

High Voltage is generated in the electrical parts area by the capacitor. Ensure that the capacitor has discharged sufficiently before proceeding with repair work. Failure to heed this caution may result in electric shocks.

### 17.1 Outdoor Unit Removal Procedure

⚠ Caution! When handling electronic controller, be careful of electrostatic discharge.

#### 17.1.1 Removing the Cabinet Top Plate and Cabinet Front Plate

1. Remove the cabinet top plate (by removing the 5 screws).
2. Remove the 8 screws fixing the cabinet front plate, release 6 hooks and pull the cabinet front plate toward front side.

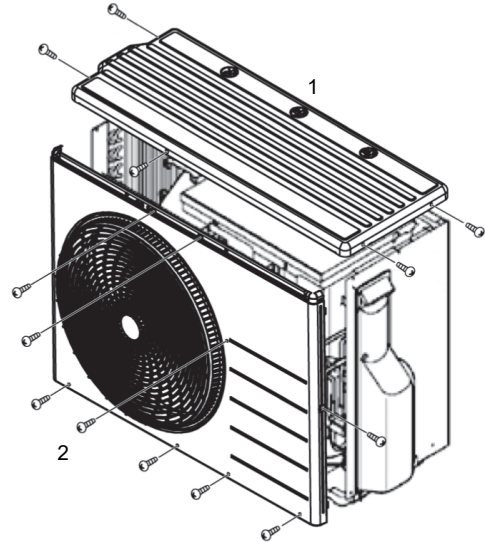

#### 17.1.2 Removing the Control Board Cover

3. Remove the control board cover (remove 1 screw).
4. Remove the terminal cover (remove 2 screws).
5. Remove the terminal cover (top) and disconnect all the lead wires (3 fasten tab) inside.

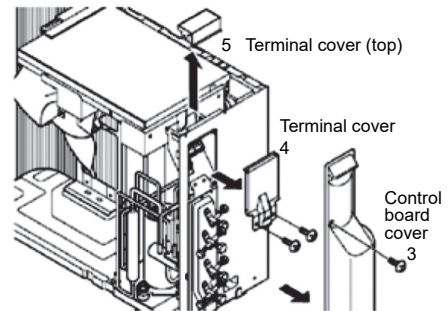

#### 17.1.3 Removing the Control Board

6. Remove the control board cover.
7. Remove the 6 screws at the positions on the control board indicated by arrows.
8. Disconnect the connectors and pipe sensor connected to the compressor and reactor.
9. Remove the control board.

When pulling the control board upward, it may not be possible to remove it because of the way in which the ground wire and other wires are routed. In this case, it is removed after the control board cover itself has been removed.

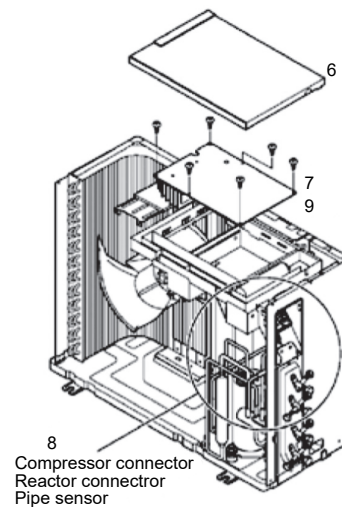

### 17.1.4 Removing the Propeller Fan and Fan Motor

1. Remove the cabinet top plate and cabinet front plate.
2. Remove the propeller fan by removing the nut turning clockwise at its center.
3. Disconnect the connector of the fan motor from the control board.
4. Loosen the 4 screws at the fan motor mounting then remove the fan motor.

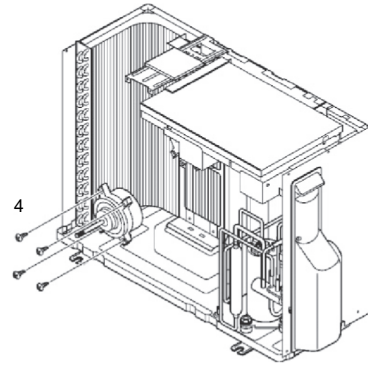
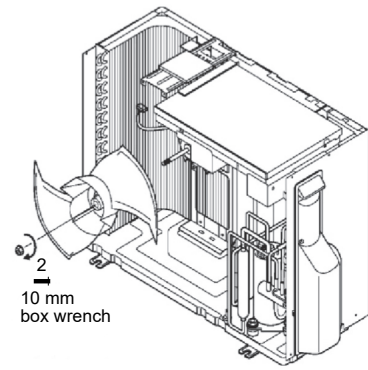

## 18. Technical Data

Technical data provided are based on the air conditioner running under free frequency.

### 18.1 Cool Mode Performance Data

Unit setting: Standard piping length, Hi Fan, Cool mode at 16°C

Voltage: 230V, 50Hz

#### 18.1.1 CU-2TZ41TBE

Combination (Capacity)	Outdoor Air Temp. °C DB	Indoor Air Temp. °C WB											
		16		17.5		18		19		22		24	
		Total Q	Input Power	Total Q	Input Power	Total Q	Input Power	Total Q	Input Power	Total Q	Input Power	Total Q	Input Power
1.6	22	1.70	0.17	1.66	0.16	1.63	0.16	1.61	0.16	2.47	0.30	3.04	0.39
	25	1.72	0.18	1.68	0.18	1.66	0.17	1.63	0.17	2.43	0.32	2.97	0.42
	29	1.91	0.22	1.89	0.22	1.88	0.22	1.86	0.22	2.43	0.39	2.81	0.47
	32	2.49	0.61	2.45	0.61	2.43	0.61	2.40	0.61	2.62	0.61	2.76	0.62
	35	2.39	0.65	2.35	0.65	2.33	0.65	2.30	0.65	2.56	0.65	2.71	0.66
	40	2.16	0.70	2.16	0.70	2.14	0.70	2.11	0.70	2.36	0.71	2.52	0.71
	43	2.06	0.75	2.02	0.75	2.01	0.75	1.98	0.75	2.21	0.75	2.36	0.76
	46	1.84	0.80	1.83	0.80	1.82	0.80	1.79	0.80	2.03	0.81	2.19	0.81
2.0	22	2.15	0.22	2.09	0.21	2.06	0.20	2.03	0.20	3.11	0.38	3.83	0.50
	25	2.17	0.23	2.12	0.22	2.10	0.22	2.06	0.22	3.07	0.41	3.74	0.54
	29	2.41	0.28	2.38	0.28	2.37	0.28	2.35	0.28	3.06	0.50	3.54	0.60
	32	3.15	0.78	3.09	0.78	3.06	0.78	3.02	0.78	3.30	0.78	3.48	0.79
	35	3.02	0.83	2.96	0.83	2.94	0.83	2.90	0.83	3.23	0.83	3.42	0.84
	40	2.73	0.90	2.72	0.90	2.70	0.90	2.67	0.90	2.97	0.91	3.17	0.90
	43	2.60	0.95	2.55	0.96	2.53	0.96	2.50	0.96	2.79	0.96	2.98	0.97
	46	2.32	1.02	2.31	1.02	2.30	1.02	2.26	1.02	2.56	1.03	2.77	1.03
2.5	22	2.59	0.28	2.52	0.27	2.49	0.26	2.45	0.26	3.75	0.49	4.62	0.64
	25	2.62	0.30	2.55	0.29	2.53	0.29	2.49	0.28	3.70	0.53	4.52	0.69
	29	2.91	0.36	2.87	0.36	2.86	0.36	2.84	0.36	3.70	0.64	4.27	0.77
	32	3.80	1.00	3.72	1.00	3.70	1.00	3.65	1.00	3.98	1.01	4.20	1.01
	35	3.64	1.07	3.57	1.07	3.55	1.07	3.50	1.07	3.90	1.08	4.13	1.08
	40	3.29	1.16	3.28	1.16	3.26	1.16	3.22	1.16	3.58	1.17	3.83	1.17
	43	3.14	1.23	3.08	1.23	3.06	1.23	3.02	1.23	3.36	1.24	3.59	1.25
	46	2.80	1.32	2.79	1.32	2.77	1.32	2.73	1.32	3.09	1.33	3.34	1.33
3.5	22	2.96	0.34	2.88	0.33	2.84	0.32	2.80	0.31	4.29	0.59	5.28	0.78
	25	3.00	0.37	2.92	0.35	2.89	0.35	2.84	0.34	4.23	0.64	5.16	0.84
	29	3.32	0.44	3.28	0.44	3.27	0.44	3.24	0.44	4.22	0.78	4.88	0.94
	32	4.34	1.22	4.26	1.22	4.23	1.22	4.17	1.22	4.55	1.23	4.80	1.23
	35	4.16	1.30	4.08	1.30	4.05	1.30	4.00	1.30	4.46	1.31	4.72	1.31
	40	3.76	1.41	3.75	1.41	3.73	1.41	3.68	1.41	4.10	1.42	4.38	1.42
	43	3.59	1.50	3.52	1.50	3.50	1.50	3.45	1.50	3.84	1.51	4.11	1.52
	46	3.20	1.60	3.19	1.60	3.17	1.60	3.12	1.60	3.54	1.61	3.82	1.61

Combination (Capacity)	Outdoor Air Temp. °C DB	Indoor Air Temp. °C WB											
		16		17.5		18		19		22		24	
		Total Q	Input Power	Total Q	Input Power	Total Q	Input Power	Total Q	Input Power	Total Q	Input Power	Total Q	Input Power
1.6 + 1.6	22	4.32	0.64	4.44	0.63	4.48	0.62	4.56	0.62	4.90	0.64	5.12	0.66
	25	4.19	0.69	4.31	0.68	4.34	0.67	4.42	0.67	4.75	0.70	4.97	0.71
	29	4.16	0.82	4.24	0.80	4.24	0.78	4.28	0.78	4.42	0.78	4.60	0.79
	32	4.16	1.01	4.18	1.01	4.17	1.01	4.14	1.01	4.37	1.01	4.51	1.01
	35	4.08	1.08	4.04	1.08	4.03	1.08	4.00	1.08	4.22	1.08	4.36	1.08
	40	3.68	1.10	3.64	1.10	3.63	1.10	3.60	1.10	3.79	1.10	3.92	1.10
	43	3.52	1.17	3.49	1.17	3.48	1.17	3.45	1.17	3.64	1.21	3.77	1.24
	46	3.32	1.22	3.28	1.22	3.27	1.22	3.24	1.22	3.43	1.22	3.56	1.24
1.6 + 2.0	22	4.86	0.74	5.00	0.73	5.04	0.71	5.13	0.71	5.51	0.74	5.76	0.76
	25	4.71	0.80	4.84	0.79	4.89	0.78	4.98	0.77	5.34	0.80	5.59	0.83
	29	4.68	0.95	4.77	0.93	4.77	0.90	4.82	0.90	4.98	0.90	5.18	0.91
	32	4.68	1.16	4.71	1.16	4.69	1.16	4.66	1.16	4.91	1.16	5.08	1.16
	35	4.59	1.25	4.55	1.25	4.53	1.25	4.50	1.25	4.74	1.25	4.91	1.25
	40	4.14	1.28	4.10	1.28	4.08	1.28	4.05	1.28	4.27	1.28	4.41	1.28
	43	3.96	1.35	3.93	1.35	3.91	1.35	3.89	1.35	4.10	1.40	4.24	1.44
	46	3.15	1.13	3.20	1.11	3.20	1.10	3.20	1.10	3.36	1.08	3.47	1.06
1.6 + 2.5	22	5.08	0.81	5.22	0.80	5.26	0.79	5.36	0.79	5.75	0.82	6.02	0.84
	25	4.92	0.88	5.06	0.87	5.10	0.86	5.20	0.85	5.58	0.89	5.83	0.91
	29	4.89	1.05	4.98	1.02	4.98	0.99	5.03	0.99	5.20	0.99	5.41	1.01
	32	4.89	1.29	4.92	1.29	4.90	1.29	4.87	1.29	5.13	1.29	5.30	1.29
	35	4.79	1.38	4.75	1.38	4.73	1.38	4.70	1.38	4.95	1.38	5.12	1.38
	40	4.32	1.41	4.28	1.41	4.26	1.41	4.23	1.41	4.46	1.41	4.61	1.41
	43	4.14	1.50	4.10	1.50	4.09	1.50	4.06	1.50	4.28	1.55	4.42	1.59
	46	3.29	1.24	3.34	1.23	3.34	1.21	3.34	1.21	3.51	1.19	3.62	1.17
1.6 + 3.5	22	5.08	0.81	5.22	0.80	5.26	0.79	5.36	0.79	5.75	0.82	6.02	0.84
	25	4.92	0.88	5.06	0.87	5.10	0.86	5.20	0.85	5.58	0.89	5.83	0.91
	29	4.89	1.05	4.98	1.02	4.98	0.99	5.03	0.99	5.20	0.99	5.41	1.01
	32	4.89	1.29	4.92	1.29	4.90	1.29	4.87	1.29	5.13	1.29	5.30	1.29
	35	4.79	1.38	4.75	1.38	4.73	1.38	4.70	1.38	4.95	1.38	5.12	1.38
	40	4.32	1.41	4.28	1.41	4.26	1.41	4.23	1.41	4.46	1.41	4.61	1.41
	43	4.14	1.50	4.10	1.50	4.09	1.50	4.06	1.50	4.28	1.55	4.42	1.59
	46	3.29	1.24	3.34	1.23	3.34	1.21	3.34	1.21	3.51	1.19	3.62	1.17
2.0 + 2.0	22	5.08	0.81	5.22	0.80	5.26	0.79	5.36	0.79	5.75	0.82	6.02	0.84
	25	4.92	0.88	5.06	0.87	5.10	0.86	5.20	0.85	5.58	0.89	5.83	0.91
	29	4.89	1.05	4.98	1.02	4.98	0.99	5.03	0.99	5.20	0.99	5.41	1.01
	32	4.89	1.29	4.92	1.29	4.90	1.29	4.87	1.29	5.13	1.29	5.30	1.29
	35	4.79	1.38	4.75	1.38	4.73	1.38	4.70	1.38	4.95	1.38	5.12	1.38
	40	4.32	1.41	4.28	1.41	4.26	1.41	4.23	1.41	4.46	1.41	4.61	1.41
	43	4.14	1.50	4.10	1.50	4.09	1.50	4.06	1.50	4.28	1.55	4.42	1.59
	46	3.29	1.24	3.34	1.23	3.34	1.21	3.34	1.21	3.51	1.19	3.62	1.17

Combination (Capacity)	Outdoor Air Temp. °C DB	Indoor Air Temp. °C WB											
		16		17.5		18		19		22		24	
		Total Q	Input Power	Total Q	Input Power	Total Q	Input Power	Total Q	Input Power	Total Q	Input Power	Total Q	Input Power
2.0 + 2.5	22	5.08	0.81	5.22	0.80	5.26	0.79	5.36	0.79	5.75	0.82	6.02	0.84
	25	4.92	0.88	5.06	0.87	5.10	0.86	5.20	0.85	5.58	0.89	5.83	0.91
	29	4.89	1.05	4.98	1.02	4.98	0.99	5.03	0.99	5.20	0.99	5.41	1.01
	32	4.89	1.29	4.92	1.29	4.90	1.29	4.87	1.29	5.13	1.29	5.30	1.29
	35	4.79	1.38	4.75	1.38	4.73	1.38	4.70	1.38	4.95	1.38	5.12	1.38
	40	4.32	1.41	4.28	1.41	4.26	1.41	4.23	1.41	4.46	1.41	4.61	1.41
	43	4.14	1.50	4.10	1.50	4.09	1.50	4.06	1.50	4.28	1.55	4.42	1.59
	46	3.29	1.24	3.34	1.23	3.34	1.21	3.34	1.21	3.51	1.19	3.62	1.17
2.0 + 3.5	22	5.08	0.81	5.22	0.80	5.26	0.79	5.36	0.79	5.75	0.82	6.02	0.84
	25	4.92	0.88	5.06	0.87	5.10	0.86	5.20	0.85	5.58	0.89	5.83	0.91
	29	4.89	1.05	4.98	1.02	4.98	0.99	5.03	0.99	5.20	0.99	5.41	1.01
	32	4.89	1.29	4.92	1.29	4.90	1.29	4.87	1.29	5.13	1.29	5.30	1.29
	35	4.79	1.38	4.75	1.38	4.73	1.38	4.70	1.38	4.95	1.38	5.12	1.38
	40	4.32	1.41	4.28	1.41	4.26	1.41	4.23	1.41	4.46	1.41	4.61	1.41
	43	4.14	1.50	4.10	1.50	4.09	1.50	4.06	1.50	4.28	1.55	4.42	1.59
	46	3.29	1.24	3.34	1.23	3.34	1.21	3.34	1.21	3.51	1.19	3.62	1.17
2.5 + 2.5	22	5.08	0.81	5.22	0.80	5.26	0.79	5.36	0.79	5.75	0.82	6.02	0.84
	25	4.92	0.88	5.06	0.87	5.10	0.86	5.20	0.85	5.58	0.89	5.83	0.91
	29	4.89	1.05	4.98	1.02	4.98	0.99	5.03	0.99	5.20	0.99	5.41	1.01
	32	4.89	1.29	4.92	1.29	4.90	1.29	4.87	1.29	5.13	1.29	5.30	1.29
	35	4.79	1.38	4.75	1.38	4.73	1.38	4.70	1.38	4.95	1.38	5.12	1.38
	40	4.32	1.41	4.28	1.41	4.26	1.41	4.23	1.41	4.46	1.41	4.61	1.41
	43	4.14	1.50	4.10	1.50	4.09	1.50	4.06	1.50	4.28	1.55	4.42	1.59
	46	3.29	1.24	3.34	1.23	3.34	1.21	3.34	1.21	3.51	1.19	3.62	1.17
2.5 + 3.5	22	5.08	0.81	5.22	0.80	5.26	0.79	5.36	0.79	5.75	0.82	6.02	0.84
	25	4.92	0.88	5.06	0.87	5.10	0.86	5.20	0.85	5.58	0.89	5.83	0.91
	29	4.89	1.05	4.98	1.02	4.98	0.99	5.03	0.99	5.20	0.99	5.41	1.01
	32	4.89	1.29	4.92	1.29	4.90	1.29	4.87	1.29	5.13	1.29	5.30	1.29
	35	4.79	1.38	4.75	1.38	4.73	1.38	4.70	1.38	4.95	1.38	5.12	1.38
	40	4.32	1.41	4.28	1.41	4.26	1.41	4.23	1.41	4.46	1.41	4.61	1.41
	43	4.14	1.50	4.10	1.50	4.09	1.50	4.06	1.50	4.28	1.55	4.42	1.59
	46	3.29	1.24	3.34	1.23	3.34	1.21	3.34	1.21	3.51	1.19	3.62	1.17

Total Q: Total Cooling Capacity (kW)  
Input Power (kW)

## 18.1.2 CU-2TZ50TBE

Combination (Capacity)	Outdoor Air Temp. °C DB	Indoor Air Temp. °C WB											
		16		17.5		18		19		22		24	
		Total Q	Input Power	Total Q	Input Power	Total Q	Input Power	Total Q	Input Power	Total Q	Input Power	Total Q	Input Power
1.6	22	1.70	0.17	1.66	0.16	1.63	0.16	1.61	0.16	2.47	0.30	3.04	0.39
	25	1.72	0.18	1.68	0.18	1.66	0.17	1.63	0.17	2.43	0.32	2.97	0.42
	29	1.91	0.22	1.89	0.22	1.88	0.22	1.86	0.22	2.43	0.39	2.81	0.47
	32	2.49	0.61	2.45	0.61	2.43	0.61	2.40	0.61	2.62	0.61	2.76	0.62
	35	2.39	0.65	2.35	0.65	2.33	0.65	2.30	0.65	2.56	0.65	2.71	0.66
	40	2.16	0.70	2.16	0.70	2.14	0.70	2.11	0.70	2.36	0.71	2.52	0.71
	43	2.06	0.75	2.02	0.75	2.01	0.75	1.98	0.75	2.21	0.75	2.36	0.76
	46	1.84	0.80	1.83	0.80	1.82	0.80	1.79	0.80	2.03	0.81	2.19	0.81
2.0	22	2.15	0.22	2.09	0.21	2.06	0.20	2.03	0.20	3.11	0.38	3.83	0.50
	25	2.17	0.23	2.12	0.22	2.10	0.22	2.06	0.22	3.07	0.41	3.74	0.54
	29	2.41	0.28	2.38	0.28	2.37	0.28	2.35	0.28	3.06	0.50	3.54	0.60
	32	3.15	0.78	3.09	0.78	3.06	0.78	3.02	0.78	3.30	0.78	3.48	0.79
	35	3.02	0.83	2.96	0.83	2.94	0.83	2.90	0.83	3.23	0.83	3.42	0.84
	40	2.73	0.90	2.72	0.90	2.70	0.90	2.67	0.90	2.97	0.91	3.17	0.90
	43	2.60	0.95	2.55	0.96	2.53	0.96	2.50	0.96	2.79	0.96	2.98	0.97
	46	2.32	1.02	2.31	1.02	2.30	1.02	2.26	1.02	2.56	1.03	2.77	1.03
2.5	22	2.59	0.28	2.52	0.27	2.49	0.26	2.45	0.26	3.75	0.49	4.62	0.64
	25	2.62	0.30	2.55	0.29	2.53	0.29	2.49	0.28	3.70	0.53	4.52	0.69
	29	2.91	0.36	2.87	0.36	2.86	0.36	2.84	0.36	3.70	0.64	4.27	0.77
	32	3.80	1.00	3.72	1.00	3.70	1.00	3.65	1.00	3.98	1.01	4.20	1.01
	35	3.64	1.07	3.57	1.07	3.55	1.07	3.50	1.07	3.90	1.08	4.13	1.08
	40	3.29	1.16	3.28	1.16	3.26	1.16	3.22	1.16	3.58	1.17	3.83	1.17
	43	3.14	1.23	3.08	1.23	3.06	1.23	3.02	1.23	3.36	1.24	3.59	1.25
	46	2.80	1.32	2.79	1.32	2.77	1.32	2.73	1.32	3.09	1.33	3.34	1.33
3.5	22	2.96	0.34	2.88	0.33	2.84	0.32	2.80	0.31	4.29	0.59	5.28	0.78
	25	3.00	0.37	2.92	0.35	2.89	0.35	2.84	0.34	4.23	0.64	5.16	0.84
	29	3.32	0.44	3.28	0.44	3.27	0.44	3.24	0.44	4.22	0.78	4.88	0.94
	32	4.34	1.22	4.26	1.22	4.23	1.22	4.17	1.22	4.55	1.23	4.80	1.23
	35	4.16	1.30	4.08	1.30	4.05	1.30	4.00	1.30	4.46	1.31	4.72	1.31
	40	3.76	1.41	3.75	1.41	3.73	1.41	3.68	1.41	4.10	1.42	4.38	1.42
	43	3.59	1.50	3.52	1.50	3.50	1.50	3.45	1.50	3.84	1.51	4.11	1.52
	46	3.20	1.60	3.19	1.60	3.17	1.60	3.12	1.60	3.54	1.61	3.82	1.61
4.2	22	3.33	0.42	3.24	0.40	3.20	0.39	3.15	0.38	4.82	0.73	5.94	0.96
	25	3.37	0.45	3.28	0.43	3.25	0.43	3.20	0.42	4.76	0.79	5.81	1.04
	29	3.74	0.54	3.69	0.54	3.68	0.54	3.65	0.54	4.75	0.96	5.49	1.15
	32	4.88	1.50	4.79	1.50	4.76	1.50	4.69	1.50	5.12	1.51	5.40	1.52
	35	4.68	1.59	4.59	1.60	4.56	1.60	4.50	1.60	5.01	1.61	5.31	1.62
	40	4.23	1.73	4.22	1.73	4.19	1.73	4.14	1.73	4.61	1.75	4.92	1.74
	43	4.04	1.84	3.96	1.84	3.93	1.84	3.88	1.85	4.32	1.86	4.62	1.86
	46	3.24	1.42	3.29	1.41	3.30	1.40	3.33	1.39	3.63	1.37	3.83	1.36

Combination (Capacity)	Outdoor Air Temp. °C DB	Indoor Air Temp. °C WB											
		16		17.5		18		19		22		24	
		Total Q	Input Power	Total Q	Input Power	Total Q	Input Power	Total Q	Input Power	Total Q	Input Power	Total Q	Input Power
5.0	22	3.77	0.49	3.67	0.48	3.62	0.47	3.57	0.46	5.47	0.87	6.73	1.14
	25	3.82	0.53	3.72	0.51	3.69	0.51	3.62	0.49	5.40	0.94	6.58	1.23
	29	4.23	0.65	4.18	0.65	4.17	0.65	4.13	0.65	5.39	1.14	6.22	1.37
	32	5.53	1.78	5.43	1.78	5.39	1.78	5.32	1.78	5.80	1.79	6.12	1.80
	35	5.30	1.89	5.20	1.90	5.17	1.90	5.10	1.90	5.68	1.91	6.02	1.92
	40	4.79	2.05	4.78	2.06	4.75	2.06	4.69	2.06	5.22	2.07	5.58	2.07
	43	4.57	2.19	4.49	2.19	4.46	2.19	4.40	2.19	4.90	2.21	5.23	2.21
	46	3.67	1.69	3.72	1.67	3.74	1.67	3.77	1.65	4.11	1.63	4.34	1.62
1.6 + 1.6	22	4.32	0.64	4.44	0.63	4.48	0.62	4.56	0.62	4.90	0.64	5.12	0.66
	25	4.19	0.69	4.31	0.68	4.34	0.67	4.42	0.67	4.75	0.70	4.97	0.71
	29	4.16	0.82	4.24	0.80	4.24	0.78	4.28	0.78	4.42	0.78	4.60	0.79
	32	4.16	1.01	4.18	1.01	4.17	1.01	4.14	1.01	4.37	1.01	4.51	1.01
	35	4.08	1.08	4.04	1.08	4.03	1.08	4.00	1.08	4.22	1.08	4.36	1.08
	40	3.68	1.10	3.64	1.10	3.63	1.10	3.60	1.10	3.79	1.10	3.92	1.10
	43	3.52	1.17	3.49	1.17	3.48	1.17	3.45	1.17	3.64	1.21	3.77	1.24
	46	3.32	1.22	3.28	1.22	3.27	1.22	3.24	1.22	3.43	1.22	3.56	1.24
1.6 + 2.0	22	4.86	0.74	5.00	0.73	5.04	0.71	5.13	0.71	5.51	0.74	5.76	0.76
	25	4.71	0.80	4.84	0.79	4.89	0.78	4.98	0.77	5.34	0.80	5.59	0.83
	29	4.68	0.95	4.77	0.93	4.77	0.90	4.82	0.90	4.98	0.90	5.18	0.91
	32	4.68	1.16	4.71	1.16	4.69	1.16	4.66	1.16	4.91	1.16	5.08	1.16
	35	4.59	1.25	4.55	1.25	4.53	1.25	4.50	1.25	4.74	1.25	4.91	1.25
	40	4.14	1.28	4.10	1.28	4.08	1.28	4.05	1.28	4.27	1.28	4.41	1.28
	43	3.96	1.35	3.93	1.35	3.91	1.35	3.89	1.35	4.10	1.40	4.24	1.44
	46	3.15	1.13	3.20	1.11	3.20	1.10	3.20	1.10	3.36	1.08	3.47	1.06
1.6 + 2.5	22	5.62	0.87	5.77	0.86	5.82	0.84	5.93	0.84	6.36	0.88	6.66	0.90
	25	5.45	0.95	5.60	0.93	5.65	0.92	5.75	0.91	6.17	0.95	6.45	0.98
	29	5.41	1.12	5.51	1.10	5.51	1.07	5.56	1.07	5.75	1.06	5.98	1.08
	32	5.41	1.38	5.44	1.38	5.42	1.38	5.38	1.38	5.68	1.38	5.87	1.38
	35	5.30	1.48	5.25	1.48	5.23	1.48	5.20	1.48	5.48	1.48	5.67	1.48
	40	4.78	1.51	4.73	1.51	4.71	1.51	4.68	1.51	4.93	1.51	5.10	1.51
	43	4.58	1.60	4.54	1.60	4.52	1.60	4.49	1.60	4.73	1.66	4.89	1.70
	46	3.64	1.33	3.69	1.32	3.69	1.30	3.69	1.30	3.88	1.28	4.00	1.26
1.6 + 3.5	22	5.62	0.87	5.77	0.86	5.82	0.84	5.93	0.84	6.36	0.88	6.66	0.90
	25	5.45	0.95	5.60	0.93	5.65	0.92	5.75	0.91	6.17	0.95	6.45	0.98
	29	5.41	1.12	5.51	1.10	5.51	1.07	5.56	1.07	5.75	1.06	5.98	1.08
	32	5.41	1.38	5.44	1.38	5.42	1.38	5.38	1.38	5.68	1.38	5.87	1.38
	35	5.30	1.48	5.25	1.48	5.23	1.48	5.20	1.48	5.48	1.48	5.67	1.48
	40	4.78	1.51	4.73	1.51	4.71	1.51	4.68	1.51	4.93	1.51	5.10	1.51
	43	4.58	1.60	4.54	1.60	4.52	1.60	4.49	1.60	4.73	1.66	4.89	1.70
	46	3.64	1.33	3.69	1.32	3.69	1.30	3.69	1.30	3.88	1.28	4.00	1.26



Combination (Capacity)	Outdoor Air Temp. °C DB	Indoor Air Temp. °C WB											
		16		17.5		18		19		22		24	
		Total Q	Input Power	Total Q	Input Power	Total Q	Input Power	Total Q	Input Power	Total Q	Input Power	Total Q	Input Power
1.6 + 4.2	22	5.83	0.96	5.99	0.94	6.05	0.92	6.16	0.92	6.61	0.96	6.91	0.99
	25	5.66	1.04	5.81	1.02	5.87	1.00	5.97	1.00	6.41	1.04	6.70	1.07
	29	5.62	1.23	5.72	1.20	5.72	1.17	5.78	1.17	5.97	1.16	6.21	1.18
	32	5.62	1.51	5.65	1.51	5.63	1.51	5.59	1.51	5.89	1.51	6.09	1.51
	35	5.51	1.62	5.45	1.62	5.44	1.62	5.40	1.62	5.69	1.62	5.89	1.62
	40	4.97	1.65	4.91	1.65	4.90	1.65	4.86	1.65	5.12	1.65	5.29	1.65
	43	4.76	1.76	4.71	1.76	4.69	1.76	4.66	1.76	4.92	1.82	5.08	1.86
	46	3.78	1.46	3.83	1.44	3.83	1.43	3.83	1.43	4.03	1.40	4.16	1.38
1.6 + 5.0	22	5.83	0.96	5.99	0.94	6.05	0.92	6.16	0.92	6.61	0.96	6.91	0.99
	25	5.66	1.04	5.81	1.02	5.87	1.00	5.97	1.00	6.41	1.04	6.70	1.07
	29	5.62	1.23	5.72	1.20	5.72	1.17	5.78	1.17	5.97	1.16	6.21	1.18
	32	5.62	1.51	5.65	1.51	5.63	1.51	5.59	1.51	5.89	1.51	6.09	1.51
	35	5.51	1.62	5.45	1.62	5.44	1.62	5.40	1.62	5.69	1.62	5.89	1.62
	40	4.97	1.65	4.91	1.65	4.90	1.65	4.86	1.65	5.12	1.65	5.29	1.65
	43	4.76	1.76	4.71	1.76	4.69	1.76	4.66	1.76	4.92	1.82	5.08	1.86
	46	3.78	1.46	3.83	1.44	3.83	1.43	3.83	1.43	4.03	1.40	4.16	1.38
2.0 + 2.0	22	5.40	0.84	5.55	0.82	5.60	0.81	5.70	0.81	6.12	0.84	6.40	0.87
	25	5.24	0.91	5.38	0.89	5.43	0.88	5.53	0.88	5.94	0.91	6.21	0.94
	29	5.20	1.08	5.30	1.05	5.30	1.02	5.35	1.02	5.53	1.02	5.75	1.04
	32	5.20	1.32	5.23	1.32	5.21	1.32	5.18	1.32	5.46	1.32	5.64	1.32
	35	5.10	1.42	5.05	1.42	5.03	1.42	5.00	1.42	5.27	1.42	5.45	1.42
	40	4.60	1.45	4.55	1.45	4.53	1.45	4.50	1.45	4.74	1.45	4.90	1.45
	43	4.40	1.54	4.36	1.54	4.35	1.54	4.32	1.54	4.55	1.60	4.71	1.63
	46	3.50	1.28	3.55	1.26	3.55	1.25	3.55	1.25	3.73	1.22	3.85	1.21
2.0 + 2.5	22	5.62	0.87	5.77	0.86	5.82	0.84	5.93	0.84	6.36	0.88	6.66	0.90
	25	5.45	0.95	5.60	0.93	5.65	0.92	5.75	0.91	6.17	0.95	6.45	0.98
	29	5.41	1.12	5.51	1.10	5.51	1.07	5.56	1.07	5.75	1.06	5.98	1.08
	32	5.41	1.38	5.44	1.38	5.42	1.38	5.38	1.38	5.68	1.38	5.87	1.38
	35	5.30	1.48	5.25	1.48	5.23	1.48	5.20	1.48	5.48	1.48	5.67	1.48
	40	4.78	1.51	4.73	1.51	4.71	1.51	4.68	1.51	4.93	1.51	5.10	1.51
	43	4.58	1.60	4.54	1.60	4.52	1.60	4.49	1.60	4.73	1.66	4.89	1.70
	46	3.64	1.33	3.69	1.32	3.69	1.30	3.69	1.30	3.88	1.28	4.00	1.26
2.0 + 3.5	22	5.83	0.96	5.99	0.94	6.05	0.92	6.16	0.92	6.61	0.96	6.91	0.99
	25	5.66	1.04	5.81	1.02	5.87	1.00	5.97	1.00	6.41	1.04	6.70	1.07
	29	5.62	1.23	5.72	1.20	5.72	1.17	5.78	1.17	5.97	1.16	6.21	1.18
	32	5.62	1.51	5.65	1.51	5.63	1.51	5.59	1.51	5.89	1.51	6.09	1.51
	35	5.51	1.62	5.45	1.62	5.44	1.62	5.40	1.62	5.69	1.62	5.89	1.62
	40	4.97	1.65	4.91	1.65	4.90	1.65	4.86	1.65	5.12	1.65	5.29	1.65
	43	4.76	1.76	4.71	1.76	4.69	1.76	4.66	1.76	4.92	1.82	5.08	1.86
	46	3.78	1.46	3.83	1.44	3.83	1.43	3.83	1.43	4.03	1.40	4.16	1.38

Combination (Capacity)	Outdoor Air Temp. °C DB	Indoor Air Temp. °C WB											
		16		17.5		18		19		22		24	
		Total Q	Input Power	Total Q	Input Power	Total Q	Input Power	Total Q	Input Power	Total Q	Input Power	Total Q	Input Power
2.0 + 4.2	22	5.83	0.96	5.99	0.94	6.05	0.92	6.16	0.92	6.61	0.96	6.91	0.99
	25	5.66	1.04	5.81	1.02	5.87	1.00	5.97	1.00	6.41	1.04	6.70	1.07
	29	5.62	1.23	5.72	1.20	5.72	1.17	5.78	1.17	5.97	1.16	6.21	1.18
	32	5.62	1.51	5.65	1.51	5.63	1.51	5.59	1.51	5.89	1.51	6.09	1.51
	35	5.51	1.62	5.45	1.62	5.44	1.62	5.40	1.62	5.69	1.62	5.89	1.62
	40	4.97	1.65	4.91	1.65	4.90	1.65	4.86	1.65	5.12	1.65	5.29	1.65
	43	4.76	1.76	4.71	1.76	4.69	1.76	4.66	1.76	4.92	1.82	5.08	1.86
	46	3.78	1.46	3.83	1.44	3.83	1.43	3.83	1.43	4.03	1.40	4.16	1.38
2.0 + 5.0	22	5.83	0.96	5.99	0.94	6.05	0.92	6.16	0.92	6.61	0.96	6.91	0.99
	25	5.66	1.04	5.81	1.02	5.87	1.00	5.97	1.00	6.41	1.04	6.70	1.07
	29	5.62	1.23	5.72	1.20	5.72	1.17	5.78	1.17	5.97	1.16	6.21	1.18
	32	5.62	1.51	5.65	1.51	5.63	1.51	5.59	1.51	5.89	1.51	6.09	1.51
	35	5.51	1.62	5.45	1.62	5.44	1.62	5.40	1.62	5.69	1.62	5.89	1.62
	40	4.97	1.65	4.91	1.65	4.90	1.65	4.86	1.65	5.12	1.65	5.29	1.65
	43	4.76	1.76	4.71	1.76	4.69	1.76	4.66	1.76	4.92	1.82	5.08	1.86
	46	3.78	1.46	3.83	1.44	3.83	1.43	3.83	1.43	4.03	1.40	4.16	1.38
2.5 + 2.5	22	5.83	0.96	5.99	0.94	6.05	0.92	6.16	0.92	6.61	0.96	6.91	0.99
	25	5.66	1.04	5.81	1.02	5.87	1.00	5.97	1.00	6.41	1.04	6.70	1.07
	29	5.62	1.23	5.72	1.20	5.72	1.17	5.78	1.17	5.97	1.16	6.21	1.18
	32	5.62	1.51	5.65	1.51	5.63	1.51	5.59	1.51	5.89	1.51	6.09	1.51
	35	5.51	1.62	5.45	1.62	5.44	1.62	5.40	1.62	5.69	1.62	5.89	1.62
	40	4.97	1.65	4.91	1.65	4.90	1.65	4.86	1.65	5.12	1.65	5.29	1.65
	43	4.76	1.76	4.71	1.76	4.69	1.76	4.66	1.76	4.92	1.82	5.08	1.86
	46	3.78	1.46	3.83	1.44	3.83	1.43	3.83	1.43	4.03	1.40	4.16	1.38
2.5 + 3.5	22	5.83	0.96	5.99	0.94	6.05	0.92	6.16	0.92	6.61	0.96	6.91	0.99
	25	5.66	1.04	5.81	1.02	5.87	1.00	5.97	1.00	6.41	1.04	6.70	1.07
	29	5.62	1.23	5.72	1.20	5.72	1.17	5.78	1.17	5.97	1.16	6.21	1.18
	32	5.62	1.51	5.65	1.51	5.63	1.51	5.59	1.51	5.89	1.51	6.09	1.51
	35	5.51	1.62	5.45	1.62	5.44	1.62	5.40	1.62	5.69	1.62	5.89	1.62
	40	4.97	1.65	4.91	1.65	4.90	1.65	4.86	1.65	5.12	1.65	5.29	1.65
	43	4.76	1.76	4.71	1.76	4.69	1.76	4.66	1.76	4.92	1.82	5.08	1.86
	46	3.78	1.46	3.83	1.44	3.83	1.43	3.83	1.43	4.03	1.40	4.16	1.38
2.5 + 4.2	22	5.83	0.96	5.99	0.94	6.05	0.92	6.16	0.92	6.61	0.96	6.91	0.99
	25	5.66	1.04	5.81	1.02	5.87	1.00	5.97	1.00	6.41	1.04	6.70	1.07
	29	5.62	1.23	5.72	1.20	5.72	1.17	5.78	1.17	5.97	1.16	6.21	1.18
	32	5.62	1.51	5.65	1.51	5.63	1.51	5.59	1.51	5.89	1.51	6.09	1.51
	35	5.51	1.62	5.45	1.62	5.44	1.62	5.40	1.62	5.69	1.62	5.89	1.62
	40	4.97	1.65	4.91	1.65	4.90	1.65	4.86	1.65	5.12	1.65	5.29	1.65
	43	4.76	1.76	4.71	1.76	4.69	1.76	4.66	1.76	4.92	1.82	5.08	1.86
	46	3.78	1.46	3.83	1.44	3.83	1.43	3.83	1.43	4.03	1.40	4.16	1.38

Combination (Capacity)	Outdoor Air Temp. °C DB	Indoor Air Temp. °C WB											
		16		17.5		18		19		22		24	
		Total Q	Input Power	Total Q	Input Power	Total Q	Input Power	Total Q	Input Power	Total Q	Input Power	Total Q	Input Power
2.5 + 5.0	22	5.83	0.96	5.99	0.94	6.05	0.92	6.16	0.92	6.61	0.96	6.91	0.99
	25	5.66	1.04	5.81	1.02	5.87	1.00	5.97	1.00	6.41	1.04	6.70	1.07
	29	5.62	1.23	5.72	1.20	5.72	1.17	5.78	1.17	5.97	1.16	6.21	1.18
	32	5.62	1.51	5.65	1.51	5.63	1.51	5.59	1.51	5.89	1.51	6.09	1.51
	35	5.51	1.62	5.45	1.62	5.44	1.62	5.40	1.62	5.69	1.62	5.89	1.62
	40	4.97	1.65	4.91	1.65	4.90	1.65	4.86	1.65	5.12	1.65	5.29	1.65
	43	4.76	1.76	4.71	1.76	4.69	1.76	4.66	1.76	4.92	1.82	5.08	1.86
	46	3.78	1.46	3.83	1.44	3.83	1.43	3.83	1.43	4.03	1.40	4.16	1.38
3.5 + 3.5	22	5.83	0.96	5.99	0.94	6.05	0.92	6.16	0.92	6.61	0.96	6.91	0.99
	25	5.66	1.04	5.81	1.02	5.87	1.00	5.97	1.00	6.41	1.04	6.70	1.07
	29	5.62	1.23	5.72	1.20	5.72	1.17	5.78	1.17	5.97	1.16	6.21	1.18
	32	5.62	1.51	5.65	1.51	5.63	1.51	5.59	1.51	5.89	1.51	6.09	1.51
	35	5.51	1.62	5.45	1.62	5.44	1.62	5.40	1.62	5.69	1.62	5.89	1.62
	40	4.97	1.65	4.91	1.65	4.90	1.65	4.86	1.65	5.12	1.65	5.29	1.65
	43	4.76	1.76	4.71	1.76	4.69	1.76	4.66	1.76	4.92	1.82	5.08	1.86
	46	3.78	1.46	3.83	1.44	3.83	1.43	3.83	1.43	4.03	1.40	4.16	1.38
3.5 + 4.2	22	5.83	0.96	5.99	0.94	6.05	0.92	6.16	0.92	6.61	0.96	6.91	0.99
	25	5.66	1.04	5.81	1.02	5.87	1.00	5.97	1.00	6.41	1.04	6.70	1.07
	29	5.62	1.23	5.72	1.20	5.72	1.17	5.78	1.17	5.97	1.16	6.21	1.18
	32	5.62	1.51	5.65	1.51	5.63	1.51	5.59	1.51	5.89	1.51	6.09	1.51
	35	5.51	1.62	5.45	1.62	5.44	1.62	5.40	1.62	5.69	1.62	5.89	1.62
	40	4.97	1.65	4.91	1.65	4.90	1.65	4.86	1.65	5.12	1.65	5.29	1.65
	43	4.76	1.76	4.71	1.76	4.69	1.76	4.66	1.76	4.92	1.82	5.08	1.86
	46	3.78	1.46	3.83	1.44	3.83	1.43	3.83	1.43	4.03	1.40	4.16	1.38

Total Q: Total Cooling Capacity (kW)  
Input Power (kW)

## 18.2 Heat Mode Performance Data

Unit setting: Standard piping length, Hi Fan, Heat mode at 30°C

Voltage: 230V, 50Hz

### 18.2.1 CU-2TZ41TBE

Combination (Capacity)	Indoor Air Temp. °C DB	Outdoor Air Temp. °C WB													
		15		10		6		1		-5		-10		-15	
		Total Q	Input Power	Total Q	Input Power	Total Q	Input Power	Total Q	Input Power	Total Q	Input Power	Total Q	Input Power	Total Q	Input Power
1.6	16	3.99	0.84	3.95	1.05	3.99	1.15	3.08	1.48	2.55	1.46	2.17	1.41	1.79	1.34
	18	3.95	0.89	3.90	1.10	3.90	1.20	3.19	1.47	2.65	1.45	2.25	1.40	1.86	1.33
	20	3.88	0.94	3.85	1.14	3.80	1.24	3.31	1.46	2.74	1.44	2.34	1.40	1.94	1.33
	21	3.84	0.95	3.80	1.16	3.77	1.26	3.33	1.46	2.76	1.44	2.35	1.40	1.94	1.33
	22	3.78	0.97	3.76	1.18	3.74	1.29	3.34	1.46	2.77	1.44	2.35	1.40	1.94	1.33
	24	3.61	0.99	3.66	1.22	3.69	1.34	3.38	1.45	2.79	1.44	2.37	1.40	1.94	1.33
2.0	16	5.04	1.07	4.99	1.33	5.04	1.46	3.89	1.87	3.22	1.84	2.74	1.78	2.26	1.70
	18	4.99	1.13	4.93	1.39	4.92	1.52	4.03	1.86	3.34	1.84	2.85	1.78	2.35	1.69
	20	4.90	1.19	4.86	1.44	4.80	1.57	4.18	1.85	3.47	1.83	2.96	1.77	2.45	1.68
	21	4.85	1.21	4.80	1.47	4.76	1.60	4.20	1.85	3.48	1.83	2.97	1.77	2.45	1.68
	22	4.78	1.22	4.74	1.50	4.73	1.63	4.22	1.84	3.50	1.83	2.97	1.77	2.45	1.68
	24	4.56	1.26	4.62	1.55	4.66	1.70	4.27	1.84	3.53	1.82	2.99	1.77	2.45	1.68
2.5	16	5.78	1.28	5.72	1.59	5.78	1.75	4.46	2.24	3.69	2.21	3.14	2.14	2.59	2.03
	18	5.72	1.35	5.65	1.66	5.64	1.81	4.62	2.23	3.83	2.20	3.26	2.13	2.70	2.02
	20	5.61	1.43	5.57	1.73	5.50	1.88	4.79	2.22	3.97	2.19	3.39	2.12	2.81	2.01
	21	5.56	1.45	5.50	1.76	5.46	1.92	4.81	2.21	3.99	2.19	3.40	2.12	2.81	2.01
	22	5.47	1.47	5.44	1.79	5.42	1.96	4.84	2.21	4.01	2.19	3.41	2.12	2.81	2.01
	24	5.23	1.50	5.30	1.85	5.34	2.03	4.90	2.20	4.04	2.18	3.42	2.12	2.81	2.01
3.5	16	6.51	1.36	6.45	1.69	6.51	1.86	5.02	2.38	4.15	2.35	3.53	2.27	2.91	2.16
	18	6.45	1.44	6.37	1.77	6.36	1.93	5.21	2.37	4.32	2.34	3.68	2.26	3.04	2.15
	20	6.32	1.52	6.28	1.84	6.20	2.00	5.39	2.36	4.48	2.33	3.82	2.25	3.16	2.14
	21	6.26	1.54	6.21	1.87	6.15	2.04	5.43	2.36	4.50	2.33	3.83	2.25	3.16	2.14
	22	6.17	1.56	6.13	1.91	6.11	2.08	5.46	2.35	4.52	2.33	3.84	2.25	3.16	2.14
	24	5.89	1.60	5.97	1.97	6.01	2.16	5.52	2.34	4.55	2.32	3.86	2.25	3.16	2.14
1.6 + 1.6	16	6.62	1.21	6.62	1.52	6.62	1.67	4.28	1.62	3.84	1.63	3.24	1.55	2.46	1.40
	18	6.49	1.26	6.47	1.58	6.46	1.74	4.19	1.66	3.77	1.68	3.19	1.59	2.43	1.44
	20	6.30	1.31	6.32	1.64	6.30	1.80	4.10	1.69	3.70	1.72	3.14	1.63	2.39	1.48
	21	6.36	1.33	6.34	1.66	6.33	1.82	4.21	1.73	3.80	1.75	3.22	1.66	2.46	1.50
	22	6.36	1.35	6.36	1.68	6.36	1.85	4.32	1.76	3.90	1.79	3.31	1.69	2.52	1.53
	24	6.43	1.39	6.41	1.72	6.43	1.89	4.54	1.84	4.10	1.85	3.47	1.75	2.65	1.58
1.6 + 2.0	16	6.62	1.19	6.62	1.50	6.62	1.66	4.28	1.60	3.84	1.62	3.24	1.53	2.46	1.39
	18	6.49	1.25	6.47	1.56	6.46	1.72	4.19	1.64	3.77	1.66	3.19	1.57	2.43	1.42
	20	6.30	1.30	6.32	1.62	6.30	1.78	4.10	1.67	3.70	1.70	3.14	1.62	2.39	1.46
	21	6.36	1.32	6.34	1.64	6.33	1.80	4.21	1.71	3.80	1.73	3.22	1.64	2.46	1.49
	22	6.36	1.34	6.36	1.66	6.36	1.82	4.32	1.74	3.90	1.77	3.31	1.67	2.52	1.51
	24	6.43	1.37	6.41	1.70	6.43	1.87	4.54	1.82	4.10	1.83	3.47	1.73	2.65	1.57

Combination (Capacity)	Indoor Air Temp. °C DB	Outdoor Air Temp. °C WB													
		15		10		6		1		-5		-10		-15	
		Total Q	Input Power	Total Q	Input Power	Total Q	Input Power	Total Q	Input Power	Total Q	Input Power	Total Q	Input Power	Total Q	Input Power
1.6 + 2.5	16	6.62	1.19	6.62	1.50	6.62	1.66	4.28	1.60	3.84	1.62	3.24	1.53	2.46	1.39
	18	6.49	1.25	6.47	1.56	6.46	1.72	4.19	1.64	3.77	1.66	3.19	1.57	2.43	1.42
	20	6.30	1.30	6.32	1.62	6.30	1.78	4.10	1.67	3.70	1.70	3.14	1.62	2.39	1.46
	21	6.36	1.32	6.34	1.64	6.33	1.80	4.21	1.71	3.80	1.73	3.22	1.64	2.46	1.49
	22	6.36	1.34	6.36	1.66	6.36	1.82	4.32	1.74	3.90	1.77	3.31	1.67	2.52	1.51
	24	6.43	1.37	6.41	1.70	6.43	1.87	4.54	1.82	4.10	1.83	3.47	1.73	2.65	1.57
1.6 + 3.5	16	6.62	1.19	6.62	1.50	6.62	1.66	4.28	1.60	3.84	1.62	3.24	1.53	2.46	1.39
	18	6.49	1.25	6.47	1.56	6.46	1.72	4.19	1.64	3.77	1.66	3.19	1.57	2.43	1.42
	20	6.30	1.30	6.32	1.62	6.30	1.78	4.10	1.67	3.70	1.70	3.14	1.62	2.39	1.46
	21	6.36	1.32	6.34	1.64	6.33	1.80	4.21	1.71	3.80	1.73	3.22	1.64	2.46	1.49
	22	6.36	1.34	6.36	1.66	6.36	1.82	4.32	1.74	3.90	1.77	3.31	1.67	2.52	1.51
	24	6.43	1.37	6.41	1.70	6.43	1.87	4.54	1.82	4.10	1.83	3.47	1.73	2.65	1.57
2.0 + 2.0	16	6.62	1.18	6.62	1.48	6.62	1.64	4.28	1.58	3.84	1.60	3.24	1.52	2.46	1.37
	18	6.49	1.23	6.47	1.54	6.46	1.70	4.19	1.62	3.77	1.64	3.19	1.56	2.43	1.41
	20	6.30	1.28	6.32	1.60	6.30	1.76	4.10	1.65	3.70	1.68	3.14	1.60	2.39	1.44
	21	6.36	1.30	6.34	1.62	6.33	1.78	4.21	1.69	3.80	1.71	3.22	1.63	2.46	1.47
	22	6.36	1.32	6.36	1.64	6.36	1.80	4.32	1.72	3.90	1.75	3.31	1.66	2.52	1.50
	24	6.43	1.36	6.41	1.68	6.43	1.85	4.54	1.80	4.10	1.81	3.47	1.71	2.65	1.55
2.0 + 2.5	16	6.62	1.18	6.62	1.48	6.62	1.64	4.28	1.58	3.84	1.60	3.24	1.52	2.46	1.37
	18	6.49	1.23	6.47	1.54	6.46	1.70	4.19	1.62	3.77	1.64	3.19	1.56	2.43	1.41
	20	6.30	1.28	6.32	1.60	6.30	1.76	4.10	1.65	3.70	1.68	3.14	1.60	2.39	1.44
	21	6.36	1.30	6.34	1.62	6.33	1.78	4.21	1.69	3.80	1.71	3.22	1.63	2.46	1.47
	22	6.36	1.32	6.36	1.64	6.36	1.80	4.32	1.72	3.90	1.75	3.31	1.66	2.52	1.50
	24	6.43	1.36	6.41	1.68	6.43	1.85	4.54	1.80	4.10	1.81	3.47	1.71	2.65	1.55
2.0 + 3.5	16	6.62	1.18	6.62	1.48	6.62	1.64	4.28	1.58	3.84	1.60	3.24	1.52	2.46	1.37
	18	6.49	1.23	6.47	1.54	6.46	1.70	4.19	1.62	3.77	1.64	3.19	1.56	2.43	1.41
	20	6.30	1.28	6.32	1.60	6.30	1.76	4.10	1.65	3.70	1.68	3.14	1.60	2.39	1.44
	21	6.36	1.30	6.34	1.62	6.33	1.78	4.21	1.69	3.80	1.71	3.22	1.63	2.46	1.47
	22	6.36	1.32	6.36	1.64	6.36	1.80	4.32	1.72	3.90	1.75	3.31	1.66	2.52	1.50
	24	6.43	1.36	6.41	1.68	6.43	1.85	4.54	1.80	4.10	1.81	3.47	1.71	2.65	1.55
2.5 + 2.5	16	6.62	1.18	6.62	1.48	6.62	1.64	4.28	1.58	3.84	1.60	3.24	1.52	2.46	1.37
	18	6.49	1.23	6.47	1.54	6.46	1.70	4.19	1.62	3.77	1.64	3.19	1.56	2.43	1.41
	20	6.30	1.28	6.32	1.60	6.30	1.76	4.10	1.65	3.70	1.68	3.14	1.60	2.39	1.44
	21	6.36	1.30	6.34	1.62	6.33	1.78	4.21	1.69	3.80	1.71	3.22	1.63	2.46	1.47
	22	6.36	1.32	6.36	1.64	6.36	1.80	4.32	1.72	3.90	1.75	3.31	1.66	2.52	1.50
	24	6.43	1.36	6.41	1.68	6.43	1.85	4.54	1.80	4.10	1.81	3.47	1.71	2.65	1.55

Combination (Capacity)	Indoor Air Temp. °C DB	Outdoor Air Temp. °C WB													
		15		10		6		1		-5		-10		-15	
		Total Q	Input Power	Total Q	Input Power	Total Q	Input Power	Total Q	Input Power	Total Q	Input Power	Total Q	Input Power	Total Q	Input Power
2.5 + 3.5	16	6.62	1.18	6.62	1.48	6.62	1.64	4.28	1.58	3.84	1.60	3.24	1.52	2.46	1.37
	18	6.49	1.23	6.47	1.54	6.46	1.70	4.19	1.62	3.77	1.64	3.19	1.56	2.43	1.41
	20	6.30	1.28	6.32	1.60	6.30	1.76	4.10	1.65	3.70	1.68	3.14	1.60	2.39	1.44
	21	6.36	1.30	6.34	1.62	6.33	1.78	4.21	1.69	3.80	1.71	3.22	1.63	2.46	1.47
	22	6.36	1.32	6.36	1.64	6.36	1.80	4.32	1.72	3.90	1.75	3.31	1.66	2.52	1.50
	24	6.43	1.36	6.41	1.68	6.43	1.85	4.54	1.80	4.10	1.81	3.47	1.71	2.65	1.55

Total Q: Total Heating Capacity (kW)

Input Power (kW)

## 18.2.2 CU-2TZ50TBE

Combination (Capacity)	Indoor Air Temp. °C DB	Outdoor Air Temp. °C WB													
		15		10		6		1		-5		-10		-15	
		Total Q	Input Power	Total Q	Input Power	Total Q	Input Power	Total Q	Input Power	Total Q	Input Power	Total Q	Input Power	Total Q	Input Power
1.6	16	3.99	0.84	3.95	1.05	3.99	1.15	3.08	1.48	2.55	1.46	2.17	1.41	1.79	1.34
	18	3.95	0.89	3.90	1.10	3.90	1.20	3.19	1.47	2.65	1.45	2.25	1.40	1.86	1.33
	20	3.88	0.94	3.85	1.14	3.80	1.24	3.31	1.46	2.74	1.44	2.34	1.40	1.94	1.33
	21	3.84	0.95	3.80	1.16	3.77	1.26	3.33	1.46	2.76	1.44	2.35	1.40	1.94	1.33
	22	3.78	0.97	3.76	1.18	3.74	1.29	3.34	1.46	2.77	1.44	2.35	1.40	1.94	1.33
	24	3.61	0.99	3.66	1.22	3.69	1.34	3.38	1.45	2.79	1.44	2.37	1.40	1.94	1.33
2.0	16	5.04	1.07	4.99	1.33	5.04	1.46	3.89	1.87	3.22	1.84	2.74	1.78	2.26	1.70
	18	4.99	1.13	4.93	1.39	4.92	1.52	4.03	1.86	3.34	1.84	2.85	1.78	2.35	1.69
	20	4.90	1.19	4.86	1.44	4.80	1.57	4.18	1.85	3.47	1.83	2.96	1.77	2.45	1.68
	21	4.85	1.21	4.80	1.47	4.76	1.60	4.20	1.85	3.48	1.83	2.97	1.77	2.45	1.68
	22	4.78	1.22	4.74	1.50	4.73	1.63	4.22	1.84	3.50	1.83	2.97	1.77	2.45	1.68
	24	4.56	1.26	4.62	1.55	4.66	1.70	4.27	1.84	3.53	1.82	2.99	1.77	2.45	1.68
2.5	16	5.78	1.28	5.72	1.59	5.78	1.75	4.46	2.24	3.69	2.21	3.14	2.14	2.59	2.03
	18	5.72	1.35	5.65	1.66	5.64	1.81	4.62	2.23	3.83	2.20	3.26	2.13	2.70	2.02
	20	5.61	1.43	5.57	1.73	5.50	1.88	4.79	2.22	3.97	2.19	3.39	2.12	2.81	2.01
	21	5.56	1.45	5.50	1.76	5.46	1.92	4.81	2.21	3.99	2.19	3.40	2.12	2.81	2.01
	22	5.47	1.47	5.44	1.79	5.42	1.96	4.84	2.21	4.01	2.19	3.41	2.12	2.81	2.01
	24	5.23	1.50	5.30	1.85	5.34	2.03	4.90	2.20	4.04	2.18	3.42	2.12	2.81	2.01
3.5	16	6.51	1.36	6.45	1.69	6.51	1.86	5.02	2.38	4.15	2.35	3.53	2.27	2.91	2.16
	18	6.45	1.44	6.37	1.77	6.36	1.93	5.21	2.37	4.32	2.34	3.68	2.26	3.04	2.15
	20	6.32	1.52	6.28	1.84	6.20	2.00	5.39	2.36	4.48	2.33	3.82	2.25	3.16	2.14
	21	6.26	1.54	6.21	1.87	6.15	2.04	5.43	2.36	4.50	2.33	3.83	2.25	3.16	2.14
	22	6.17	1.56	6.13	1.91	6.11	2.08	5.46	2.35	4.52	2.33	3.84	2.25	3.16	2.14
	24	5.89	1.60	5.97	1.97	6.01	2.16	5.52	2.34	4.55	2.32	3.86	2.25	3.16	2.14
4.2	16	6.62	1.60	6.55	1.99	6.62	2.19	5.10	2.80	4.22	2.76	3.59	2.67	2.96	2.54
	18	6.55	1.69	6.47	2.08	6.46	2.27	5.29	2.78	4.39	2.75	3.74	2.66	3.09	2.53
	20	6.43	1.79	6.38	2.16	6.30	2.35	5.48	2.77	4.55	2.74	3.88	2.65	3.21	2.51
	21	6.36	1.81	6.31	2.20	6.25	2.40	5.51	2.77	4.57	2.74	3.89	2.65	3.21	2.51
	22	6.27	1.83	6.23	2.24	6.21	2.44	5.54	2.76	4.59	2.73	3.90	2.65	3.21	2.51
	24	5.99	1.88	6.07	2.32	6.11	2.54	5.61	2.75	4.63	2.73	3.92	2.65	3.21	2.51
5.0	16	6.62	1.58	6.55	1.97	6.62	2.17	5.10	2.77	4.22	2.74	3.59	2.65	2.96	2.52
	18	6.55	1.68	6.47	2.06	6.46	2.25	5.29	2.76	4.39	2.72	3.74	2.64	3.09	2.50
	20	6.43	1.77	6.38	2.14	6.30	2.33	5.48	2.75	4.55	2.71	3.88	2.62	3.21	2.49
	21	6.36	1.79	6.31	2.18	6.25	2.38	5.51	2.74	4.57	2.71	3.89	2.62	3.21	2.49
	22	6.27	1.82	6.23	2.22	6.21	2.42	5.54	2.74	4.59	2.71	3.90	2.62	3.21	2.49
	24	5.99	1.86	6.07	2.30	6.11	2.52	5.61	2.73	4.63	2.71	3.92	2.62	3.21	2.49

Combination (Capacity)	Indoor Air Temp. °C DB	Outdoor Air Temp. °C WB													
		15		10		6		1		-5		-10		-15	
		Total Q	Input Power	Total Q	Input Power	Total Q	Input Power	Total Q	Input Power	Total Q	Input Power	Total Q	Input Power	Total Q	Input Power
1.6 + 1.6	16	6.62	1.21	6.62	1.52	6.62	1.67	4.28	1.62	3.84	1.63	3.24	1.55	2.46	1.40
	18	6.49	1.26	6.47	1.58	6.46	1.74	4.19	1.66	3.77	1.68	3.19	1.59	2.43	1.44
	20	6.30	1.31	6.32	1.64	6.30	1.80	4.10	1.69	3.70	1.72	3.14	1.63	2.39	1.48
	21	6.36	1.33	6.34	1.66	6.33	1.82	4.21	1.73	3.80	1.75	3.22	1.66	2.46	1.50
	22	6.36	1.35	6.36	1.68	6.36	1.85	4.32	1.76	3.90	1.79	3.31	1.69	2.52	1.53
	24	6.43	1.39	6.41	1.72	6.43	1.89	4.54	1.84	4.10	1.85	3.47	1.75	2.65	1.58
1.6 + 2.0	16	6.62	1.19	6.62	1.50	6.62	1.66	4.28	1.60	3.84	1.62	3.24	1.53	2.46	1.39
	18	6.49	1.25	6.47	1.56	6.46	1.72	4.19	1.64	3.77	1.66	3.19	1.57	2.43	1.42
	20	6.30	1.30	6.32	1.62	6.30	1.78	4.10	1.67	3.70	1.70	3.14	1.62	2.39	1.46
	21	6.36	1.32	6.34	1.64	6.33	1.80	4.21	1.71	3.80	1.73	3.22	1.64	2.46	1.49
	22	6.36	1.34	6.36	1.66	6.36	1.82	4.32	1.74	3.90	1.77	3.31	1.67	2.52	1.51
	24	6.43	1.37	6.41	1.70	6.43	1.87	4.54	1.82	4.10	1.83	3.47	1.73	2.65	1.57
1.6 + 2.5	16	6.62	1.19	6.62	1.50	6.62	1.66	4.28	1.60	3.84	1.62	3.24	1.53	2.46	1.39
	18	6.49	1.25	6.47	1.56	6.46	1.72	4.19	1.64	3.77	1.66	3.19	1.57	2.43	1.42
	20	6.30	1.30	6.32	1.62	6.30	1.78	4.10	1.67	3.70	1.70	3.14	1.62	2.39	1.46
	21	6.36	1.32	6.34	1.64	6.33	1.80	4.21	1.71	3.80	1.73	3.22	1.64	2.46	1.49
	22	6.36	1.34	6.36	1.66	6.36	1.82	4.32	1.74	3.90	1.77	3.31	1.67	2.52	1.51
	24	6.43	1.37	6.41	1.70	6.43	1.87	4.54	1.82	4.10	1.83	3.47	1.73	2.65	1.57
1.6 + 3.5	16	6.62	1.19	6.62	1.50	6.62	1.66	4.28	1.60	3.84	1.62	3.24	1.53	2.46	1.39
	18	6.49	1.25	6.47	1.56	6.46	1.72	4.19	1.64	3.77	1.66	3.19	1.57	2.43	1.42
	20	6.30	1.30	6.32	1.62	6.30	1.78	4.10	1.67	3.70	1.70	3.14	1.62	2.39	1.46
	21	6.36	1.32	6.34	1.64	6.33	1.80	4.21	1.71	3.80	1.73	3.22	1.64	2.46	1.49
	22	6.36	1.34	6.36	1.66	6.36	1.82	4.32	1.74	3.90	1.77	3.31	1.67	2.52	1.51
	24	6.43	1.37	6.41	1.70	6.43	1.87	4.54	1.82	4.10	1.83	3.47	1.73	2.65	1.57
1.6 + 4.2	16	6.72	1.19	6.72	1.49	6.72	1.65	4.35	1.59	3.90	1.61	3.30	1.52	2.50	1.38
	18	6.59	1.24	6.57	1.55	6.56	1.71	4.26	1.63	3.83	1.65	3.24	1.57	2.46	1.42
	20	6.40	1.29	6.42	1.61	6.40	1.77	4.16	1.66	3.76	1.69	3.19	1.61	2.43	1.45
	21	6.46	1.31	6.44	1.63	6.43	1.79	4.27	1.70	3.86	1.72	3.28	1.64	2.50	1.48
	22	6.46	1.33	6.46	1.65	6.46	1.81	4.38	1.73	3.96	1.76	3.36	1.66	2.56	1.50
	24	6.53	1.36	6.51	1.69	6.53	1.86	4.61	1.81	4.16	1.82	3.53	1.72	2.69	1.56
1.6 + 5.0	16	6.72	1.19	6.72	1.49	6.72	1.65	4.35	1.59	3.90	1.61	3.30	1.52	2.50	1.38
	18	6.59	1.24	6.57	1.55	6.56	1.71	4.26	1.63	3.83	1.65	3.24	1.57	2.46	1.42
	20	6.40	1.29	6.42	1.61	6.40	1.77	4.16	1.66	3.76	1.69	3.19	1.61	2.43	1.45
	21	6.46	1.31	6.44	1.63	6.43	1.79	4.27	1.70	3.86	1.72	3.28	1.64	2.50	1.48
	22	6.46	1.33	6.46	1.65	6.46	1.81	4.38	1.73	3.96	1.76	3.36	1.66	2.56	1.50
	24	6.53	1.36	6.51	1.69	6.53	1.86	4.61	1.81	4.16	1.82	3.53	1.72	2.69	1.56
2.0 + 2.0	16	6.62	1.18	6.62	1.48	6.62	1.64	4.28	1.58	3.84	1.60	3.24	1.52	2.46	1.37
	18	6.49	1.23	6.47	1.54	6.46	1.70	4.19	1.62	3.77	1.64	3.19	1.56	2.43	1.41
	20	6.30	1.28	6.32	1.60	6.30	1.76	4.10	1.65	3.70	1.68	3.14	1.60	2.39	1.44
	21	6.36	1.30	6.34	1.62	6.33	1.78	4.21	1.69	3.80	1.71	3.22	1.63	2.46	1.47
	22	6.36	1.32	6.36	1.64	6.36	1.80	4.32	1.72	3.90	1.75	3.31	1.66	2.52	1.50
	24	6.43	1.36	6.41	1.68	6.43	1.85	4.54	1.80	4.10	1.81	3.47	1.71	2.65	1.55



Combination (Capacity)	Indoor Air Temp. °C DB	Outdoor Air Temp. °C WB													
		15		10		6		1		-5		-10		-15	
		Total Q	Input Power	Total Q	Input Power	Total Q	Input Power	Total Q	Input Power	Total Q	Input Power	Total Q	Input Power	Total Q	Input Power
2.0 + 2.5	16	6.62	1.18	6.62	1.48	6.62	1.64	4.28	1.58	3.84	1.60	3.24	1.52	2.46	1.37
	18	6.49	1.23	6.47	1.54	6.46	1.70	4.19	1.62	3.77	1.64	3.19	1.56	2.43	1.41
	20	6.30	1.28	6.32	1.60	6.30	1.76	4.10	1.65	3.70	1.68	3.14	1.60	2.39	1.44
	21	6.36	1.30	6.34	1.62	6.33	1.78	4.21	1.69	3.80	1.71	3.22	1.63	2.46	1.47
	22	6.36	1.32	6.36	1.64	6.36	1.80	4.32	1.72	3.90	1.75	3.31	1.66	2.52	1.50
	24	6.43	1.36	6.41	1.68	6.43	1.85	4.54	1.80	4.10	1.81	3.47	1.71	2.65	1.55
2.0 + 3.5	16	6.72	0.88	6.72	1.10	6.72	1.22	4.35	1.18	3.90	1.19	3.30	1.13	2.50	1.02
	18	6.59	0.92	6.57	1.15	6.56	1.26	4.26	1.21	3.83	1.22	3.24	1.16	2.46	1.05
	20	6.40	0.96	6.42	1.19	6.40	1.31	4.16	1.23	3.76	1.25	3.19	1.19	2.43	1.07
	21	6.46	0.97	6.44	1.21	6.43	1.33	4.27	1.26	3.86	1.28	3.28	1.21	2.50	1.09
	22	6.46	0.98	6.46	1.22	6.46	1.34	4.38	1.28	3.96	1.30	3.36	1.23	2.56	1.11
	24	6.53	1.01	6.51	1.25	6.53	1.38	4.61	1.34	4.16	1.35	3.53	1.28	2.69	1.15
2.0 + 4.2	16	6.72	1.19	6.72	1.49	6.72	1.65	4.35	1.59	3.90	1.61	3.30	1.52	2.50	1.38
	18	6.59	1.24	6.57	1.55	6.56	1.71	4.26	1.63	3.83	1.65	3.24	1.57	2.46	1.42
	20	6.40	1.29	6.42	1.61	6.40	1.77	4.16	1.66	3.76	1.69	3.19	1.61	2.43	1.45
	21	6.46	1.31	6.44	1.63	6.43	1.79	4.27	1.70	3.86	1.72	3.28	1.64	2.50	1.48
	22	6.46	1.33	6.46	1.65	6.46	1.81	4.38	1.73	3.96	1.76	3.36	1.66	2.56	1.50
	24	6.53	1.36	6.51	1.69	6.53	1.86	4.61	1.81	4.16	1.82	3.53	1.72	2.69	1.56
2.0 + 5.0	16	6.72	1.19	6.72	1.49	6.72	1.65	4.35	1.59	3.90	1.61	3.30	1.52	2.50	1.38
	18	6.59	1.24	6.57	1.55	6.56	1.71	4.26	1.63	3.83	1.65	3.24	1.57	2.46	1.42
	20	6.40	1.29	6.42	1.61	6.40	1.77	4.16	1.66	3.76	1.69	3.19	1.61	2.43	1.45
	21	6.46	1.31	6.44	1.63	6.43	1.79	4.27	1.70	3.86	1.72	3.28	1.64	2.50	1.48
	22	6.46	1.33	6.46	1.65	6.46	1.81	4.38	1.73	3.96	1.76	3.36	1.66	2.56	1.50
	24	6.53	1.36	6.51	1.69	6.53	1.86	4.61	1.81	4.16	1.82	3.53	1.72	2.69	1.56
2.5 + 2.5	16	6.72	1.19	6.72	1.49	6.72	1.65	4.35	1.59	3.90	1.61	3.30	1.52	2.50	1.38
	18	6.59	1.24	6.57	1.55	6.56	1.71	4.26	1.63	3.83	1.65	3.24	1.57	2.46	1.42
	20	6.40	1.29	6.42	1.61	6.40	1.77	4.16	1.66	3.76	1.69	3.19	1.61	2.43	1.45
	21	6.46	1.31	6.44	1.63	6.43	1.79	4.27	1.70	3.86	1.72	3.28	1.64	2.50	1.48
	22	6.46	1.33	6.46	1.65	6.46	1.81	4.38	1.73	3.96	1.76	3.36	1.66	2.56	1.50
	24	6.53	1.36	6.51	1.69	6.53	1.86	4.61	1.81	4.16	1.82	3.53	1.72	2.69	1.56
2.5 + 3.5	16	6.72	1.19	6.72	1.49	6.72	1.65	4.35	1.59	3.90	1.61	3.30	1.52	2.50	1.38
	18	6.59	1.24	6.57	1.55	6.56	1.71	4.26	1.63	3.83	1.65	3.24	1.57	2.46	1.42
	20	6.40	1.29	6.42	1.61	6.40	1.77	4.16	1.66	3.76	1.69	3.19	1.61	2.43	1.45
	21	6.46	1.31	6.44	1.63	6.43	1.79	4.27	1.70	3.86	1.72	3.28	1.64	2.50	1.48
	22	6.46	1.33	6.46	1.65	6.46	1.81	4.38	1.73	3.96	1.76	3.36	1.66	2.56	1.50
	24	6.53	1.36	6.51	1.69	6.53	1.86	4.61	1.81	4.16	1.82	3.53	1.72	2.69	1.56
2.5 + 4.2	16	6.72	1.19	6.72	1.49	6.72	1.65	4.35	1.59	3.90	1.61	3.30	1.52	2.50	1.38
	18	6.59	1.24	6.57	1.55	6.56	1.71	4.26	1.63	3.83	1.65	3.24	1.57	2.46	1.42
	20	6.40	1.29	6.42	1.61	6.40	1.77	4.16	1.66	3.76	1.69	3.19	1.61	2.43	1.45
	21	6.46	1.31	6.44	1.63	6.43	1.79	4.27	1.70	3.86	1.72	3.28	1.64	2.50	1.48
	22	6.46	1.33	6.46	1.65	6.46	1.81	4.38	1.73	3.96	1.76	3.36	1.66	2.56	1.50
	24	6.53	1.36	6.51	1.69	6.53	1.86	4.61	1.81	4.16	1.82	3.53	1.72	2.69	1.56

Combination (Capacity)	Indoor Air Temp. °C DB	Outdoor Air Temp. °C WB													
		15		10		6		1		-5		-10		-15	
		Total Q	Input Power	Total Q	Input Power	Total Q	Input Power	Total Q	Input Power	Total Q	Input Power	Total Q	Input Power	Total Q	Input Power
2.5 + 5.0	16	6.72	1.19	6.72	1.49	6.72	1.65	4.35	1.59	3.90	1.61	3.30	1.52	2.50	1.38
	18	6.59	1.24	6.57	1.55	6.56	1.71	4.26	1.63	3.83	1.65	3.24	1.57	2.46	1.42
	20	6.40	1.29	6.42	1.61	6.40	1.77	4.16	1.66	3.76	1.69	3.19	1.61	2.43	1.45
	21	6.46	1.31	6.44	1.63	6.43	1.79	4.27	1.70	3.86	1.72	3.28	1.64	2.50	1.48
	22	6.46	1.33	6.46	1.65	6.46	1.81	4.38	1.73	3.96	1.76	3.36	1.66	2.56	1.50
	24	6.53	1.36	6.51	1.69	6.53	1.86	4.61	1.81	4.16	1.82	3.53	1.72	2.69	1.56
3.5 + 3.5	16	6.72	1.19	6.72	1.49	6.72	1.65	4.35	1.59	3.90	1.61	3.30	1.52	2.50	1.38
	18	6.59	1.24	6.57	1.55	6.56	1.71	4.26	1.63	3.83	1.65	3.24	1.57	2.46	1.42
	20	6.40	1.29	6.42	1.61	6.40	1.77	4.16	1.66	3.76	1.69	3.19	1.61	2.43	1.45
	21	6.46	1.31	6.44	1.63	6.43	1.79	4.27	1.70	3.86	1.72	3.28	1.64	2.50	1.48
	22	6.46	1.33	6.46	1.65	6.46	1.81	4.38	1.73	3.96	1.76	3.36	1.66	2.56	1.50
	24	6.53	1.36	6.51	1.69	6.53	1.86	4.61	1.81	4.16	1.82	3.53	1.72	2.69	1.56
3.5 + 4.2	16	6.72	1.19	6.72	1.49	6.72	1.65	4.35	1.59	3.90	1.61	3.30	1.52	2.50	1.38
	18	6.59	1.24	6.57	1.55	6.56	1.71	4.26	1.63	3.83	1.65	3.24	1.57	2.46	1.42
	20	6.40	1.29	6.42	1.61	6.40	1.77	4.16	1.66	3.76	1.69	3.19	1.61	2.43	1.45
	21	6.46	1.31	6.44	1.63	6.43	1.79	4.27	1.70	3.86	1.72	3.28	1.64	2.50	1.48
	22	6.46	1.33	6.46	1.65	6.46	1.81	4.38	1.73	3.96	1.76	3.36	1.66	2.56	1.50
	24	6.53	1.36	6.51	1.69	6.53	1.86	4.61	1.81	4.16	1.82	3.53	1.72	2.69	1.56

Total Q: Total Heating Capacity (kW)

Input Power (kW)

# 19. Service Data

Service Data provided are based on the air conditioner running under rated frequency during forced cooling / forced heating mode.

## 19.1 Operation Characteristics (CU-2TZ41TBE)

### 19.1.1 One Indoor Unit Operation

- Cooling Characteristic  
[Condition] Room temperature: 27°C (DBT), 19°C (WBT)  
Operation condition: High fan speed  
Piping length: 5.0 m  
Voltage: 230V, 50Hz

A) Indoor unit capacity: Cooling (1.6), CS-MTZ16TKE

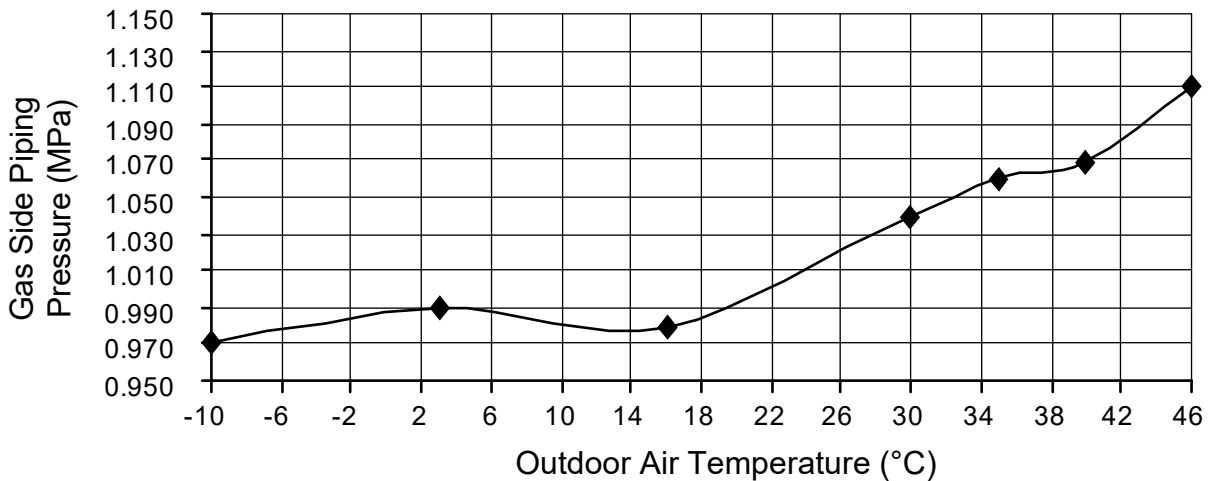
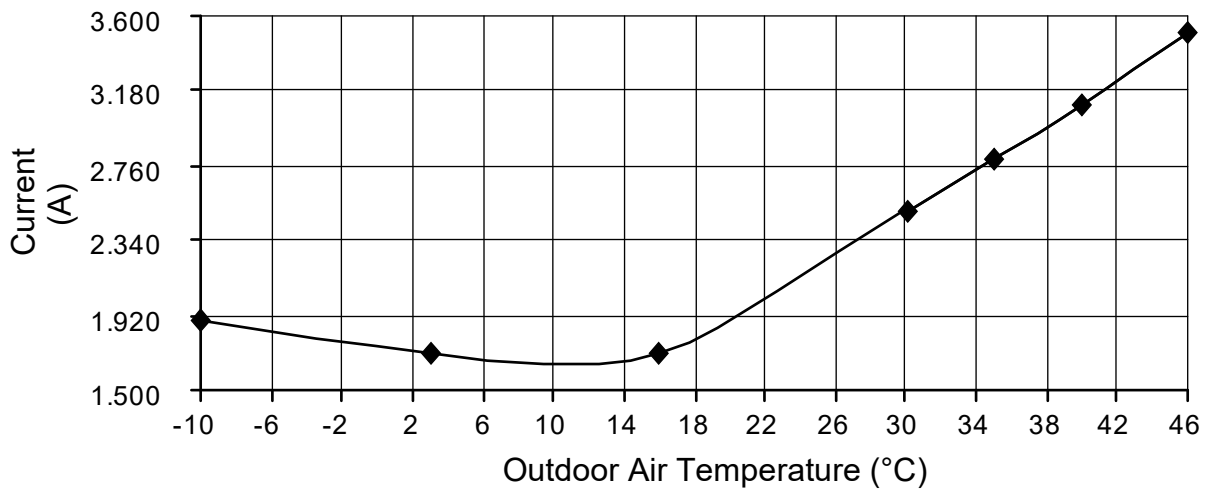
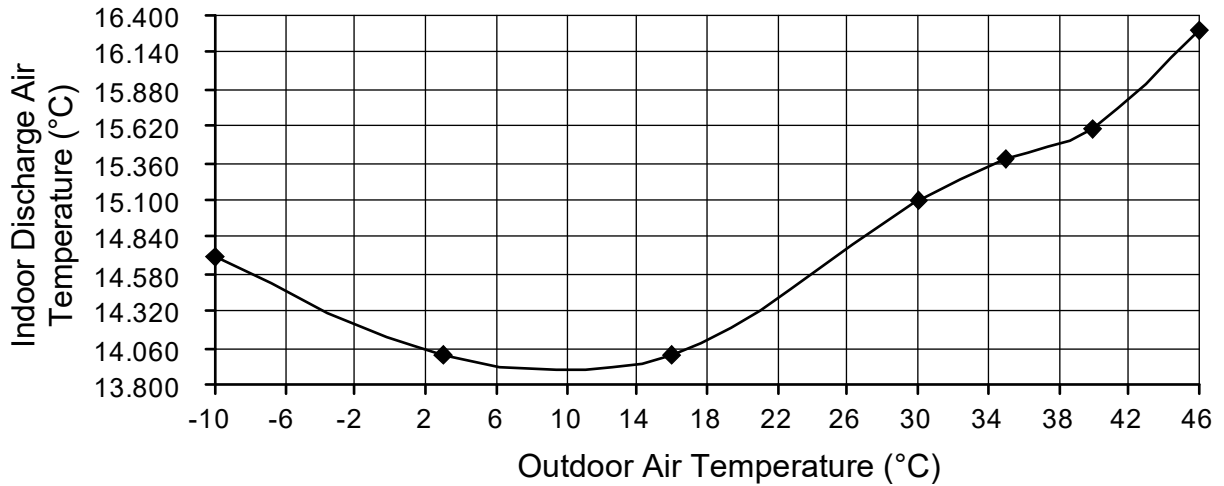

- Cooling Characteristic

[Condition] Room temperature: 27°C (DBT), 19°C (WBT)

Operation condition: High fan speed

Piping length: 5.0 m

Voltage: 230V, 50Hz

B) Indoor unit capacity: Cooling (2.0), CS-TZ20TKEW

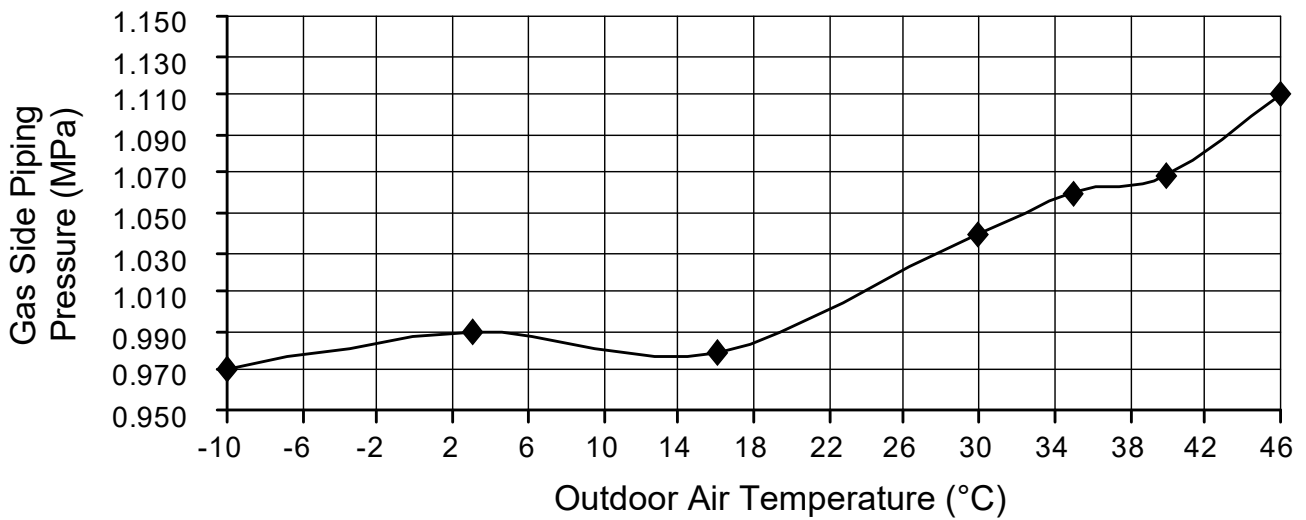
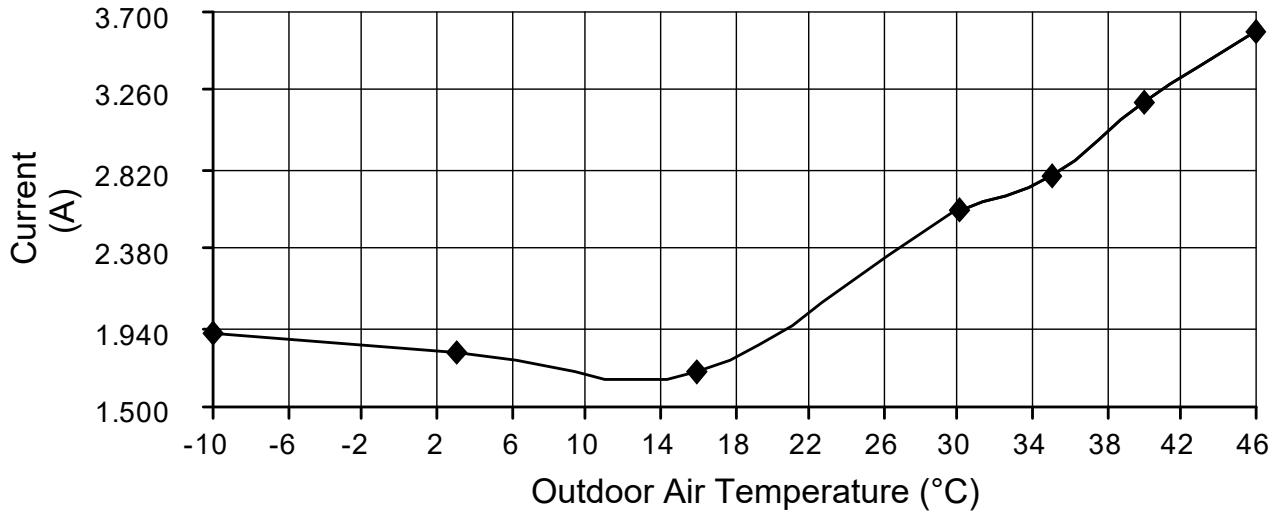
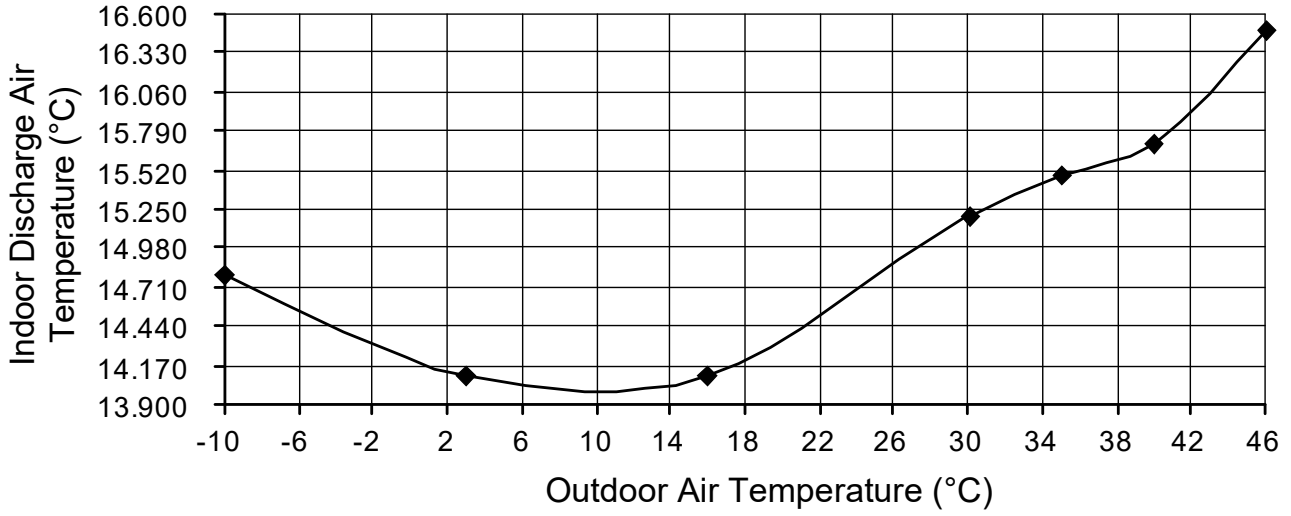

- Cooling Characteristic
- [Condition] Room temperature: 27°C (DBT), 19°C (WBT)
- Operation condition: High fan speed
- Piping length: 5.0 m
- Voltage: 230V, 50Hz

C) Indoor unit capacity: Cooling (2.5), CS-TZ25TKEW

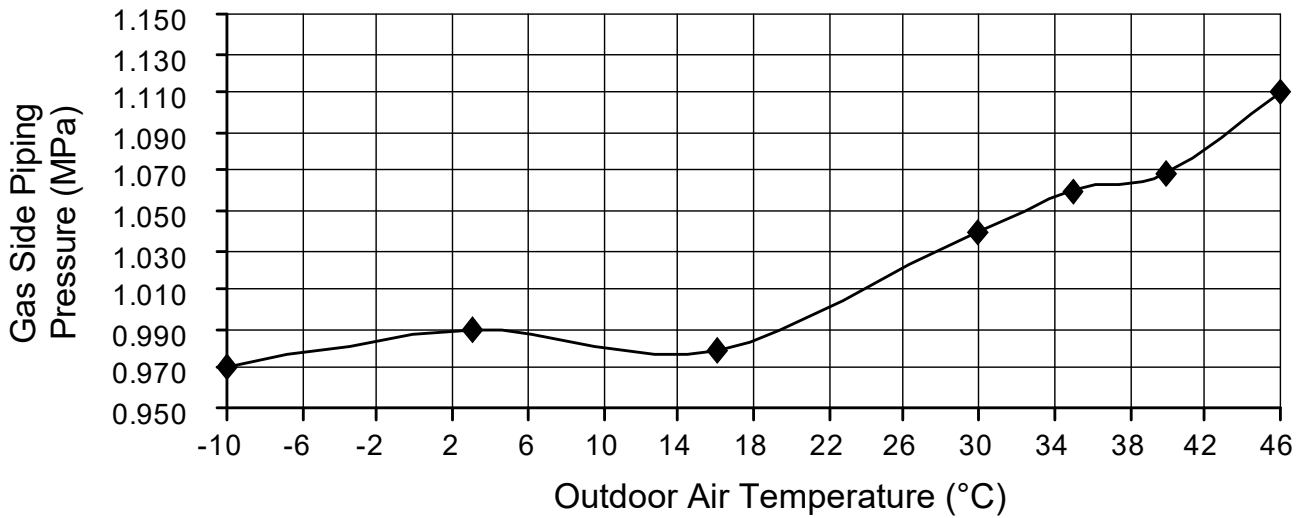
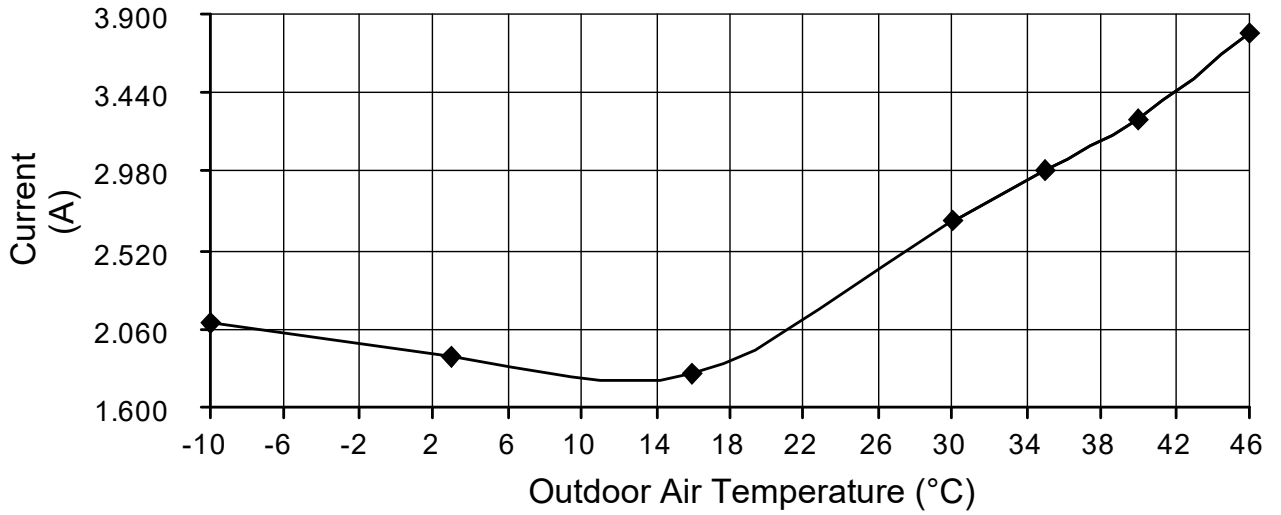
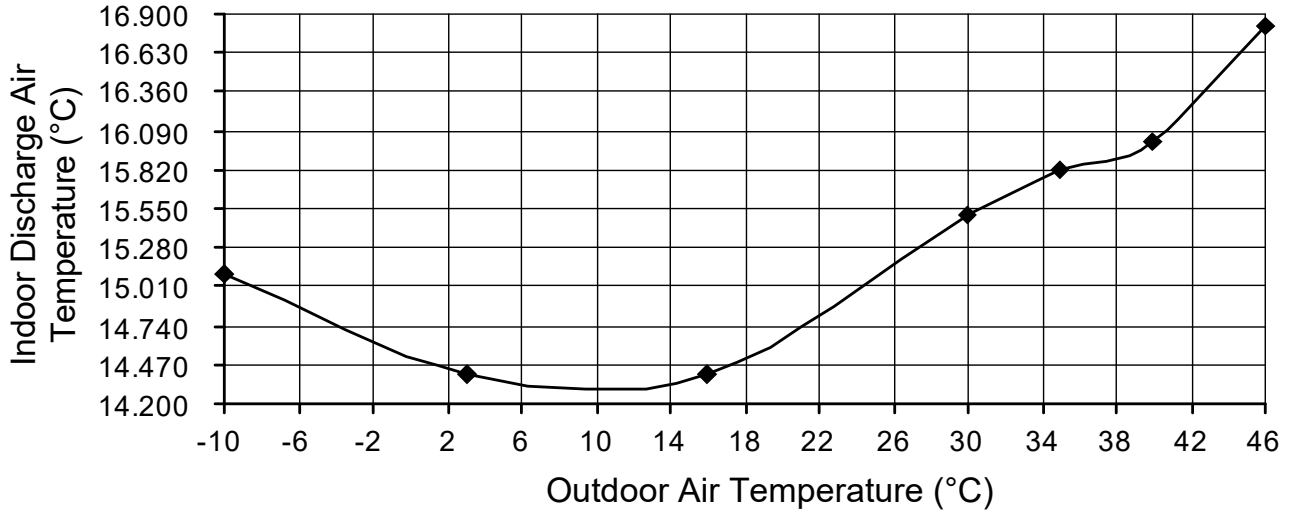

- Cooling Characteristic
- [Condition] Room temperature: 27°C (DBT), 19°C (WBT)  
 Operation condition: High fan speed  
 Piping length: 5.0 m  
 Voltage: 230V, 50Hz

D) Indoor unit capacity: Cooling (3.5), CS-TZ35TKEW

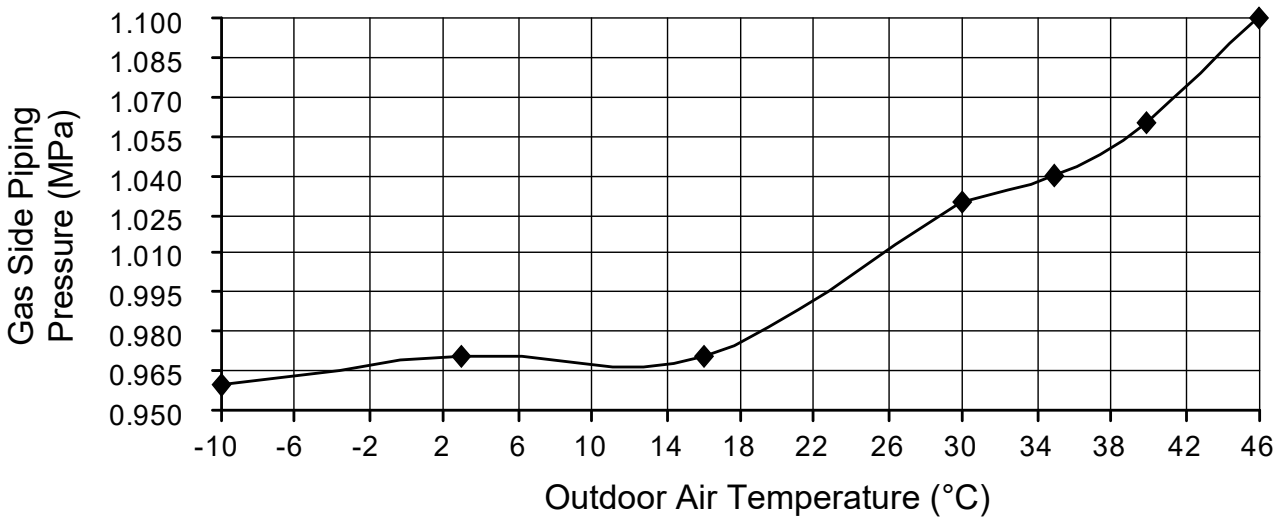
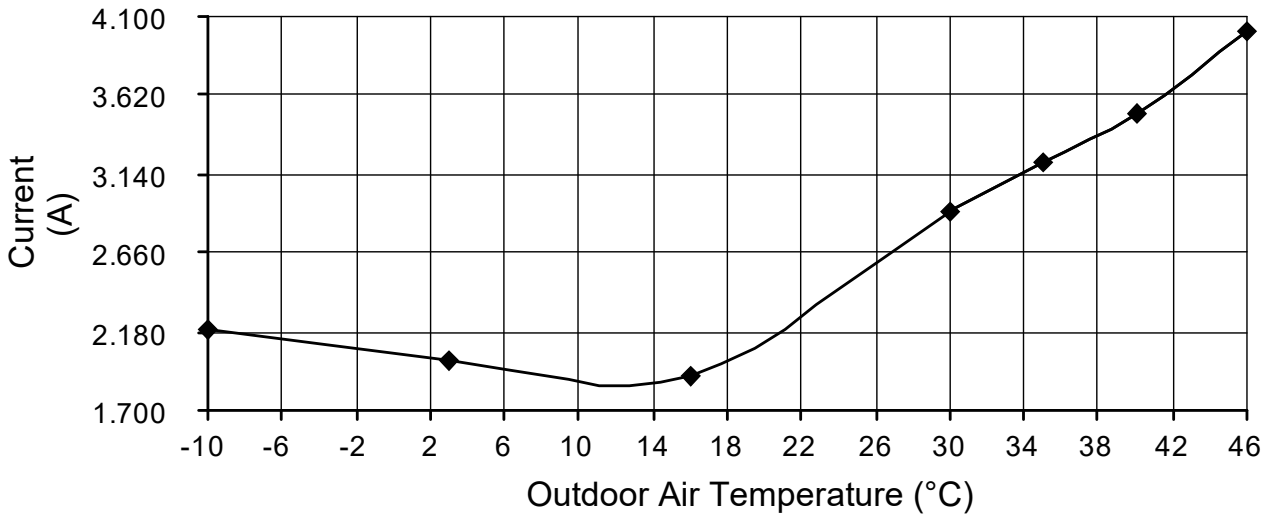
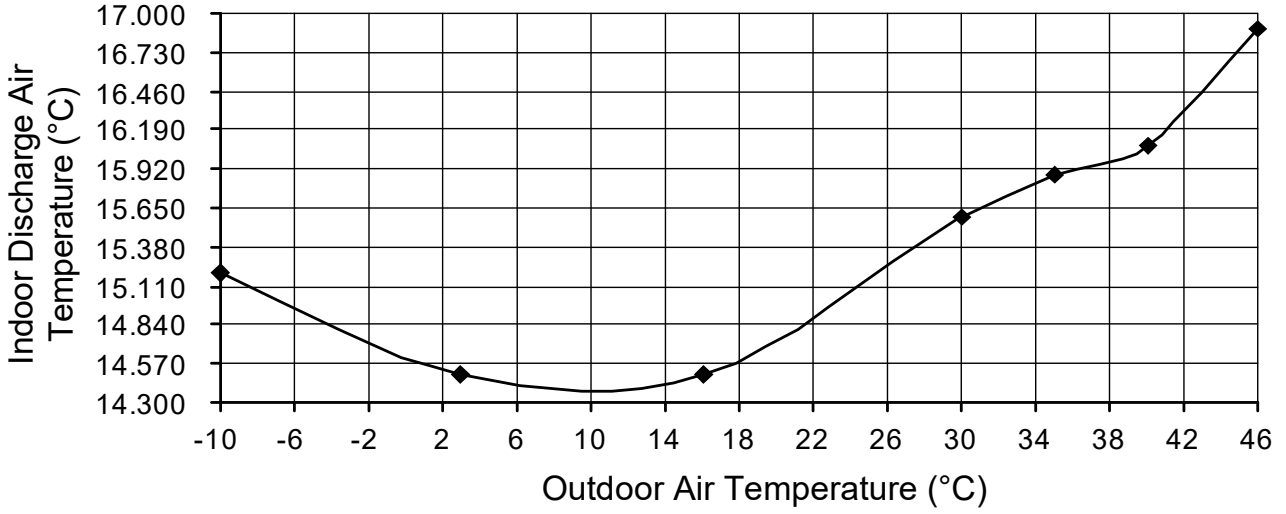

- Heating Characteristic
- [Condition] Room temperature: 20°C (DBT), 12°C (WBT)  
 Operation condition: High fan speed  
 Piping length: 5.0 m  
 Voltage: 230V, 50Hz

A) Indoor unit capacity: Heating (1.6), CS-MTZ16TKEW

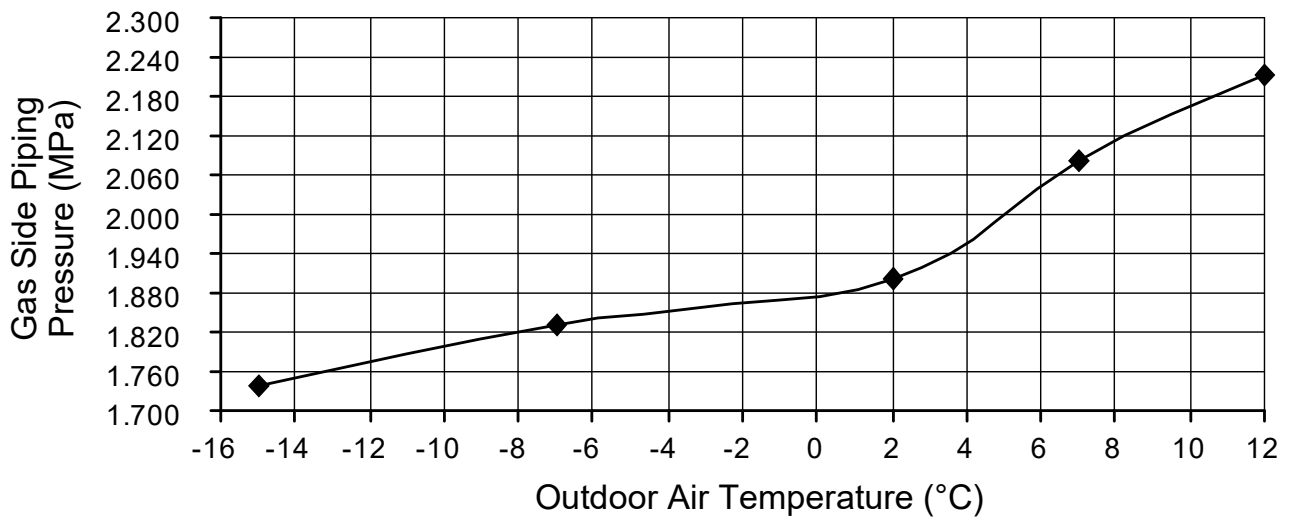
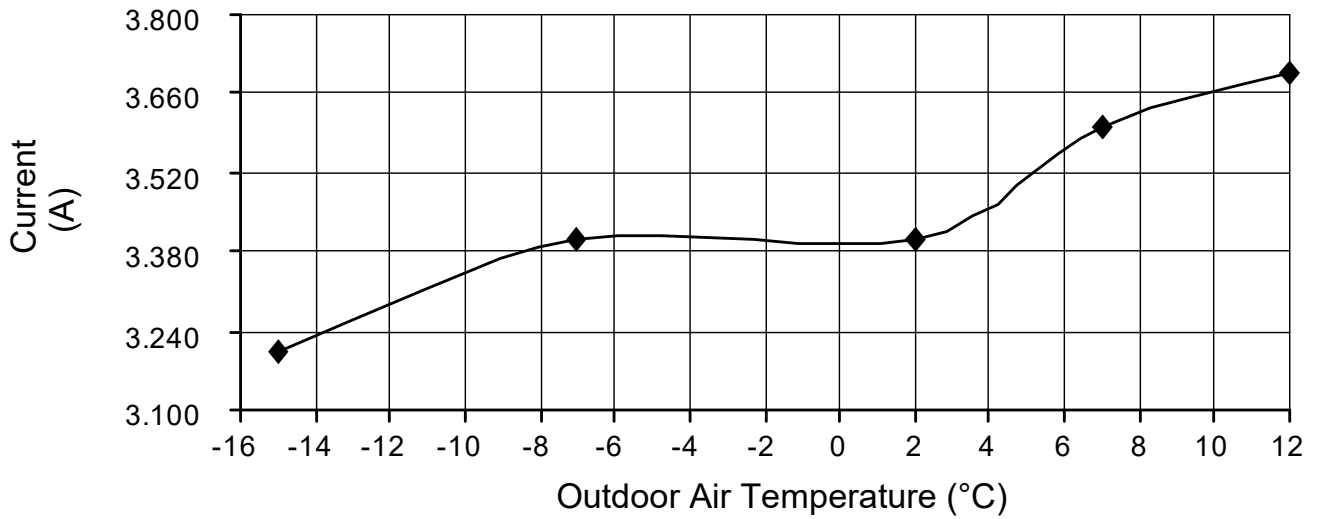
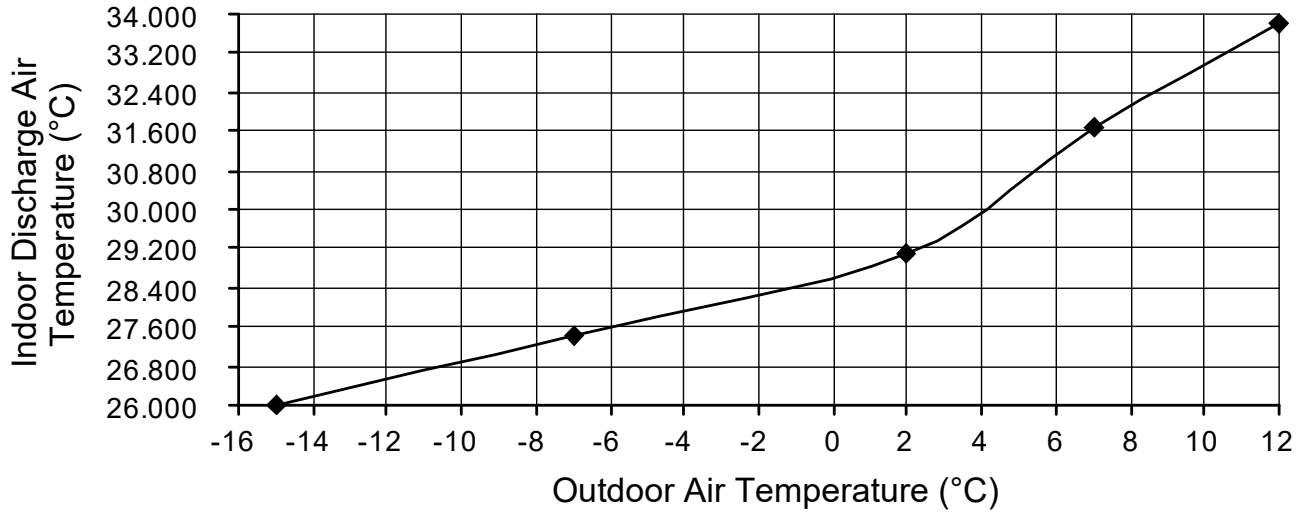

- Heating Characteristic
- [Condition] Room temperature: 20°C (DBT), 12°C (WBT)  
 Operation condition: High fan speed  
 Piping length: 5.0 m  
 Voltage: 230V, 50Hz

B) Indoor unit capacity: Heating (2.0), CS-TZ20TKEW

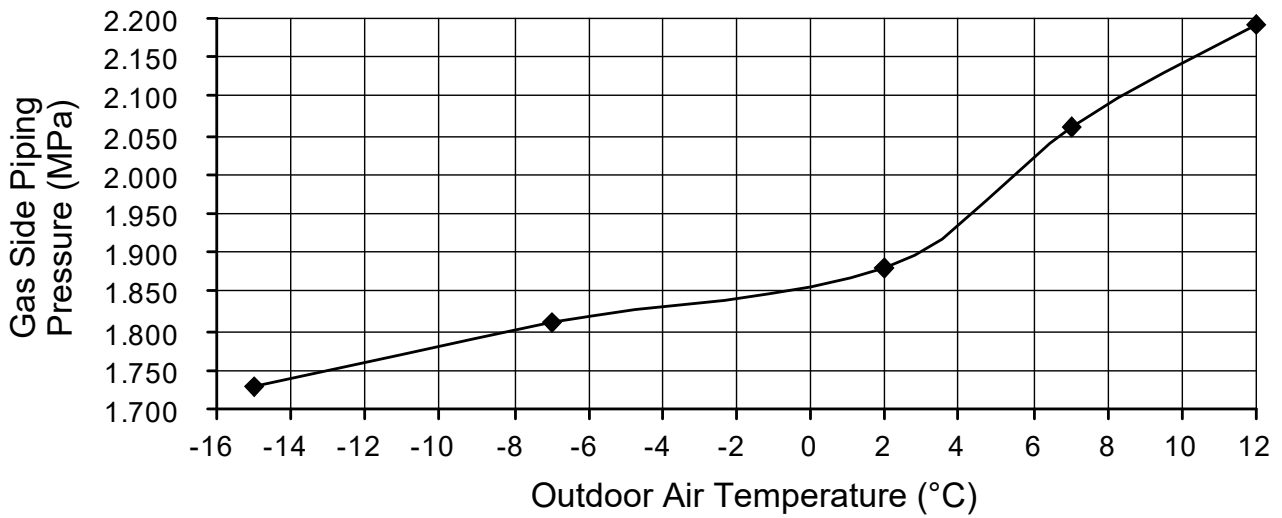
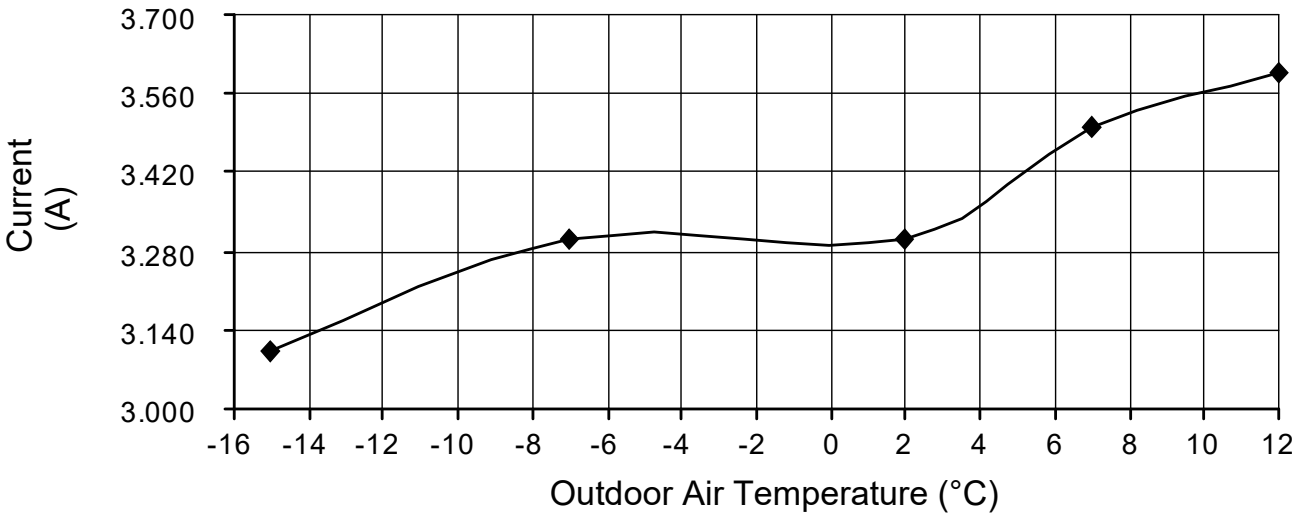
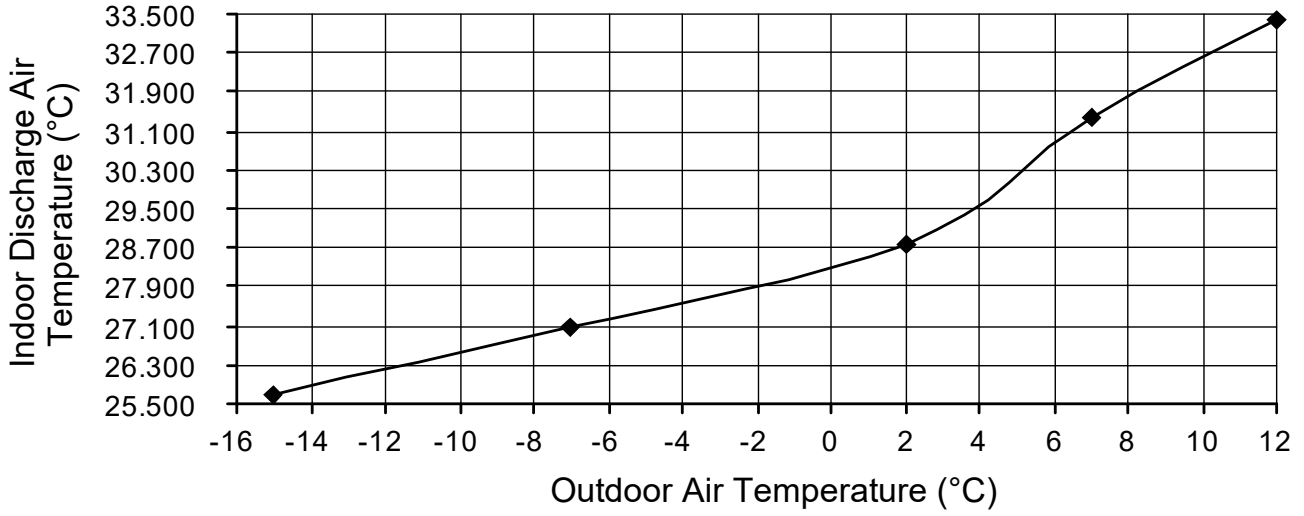



- Heating Characteristic
- [Condition] Room temperature: 20°C (DBT), 12°C (WBT)  
 Operation condition: High fan speed  
 Piping length: 5.0 m  
 Voltage: 230V, 50Hz

C) Indoor unit capacity: Heating (2.5), CS-TZ25TKEW

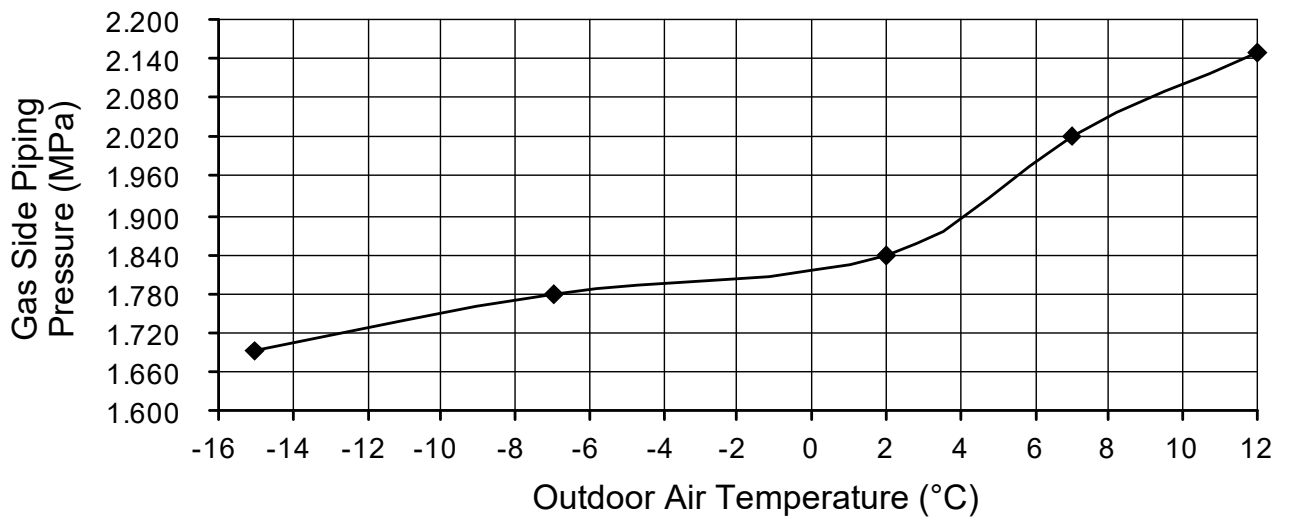
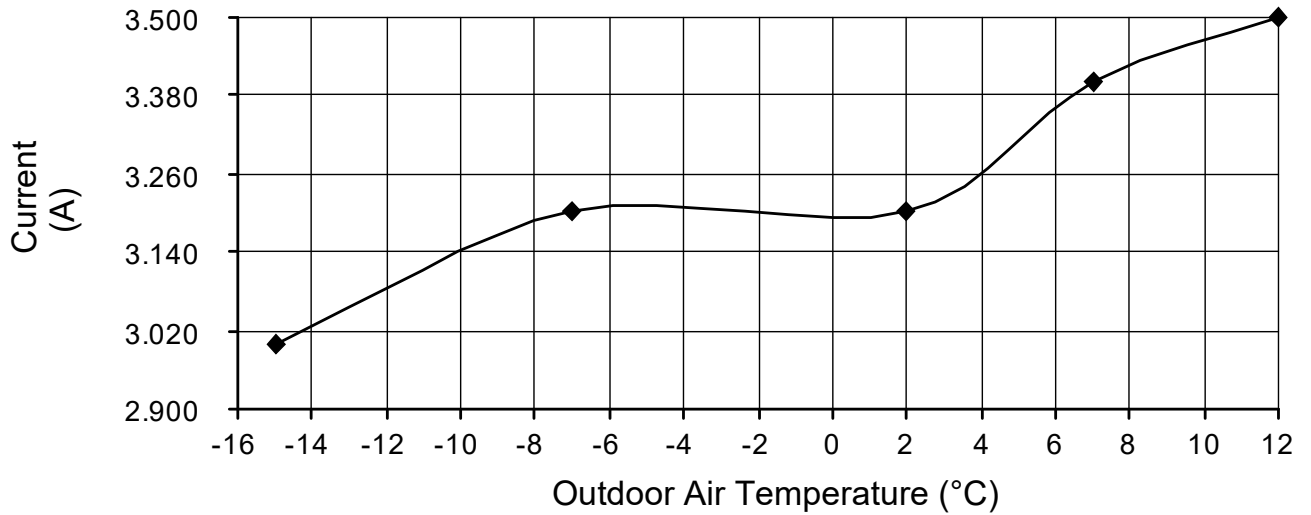
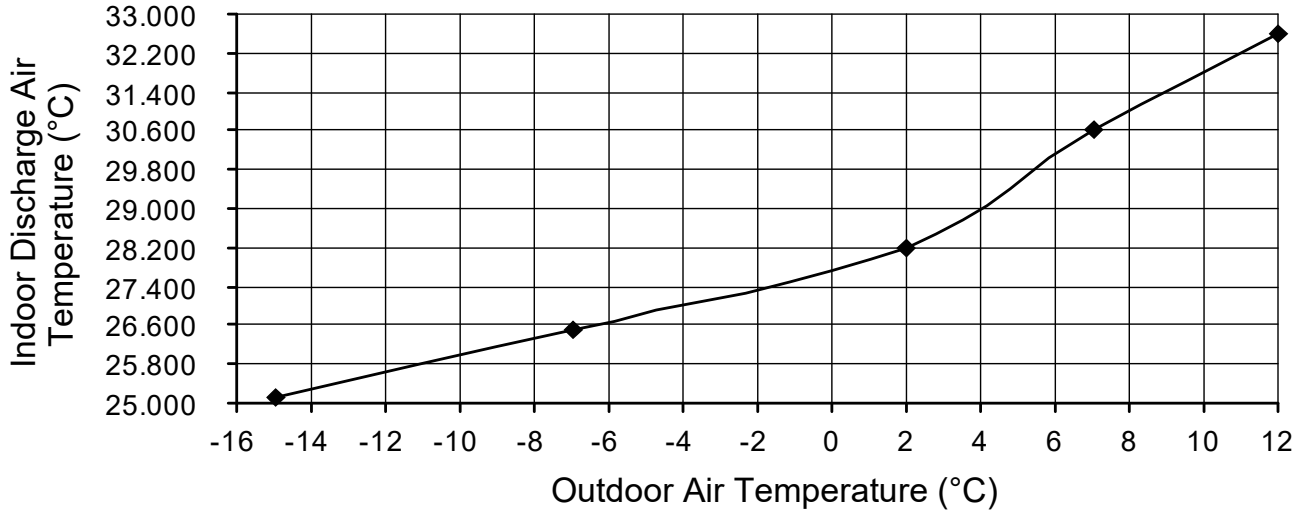

- Heating Characteristic
- [Condition] Room temperature: 20°C (DBT), 12°C (WBT)  
 Operation condition: High fan speed  
 Piping length: 5.0 m  
 Voltage: 230V, 50Hz

D) Indoor unit capacity: Heating (3.5), CS-TZ35TKEW

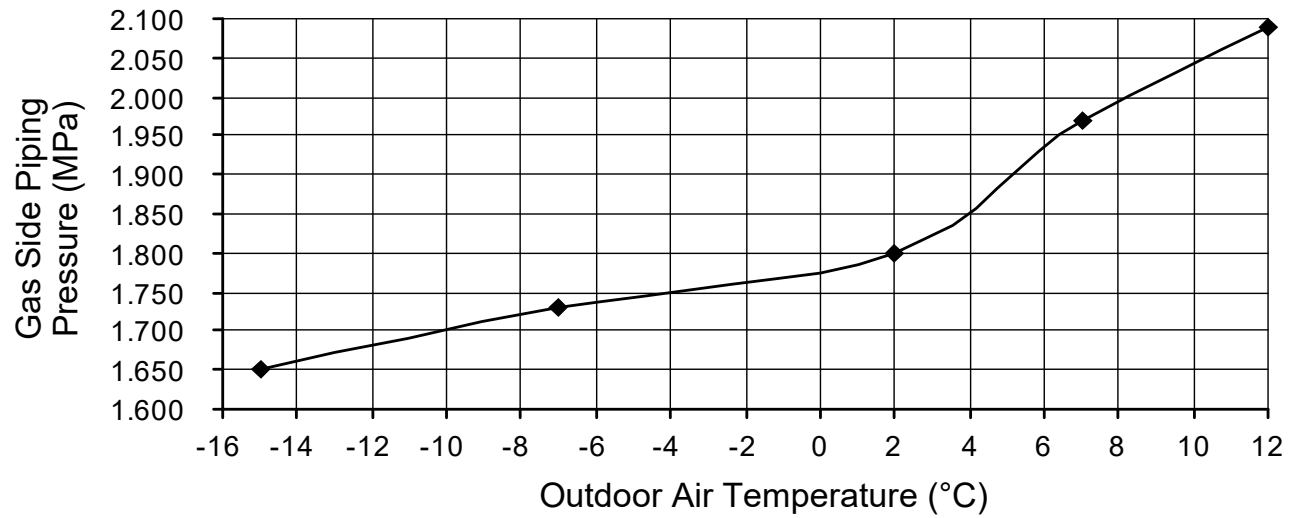
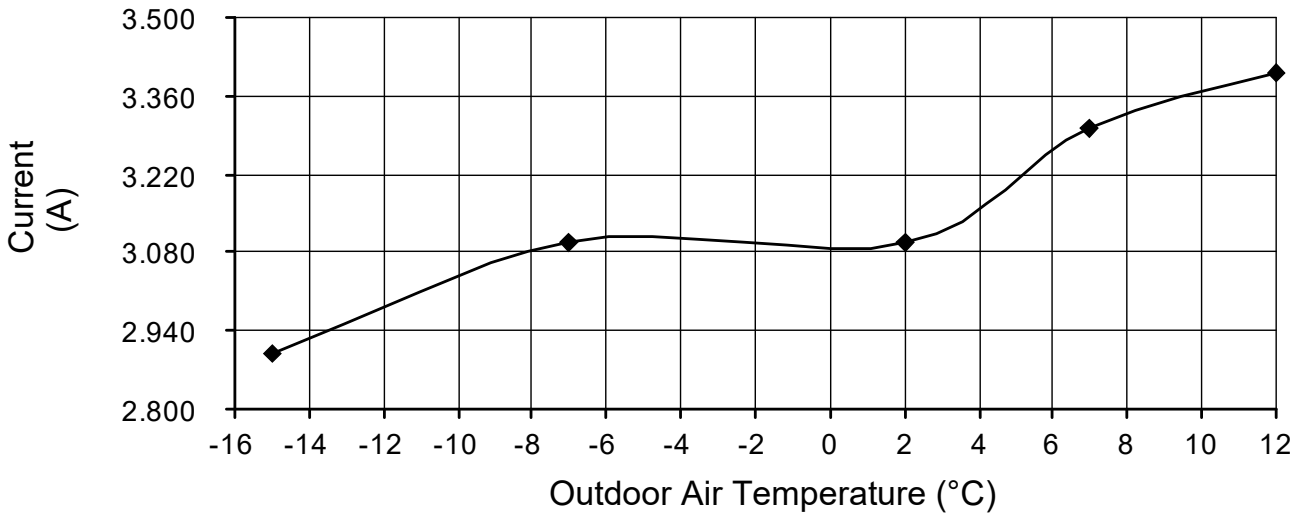
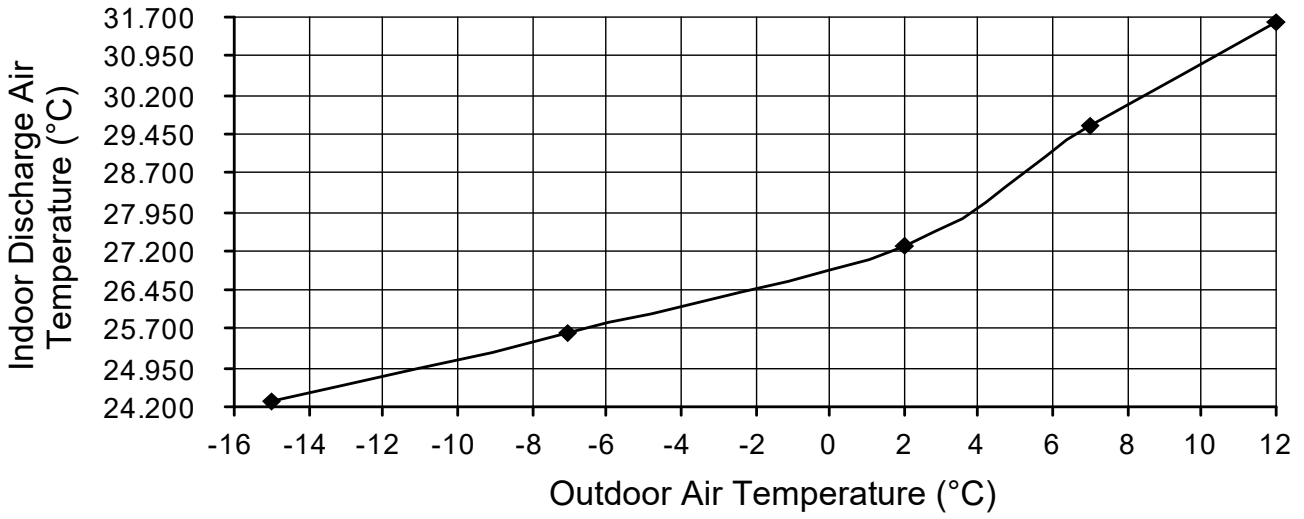

### 19.1.2 Two Indoor Unit Operation

- Cooling Characteristic

[Condition] Room temperature: 27°C (DBT), 19°C (WBT)

Operation condition: High fan speed

Piping length: 5.0 m

Voltage: 230V, 50Hz

A) Indoor unit capacity: Cooling (1.6 + 1.6), CS-MTZ16TKE + CS-MTZ16TKE

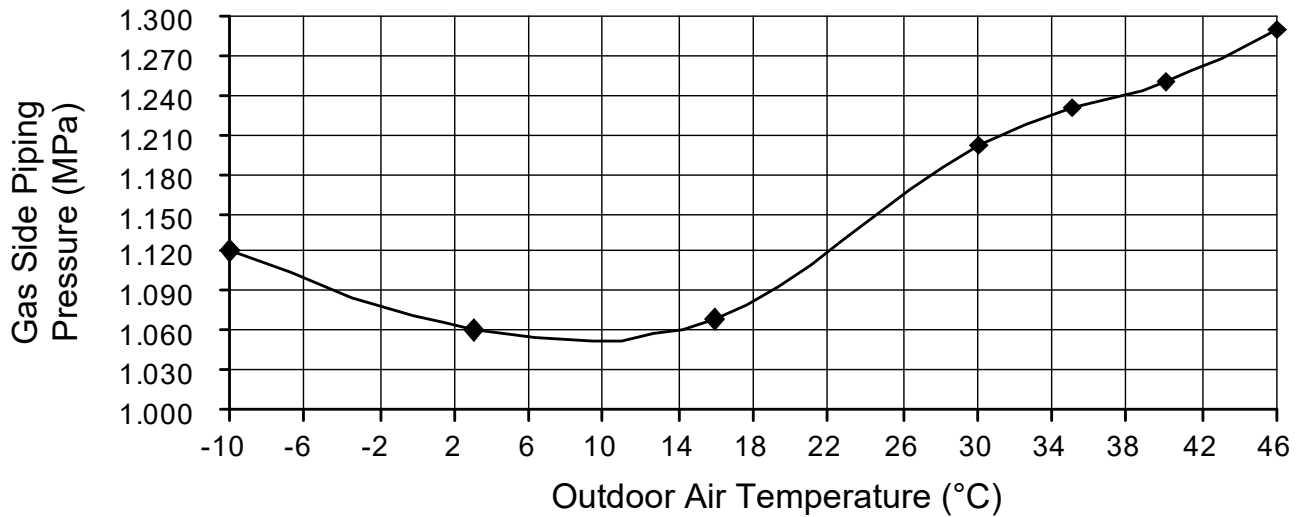
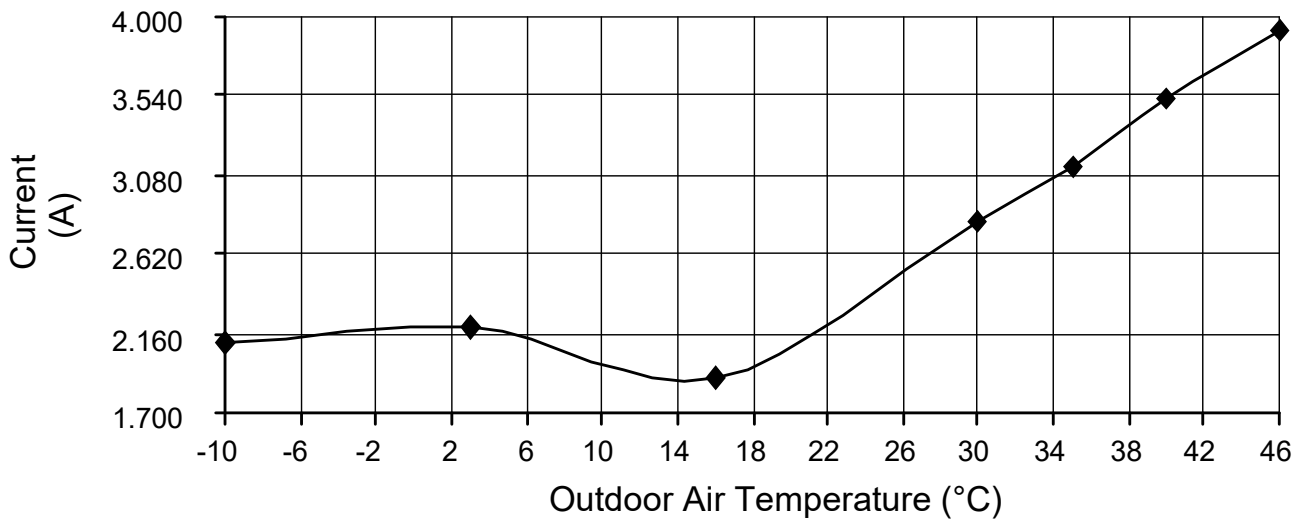
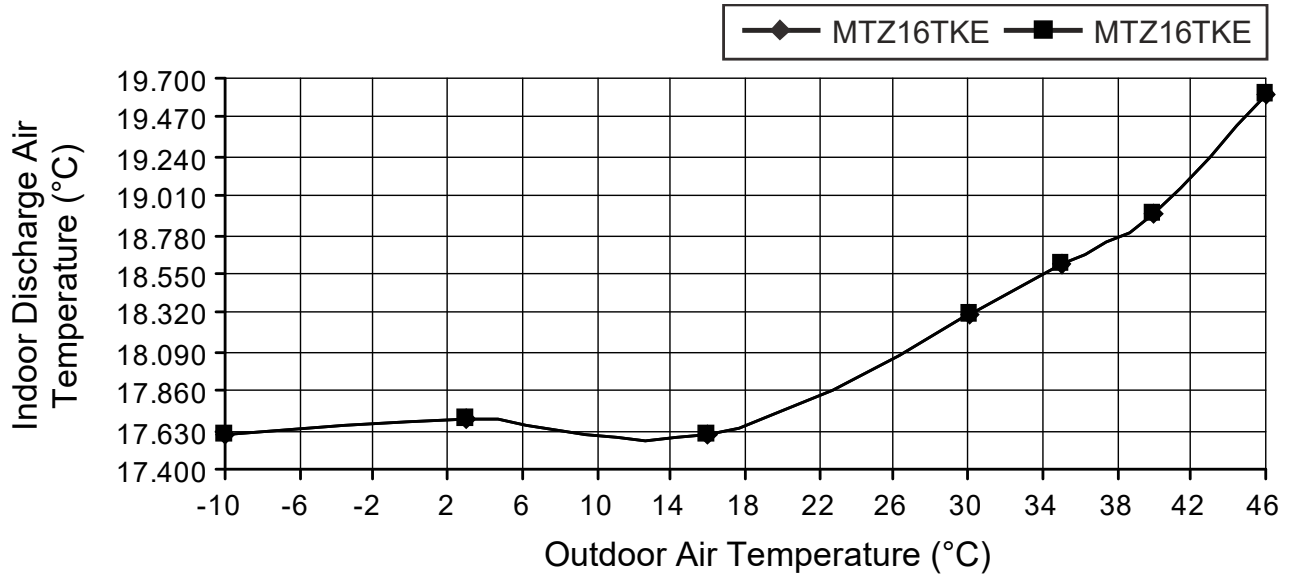

- Cooling Characteristic

[Condition] Room temperature: 27°C (DBT), 19°C (WBT)

Operation condition: High fan speed

Piping length: 5.0 m

Voltage: 230V, 50Hz

B) Indoor unit capacity: Cooling (2.5 + 2.5), CS-TZ25TKEW + CS-TZ25TKEW

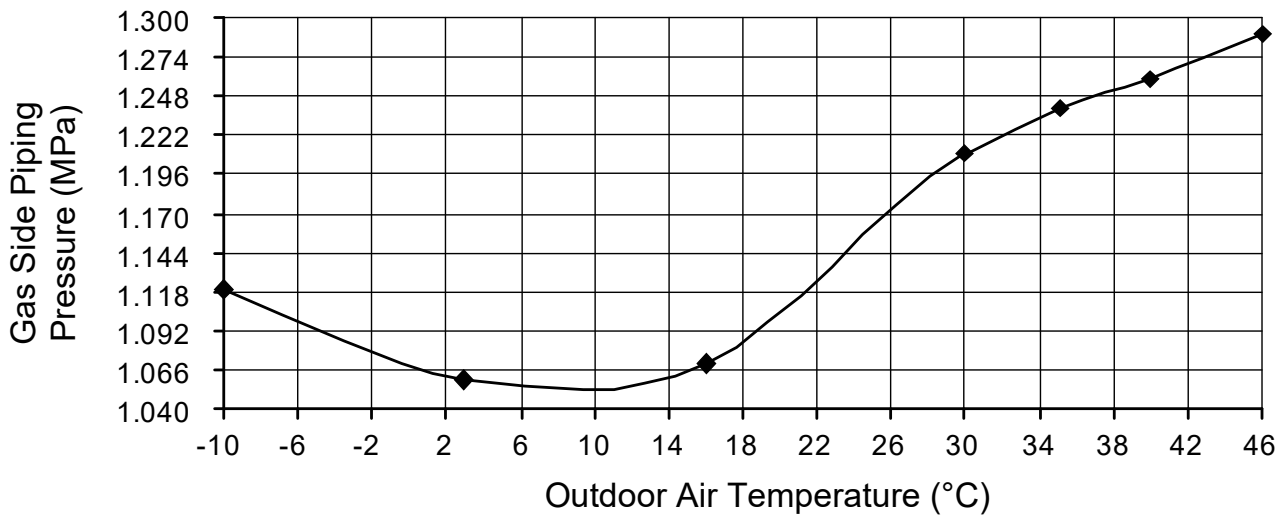
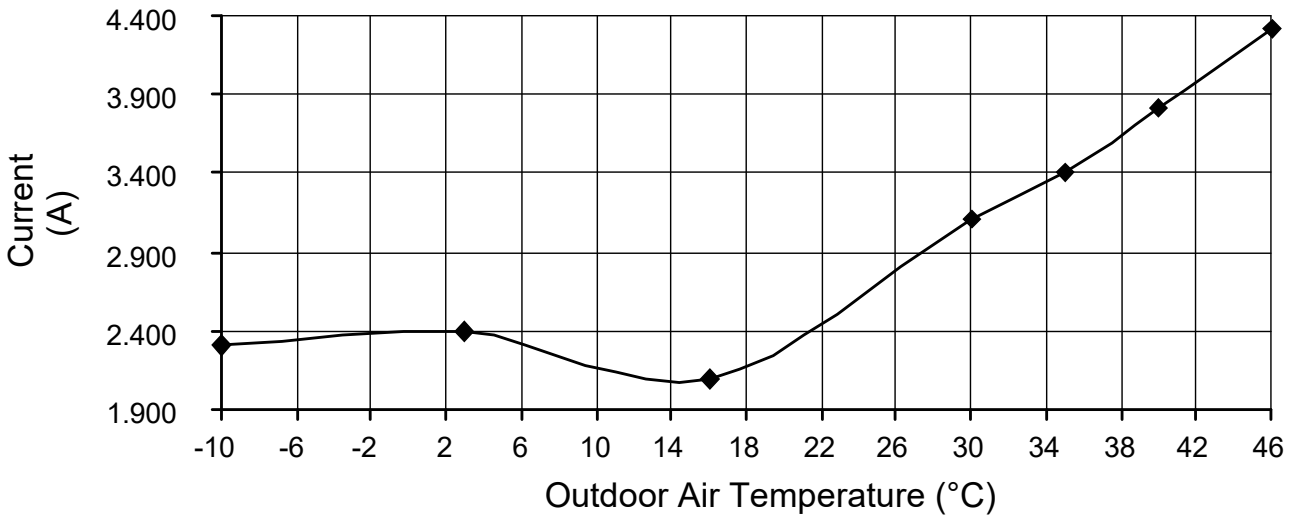
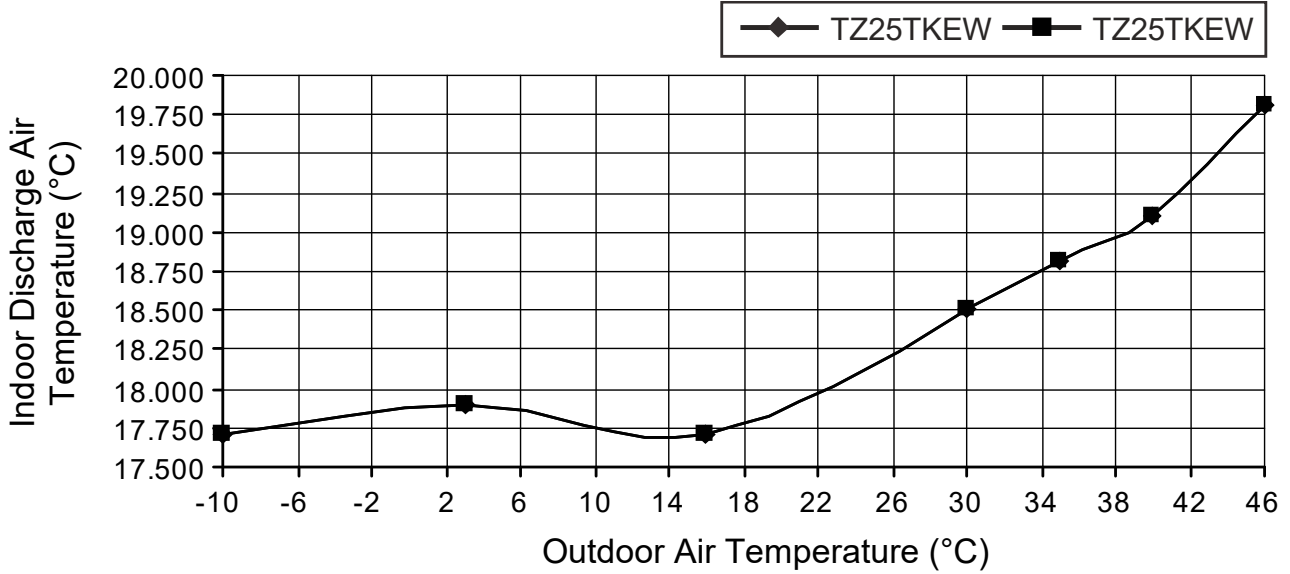

- Heating Characteristic
- [Condition] Room temperature: 20°C (DBT), 12°C (WBT)  
 Operation condition: High fan speed  
 Piping length: 5.0 m  
 Voltage: 230V, 50Hz

A) Indoor unit capacity: Heating (1.6 + 1.6), CS-MTZ16TKE + CS-MTZ16TKE

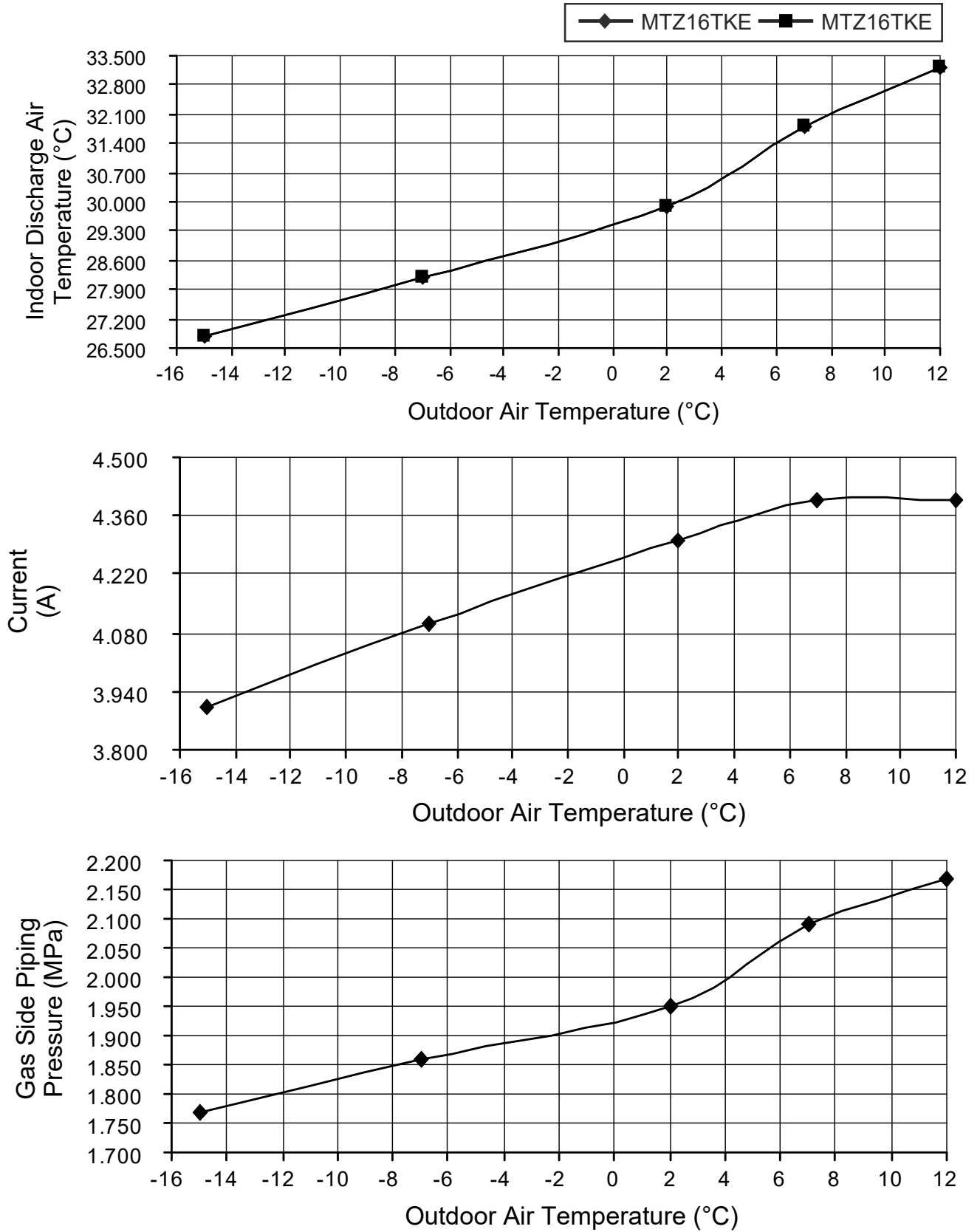

- Heating Characteristic

[Condition] Room temperature: 20°C (DBT), 12°C (WBT)

Operation condition: High fan speed

Piping length: 5.0 m

Voltage: 230V, 50Hz

B) Indoor unit capacity: Heating (2.5 + 2.5), CS-TZ25TKEW + CS-TZ25TKEW

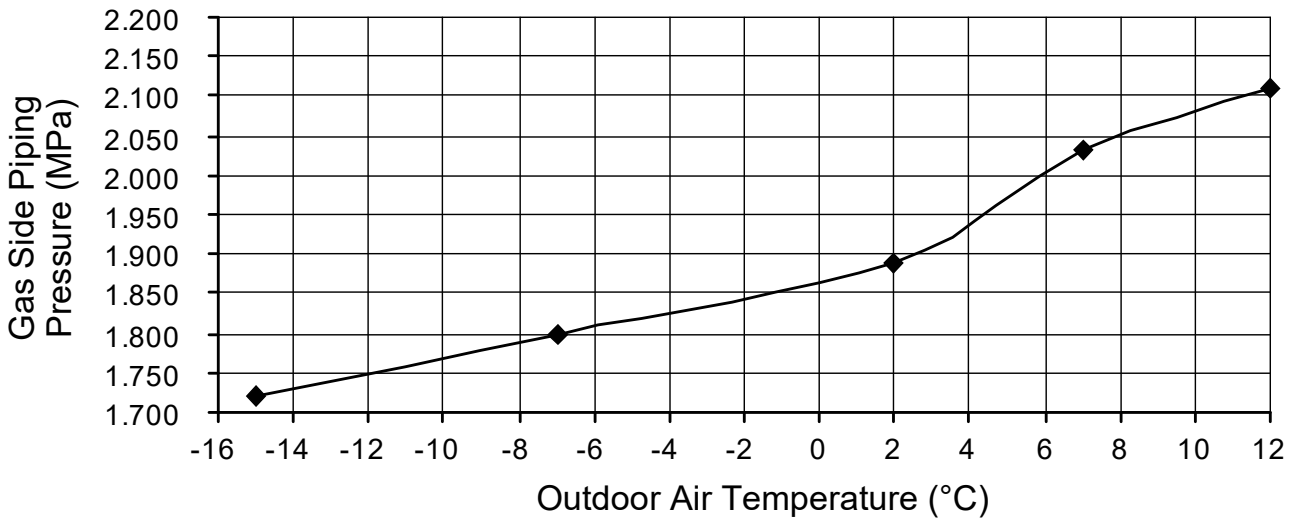
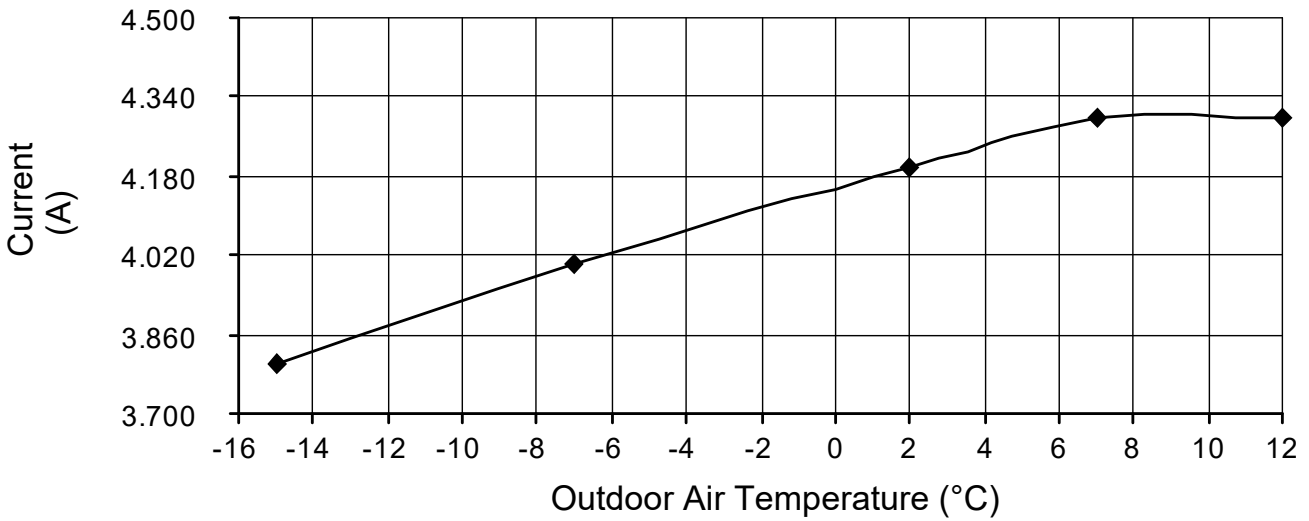
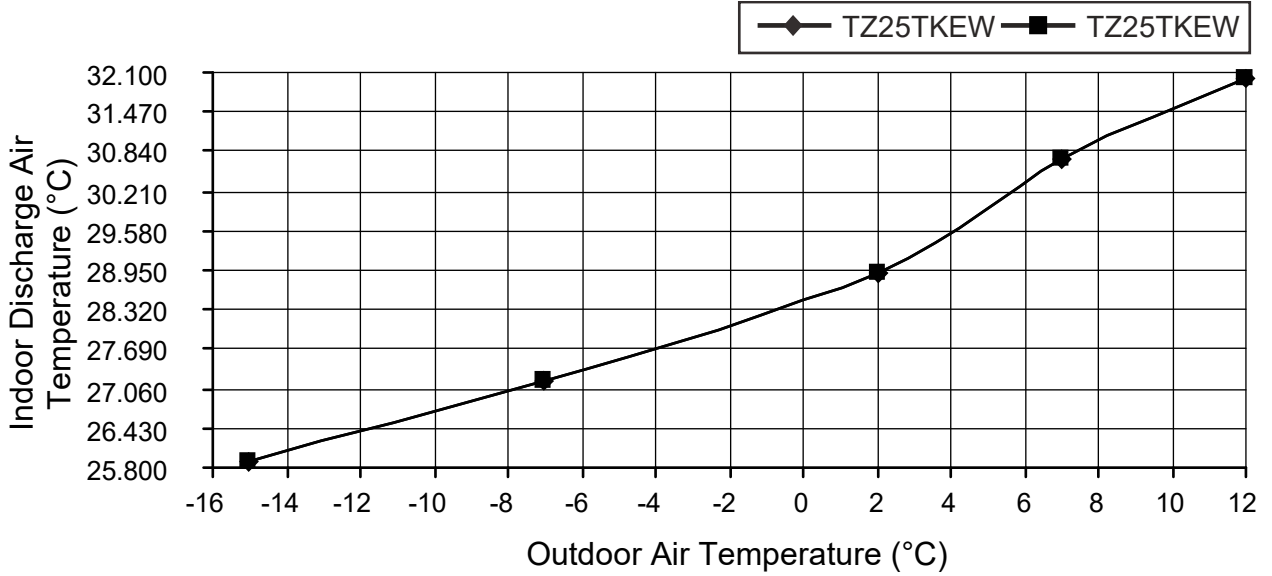

## 19.2 Operation Characteristics (CU-2TZ50TBE)

### 19.2.1 One Indoor Unit Operation

- Cooling Characteristic  
[Condition] Room temperature: 27°C (DBT), 19°C (WBT)  
Operation condition: High fan speed  
Piping length: 5.0 m  
Voltage: 230V, 50Hz

A) Indoor unit capacity: Cooling (1.6), CS-MTZ16TKE

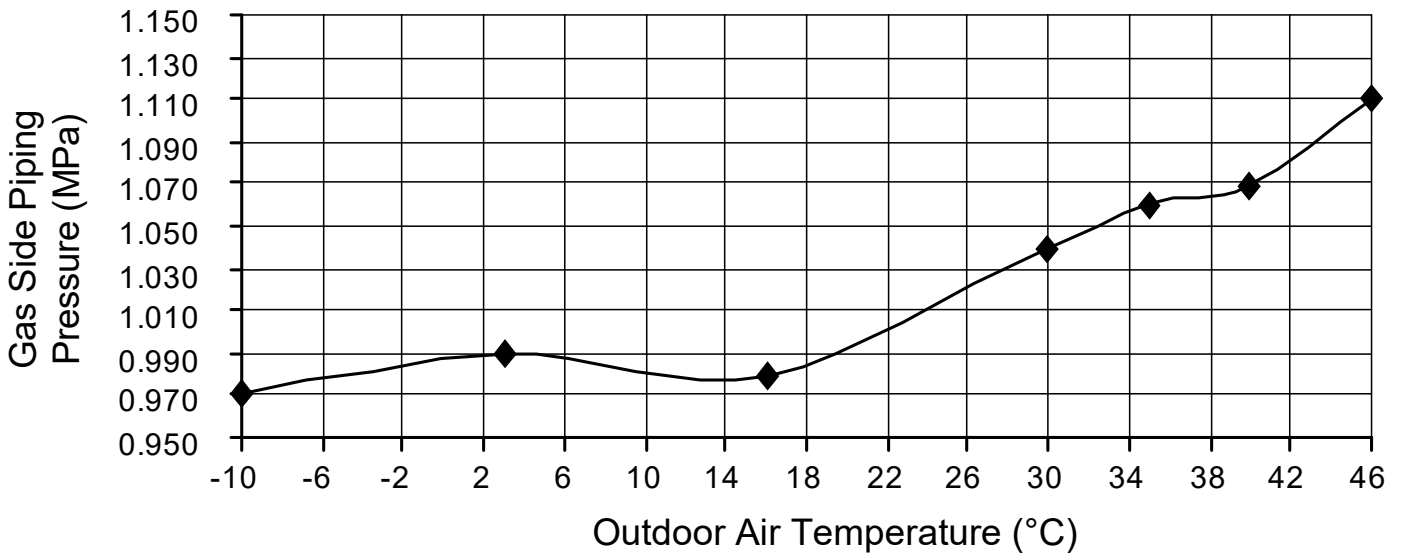
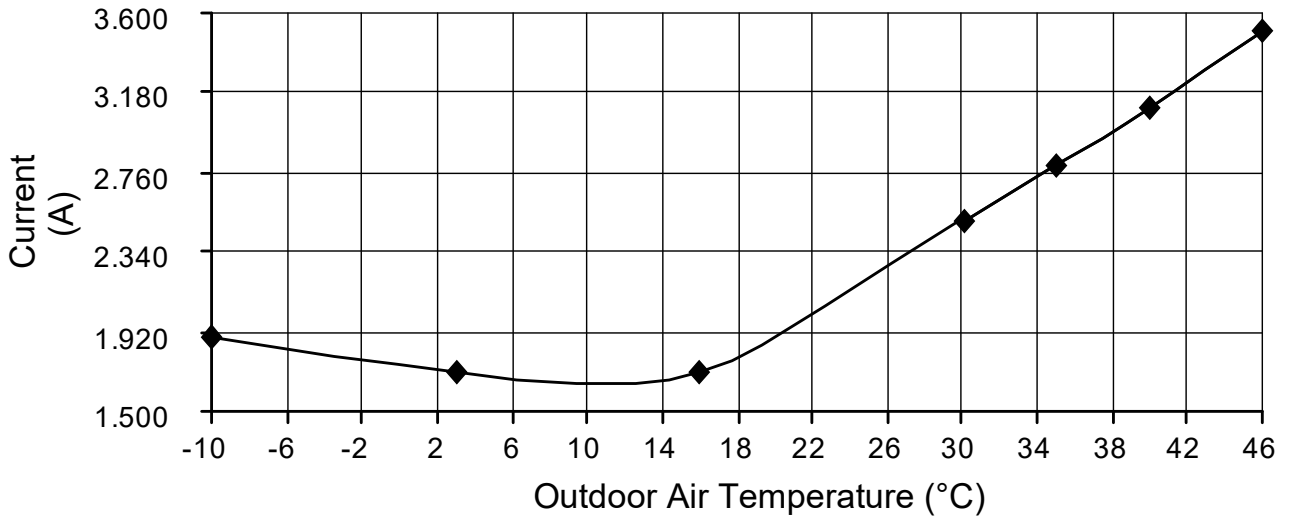
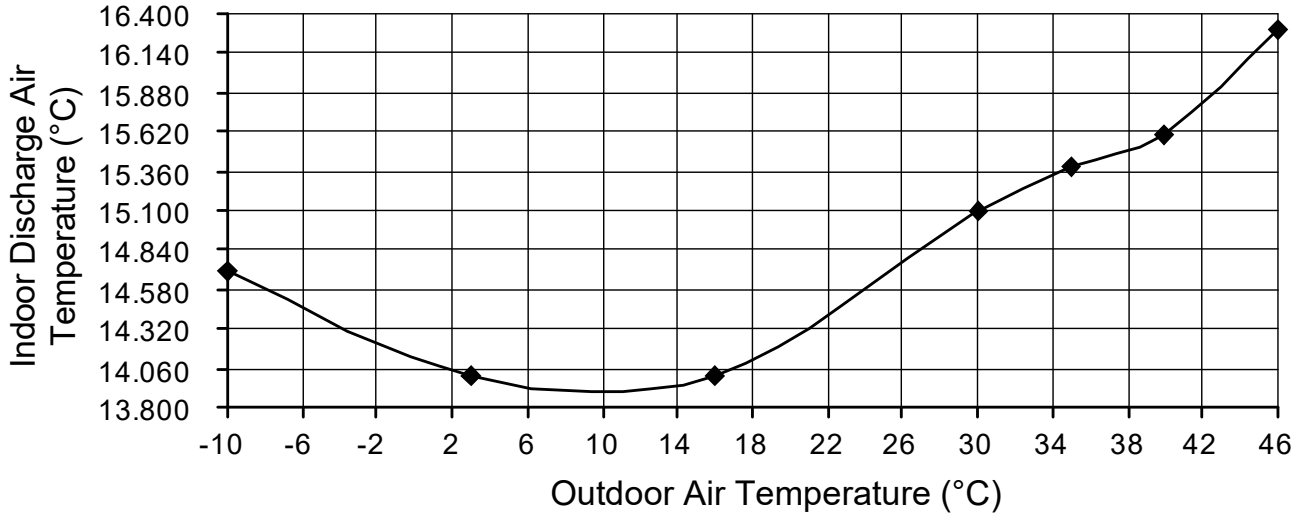

• Cooling Characteristic

[Condition] Room temperature: 27°C (DBT), 19°C (WBT)

Operation condition: High fan speed

Piping length: 5.0 m

Voltage: 230V, 50Hz

B) Indoor unit capacity: Cooling (2.0), CS-TZ20TKEW

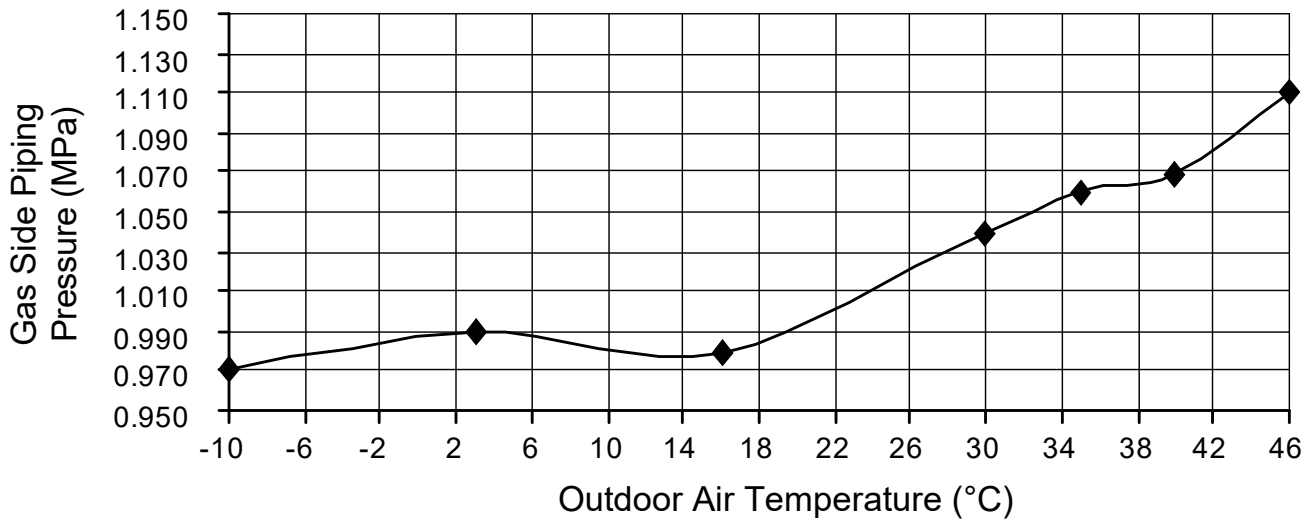
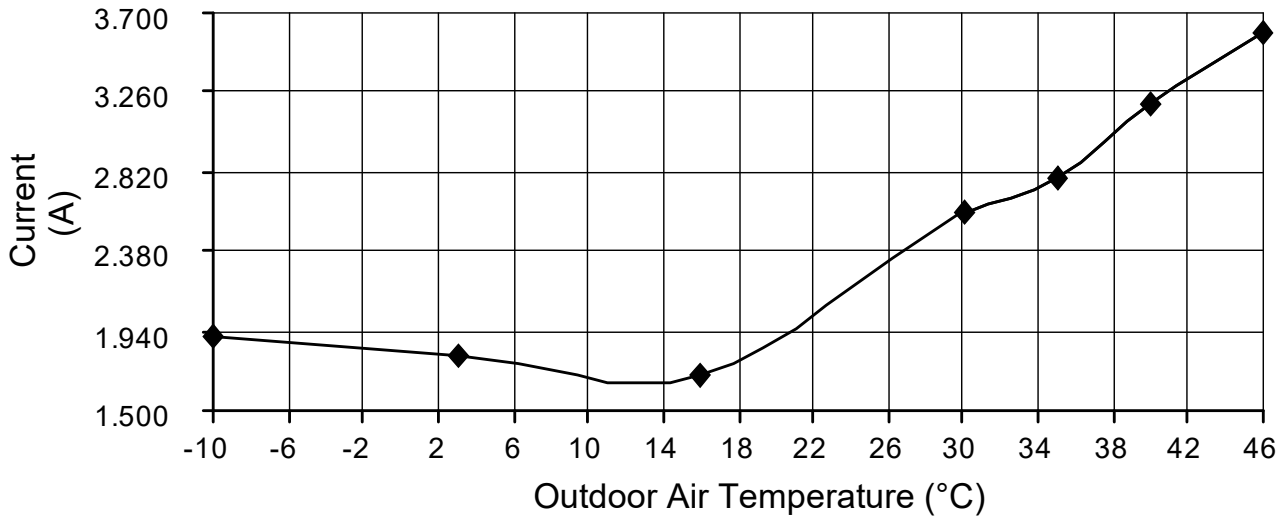
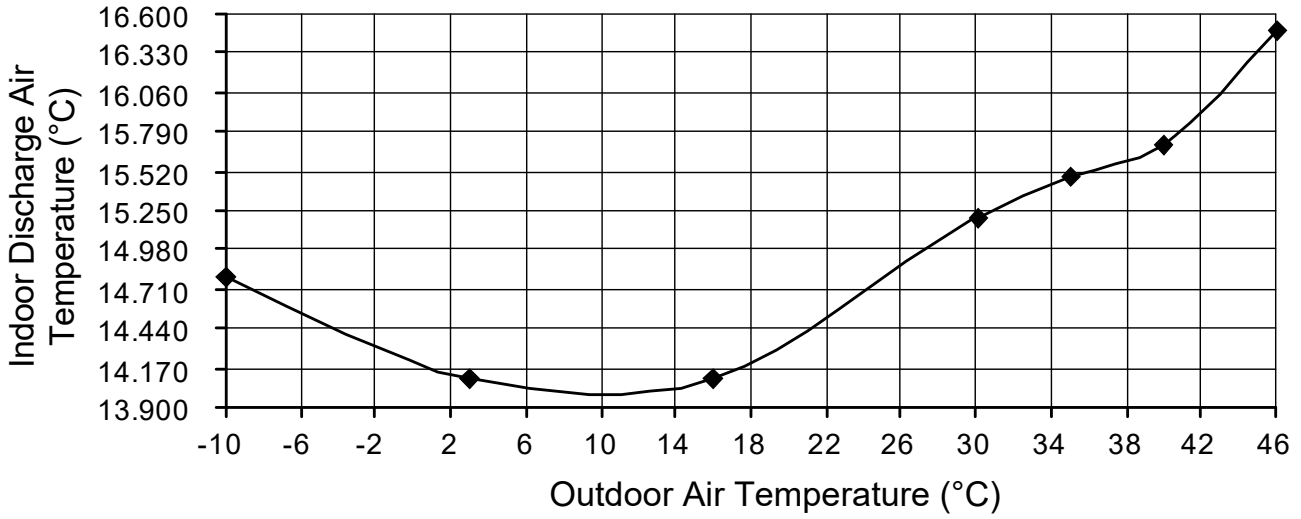



- Cooling Characteristic  
 [Condition] Room temperature: 27°C (DBT), 19°C (WBT)  
 Operation condition: High fan speed  
 Piping length: 5.0 m  
 Voltage: 230V, 50Hz

C) Indoor unit capacity: Cooling (2.5), CS-TZ25TKEW

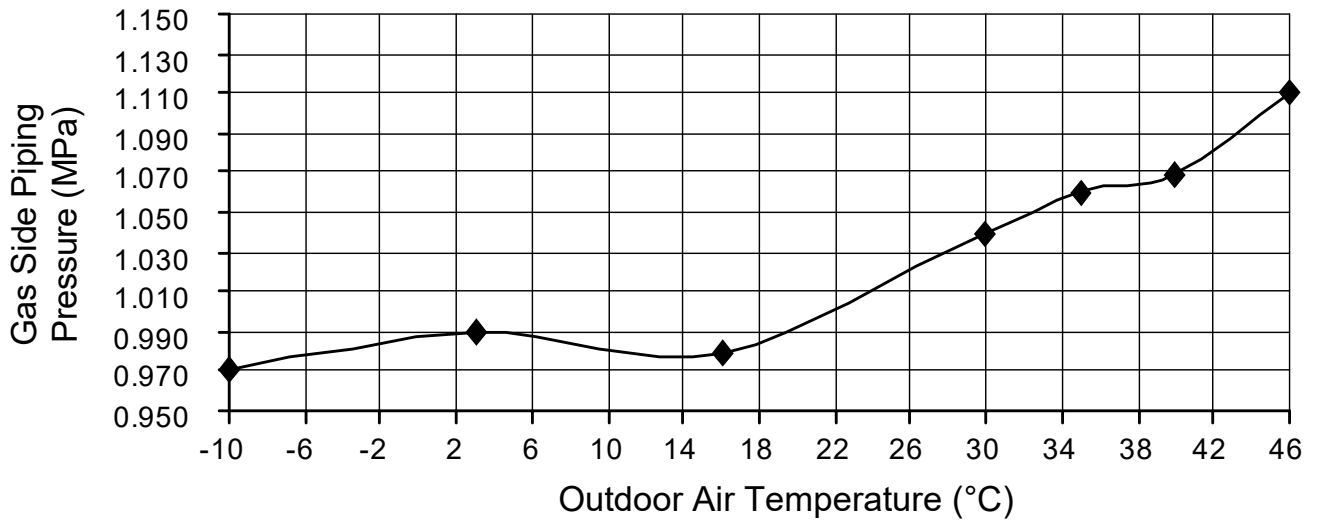
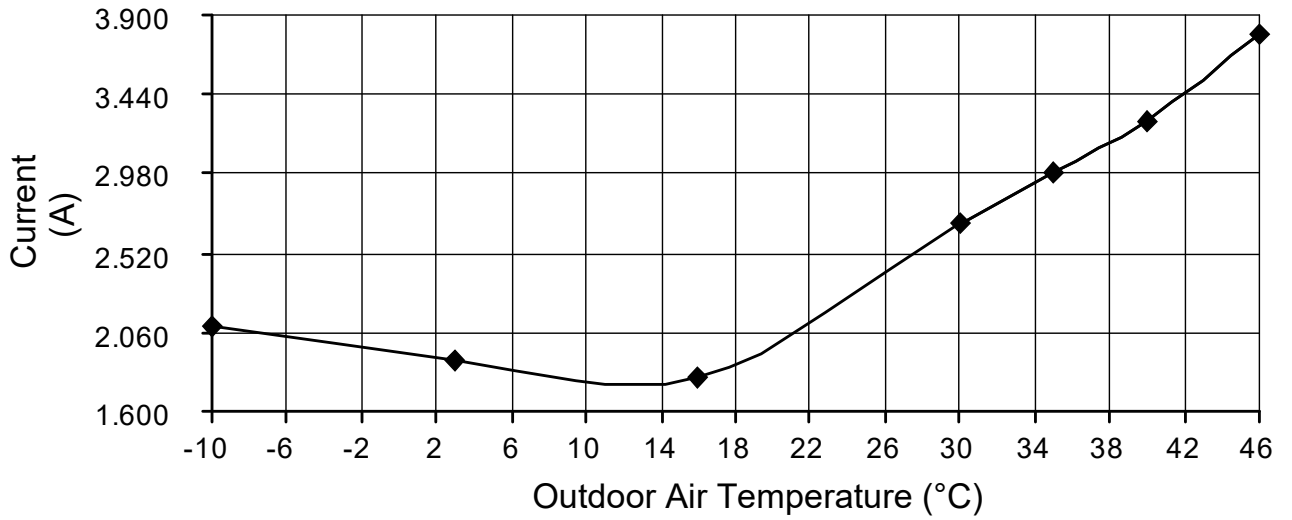
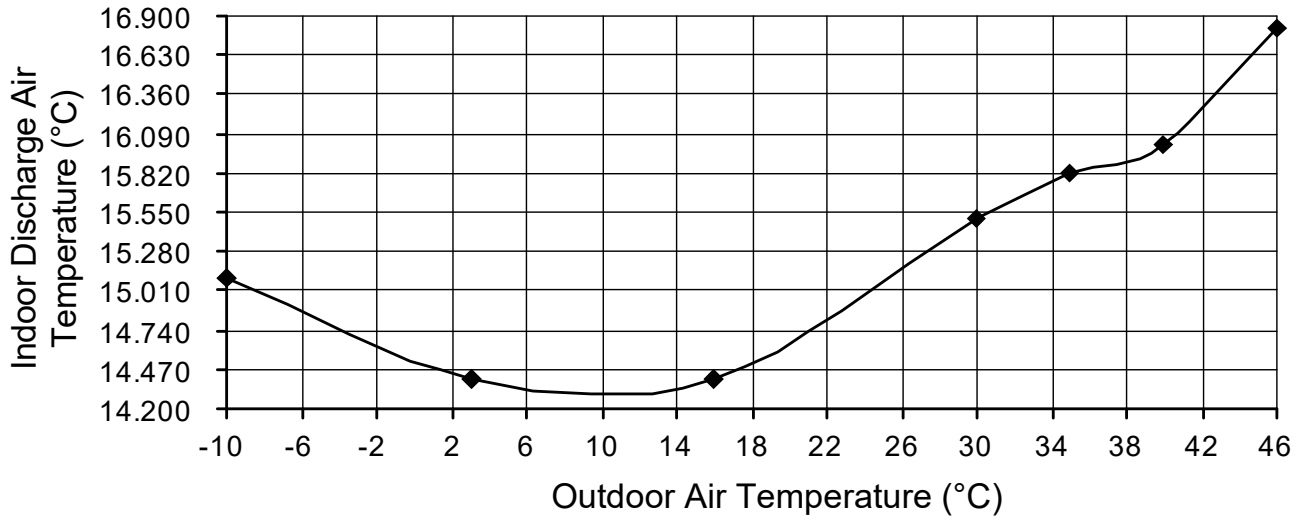

- Cooling Characteristic

[Condition] Room temperature: 27°C (DBT), 19°C (WBT)

Operation condition: High fan speed

Piping length: 5.0 m

Voltage: 230V, 50Hz

D) Indoor unit capacity: Cooling (3.5), CS-TZ35TKEW

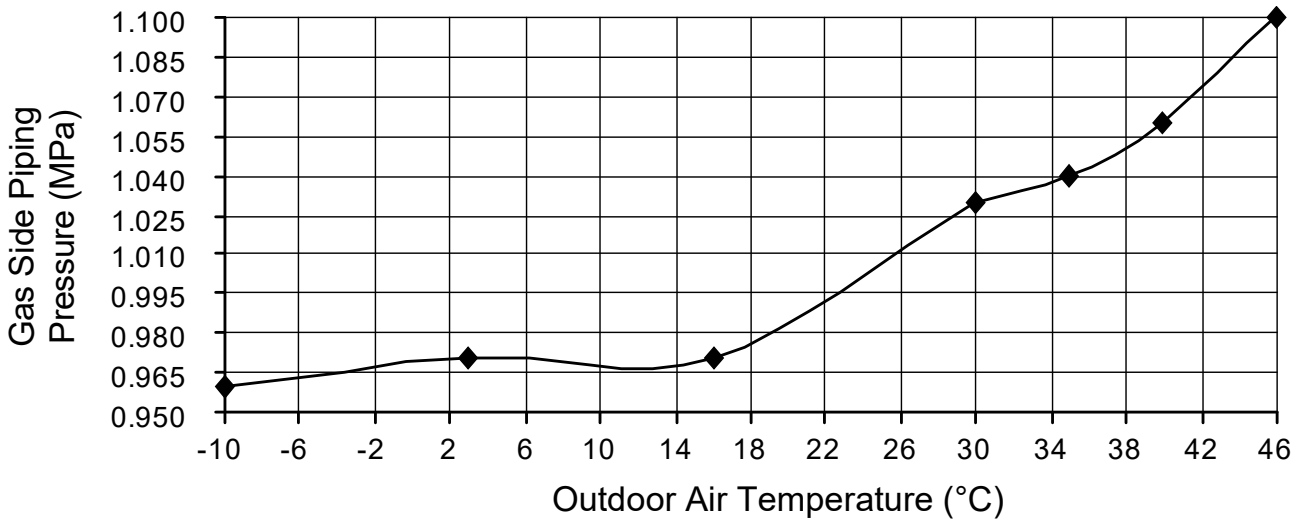
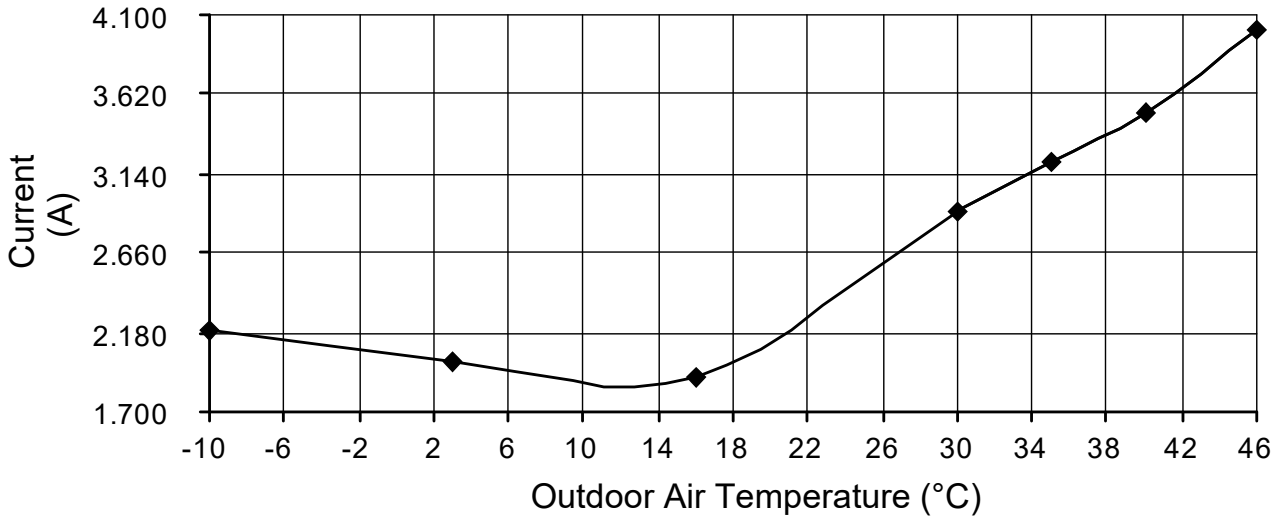
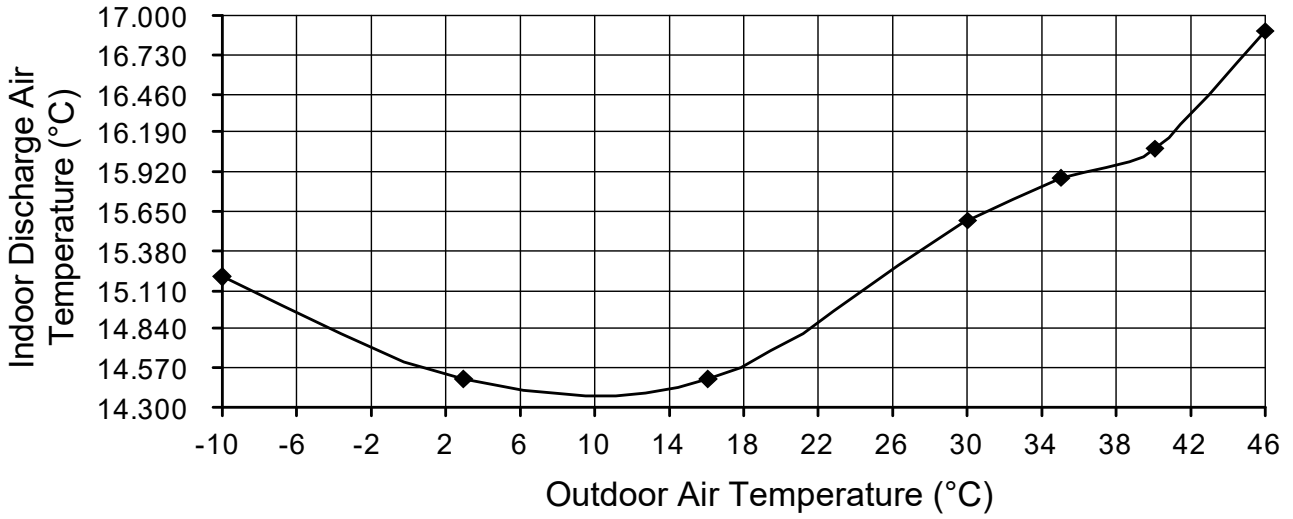

- Cooling Characteristic  
 [Condition] Room temperature: 27°C (DBT), 19°C (WBT)  
 Operation condition: High fan speed  
 Piping length: 5.0 m  
 Voltage: 230V, 50Hz

E) Indoor unit capacity: Cooling (4.2), CS-TZ42TKEW

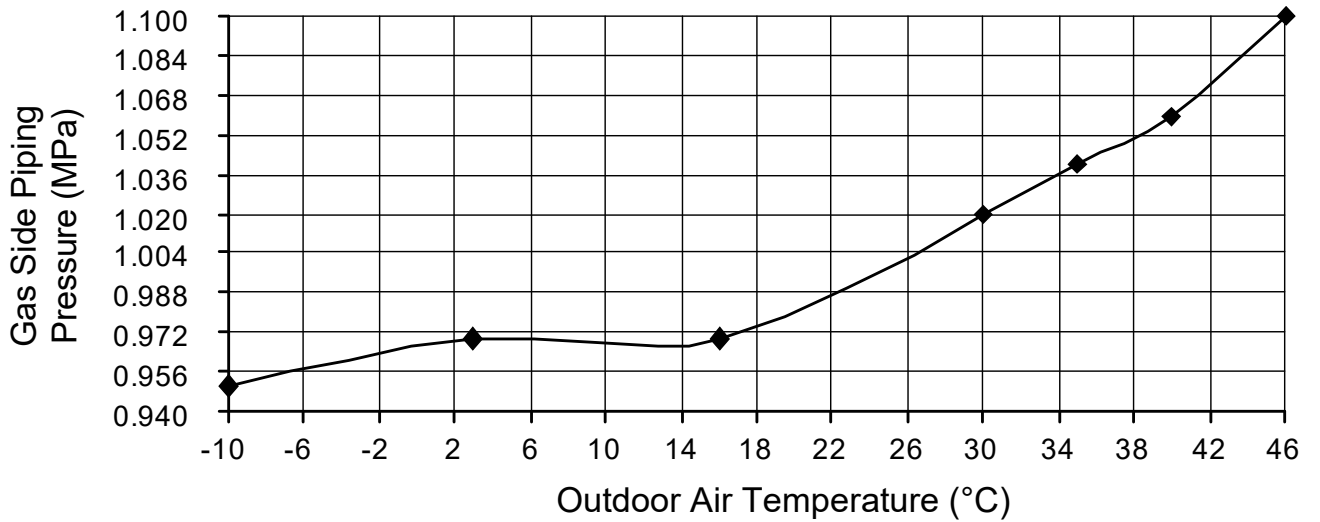
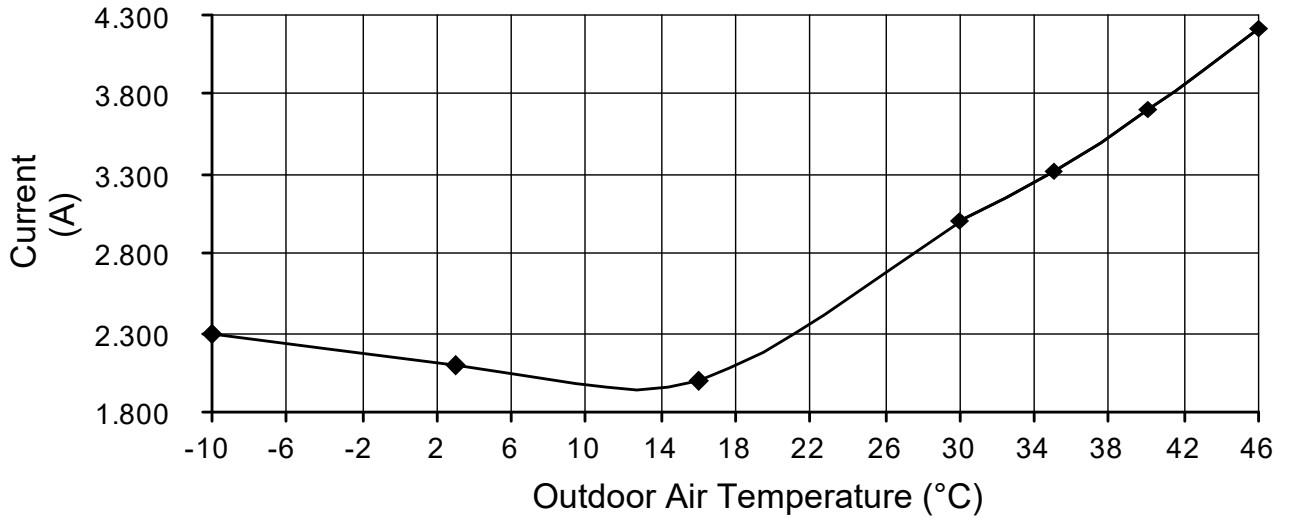
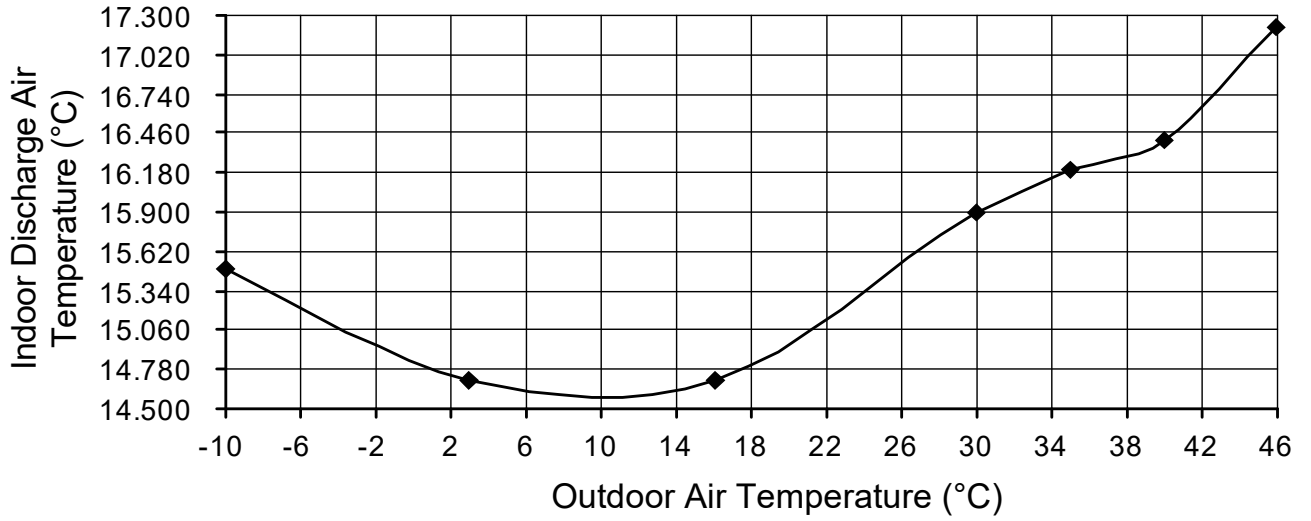

- Cooling Characteristic
- [Condition] Room temperature: 27°C (DBT), 19°C (WBT)  
 Operation condition: High fan speed  
 Piping length: 5.0 m  
 Voltage: 230V, 50Hz

F) Indoor unit capacity: Cooling (5.0), CS-TZ50TKEW

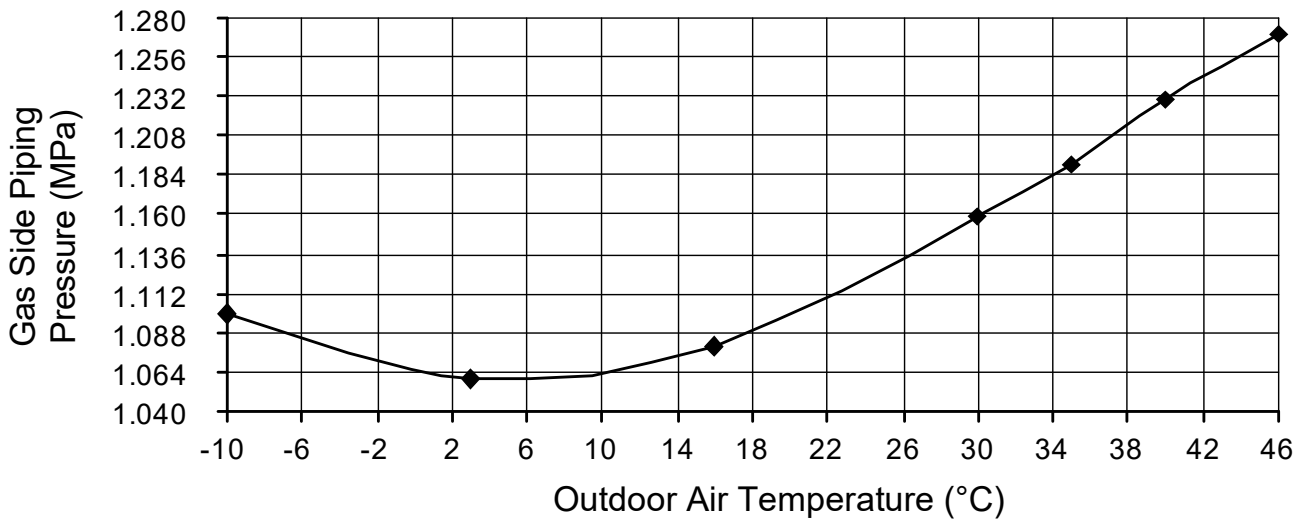
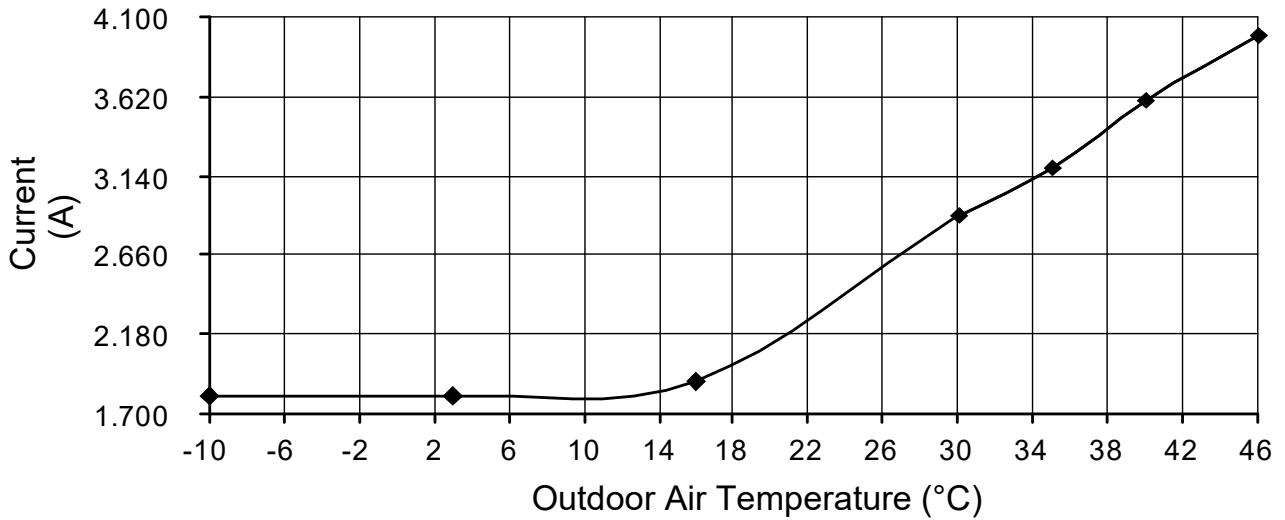
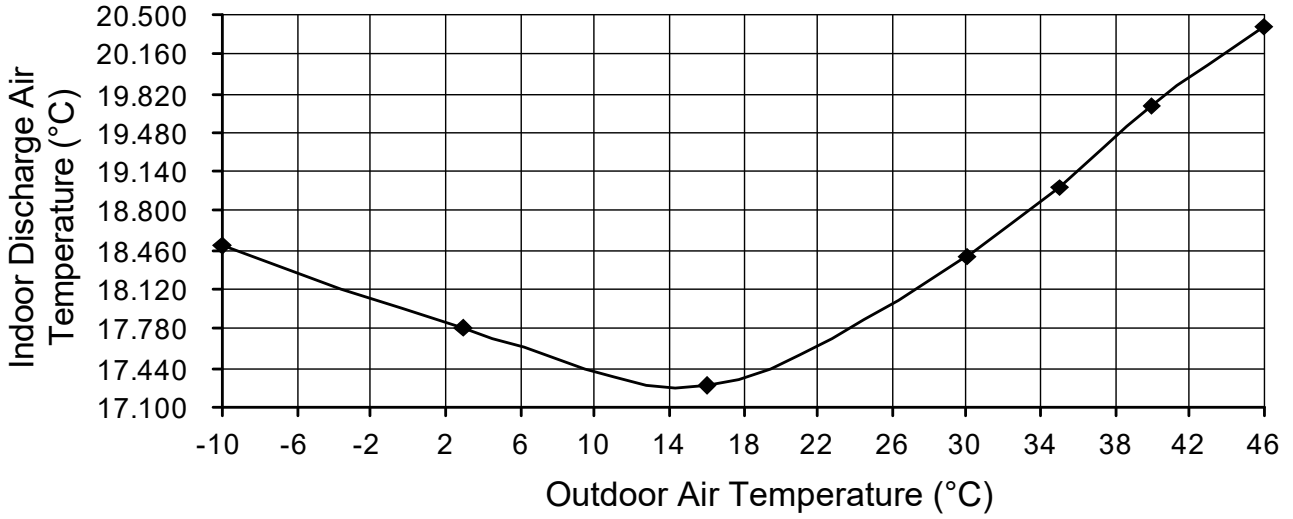

- Heating Characteristic
- [Condition] Room temperature: 20°C (DBT), 12°C (WBT)  
 Operation condition: High fan speed  
 Piping length: 5.0 m  
 Voltage: 230V, 50Hz

A) Indoor unit capacity: Heating (1.6), CS-MTZ16TKEW

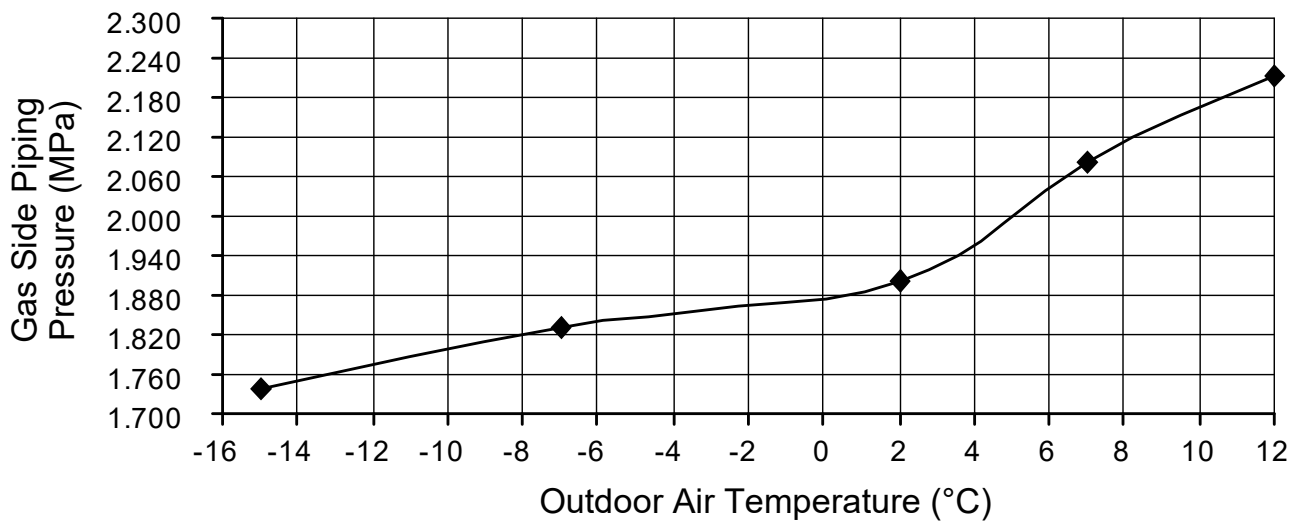
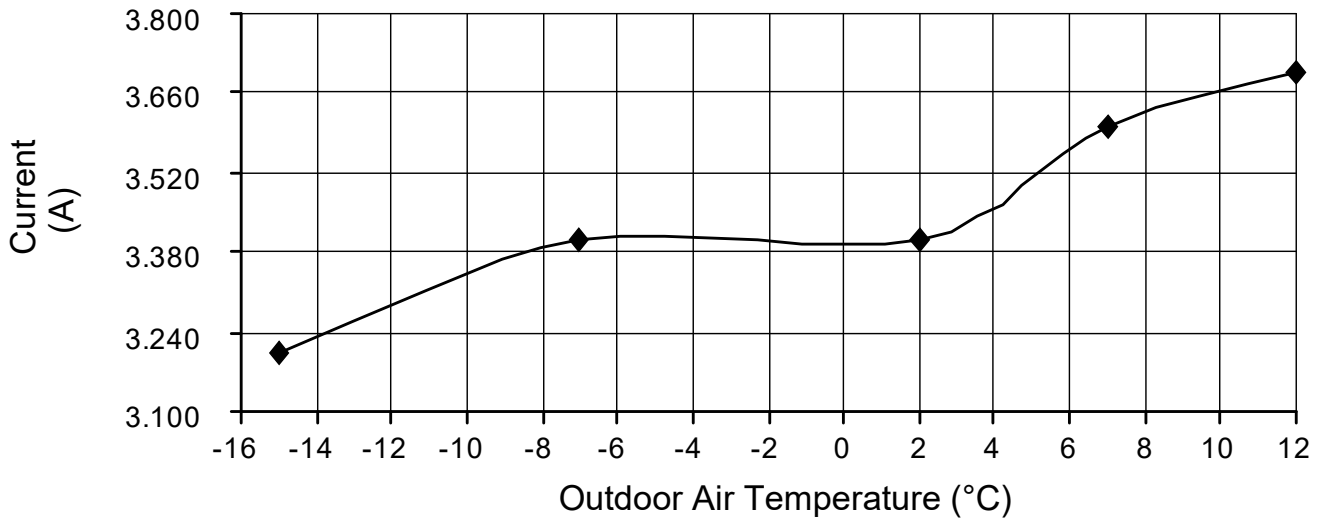
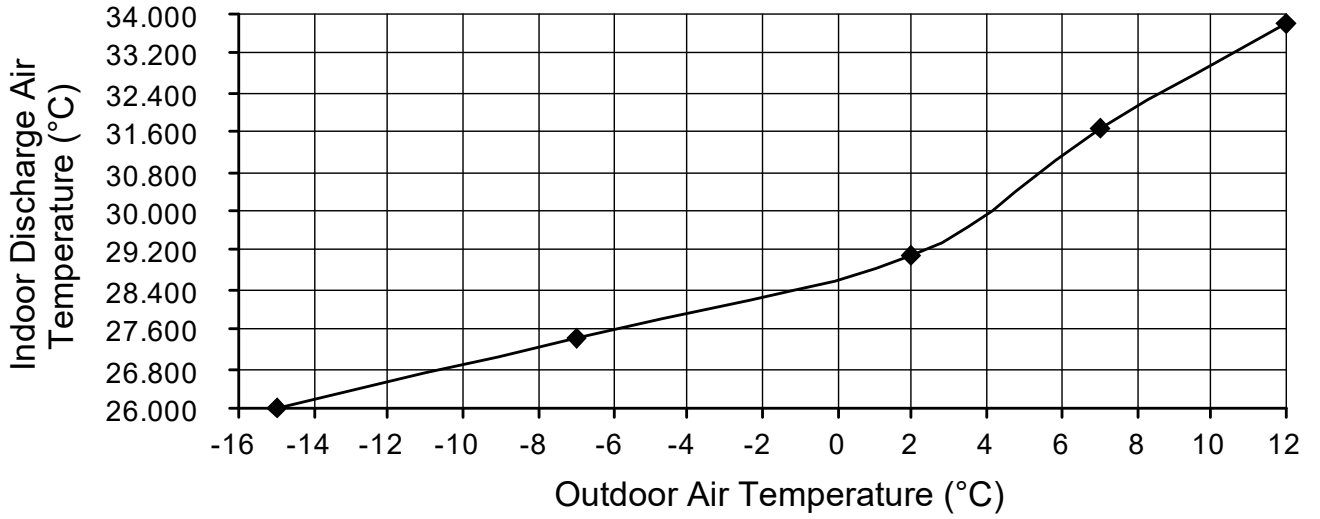

- Heating Characteristic
- [Condition] Room temperature: 20°C (DBT), 12°C (WBT)  
 Operation condition: High fan speed  
 Piping length: 5.0 m  
 Voltage: 230V, 50Hz

B) Indoor unit capacity: Heating (2.0), CS-TZ20TKEW

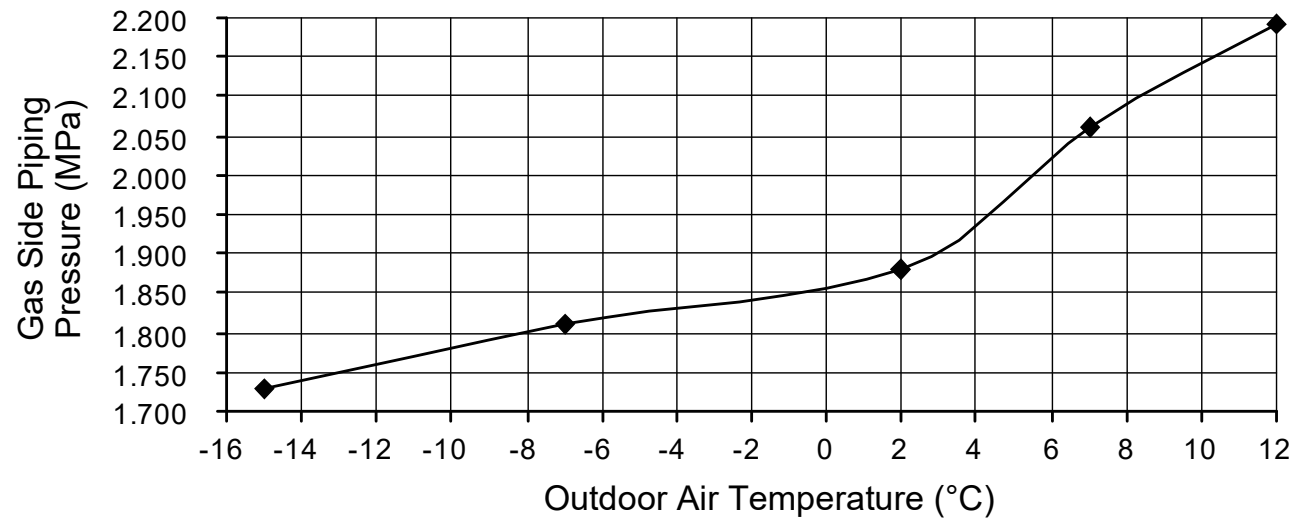
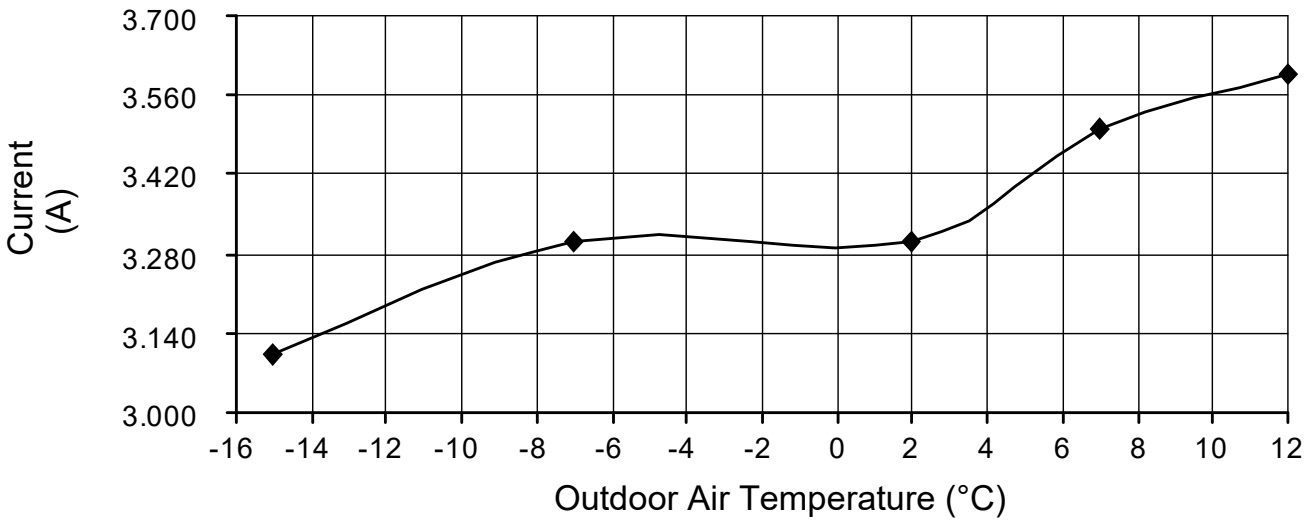
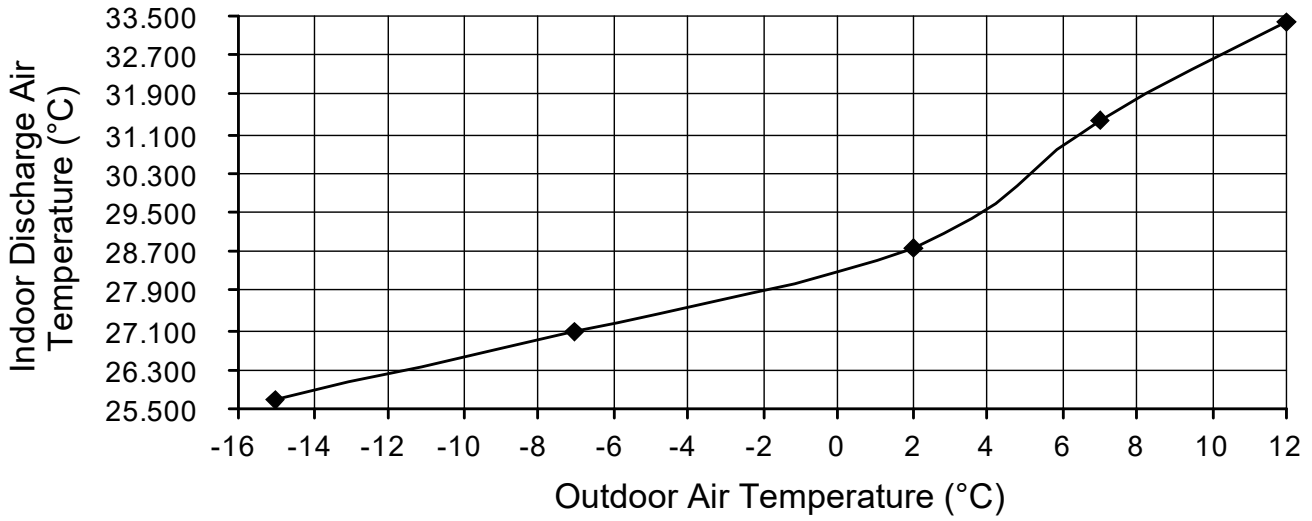

- Heating Characteristic
- [Condition] Room temperature: 20°C (DBT), 12°C (WBT)  
 Operation condition: High fan speed  
 Piping length: 5.0 m  
 Voltage: 230V, 50Hz

C) Indoor unit capacity: Heating (2.5), CS-TZ25TKEW

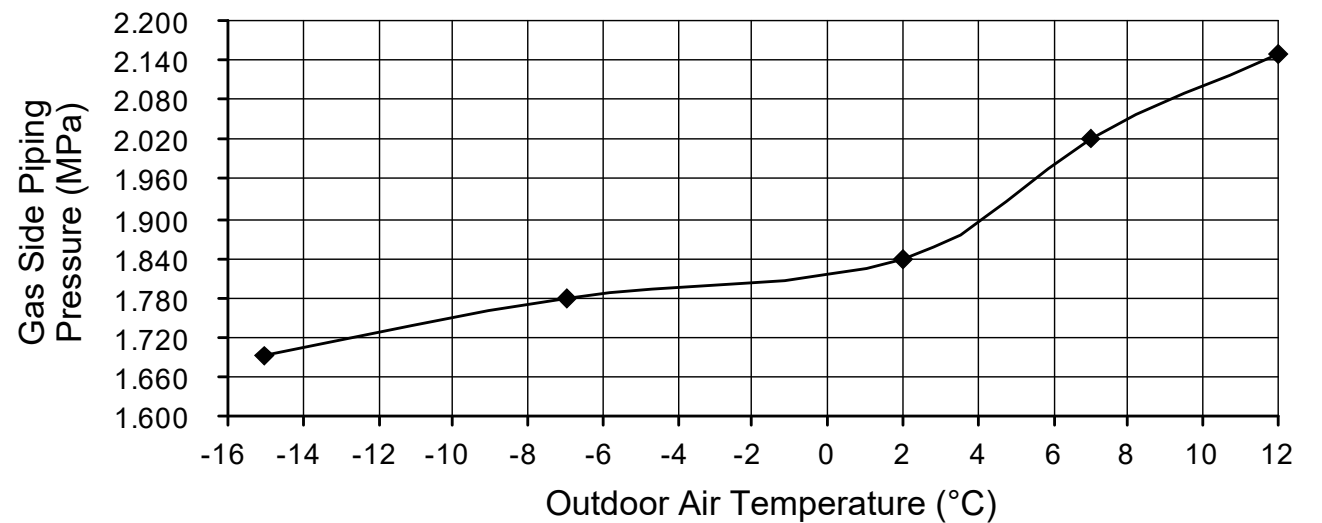
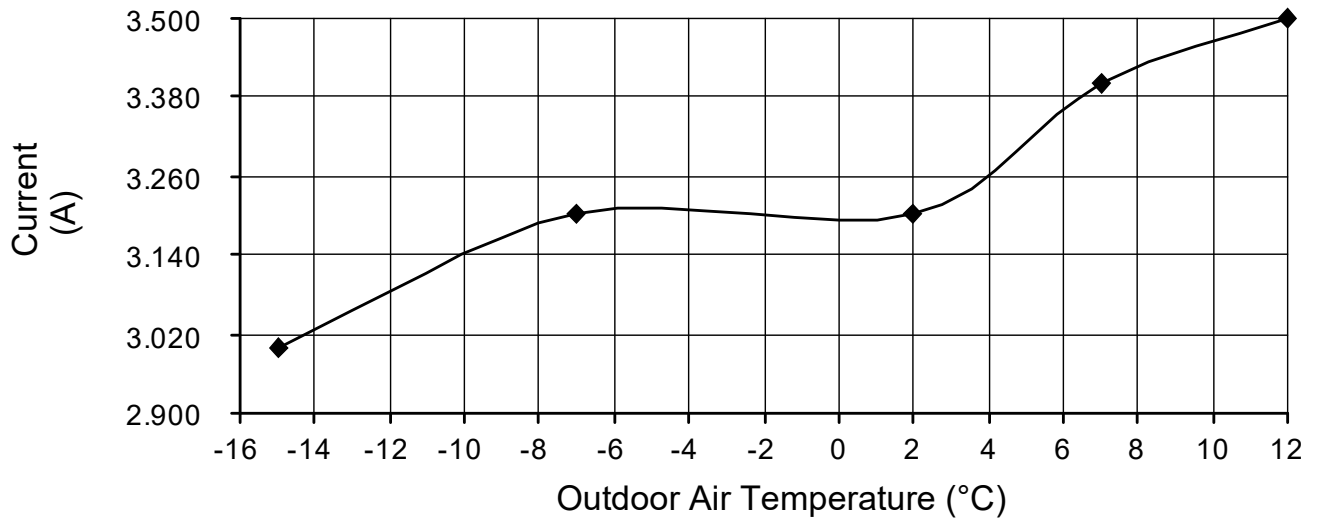
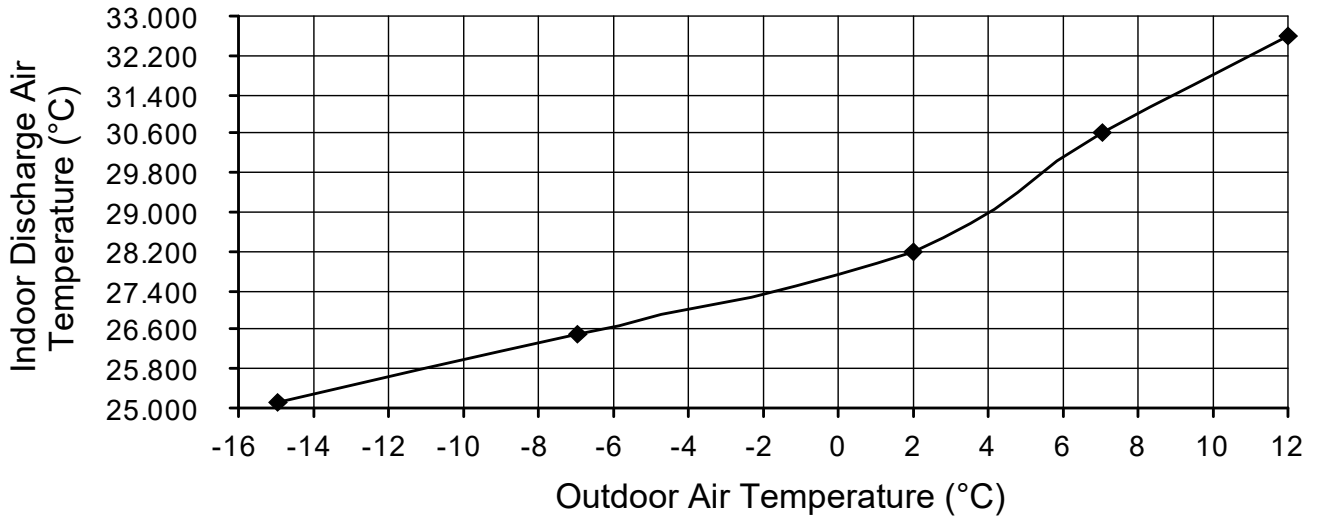

- Heating Characteristic
- [Condition] Room temperature: 20°C (DBT), 12°C (WBT)  
 Operation condition: High fan speed  
 Piping length: 5.0 m  
 Voltage: 230V, 50Hz

D) Indoor unit capacity: Heating (3.5), CS-TZ35TKEW

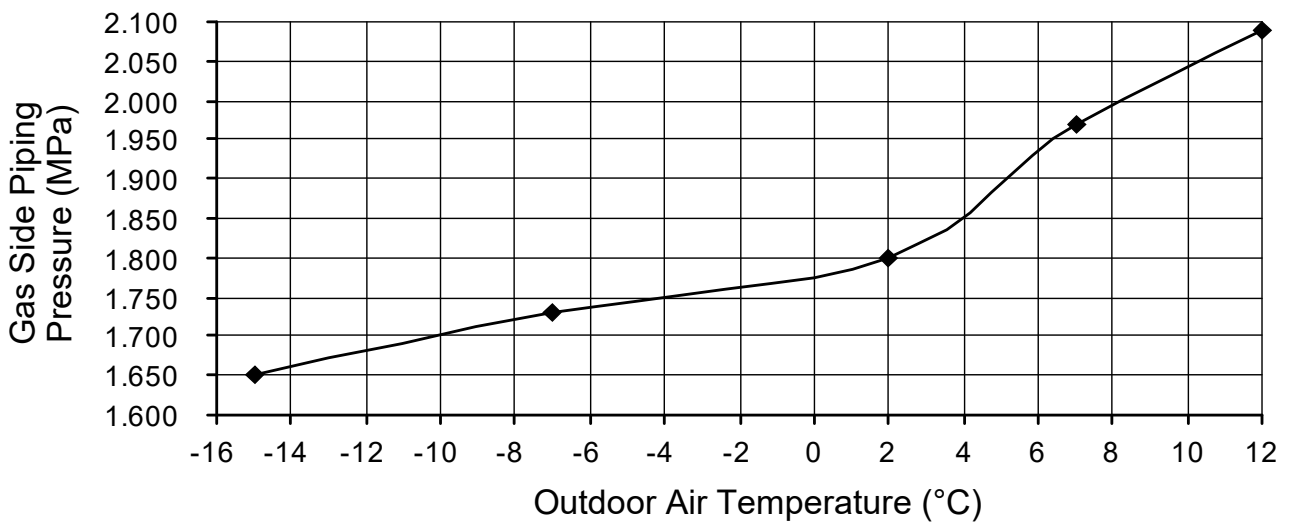
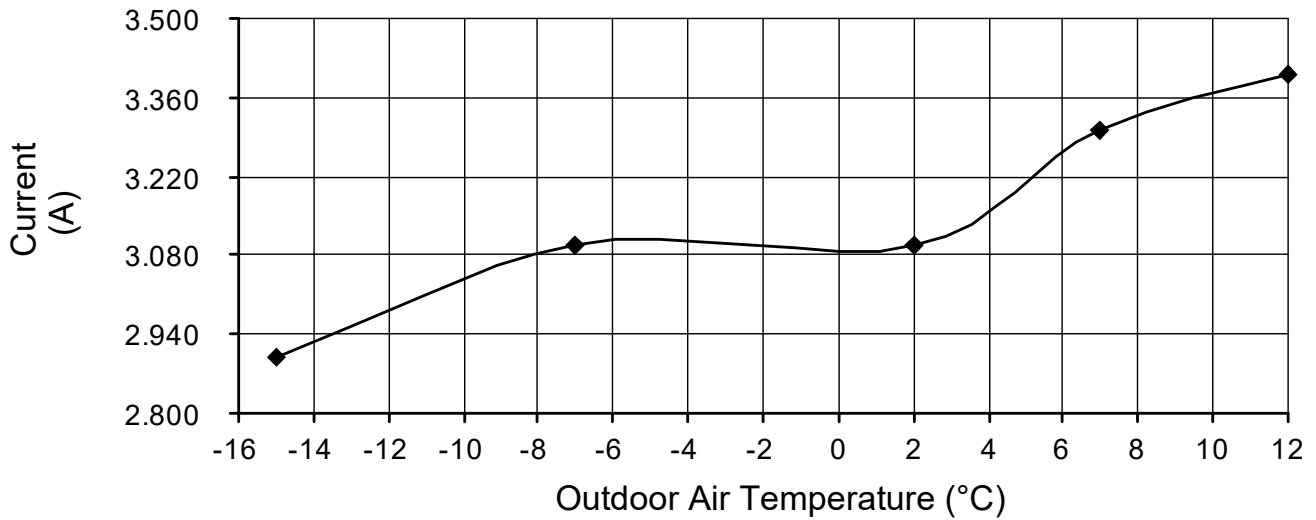
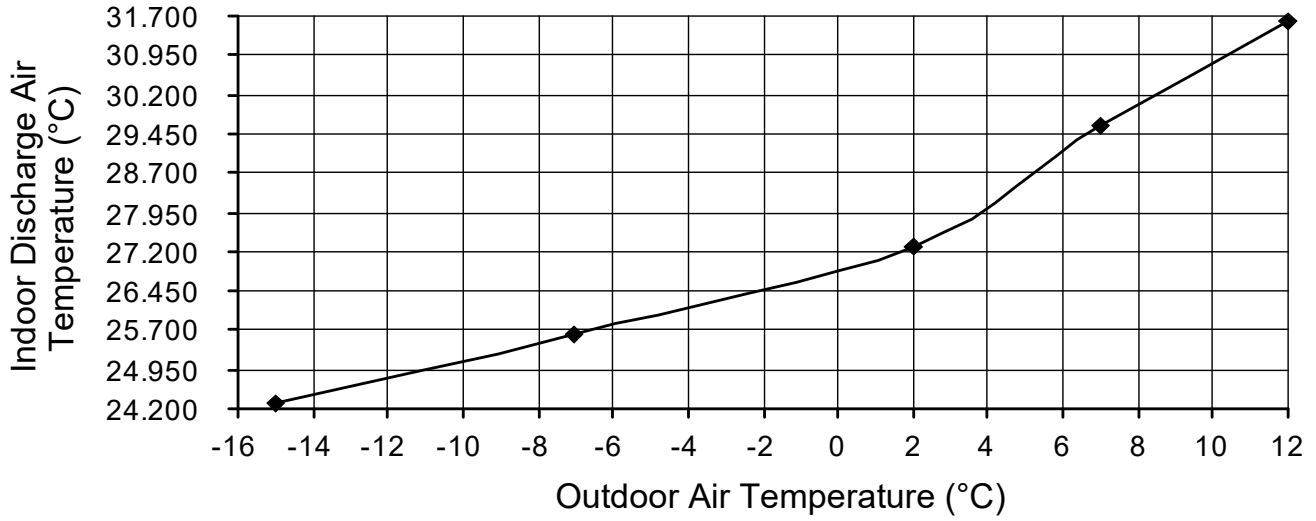



- Heating Characteristic
- [Condition] Room temperature: 20°C (DBT), 12°C (WBT)  
 Operation condition: High fan speed  
 Piping length: 5.0 m  
 Voltage: 230V, 50Hz

E) Indoor unit capacity: Heating (4.2), CS-TZ42TKEW

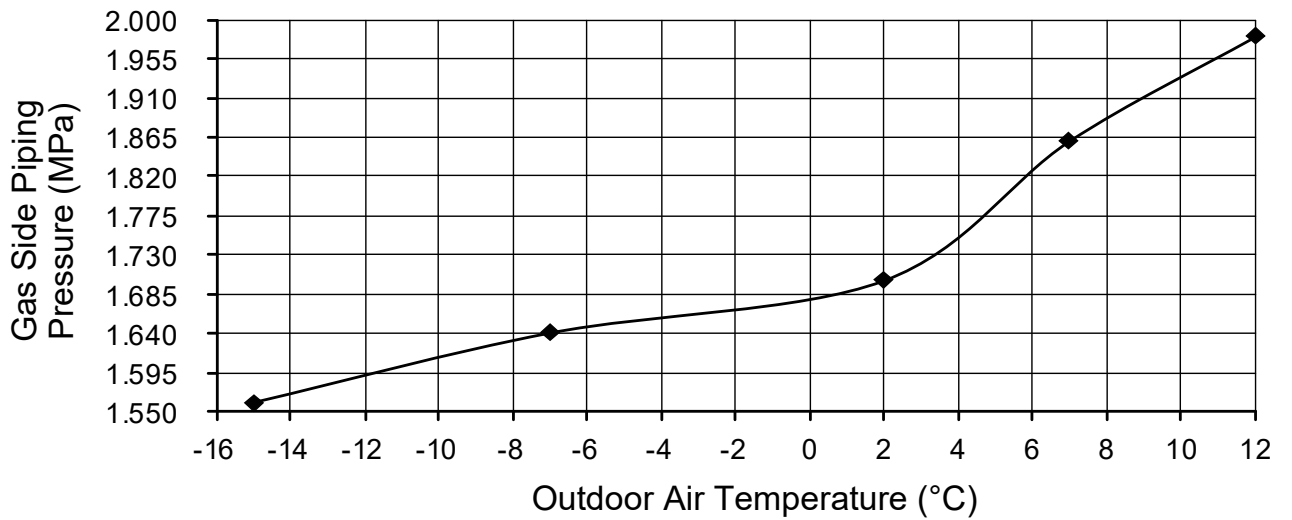
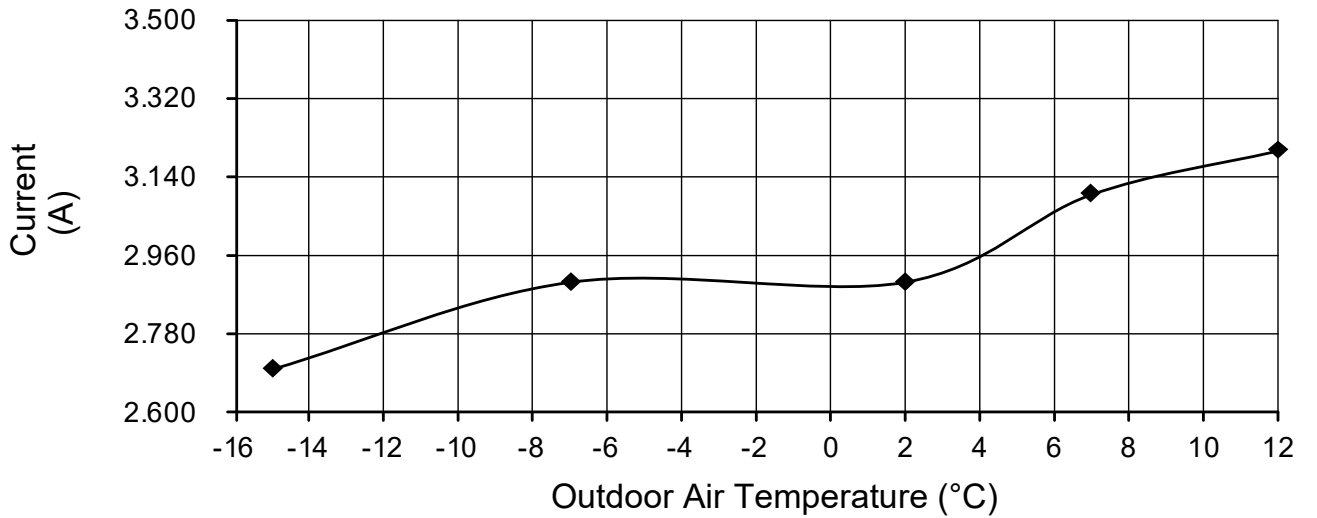
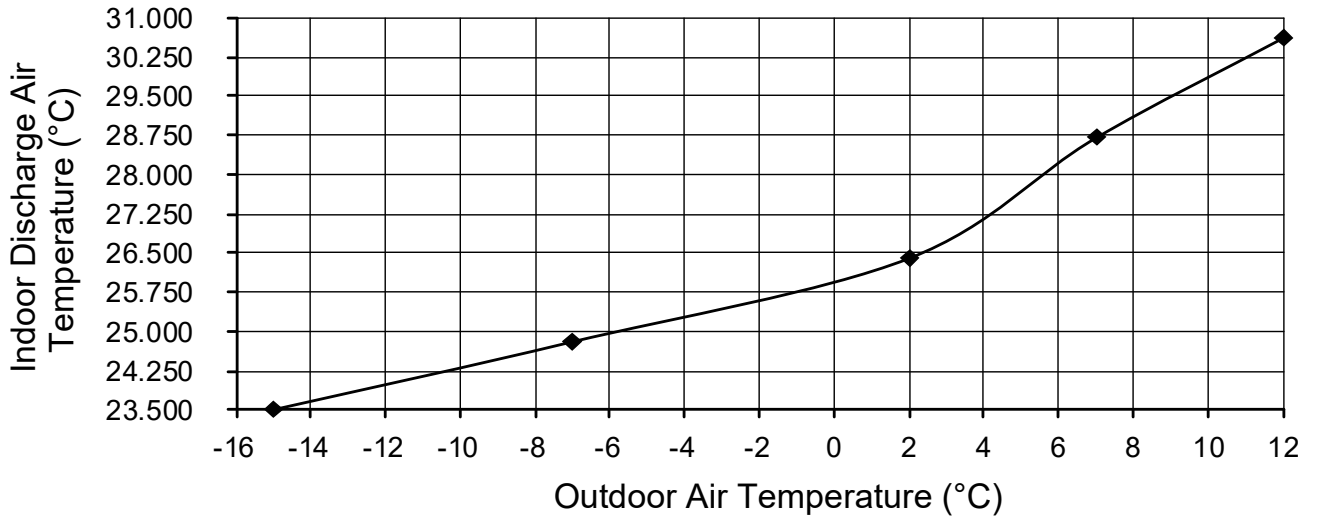

- Heating Characteristic

[Condition] Room temperature: 20°C (DBT), 12°C (WBT)

Operation condition: High fan speed

Piping length: 5.0 m

Voltage: 230V, 50Hz

F) Indoor unit capacity: Heating (5.0), CS-TZ50TKEW

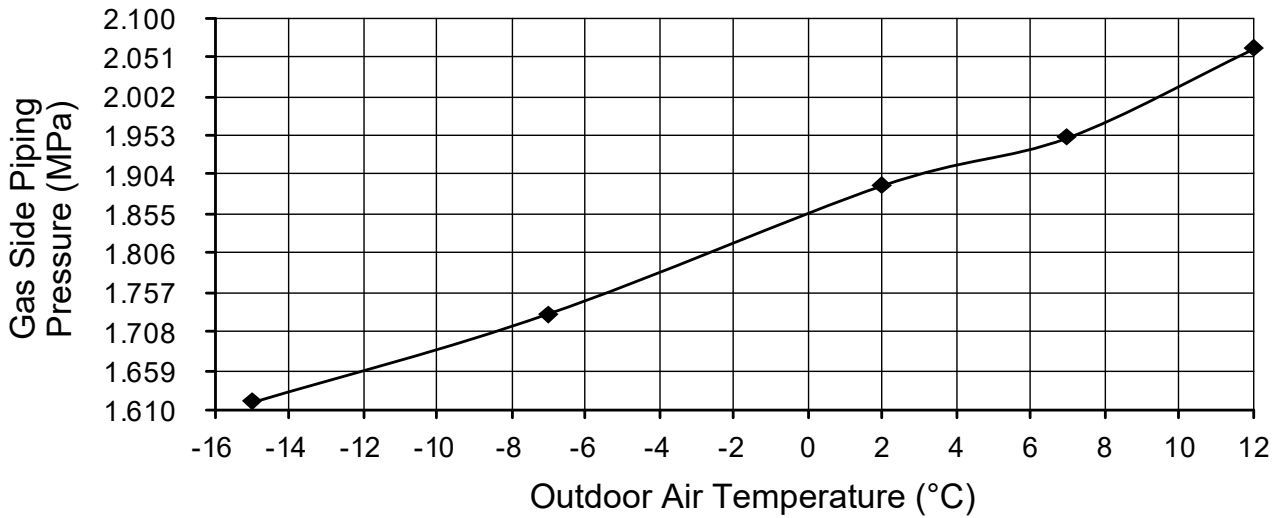
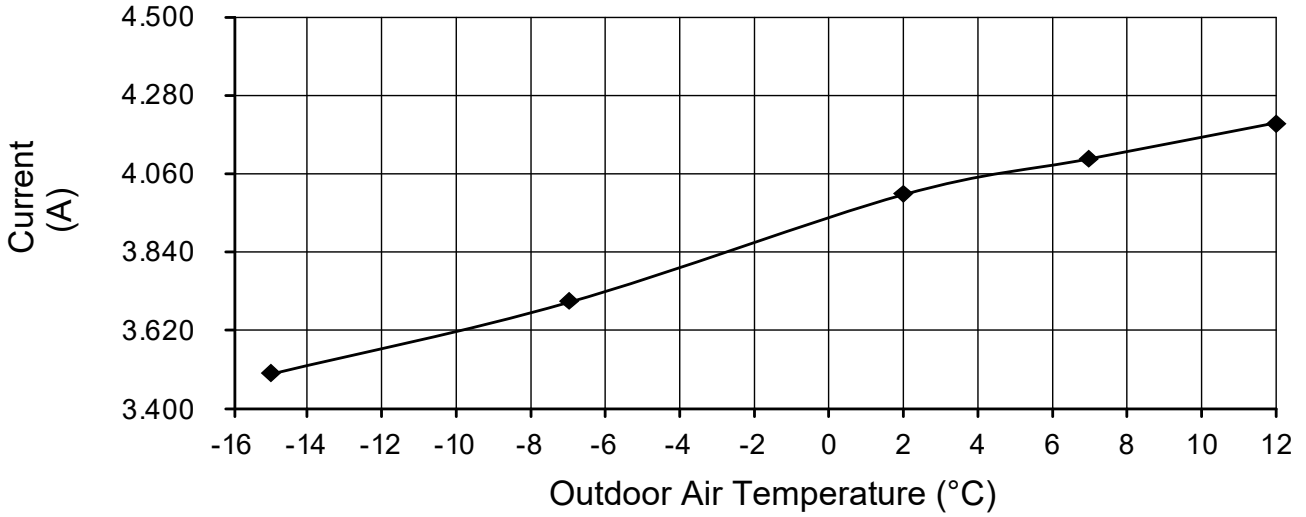
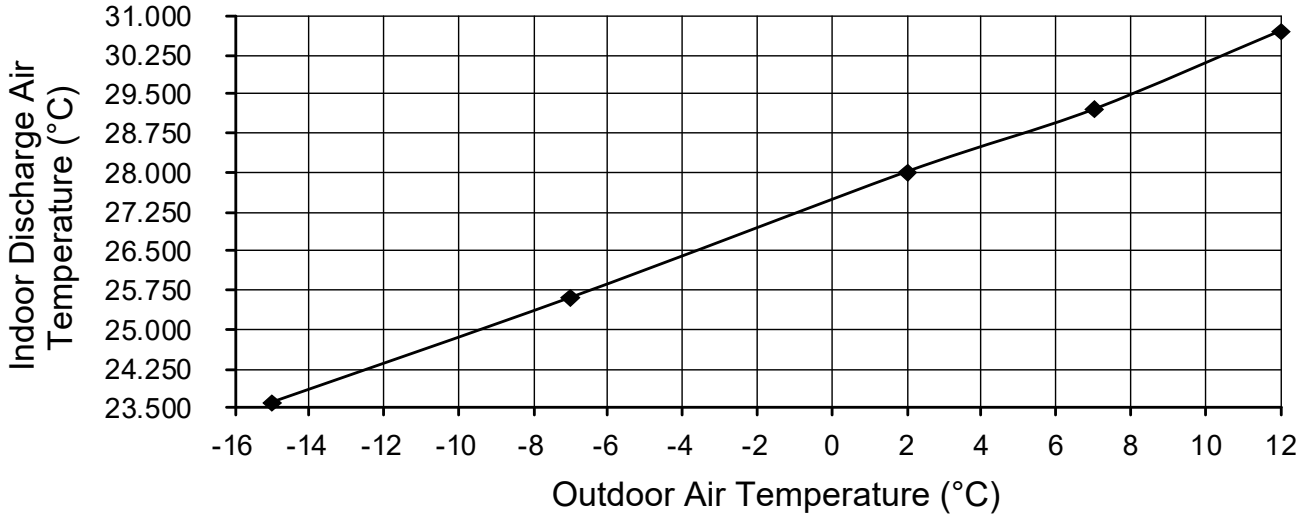

## 19.2.2 Two Indoor Unit Operation

- Cooling Characteristic

[Condition] Room temperature: 27°C (DBT), 19°C (WBT)

Operation condition: High fan speed

Piping length: 5.0 m

Voltage: 230V, 50Hz

A) Indoor unit capacity: Cooling (1.6 + 1.6), CS-MTZ16TKE + CS-MTZ16TKE

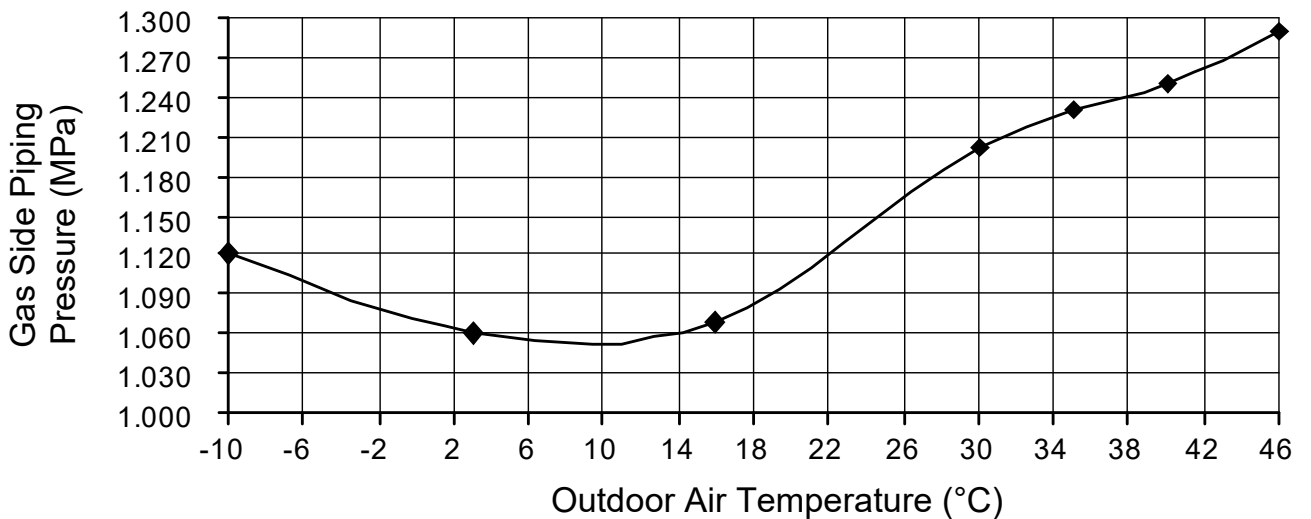
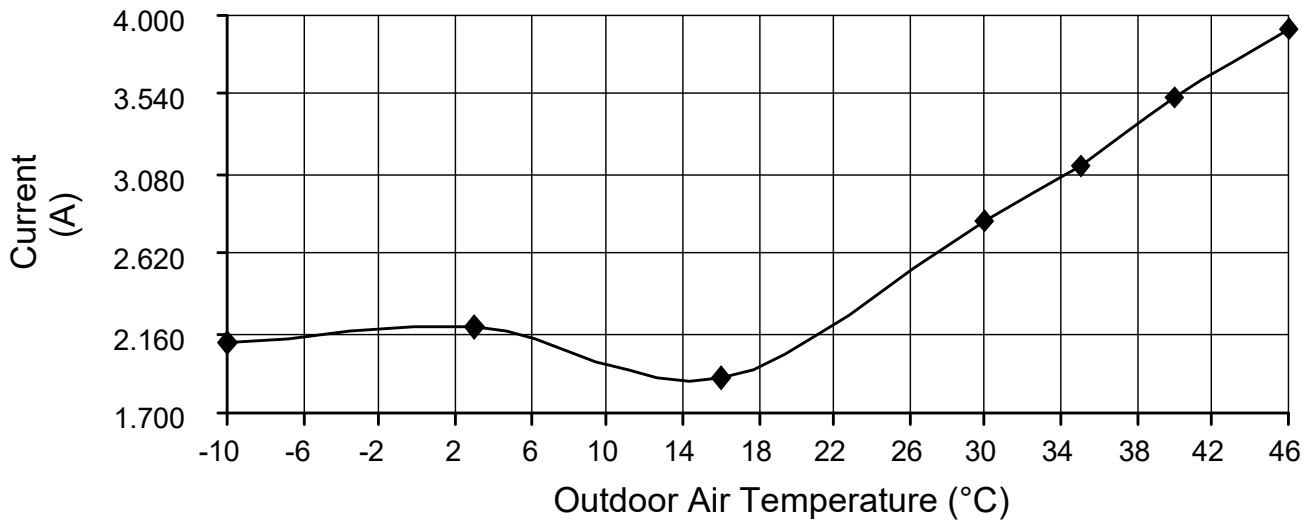
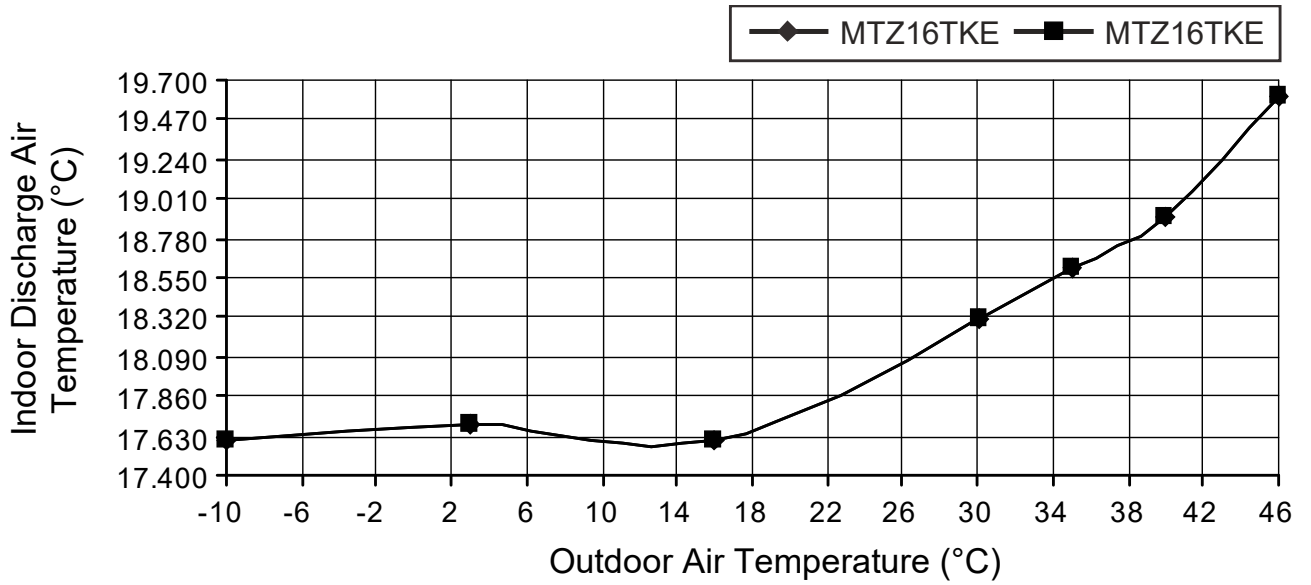

- Cooling Characteristic

[Condition] Room temperature: 27°C (DBT), 19°C (WBT)

Operation condition: High fan speed

Piping length: 5.0 m

Voltage: 230V, 50Hz

B) Indoor unit capacity: Cooling (2.5 + 2.5), CS-TZ25TKEW + CS-TZ25TKEW

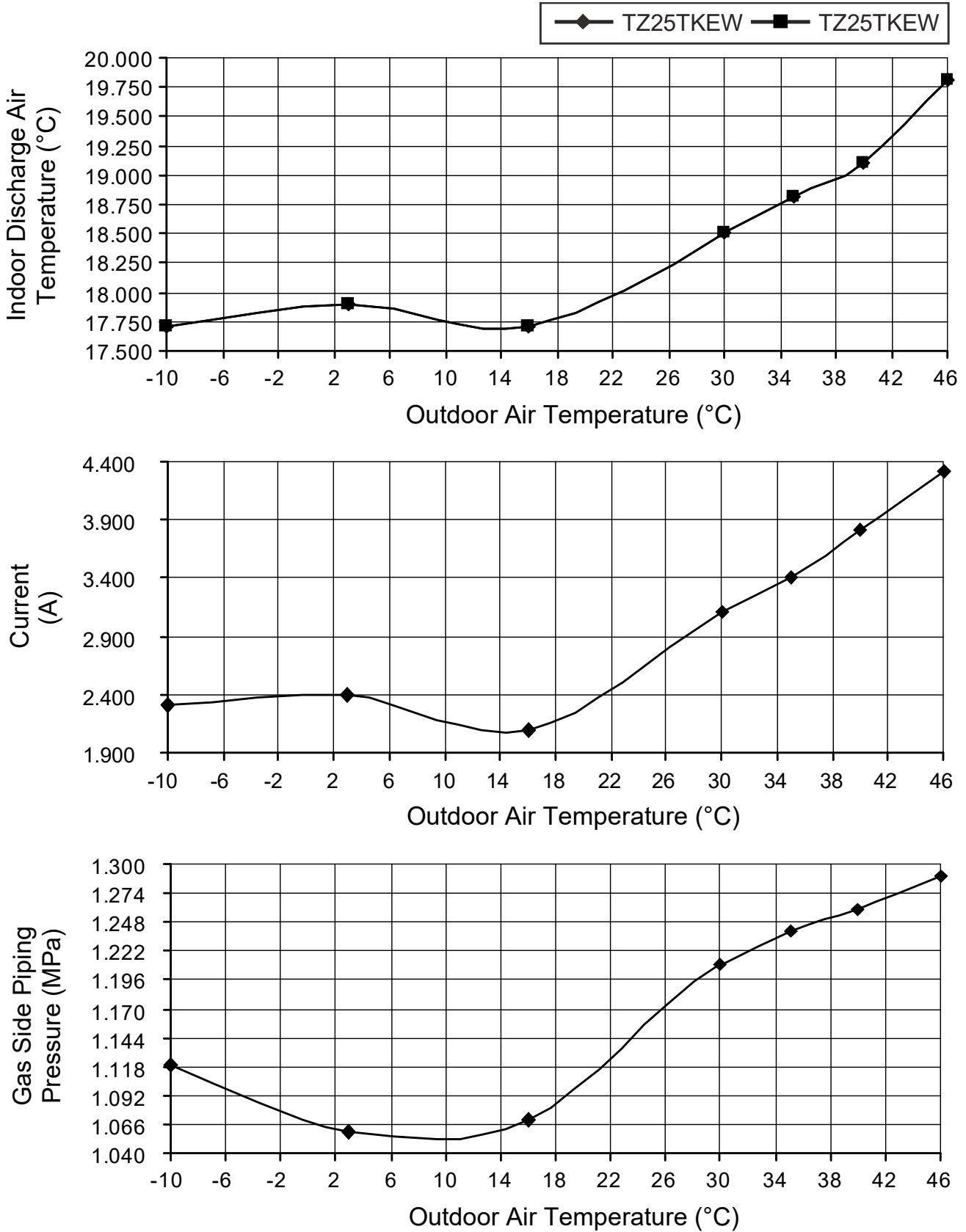

- Cooling Characteristic
- [Condition] Room temperature: 27°C (DBT), 19°C (WBT)
- Operation condition: High fan speed
- Piping length: 5.0 m
- Voltage: 230V, 50Hz

C) Indoor unit capacity: Cooling (3.5 + 3.5), CS-TZ35TKEW + CS-TZ35TKEW

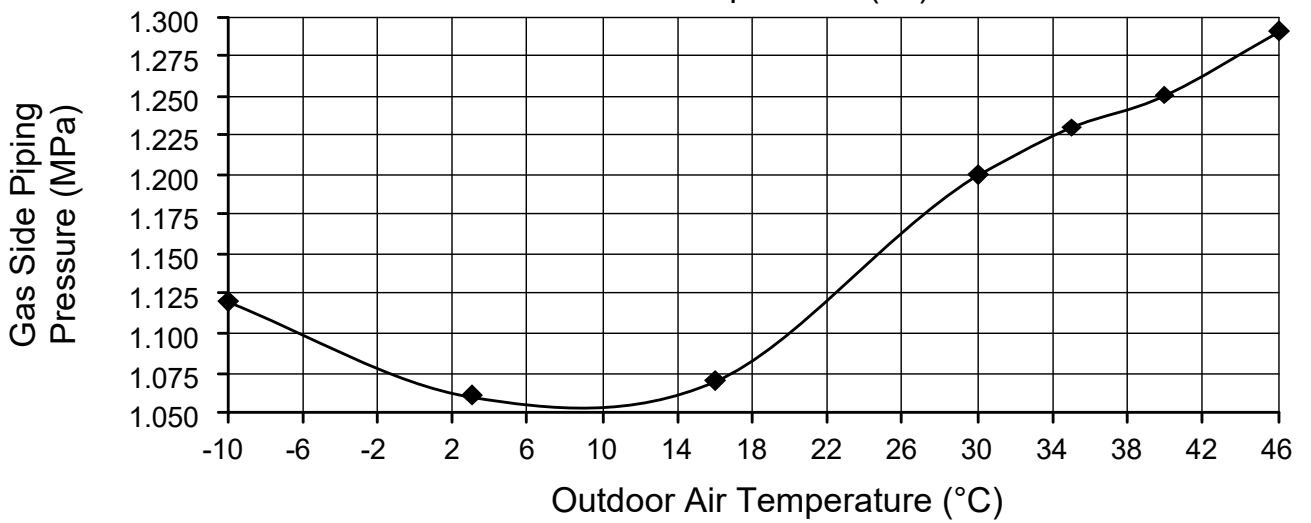
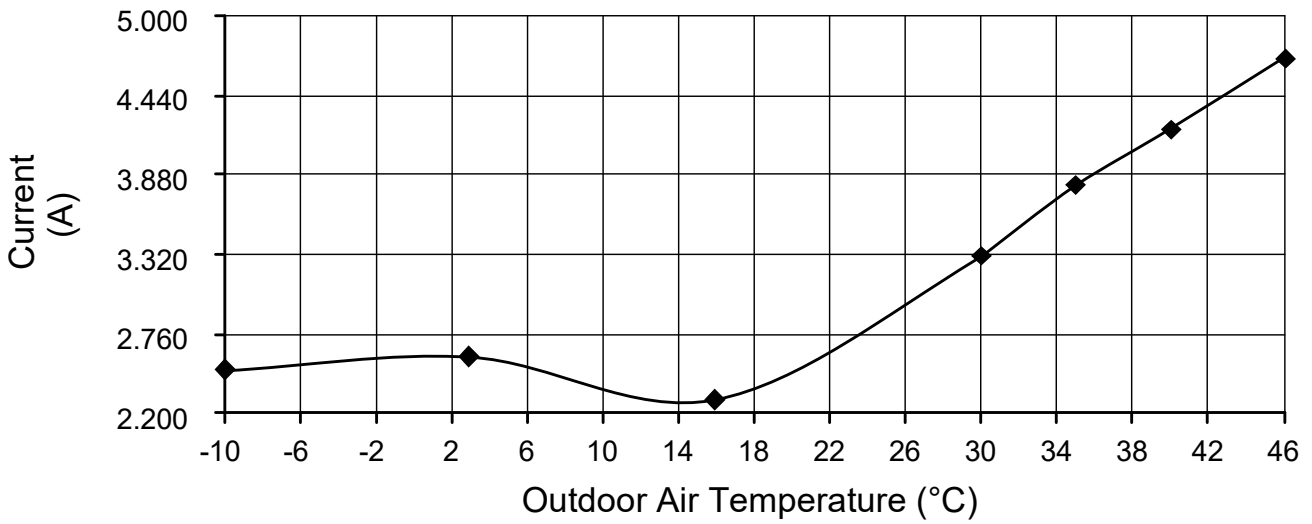
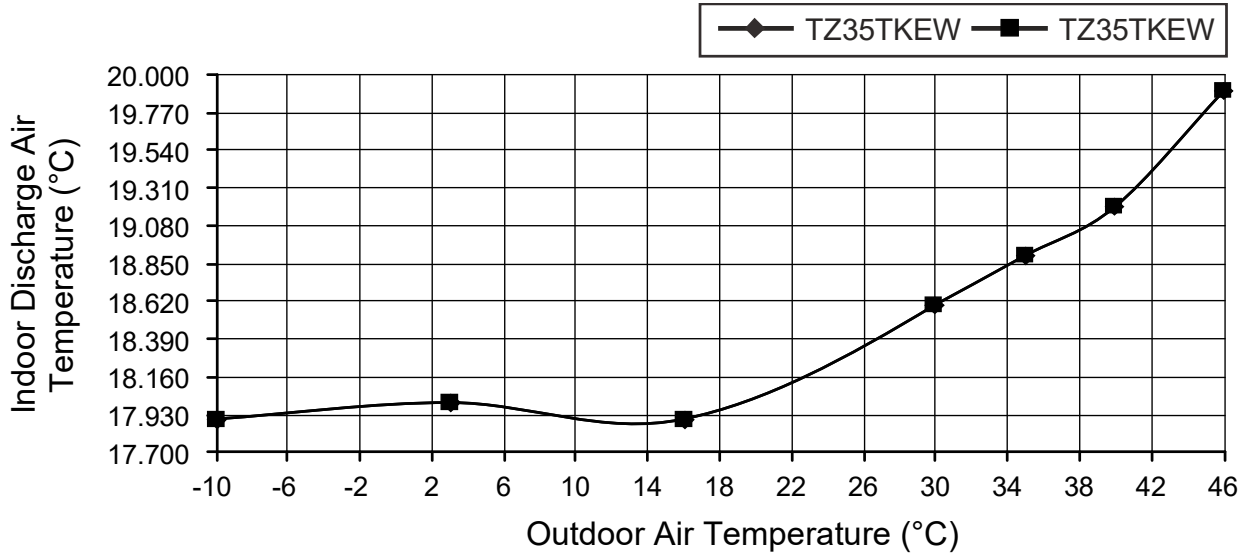

- Cooling Characteristic

[Condition] Room temperature: 27°C (DBT), 19°C (WBT)

Operation condition: High fan speed

Piping length: 5.0 m

Voltage: 230V, 50Hz

D) Indoor unit capacity: Cooling (2.5 + 5.0), CS-TZ25TKEW + CS-TZ50TKEW

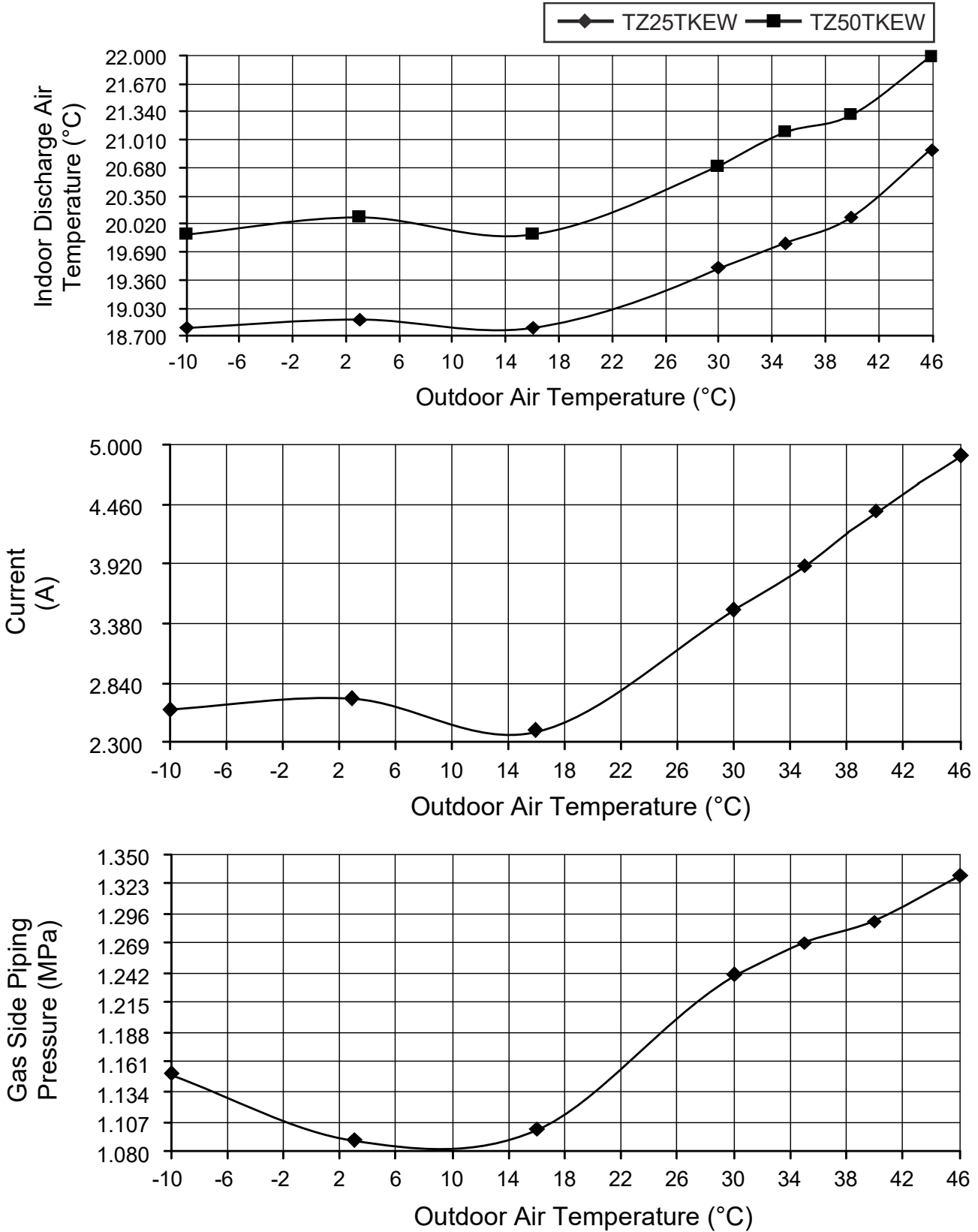

- Heating Characteristic
- [Condition] Room temperature: 20°C (DBT), 12°C (WBT)  
 Operation condition: High fan speed  
 Piping length: 5.0 m  
 Voltage: 230V, 50Hz

A) Indoor unit capacity: Heating (1.6 + 1.6), CS-MTZ16TKE + CS-MTZ16TKE

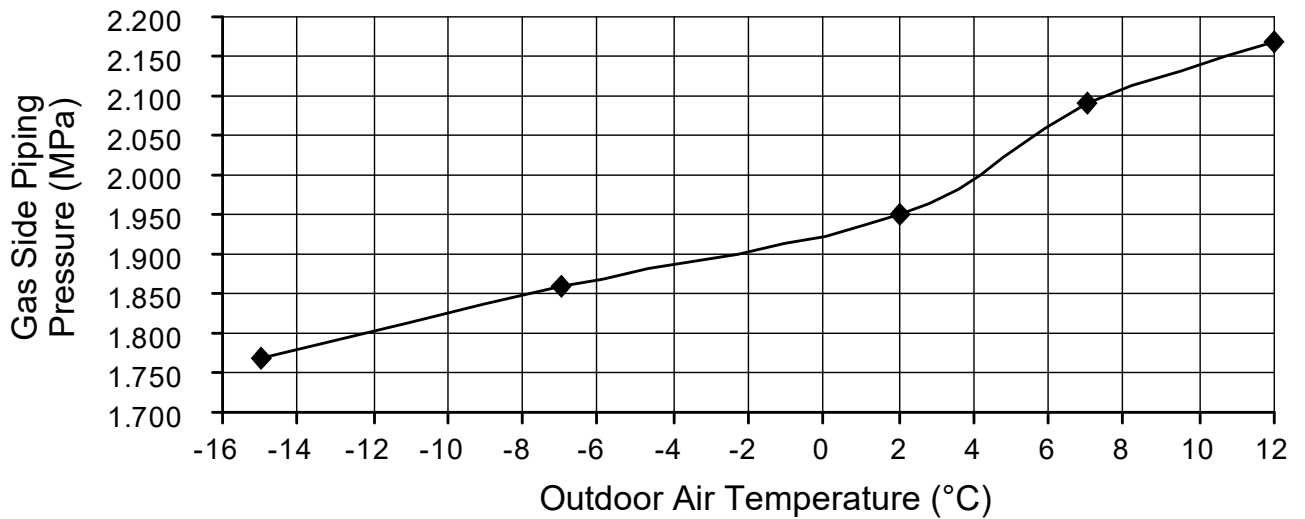
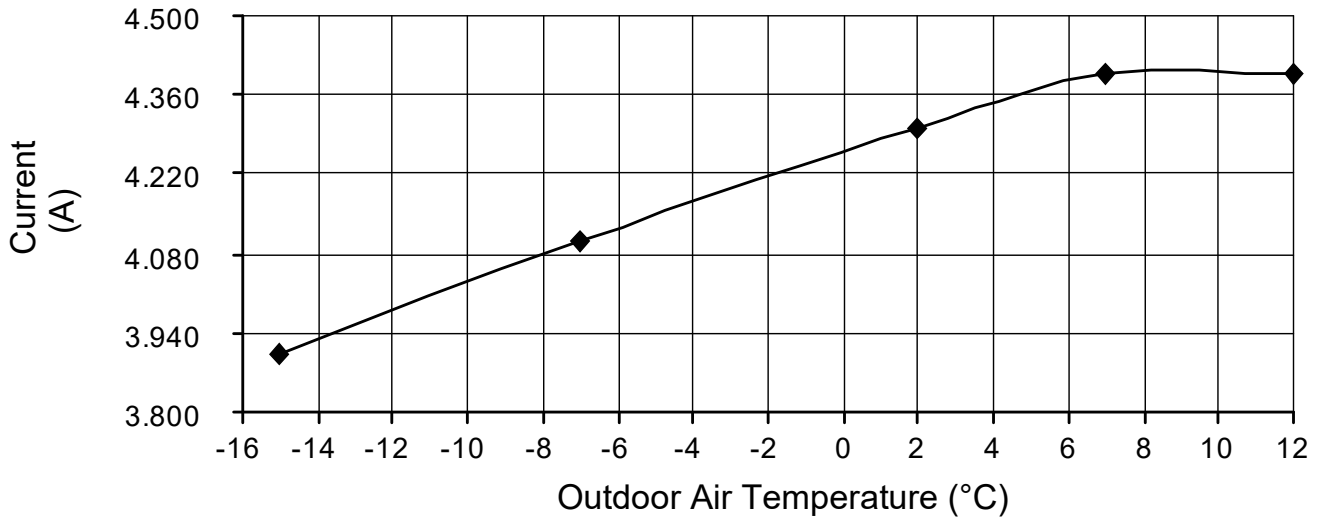
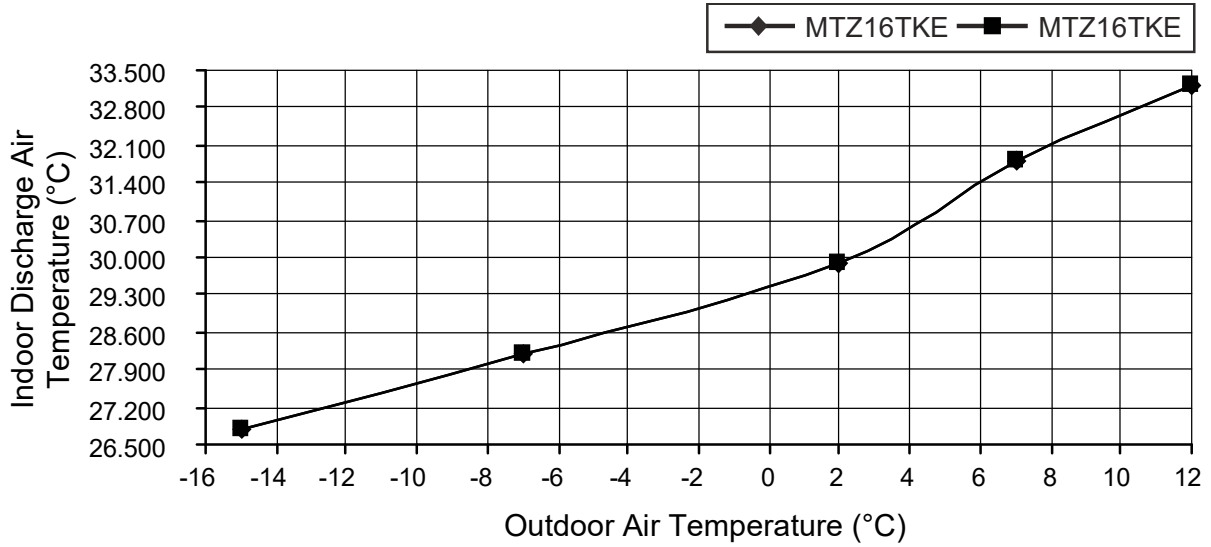

- Heating Characteristic

[Condition] Room temperature: 20°C (DBT), 12°C (WBT)

Operation condition: High fan speed

Piping length: 5.0 m

Voltage: 230V, 50Hz

B) Indoor unit capacity: Heating (2.5 + 2.5), CS-TZ25TKEW + CS-TZ25TKEW

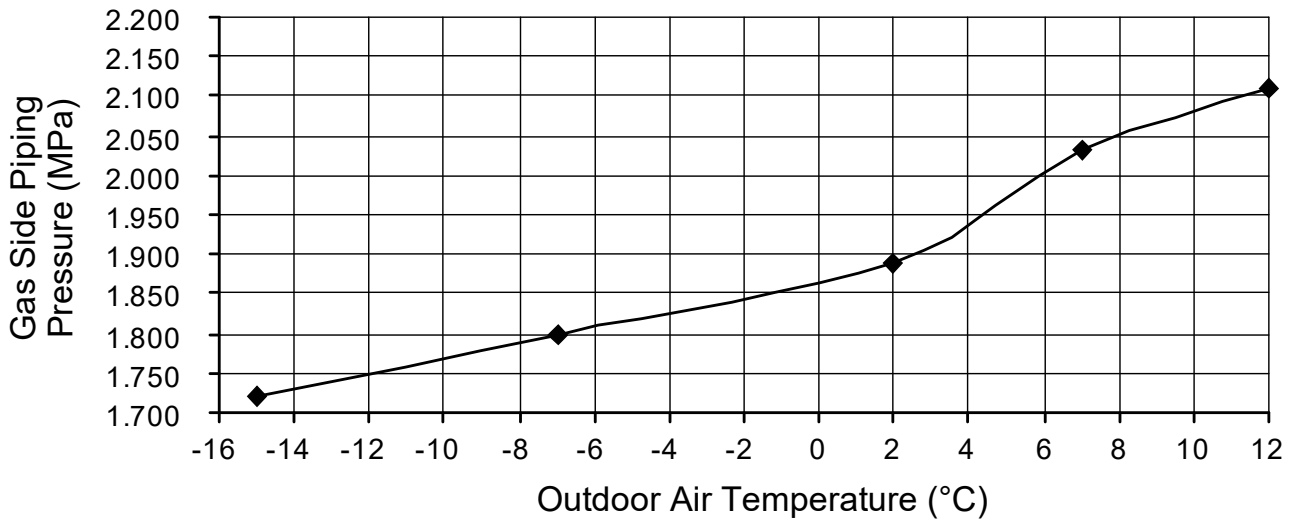
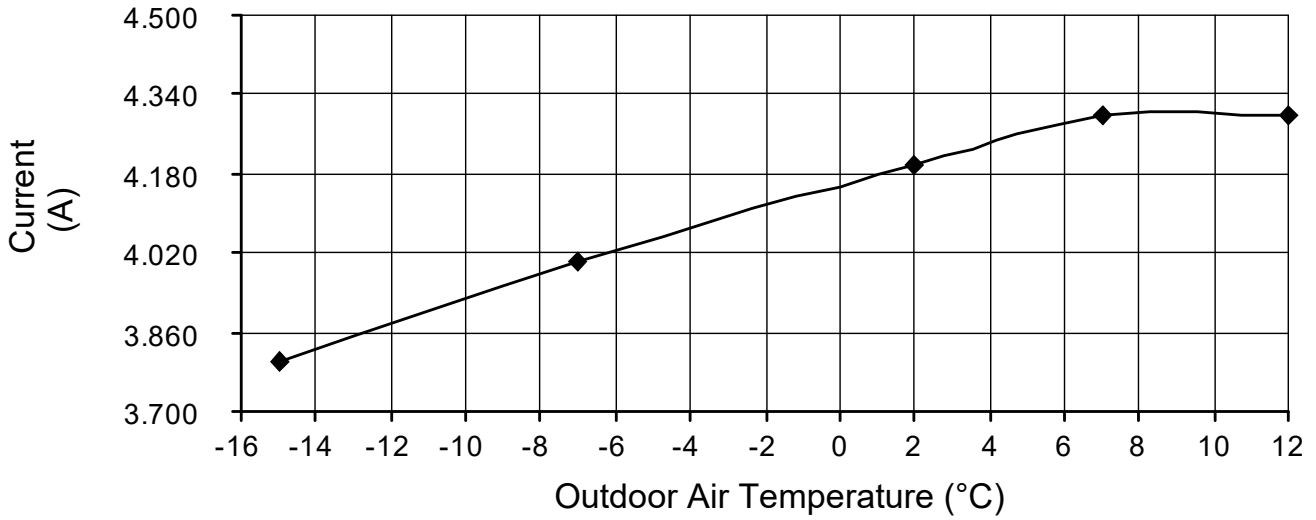
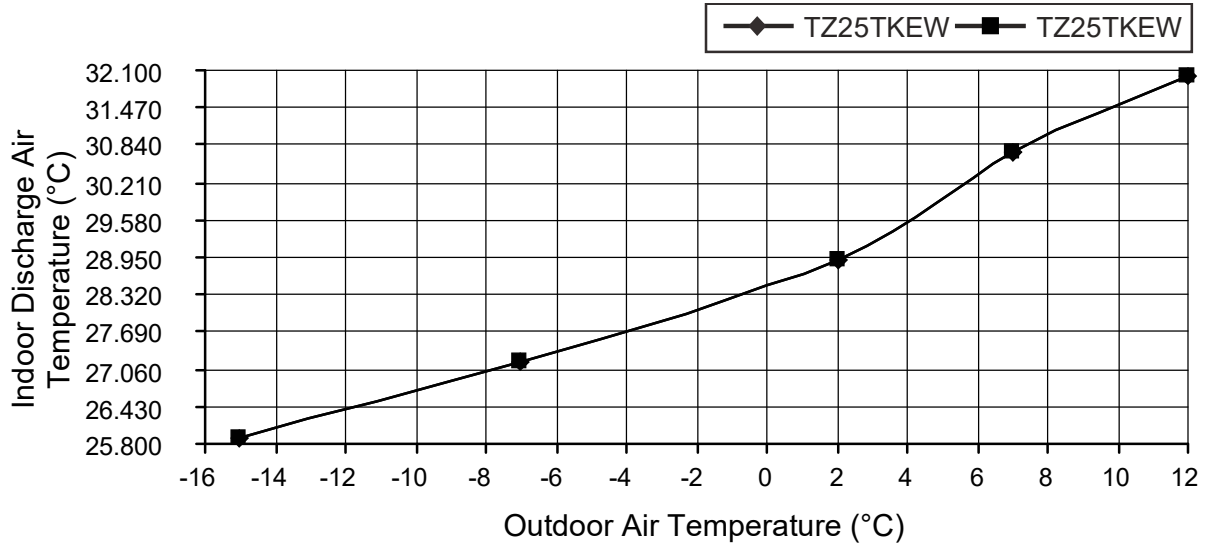



- Heating Characteristic  
 [Condition] Room temperature: 20°C (DBT), 12°C (WBT)  
 Operation condition: High fan speed  
 Piping length: 5.0 m  
 Voltage: 230V, 50Hz

C) Indoor unit capacity: Heating (3.5 + 3.5), CS-TZ35TKEW + CS-TZ35TKEW

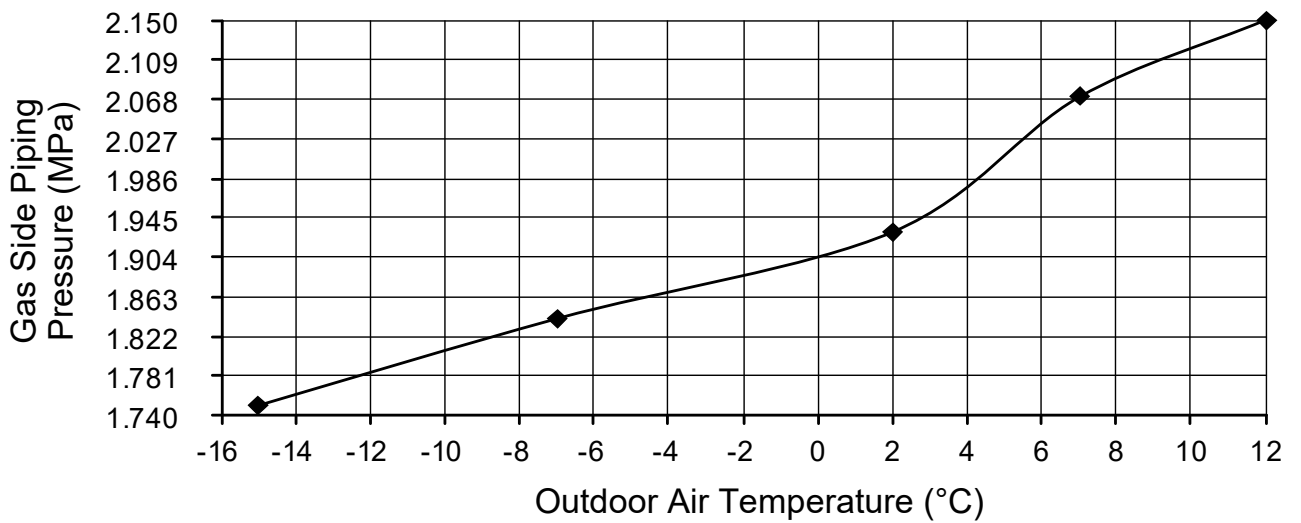
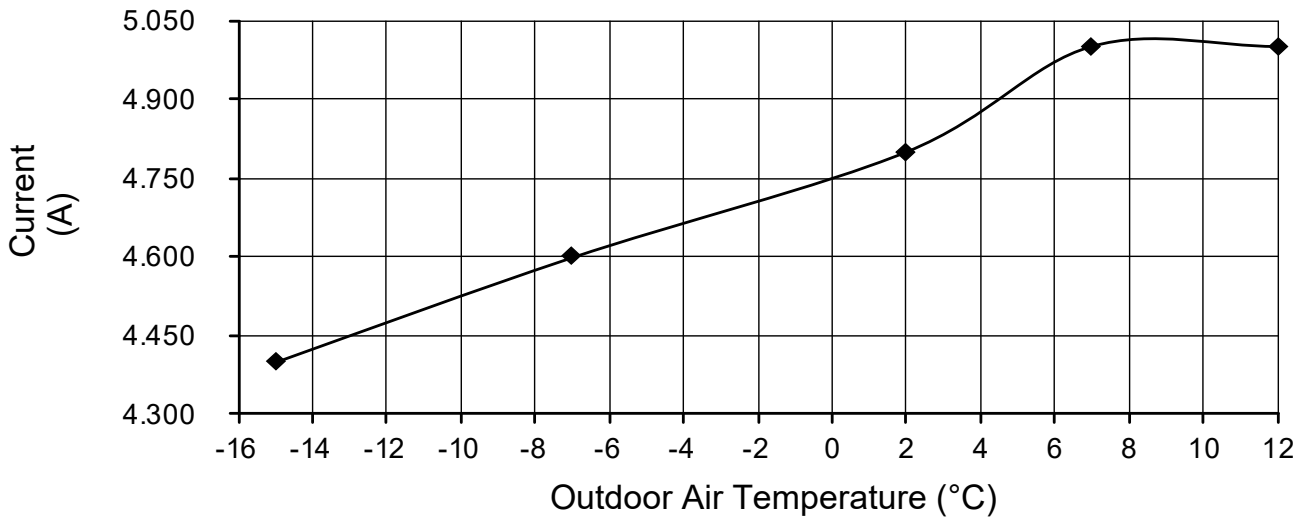
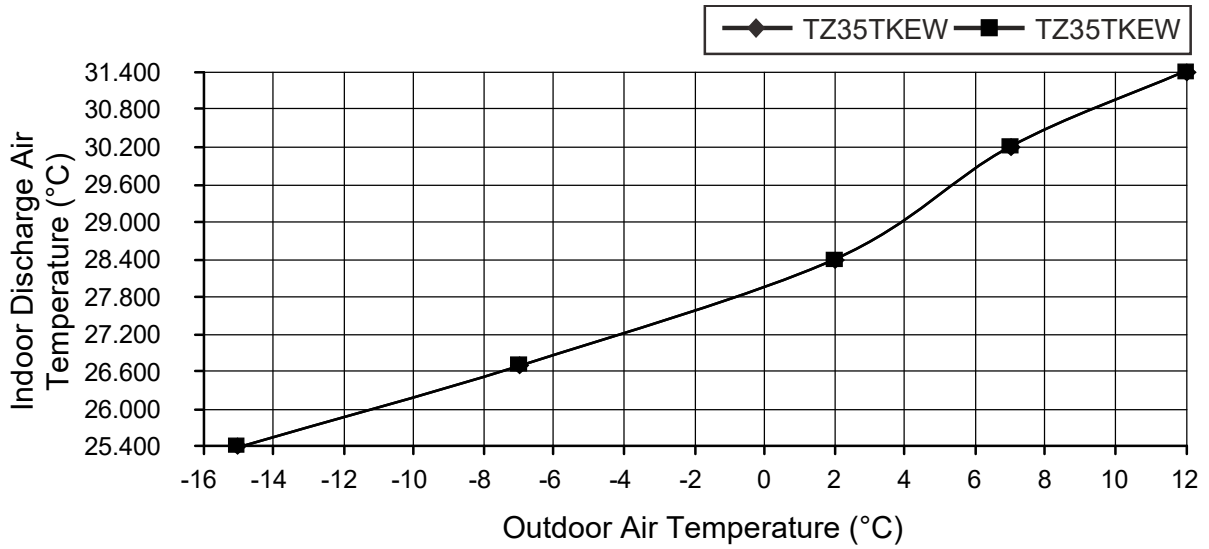

- Heating Characteristic

[Condition] Room temperature: 20°C (DBT), 12°C (WBT)

Operation condition: High fan speed

Piping length: 5.0 m

Voltage: 230V, 50Hz

D) Indoor unit capacity: Heating (2.5 + 5.0), CS-TZ25TKEW + CS-TZ50TKEW

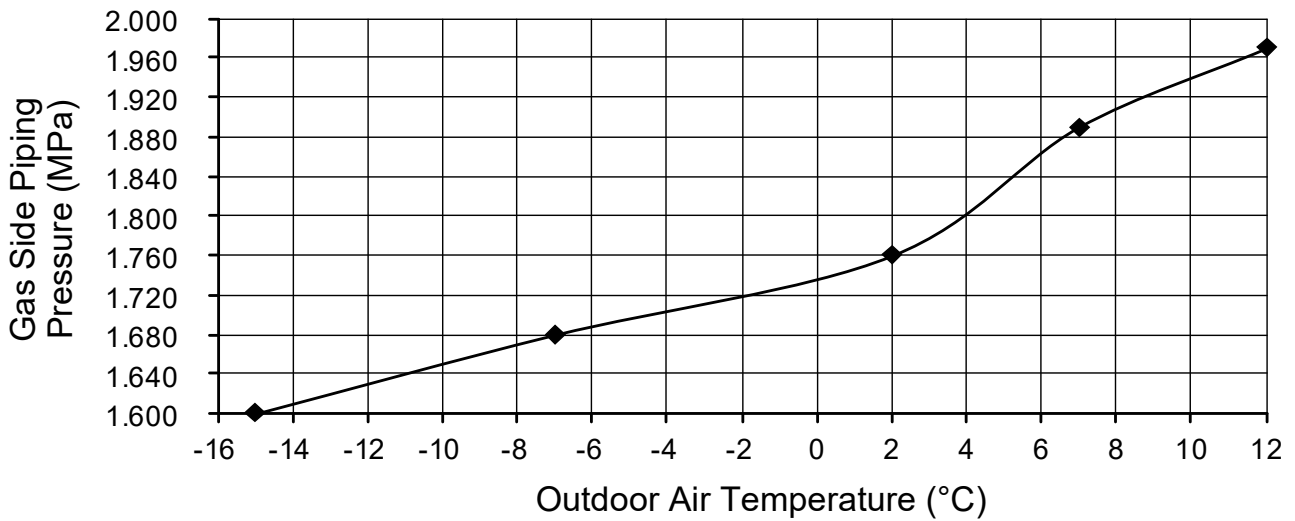
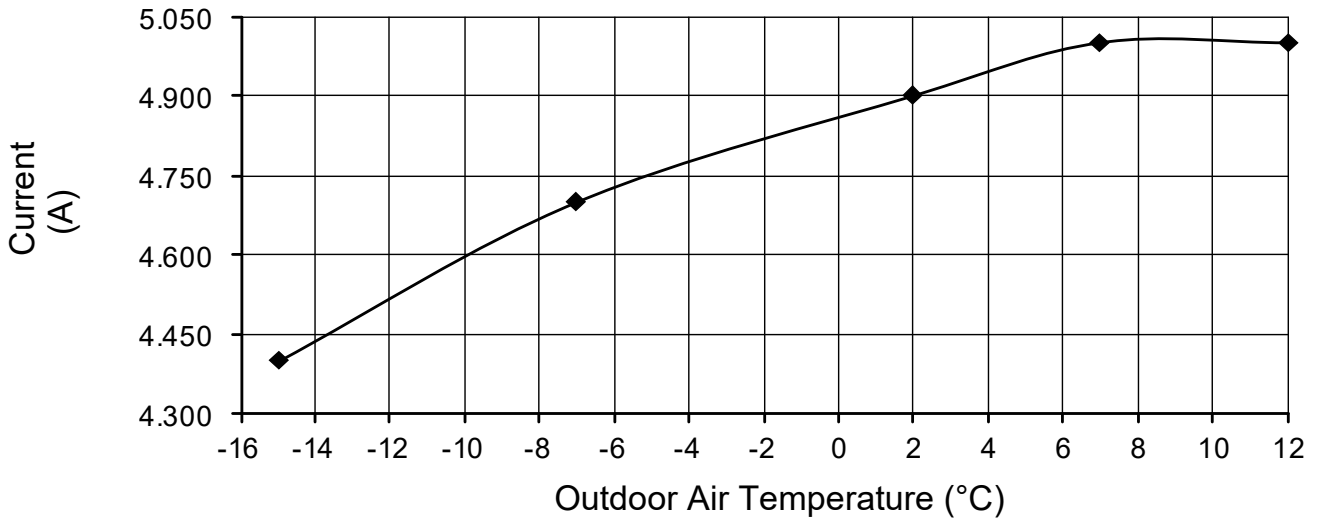
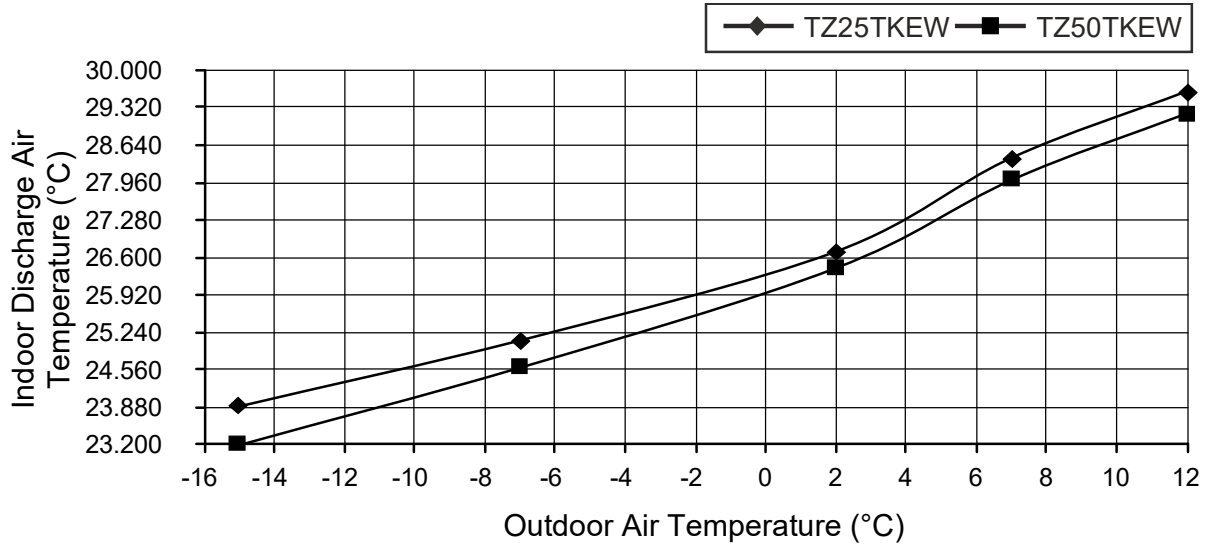

## 20. Exploded View and Replacement Parts List

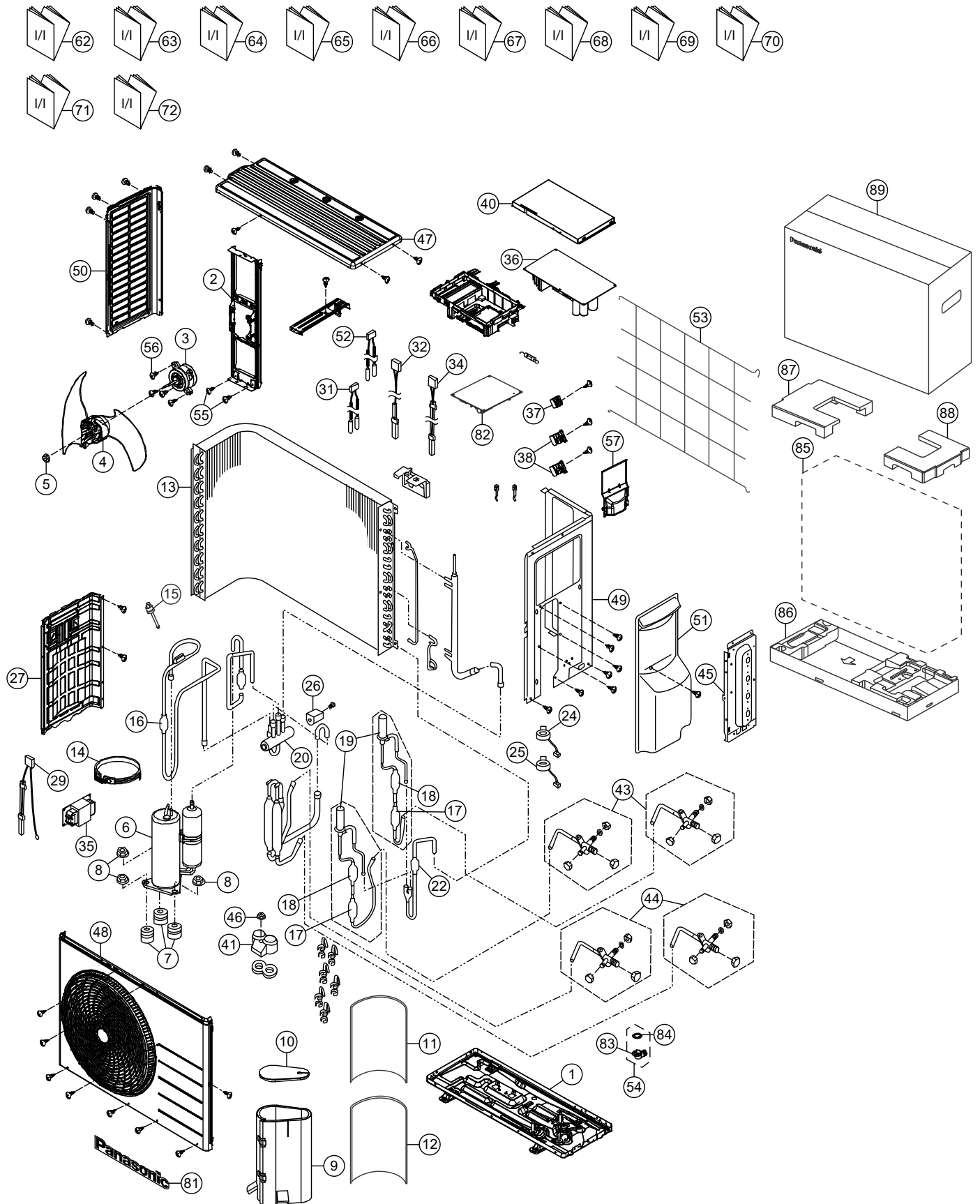

Note  
 The above exploded view is for the purpose of parts disassembly and replacement.  
 The non-numbered parts are not kept as standard service parts.

SAFETY	NO.	DESCRIPTION & NAME	Q'TY	CU-2TZ41TBE	CU-2TZ50TBE	REMARK
	1	CHASSIS ASSY	1	CWD52K1399	←	
	2	FAN MOTOR BRACKET	1	CWD541157	←	
⚠	3	FAN MOTOR	1	L6CBYYYYL0218	←	O
	4	PROPELLER FAN ASSY	1	CWH03K1100	←	
	5	NUT - PROPELLER FAN	1	CWH56053J	←	
⚠	6	COMPRESSOR	1	9RD132XFA21	←	O
	7	ANTI - VIBRATION BUSHING	3	CWH50077	←	
	8	NUT - COMPRESSOR MOUNT	3	CWH561096	←	
	9	SOUND PROOF MATERIAL (BODY)	1	ACXG30-08250	←	
	10	SOUND PROOF MATERIAL (TOP)	1	ACXG30-08260	←	
	11	SOUND PROOF MATERIAL	1	ACXG30-08450	←	
	12	SOUND PROOF MATERIAL	1	ACXG30-08460	←	
	13	CONDENSOR CO.	1	ACXB32C15170	←	
	14	CRANKCASE HEATER	1	CWA341044	←	
	15	HEATING PRESSURE SWITCH	1	CWA101013	←	
	16	DISCHARGE MUFFLER	1	CWB121010	←	
	17	DISCHARGE MUFFLER	2	ACXB12-00610	←	
	18	STRAINER	2	CWB111024	←	
	19	EXPANSION VALVE	2	CWB051029	←	
	20	4 - WAYS VALVE	1	CWB001064	←	O
	22	STRAINER	1	CWB111080	←	
	24	V - COIL COMPLETE (CN-EV1 WHITE)	1	CWA43C2579	←	O
	25	V - COIL COMPLETE (CN-EV2 YELLOW)	1	CWA43C2580	←	O
	26	V - COIL COMPLETE (4 - WAY VALVE)	1	CWA43C2585	←	O
	27	SOUND PROOF BOARD	1	ACXH15-02430	←	
	29	SENSOR - COMPLETE (AIR TEMP SENSOR CN-TH1)	1	ACXA50C14060	←	O
	31	SENSOR - COMPLETE (GAS PIPE TEMP CN-TH4)	1	ACXA50C14080	←	O
	32	SENSOR - COMPLETE (DEFROST SENSOR CN-TH2)	1	ACXA50C14070	←	O
	34	SENSOR - COMPLETE - TANK	1	CWA50C2632	←	O
	35	REACTOR	1	G0C392J00035	←	O
⚠	36	ELECTRONIC CONTROLLER - MAIN	1	ACXA73C42190R	ACXA73C42200R	O
⚠	37	TERMINAL BOARD ASSY (L, N)	1	CWA28K1162	←	O
⚠	38	TERMINAL BOARD ASSY (1, 2, 3)	2	CWA28K1161	←	O
	40	CONTROL BOARD COVER	1	ACXH13-00450	←	
	41	TERMINAL COVER	1	CWH171039A	←	
	43	3 - WAYS VALVE (LIQUID)	2	CWB011418	←	O
	44	3 - WAYS VALVE (GAS)	2	CWB011081J	←	O
	45	HOLDER COUPLING	1	ACXH35-01450	←	
	46	NUT - TERMINAL COVER	1	CWH7080300J	←	
	47	CABINET TOP PLATE	1	CWE031230A	←	

SAFETY	NO.	DESCRIPTION & NAME	Q'TY	CU-2TZ41TBE	CU-2TZ50TBE	REMARK
	48	CABINET FRONT PLATE CO.	1	CWE06C1566	←	
	49	CABINET SIDE PLATE CO.	1	ACXE04C05760	←	
	50	CABINET SIDE PLATE (LEFT)	1	CWE041858A	←	
	51	CONTROL BOARD COVER - COMPLETE	1	ACXH13C04680	←	
	52	SENSOR - COMPLETE (LIQUID PIPE TEMP CN-TH3)	1	ACXA50C14090	←	O
	53	WIRE NET. RESIN NET	1	ACXD04-00040A	←	
	54	BAG - COMPLETE	1	CWG87C900	←	
	55	SCREW - BRACKET FAN MOTOR	2	CWH551217	←	
	56	SCREW - FAN MOTOR MOUNT	4	CWH55252J	←	
	57	CONTROL BOARD COVER	1	CWH131595	←	
	62	INSTALLATION INSTRUCTION	1	ACXF60-29180	←	
	63	INSTALLATION INSTRUCTION	1	ACXF60-29190	←	
	64	INSTALLATION INSTRUCTION	1	ACXF60-29200	←	
	65	INSTALLATION INSTRUCTION	1	ACXF60-29210	←	
	66	INSTALLATION INSTRUCTION	1	ACXF60-29220	←	
	67	INSTALLATION INSTRUCTION	1	ACXF60-29230	←	
	68	INSTALLATION INSTRUCTION	1	ACXF60-29240	←	
	69	INSTALLATION INSTRUCTION	1	ACXF60-29250	←	
	70	INSTALLATION INSTRUCTION	1	ACXF60-29260	←	
	71	INSTALLATION INSTRUCTION	1	ACXF60-29270	←	
	72	INSTALLATION INSTRUCTION	1	ACXF60-29280	←	
	81	BADGE PANASONIC	1	CWE373439	←	
	82	ELECT. CONT. (NOISE FILTER)	1	ACXA73-22700	←	
	83	L - TUBE	1	CWH5850080	←	
	84	PACKING L - TUBE	1	CWB81012	←	
	85	BAG	1	CWG861078	←	
	86	BASE BOARD COMPLETE	1	CWG62C1223	←	
	87	SHOCK ABSORBER (L)	1	CWG713779	←	
	88	SHOCK ABSORBER (R)	1	CWG713778	←	
	89	C.C. CASE	1	ACXG50-06590	←	

(Note)

- All parts are supplied from PAPAMY, Malaysia (Vendor Code: 00029488).
- "O" marked parts are recommended to be kept in stock.