

# Scotsman<sup>®</sup>

SERVICE MANUAL

## NEW AF SERIES

**Electronic flakers  
with storage**

SCOTSMAN EUROPE - FRIMONT SPA  
Via Puccini, 22 - 20010 Pogliano M.se - Milano - Italy  
Tel. +39-02-93960.1 (Aut. Sel.)- Telefax +39-02-93550500  
Direct Line to Service & Parts:  
Phone +39-02-93960350 - Fax +39-02-93540449  
Website: [www.scotsman-ice.com](http://www.scotsman-ice.com)  
E-Mail: [scotsman.europe@frimont.it](mailto:scotsman.europe@frimont.it)

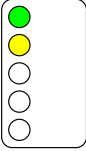
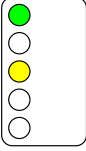
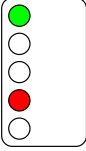
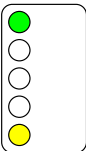
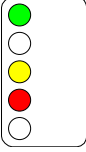
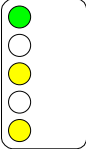
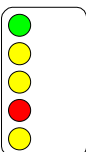

REV. 04/2012

LED	STATUS	REASON WHY – SIGNIFICATION – SIGNIFICATO – Beschreibung
	<b>ON STEADY</b> FIXE FISSO <i>Ständig an</i>	<b>UNIT OFF AT BIN FULL</b> CABINE PLAINÉ CONTENITORE PIENO <i>Maschine AUS, Speicher voll!</i>
	<b>BLINKING SLOW</b> CLIGNOTANT LENT LAMPEGG. LENTO <i>Blinkt langsam</i>	<b>IR BEAM CUTTED</b> FAISCEAU INFRA ROUGE CELLULE NIVEAU GLACE INTERROMPU RAGGIO INFRAROSSO INTERROTTO <i>Lichtschanke unterbrochen!</i>
	<b>BLINKING FAST</b> CLIGNOTANT RAPIDE LAMPEGG. VELOCE <i>Blinkt schnell</i>	<b>IR ON AFTER TRIP OFF AT BIN FULL</b> FAISCEAU INFRA ROUGE CELLULE NIVEAU GLACE ETABLI RAGGIO INFRAROSSO RIPRISTINATO INTERROTTO <i>Speicher entleert, Maschine startet gleich!</i>
	<b>ON STEADY</b> FIXE FISSO <i>Ständig an</i>	<b>NO WATER</b> MANQUE D'EAU MANCANZA ACQUA <i>Kein Wasser!</i>
	<b>ON STEADY</b> FIXE FISSO <i>Ständig an</i>	<b>TOO HI DISCHARGE PRESSURE/TEMPERATURE</b> COUPURE HP FERMATA ALTA TEMP. CONDENSAZIONE <i>Zu hoher Kondensationsdruck</i>
	<b>BLINKING</b> CLIGNOTANT LAMPEGGIANTE <i>Blinkt</i>	<b>DELAY AT START UP (3 min. or 60 min. according to the Jumper setting)</b> TEMPORISATION AU DEMARRAGE (3 min ou 60 min. selon le réglage du chavalier) RITARDO PARTENZA (3' o 60' in funzione della regolazione del ponticello) <i>3 min. oder 60 min. Startverzögerung je nach Jumper Konfig.!</i>
	<b>BLINKING 3 TIMES AND REPEAT</b> CLIGNOTANT 3 FOIS ET NOUVEAU LAMPEGGIANTE 3 VOLTE <i>BLINKT 3 MAL und wiederholen</i>	<b>TOO LOW ROOM TEMP (&lt; +3°C)</b> COUPURE TRES BASSE TEMP. AMBIANTE (< +3°C) FERMATA TEMP. AMBIENTE BASSA (< +3°C) <i>Zu hoher Raumtemp. &lt; +3°C!</i>
	<b>ON STEADY</b> FIXE FISSO <i>Ständig an</i>	<b>NO, SLOW OR WRONG ROTATION OF DRIVE MOTOR</b> MOTOREDUCTEUR TOURNE A L'ENVERS, NE TOURNE PAS, OU TROP LENTEMENT MOTORE RIDUTTORE GIRA AL CONTRARIO, NON GIRA O GIRA LENTAMENTE <i>Keine, zu langsame oder schwere Getriebrotation!</i>
	<b>BLINKING</b> CLIGNOTANT LAMPEGGIANTE <i>Blinkt</i>	<b>TOO HI EVAP. TEMP. (&gt; 0°C) AFTER 10' FROM START UP OR TOO LOW EVAP. TEMP. (&lt; -25°C)</b> COUPURE TEMP. EVAP. >0°C APRES 10' DE FONCTIONNEMENT OU TEMP. EVAP. <-25°C TEMP. EVAP. >0 °C DOPO 10' DA INIZIO FUNZIONAMENTO O INFERIORE A -25°C <i>Zu hohe Verd.temp. &gt; 0°C 10 min. nach dem Start oder zu niedrige Verd.temp. &lt; -25°C</i>
	<b>ON STEADY</b> FIXE FISSO <i>Ständig an</i>	<b>CONDENSER SENSOR OUT OF ORDER</b> SONDE CONDENSEUR HS SONDA CONDENSATORE MALFUNZIONANTE <i>Kondensatorfühler defekt!</i>
	<b>BLINKING</b> CLIGNOTANT LAMPEGGIANTE <i>Blinkt</i>	<b>EVAPORATOR SENSOR OUT OF ORDER</b> SONDE EVAPORATEUR HS SONDA EVAPORATORE MALFUNZIONANTE <i>Verdampferfühler defekt!</i>
	<b>BLINKING ALTERNATE</b> CLIGNOTANT ALTERNE LAMPEGGIANTE ALTERNATO <i>Blinkt im Wechsel!</i>	<b>OPTICAL ICE LEVEL CONTROL OUT OF ORDER</b> CELLULE INFRAROUGE NIVEAU GLACE HS SONDA ALL'INFRAROSSO LIVELLO GHIACCIO MALFUNZIONANTE <i>Lichtschanke defekt!</i>
	<b>BLINKING</b> CLIGNOTANT LAMPEGGIANTE <i>Blinkt</i>	<b>6 OR 12 MONTHS WATER SYSTEM CLEANING REMIND (according to the Jumper setting)</b> RAPPEL NETTOYAGE SYSTÈME HYDRAULIQUE APRES 6 OU 2 MOIS (selon réglage. chavalier) RICHIAMO PULIZIA CIRCUITO IDRICO DOPO 6 O 12 MESI (In funzione regolazione ponticello) <i>6 oder 12 Monate Reinigungshinweis für Wassersystem je nach Jumper Konfig.!</i>
	<b>BLINKING IN SEQUENCE</b> CLIGNOTTANT EN SEQUENCE LAMPEGGIANTE IN SEQUENZA <i>Blinken nacheinander!</i>	<b>PURGE CYCLE IN OPERATION (Only on units equipped with purge valve)</b> CYCLE D'ÉVACUATION EAU EN FONCTION (Seulement dans les machine équipées avec vanne de vidange eau) SISTEMA SCARICO ACQUA IN FUNZIONE (Solo negli apparecchi dotati di valvola di scarico) <i>Spülzyklus läuft, bei Maschinen mit Abbläsventil!</i>
	<b>BLINKING</b> CLIGNOTANT LAMPEGGIANTE <i>Blinken</i>	<b>UNIT OFF DUE TO THE JUMPER ON TEST CONTACTS</b> MACHINE A L'ARRÊT – CONTACTS TEST FERMÉES MACCHINA FERMA – CONTATTI TEST CHIUSI <i>Jumper Konfig. Im Testmodus!</i>

**PUSH AND HOLD THE RED LIGHTED SWITCH OR THE PC BOARD BUTTON FOR MORE OF 5 SECONDS WITH MACHINE IN OPERATION TILL THE SWITCHING OFF OF THE TWO YELLOW LEDS TO RESTART THE CLEANING REMIND COUNTDOWN**

APPUYER SUR LE BOUTON ROUGE OU SUR LE BOUTON DE LA CARTE POUR 5 SECONDES AVEC LA MACHINE EN FONCTIONNEMENT JUSQU'A L'ETEINTE DE LES DEUX LEDS JAUNE POUR REINITIALISER L'ALARME JUSQU'AU PROCHAIN DETARTRAGE

PREMERE IL PULSANTE ROSSO O IL PULSANTE DELLA SCHEDE PER PIU' DI 5" CON LA MACCHINA IN FUNZIONE FINO ALLO SPEGNIMENTO DEI DUE LED GIALLI PER FAR RIPARTIRE IL CONTEGGIO PER LA PROSSIMA DISINCROSTAZIONE

Drücken und halten Sie den roten Schalter oder den push button auf der Elektronik, für mehr als 5 Sekunden wenn die Maschine in Betrieb ist, bis die 2 gelben LED's auf der Elektronik nicht mehr leuchten!

Der Erinnerungszyklus für die Reinigung ist somit zurückgesetzt und startet neu!

**TABLE OF  
CONTENTS**

Table of contents	page	2
Specifications AF 803		3
Specifications AF 103		5
Specifications AF 124		7
Specifications AF 156		9
Specifications AF 206		11
 <b>GENERAL INFORMATION AND INSTALLATION</b>		
Introduction		13
Unpacking and Inspection		13
Location and levelling		13
Electrical connections		13
Water supply and drain connections		14
Final check list		14
Installation practice		15
 <b>OPERATING INSTRUCTIONS</b>		
Start up		16
Operational checks		18
 <b>PRINCIPLE OF OPERATION (How it works)</b>		
Water circuit		21
Refrigerant circuit		21
Mechanical system		23
Operating pressures		24
Components description		25
 <b>ADJUSTMENT, REMOVAL AND REPLACEMENT PROCEDURES</b>		
Adjustment of the evaporator water level		29
Replacement of evaporator temperature sensor		29
Replacement of condenser temperature sensor		29
Replacement of ice level light control		29
Replacement of the gear motor rotation and speed sensor		29
Replacement of the reservoir water level sensor		30
Replacement of P.C. Board		30
Replacement of the ice spout		30
Replacement of the auger, water seal, bearings and coupling		30
Replacement of the gear motor assy		31
Replacement of fan motor		31
Replacement of drier		32
Replacement of the freezing cylinder		32
Replacement of air cooled condenser		32
Replacement of water cooled condenser		32
Replacement of water regulating valve (water cooled models)		33
Replacement of compressor		33
Replacement of the gear motor magnetic sensor		33
Wiring diagram		34
Service diagnosis		36
 <b>MAINTENANCE AND CLEANING INSTRUCTIONS</b>		
General		38
Icemaker		38
Cleaning instructions of water system		38

**SPECIFICATIONS**

**ELECTRONIC FLAKER MODEL AF 80**

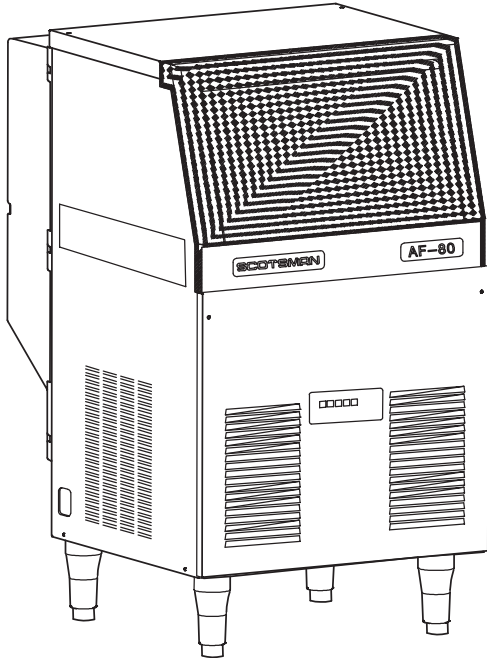

Important operating requirements:

	MIN	MAX
- Air temperature	10°C (50°F)	40°C (100°F)
- Water temperature	5°C (40°F)	35°C (100°F)
- Water pressure	1 bar (14 psi)	5 bars (70 psi)
- Electr. voltage variations from voltage rating specified on nameplate	-10%	+10%

**ice making capacity**

**AIR COOLED MODELS**

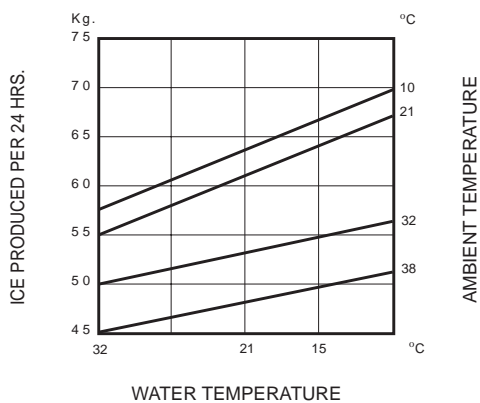

**WATER COOLED MODELS**

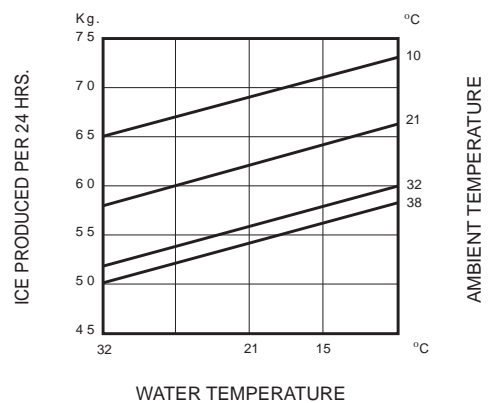

**NOTE.** With the unit in "built-in" conditions, the ice production is gradually reduced in respect to the levels shown in the graph, up to a maximum of 10% at room temperatures higher than 32°C. The daily ice-making capacity is directly related to the condenser air inlet temperature, water temperature and age of the machine. To keep your **SCOTSMAN FLAKER** at peak performance levels, periodic maintenance checks must be carried out as indicated on page 36 of this manual.

**SPECIFICATIONS**

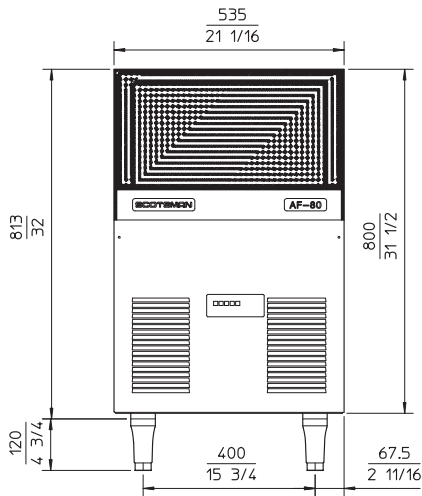
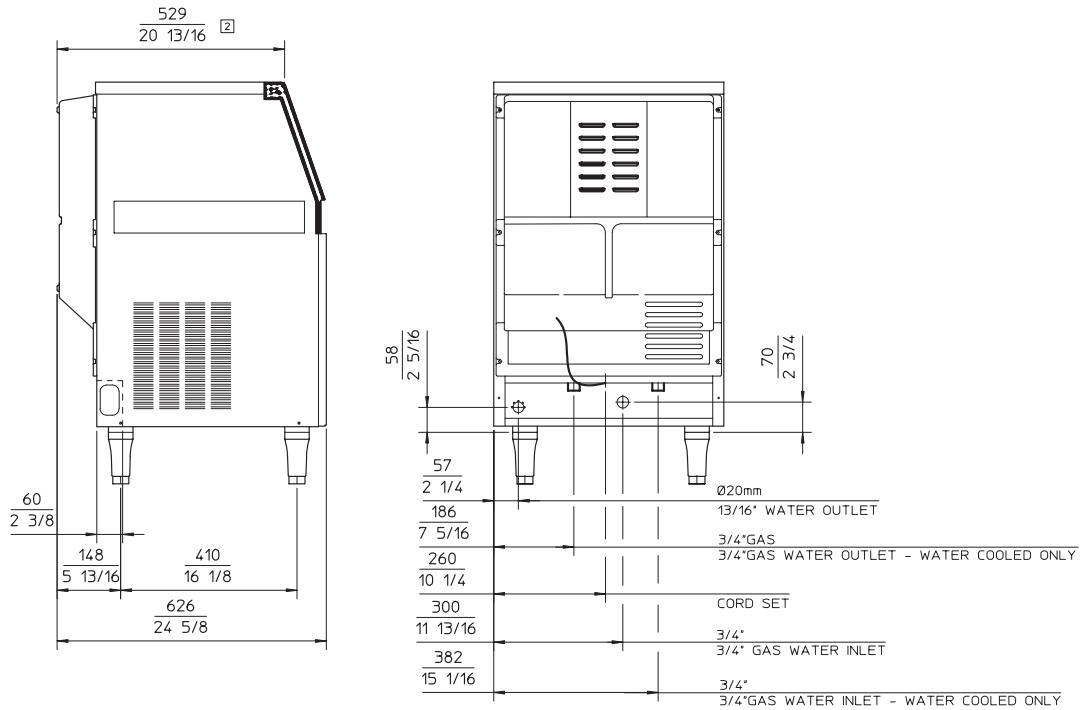

**Dimensions:**

HEIGHT (less legs)	813 mm.
HEIGHT (with legs)	933 mm.
WIDTH	535 mm.
DEPTH	621 mm.
WEIGHT	72 Kg.

**AF80 - MACHINE SPECIFICATIONS**

Model	Cond. unit	Finish	Comp. HP	Ice bin cap	Water req. lt/24 HR	
AF80 AS AF80 WS	Air Water	S. Steel	1/4	25 Kg.	53 300*	
Basic electr.	Amps	Start Amps	Watts	Electric power cons. Kwh per 24 HR	Nr. of wires	Amps fuse
230/50/1	2.2	11	330	7.5	3 x 1.5 mm <sup>2</sup>	10

\* A 15°C water temperature

**SPECIFICATIONS**

**ELECTRONIC FLAKER MODEL AF 103**

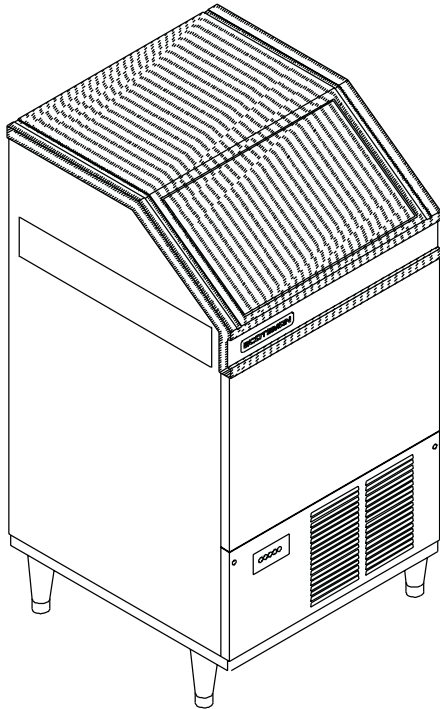

Important operating requirements:

	MIN	MAX
- Air temperature	10°C (50°F)	40°C (100°F)
- Water temperature	5°C (40°F)	40°C (100°F)
- Water pressure	1 bar (14 psi)	5 bars (70 psi)
- Electr. voltage variations from voltage rating specified on nameplate	-10%	+10%

**ice making capacity**

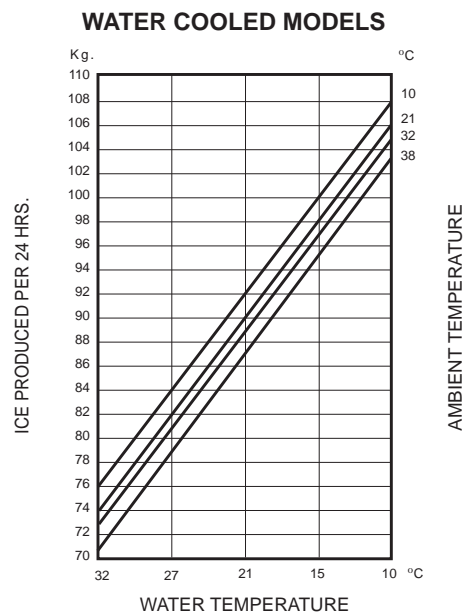
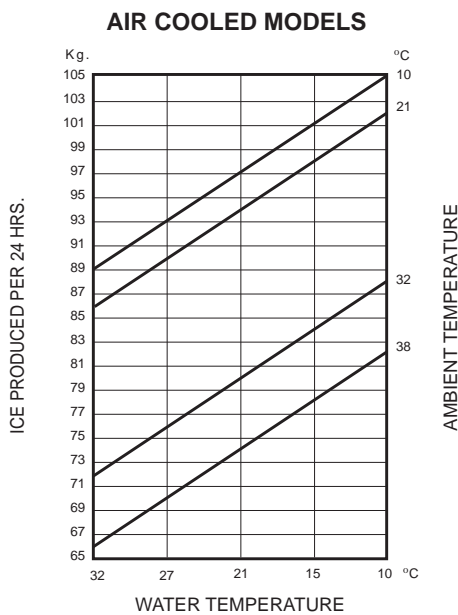

**NOTE.** The daily ice-making capacity is directly related to the condenser air inlet temperature, water temperature and age of the machine.  
 To keep your **SCOTSMAN FLAKER** at peak performance levels, periodic maintenance checks must be carried out as indicated on page 36 of this manual.

**SPECIFICATIONS**

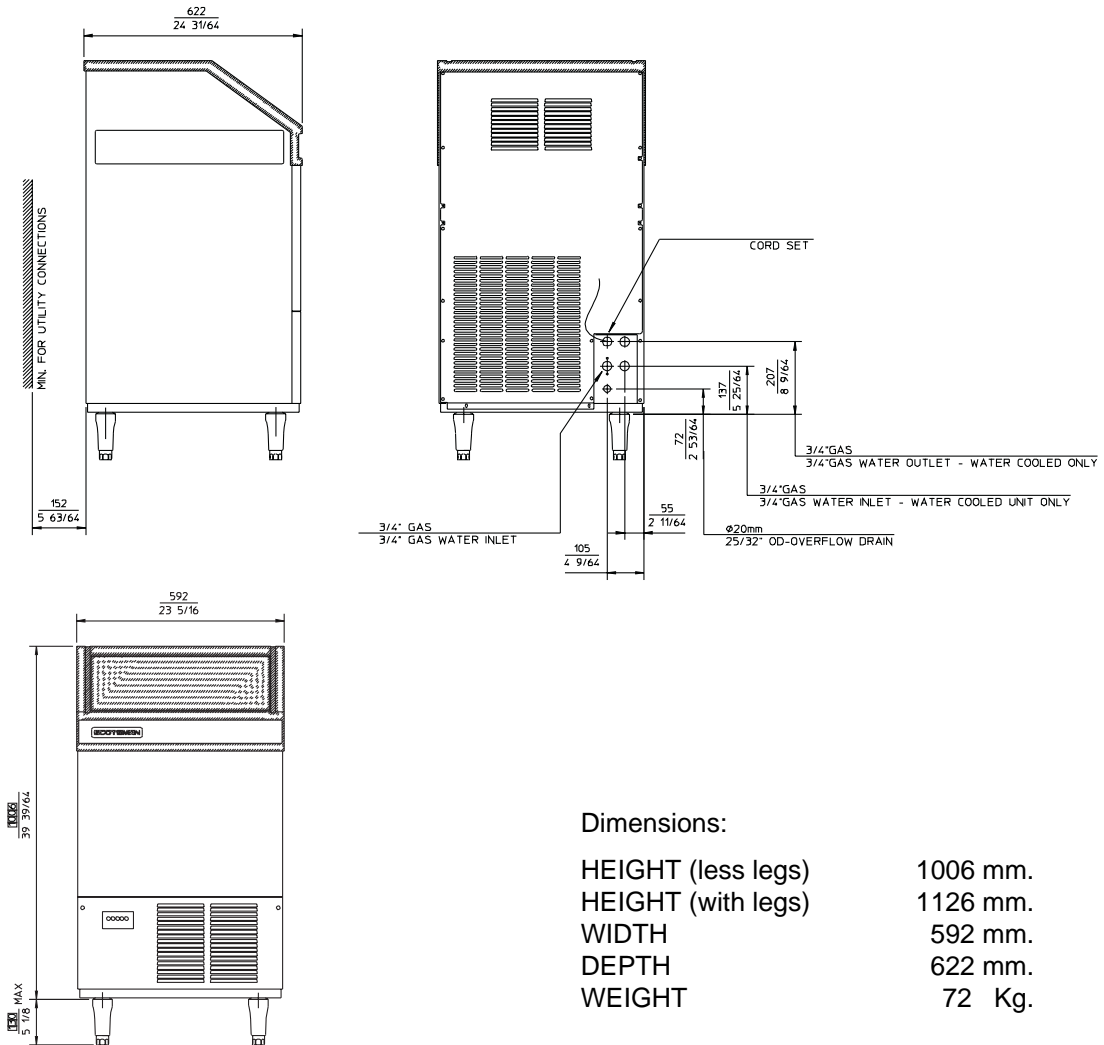

**AF103 - MACHINE SPECIFICATIONS**

Model	Cond. unit	Finish	Comp. HP	Ice bin cap	Water req. lt/24 HR
AF 103 AS AF 103 WS	Air Water	S. Steel	1/4	30 Kg.	105 440*

  

Basic electr.	Amps	Start Amps	Watts	Electric power cons. Kwh per 24 HR	Nr. of wires	Amps fuse
230/50/1	2.5	11	470 360	10 8.5	3 x 1.5 mm <sup>2</sup>	10

\* A 15°C water temperature

**SPECIFICATIONS**

**ELECTRONIC CUBELET MODEL AF 124**

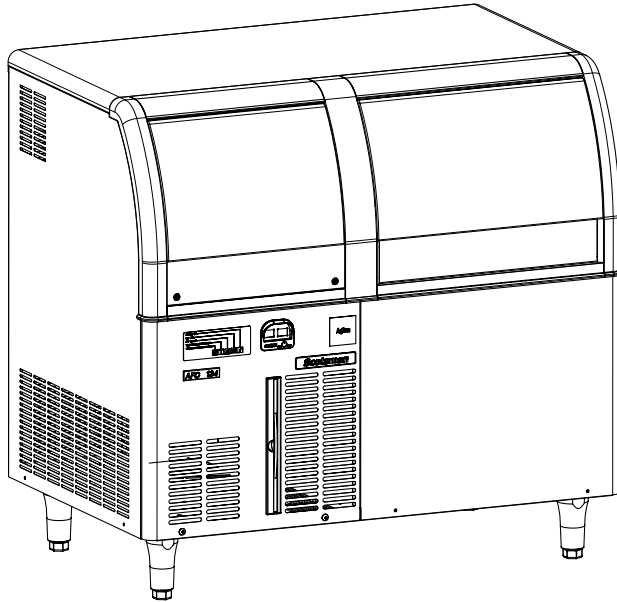

Important operating requirements:

	MIN	MAX
- Air temperature	10°C (50°F)	40°C (100°F)
- Water temperature	5°C (40°F)	35°C (90°F)
- Water pressure	1 bar (14 psi)	5 bars (70 psi)
- Electr. voltage variations from voltage rating specified on nameplate	-10%	+10%

**ice making capacity**

**AIR COOLED MODELS**

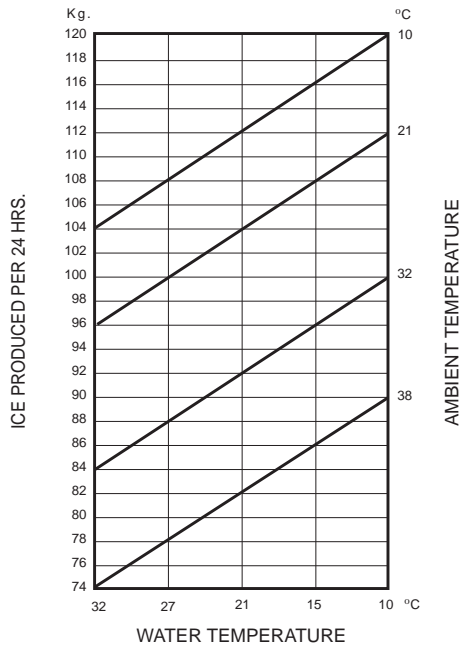

**WATER COOLED MODELS**

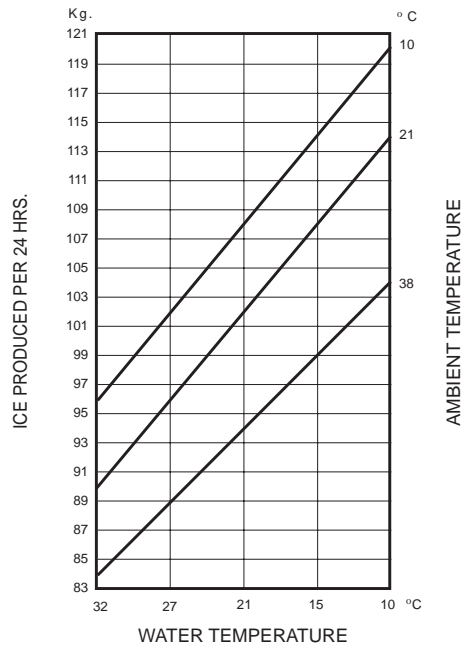

**NOTE.** With the unit in "built-in" conditions, the ice production is gradually reduced in respect to the levels shown in the graph, up to a maximum of 10% at room temperatures higher than 32°C. The daily ice-making capacity is directly related to the condenser air inlet temperature, water temperature and age of the machine. To keep your **SCOTSMAN CUBELET** at peak performance levels, periodic maintenance checks must be carried out as indicated on page 36 of this manual.



**SPECIFICATIONS**

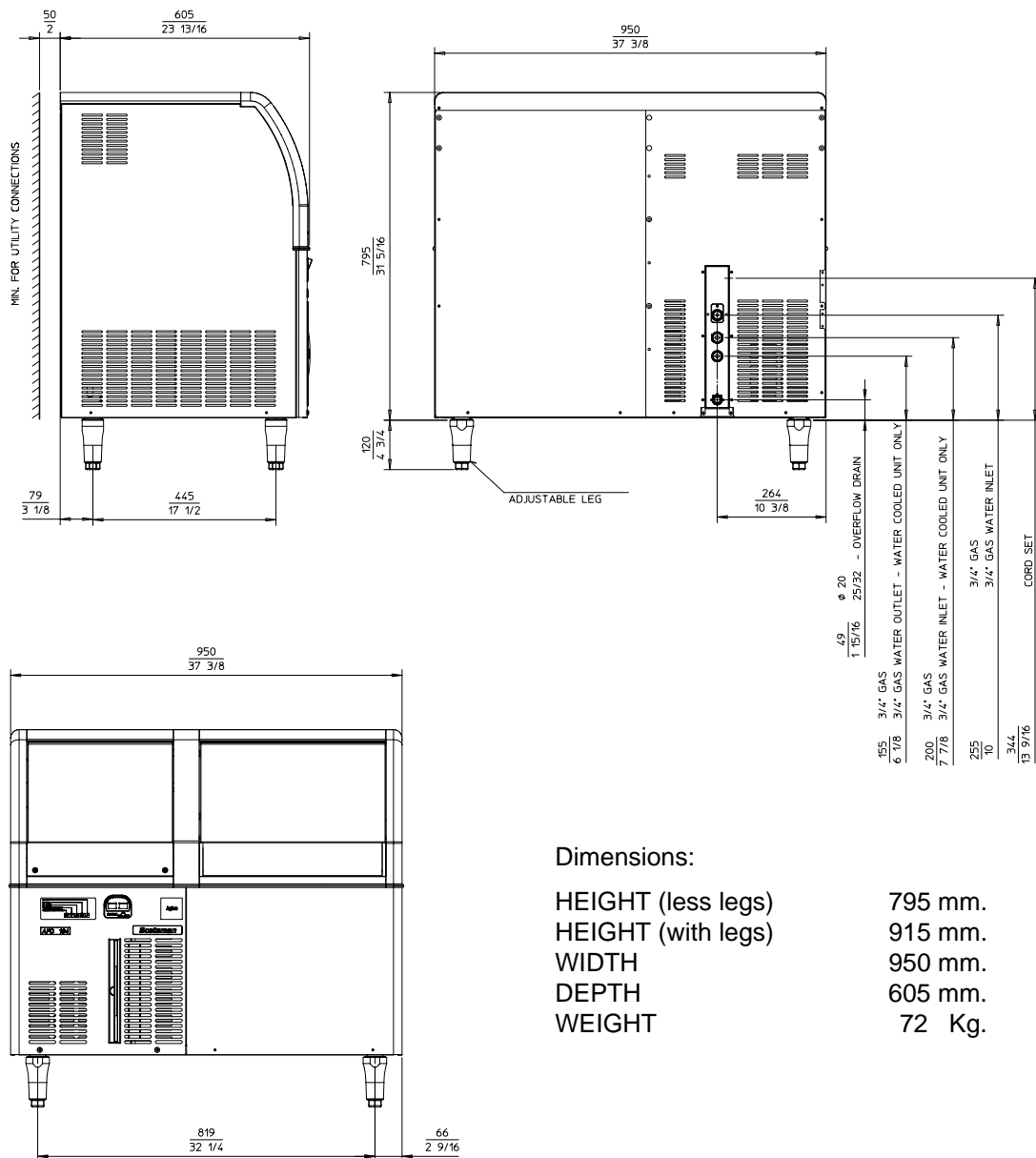

**AF 124 - MACHINE SPECIFICATIONS**

Model	Cond. unit	Finish	Comp. HP	Ice bin cap	Water req. lt/24 HR
AF 124 AS AF 124 WS	Air Water	S. Steel	3/8	40 Kg.	130 620*

  

Basic electr.	Amps	Start Amps	Watts	Electric power cons. Kwh per 24 HR	Nr. of wires	Amps fuse
230/50/1	3.8	17	600 500	13.2 11.9	3 x 1.5 mm <sup>2</sup>	10

\* A 15°C water temperature

**SPECIFICATIONS**

**ELECTRONIC FLAKER MODEL AF 156**

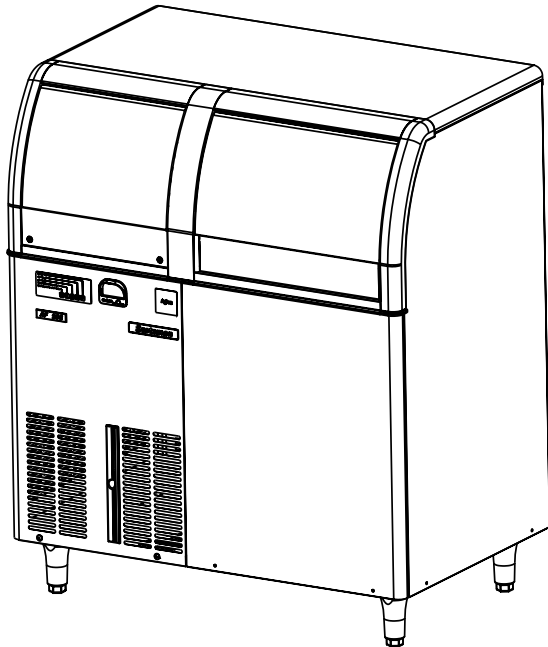

Important operating requirements:

	MIN	MAX
- Air temperature	10°C (50°F)	40°C (100°F)
- Water temperature	5°C (40°F)	40°C (100°F)
- Water pressure	1 bar (14 psi)	5 bars (70 psi)
- Electr. voltage variations from voltage rating specified on nameplate	-10%	+10%

**ice making capacity**

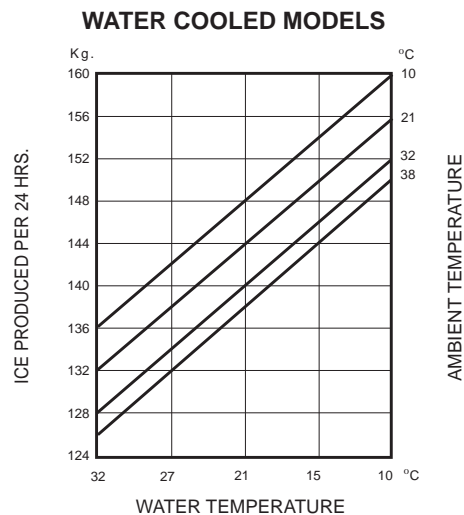
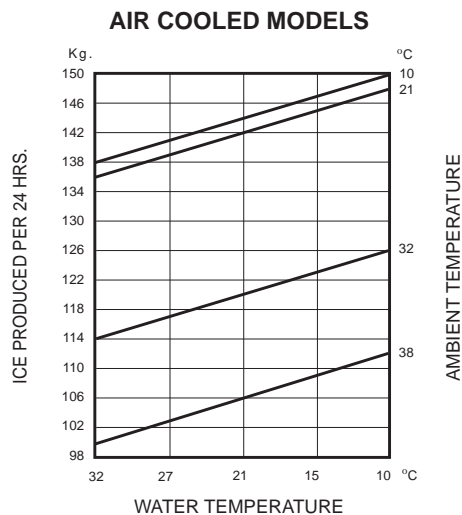

**NOTE.** With the unit in "built-in" conditions, the ice production is gradually reduced in respect to the levels shown in the graph, up to a maximum of 10% at room temperatures higher than 32°C. The daily ice-making capacity is directly related to the condenser air inlet temperature, water temperature and age of the machine. To keep your **SCOTSMAN FLAKER** at peak performance levels, periodic maintenance checks must be carried out as indicated on page 36 of this manual.

### SPECIFICATIONS

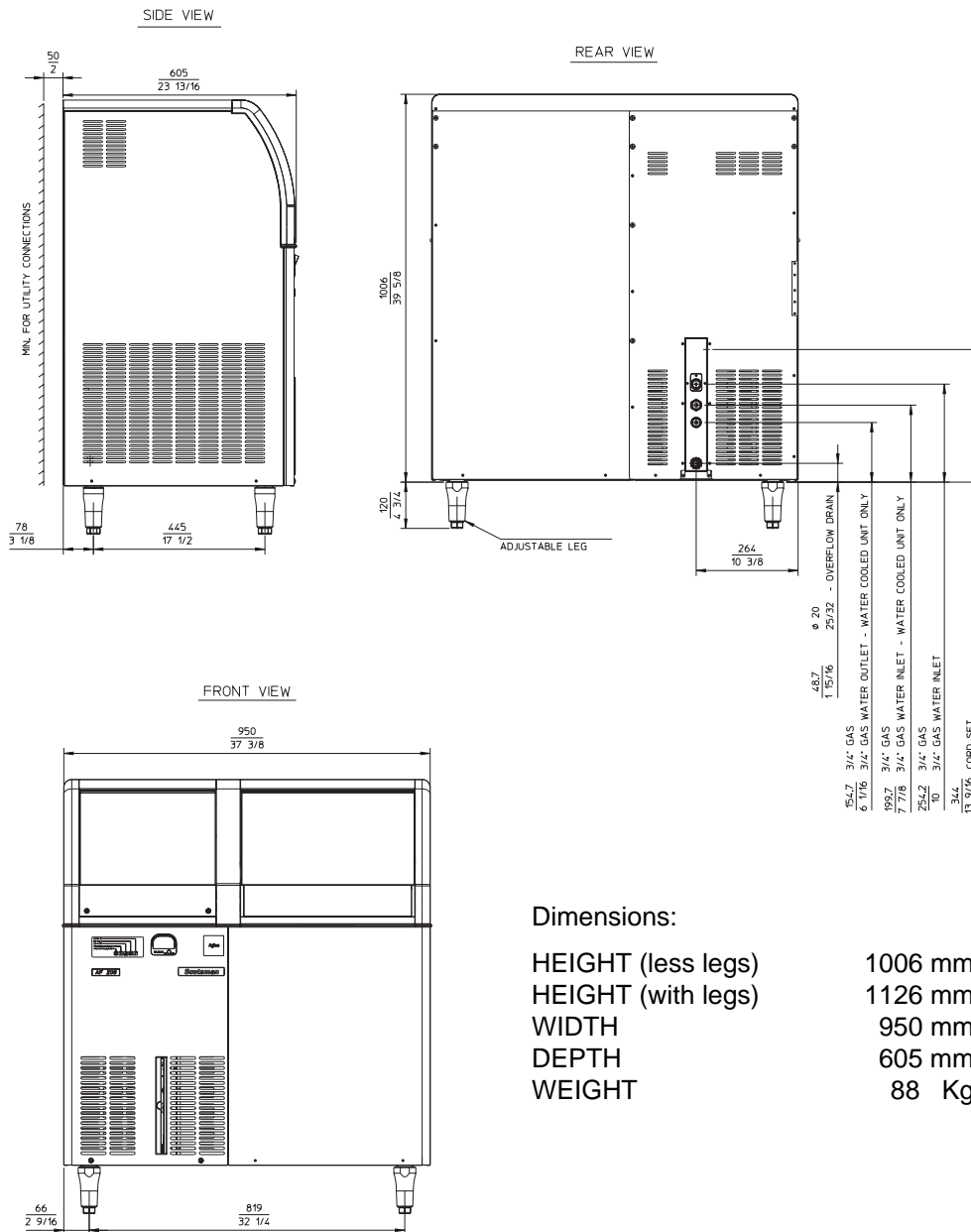

### AF 156 - MACHINE SPECIFICATIONS

Model	Cond. unit	Finish	Comp. HP	Ice bin cap	Water req. lt/24 HR	
AF156 AS AF156 WS	Air Water	S. Steel	3/8	60 Kg.	160 1000*	
Basic electr.	Amps	Start Amps	Watts	Electric power cons. Kwh per 24 HR	Nr. of wires	Amps fuse
230/50/1	3.8	17	650	14.7	3 x 1.5 mm <sup>2</sup>	10

\* A 15°C water temperature

## SPECIFICATIONS

# ELECTRONIC FLAKER MODEL AF 206

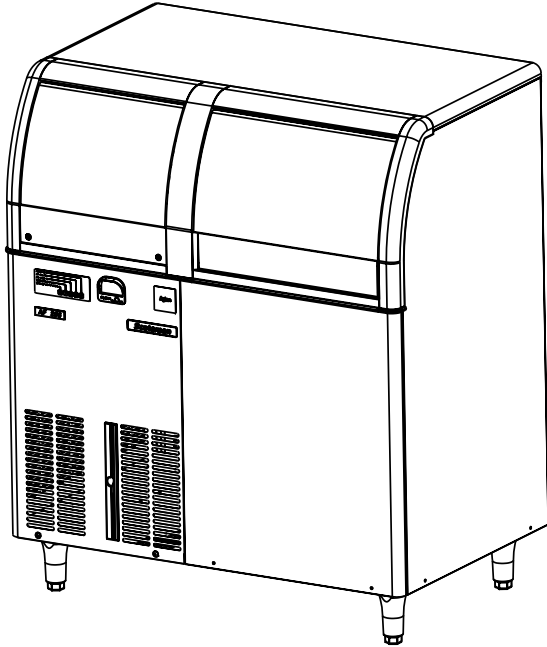

Important operating requirements:

	MIN	MAX
- Air temperature	10°C (50°F)	40°C (100°F)
- Water temperature	5°C (40°F)	40°C (100°F)
- Water pressure	1 bar (14 psi)	5 bars (70 psi)
- Electr. voltage variations from voltage rating specified on nameplate	-10%	+10%

## ice making capacity

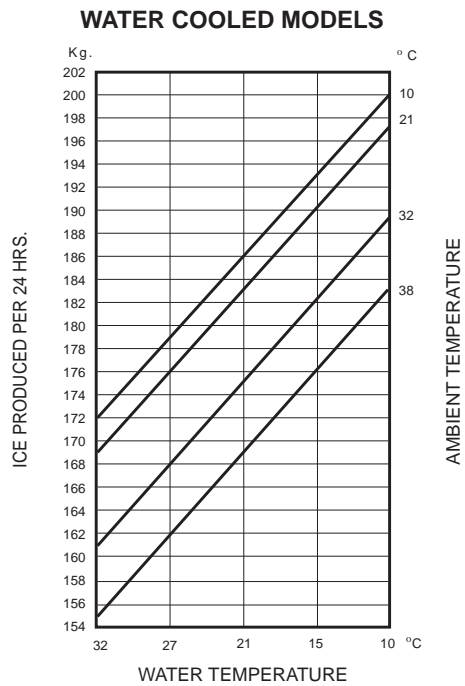
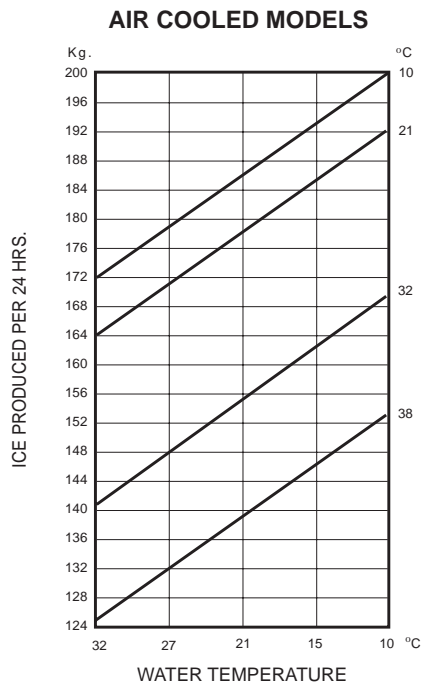

**NOTE.** The daily ice-making capacity is directly related to the condenser air inlet temperature, water temperature and age of the machine.  
 To keep your **SCOTSMAN FLAKER** at peak performance levels, periodic maintenance checks must be carried out as indicated on page 36 of this manual.

### SPECIFICATIONS

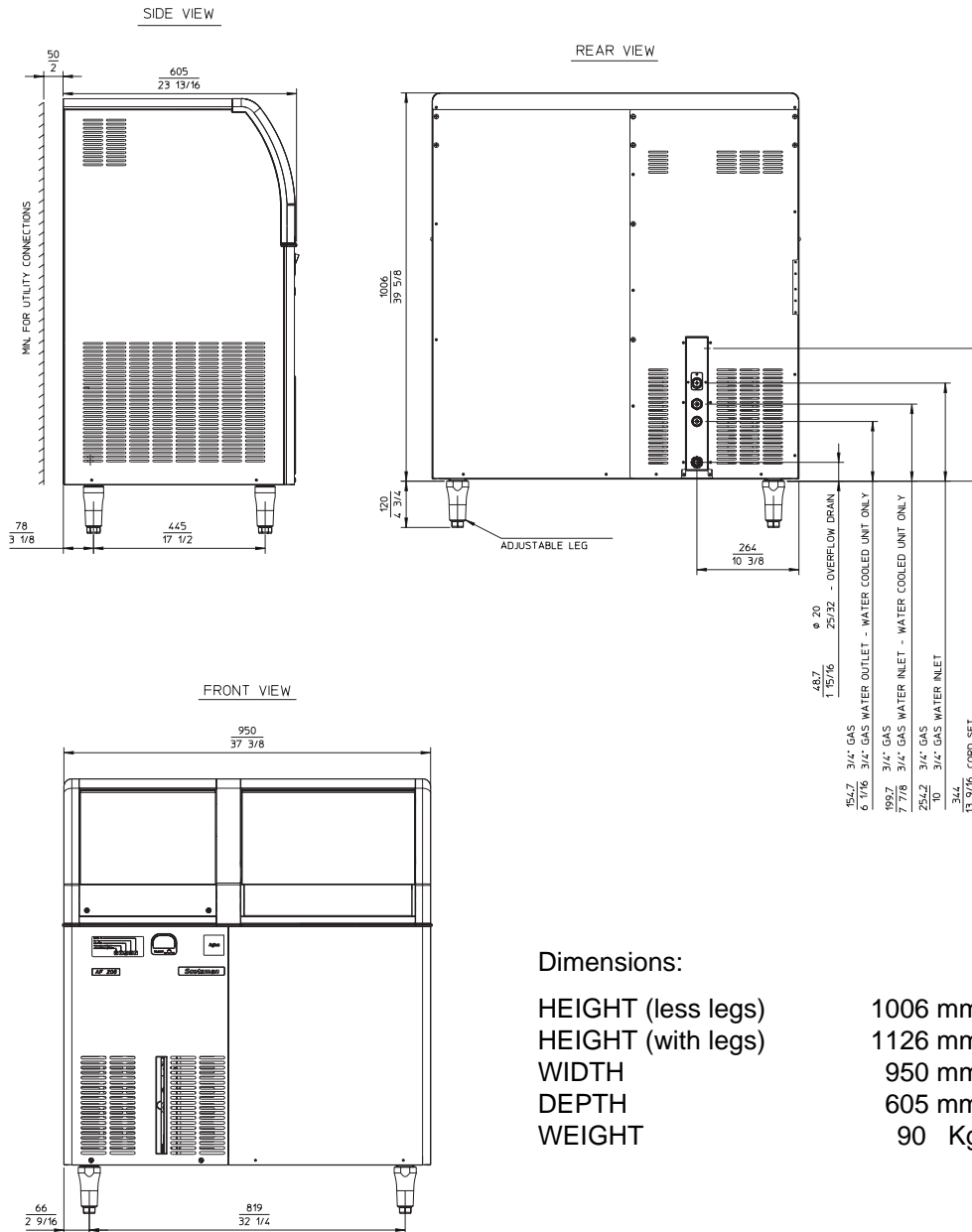

**Dimensions:**

HEIGHT (less legs)	1006 mm.
HEIGHT (with legs)	1126 mm.
WIDTH	950 mm.
DEPTH	605 mm.
WEIGHT	90 Kg.

### AF206 - MACHINE SPECIFICATIONS

Model	Cond. unit	Finish	Comp. HP	Ice bin cap	Water req. lt/24 HR
AF 206 AS AF 206 WS	Air Water	S. Steel	5/8	60 Kg.	200 1350*
Basic electr.	Amps	Start Amps	Watts	Electric power cons. Kwh per 24 HR	Nr. of wires Amps fuse
230/50/1	4	20	760	17.4	3 x 1.5 mm <sup>2</sup> 10

\* A 15°C water temperature

## GENERAL INFORMATION AND INSTALLATION

### A. INTRODUCTION

This manual provides the specifications and the step-by-step procedures for the installation, start-up and operation, maintenance and cleaning for the **SCOTSMAN AF series** icemakers.

The Electronic Flakers are quality designed, engineered and manufactured.

Their ice making systems are thoroughly tested providing the utmost in flexibility to fit the needs of a particular user.

**NOTE.** *To retain the safety and performance built into this icemaker, it is important that installation and maintenance be conducted in the manner outlined in this manual.*

### B. UNPACKING AND INSPECTION

1. Call your authorized SCOTSMAN Distributor or Dealer for proper installation.

2. Visually inspect the exterior of the packing and skid. Any severe damage noted should be reported to the delivering carrier and a concealed damage claim form filled in subject to inspection of the contents with the carrier's representative present.

3. a) Cut and remove the plastic strip securing the carton box to the skid.

b) Cut open the top of the carton and remove the polystyrene protection sheet.

c) Pull out the polystyrene posts from the corners and then remove the carton.

4. Remove the front and the rear panels of the unit and inspect for any concealed damage. Notify carrier of your claim for the concealed damage as stated in step 2 above.

5. Remove all internal support packing and masking tape. (Leg package and water inlet and outlet hoses are located in the storage bin compartment).

6. Check that refrigerant lines do not rub against or touch other lines or surfaces, and that the fan blades move freely.

7. Check that the compressor fits snugly onto all its mounting pads.

8. Use clean damp cloth to wipe the surfaces inside the storage bin and the outside of the cabinet.

9. See data plate on the rear side of the unit and check that local main voltage corresponds with the voltage specified on it.

**CAUTION.** **Incorrect voltage supplied to the icemaker will void your parts replacement program.**

10. Remove the manufacturer's registration card from the inside of the User Manual and fill-in all parts including: Model and Serial Number taken from the data plate.

Forward the completed self-addressed registration card to SCOTSMAN EUROPE factory.

11. If necessary fit the four legs into their seats on the machine base and adjust them to the desired level.

### C. LOCATION AND LEVELLING

**WARNING.** **This Ice Flaker is designed for indoor installation only. Extended periods of operation at temperature exceeding the following limitations will constitute misuse under the terms of the SCOTSMAN Manufacturer's Limited Warranty resulting in LOSS of warranty coverage.**

1. Position the unit in the selected permanent location.

Criteria for selection of location include:

a) Minimum room temperature 10°C (50°F) and maximum room temperature 40°C (100°F).

b) Water inlet temperatures: minimum 5°C (40°F) and maximum 35°C (90°F).

c) Well ventilated location for air cooled models (Clean the air cooled condenser at frequent intervals).

d) Service access: adequate space must be left for all service connections through the rear of the ice maker. A minimum clearance of 15 cm (6") must be left at the sides of the unit for routing cooling air drawn into and exhausted out of the compartment to maintain proper condensing operation of air cooled models.

2. Level the unit in both the left to right and front to rear directions.

### D. ELECTRICAL CONNECTIONS

See data plate for current requirements to determine wire size to be used for electrical connections. All SCOTSMAN icemakers require a solid earth wire.

All SCOTSMAN ice machines are supplied from the factory completely pre-wired and require only electrical power connections to the wire cord provided at the rear of the unit.

Make sure that the ice machine is connected to its own circuit and individually fused (see data plate for fuse size).

The maximum allowable voltage variation should not exceed -10% and +10% of the data plate rating. Low voltage can cause faulty functioning and may be responsible for serious damage to the overload switch and motor windings.

**NOTE.** All external wiring should conform to national, state and local standards and regulations.

Check voltage on the line and the ice maker's data plate before connecting the unit.

## E. WATER SUPPLY AND DRAIN CONNECTIONS

### GENERAL

When choosing the water supply for the ice flaker consideration should be given to:

- a) Length of run
- b) Water clarity and purity
- c) Adequate water supply pressure

Since water is the most important single ingredient in producing ice you cannot emphasize too much the three items listed above.

Low water pressure, below 1 bar may cause malfunction of the ice maker unit.

Water containing excessive minerals will tend to produce scale build-up on the interior parts of the water system while too soft water (with too low contents of mineral salts), will produce a very hard flaker ice.

### WATER SUPPLY

Connect the 3/4" GAS male of the water inlet fitting, using the flexible hose supplied to the cold water supply line with regular plumbing fitting and a shut-off valve installed in an accessible position between the water supply line and the unit.

If water contains a high level of impurities, it is advisable to consider the installation of an appropriate water filter or conditioner.

### WATER SUPPLY - WATER COOLED MODELS

The water cooled versions of SCOTSMAN Ice Makers require two separate inlet water supplies, one for the water making the flaker ice and the other for the water cooled condenser.

Connect the 3/4" GAS male fitting of the water inlet, using the flexible hose supplied to the cold water supply line with regular plumbing fitting and a shut-off valve installed in an accessible position between the water supply line and the unit.

### WATER DRAIN

The recommended drain tube is a plastic or flexible hose with 18 mm (3/4") I.D. which runs to an open trapped and vented drain. When the drain is a long run, allow 3 cm pitch per meter (1/4" pitch per foot).

Install a vertical open vent on drain line high point at the unit drain connection to ensure good draining.

The ideal drain receptacle is a trapped and vented floor drain.

### WATER DRAIN - WATER COOLED MODELS

Connect the 3/4" GAS male fitting of the condenser water drain, utilizing a second flexible hose to the open trapped and vented drain.

This additional drain line must not interconnect to any other of the units drains.

**NOTE.** The water supply and the water drain must be installed to conform with the local code. In some case a licensed plumber and/or a plumbing permit is required.

## F. FINAL CHECK LIST

1. Is the unit in a room where ambient temperatures are within a minimum of 10°C (50°F) even in winter months?
2. Is there at least a 15 cm (6") clearance around the unit for proper air circulation?
3. Is the unit level? (IMPORTANT)
4. Have all the electrical and plumbing connections been made, and is the water supply shut-off valve open?
5. Has the voltage been tested and checked against the data plate rating?
6. Has the water supply pressure been checked to ensure a water pressure of at least 1 bar (14 psi).
7. Have the bolts holding the compressor down been checked to ensure that the compressor is snugly fitted onto the mounting pads?

- 8. Check all refrigerant lines and conduit lines to guard against vibrations and possible failure.
- 9. Have the bin liner and cabinet been wiped clean?
- 10. Has the owner/user been given the User Manual and been instructed on the importance of periodic maintenance checks?

11. Has the Manufacturer's registration card been filled in properly? Check for correct model and serial number against the serial plate and mail the registration card to the factory.

12. Has the owner been given the name and the phone number of the authorized SCOTSMAN Service Agency serving him?

### G. INSTALLATION PRACTICE

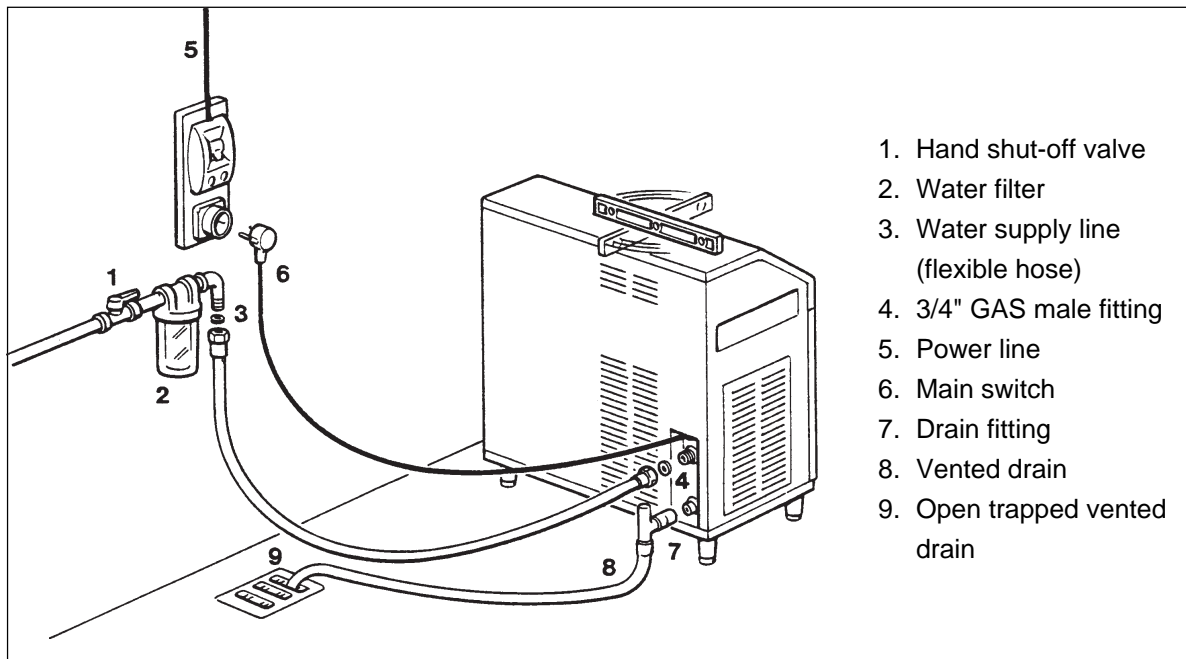

**WARNING.** This icemaker is not designed for outdoor installation and will not function in ambient temperatures below 10°C (50°F) or above 40°C (100°F). This icemaker will malfunction with water temperatures below 5°C (40°F) or above 35°C (90°F).

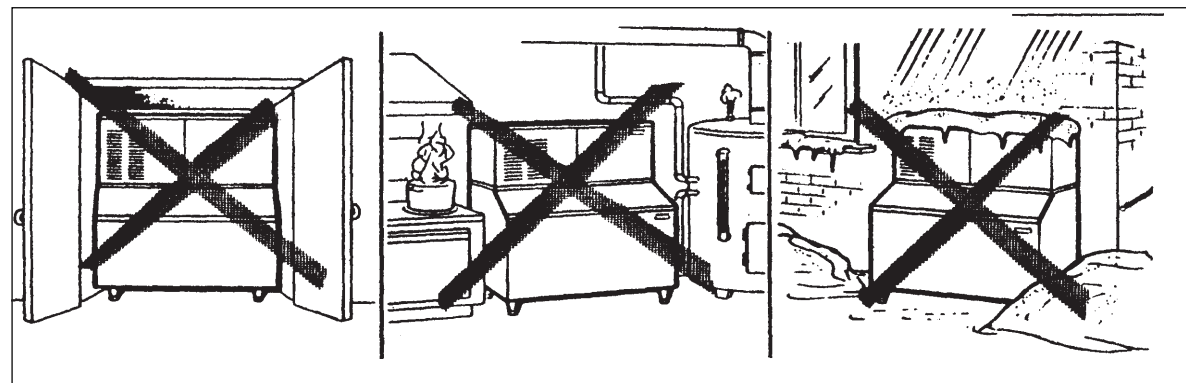



## OPERATING INSTRUCTIONS

### START UP

After having correctly installed the ice maker and completed the plumbing and electrical connections, perform the following "Start-up" procedure.

- A.** Open the water supply line shutoff valve and put the unit under electrical power by moving the main switch, on the power supply line, to the ON position.  
The **first LED - GREEN** - will glow to signal that unit is under power.

- B.** Elapsed the 3 minutes - stand by period - the unit starts operating with the activation in sequence of the following assemblies:

**GEAR MOTOR**  
**COMPRESSOR**

**FAN MOTOR** (if unit is an air cooled version) kept under control by the condenser temperature sensor which has its probe within the condenser fins (Fig.2).

- C.** After 2 or 3 minutes from the compressor start up, observe that flaker ice begins dropping off the ice spout to fall into the storage bin.

**NOTE.** Every time the unit is put under power, after being kept for sometime in shut-off conditions (electrically disconnected) the RED LED will blink for 3 minutes after which the unit will start up with the immediate operation of the gear motor assembly and, after few seconds, of the compressor assy (Fig.1).

**NOTE.** The first ice bits that drop into the ice storage bin are not so hard as the evaporating temperature has not yet reached the correct operating value. It is necessary to allow the ice - just made - to cure itself and wait for about ten minutes for the evaporating temperature to reach the correct value so to make more hard bits of ice.

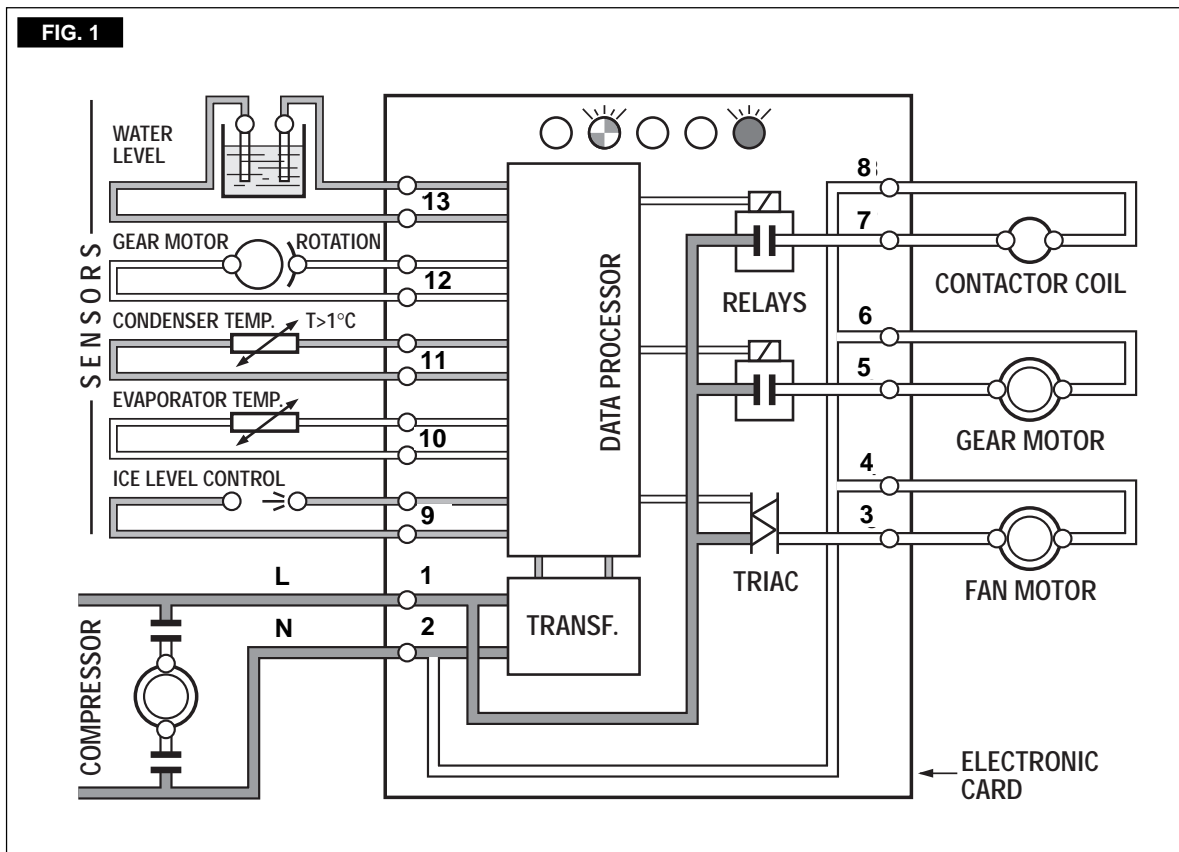

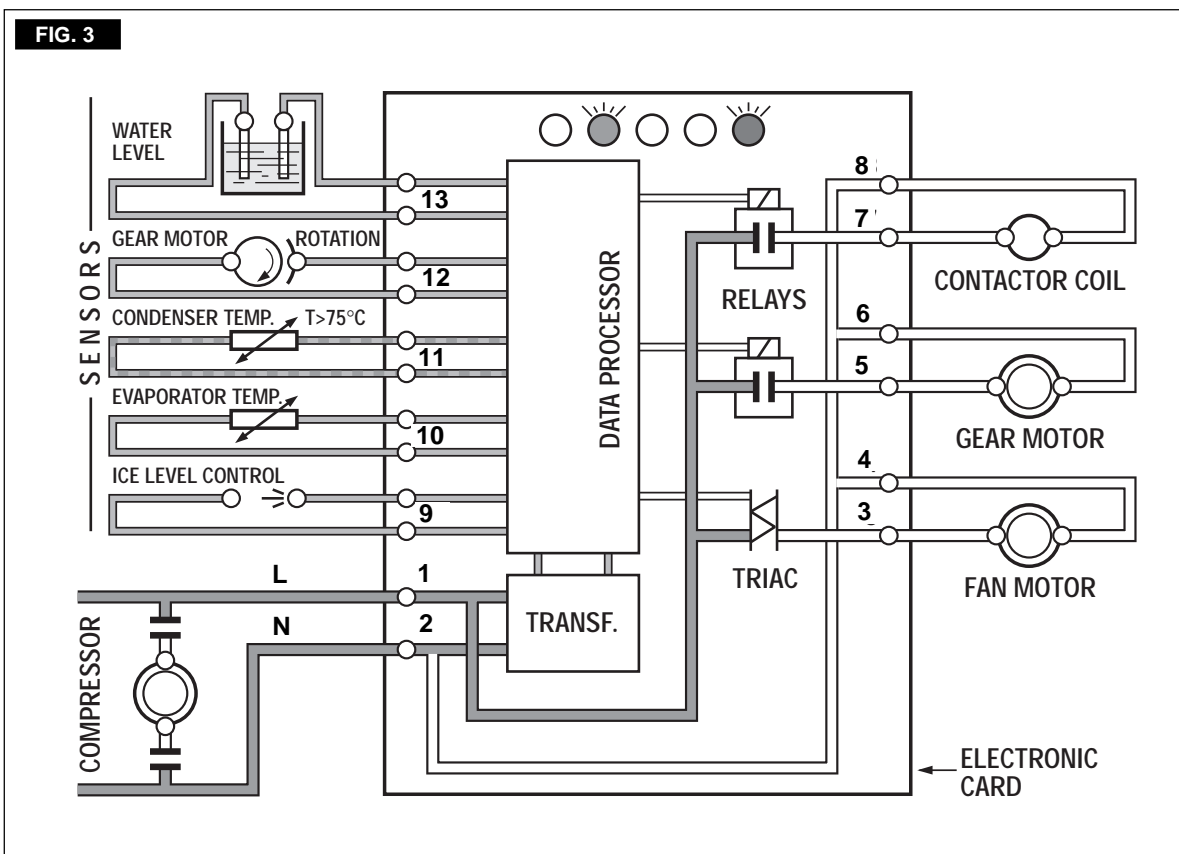
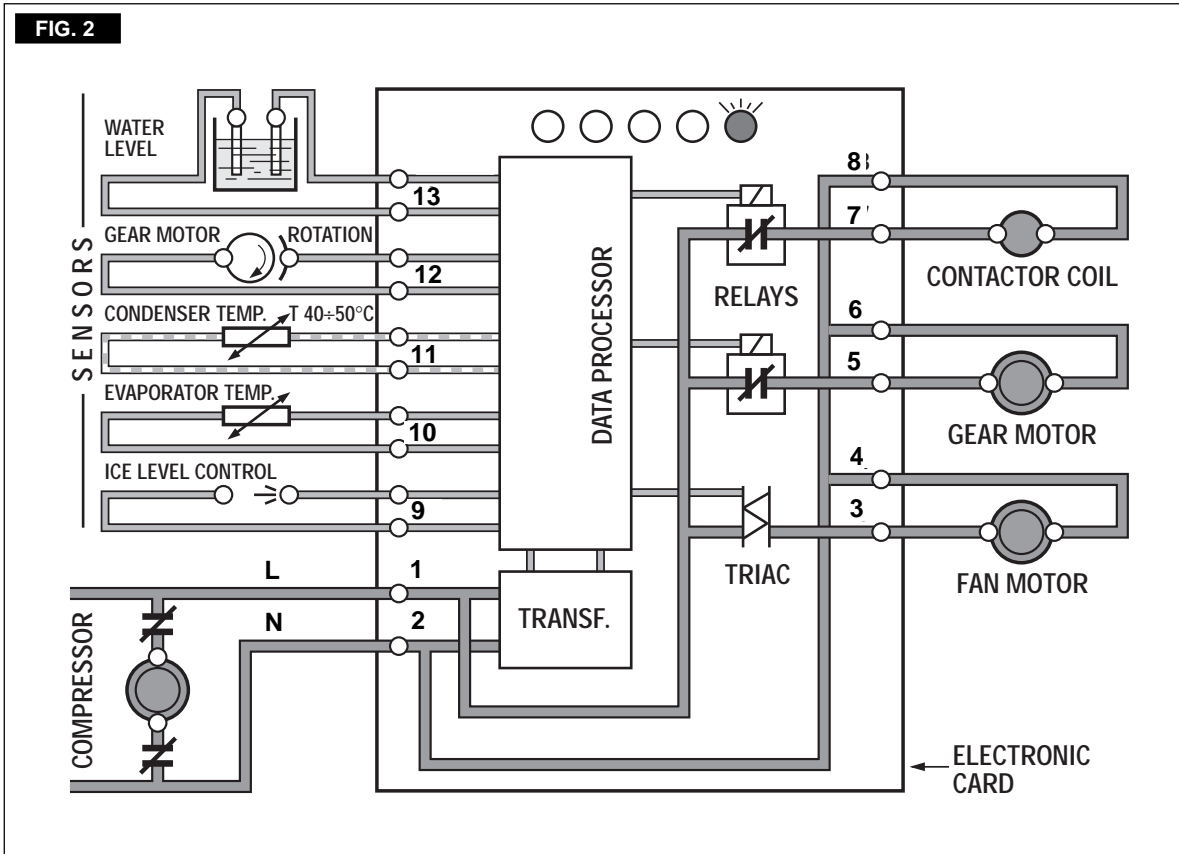

**NOTE.** If, after ten minutes from the compressor start-up, the evaporating temperature has not dropped down to a value lower than  $-1^{\circ}\text{C}$  ( $30^{\circ}\text{F}$ ) due to an insufficient quantity of refrigerant in the system, the evaporating temperature sensor detects such an abnormal situation and stops consequently the unit operation (drive motor keeps on working for 3' delay then stops). In this circumstance, the **5th warning YELLOW LED** will blink.



The machine will remain in OFF mode for one hour then it will restart automatically. In case the unit trips OFF again in alarm for 3 times in 3 hours, the machine SHUTS OFF DEFINITELY. After having diagnosed and eliminated the cause of the poor evaporating temperature (insufficient refrigerant in the system, etc.) it is necessary to unplug and plug in again to restart the machine. The unit, before resuming the total operation, will go through the **usual 3 minutes STAND-BY period**.

**OPERATION CHECKS UPON THE UNIT START UP**

**D.** Remove front service panel and if necessary install the refrigerant service gauges on the corresponding Service valves to check both the HI and LO refrigerant pressures.

**NOTE.** On air cooled models, the condenser temperature sensor, which is located within the condenser fins, keep the head (condensing) pressure between 17 and 18 bar.

In case of condenser clogging such to prevent the proper flow of the cooling air or, in case the fan motor is out of operation or shortage of water in the water cooled condenser, the condenser temperature rises and when it reaches  $70^{\circ}\text{C}$  ( $160^{\circ}\text{F}$ ) - for air cooled version - and  $60^{\circ}\text{C}$  ( $140^{\circ}\text{F}$ ) - for water cooled version - the condenser temperature sensor shuts-off the ice maker (drive motor keeps on working for 3' delay then stops) with the consequent light-up of the **RED WARNING LIGHT** (Fig.3).



The machine will remain in OFF mode for one hour then it will restart automatically. In case the unit trips OFF again in alarm for 3 times in 3 hours, the machine SHUTS OFF DEFINITELY. After having diagnosed the reason of the temperature rise and removed its cause, it is necessary to proceed as per the previous "NOTE" to start up again the operation of the ice maker.

**E.** Check for the correct CUT-OUT and CUT-IN of the **float reservoir water level sensors** by first shutting closed the water shutoff valve on the water supply line.

**FIG. 4**

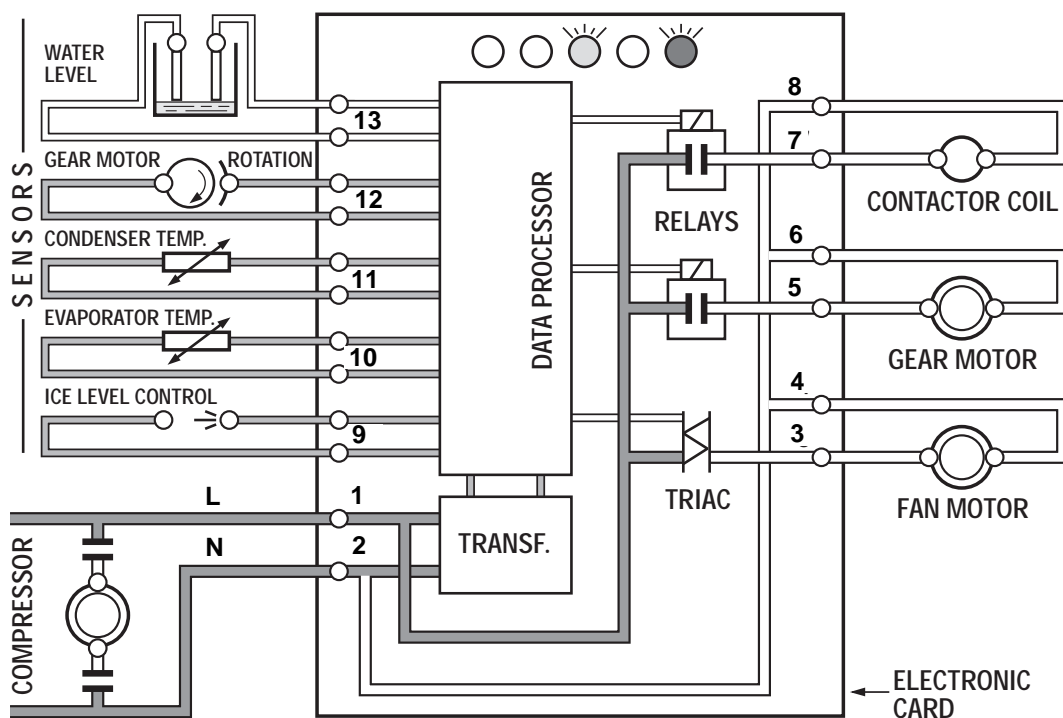

This will cause a gradual decrease of the water level in the float reservoir and as soon as the level gets below the sensors, the flaker stops to operate (drive motor keeps on working by 3' delay then stops) and the **YELLOW warning LED** will glow to signal the shortage of water (Fig. 4).



**NOTE.** The water level sensor detects the presence of sufficient water in the float reservoir and confirms it to the micro processor by maintaining a low voltage current flow between the two sensors using the water as conductor.

**WARNING.** The use of de-mineralized water (water with no salt content) having an electrical conductivity lower than 30  $\mu\text{S}$ , will cause the ability of the water sensors to vanish with the consequent **CUT-OUT** of the flaker operations and the glowing of the **YELLOW LED** of shortage of water, even though that water is indeed in the reservoir.

After this, open the water supply line shutoff valve to fill up again the float reservoir, the **YELLOW LED** goes off while the **RED LED** starts blinking.

After 3 minutes the unit resumes its total operation with the immediate start-up of the gear motor and, 2 seconds later, of the compressor.

**F.** Check for correct operation of the ice level control, by putting some ice so to cut the light beam of the sensing eyes.

This interruption will cause an immediate blinking of the Bin Full **YELLOW LED** located on the front of the P.C. Board and after about 10 seconds causes the shutoff of the unit (compressor first and 3' later the gear reducer) with the simultaneous lighting (steady) of the **Same LED** signalling the **full bin situation** (Fig. 5).



Remove the ice bin so to allow the resumption of the light beam previously interrupted. After about 10 seconds the flaker will resume - through the 3 minutes **STAND-BY** period - the ice making process with the extinguishing of the **YELLOW LED**.

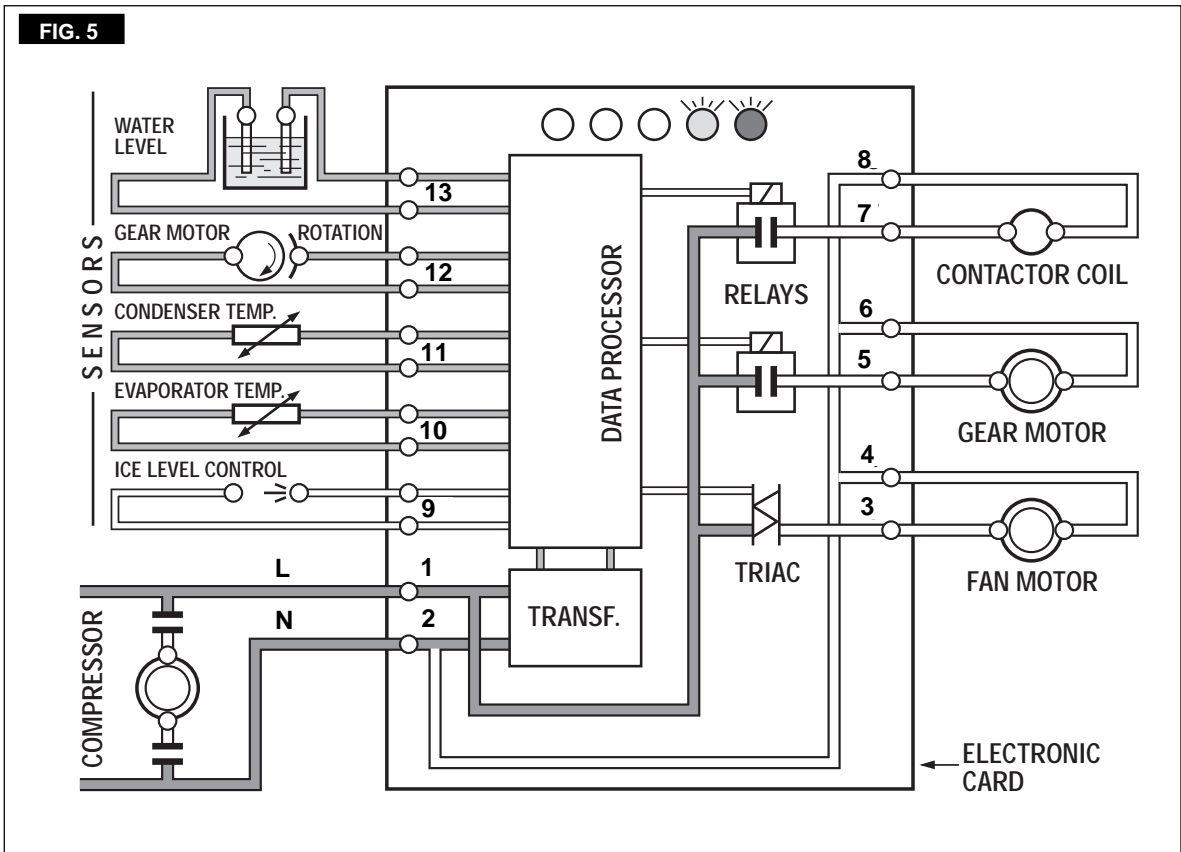

**NOTE.** The **ICE LEVEL CONTROL (INFRA-RED SYSTEM)** is independent of the temperature however, the reliability of its detection **can be affected by external light radiations** or by any sort of **dirt and scale sediment** which may deposit directly on the light source and on the receiver.

To prevent any possible ice maker malfunction, due to negative affection of the light detector, it is advisable to **locate the unit where it is not reached by any direct light beam or light radiation**, also it is **recommended to keep the bin door constantly closed**.

**NOTE.** During the life of the machine the Ice Level Control may require a recalibration mainly when the glass of the two optical eyes are covered by a thin lay of scale.

To do it just follow the following procedure:

- With unit OFF push and old the Reset Button of the PC Board
- Give power to the machine through the Green Master Switch
- Hold the PC Board Reset Button till the leds start to blink/flash (more or less 10 seconds)
- Release the PC Board Reset Button

The Optical Ice Level Control is now recalibrated.

Check for the correct operation of the Optical Ice Level Control by plasing a handfull of ice in between the two eyes.

The Bin Full yellow led must start to blink/flash immediately and, 10 seconds later, the machine must trip OFF.

**M.** If previously installed, remove the refrigerant service gauges and re-fit the unit service panels previously removed.

**N.** Instruct the owner/user on the general operation of the ice machine and about the cleaning and care it requires.

## PRINCIPLE OF OPERATION

### WATER CIRCUIT

The water enters in the machine through the water inlet fitting which incorporates a strainer and it is located at the rear side of the cabinet and then it goes to the water reservoir flowing through a float valve.

**NOTE.** The presence of the water in the float reservoir is detected by a system of two sensors which operates in conjunction with the P.C. Board. The two sensors use the water as a conductor to maintain a low voltage current flow between them signalling in this way to the P.C. Board the presence of the water in the reservoir. In case the water used is very soft (de-mineralized) or the float reservoir gets empty the current flow between the sensors become so weak or is no longer maintained that, as consequence, the P.C. Board shuts off the flaker operation (drive motor keeps on working by 3' delay then stops) with the simultaneous glowing of the **YELLOW LED** signalling "Shortage of water".

The float reservoir is positioned at the side of the freezing cylinder at such an height to be able to maintain a constant water level around the freezer auger.

In fact, the water flows from the reservoir into the bottom inlet of the freezing cylinder to surround the stainless steel auger which is vertically fitted in the center of the freezer.

In the freezer the incoming water gets chilled into soft (slush) ice which is moved upward by the rotating action of the auger. The stainless steel auger that rotates counter-clockwise within the freezer, is powered by a direct drive gear motor and carries the ice upward along the refrigerated freezer inner walls and by doing so the ice gets progressively thicker and harder.

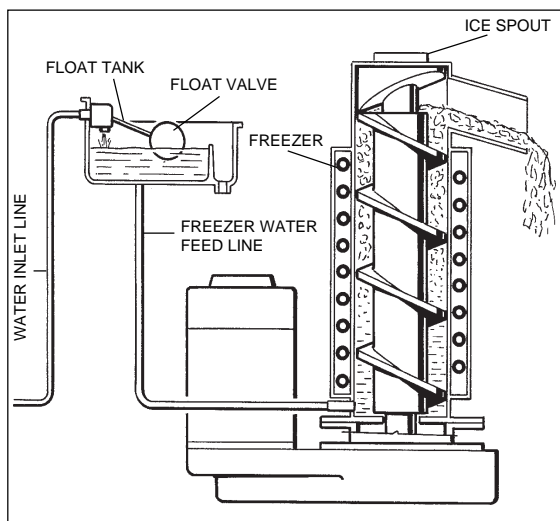

The ice, being constantly lifted up, meets the toothed point of the ice breaker which is fitted on the top end of the auger, where it gets compacted, cracked and forced to change from vertical into

horizontal motion to be discharged out, through the ice spout, into the storage bin.

By running the ice maker, i.e. by putting the unit under power, starts the automatic and continuous icemaking process which would not stop until the ice storage bin gets filled-up to the level of the control "eyes" located on the sides of the ice spout. As the ice level raises to interrupt the light beam running between the two infrared LEDs, the unit stops after six seconds (compressor first and 3' later the gear reducer), with the simultaneous glowing of the **YELLOW LED** signalling the "**Full Bin**" situation.

**NOTE.** The interruption of the light beam between the two light sensors is immediately signalled by the blinking of the **BIN FULL YELLOW LED** located on the front of the P.C. Board.

After about **10"** of steady interruption of the light beam the unit stops (drive motor keeps on working by 3' delay then stops) and the "**Full Bin**" **YELLOW LED** glows steady. The ten seconds of delay prevent the unit from stopping for any undue reason like the momentarily interruption of the light beam caused by the flakes that slides along the ice spout before dropping into the bin.

As some ice gets scooped out from the storage bin, the light beam between the two sensors resumes (fast blinking of **YELLOW LED**) and ten seconds later the ice machine restarts the ice making process - going always through the 3' stand by - and the **YELLOW LED** goes off.

### REFRIGERANT CIRCUIT

The hot gas refrigerant discharged out from the compressor reaches the condenser where, being cooled down, condenses into liquid.

Flowing into the liquid line it passes through the drier filter, then it goes all the way through the capillary tube where it loses some of its pressure so that its pressure and temperature are lowered. Next, the refrigerant enters into the evaporator coil wrapped around the freezer inner tube.

The water being constantly fed at the interior of the freezer inner tube, exchange heat with the refrigerant circulating into the evaporator coil, this causes the refrigerant to boil-off and evaporate, thereby it changes from liquid into vapor.

The vapor refrigerant then passes through the suction accumulator and through the suction line where the refrigerant exchanges heat with the one flowing into the capillary tube (warmer) before being sucked into the compressor to be recirculated.

The refrigerant heat pressure is kept between two pre-set values **17÷18 bar - 245÷260 psig** by the condenser temperature sensor which has its probe located within the condenser fins - in air cooled versions.

This condenser temperature sensor, when senses a rising of the condenser temperature beyond the pre-fixed limit, changes its electrical resistance and send a low voltage power flow to

the MICRO-PROCESSOR of the P.C. Board which energizes, through a TRIAC, the Fan Motor in ON-OFF mode.

When the opposite situation occurs, i.e. the condenser temperature gets below the pre-fixed

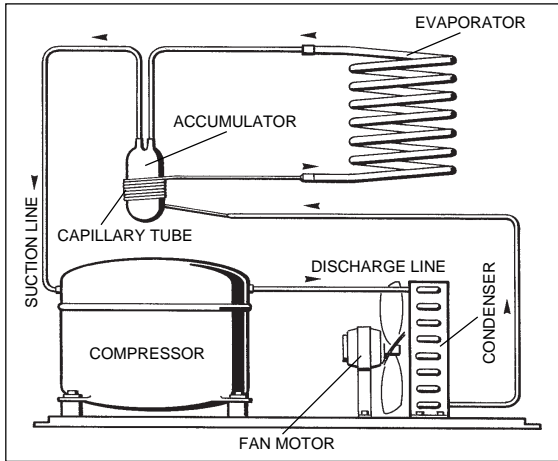

limit, the temperature sensor changes again its electrical resistance reducing therefore the current flow to the P.C. Board to cause a temporary stop of the Fan Motor.

On the water cooled versions, the refrigerant head pressure is kept at the constant value of **17 bar (245 psig)** by the metered amount of water passing through the condenser which is regulated by the action of the Water Regulating Valve that has its capillary tube connected to the liquid refrigerant line. As pressure increases, the water regulating valve opens to increase the flow of cooling water to the condenser.

**NOTE.** In case the condenser temperature probe senses that the condenser temperature has risen to **70°C (160°F)** - on air cooled versions - or **60°C (140°F)** - on water cooled versions - for one of the following abnormal reasons:

- CLOGGED CONDENSER** (Air cooled version)
- INSUFFICIENT FLOW OF COOLING WATER** (Water cooled version)
- FAN MOTOR OUT OF OPERATION** (Air cooled version)
- AMBIENT TEMPERATURE HIGHER THEN 43°C (110°F)**

it causes the total and immediate SHUT-OFF of the machine (drive motor keeps on working by 3' delay then stops) in order to prevent the unit from operating in abnormal and dangerous conditions. When the ice maker stops on account of this protective device, there is a simultaneous glowing of the **RED LED**, warning the user of the **Hi Temperature** situation. The machine will remain in OFF mode for one hour then it will restart automatically. In case the unit trips OFF again in alarm for 3 times in 3 hours, the machine SHUTS OFF DEFINITELY. After having eliminated the source of the excessive con-denser temperature, to restart the ice machine it is necessary to unplug and plug in again. The **RED LED starts blinking** and three minutes later the flaker unit resume its normal operating mode. The condenser temperature sensor has a further safety function which consist in preventing the unit from operating in Lo-ambient conditions i.e. when the condenser body temperature - equivalent to the ambient temperature - is **lower then 1°C 34°F** (Fig.6). As soon as the ambient temperature rises up to 5°C (40°F) the PC Board will automatically restarts the machine through the three minutes delay time.

FIG. 6

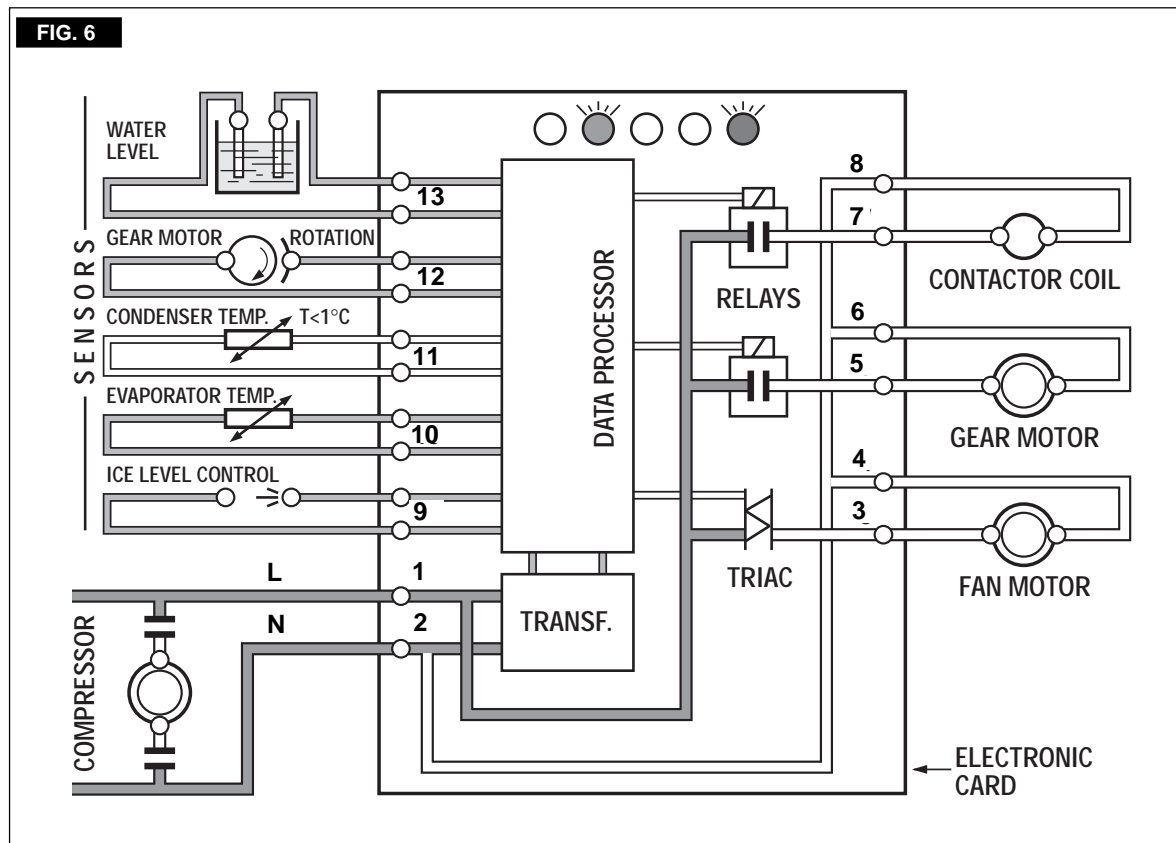



The refrigerant suction or Lo-pressure sets - in normal ambient conditions (21 °C) - on the value of **2.4 - 2.6 bar (35 - 38 psig)** after few minutes from the unit start-up.

This **value can vary of 0.1 or 0.2 bar (1.5÷3 psig)** in relation to the water temperature variations influencing the freezer cylinder.

**NOTE.** If, after ten minutes from the unit start up, no ice is made and the evaporating temperature detected by the evaporator sensor results to be higher than -1°C (30°F) the ice maker stops (compressor first and 3' later the gear reducer) and the **5TH WARNING YELLOW LED** blinks.  
 The machine will remain in OFF mode for one hour then it will restart automatically.  
 In case the unit trips OFF again in alarm for 3 times in 3 hours, the machine SHUTS OFF DEFINITELY.

**MECHANICAL SYSTEM**

The mechanical system of the SCOTSMAN Flaker machines consists basically of a gear motor assembly which drives, through a ratched coupling, a worn shaft or auger placed on its vertical axis within the freezing cylinder. The gear motor is made of a single phase electric motor with a permanent capacitor. This motor is

directly fitted in the gear case through which it drives - in counter clockwise rotation at a speed of 9.5 r.p.m. - the freezer auger being linked to it by the ratched coupling.

**NOTE.** In the event the gear motor will tend to rotate in the wrong direction (counter-clockwise) or not rotating at all or rotating at lower speed the unit will **stop immediately** with the glowing of the **WARNING YELLOW LED** on account of the intervention of the **Electromagnetic Safety Device** - based on Hall Effect principle.



The machine will remain in OFF mode for one hour then it will restart automatically. In case the unit trips OFF again in alarm for 3 times in 3 hours, the machine SHUTS OFF DEFINITELY.  
 After having diagnosed and eliminated the source of the failure, to restart the unit it is necessary to switch OFF and ON the power line main disconnect switch (Fig. 7).  
 The RED LED will start blinking and after 3 minutes the ice maker will resume its total operations by running first the gear motor and then the compressor.

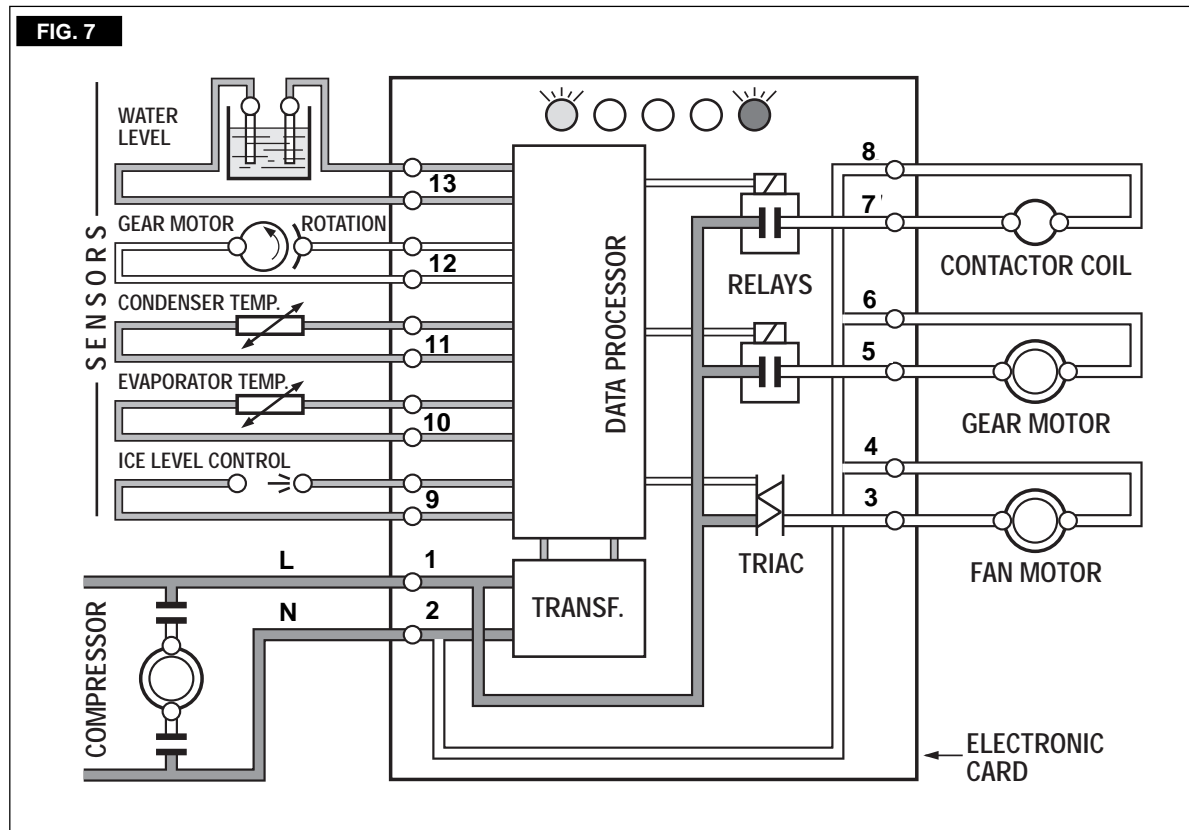



**REFRIGERANT METERING DEVICE:**

capillary tube

**NOTE.** Before charging the refrigerant system always check the type of refrigerant and quantity as specified on the individual ice machine dataplate.  
The refrigerant charges indicated are relatives to averages operating conditions.

**REFRIGERANT CHARGE (R 134 A)**

	air cooled	water cooled
<b>AF 80</b>	340 gr	310 gr

**REFRIGERANT CHARGE (R 404 A)**

	air cooled	water cooled
<b>AF 103</b>	450 gr	300 gr
<b>AF 124</b>	420 gr	300 gr
<b>AF 156</b>	490 gr	300 gr
<b>AF 206</b>	660 gr	520 gr

**OPERATING PRESSURES**  
(With 21°C ambient temperature)

		<b>AF 80</b>	<b>AF 103</b>	<b>AF 124</b>	<b>AF 156</b>	<b>AF 206</b>
Discharge pressure	Air cooled	8.5 ÷ 10 bar 125 ÷ 145 psig	17 - 18 bar 245 - 260 psig			
	Water cooled	9.5 bar 140 psig	17 bar 245 psig			
Suction pressure	Air cooled	0.4 ÷ 0.8 bar 6 ÷ 12 psig	2.6 bar 38 psig	2.2 bar 32 psig	2.6 bar 38 psig	2.5 bar 36 psig
	Water cooled	0.4 ÷ 0.8 bar 6 ÷ 12 psig	2.7 bar 39 psig	2.5 bar 36 psig	2.6 bar 38 psig	2.4 bar 35 psig

## COMPONENTS DESCRIPTION

### A. GREEN MASTER SWITCH PUSH BUTTON

Located in the front of the machine it's used to switch ON and OFF the unit by pushing its green push button. When ON, its green light is ON as well.

### B. RED ALARM/RE-SET PUSH BUTTON

Located in the front of the machine (just beside the Master Switch) it works in conjunction with the Cleaning Remind Board and it's activated when:

- Consensing temperature is higher then 70°C (air cooled version) - **ON steady with machine in OFF mode**
- Consensing temperature is higher then 60°C (water cooled version) - **ON steady with machine in OFF mode**
- Condenser sensor out of order - **Blinking twice and repeat with machine in OFF mode**
- Condenser air filter need to be cleaned - **ON steady with machine in ON mode**
- Water system need to be cleaned - **Slow blinking with machine in ON mode.**

On the first two cases it's possible to Re-Set the operation of the machine pushing and hold the Red Alarm Re-Set Button by 5" till the Red Light is OFF.

On the third case, it's necessary first to replace the condenser sensor then, push and hold for 5" the Red Re-Set Button.

On the last case, to start up a new countdown and remove the signal from the Red Light, push and hold the Red Light Switch for 5 sec till stops to blink with machine/PC Board energized since more of 30 seconds.

### C. EVAPORATOR TEMPERATURE SENSOR

The evaporator sensor probe is inserted into its tube well, which is welded on the evaporator outlet line, it detects the temperature of the refrigerant on the way out from the evaporator and signals it by supplying a low voltage current flow to the P.C. Board Micro-Processor.

According to the current received, the micro-processor let the ice maker to continue its operations. In case the evaporating temperature, after 10 minutes from the unit start-up, does not go below -1°C (30°F) due to shortage of refrigerant in the system the evaporator sensor signal reaching the microprocessor is such to stop immediately the unit operation (drive motor keeps on working by 3' delay then stops), with the 5th Warning YELLOW LED that blinks.

**NOTE.** The machine will remain in OFF mode for one hour then it will restart automatically. In case the unit trips OFF again in alarm for 3 times in 3 hours, the machine SHUTS OFF DEFINITELY.

To restart the unit after the shutoff caused by the hi evaporating temperature, it is necessary to switch OFF and ON the power line main disconnect Switch.

### D. WATER LEVEL SENSOR

This sensor system consist of two small stainless steel rods vertically fitted on the inner face of the reservoir cover and electrically connected to the low voltage circuit of the P.C. Board. When the cover of the reservoir is positioned in its place the tips of both the rods dip into the reservoir water and detects and signals its presence by making use of its electrical resistance.

**NOTE.** In the event of **shortage of water** in the reservoir or, in case the water used is too soft (de-mineralized) to cause greater resistance to the current flow (conductivity lower than 30µS) this sensor system causes the **shutoff of the machine** (drive motor keeps on working by 3' delay then stops), to protect it from running with an interrupted or inadequate water supply. In this situation the **YELLOW LED** will glow to warn of the machine shutoff and the reason why.

### E. CONDENSER TEMPERATURE SENSOR

The condenser temperature sensor probe, located within the condenser fins (air cooled version) or in contact with the tube coil (water cooled version) detects the condenser temperature variations and signals them by supplying current, at low voltage, to the P.C. BOARD.

In case the condenser temperature sensor detects a temperature at the condenser lower than **+1°C (33°F)** that signify that the ambient temperature is at the same value, therefore it is too low for the correct unit operation, the sensor signals to the microprocessor to stop immediately or to do not start the unit operations up to the moment that the ambient temperature will rise to more acceptables conditions (5°C).

In the air cooled versions, in relation to the different current received, the micro processor of the P.C. BOARD supplies, through a TRIAC, the power at high voltage to the fan motor so that it can cool the condenser and reduce its temperature. In the event the condenser temperature rises and reaches **70°C** or **60°C** the current arriving to the micro processor is such to cause an immediate and total stop of the machine operation (drive motor keeps on working by 3' delay then stops).

**NOTE.** The machine will remain in OFF mode for one hour then it will restart automatically. In case the unit trips OFF again in alarm for 3 times in 3 hours, the machine SHUTS OFF DEFINITELY.

To restart the unit after the shutoff caused by the hi condenser temperature, it is necessary to switch OFF and ON the power line main disconnect Switch.

### F. GEAR MOTOR ROTATION AND SPEED SENSOR

This safety device is housed on top of the Drive Motor and detects - based on Hall Effect principle - the rotating speed and rotating direction of the drive Motor.

Should the rotating speed drop below 1300 r.p.m. the magnitude measured by this device is such to signal to the microprocessor to stop the unit and light-up the YELLOW LED. About the same reaction occurs when the drive motor will tend to rotate in the wrong direction (counterclockwise) situation that, if it occurs, will greatly affect all the freezer and gear reducer components.

**NOTE.** The machine will remain in OFF mode for one hour then it will restart automatically. In case the unit trips OFF again in alarm for 3 times in 3 hours, the machine SHUTS OFF DEFINITELY. To restart the unit after the shutoff caused by this safety device, it is necessary first to eliminate the cause that has generated the intervention of the device and then switch OFF and ON the power line main disconnect switch.

### G. ICE BIN LEVEL LIGHT CONTROL

The electronic ice bin level control, located into the ice spout, has the function to stop the operation of the ice machine when the light beam between the light source and the sensor gets interrupted by the flake ice which accumulates in the spout. When the light beam is interrupted the **Bin Full YELLOW LED** located in the front of the P.C. BOARD blinks; in case the light beam gets interrupted for as long as 10 seconds, the ice machine stops (drive motor keeps on working by 3' delay then stops) with the glowing-up of the **2nd YELLOW LED** to monitor the full ice bin situation. The 10 seconds of delay prevents that any minimum interruption of the light beam due to the regular ice chuting through the ice spout may stop the operation of the unit.

**NOTE.** During the life of the machine the Ice Level Control may require a recalibration mainly when the glass of the two optical eyes are covered by a thin lay of scale. To do it just follow the following procedure:

- With unit OFF push and old the Reset Button of the PC Board
- Give power to the machine through the Green Master Switch
- Hold the PC Board Reset Button till the leds start to blink/flash (more or less 10 seconds)
- Release the PC Board Reset Button

The Optical Ice Level Control is now recalibrated.

Check for the correct operation of the Optical Ice Level Control by plasing a handfull of ice in between the two eyes.

The Bin Full yellow led must start to blink/flash immediately and, 10 seconds later, the machine must trip OFF.

As soon as the ice is scooped out (with the resumption of the light beam between the two infrared sensor of ice level control) 10 seconds later the ice machine resumes its operation with the simultaneous extinguishing the 2nd YELLOW LED.

### H. P.C. BOARD (Data processor)

The **P.C. BOARD**, fitted in its plastic box located in the front of the unit, consists of two separated printed circuits one at high and the other at low voltage and protected by fuses. Also it consists of five aligned **LEDS** monitoring the operation of the machine of three jumpers (TEST used only in the factory, 60/70°C used to set up the PC Board at proper safety cut out condensing temperature and 3' to by pass the 3 minutes Stand By) and of input terminals for the leads of the sensor probes as well as input and output terminals for the leads of the ice maker electrical wires.

The P.C. BOARD is the brain of the system and it elaborates, through its micro processor, the signals received from the sensors in order to control the operation of the different electrical components of the ice maker (compressor, gear motor, etc.).

The five LEDES, placed in a row in the front of the P.C. BOARD, monitor the following situations:

#### GREEN LED

Unit under electrical power



#### YELLOW LED

- Blinking: **I/R beam cut out**
- Steady: **unit shut-off at storage bin full**
- Blinking fast: **I/R beam resumed**

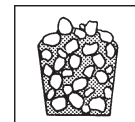

#### YELLOW LED

Unit shut-off due to a **too lo-water level** into float tank

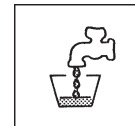

#### RED LED

##### ON all the time

- Unit shut-off due to a **too hi-condensing temperature**
- Unit shut-off due to a **too lo-ambient temperature <+1°C**

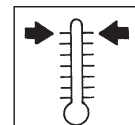

##### Blinking

3 minutes start up delay time

#### YELLOW LED

##### ON all the time

- Unit shut-off due to the **wrong rotation direction** of gear motor
- Unit shut-off due to the **too lo speed of gear motor**



##### Blinking

- Unit shut-off due to a **too hi- evaporating temp. >-1°C** after 10 min of operation

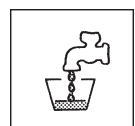

#### YELLOW AND RED LED

- Blinking: **Evaporator sensor out of order**
- Steady: **Condenser sensor out of order**
- Blinking alternatively: **Ice level control out of order**

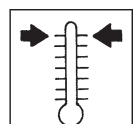

**TO BY-PASS THE 3'/60' STAND BY TIME, SIMPLY JUMP "TEST" CONTACTS WITH PCB ENERGIZED**

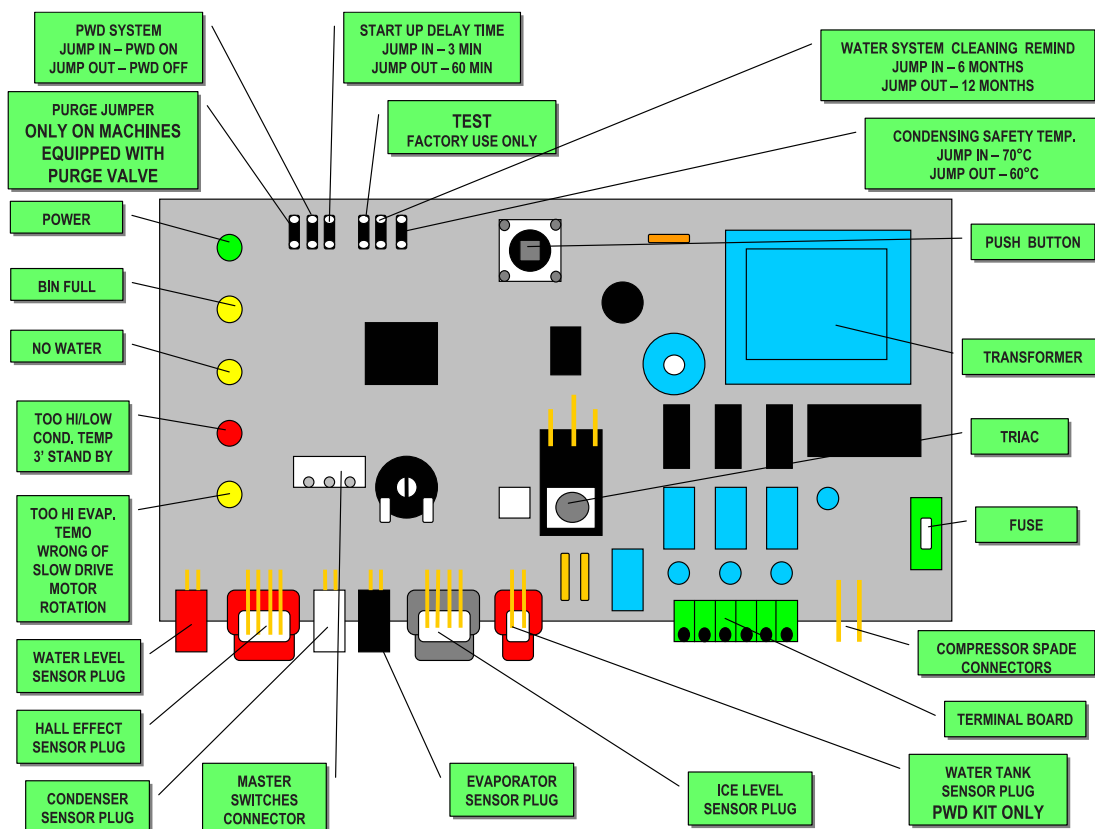

The Flaker PCB Board is equipped by three jumpers:

J1

**PURGE** Used on machine equipped with Water Purge Valve to purge out the water from the water system every 12 hours and when the machine restart from the Bin Full

JUMP IN - Purge activated  
JUMP OUT - Purge deactivated

**PWD** Used to Pump Out the water by means of the Progressive Water Pump supplied as a kit

JUMP IN - No Progressive Water Pump installed/in operation  
JUMP OUT - Progressive Water Pump installed/in operation

3'/60'

Delay time at start up  
JUMP IN - 3 minutes delay  
JUMP OUT - 60 minutes delay

J2

**TEST** Factory use ONLY  
6/12 M Cleaning remind for the water system - Red Light blinks/flashes with machine ON

JUMP IN - 12 months set up  
JUMP OUT - 6 months set up

60/70°C Set up of the Safety Condensing Temperature Sensor  
JUMP IN - 70°C  
JUMP OUT - 60°C

**J. EXTERNAL SWITCHES SOCKET**

Connected to the external Green Master and Red Alarm Reset Switches, it receives power from the Master Switch as well as it provides power to the Red Alarm switch in order to signal any possible uncorrect operation condition of the machine as clogged air filter (air cooled version only) or short/missing of condensing water (water cooled version) as detailed at item B.

It signal also the time for the cleaning of the water system of the machine, cleaning that can be change, according to the local water conditions, from six month (standard - Jump In) to twelve months (Jump Out).

Once cleaned the water system, it's necessary to cancel the time stored into the PC Board by pushing and hold for more then 5" the Red Alarm Re-Set Button till it stops to blink.

**K. FLOAT RESERVOIR**

The float reservoir consists of a plastic water pan on which is fitted a float valve with its setting screw. The float valve modulate the incoming water flow to maintain a constant water level in the reservoir, level that corresponds to the one in the freezing cylinder to ensure proper ice formation and fluidity.

On the inner side of the reservoir cover are fitted the two water level sensors which detects the presence or the shortage of water in the reservoir.

**NOTE.** *It is very important to make sure of the correct fitting of the cover on the reservoir in order to enable the sensor to efficiently control the water situation avoiding undue shutoff interventions.*

#### L. FREEZING CYLINDER (EVAPORATOR)

The freezing cylinder is made of a stainless steel vertical tube on which exterior is wrapped around the cooling coil with the evaporating chamber and in its interior is located the auger which rotates on its vertical axis and it is maintained aligned by the top and bottom bearings. A water seal system is located in the bottom part of the freezer while at the top end is fitted the ice breaker.

The water constantly flowing into the cylinder bottom part, freezes into ice when in contact with the cylinder inner walls. The ice is then lifted up by the rotating auger and compacted and forced out by the ice breaker.

#### M. ICE BREAKER

The ice breaker is fitted in the freezer upper part it has two breaker teeth to break the ice and with its slanted shape from the rear tooth to the front one it compacts and forces the ice out in an horizontal way. By undergoing this, the ice loses its excess of water content so it drops into the bin in hard dry bits of ice.

In the ice breaker it is housed the top bearing which is made of two rolls bearings positioned to withstand the auger axial and radial loads. This bearing is lubricated with a food grade - water resistant grease.

**NOTE.** *It is advisable to check the conditions of both the lubricant grease and the top bearing every six months.*

#### N. DRIVE GEAR MOTOR

This motoreducer is made of a single phase electric motor with permanent capacitor directly fitted on a gear box.

The drive motor rotor is kept aligned on its vertical axis by two ball bearings permanently lubricated. The gear case contains a train of three spur gears the first one of which is in fiber to limit the noise level. All the three gears are encased in case bearings and are covered by lubricant grease (MOBILPLEX IP 44).

Two seal rings, one fitted on the rotor shaft and the other on the output shaft keep the gear case sealed.

However, the interior can be inspected and serviced by unbolting the two halves of the aluminium gear case housing.

The gear reducer output shaft is connected to the freezer auger by a ratched coupling which is made of two toothed halves that engages themselves only if turned in the correct direction namely, counterclockwise.

#### O. FAN MOTOR (Air cooled version)

The fan motor is controlled through the P.C. BOARD and the TRIAC by the condenser temperature sensor. Normally it operates to draw cooling air through the condenser fins.

In cold ambient situation, the fan motor can run at intermittance as the condenser pressure must be kept between two corresponding head pressure values 17÷18 bar-245÷260 psig.

#### P. WATER REGULATING VALVE (Water cooled version)

This valve controls the head pressure in the refrigerant system by regulating the flow of water going to the condenser.

As pressure increases, the water regulating valve opens to increase the flow of cooling water.

#### Q. COMPRESSOR

The hermetic compressor is the heart of the refrigerant system and it is used to circulate and retrieve the refrigerant throughout the entire system. It compresses the low pressure refrigerant vapor causing its temperature to rise and become high pressure hot vapor which is then released through the discharge valve.

## ADJUSTMENT, REMOVAL AND REPLACEMENT PROCEDURES

**NOTE.** Read the instructions thoroughly before performing any of the following adjustment or removal and replacement procedure.

### A. ADJUSTMENT OF THE EVAPORATOR WATER LEVEL

The correct water level in the freezing cylinder is about 25 mm. (1") below the ice discharge opening. Low water level causes excessive strain inside the freezer assembly due to a faster freezing rate.

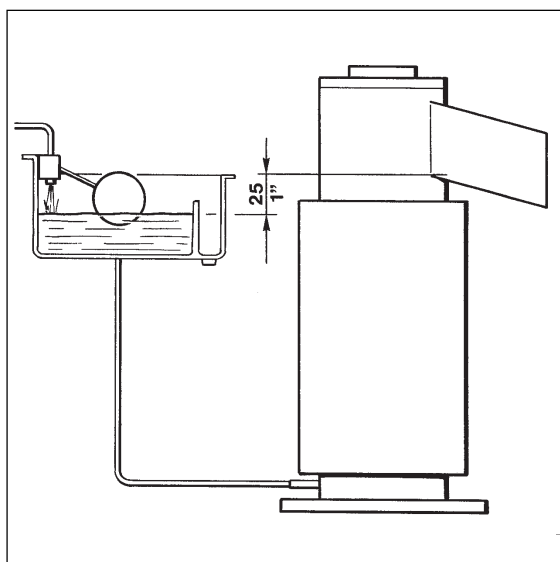

When the water level is above or below the correct one, adjustment can be performed to Raise or Lower the water level by raising or lowering at the measure required, the water reservoir and its mounting bracket.

1. To Raise the water level:

a. Loosen and remove the screw securing the mounting bracket of the water reservoir to the unit cabinet and raise the water reservoir to the correct level.

b. Thread the mounting screw in the corresponding hole and tighten it.

2. To Lower the water level follow the above indications to lower to the correct level the water reservoir assembly.

**WARNING.** Be sure the electrical power supply circuit breaker and the inlet water supply are OFF, before starting any of the following Removal and Replacement procedures as a precaution to prevent possible personal injury or damage to the equipments.

### B. REPLACEMENT OF EVAPORATOR TEMPERATURE SENSOR

1. Remove the front and top panels.
2. Remove the insulation from the refrigerant tubing, connecting the freezer to the accumulator, to gain access to the sensor probe well and be able to pull out from this well the sensor probe.
3. Trace the condenser sensor terminal plug (blue) on the left side of the control box and remove it from its socket by carefully pulling out the terminal plug securing clip.
4. To install the replacement evaporator sensor follow the above steps in reverse.

### C. REPLACEMENT OF CONDENSER TEMPERATURE SENSOR

1. Remove the front panel.
2. Trace the condenser sensor probe located within the condenser fins on air cooled version and withthrow it. On water cooled version remove it by opening the plastic strap (reusable) securing the probe to the refrigerant liquid line.
3. Trace the condenser sensor terminal plug (black) on the left side of the control box and remove it from its socket by carefully pulling out the terminal plug securing clip.
4. To install the replacement condenser sensor follow the above steps in reverse.

### D. REPLACEMENT OF THE ICE LEVEL LIGHT CONTROL

1. Remove the front and top panels.
2. Trace the ice level light control terminal plug (black and with four terminal pins) on the left side of the control box and draw it out from its socket by carefully slackening the fastening tie.
3. Unloose the two screws holding the optical ice level control to the upper side of the spout and remove it.
4. To install the replacement ice level light control follow the above steps in reverse.

### E. REPLACEMENT OF THE GEAR MOTOR ROTATION AND SPEED SENSOR

1. Remove the front and top panels.



- Unloose the three screws securing the plastic cover to the gear motor speed sensor housing and remove it.
- Unloose the two screws securing the sensor to the plastic housing and withdraw it from its seat.
- Trace the gear motor speed sensor terminal plug (red with four pins) on the left side of the control box and draw it out from its socket by carefully slackening the fastening tie.
- To install the replacement gear motor rotation and speed sensor follow the above steps in reverse.

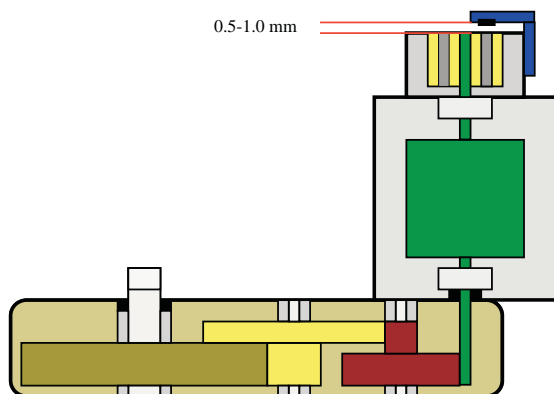

#### F. REPLACEMENT OF THE RESERVOIR WATER LEVEL SENSOR

- Remove the front and top panels.
- Unloose the two nuts securing the wire leads to the two water level sensor rods located on the water reservoir plastic cover.
- Trace the water level sensor terminal plug (red) on the left side of the control box and draw it out from its socket by carefully slackening the fastening tie.
- To install the replacement water level sensor follow the above steps in reverse.

#### G. REPLACEMENT OF P.C. BOARD

- Remove front panel.
- Remove all sensor terminal plugs, located on the left side of P.C. Board, by carefully releasing them out from their sockets clips.
- Disconnect the terminal board connection plug from the rear side of P.C. BOARD then unloose the four screws holding the same to the plastic control box and remove it.
- To install the replacement P.C. BOARD follow the above steps on reverse.

**NOTE.** In case the TEST contacts are jumped together (it is a possibility when PC Board is replace as spare parts), the machine starts up immediately with all the electrical parts (compressor, drive motor and fan motor start together with no delay). This for 3 minutes then the machine stops with all LEDs blinking.

#### H. REPLACEMENT OF THE ICE SPOUT

- Remove the top panel.
- Slacken and remove the two metal straps that hold tight the polystyrene insulations against the freezer upper part.
- Remove the optical ice level control.
- Unloose and remove the two screws and the spout from the freezer cylinder.
- To install the replacement spout follow previous steps in reverse.

#### I. REPLACEMENT OF THE AUGER, WATER SEAL, BEARINGS AND COUPLING

- Remove the front, side and top panels.
- Follow the steps at item H to remove the ice spout.
- Grasp the wire cap hook at the top of the freezer and pull out the auger and attached cap, ice breaker, bearings and O rings, at the top of the auger, and the top half of the water seal at the auger bottom.

**NOTE.** If the auger cannot be pulled out, proceed to steps 9 and 10 of this paragraph, to gain access to the auger bottom. Then, with a rowhide mallet or placing a piece of wood on the bottom end of the auger, tap this bottom to break loose the auger and be able then to pull it out as in step 3 above.

- With a circlip plier remove the retaining ring and cap hook from the ice breaker.
- Unloose and remove cap screw and remove the ice breaker from the auger.
- Clean away the old grease from the interior of the ice breaker and inspect the conditions of the O ring; if torn or worn replace it.
- Inspect the bearing pressed into the top of the ice breaker and if worn do not hesitate to replace it.

**WARNING.** The top bearing assembly works in critical conditions for what concern its lubrication status as it is housed in the ice breaker where the formation of a great rate of condensation is usual. Therefore it is important to apply on it an ample coating of Food grade Waterproof Grease P/N 263612.00 before installing the breaker and cap hook in place.

8. Slide off from the auger bottom the upper half of the water seal.

**NOTE.** Any time the auger is removed for replacement or inspection use extra care in handling the water seal parts, so no dirt or foreign matters are deposited on the surfaces of the seal. If there is any doubt about the effectiveness of the water seal or O ring do not hesitate to REPLACE THEM.

9. Unloose and remove the three bolts and lockwashers which attach the freezer assy to the aluminium adaptor.

10. Raise the freezer assy off the adaptor, secure it out of the way to allow room to work. Using a suitable length and size wooden dowel or stick inserted through the top of the open freezer, tap the lower half of the water seal and the lower bearing out the bottom of the freezer.

**NOTE.** It is good practice to replace the water seal assy and both the top and the bottom bearings any time the auger is removed.  
To facilitate this, SCOTSMAN EUROPE Service makes available a service Kit P/N 001028.07 which includes besides the above mentioned parts, the ice breaker O ring and a can of food grade waterproof grease.

11. Reach through the adaptor and remove the coupling parts.

12. Check both the coupling halves for chipping and wear and do not hesitate to replace them.

13. To install the ratched coupling, the water seal, the bearings and auger follow previous steps in reverse.

**NOTE.** It is very important to provide correct/proper lubrication of the inside bore of the upper semi-coupling as well as to the external surfaces of the teeth as shown on the here below photo.  
The correct lubrication allows the upper semi-coupling to move it down, by the load of the upper spring, in case of any rising up during its rotation.

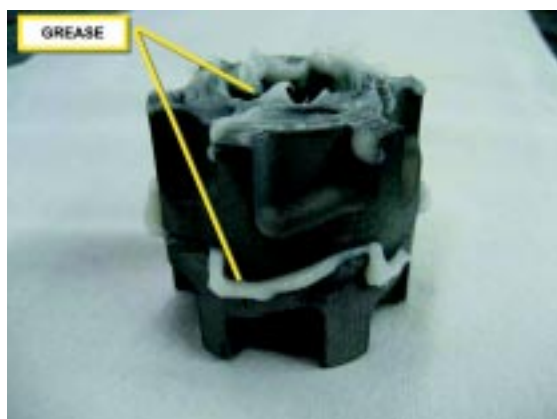

**NOTE.** Install the upper bearing into the ice breaker starting by the radial portion that must be fitted with the flat surface facing up. Apply some lubricant (grease) on the upper surface then install the rollers cage with the smaller openings of the same facing up so to leave a small gap between plastic cage and flat surface of the bottom portion of the bearing (see drawing).

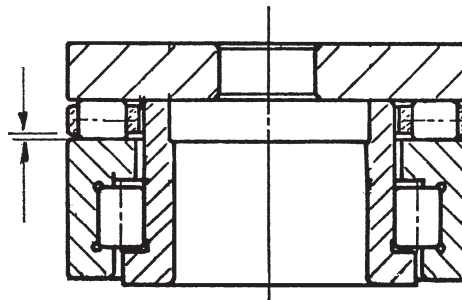

Apply some more lubricant then place the S.S. trust washer.

#### J. REPLACEMENT OF THE GEAR MOTOR ASSY

1. Remove the rear side and top panels.
2. Remove the three bolts and washers securing the gear reducer base to the unit chassis, then remove bolts and lockwashers which attach the bottom of the aluminium adaptor to the gear reducer case cover.
3. Disconnect the electrical leads from the electromagnetic safety device located on top of drive motor.
4. Trace and disconnect the electric wires leads of the drive motor. Lift and remove the entire gear motor assembly.
5. To install the replacement gear motor assy follow the above steps in reverse.

#### K. REPLACEMENT OF FAN MOTOR

1. Remove front and side panels.
2. Remove screws and yellow green ground wire. Trace the electrical leads of fan motor and disconnect them.
3. Remove the bolts securing the fan motor bracket to the cabinet base and then remove the assembly.
4. To install the replacement fan motor follow the above steps in reverse.

**NOTE.** When installing a new fan motor check that the fan blades do not touch any surface and move freely.



## L. REPLACEMENT OF DRIER

1. Remove front and side panels.
2. Recover the refrigerant from the system and transfer it in a container so to reclaim or recycle it.
3. Unsolder the capillary tube and the refrigerant line from the two ends of the drier.
4. To install the replacement drier remove factory seals and solder the refrigerant lines and the capillary tube taking precautions to NOT OVERHEAT the drier body.
5. Thoroughly evacuate the system to remove moisture and non condensable after drier replacement.
6. Charge the system with refrigerant 134 A by weight (see data plate of machine) and check for leaks.
7. Replace panels previously removed.

## M. REPLACEMENT OF THE FREEZING CYLINDER

1. Follow the steps at item H to remove the ice spout.
2. Remove the clamp fastening the water hose to the water inlet port of the freezer assy. Place a water pan under this water inlet port then disconnect the water hose and collect all water flowing from freezer and from water hose.
3. Withdraw the evaporator sensor probe from the its holder as stated in item B.
4. Recover the refrigerant from the system and transfer it in a container so to reclaim or recycle it.
5. Unsolder and disconnect the capillary tube and the accumulator/suction line assy from the outlet line of the freezing cylinder.
6. Remove the three bolts and washers securing the gear reducer base to the unit chassis, then remove bolts and lockwashers which attach the bottom of the aluminium adaptor to the gear reducer case cover.
7. Lift the freezer up and off the gear motor assembly, then if necessary remove the aluminium adaptor by removing the three mounting screws and lockwashers.

**NOTE. It is imperative to install a replacement drier whenever the sealed refrigeration system is open.**  
Do not replace the drier until all other repairs or replacements have been completed.

8. To install the replacement evaporator follow the above steps in reverse.

**NOTE. Thoroughly evacuate the system to remove moisture and non condensables after evaporator replacement.**

## N. REPLACEMENT OF AIR COOLED CONDENSER

1. Remove front and side panels.
2. Remove from the condenser fins the condenser ambient temperature sensor probes.
3. Remove the two bolts attaching the condenser to the base.
4. Recover the refrigerant from the system and transfer it in a container so to reclaim or recycle it.
5. Unsolder the refrigerant lines from the condenser and remove it from the unit.

**NOTE. It is imperative to install a replacement drier whenever the sealed refrigeration system is open.**  
Do not replace the drier until all other repairs or replacements have been completed.

6. To install the replacement condenser follow the above steps in reverse.

**NOTE. Thoroughly evacuate the system to remove moisture and non condensables after condenser replacement.**

## O. REPLACEMENT OF WATER COOLED CONDENSER

1. Remove front and side panels.
2. Remove the condenser temperature sensor probes from condenser.
3. Remove bolts which secure the condenser to the unit base.
4. Remove the corbin clamps and disconnect the plastic hoses from the water cooled condenser.
5. Recover the refrigerant from the system and transfer it in a container so to reclaim or recycle it.
6. Unsolder the refrigerant lines from the condenser and remove it from the unit.

**NOTE. It is imperative to install a replacement drier whenever the sealed refrigeration system is open.**  
Do not replace the drier until all other repairs or replacements have been completed.

7. To install the replacement condenser follow the above steps in reverse.

**NOTE.** Thoroughly evacuate the system to remove moisture and non condensables after condenser replacement.

#### P. REPLACEMENT OF WATER REGULATING VALVE (WATER COOLED MODELS)

1. Remove front and rear panels.
2. Close the shut-off valve on the water supply line and disconnect it at the rear of the flaker.
3. Remove corbin clamp and disconnect the water hose from the outlet of water regulating valve.
4. Unloose the nut securing the water regulating valve to the unit frame.
5. Recover the refrigerant from the system and transfer it in a container so to reclaim or recycle it.
6. Trace the water regulating valve capillary tube and unsolder its end from the refrigerant line then remove it from the unit.

**NOTE.** It is imperative to install a replacement drier whenever the sealed refrigeration system is open. Do not replace the drier until all other repairs or replacements have been completed.

7. To install the replacement water regulating valve follow the above steps in reverse.

**NOTE.** Thoroughly evacuate the system to remove moisture and non condensables after water regulating valve replacement.

**NOTE.** The water flow that passes through the valve can be adjusted by means of the valve setting stem in order to have a condensing pressure of 9.5 bars (138 psig).

#### Q. REPLACEMENT OF COMPRESSOR

1. Remove back and front panels.

2. Remove the cover and disconnect the electrical leads from the compressor junction box.

3. Recover the refrigerant from the system and transfer it in a container so to reclaim or recycle it.

4. Unsolder and disconnect both the suction line and the discharge line from the compressor.

5. Remove the four compressor mounting bolts and the compressor from the unit base.

6. Unsolder suction and process header from compressor and retain it to be used on new compressor.

**NOTE.** It is imperative to install a replacement drier whenever the sealed refrigeration system is open. Do not replace the drier until all other repairs or replacements have been completed.

7. To install the replacement compressor follow the above steps in reverse.

**NOTE.** Thoroughly evacuate the system to remove moisture and non condensables after compressor replacement.

#### R. REPLACEMENT OF THE GEAR MOTOR MAGNETIC SENSOR

1. Remove top and back panel.

2. Unloose the three screws securing the plastic cover to the top of the gear motor and remove it.

3. Unloose the two screws securing the magnetic sensor to the plastic housing and withdraw it from its seat.









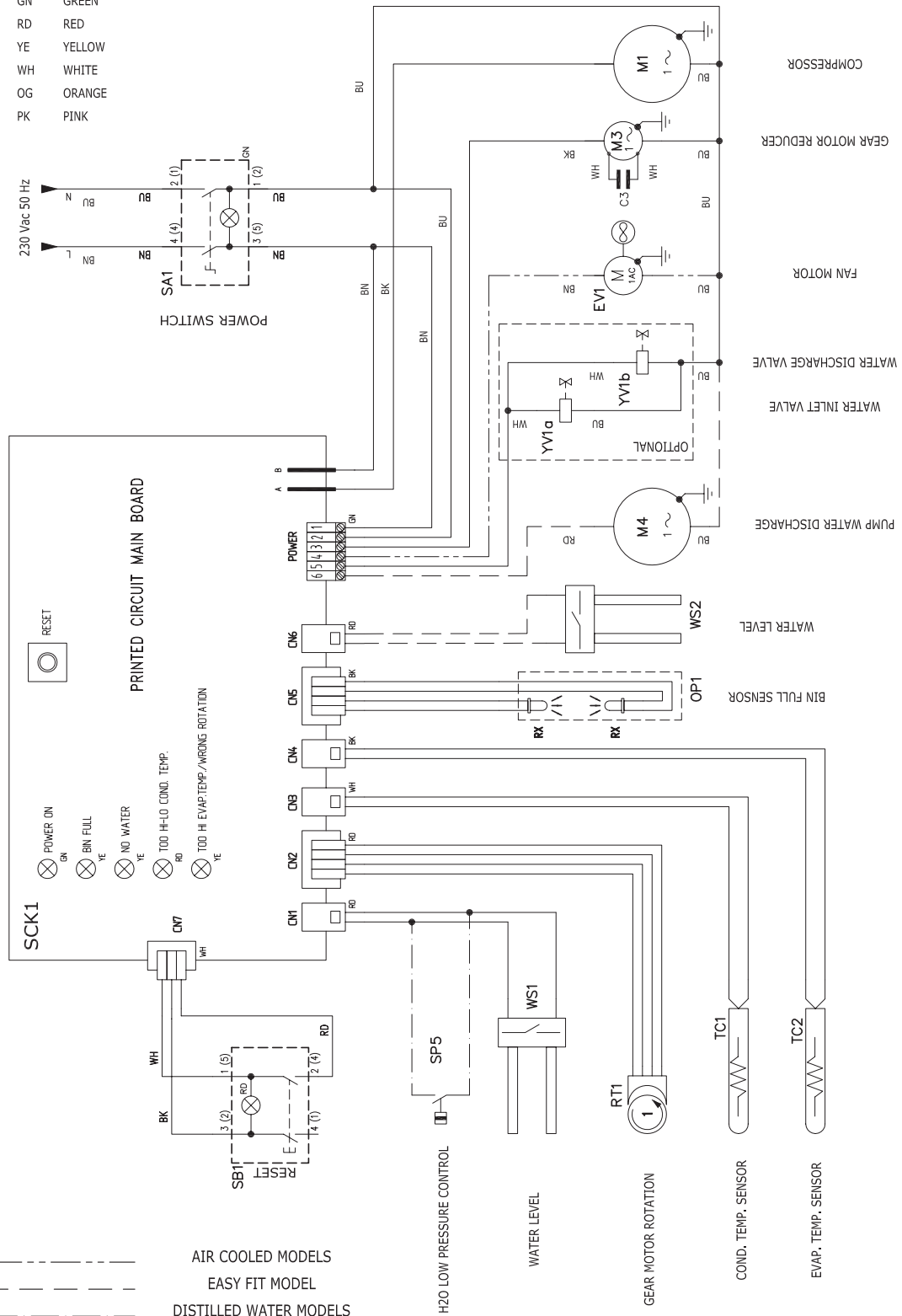







4. Trace the gear motor magnetic sensor terminal plug on the rear side of the control box (red with four terminal pins) and draw it out from its socket by carefully slackening the fastening tie.

5. To install the replacement gear motor magnetic sensor follow the above steps in reverse.

## WIRING DIAGRAM AIR AND WATER COOLED 230/50-60/1

- BK BLACK
- BN BROWN
- BU BLUE
- GY GREY
- GYE GREEN-YELLOW
- GN GREEN
- RD RED
- YE YELLOW
- WH WHITE
- OG ORANGE
- PK PINK



Sim.\Sym.	Sigla\Item	Funzione\Use Type	Sim.\Sym.	Sigla\Item	Funzione\Use Type	Sim.\Sym.	Sigla\Item	Funzione\Use Type
	EV1	Fan motor Ventilatore		SP5	H2O Low pressure control Pressostato acqua			
	M1	Compressor Compressore		WS2	Water level control Controllo livello acqua			
	M3	Drive Motor Motoriduttore		M4	Pump water discharge Pompa scarico acqua			
	OP1	BIN full sensor Sensore contenitore pieno		SA1	Power switch Interruttore generale			
	RT1	Gear motor rotation sensor Sensore rotazione motoriduttore		SB1	Reset push button Pulsante di reset			
	SCK1	Printed circuit command board Scheda elettronica di comando						
	WS1	Water level control Controllo livello acqua						
	TC1	Condenser temperature sensor Sensore temperatura condensatore						
	TC2	Evaporator temperature sensor Sensore temperatura evaporatore						
	YV1a	Water inlet valve Elettrovalvola scarico acqua						
	YV1b	Water discharge valve Elettrovalvola scarico acqua						

**SERVICE DIAGNOSIS**

<b>SYMPTON</b>	<b>POSSIBLE CAUSE</b>	<b>SUGGESTED CORRECTION</b>
Unit will not run No LED lighted-up	Blown fuse in P.C.Board	Replace fuse & check for cause of blown fuse
	Master switch in OFF position	Turn switch to ON position
	Inoperative P.C.Board	Replace P.C.Board
	Loose electrical connections	Check wiring
Bin full yellow LED glows with no ice in the bin	Inoperative or dirty ice level control	Replace or clean ice level control
Water yellow LED glows	Shortage or too soft water	See remedies for shortage of water or install a mineral salt metering device
Red-alarm LED glows	High head pressure	Dirty condenser. Clean Inoperative fan motor. Replace
	Ambient temperature too low	Move unit in warmer location
Reverse rotation yellow LED blinks	Too hi evap. temperature Shortage or lack of refrigerant	Check and charge refrigerant system
Reverse rotation yellow LED glows	Gear motor turns on reverse	Check gear motor capacitor
	Too low gear motor rotating speed	Check rotor bearings, freezer bearings and interior of freezer for scores. Replace whatever worn or damaged.
	No rotation of gear motor	Check for power to drive motor (16 A fuses) Check for stator winding
	Gear motor starts and stop after a while	Check for correct operation of drive motor magnetic sensor Check for correct magnetic capacity of magnetic cylinder
Water yellow LED and red LED ON (steady) together	Inoperative Condenser Sensor	Replace it.
Water yellow LED and red LED blink together	Inoperative Evaporator Sensor	Replace it.
Water yellow LED and red LED blink alternatively	Inoperative Ice Level Control	Replace it.
Compressor cycles intermittently	Low voltage	Check circuit for overloading Check voltage at the supply to the building. If low, contact the power company
	Non-condensable gas in system	Purge the system
	Compressor starting device with	Check for loose wires in starting loose wires device
Low ice production	Capillary tube partially restricted	Blow charge, add new gas & drier, after evacuating system with vacuum pump
	Moisture in the system	Same as above
	Low water level in the freezer	Adjust to approx 20 mm below ice spout
	Shortage of refrigerant	Check for leaks & recharge
	Pitted or stained auger surface	Clean or replace auger

**SERVICE DIAGNOSIS**

<b>SYMPTON</b>	<b>POSSIBLE CAUSE</b>	<b>SUGGESTED CORRECTION</b>
Wet ice	Ambinet temperature too high High water level in the freezer Faulty compressor	Move unit to cooler location Lower to approx. 20 mm below ice spout Replace
Machine runs but makes no ice	Water not entering in the freezer Gear stripped Moisture in the system	Air look in feed line to freezer. Clogged feed line to freezer. Clean it Check and repair Purge, replace drier and re-charge
Water leaks	Water seal leaking Water feed line to freezer leaking Float valve not closing Spout leaking	Replace water seal Check and fasten hose clamp Check and adjust float valve setting screw Tighten screws holding the spout
Excessive noise or chattering	Mineral or scale deposit on auger and inner freezer walls Low suction pressure Water feed line to freezer clogged Low water level into freezer	Remove and manually polish auger and inner walls of freezer barrel using emery paper Add refrigerant to rise suction pressure Vent and clean it Adjust to approx. 20 mm below ice spout
Gear motor noise	Worn rotor bearings Shortage or poor lubricant in gear case Gear case bearings and gear racers worn out	Check and replace Check for proper lubricant opening gear case. Top of gears must be covered with lubricant Check and replace worn parts
Shortage of water	Strainer at water inlet fitting clogged Float reservoir water nozzle clogged-up	Remove strainer and clean Remove float valve and clean nozzle

## MAINTENANCE AND CLEANING INSTRUCTION

### A. GENERAL

The periods and the procedures for maintenance and cleaning are given as guides and are not to be construed as absolute or invariable. Cleaning, especially, will vary depending upon local water and ambient conditions and the ice volume produced; and, each icemaker must be maintained individually, in accordance with its particular location requirements.

### B. ICEMAKER

The following maintenance should be scheduled at least two times per year on these icemakers.

1. Check and clean the water line strainer.
2. Remove the cover from the float reservoir - care to do not damage the two water sensors - and depress the float to make sure that a full stream of water enters into the reservoir.
3. Check that the icemaker is levelled in side to side and in front to rear directions.
4. Check that the water level in the water reservoir is below the overflow but high enough that it does not run out of the spout opening.

**NOTE.** *The float must close positively the incoming water flow when its fulcrum, housing the setting screw, is perpendicular to the water nozzle.*

5. Clean the water system, water reservoir and the interior of freezing cylinder using a solution of SCOTSMAN Ice Machine Cleaner. Refer to procedure C cleaning instructions and after cleaning will indicate frequency and procedure to be followed in local areas.

**NOTE.** *Cleaning requirements vary according to the local water conditions and individual user operation.*

6. If required, polish the two sensor rods secured to the float reservoir cover, heavy scale sediment on them can be removed with the help of a bit of SCOTSMAN Cleaner plain.

7. With the ice machine and fan motor OFF on air cooled models, clean condenser using vacuum cleaner, whisk broom or non metallic brush taking care to do not damage the condenser/ambient temperature sensor.

8. Check for water leaks and tighten drain line connections. Pour water down bin drain line to be sure that drain line is open and clear.

9. Check the ice level control sensor to test shut-off. Put some ice in front of the ice level control so to cut off the light beam for at least 10 seconds.

This should cause the immediate blinking of the Bin Full YELLOW LED located in the front of P.C. Board and, 10seconds later, the total stopping of the ice maker with the simultaneous light up of the Full Bin Yellow LED (steady).

**NOTE.** *Test the operation of the Ice Level Control using ice NOT HAND.*

Within few seconds from the removal of the ice between the sensor lights the ice maker resume its operation.

**NOTE.** *The ice level control uses devices that sense light, therefore they must be kept clean enough so they can "see".*

10. Check for refrigerant leaks and for proper frost line, which should frost as far as approx. 20 cm (8") from the compressor.

When doubtful about refrigerant charge, install refrigerant gauges on corresponding Schröder valves and check for correct refrigerant pressures. (See Operating pressure at page 20 of this manual).

11. Check that fan blades move freely and are not touching any surfaces.

12. Remove the retaining ring and the hook and cap from the top of the freezer assembly then inspect the top bearing, wipe clean of all grease and apply a coating of food grade water proof grease P/N 263612.00

**NOTE.** *It is recommended to use only food grade and waterproof grease to lubricate the freezer top bearing.*

13. Check the quality of ice. Ice flakes should be wet when formed, but will cure rapidly to normal hardness in the bin.

**NOTE.** *It is not abnormal for some water to emerge from the ice spout with the flaker ice.*

### C. CLEANING INSTRUCTIONS OF WATER SYSTEM

1. Switch OFF the Master disconnect switch on the power line.

2. Remove all ice stored in the bin to prevent it from getting contaminated with the cleaning solution.

3. Shut close the water shutoff valve on water line.
4. Remove the top panels to gain access to the water reservoir.
5. Remove the float reservoir cover and with a piece of copper wire jump the two water level sensors.
6. Place a water pan under the freezer water inlet port, disconnect the water hose from this port and allow the water from the freezer to flow into the pan previously positioned. Then refit the water hose to the freezer water inlet port.
7. Prepare the cleaning solution by diluting in a plastic container one or two liters of warm water (45°-50°C) with a 0,1-0,2 liters of **SCOTSMAN** Ice Machine Cleaner.

**WARNING. The SCOTSMAN Ice Machine Cleaner contains Phosphoric and Hydroxyacetic acids. These compounds are corrosive and may cause burns if swallowed, DO NOT induce vomiting. Give large amounts of water or milk. Call Physician immediately. In case of external contact flush with water. KEEP OUT OF THE REACH OF CHILDREN**

8. Switch ON the Master switch to start the unit then pour the cleaning solution into the float reservoir.
9. Wait for about three minutes for the unit to start operating, then continue to slowly pour the cleaning solution into the water reservoir taking care to maintain the level just below the overflow.

**NOTE.** *The ice made with the cleaning solution is slushy and coloured also, it may tend to loose fluidity creating some resistance in being elevated and extruded; this situation can be heard by the creaking noise made by the ice.*

*Should this occur it is recommended to stop for few minutes the ice machine in order to allow the ice in the freezer to partially melt.*

10. When all the cleaning solution has been used up, open the water shutoff valve to allow new fresh water to flow into the reservoir. Let the unit to continue to run until the ice resumes the normal colour and hardness.

11. Stop the icemaker and pour warm water on the ice deposited into the storage bin to melt it up.

**NOTE.** *DO NOT use ice produced with the cleaning solution. Be sure none remains in the bin.*

12. Pour into the water reservoir 1 cc. (approx 20 drops) of Scotsman Sanitiser (Antialgae P/N 264000.00) then switch the unit ON.

13. Left the unit running for approx 10 minutes then remove the copper wire used to jump the two sensors for the water level and place back correctly the cover on the float reservoir.

**NOTE.** *DO NOT use ice produced with the sanitising solution.*

14. With a sponge moisted with a sanitising solution, wipe clean all the bin interior surfaces.

**REMEMBER.** *To prevent the accumulation of undesirable bacteria it is necessary to sanitise the interior of the storage bin with an anti-algae disinfectant solution every week.*