

# Service Manual

## Air Conditioner



**Indoor Unit**  
**CS-E18RB4EAW**  
**CS-E21RB4EAW**

**Outdoor Unit**  
**CU-E18RBEA**  
**CU-E21RBEA**

**Destination**  
**Europe**  
**Turkey**

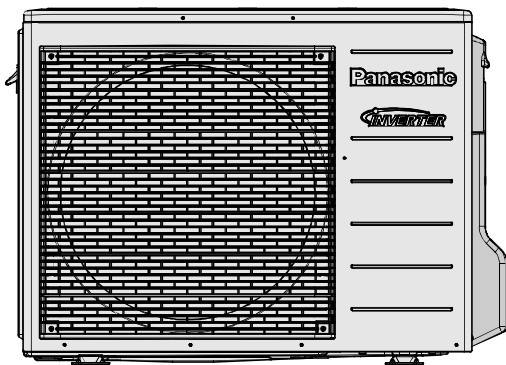

Please file and use this manual together with the Service Manual for Model No. CU-2E15PBE, CU-2E18PBE, CU-3E18PBE, CU-4E23PBE, CU-4E27PBE, CU-5E34PBE, Order No. PAPAMY1301048CE, PAPAMY1303046CE

### **⚠ WARNING**

This service information is designed for experienced repair technicians only and is not designed for use by the general public. It does not contain warnings or cautions to advise non-technical individuals of potential dangers in attempting to service a product. Products powered by electricity should be serviced or repaired only by experienced professional technicians. Any attempt to service or repair the products dealt with in this service information by anyone else could result in serious injury or death.

### **IMPORTANT SAFETY NOTICE**

There are special components used in this equipment which are important for safety. These parts are marked by **⚠** in the Schematic Diagrams, Circuit Board Diagrams, Exploded Views and Replacement Parts List. It is essential that these critical parts should be replaced with manufacturer's specified parts to prevent shock, fire or other hazards. Do not modify the original design without permission of manufacturer.

### **⚠ PRECAUTION OF LOW TEMPERATURE**

In order to avoid frostbite, be assured of no refrigerant leakage during the installation or repairing of refrigerant circuit.



# Panasonic®

# TABLE OF CONTENTS

<b>1. Safety Precautions</b> .....	<b>3</b>
<b>2. Specifications</b> .....	<b>5</b>
<b>3. Features</b> .....	<b>23</b>
<b>4. Location of Controls and Components</b> .....	<b>24</b>
4.1 Indoor Unit .....	24
4.2 Outdoor Unit .....	24
4.3 Remote Control .....	24
<b>5. Dimensions</b> .....	<b>25</b>
5.1 Indoor Unit .....	25
5.2 Outdoor Unit .....	26
<b>6. Refrigeration Cycle Diagram</b> .....	<b>27</b>
<b>7. Block Diagram</b> .....	<b>28</b>
<b>8. Wiring Connection Diagram</b> .....	<b>29</b>
8.1 Indoor Unit .....	29
8.2 Outdoor Unit .....	30
<b>9. Electronic Circuit Diagram</b> .....	<b>31</b>
9.1 Indoor Unit .....	31
9.2 Outdoor Unit .....	32
<b>10. Printed Circuit Board</b> .....	<b>33</b>
10.1 Indoor Unit .....	33
10.2 Outdoor Unit .....	35
<b>11. Installation Instruction</b> .....	<b>36</b>
11.1 Indoor Unit .....	36
11.2 Outdoor Unit .....	43
<b>12. Operation Control</b> .....	<b>48</b>
12.1 Basic Function .....	48
12.2 Indoor Fan Motor Operation .....	49
12.3 Outdoor Fan Motor Operation .....	50
12.4 Airflow Direction.....	51
12.5 Quiet Operation (Cooling Mode/Cooling Area of Dry Mode).....	51
12.6 Quiet Operation (Heating) .....	52
12.7 Powerful Mode Operation.....	52
12.8 Timer Control.....	52
12.9 Auto Restart Control .....	53
12.10 Indication Panel.....	53
12.11 Drain Pump Control Operation .....	53
12.12 HA Terminal (HAJEM-A) .....	54
<b>13. Protection Control</b> .....	<b>55</b>
13.1 Protection Control For All Operations.....	55
13.2 Protection Control For Cooling & Soft Dry Operation.....	57
13.3 Protection Control For Heating Operation..	58
<b>14. Servicing Mode</b> .....	<b>60</b>
14.1 Auto OFF/ON Button .....	60
14.2 Remote Control Button.....	61
14.3 Outdoor PCB Test Run Operation (For Pump Down/Servicing Purpose).....	62
<b>15. Troubleshooting Guide</b> .....	<b>63</b>
15.1 Refrigeration Cycle System .....	63
15.2 Breakdown Self Diagnosis Function.....	65
15.3 Error Codes Table .....	66
15.4 Self-diagnosis Method .....	68
<b>16. Disassembly and Assembly Instructions</b> .....	<b>92</b>
16.1 Disassembly of Parts.....	92
16.2 Outdoor Electronic Controller Removal Procedure .....	95
<b>17. Technical Data</b> .....	<b>96</b>
17.1 Cool Mode Performance Data.....	96
17.2 Heat Mode Performance Data.....	98
<b>18. Service Data</b> .....	<b>99</b>
18.1 Cool Mode Outdoor Air Temperature Characteristic.....	99
18.2 Heat Mode Outdoor Air Temperature Characteristic.....	101
18.3 Piping Length Correction Factor.....	103
<b>19. Exploded View and Replacement Parts List</b>	<b>104</b>
19.1 Indoor Unit .....	104
19.2 CZ-BT20U (Front Grille Complete).....	108
19.3 Outdoor Unit .....	110

# 1. Safety Precautions







- Read the following “SAFETY PRECAUTIONS” carefully before perform any servicing.
- Electrical work must be installed or serviced by a licensed electrician. Be sure to use the correct rating of the power plug and main circuit for the model installed.
- The caution items stated here must be followed because these important contents are related to safety. The meaning of each indication used is as below. Incorrect installation or servicing due to ignoring of the instruction will cause harm or damage, and the seriousness is classified by the following indications.

 <b>WARNING</b>	This indication shows the possibility of causing death or serious injury.
 <b>CAUTION</b>	This indication shows the possibility of causing injury or damage to properties.

- The items to be followed are classified by the symbols:

	This symbol denotes item that is PROHIBITED from doing.
---	---







- Carry out test run to confirm that no abnormality occurs after the servicing. Then, explain to user the operation, care and maintenance as stated in instructions. Please remind the customer to keep the operating instructions for future reference.

 <b>WARNING</b>	
1.	Do not modify the machine, part, material during repairing service.
2.	If wiring unit is supplied as repairing part, do not repair or connect the wire even only partial wire break. Exchange the whole wiring unit.
3.	Do not wrench the fasten terminal. Pull it out or insert it straightly.
4.	Engage dealer or specialist for installation and servicing. If installation of servicing done by the user is defective, it will cause water leakage, electrical shock or fire.
5.	Install according to this installation instructions strictly. If installation is defective, it will cause water leakage, electric shock or fire.
6.	Use the attached accessories parts and specified parts for installation and servicing. Otherwise, it will cause the set to fall, water leakage, fire or electrical shock.
7.	Install at a strong and firm location which is able to withstand the set's weight. If the strength is not enough or installation is not properly done, the set will drop and cause injury.
8.	For electrical work, follow the local national wiring standard, regulation and the installation instruction. An independent circuit and single outlet must be used. If electrical circuit capacity is not enough or defect found in electrical work, it will cause electrical shock or fire.
9.	This equipment is strongly recommended to install with Earth Leakage Circuit Breaker (ELCB) or Residual Current Device (RCD). Otherwise, it may cause electrical shock and fire in case equipment breakdown or insulation breakdown.
10.	Do not use joint cable for indoor / outdoor connection cable. Use the specified Indoor/Outdoor connection cable, refer to installation instruction <b>CONNECT THE CABLE TO THE INDOOR UNIT</b> and connect tightly for indoor / outdoor connection. Clamp the cable so that no external force will be acted on the terminal. If connecting or fixing is not perfect, it will cause heat up or fire at the connection.
11.	Wire routing must be properly arranged so that control board cover is fixed properly. If control board cover is not fixed perfectly, it will cause heat-up or fire at the connection point of terminal, fire or electrical shock.
12.	When install or relocate air conditioner, do not let any substance other than the specified refrigerant, eg. air etc. mix into refrigeration cycle (piping). (Mixing of air etc. will cause abnormal high pressure in refrigeration cycle and result in explosion, injury etc.).
13.	Do not install outdoor unit near handrail of veranda. When installing air-conditioner unit at veranda of high rise building, child may climb up to outdoor unit and cross over the handrail and causing accident.
14.	This equipment must be properly earthed. Earth line must not be connected to gas pipe, water pipe, earth of lightning rod and telephone. Otherwise, it may cause electric shock in case equipment breakdown or insulation breakdown. 
15.	Keep away from small children, the thin film may cling to nose and mouth and prevent breathing. 
16.	Do not use unspecified cord, modified cord, joint cord or extension cord for power supply cord. Do not share the single outlet with other electrical appliances. Poor contact, poor insulation or over current will cause electrical shock or fire. 
17.	Tighten the flare nut with torque wrench according to specified method. If the flare nut is over-tightened, after a long period, the flare may break and cause refrigerant gas leakage. 
18.	For R410A model, use piping, flare nut and tools which is specified for R410A refrigerant. Using of existing (R22) piping, flare nut and tools may cause abnormally high pressure in the refrigerant cycle (piping), and possibly result in explosion and injury. Thickness or copper pipes used with R410A must be more than 0.8 mm. Never use copper pipes thinner than 0.8 mm. It is desirable that the amount of residual oil less than 40 mg/10 m. 
19.	During installation, install the refrigerant piping properly before run the compressor. (Operation of compressor without fixing refrigeration piping and valves at opened condition will caused suck-in of air, abnormal high pressure in refrigeration cycle and result in explosion, injury etc).

 **WARNING**

- |     |   |   |
|-----|---|---|
| 20. | During pump down operation, stop the compressor before remove the refrigeration piping. (Removal of compressor while compressor is operating and valves are opened will cause suck-in of air, abnormal high pressure in refrigeration cycle and result in explosion, injury etc.) |   |
| 21. | After completion of installation or service, confirm there is no leakage or refrigerant gas. It may generate toxic gas when the refrigerant contacts with fire.   |   |
| 22. | Ventilate if there is refrigerant gas leakage during operation. It may cause toxic gas when refrigerant contacts with fire.   |   |
| 23. | Do not insert your fingers or other objects into the unit, high speed rotating fan may cause injury.  |  |
| 24. | Must not use other parts except original parts described in catalog and manual.   |   |
| 25. | Using of refrigerant other than the specified type may cause product damage, burst and injury etc.  |   |

 **CAUTION**

- |     |   |   |
|-----|---|---|
| 1.  | Do not install the unit at place where leakage of flammable gas may occur. In case gas leaks and accumulates at surrounding of the unit, it may cause fire.   |    |
| 2.  | Carry out drainage piping as mentioned in installation instructions. If drainage is not perfect, water may enter the room and damage the furniture.   |   |
| 3.  | Tighten the flare nut with torque wrench according to specified method. If the flare nut is over-tightened, after a long period, the flare may break and cause refrigerant gas leakage.   |   |
| 4.  | Do not touch outdoor unit air inlet and aluminium fin. It may cause injury.   |    |
| 5.  | Select an installation location which is easy for maintenance.  |   |
| 6.  | Pb free solder has a higher melting point than standard solder; typically the melting point is 50°F – 70°F (30°C – 40°C) higher. Please use a high temperature solder iron. In case of the soldering iron with temperature control, please set it to 700 ± 20°F (370 ± 10°C). Pb free solder will tend to splash when heated too high (about 1100°F / 600°C).   |   |
| 7.  | Power supply connection to the room air conditioner.<br>Use power supply cord 3 × 2.5 mm <sup>2</sup> (2.0 ~ 2.5HP) type designation 60245 IEC 57 or heavier cord.<br>Connect the power supply cord of the air conditioner to the mains using one of the following method.<br>Power supply point should be in easily accessible place for power disconnection in case of emergency.<br>In some countries, permanent connection of this air conditioner to the power supply is prohibited.<br>1) Power supply connection to the receptacle using power plug.<br>Use an approved 16A power plug with earth pin for the connection to the socket.<br>2) Power supply connection to a circuit breaker for the permanent connection.<br>Use an approved 16A circuit breaker for the permanent connection. It must be a double pole switch with a minimum 3.0 mm contact gap. |   |
| 8.  | Do not release refrigerant during piping work for installation, servicing, reinstallation and during repairing a refrigerant parts. Take care of the liquid refrigerant, it may cause frostbite.  |  |
| 9.  | Installation or servicing work: It may need two people to carry out the installation or servicing work.   |   |
| 10. | Do not install this appliance in a laundry room or other location where water may drip from the ceiling, etc.   |  |
| 11. | Do not sit or step on the unit, you may fall down accidentally.   |  |
| 12. | Do not touch the sharp aluminium fins or edges of metal parts.<br>If you are required to handle sharp parts during installation or servicing, please wear hand glove.<br>Sharp parts may cause injury.  |  |

## 2. Specifications

Model		Indoor	CS-E18RB4EAW							
		Outdoor	CU-E18RBEA							
Performance Test Condition			EUROVENT							
Power Supply		Phase, Hz	Single, 50							
		V	220			230				
		Min.	Mid.	Max.	Min.	Mid.	Max.			
Cooling	Capacity		kW	0.90	5.00	5.80	0.90	5.00	5.80	
			BTU/h	3070	17100	19800	3070	17100	19800	
			kcal/h	770	4300	4990	770	4300	4990	
	Running Current		A	–	7.50	–	–	7.20	–	
	Input Power		W	255	1.60k	1.95k	255	1.60k	1.95k	
	Annual Consumption		kWh	–	800	–	–	800	–	
	EER		W/W	3.53	3.13	2.97	3.53	3.13	2.97	
			BTU/hW	12.04	10.69	10.15	12.04	10.69	10.15	
			kcal/hW	3.02	2.69	2.56	3.02	2.69	2.56	
	ErP	Pdesign		kW	5.0					
		SEER		(W/W)	5.8					
		Annual Consumption		kWh	302					
		Class			A+					
	Power Factor		%	–	97	–	–	97	–	
	Indoor Noise (H / L / QLo)		dB-A	37 / 28 / 25			37 / 28 / 25			
			Power Level dB	53 / 44 / 41			53 / 44 / 41			
	Outdoor Noise (H / L / QLo)		dB-A	47 / – / –			47 / – / –			
			Power Level dB	61 / – / –			61 / – / –			
	Heating	Capacity		kW	0.90	5.60	7.10	0.90	5.60	7.10
				BTU/h	3070	19100	24200	3070	19100	24200
kcal/h				770	4820	6110	770	4820	6110	
Running Current		A	–	8.60	–	–	8.30	–		
Input Power		W	260	1.86k	2.43k	260	1.86k	2.43k		
COP		W/W	3.46	3.01	2.92	3.46	3.01	2.92		
		BTU/hW	11.81	10.27	9.96	11.81	10.27	9.96		
		kcal/hW	2.96	2.59	2.51	2.96	2.59	2.51		
ErP		Pdesign		kW	3.8					
		Tbivalent		°C	-10					
		SCOP		(W/W)	4.1					
		Annual Consumption		kWh	1298					
		Class			A+					
Power Factor		%	–	98	–	–	97	–		
Indoor Noise (H / L / QLo)		dB-A	38 / 29 / 26			38 / 29 / 26				
		Power Level dB	54 / 45 / 42			54 / 45 / 42				
Outdoor Noise (H / L / QLo)		dB-A	48 / – / –			48 / – / –				
		Power Level dB	62 / – / –			62 / – / –				
※3 Low Temp. : Capacity (kW) / I. Power (W) / COP			5.14 / 2.15k / 2.39							
※4 Extr Low Temp. : Capacity (kW) / I. Power (W) / COP			4.37 / 2.24k / 1.95							
Max Current (A) / Max Input Power (W)			11.1 / 2.43k							
Starting Current (A)			8.60							

Model			Indoor	CS-E18RB4EAW	
			Outdoor	CU-E18RBEA	
Compressor	Type			Hermetic Motor (Rotary)	
	Motor Type			Brushless (4 poles)	
	Output Power		W	900	
Indoor Fan	Type			BACKWARD FAN	
	Material			ABS	
	Motor Type			DC / Transistor (8-poles)	
	Input Power		W	-	
	Output Power		W	40	
	Speed	QLo	Cool	rpm	360
			Heat	rpm	430
		Lo	Cool	rpm	390
			Heat	rpm	450
		Me	Cool	rpm	500
			Heat	rpm	540
		Hi	Cool	rpm	620
			Heat	rpm	640
	SHi	Cool	rpm	670	
Heat		rpm	690		
Outdoor Fan	Type			Propeller Fan	
	Material			PP	
	Motor Type			DC (8-poles)	
	Input Power		W	-	
	Output Power		W	40	
	Speed	Hi	Cool	rpm	640
Heat			rpm	640	
Moisture Removal			L/h (Pt/h)	2.8 (5.9)	
Indoor Airflow	QLo	Cool	m <sup>3</sup> /min (ft <sup>3</sup> /min)	7.2 (254)	
		Heat	m <sup>3</sup> /min (ft <sup>3</sup> /min)	8.3 (293)	
	Lo	Cool	m <sup>3</sup> /min (ft <sup>3</sup> /min)	7.7 (272)	
		Heat	m <sup>3</sup> /min (ft <sup>3</sup> /min)	8.7 (307)	
	Me	Cool	m <sup>3</sup> /min (ft <sup>3</sup> /min)	9.5 (335)	
		Heat	m <sup>3</sup> /min (ft <sup>3</sup> /min)	10.2 (360)	
	Hi	Cool	m <sup>3</sup> /min (ft <sup>3</sup> /min)	11.5 (405)	
		Heat	m <sup>3</sup> /min (ft <sup>3</sup> /min)	11.8 (415)	
SHi	Cool	m <sup>3</sup> /min (ft <sup>3</sup> /min)	12.3 (434)		
	Heat	m <sup>3</sup> /min (ft <sup>3</sup> /min)	12.7 (448)		
Outdoor Airflow	Hi	Cool	m <sup>3</sup> /min (ft <sup>3</sup> /min)	39.2 (1385)	
		Heat	m <sup>3</sup> /min (ft <sup>3</sup> /min)	39.2 (1385)	
Refrigeration Cycle	Control Device			Expansion Valve	
	Refrigerant Oil		cm <sup>3</sup>	FV50S (450)	
	Refrigerant Type		g (oz)	R410A, 1.23k (43.4)	
Dimension	Height (I/D / O/D / PANEL)		mm (inch)	260 (10-1/4) / 695 (27-3/8) / 51 (2-1/32)	
	Width (I/D / O/D / PANEL)		mm (inch)	575 (22-21/32) / 875 (34-15/32) / 700 (27-9/16)	
	Depth (I/D / O/D / PANEL)		mm (inch)	575 (22-21/32) / 320 (12-5/8) / 700 (27-9/16)	
Weight	Net (I/D / O/D / PANEL)		kg (lb)	18 (40) / 47 (104) / 2.5 (6)	

Model		Indoor	CS-E18RB4EAW	
		Outdoor	CU-E18RBEA	
Piping	Pipe Diameter (Liquid / Gas)	mm (inch)	6.35 (1/4) / 12.70 (1/2)	
	Standard length	m (ft)	5.0 (16.4)	
	Length range (min – max)	m (ft)	3 (9.8) ~ 30 (98.4)	
	I/D & O/D Height different	m (ft)	20.0 (65.6)	
	Additional Gas Amount	g/m (oz/ft)	20 (0.2)	
	Length for Additional Gas	m (ft)	10 (32.8)	
Drain Hose	Inner Diameter	mm	30	
	Length	mm	193	
Indoor Heat Exchanger	Fin Material		Aluminium (Pre Coat)	
	Fin Type		Slit Fin	
	Row × Stage × FPI		2 × 10 × 18	
	Size (W × H × L)	mm	1330:1270 × 210 × 25.4	
Outdoor Heat Exchanger	Fin Material		Aluminium (Pre Coat)	
	Fin Type		Corrugated Fin	
	Row × Stage × FPI		2 × 31 × 19	
	Size (W × H × L)	mm	36.4 × 651 × 854.5:824.5	
Air Filter	Material		-	
	Type		-	
Power Supply			Outdoor	
Power Supply Cord		A	Nil	
Thermostat			Electronic Control	
Protection Device			Electronic Control	
			Dry Bulb	Wet Bulb
Indoor Operation Range	Cooling	Maximum °C	32	23
		Minimum °C	16	11
	Heating	Maximum °C	30	-
		Minimum °C	16	-
Outdoor Operation Range	Cooling	Maximum °C	43	26
		Minimum °C	-10	-
	Heating	Maximum °C	24	18
		Minimum °C	-10	-

- Cooling capacities are based on indoor temperature of 27°C Dry Bulb (80.6°F Dry Bulb), 19.0°C Wet Bulb (66.2°F Wet Bulb) and outdoor air temperature of 35°C DRY BULB (95°F Dry Bulb), 24°C Wet Bulb (75.2°F Wet Bulb)
- Heating capacities are based on indoor temperature of 20°C Dry Bulb (68°F Dry Bulb) and outdoor air temperature of 7°C Dry Bulb (44.6°F Dry Bulb), 6°C Wet Bulb (42.8°F Wet Bulb)
- ※3 Heating low temperature capacity, Input Power and COP measured at 230 V, indoor temperature 20°C, outdoor 2/1°C
- ※4 Heating extreme low temperature capacity, Input Power and COP measured at 230 V, indoor temperature 20°C, outdoor -7/-8°C
- Standby power consumption ≤0.7W (when switched OFF by remote control, except under self protection control).
- Specifications are subjected to change without prior notice for further improvement.

Model		Indoor	CS-E21RB4EAW							
		Outdoor	CU-E21RBEA							
Performance Test Condition			EUROVENT							
Power Supply		Phase, Hz	Single, 50							
		V	220			230				
			Min.	Mid.	Max.	Min.	Mid.	Max.		
Cooling	Capacity		kW	0.90	5.90	6.30	0.90	5.90	6.30	
			BTU/h	3070	20100	21500	3070	20100	21500	
			kcal/h	770	5070	5420	770	5070	5420	
	Running Current		A	–	9.40	–	–	9.10	–	
	Input Power		W	255	2.05k	2.20k	255	2.05k	2.20k	
	Annual Consumption		kWh	–	1025	–	–	1025	–	
	EER		W/W	3.53	2.88	2.86	3.53	2.88	2.86	
			BTU/hW	12.04	9.80	9.77	12.04	9.80	9.77	
			kcal/hW	3.02	2.47	2.46	3.02	2.47	2.46	
	ErP	Pdesign	kW	5.9						
		SEER	(W/W)	5.6						
		Annual Consumption	kWh	369						
		Class		A+						
	Power Factor		%	–	99	–	–	98	–	
	Indoor Noise (H / L / QLo)		dB-A	42 / 33 / 30			42 / 33 / 30			
			Power Level dB	58 / 49 / 46			58 / 49 / 46			
	Outdoor Noise (H / L / QLo)		dB-A	49 / – / –			49 / – / –			
			Power Level dB	63 / – / –			63 / – / –			
	Heating	Capacity		kW	0.90	7.00	8.00	0.90	7.00	8.00
				BTU/h	3070	23900	27300	3070	23900	27300
kcal/h				770	6020	6880	770	6020	6880	
Running Current		A	–	11.40	–	–	11.10	–		
Input Power		W	260	2.45k	2.82k	260	2.45k	2.82k		
COP		W/W	3.46	2.86	2.84	3.46	2.86	2.84		
		BTU/hW	11.81	9.76	9.68	11.81	9.76	9.68		
		kcal/hW	2.96	2.46	2.44	2.96	2.46	2.44		
ErP		Pdesign	kW	4.0						
		Tbivalent	°C	-10						
		SCOP	(W/W)	4.1						
		Annual Consumption	kWh	1366						
		Class		A+						
Power Factor		%	–	98	–	–	96	–		
Indoor Noise (H / L / QLo)		dB-A	43 / 34 / 31			43 / 34 / 31				
		Power Level dB	59 / 50 / 47			59 / 50 / 47				
Outdoor Noise (H / L / QLo)		dB-A	50 / – / –			50 / – / –				
		Power Level dB	64 / – / –			64 / – / –				
※3 Low Temp. : Capacity (kW) / I. Power (W) / COP			5.80 / 2.50k / 2.32							
※4 Extr Low Temp. : Capacity (kW) / I. Power (W) / COP			5.07 / 2.60k / 1.95							
Max Current (A) / Max Input Power (W)			12.9 / 2.82k							
Starting Current (A)			11.40							



Model			Indoor	CS-E21RB4EAW	
			Outdoor	CU-E21RBEA	
Compressor	Type			Hermetic Motor (Rotary)	
	Motor Type			Brushless (4 poles)	
	Output Power		W	900	
Indoor Fan	Type			BACKWARD FAN	
	Material			ABS	
	Motor Type			DC / Transistor (8-poles)	
	Input Power		W	-	
	Output Power		W	40	
	Speed	QLo	Cool	rpm	460
			Heat	rpm	480
		Lo	Cool	rpm	510
			Heat	rpm	540
		Me	Cool	rpm	600
			Heat	rpm	660
		Hi	Cool	rpm	700
			Heat	rpm	780
	SHi	Cool	rpm	750	
		Heat	rpm	820	
Outdoor Fan	Type			Propeller Fan	
	Material			PP	
	Motor Type			DC (8-poles)	
	Input Power		W	-	
	Output Power		W	40	
	Speed	Hi	Cool	rpm	680
Heat			rpm	670	
Moisture Removal			L/h (Pt/h)	3.3 (7.0)	
Indoor Airflow	QLo	Cool	m <sup>3</sup> /min (ft <sup>3</sup> /min)	7.7 (272)	
		Heat	m <sup>3</sup> /min (ft <sup>3</sup> /min)	9.0 (318)	
	Lo	Cool	m <sup>3</sup> /min (ft <sup>3</sup> /min)	8.7 (307)	
		Heat	m <sup>3</sup> /min (ft <sup>3</sup> /min)	10.1 (357)	
	Me	Cool	m <sup>3</sup> /min (ft <sup>3</sup> /min)	10.5 (371)	
		Heat	m <sup>3</sup> /min (ft <sup>3</sup> /min)	12.4 (438)	
	Hi	Cool	m <sup>3</sup> /min (ft <sup>3</sup> /min)	12.4 (440)	
		Heat	m <sup>3</sup> /min (ft <sup>3</sup> /min)	14.6 (515)	
	SHi	Cool	m <sup>3</sup> /min (ft <sup>3</sup> /min)	13.4 (473)	
		Heat	m <sup>3</sup> /min (ft <sup>3</sup> /min)	15.3 (540)	
Outdoor Airflow	Hi	Cool	m <sup>3</sup> /min (ft <sup>3</sup> /min)	40.4 (1425)	
		Heat	m <sup>3</sup> /min (ft <sup>3</sup> /min)	40.4 (1425)	
Refrigeration Cycle	Control Device			Expansion Valve	
	Refrigerant Oil		cm <sup>3</sup>	FV50S (450)	
	Refrigerant Type		g (oz)	R410A, 1.30k (45.9)	
Dimension	Height (I/D / O/D / PANEL)		mm (inch)	260 (10-1/4) / 695 (27-3/8) / 51 (2-1/32)	
	Width (I/D / O/D / PANEL)		mm (inch)	575 (22-21/32) / 875 (34-15/32) / 700 (27-9/16)	
	Depth (I/D / O/D / PANEL)		mm (inch)	575 (22-21/32) / 320 (12-5/8) / 700 (27-9/16)	
Weight	Net (I/D / O/D) / PANEL		kg (lb)	18 (40) / 47 (104) / 2.5 (6)	

Model		Indoor	CS-E21RB4EAW	
		Outdoor	CU-E21RBEA	
Piping	Pipe Diameter (Liquid / Gas)	mm (inch)	6.35 (1/4) / 12.70 (1/2)	
	Standard length	m (ft)	5.0 (16.4)	
	Length range (min – max)	m (ft)	3 (9.8) ~ 30 (98.4)	
	I/D & O/D Height different	m (ft)	20.0 (65.6)	
	Additional Gas Amount	g/m (oz/ft)	20 (0.2)	
	Length for Additional Gas	m (ft)	10 (32.8)	
Drain Hose	Inner Diameter	mm	30	
	Length	mm	193	
Indoor Heat Exchanger	Fin Material		Aluminium (Pre Coat)	
	Fin Type		Slit Fin	
	Row × Stage × FPI		2 × 10 × 20	
	Size (W × H × L)	mm	1330:1270 × 210 × 25.4	
Outdoor Heat Exchanger	Fin Material		Aluminium (Pre Coat)	
	Fin Type		Corrugated Fin	
	Row × Stage × FPI		2 × 31 × 19	
	Size (W × H × L)	mm	36.4 × 651 × 854.5:824.5	
Air Filter	Material		-	
	Type		-	
Power Supply			Outdoor	
Power Supply Cord		A	Nil	
Thermostat			Electronic Contol	
Protection Device			Electronic Contol	
			Dry Bulb	Wet Bulb
Indoor Operation Range	Cooling	Maximum °C	32	23
		Minimum °C	16	11
	Heating	Maximum °C	30	-
		Minimum °C	16	-
Outdoor Operation Range	Cooling	Maximum °C	43	26
		Minimum °C	-10	-
	Heating	Maximum °C	24	18
		Minimum °C	-10	-

1. Cooling capacities are based on indoor temperature of 27°C Dry Bulb (80.6°F Dry Bulb), 19.0°C Wet Bulb (66.2°F Wet Bulb) and outdoor air temperature of 35°C DRY BULB (95°F Dry Bulb), 24°C Wet Bulb (75.2°F Wet Bulb)
2. Heating capacities are based on indoor temperature of 20°C Dry Bulb (68°F Dry Bulb) and outdoor air temperature of 7°C Dry Bulb (44.6°F Dry Bulb), 6°C Wet Bulb (42.8°F Wet Bulb)
- ※3 Heating low temperature capacity, Input Power and COP measured at 230 V, indoor temperature 20°C, outdoor 2/1 °C
- ※4 Heating extreme low temperature capacity, Input Power and COP measured at 230 V, indoor temperature 20°C, outdoor -7/-8°C
- 5 Standby power consumption ≤0.7W (when switched OFF by remote control, except under self protection control).
- 6 Specifications are subjected to change without prior notice for further improvement.

• **Multi Split Combination Possibility:**

- A single outdoor unit enables air conditioning of up to two separate rooms for CU-2E15PBE, CU-2E18PBE.
- A single outdoor unit enables air conditioning of up to three separate rooms for CU-3E18PBE.
- A single outdoor unit enables air conditioning of up to four separate rooms for CU-4E23PBE.
- A single outdoor unit enables air conditioning of up to four separate rooms for CU-4E27PBE.
- A single outdoor unit enables air conditioning of up to five separate rooms for CU-5E34PBE.

CONNECTABLE INDOOR UNIT			OUTDOOR UNIT											
			CU-2E15PBE		CU-2E18PBE		CU-3E18PBE			CU-4E23PBE				
Type/ROOM			A	B	A	B	A	B	C	A	B	C	D	
Wall	1.6kW	CS-ME5PKE	•	•	•	•	•	•	•	•	•	•	•	
	2.0kW	CS-E7PKEW	•	•	•	•	•	•	•	•	•	•	•	
		CS-XE7PKEW	•	•	•	•	•	•	•	•	•	•	•	
	2.5kW	CS-E9PKEW	•	•	•	•	•	•	•	•	•	•	•	•
		CS-XE9PKEW												
		CS-ME9PD3EA												
		CS-ME18RB4EA												
		CS-E9GFEW												
CS-E9GFEW-2														
CS-E9PD3EA														
3.2kW	CS-E12PKEW	•	•	•	•	•	•	•	•	•	•	•	•	
	CS-XE12PKEW													
	CS-ME12PD3EA													
	CS-ME24RB4EA													
	CS-E12GFEW													
	CS-E12GFEW-2													
	CS-E12PD3EA													
	CS-E12PB4EA													
4.0kW	CS-E15PKEW	-	-	-	-	•	•	•	•	•	•	•	•	
	CS-XE15PKEW	-	-	-	-	•	•	•	•	•	•	•	•	
5.0kW	CS-E18PKEW	-	-	-	-	•	•	•	•	•	•	•	•	
	CS-XE18PKEW													
	CS-ME18PD3EA													
	CS-ME18PB4EA													
	CS-E18GFEW													
	CS-E18GFEW-2													
CS-E18RB4EAW														
6.0kW	CS-E21PKEW	-	-	-	-	-	-	-	-	•	•	•	•	
	CS-XE21PKEW													
	CS-ME21PB4EA													
	CS-E21RB4EAW													
Capacity range of connectable indoor units			From 3.2kW to 5.6kW		From 3.2kW to 6.4kW		From 4.5kW to 9.0kW			From 4.5kW to 11.0 kW				
Pipe length	1 room maximum pipe length (m)		20		20		25			25				
	Allowable elevation (m)		10		10		15			15				
	Total allowable pipe length (m)		30		30		50			60				
	Total pipe length for maximum chargeless length (m)		20		20		30			30				
	Additional gas amount over chargeless length (g/m)		15		15		20			20				
Note: "•": Available														
Remarks for CU-2E15PBE / CU-2E18PBE 1. At least two indoor units must be connected. 2. The total nominal cooling capacity of indoor units that will be connected to outdoor unit must be within connectable capacity range of indoor unit. (as shown in the table above) Example: The indoor units' combination below is possible to connect to CU-2E15PBE. (Total nominal capacity of indoor units is between 3.2kW to 5.6kW) 1) Two CS-E7PKEW only (Total nominal cooling capacity is 4.0kW) 2) One CS-E7PKEW and one CS-E9PKEW. (Total nominal cooling capacity is 4.5kW)														
Remarks for CU-3E18PBE / CU-4E23PBE 1. At least two indoor units must be connected. 2. The total nominal cooling capacity of indoor units that will be connected to outdoor unit must be within connectable capacity range of indoor unit. (as shown in the table above) Example: The indoor units' combination below is possible to connect to CU-3E18PBE. (Total nominal capacity of indoor units is between 4.5kW to 9.0kW) 1) Two CS-E9PKEW only (Total nominal cooling capacity is 5.0kW) 2) Three CS-E12PKEW. (Total nominal cooling capacity is 9.6kW)														

CONNECTABLE INDOOR UNIT		OUTDOOR UNIT								
		CU-4E27PBE				CU-5E34PBE				
Type/ROOM		A	B	C	D	A	B	C	D	E
Wall	2.0kW	CS-E7PKEW CS-XE7PKEW	•	•	•	•	•	•	•	•
	2.5kW	CS-E9PKEW CS-XE9PKEW CS-ME9PD3EA CS-ME18RB4EA CS-E9GFEW CS-E9GFEW-2 CS-E9PD3EA CS-E9PB4EA	•	•	•	•	•	•	•	•
	3.2kW	CS-E12PKEW CS-XE12PKEW CS-ME12PD3EA CS-ME24RB4EA CS-E12GFEW CS-E12GFEW-2 CS-E12PD3EA CS-E12PB4EA	•	•	•	•	•	•	•	•
	4.0kW	CS-E15PKEW CS-XE15PKEW	•	•	•	•	•	•	•	•
	5.0kW	CS-E18PKEW CS-XE18PKEW CS-ME18PD3EA CS-ME18PB4EA CS-E18GFEW CS-E18GFEW-2 CS-E18RB4EAW	•	•	•	•	•	•	•	•
	6.0kW	CS-E21PKEW CS-XE21PKEW CS-ME21PB4EA CS-E21RB4EAW	•	•	•	•	•	•	•	•
	7.0kW	CS-E24PKEW	•	•	•	•	•	•	•	•
	Capacity range of connectable indoor units		From 4.5kW to 13.6kW				From 4.5kW to 17.5 kW			
Pipe length	1 room maximum pipe length (m)	25				25				
	Allowable elevation (m)	15				15				
	Total allowable pipe length (m)	70				80				
	Total pipe length for maximum chargeless length (m)	45				45				
	Additional gas amount over chargeless length (g/m)	20				20				
Note: "•" : Available										
Remarks for CU-4E27PBE / CU-5E34PBE 1. At least two indoor units must be connected. 2. The total nominal cooling capacity of indoor units that will be connected to outdoor unit must be within connectable capacity range of indoor unit. (as shown in the table above) Example: The indoor units' combination below is possible to connect to CU-4E27PBE. (Total nominal capacity of indoor units is between 4.5kW to 13.6kW) 1) Two CS-E9PKEW only (Total nominal cooling capacity is 5.0kW) 2) Three CS-E12PKEW. (Total nominal cooling capacity is 9.6kW)										

- Indoor Unit : CS-ME5PKE, CS-E7/9/12PKEW, CS-E9/12GFEW, CS-ME9/12PB4EA, CS-ME9/12PD3EA, CS-E9/12PD3EA, CS-E9/12PB4EA
- Outdoor Unit : CU-2E15PBE

2 Room		1 Room	
Indoor Unit Capacity (kW)	Total Indoor Capacity (kW)	Indoor Unit Capacity (kW)	Total Indoor Capacity (kW)
1.6 + 1.6	3.2	1.6	1.6
1.6 + 2.0	3.6	2.0	2.0
1.6 + 2.5	4.1	2.5	2.5
1.6 + 2.8	4.4	2.8	2.8
1.6 + 3.2	4.8	3.2	3.2
2.0 + 2.0	4.0		
2.0 + 2.5	4.5		
2.0 + 2.8	4.8		
2.0 + 3.2	5.2		
2.5 + 2.5	5.0		
2.5 + 2.8	5.3		
2.8 + 2.8	5.6		

- Indoor Unit : CS-ME5PKE, CS-E7/9/12PKEW, CS-E9/12GFEW, CS-ME9/12PB4EA, CS-ME9/12PD3EA, CS-E9/12PD3EA, CS-E9/12PB4EA
- Outdoor Unit : CU-2E18PBE

2 Room		1 Room	
Indoor Unit Capacity (kW)	Total Indoor Capacity (kW)	Indoor Unit Capacity (kW)	Total Indoor Capacity (kW)
1.6 + 1.6	3.2	1.6	1.6
1.6 + 2.0	3.6	2.0	2.0
1.6 + 2.5	4.1	2.5	2.5
1.6 + 2.8	4.4	2.8	2.8
1.6 + 3.2	4.8	3.2	3.2
2.0 + 2.0	4.0		
2.0 + 2.5	4.5		
2.0 + 2.8	4.8		
2.0 + 3.2	5.2		
2.5 + 2.5	5.0		
2.5 + 2.8	5.3		
2.5 + 3.2	5.7		
2.8 + 2.8	5.6		
2.8 + 3.2	6.0		
3.2 + 3.2	6.4		

- Indoor Unit : CS-ME5PKE, CS-E7/9/12/15/18PKEW, CS-E9/12/18GFEW, CS-ME9/12/18PB4EA, CS-ME9/12/18PD3EA, CS-E9/12PD3EA, CS-E9/12PB4EA, CS-E18RB4EAW
- Outdoor Unit : CU-3E18PBE

3 Room		2 Room		1 Room	
Indoor Unit Capacity (kW)	Total Indoor Capacity (kW)	Indoor Unit Capacity (kW)	Total Indoor Capacity (kW)	Indoor Unit Capacity (kW)	Total Indoor Capacity (kW)
1.6 + 1.6 + 1.6	4.8	1.6 + 3.2	4.8	1.6	1.6
1.6 + 1.6 + 2.0	5.2	1.6 + 4.0	5.6	2.0	2.0
1.6 + 1.6 + 2.5	5.7	1.6 + 5.0	6.6	2.5	2.5
1.6 + 1.6 + 2.8	6.0	2.0 + 2.5	4.5	2.8	2.8
1.6 + 1.6 + 3.2	6.4	2.0 + 2.8	4.8	3.2	3.2
1.6 + 1.6 + 4.0	7.2	2.0 + 3.2	5.2	4.0	4.0
1.6 + 1.6 + 5.0	8.2	2.0 + 4.0	6.0	5.0	5.0
1.6 + 2.0 + 2.0	5.6	2.0 + 5.0	7.0		
1.6 + 2.0 + 2.5	6.1	2.5 + 2.5	5.0		
1.6 + 2.0 + 2.8	6.4	2.5 + 2.8	5.3		
1.6 + 2.0 + 3.2	6.8	2.5 + 3.2	5.7		
1.6 + 2.0 + 4.0	7.6	2.5 + 4.0	6.5		
1.6 + 2.0 + 5.0	8.6	2.5 + 5.0	7.5		
1.6 + 2.5 + 2.5	6.6	2.8 + 2.8	5.6		
1.6 + 2.5 + 2.8	6.9	2.8 + 3.2	6.0		
1.6 + 2.5 + 3.2	7.3	2.8 + 4.0	6.8		
1.6 + 2.5 + 4.0	8.1	2.8 + 5.0	7.8		
1.6 + 2.8 + 2.8	7.2	3.2 + 3.2	6.4		
1.6 + 2.8 + 3.2	7.6	3.2 + 4.0	7.2		
1.6 + 2.8 + 4.0	8.4	3.2 + 5.0	8.2		
1.6 + 3.2 + 3.2	8.0	4.0 + 4.0	8.0		
1.6 + 3.2 + 4.0	8.8	4.0 + 5.0	9.0		
2.0 + 2.0 + 2.0	6.0				
2.0 + 2.0 + 2.5	6.5				
2.0 + 2.0 + 2.8	6.8				
2.0 + 2.0 + 3.2	7.2				
2.0 + 2.0 + 4.0	8.0				
2.0 + 2.0 + 5.0	9.0				
2.0 + 2.5 + 2.5	7.0				
2.0 + 2.5 + 2.8	7.3				
2.0 + 2.5 + 3.2	7.7				
2.0 + 2.5 + 4.0	8.5				
2.0 + 2.8 + 2.8	7.6				
2.0 + 2.8 + 3.2	8.0				
2.0 + 2.8 + 4.0	8.8				
2.0 + 3.2 + 3.2	8.4				
2.5 + 2.5 + 2.5	7.5				
2.5 + 2.5 + 2.8	7.8				
2.5 + 2.5 + 3.2	8.2				
2.5 + 2.5 + 4.0	9.0				
2.5 + 2.8 + 2.8	8.1				
2.5 + 2.8 + 3.2	8.5				
2.5 + 3.2 + 3.2	8.9				
2.8 + 2.8 + 2.8	8.4				
2.8 + 2.8 + 3.2	8.8				

- Indoor Unit : CS-ME5PKE, CS-E7/9/12/15/18/21PKEW, CS-E9/12/18GFEW, CS-ME9/12/18/21PB4EA, CS-ME9/12/18PD3EA, CS-E9/12PD3EA, CS-E9/12PB4EA, CS-E18/21RB4EAW
- Outdoor Unit : CU-4E23PBE

4 Room		3 Room		2 Room		1 Room	
Indoor Unit Capacity (kW)	Total Indoor Capacity (kW)	Indoor Unit Capacity (kW)	Total Indoor Capacity (kW)	Indoor Unit Capacity (kW)	Total Indoor Capacity (kW)	Indoor Unit Capacity (kW)	Total Indoor Capacity (kW)
1.6 + 1.6 + 1.6 + 1.6	6.4	1.6 + 1.6 + 1.6	4.8	1.6 + 3.2	4.8	1.6	1.6
1.6 + 1.6 + 1.6 + 2.0	6.8	1.6 + 1.6 + 2.0	5.2	1.6 + 4.0	5.6	2.0	2.0
1.6 + 1.6 + 1.6 + 2.5	7.3	1.6 + 1.6 + 2.5	5.7	1.6 + 5.0	6.6	2.5	2.5
1.6 + 1.6 + 1.6 + 2.8	7.6	1.6 + 1.6 + 2.8	6.0	1.6 + 6.0	7.6	2.8	2.8
1.6 + 1.6 + 1.6 + 3.2	8.0	1.6 + 1.6 + 3.2	6.4	2.0 + 2.5	4.5	3.2	3.2
1.6 + 1.6 + 1.6 + 4.0	8.8	1.6 + 1.6 + 4.0	7.2	2.0 + 2.8	4.8	4.0	4.0
1.6 + 1.6 + 1.6 + 5.0	9.8	1.6 + 1.6 + 5.0	8.2	2.0 + 3.2	5.2	5.0	5.0
1.6 + 1.6 + 1.6 + 6.0	10.8	1.6 + 1.6 + 6.0	9.2	2.0 + 4.0	6.0	6.0	6.0
1.6 + 1.6 + 2.0 + 2.0	7.2	1.6 + 2.0 + 2.0	5.6	2.0 + 5.0	7.0		
1.6 + 1.6 + 2.0 + 2.5	7.7	1.6 + 2.0 + 2.5	6.1	2.0 + 6.0	8.0		
1.6 + 1.6 + 2.0 + 2.8	8.0	1.6 + 2.0 + 2.8	6.4	2.5 + 2.5	5.0		
1.6 + 1.6 + 2.0 + 3.2	8.4	1.6 + 2.0 + 3.2	6.8	2.5 + 2.8	5.3		
1.6 + 1.6 + 2.0 + 4.0	9.2	1.6 + 2.0 + 4.0	7.6	2.5 + 3.2	5.7		
1.6 + 1.6 + 2.0 + 5.0	10.2	1.6 + 2.0 + 5.0	8.6	2.5 + 4.0	6.5		
1.6 + 1.6 + 2.5 + 2.5	8.2	1.6 + 2.0 + 6.0	9.6	2.5 + 5.0	7.5		
1.6 + 1.6 + 2.5 + 2.8	8.5	1.6 + 2.5 + 2.5	6.6	2.5 + 6.0	8.5		
1.6 + 1.6 + 2.5 + 3.2	8.9	1.6 + 2.5 + 2.8	6.9	2.8 + 2.8	5.6		
1.6 + 1.6 + 2.5 + 4.0	9.7	1.6 + 2.5 + 3.2	7.3	2.8 + 3.2	6.0		
1.6 + 1.6 + 2.5 + 5.0	10.7	1.6 + 2.5 + 4.0	8.1	2.8 + 4.0	6.8		
1.6 + 1.6 + 2.8 + 2.8	8.8	1.6 + 2.5 + 5.0	9.1	2.8 + 5.0	7.8		
1.6 + 1.6 + 2.8 + 3.2	9.2	1.6 + 2.5 + 6.0	10.1	2.8 + 6.0	8.8		
1.6 + 1.6 + 2.8 + 4.0	10.0	1.6 + 2.8 + 2.8	7.2	3.2 + 3.2	6.4		
1.6 + 1.6 + 2.8 + 5.0	11.0	1.6 + 2.8 + 3.2	7.6	3.2 + 4.0	7.2		
1.6 + 1.6 + 3.2 + 3.2	9.6	1.6 + 2.8 + 4.0	8.4	3.2 + 5.0	8.2		
1.6 + 1.6 + 3.2 + 4.0	10.4	1.6 + 2.8 + 5.0	9.4	3.2 + 6.0	9.2		
1.6 + 2.0 + 2.0 + 2.0	7.6	1.6 + 2.8 + 6.0	10.4	4.0 + 4.0	8.0		
1.6 + 2.0 + 2.0 + 2.5	8.1	1.6 + 3.2 + 3.2	8.0	4.0 + 5.0	9.0		
1.6 + 2.0 + 2.0 + 2.8	8.4	1.6 + 3.2 + 4.0	8.8	4.0 + 6.0	10.0		
1.6 + 2.0 + 2.0 + 3.2	8.8	1.6 + 3.2 + 5.0	9.8	5.0 + 5.0	10.0		
1.6 + 2.0 + 2.0 + 4.0	9.6	1.6 + 3.2 + 6.0	10.8	5.0 + 6.0	11.0		
1.6 + 2.0 + 2.0 + 5.0	10.6	1.6 + 4.0 + 4.0	9.6				
1.6 + 2.0 + 2.5 + 2.5	8.6	1.6 + 4.0 + 5.0	10.6				
1.6 + 2.0 + 2.5 + 2.8	8.9	2.0 + 2.0 + 2.0	6.0				
1.6 + 2.0 + 2.5 + 3.2	9.3	2.0 + 2.0 + 2.5	6.5				
1.6 + 2.0 + 2.5 + 4.0	10.1	2.0 + 2.0 + 2.8	6.8				
1.6 + 2.0 + 2.8 + 2.8	9.2	2.0 + 2.0 + 3.2	7.2				
1.6 + 2.0 + 2.8 + 3.2	9.6	2.0 + 2.0 + 4.0	8.0				
1.6 + 2.0 + 2.8 + 4.0	10.4	2.0 + 2.0 + 5.0	9.0				
1.6 + 2.0 + 3.2 + 3.2	10.0	2.0 + 2.0 + 6.0	10.0				
1.6 + 2.0 + 3.2 + 4.0	10.8	2.0 + 2.5 + 2.5	7.0				
1.6 + 2.5 + 2.5 + 2.5	9.1	2.0 + 2.5 + 2.8	7.3				
1.6 + 2.5 + 2.5 + 2.8	9.4	2.0 + 2.5 + 3.2	7.7				
1.6 + 2.5 + 2.5 + 3.2	9.8	2.0 + 2.5 + 4.0	8.5				
1.6 + 2.5 + 2.5 + 4.0	10.6	2.0 + 2.5 + 5.0	9.5				
1.6 + 2.5 + 2.8 + 2.8	9.7	2.0 + 2.5 + 6.0	10.5				
1.6 + 2.5 + 2.8 + 3.2	10.1	2.0 + 2.8 + 2.8	7.6				
1.6 + 2.5 + 2.8 + 4.0	10.9	2.0 + 2.8 + 3.2	8.0				
1.6 + 2.5 + 3.2 + 3.2	10.5	2.0 + 2.8 + 4.0	8.8				
1.6 + 2.8 + 2.8 + 2.8	10.0	2.0 + 2.8 + 5.0	9.8				
1.6 + 2.8 + 2.8 + 3.2	10.4	2.0 + 2.8 + 6.0	10.8				
1.6 + 2.8 + 3.2 + 3.2	10.8	2.0 + 3.2 + 3.2	8.4				
2.0 + 2.0 + 2.0 + 2.0	8.0	2.0 + 3.2 + 4.0	9.2				
2.0 + 2.0 + 2.0 + 2.5	8.5	2.0 + 3.2 + 5.0	10.2				
2.0 + 2.0 + 2.0 + 2.8	8.8	2.0 + 4.0 + 4.0	10.0				
2.0 + 2.0 + 2.0 + 3.2	9.2	2.0 + 4.0 + 5.0	11.0				
2.0 + 2.0 + 2.0 + 4.0	10.0	2.5 + 2.5 + 2.5	7.5				
2.0 + 2.0 + 2.0 + 5.0	11.0	2.5 + 2.5 + 2.8	7.8				
2.0 + 2.0 + 2.5 + 2.5	9.0	2.5 + 2.5 + 3.2	8.2				

4 Room		3 Room		2 Room		1 Room	
Indoor Unit Capacity (kW)	Total Indoor Capacity (kW)	Indoor Unit Capacity (kW)	Total Indoor Capacity (kW)	Indoor Unit Capacity (kW)	Total Indoor Capacity (kW)	Indoor Unit Capacity (kW)	Total Indoor Capacity (kW)
2.0 + 2.0 + 2.5 + 2.8	9.3	2.5 + 2.5 + 4.0	9.0				
2.0 + 2.0 + 2.5 + 3.2	9.7	2.5 + 2.5 + 5.0	10.0				
2.0 + 2.0 + 2.5 + 4.0	10.5	2.5 + 2.5 + 6.0	11.0				
2.0 + 2.0 + 2.8 + 2.8	9.6	2.5 + 2.8 + 2.8	8.1				
2.0 + 2.0 + 2.8 + 3.2	10.0	2.5 + 2.8 + 3.2	8.5				
2.0 + 2.0 + 2.8 + 4.0	10.8	2.5 + 2.8 + 4.0	9.3				
2.0 + 2.0 + 3.2 + 3.2	10.4	2.5 + 2.8 + 5.0	10.3				
2.0 + 2.5 + 2.5 + 2.5	9.5	2.5 + 3.2 + 3.2	8.9				
2.0 + 2.5 + 2.5 + 2.8	9.8	2.5 + 3.2 + 4.0	9.7				
2.0 + 2.5 + 2.5 + 3.2	10.2	2.5 + 3.2 + 5.0	10.7				
2.0 + 2.5 + 2.5 + 4.0	11.0	2.5 + 4.0 + 4.0	10.5				
2.0 + 2.5 + 2.8 + 2.8	10.1	2.8 + 2.8 + 2.8	8.4				
2.0 + 2.5 + 2.8 + 3.2	10.5	2.8 + 2.8 + 3.2	8.8				
2.0 + 2.5 + 3.2 + 3.2	10.9	2.8 + 2.8 + 4.0	9.6				
2.0 + 2.8 + 2.8 + 2.8	10.4	2.8 + 2.8 + 5.0	10.6				
2.0 + 2.8 + 2.8 + 3.2	10.8	2.8 + 3.2 + 3.2	9.2				
2.5 + 2.5 + 2.5 + 2.5	10.0	2.8 + 3.2 + 4.0	10.0				
2.5 + 2.5 + 2.5 + 2.8	10.3	2.8 + 3.2 + 5.0	11.0				
2.5 + 2.5 + 2.5 + 3.2	10.7	2.8 + 4.0 + 4.0	10.8				
2.5 + 2.5 + 2.8 + 2.8	10.6	3.2 + 3.2 + 3.2	9.6				
2.5 + 2.5 + 2.8 + 3.2	11.0	3.2 + 3.2 + 4.0	10.4				
2.5 + 2.8 + 2.8 + 2.8	10.9						



- Indoor Unit : CS-E7/9/12/15/18/21/24PKEW, CS-E9/12/18GFEW, CS-ME9/12/18/21PB4EA, CS-ME9/12/18PD3EA, CS-E9/12PD3EA, CS-E9/12PB4EA, CS-E18/21RB4EAW
- Outdoor Unit : CU-4E27PBE

4 Room		3 Room		2 Room		1 Room	
Indoor Unit Capacity (kW)	Total Indoor Capacity (kW)	Indoor Unit Capacity (kW)	Total Indoor Capacity (kW)	Indoor Unit Capacity (kW)	Total Indoor Capacity (kW)	Indoor Unit Capacity (kW)	Total Indoor Capacity (kW)
2.0+2.0+2.0+2.0	8.0	2.0+2.0+2.0	6.0	2.0+2.5	4.5	2.0	2.0
2.0+2.0+2.0+2.5	8.5	2.0+2.0+2.5	6.5	2.0+2.8	4.8	2.5	2.5
2.0+2.0+2.0+2.8	8.8	2.0+2.0+2.8	6.8	2.0+3.2	5.2	2.8	2.8
2.0+2.0+2.0+3.2	9.2	2.0+2.0+3.2	7.2	2.0+4.0	6.0	3.2	3.2
2.0+2.0+2.0+4.0	10.0	2.0+2.0+4.0	8.0	2.0+5.0	7.0	4.0	4.0
2.0+2.0+2.0+5.0	11.0	2.0+2.0+5.0	9.0	2.0+6.0	8.0	5.0	5.0
2.0+2.0+2.0+6.0	12.0	2.0+2.0+6.0	10.0	2.0+7.0	9.0	6.0	6.0
2.0+2.0+2.0+7.0	13.0	2.0+2.0+7.0	11.0	2.5+2.5	5.0	7.0	7.0
2.0+2.0+2.5+2.5	9.0	2.0+2.5+2.5	7.0	2.5+2.8	5.3		
2.0+2.0+2.5+2.8	9.3	2.0+2.5+2.8	7.3	2.5+3.2	5.7		
2.0+2.0+2.5+3.2	9.7	2.0+2.5+3.2	7.7	2.5+4.0	6.5		
2.0+2.0+2.5+4.0	10.5	2.0+2.5+4.0	8.5	2.5+5.0	7.5		
2.0+2.0+2.5+5.0	11.5	2.0+2.5+5.0	9.5	2.5+6.0	8.5		
2.0+2.0+2.5+6.0	12.5	2.0+2.5+6.0	10.5	2.5+7.0	9.5		
2.0+2.0+2.5+7.0	13.5	2.0+2.5+7.0	11.5	2.8+2.8	5.6		
2.0+2.0+2.8+2.8	9.6	2.0+2.8+2.8	7.6	2.8+3.2	6.0		
2.0+2.0+2.8+3.2	10.0	2.0+2.8+3.2	8.0	2.8+4.0	6.8		
2.0+2.0+2.8+4.0	10.8	2.0+2.8+4.0	8.8	2.8+5.0	7.8		
2.0+2.0+2.8+5.0	11.8	2.0+2.8+5.0	9.8	2.8+6.0	8.8		
2.0+2.0+2.8+6.0	12.8	2.0+2.8+6.0	10.8	2.8+7.0	9.8		
2.0+2.0+3.2+3.2	10.4	2.0+2.8+7.0	11.8	3.2+3.2	6.4		
2.0+2.0+3.2+4.0	11.2	2.0+3.2+3.2	8.4	3.2+4.0	7.2		
2.0+2.0+3.2+5.0	12.2	2.0+3.2+4.0	9.2	3.2+5.0	8.2		
2.0+2.0+3.2+6.0	13.2	2.0+3.2+5.0	10.2	3.2+6.0	9.2		
2.0+2.0+4.0+4.0	12.0	2.0+3.2+6.0	11.2	3.2+7.0	10.2		
2.0+2.0+4.0+5.0	13.0	2.0+3.2+7.0	12.2	4.0+4.0	8.0		
2.0+2.5+2.5+2.5	9.5	2.0+4.0+4.0	10.0	4.0+5.0	9.0		
2.0+2.5+2.5+2.8	9.8	2.0+4.0+5.0	11.0	4.0+6.0	10.0		
2.0+2.5+2.5+3.2	10.2	2.0+4.0+6.0	12.0	4.0+7.0	11.0		
2.0+2.5+2.5+4.0	11.0	2.0+4.0+7.0	13.0	5.0+5.0	10.0		
2.0+2.5+2.5+5.0	12.0	2.0+5.0+5.0	12.0	5.0+6.0	11.0		
2.0+2.5+2.5+6.0	13.0	2.0+5.0+6.0	13.0	5.0+7.0	12.0		
2.0+2.5+2.8+2.8	10.1	2.5+2.5+2.5	7.5	6.0+6.0	12.0		
2.0+2.5+2.8+3.2	10.5	2.5+2.5+2.8	7.8	6.0+7.0	13.0		
2.0+2.5+2.8+4.0	11.3	2.5+2.5+3.2	8.2				
2.0+2.5+2.8+5.0	12.3	2.5+2.5+4.0	9.0				
2.0+2.5+2.8+6.0	13.3	2.5+2.5+5.0	10.0				
2.0+2.5+3.2+3.2	10.9	2.5+2.5+6.0	11.0				
2.0+2.5+3.2+4.0	11.7	2.5+2.5+7.0	12.0				
2.0+2.5+3.2+5.0	12.7	2.5+2.8+2.8	8.1				
2.0+2.5+4.0+4.0	12.5	2.5+2.8+3.2	8.5				
2.0+2.5+4.0+5.0	13.5	2.5+2.8+4.0	9.3				
2.0+2.8+2.8+2.8	10.4	2.5+2.8+5.0	10.3				
2.0+2.8+2.8+3.2	10.8	2.5+2.8+6.0	11.3				
2.0+2.8+2.8+4.0	11.6	2.5+2.8+7.0	12.3				
2.0+2.8+2.8+5.0	12.6	2.5+3.2+3.2	8.9				
2.0+2.8+2.8+6.0	13.6	2.5+3.2+4.0	9.7				
2.0+2.8+3.2+3.2	11.2	2.5+3.2+5.0	10.7				
2.0+2.8+3.2+4.0	12.0	2.5+3.2+6.0	11.7				
2.0+2.8+3.2+5.0	13.0	2.5+3.2+7.0	12.7				
2.0+2.8+4.0+4.0	12.8	2.5+4.0+4.0	10.5				
2.0+3.2+3.2+3.2	11.6	2.5+4.0+5.0	11.5				
2.0+3.2+3.2+4.0	12.4	2.5+4.0+6.0	12.5				
2.0+3.2+3.2+5.0	13.4	2.5+4.0+7.0	13.5				
2.0+3.2+4.0+4.0	13.2	2.5+5.0+5.0	12.5				
2.5+2.5+2.5+2.5	10.0	2.5+5.0+6.0	13.5				
2.5+2.5+2.5+2.8	10.3	2.8+2.8+2.8	8.4				
2.5+2.5+2.5+3.2	10.7	2.8+2.8+3.2	8.8				

4 Room		3 Room		2 Room		1 Room	
Indoor Unit Capacity (kW)	Total Indoor Capacity (kW)	Indoor Unit Capacity (kW)	Total Indoor Capacity (kW)	Indoor Unit Capacity (kW)	Total Indoor Capacity (kW)	Indoor Unit Capacity (kW)	Total Indoor Capacity (kW)
2.5+2.5+2.5+4.0	11.5	2.8+2.8+4.0	9.6				
2.5+2.5+2.5+5.0	12.5	2.8+2.8+5.0	10.6				
2.5+2.5+2.5+6.0	13.5	2.8+2.8+6.0	11.6				
2.5+2.5+2.8+2.8	10.6	2.8+2.8+7.0	12.6				
2.5+2.5+2.8+3.2	11.0	2.8+3.2+3.2	9.2				
2.5+2.5+2.8+4.0	11.8	2.8+3.2+4.0	10.0				
2.5+2.5+2.8+5.0	12.8	2.8+3.2+5.0	11.0				
2.5+2.5+3.2+3.2	11.4	2.8+3.2+6.0	12.0				
2.5+2.5+3.2+4.0	12.2	2.8+3.2+7.0	13.0				
2.5+2.5+3.2+5.0	13.2	2.8+4.0+4.0	10.8				
2.5+2.5+4.0+4.0	13.0	2.8+4.0+5.0	11.8				
2.5+2.8+2.8+2.8	10.9	2.8+4.0+6.0	12.8				
2.5+2.8+2.8+3.2	11.3	2.8+5.0+5.0	12.8				
2.5+2.8+2.8+4.0	12.1	3.2+3.2+3.2	9.6				
2.5+2.8+2.8+5.0	13.1	3.2+3.2+4.0	10.4				
2.5+2.8+3.2+3.2	11.7	3.2+3.2+5.0	11.4				
2.5+2.8+3.2+4.0	12.5	3.2+3.2+6.0	12.4				
2.5+2.8+3.2+5.0	13.5	3.2+3.2+7.0	13.4				
2.5+2.8+4.0+4.0	13.3	3.2+4.0+4.0	11.2				
2.5+3.2+3.2+3.2	12.1	3.2+4.0+5.0	12.2				
2.5+3.2+3.2+4.0	12.9	3.2+4.0+6.0	13.2				
2.8+2.8+2.8+2.8	11.2	3.2+5.0+5.0	13.2				
2.8+2.8+2.8+3.2	11.6	4.0+4.0+4.0	12.0				
2.8+2.8+2.8+4.0	12.4	4.0+4.0+5.0	13.0				
2.8+2.8+2.8+5.0	13.4						
2.8+2.8+3.2+3.2	12.0						
2.8+2.8+3.2+4.0	12.8						
2.8+2.8+4.0+4.0	13.6						
2.8+3.2+3.2+3.2	12.4						
2.8+3.2+3.2+4.0	13.2						
3.2+3.2+3.2+3.2	12.8						
3.2+3.2+3.2+4.0	13.6						

- Indoor Unit : CS-E7/9/12/15/18/21/24PKEW, CS-E9/12/18GFEW, CS-ME9/12/18/21PB4EA, CS-ME9/12/18PD3EA, CS-E9/12PD3EA, CS-E9/12PB4EA, CS-E18/21RB4EAW
- Outdoor Unit : CU-5E34PBE

5 Room		4 Room		3 Room		2 Room		1 Room	
Indoor Unit Capacity (kW)	Total Indoor Capacity (kW)	Indoor Unit Capacity (kW)	Total Indoor Capacity (kW)	Indoor Unit Capacity (kW)	Total Indoor Capacity (kW)	Indoor Unit Capacity (kW)	Total Indoor Capacity (kW)	Indoor Unit Capacity (kW)	Total Indoor Capacity (kW)
2.0+2.0+2.0+2.0+2.0	10.0	2.0+2.0+2.0+2.0	8.0	2.0+2.0+2.0	6.0	2.0+2.5	4.5	2.0	2.0
2.0+2.0+2.0+2.0+2.5	10.5	2.0+2.0+2.0+2.5	8.5	2.0+2.0+2.5	6.5	2.0+2.8	4.8	2.5	2.5
2.0+2.0+2.0+2.0+2.8	10.8	2.0+2.0+2.0+2.8	8.8	2.0+2.0+2.8	6.8	2.0+3.2	5.2	2.8	2.8
2.0+2.0+2.0+2.0+3.2	11.2	2.0+2.0+2.0+3.2	9.2	2.0+2.0+3.2	7.2	2.0+4.0	6.0	3.2	3.2
2.0+2.0+2.0+2.0+4.0	12.0	2.0+2.0+2.0+4.0	10.0	2.0+2.0+4.0	8.0	2.0+5.0	7.0	4.0	4.0
2.0+2.0+2.0+2.0+5.0	13.0	2.0+2.0+2.0+5.0	11.0	2.0+2.0+5.0	9.0	2.0+6.0	8.0	5.0	5.0
2.0+2.0+2.0+2.0+6.0	14.0	2.0+2.0+2.0+6.0	12.0	2.0+2.0+6.0	10.0	2.0+7.0	9.0	6.0	6.0
2.0+2.0+2.0+2.0+7.0	15.0	2.0+2.0+2.0+7.0	13.0	2.0+2.0+7.0	11.0	2.5+2.5	5.0	7.0	7.0
2.0+2.0+2.0+2.5+2.5	11.0	2.0+2.0+2.5+2.5	9.0	2.0+2.5+2.5	7.0	2.5+2.8	5.3		
2.0+2.0+2.0+2.5+2.8	11.3	2.0+2.0+2.5+2.8	9.3	2.0+2.5+2.8	7.3	2.5+3.2	5.7		
2.0+2.0+2.0+2.5+3.2	11.7	2.0+2.0+2.5+3.2	9.7	2.0+2.5+3.2	7.7	2.5+4.0	6.5		
2.0+2.0+2.0+2.5+4.0	12.5	2.0+2.0+2.5+4.0	10.5	2.0+2.5+4.0	8.5	2.5+5.0	7.5		
2.0+2.0+2.0+2.5+5.0	13.5	2.0+2.0+2.5+5.0	11.5	2.0+2.5+5.0	9.5	2.5+6.0	8.5		
2.0+2.0+2.0+2.5+6.0	14.5	2.0+2.0+2.5+6.0	12.5	2.0+2.5+6.0	10.5	2.5+7.0	9.5		
2.0+2.0+2.0+2.5+7.0	15.5	2.0+2.0+2.5+7.0	13.5	2.0+2.5+7.0	11.5	2.8+2.8	5.6		
2.0+2.0+2.0+2.8+2.8	11.6	2.0+2.0+2.8+2.8	9.6	2.0+2.8+2.8	7.6	2.8+3.2	6.0		
2.0+2.0+2.0+2.8+3.2	12.0	2.0+2.0+2.8+3.2	10.0	2.0+2.8+3.2	8.0	2.8+4.0	6.8		
2.0+2.0+2.0+2.8+4.0	12.8	2.0+2.0+2.8+4.0	10.8	2.0+2.8+4.0	8.8	2.8+5.0	7.8		
2.0+2.0+2.0+2.8+5.0	13.8	2.0+2.0+2.8+5.0	11.8	2.0+2.8+5.0	9.8	2.8+6.0	8.8		
2.0+2.0+2.0+2.8+6.0	14.8	2.0+2.0+2.8+6.0	12.8	2.0+2.8+6.0	10.8	2.8+7.0	9.8		
2.0+2.0+2.0+2.8+7.0	15.8	2.0+2.0+2.8+7.0	13.8	2.0+2.8+7.0	11.8	3.2+3.2	6.4		
2.0+2.0+2.0+3.2+3.2	12.4	2.0+2.0+3.2+3.2	10.4	2.0+3.2+3.2	8.4	3.2+4.0	7.2		
2.0+2.0+2.0+3.2+4.0	13.2	2.0+2.0+3.2+4.0	11.2	2.0+3.2+4.0	9.2	3.2+5.0	8.2		
2.0+2.0+2.0+3.2+5.0	14.2	2.0+2.0+3.2+5.0	12.2	2.0+3.2+5.0	10.2	3.2+6.0	9.2		
2.0+2.0+2.0+3.2+6.0	15.2	2.0+2.0+3.2+6.0	13.2	2.0+3.2+6.0	11.2	3.2+7.0	10.2		
2.0+2.0+2.0+3.2+7.0	16.2	2.0+2.0+3.2+7.0	14.2	2.0+3.2+7.0	12.2	4.0+4.0	8.0		
2.0+2.0+2.0+4.0+4.0	14.0	2.0+2.0+4.0+4.0	12.0	2.0+4.0+4.0	10.0	4.0+5.0	9.0		
2.0+2.0+2.0+4.0+5.0	15.0	2.0+2.0+4.0+5.0	13.0	2.0+4.0+5.0	11.0	4.0+6.0	10.0		
2.0+2.0+2.0+4.0+6.0	16.0	2.0+2.0+4.0+6.0	14.0	2.0+4.0+6.0	12.0	4.0+7.0	11.0		
2.0+2.0+2.0+4.0+7.0	17.0	2.0+2.0+4.0+7.0	15.0	2.0+4.0+7.0	13.0	5.0+5.0	10.0		
2.0+2.0+2.0+5.0+5.0	16.0	2.0+2.0+5.0+5.0	14.0	2.0+5.0+5.0	12.0	5.0+6.0	11.0		
2.0+2.0+2.0+5.0+6.0	17.0	2.0+2.0+5.0+6.0	15.0	2.0+5.0+6.0	13.0	5.0+7.0	12.0		
2.0+2.0+2.5+2.5+2.5	11.5	2.0+2.0+5.0+7.0	16.0	2.0+5.0+7.0	14.0	6.0+6.0	12.0		
2.0+2.0+2.5+2.5+2.8	11.8	2.0+2.0+6.0+6.0	16.0	2.0+6.0+6.0	14.0	6.0+7.0	13.0		
2.0+2.0+2.5+2.5+3.2	12.2	2.0+2.0+6.0+7.0	17.0	2.0+6.0+7.0	15.0	7.0+7.0	14.0		
2.0+2.0+2.5+2.5+4.0	13.0	2.0+2.5+2.5+2.5	9.5	2.0+7.0+7.0	16.0				
2.0+2.0+2.5+2.5+5.0	14.0	2.0+2.5+2.5+2.8	9.8	2.5+2.5+2.5	7.5				
2.0+2.0+2.5+2.5+6.0	15.0	2.0+2.5+2.5+3.2	10.2	2.5+2.5+2.8	7.8				
2.0+2.0+2.5+2.5+7.0	16.0	2.0+2.5+2.5+4.0	11.0	2.5+2.5+3.2	8.2				
2.0+2.0+2.5+2.8+2.8	12.1	2.0+2.5+2.5+5.0	12.0	2.5+2.5+4.0	9.0				
2.0+2.0+2.5+2.8+3.2	12.5	2.0+2.5+2.5+6.0	13.0	2.5+2.5+5.0	10.0				
2.0+2.0+2.5+2.8+4.0	13.3	2.0+2.5+2.5+7.0	14.0	2.5+2.5+6.0	11.0				
2.0+2.0+2.5+2.8+5.0	14.3	2.0+2.5+2.8+2.8	10.1	2.5+2.5+7.0	12.0				
2.0+2.0+2.5+2.8+6.0	15.3	2.0+2.5+2.8+3.2	10.5	2.5+2.8+2.8	8.1				
2.0+2.0+2.5+2.8+7.0	16.3	2.0+2.5+2.8+4.0	11.3	2.5+2.8+3.2	8.5				
2.0+2.0+2.5+3.2+3.2	12.9	2.0+2.5+2.8+5.0	12.3	2.5+2.8+4.0	9.3				
2.0+2.0+2.5+3.2+4.0	13.7	2.0+2.5+2.8+6.0	13.3	2.5+2.8+5.0	10.3				
2.0+2.0+2.5+3.2+5.0	14.7	2.0+2.5+2.8+7.0	14.3	2.5+2.8+6.0	11.3				
2.0+2.0+2.5+3.2+6.0	15.7	2.0+2.5+3.2+3.2	10.9	2.5+2.8+7.0	12.3				
2.0+2.0+2.5+3.2+7.0	16.7	2.0+2.5+3.2+4.0	11.7	2.5+3.2+3.2	8.9				
2.0+2.0+2.5+4.0+4.0	14.5	2.0+2.5+3.2+5.0	12.7	2.5+3.2+4.0	9.7				
2.0+2.0+2.5+4.0+5.0	15.5	2.0+2.5+3.2+6.0	13.7	2.5+3.2+5.0	10.7				
2.0+2.0+2.5+4.0+6.0	16.5	2.0+2.5+3.2+7.0	14.7	2.5+3.2+6.0	11.7				
2.0+2.0+2.5+4.0+7.0	17.5	2.0+2.5+4.0+4.0	12.5	2.5+3.2+7.0	12.7				
2.0+2.0+2.5+5.0+5.0	16.5	2.0+2.5+4.0+5.0	13.5	2.5+4.0+4.0	10.5				
2.0+2.0+2.5+5.0+6.0	17.5	2.0+2.5+4.0+6.0	14.5	2.5+4.0+5.0	11.5				
2.0+2.0+2.5+5.0+7.0	18.5	2.0+2.5+4.0+7.0	15.5	2.5+4.0+6.0	12.5				

5 Room		4 Room		3 Room		2 Room		1 Room	
Indoor Unit Capacity (kW)	Total Indoor Capacity (kW)	Indoor Unit Capacity (kW)	Total Indoor Capacity (kW)	Indoor Unit Capacity (kW)	Indoor Unit Capacity (kW)	Total Indoor Capacity (kW)	Indoor Unit Capacity (kW)	Total Indoor Capacity (kW)	Indoor Unit Capacity (kW)
2.0+2.0+2.8+2.8+3.2	12.8	2.0+2.5+5.0+5.0	14.5	2.5+4.0+7.0	13.5				
2.0+2.0+2.8+2.8+4.0	13.6	2.0+2.5+5.0+6.0	15.5	2.5+5.0+5.0	12.5				
2.0+2.0+2.8+2.8+5.0	14.6	2.0+2.5+5.0+7.0	16.5	2.5+5.0+6.0	13.5				
2.0+2.0+2.8+2.8+6.0	15.6	2.0+2.5+6.0+6.0	16.5	2.5+5.0+7.0	14.5				
2.0+2.0+2.8+2.8+7.0	16.6	2.0+2.5+6.0+7.0	17.5	2.5+6.0+6.0	14.5				
2.0+2.0+2.8+3.2+3.2	13.2	2.0+2.8+2.8+2.8	10.4	2.5+6.0+7.0	15.5				
2.0+2.0+2.8+3.2+4.0	14.0	2.0+2.8+2.8+3.2	10.8	2.5+7.0+7.0	16.5				
2.0+2.0+2.8+3.2+5.0	15.0	2.0+2.8+2.8+4.0	11.6	2.8+2.8+2.8	8.4				
2.0+2.0+2.8+3.2+6.0	16.0	2.0+2.8+2.8+5.0	12.6	2.8+2.8+3.2	8.8				
2.0+2.0+2.8+3.2+7.0	17.0	2.0+2.8+2.8+6.0	13.6	2.8+2.8+4.0	9.6				
2.0+2.0+2.8+4.0+4.0	14.8	2.0+2.8+2.8+7.0	14.6	2.8+2.8+5.0	10.6				
2.0+2.0+2.8+4.0+5.0	15.8	2.0+2.8+3.2+3.2	11.2	2.8+2.8+6.0	11.6				
2.0+2.0+2.8+4.0+6.0	16.8	2.0+2.8+3.2+4.0	12.0	2.8+2.8+7.0	12.6				
2.0+2.0+2.8+5.0+5.0	16.8	2.0+2.8+3.2+5.0	13.0	2.8+3.2+3.2	9.2				
2.0+2.0+3.2+3.2+3.2	13.6	2.0+2.8+3.2+6.0	14.0	2.8+3.2+4.0	10.0				
2.0+2.0+3.2+3.2+4.0	14.4	2.0+2.8+3.2+7.0	15.0	2.8+3.2+5.0	11.0				
2.0+2.0+3.2+3.2+5.0	15.4	2.0+2.8+4.0+4.0	12.8	2.8+3.2+6.0	12.0				
2.0+2.0+3.2+3.2+6.0	16.4	2.0+2.8+4.0+5.0	13.8	2.8+3.2+7.0	13.0				
2.0+2.0+3.2+3.2+7.0	17.4	2.0+2.8+4.0+6.0	14.8	2.8+4.0+4.0	10.8				
2.0+2.0+3.2+4.0+4.0	15.2	2.0+2.8+4.0+7.0	15.8	2.8+4.0+5.0	11.8				
2.0+2.0+3.2+4.0+5.0	16.2	2.0+2.8+5.0+5.0	14.8	2.8+4.0+6.0	12.8				
2.0+2.0+3.2+4.0+6.0	17.2	2.0+2.8+5.0+6.0	15.8	2.8+4.0+7.0	13.8				
2.0+2.0+3.2+5.0+5.0	17.2	2.0+2.8+5.0+7.0	16.8	2.8+5.0+5.0	12.8				
2.0+2.0+4.0+4.0+4.0	16.0	2.0+2.8+6.0+6.0	16.8	2.8+5.0+6.0	13.8				
2.0+2.0+4.0+4.0+5.0	17.0	2.0+3.2+3.2+3.2	11.6	2.8+5.0+7.0	14.8				
2.0+2.5+2.5+2.5+2.5	12.0	2.0+3.2+3.2+4.0	12.4	2.8+6.0+6.0	14.8				
2.0+2.5+2.5+2.5+2.8	12.3	2.0+3.2+3.2+5.0	13.4	2.8+6.0+7.0	15.8				
2.0+2.5+2.5+2.5+3.2	12.7	2.0+3.2+3.2+6.0	14.4	2.8+7.0+7.0	16.8				
2.0+2.5+2.5+2.5+4.0	13.5	2.0+3.2+3.2+7.0	15.4	3.2+3.2+3.2	9.6				
2.0+2.5+2.5+2.5+5.0	14.5	2.0+3.2+4.0+4.0	13.2	3.2+3.2+4.0	10.4				
2.0+2.5+2.5+2.5+6.0	15.5	2.0+3.2+4.0+5.0	14.2	3.2+3.2+5.0	11.4				
2.0+2.5+2.5+2.5+7.0	16.5	2.0+3.2+4.0+6.0	15.2	3.2+3.2+6.0	12.4				
2.0+2.5+2.5+2.8+2.8	12.6	2.0+3.2+4.0+7.0	16.2	3.2+3.2+7.0	13.4				
2.0+2.5+2.5+2.8+3.2	13.0	2.0+3.2+5.0+5.0	15.2	3.2+4.0+4.0	11.2				
2.0+2.5+2.5+2.8+4.0	13.8	2.0+3.2+5.0+6.0	16.2	3.2+4.0+5.0	12.2				
2.0+2.5+2.5+2.8+5.0	14.8	2.0+3.2+5.0+7.0	17.2	3.2+4.0+6.0	13.2				
2.0+2.5+2.5+2.8+6.0	15.8	2.0+3.2+6.0+6.0	17.2	3.2+4.0+7.0	14.2				
2.0+2.5+2.5+2.8+7.0	16.8	2.0+4.0+4.0+4.0	14.0	3.2+5.0+5.0	13.2				
2.0+2.5+2.5+3.2+3.2	13.4	2.0+4.0+4.0+5.0	15.0	3.2+5.0+6.0	14.2				
2.0+2.5+2.5+3.2+4.0	14.2	2.0+4.0+4.0+6.0	16.0	3.2+5.0+7.0	15.2				
2.0+2.5+2.5+3.2+5.0	15.2	2.0+4.0+4.0+7.0	17.0	3.2+6.0+6.0	15.2				
2.0+2.5+2.5+3.2+6.0	16.2	2.0+4.0+5.0+5.0	16.0	3.2+6.0+7.0	16.2				
2.0+2.5+2.5+3.2+7.0	17.2	2.0+4.0+5.0+6.0	17.0	3.2+7.0+7.0	17.2				
2.0+2.5+2.5+4.0+4.0	15.0	2.0+5.0+5.0+5.0	17.0	4.0+4.0+4.0	12.0				
2.0+2.5+2.5+4.0+5.0	16.0	2.5+2.5+2.5+2.5	10.0	4.0+4.0+5.0	13.0				
2.0+2.5+2.5+4.0+6.0	17.0	2.5+2.5+2.5+2.8	10.3	4.0+4.0+6.0	14.0				
2.0+2.5+2.5+5.0+5.0	17.0	2.5+2.5+2.5+3.2	10.7	4.0+4.0+7.0	15.0				
2.0+2.5+2.8+2.8+2.8	12.9	2.5+2.5+2.5+4.0	11.5	4.0+5.0+5.0	14.0				
2.0+2.5+2.8+2.8+3.2	13.3	2.5+2.5+2.5+5.0	12.5	4.0+5.0+6.0	15.0				
2.0+2.5+2.8+2.8+4.0	14.1	2.5+2.5+2.5+6.0	13.5	4.0+5.0+7.0	16.0				
2.0+2.5+2.8+2.8+5.0	15.1	2.5+2.5+2.5+7.0	14.5	4.0+6.0+6.0	16.0				
2.0+2.5+2.8+2.8+6.0	16.1	2.5+2.5+2.8+2.8	10.6	4.0+6.0+7.0	17.0				
2.0+2.5+2.8+2.8+7.0	17.1	2.5+2.5+2.8+3.2	11.0	5.0+5.0+5.0	15.0				
2.0+2.5+2.8+3.2+3.2	13.7	2.5+2.5+2.8+4.0	11.8	5.0+5.0+6.0	16.0				
2.0+2.5+2.8+3.2+4.0	14.5	2.5+2.5+2.8+5.0	12.8	5.0+5.0+7.0	17.0				
2.0+2.5+2.8+3.2+5.0	15.5	2.5+2.5+2.8+6.0	13.8	5.0+6.0+6.0	17.0				
2.0+2.5+2.8+3.2+6.0	16.5	2.5+2.5+2.8+7.0	14.8						
2.0+2.5+2.8+3.2+7.0	17.5	2.5+2.5+3.2+3.2	11.4						
2.0+2.5+2.8+4.0+4.0	15.3	2.5+2.5+3.2+4.0	12.2						
2.0+2.5+2.8+4.0+5.0	16.3	2.5+2.5+3.2+5.0	13.2						
2.0+2.5+2.8+4.0+6.0	17.3	2.5+2.5+3.2+6.0	14.2						

5 Room		4 Room		3 Room		2 Room		1 Room	
Indoor Unit Capacity (kW)	Total Indoor Capacity (kW)	Indoor Unit Capacity (kW)	Total Indoor Capacity (kW)	Indoor Unit Capacity (kW)	Indoor Unit Capacity (kW)	Total Indoor Capacity (kW)	Indoor Unit Capacity (kW)	Total Indoor Capacity (kW)	Indoor Unit Capacity (kW)
2.0+2.5+2.8+5.0+5.0	17.3	2.5+2.5+3.2+7.0	15.2						
2.0+2.5+3.2+3.2+3.2	14.1	2.5+2.5+4.0+4.0	13.0						
2.0+2.5+3.2+3.2+4.0	14.9	2.5+2.5+4.0+5.0	14.0						
2.0+2.5+3.2+3.2+5.0	15.9	2.5+2.5+4.0+6.0	15.0						
2.0+2.5+3.2+3.2+6.0	16.9	2.5+2.5+4.0+7.0	16.0						
2.0+2.5+3.2+4.0+4.0	15.7	2.5+2.5+5.0+5.0	15.0						
2.0+2.5+3.2+4.0+5.0	16.7	2.5+2.5+5.0+6.0	16.0						
2.0+2.5+4.0+4.0+4.0	16.5	2.5+2.5+5.0+7.0	17.0						
2.0+2.5+4.0+4.0+5.0	17.5	2.5+2.5+6.0+6.0	17.0						
2.0+2.8+2.8+2.8+2.8	13.2	2.5+2.8+2.8+2.8	10.9						
2.0+2.8+2.8+2.8+3.2	13.6	2.5+2.8+2.8+3.2	11.3						
2.0+2.8+2.8+2.8+4.0	14.4	2.5+2.8+2.8+4.0	12.1						
2.0+2.8+2.8+2.8+5.0	15.4	2.5+2.8+2.8+5.0	13.1						
2.0+2.8+2.8+2.8+6.0	16.4	2.5+2.8+2.8+6.0	14.1						
2.0+2.8+2.8+2.8+7.0	17.4	2.5+2.8+2.8+7.0	15.1						
2.0+2.8+2.8+3.2+3.2	14.0	2.5+2.8+3.2+3.2	11.7						
2.0+2.8+2.8+3.2+4.0	14.8	2.5+2.8+3.2+4.0	12.5						
2.0+2.8+2.8+3.2+5.0	15.8	2.5+2.8+3.2+5.0	13.5						
2.0+2.8+2.8+3.2+6.0	16.8	2.5+2.8+3.2+6.0	14.5						
2.0+2.8+2.8+4.0+4.0	15.6	2.5+2.8+3.2+7.0	15.5						
2.0+2.8+2.8+4.0+5.0	16.6	2.5+2.8+4.0+4.0	13.3						
2.0+2.8+3.2+3.2+3.2	14.4	2.5+2.8+4.0+5.0	14.3						
2.0+2.8+3.2+3.2+4.0	15.2	2.5+2.8+4.0+6.0	15.3						
2.0+2.8+3.2+3.2+5.0	16.2	2.5+2.8+4.0+7.0	16.3						
2.0+2.8+3.2+3.2+6.0	17.2	2.5+2.8+5.0+5.0	15.3						
2.0+2.8+3.2+4.0+4.0	16.0	2.5+2.8+5.0+6.0	16.3						
2.0+2.8+3.2+4.0+5.0	17.0	2.5+2.8+5.0+7.0	17.3						
2.0+2.8+4.0+4.0+4.0	16.8	2.5+2.8+6.0+6.0	17.3						
2.0+3.2+3.2+3.2+3.2	14.8	2.5+3.2+3.2+3.2	12.1						
2.0+3.2+3.2+3.2+4.0	15.6	2.5+3.2+3.2+4.0	12.9						
2.0+3.2+3.2+3.2+5.0	16.6	2.5+3.2+3.2+5.0	13.9						
2.0+3.2+3.2+4.0+4.0	16.4	2.5+3.2+3.2+6.0	14.9						
2.0+3.2+3.2+4.0+5.0	17.4	2.5+3.2+3.2+7.0	15.9						
2.0+3.2+4.0+4.0+4.0	17.2	2.5+3.2+4.0+4.0	13.7						
2.5+2.5+2.5+2.5+2.5	12.5	2.5+3.2+4.0+5.0	14.7						
2.5+2.5+2.5+2.5+2.8	12.8	2.5+3.2+4.0+6.0	15.7						
2.5+2.5+2.5+2.5+3.2	13.2	2.5+3.2+4.0+7.0	16.7						
2.5+2.5+2.5+2.5+4.0	14.0	2.5+3.2+5.0+5.0	15.7						
2.5+2.5+2.5+2.5+5.0	15.0	2.5+3.2+5.0+6.0	16.7						
2.5+2.5+2.5+2.5+6.0	16.0	2.5+4.0+4.0+4.0	14.5						
2.5+2.5+2.5+2.5+7.0	17.0	2.5+4.0+4.0+5.0	15.5						
2.5+2.5+2.5+2.8+2.8	13.1	2.5+4.0+4.0+6.0	16.5						
2.5+2.5+2.5+2.8+3.2	13.5	2.5+4.0+4.0+7.0	17.5						
2.5+2.5+2.5+2.8+4.0	14.3	2.5+4.0+5.0+5.0	16.5						
2.5+2.5+2.5+2.8+5.0	15.3	2.5+4.0+5.0+6.0	17.5						
2.5+2.5+2.5+2.8+6.0	16.3	2.5+5.0+5.0+5.0	17.5						
2.5+2.5+2.5+2.8+7.0	17.3	2.8+2.8+2.8+2.8	11.2						
2.5+2.5+2.5+3.2+3.2	13.9	2.8+2.8+2.8+3.2	11.6						
2.5+2.5+2.5+3.2+4.0	14.7	2.8+2.8+2.8+4.0	12.4						
2.5+2.5+2.5+3.2+5.0	15.7	2.8+2.8+2.8+5.0	13.4						
2.5+2.5+2.5+3.2+6.0	16.7	2.8+2.8+2.8+6.0	14.4						
2.5+2.5+2.5+4.0+4.0	15.5	2.8+2.8+2.8+7.0	15.4						
2.5+2.5+2.5+4.0+5.0	16.5	2.8+2.8+3.2+3.2	12.0						
2.5+2.5+2.5+4.0+6.0	17.5	2.8+2.8+3.2+4.0	12.8						
2.5+2.5+2.5+5.0+5.0	17.5	2.8+2.8+3.2+5.0	13.8						
2.5+2.5+2.8+2.8+2.8	13.4	2.8+2.8+3.2+6.0	14.8						
2.5+2.5+2.8+2.8+3.2	13.8	2.8+2.8+3.2+7.0	15.8						
2.5+2.5+2.8+2.8+4.0	14.6	2.8+2.8+4.0+4.0	13.6						
2.5+2.5+2.8+2.8+5.0	15.6	2.8+2.8+4.0+5.0	14.6						
2.5+2.5+2.8+2.8+6.0	16.6	2.8+2.8+4.0+6.0	15.6						
2.5+2.5+2.8+3.2+3.2	14.2	2.8+2.8+4.0+7.0	16.6						

5 Room		4 Room		3 Room		2 Room		1 Room	
Indoor Unit Capacity (kW)	Total Indoor Capacity (kW)	Indoor Unit Capacity (kW)	Total Indoor Capacity (kW)	Indoor Unit Capacity (kW)	Indoor Unit Capacity (kW)	Total Indoor Capacity (kW)	Indoor Unit Capacity (kW)	Total Indoor Capacity (kW)	Indoor Unit Capacity (kW)
2.5+2.5+2.8+3.2+4.0	15.0	2.8+2.8+5.0+5.0	15.6						
2.5+2.5+2.8+3.2+5.0	16.0	2.8+2.8+5.0+6.0	16.6						
2.5+2.5+2.8+3.2+6.0	17.0	2.8+3.2+3.2+3.2	12.4						
2.5+2.5+2.8+4.0+4.0	15.8	2.8+3.2+3.2+4.0	13.2						
2.5+2.5+2.8+4.0+5.0	16.8	2.8+3.2+3.2+5.0	14.2						
2.5+2.5+3.2+3.2+3.2	14.6	2.8+3.2+3.2+6.0	15.2						
2.5+2.5+3.2+3.2+4.0	15.4	2.8+3.2+3.2+7.0	16.2						
2.5+2.5+3.2+3.2+5.0	16.4	2.8+3.2+4.0+4.0	14.0						
2.5+2.5+3.2+3.2+6.0	17.4	2.8+3.2+4.0+5.0	15.0						
2.5+2.5+3.2+4.0+4.0	16.2	2.8+3.2+4.0+6.0	16.0						
2.5+2.5+3.2+4.0+5.0	17.2	2.8+3.2+4.0+7.0	17.0						
2.5+2.5+4.0+4.0+4.0	17.0	2.8+3.2+5.0+5.0	16.0						
2.5+2.8+2.8+2.8+2.8	13.7	2.8+3.2+5.0+6.0	17.0						
2.5+2.8+2.8+2.8+3.2	14.1	2.8+4.0+4.0+4.0	14.8						
2.5+2.8+2.8+2.8+4.0	14.9	2.8+4.0+4.0+5.0	15.8						
2.5+2.8+2.8+2.8+5.0	15.9	2.8+4.0+4.0+6.0	16.8						
2.5+2.8+2.8+2.8+6.0	16.9	2.8+4.0+5.0+5.0	16.8						
2.5+2.8+2.8+3.2+3.2	14.5	3.2+3.2+3.2+3.2	12.8						
2.5+2.8+2.8+3.2+4.0	15.3	3.2+3.2+3.2+4.0	13.6						
2.5+2.8+2.8+3.2+5.0	16.3	3.2+3.2+3.2+5.0	14.6						
2.5+2.8+2.8+3.2+6.0	17.3	3.2+3.2+3.2+6.0	15.6						
2.5+2.8+2.8+4.0+4.0	16.1	3.2+3.2+3.2+7.0	16.6						
2.5+2.8+2.8+4.0+5.0	17.1	3.2+3.2+4.0+4.0	14.4						
2.5+2.8+3.2+3.2+3.2	14.9	3.2+3.2+4.0+5.0	15.4						
2.5+2.8+3.2+3.2+4.0	15.7	3.2+3.2+4.0+6.0	16.4						
2.5+2.8+3.2+3.2+5.0	16.7	3.2+3.2+4.0+7.0	17.4						
2.5+2.8+3.2+4.0+4.0	16.5	3.2+3.2+5.0+5.0	16.4						
2.5+2.8+3.2+4.0+5.0	17.5	3.2+3.2+5.0+6.0	17.4						
2.5+2.8+4.0+4.0+4.0	17.3	3.2+4.0+4.0+4.0	15.2						
2.5+3.2+3.2+3.2+3.2	15.3	3.2+4.0+4.0+5.0	16.2						
2.5+3.2+3.2+3.2+4.0	16.1	3.2+4.0+4.0+6.0	17.2						
2.5+3.2+3.2+3.2+5.0	17.1	3.2+4.0+5.0+5.0	17.2						
2.5+3.2+3.2+4.0+4.0	16.9	4.0+4.0+4.0+4.0	16.0						
2.8+2.8+2.8+2.8+2.8	14.0	4.0+4.0+4.0+5.0	17.0						
2.8+2.8+2.8+2.8+3.2	14.4								
2.8+2.8+2.8+2.8+4.0	15.2								
2.8+2.8+2.8+2.8+5.0	16.2								
2.8+2.8+2.8+2.8+6.0	17.2								
2.8+2.8+2.8+3.2+3.2	14.8								
2.8+2.8+2.8+3.2+4.0	15.6								
2.8+2.8+2.8+3.2+5.0	16.6								
2.8+2.8+2.8+4.0+4.0	16.4								
2.8+2.8+2.8+4.0+5.0	17.4								
2.8+2.8+3.2+3.2+3.2	15.2								
2.8+2.8+3.2+3.2+4.0	16.0								
2.8+2.8+3.2+3.2+5.0	17.0								
2.8+2.8+3.2+4.0+4.0	16.8								
2.8+3.2+3.2+3.2+3.2	15.6								
2.8+3.2+3.2+3.2+4.0	16.4								
2.8+3.2+3.2+3.2+5.0	17.4								
2.8+3.2+3.2+4.0+4.0	17.2								
3.2+3.2+3.2+3.2+3.2	16.0								
3.2+3.2+3.2+3.2+4.0	16.8								

## 3. Features

- **Inverter Technology**
  - Wider output power range
  - Energy saving
  - Quick Cooling
  - Quick Heating
  - More precise temperature control
- **Environment Protection**
  - Non-ozone depletion substances refrigerant (R410A)
- **Long Installation Piping**
  - Long piping up to 30 meters
- **Easy to use remote control**
- **Quality Improvement**
  - Random auto restart after power failure for safety restart operation
  - Gas leakage protection
  - Prevent compressor reverse cycle
  - Inner protector to protect compressor
  - Noise prevention during soft dry operation
- **Operation Improvement**
  - Quiet mode to reduce the indoor unit operating sound
  - Powerful mode to reach the desired room temperature quickly
  - 24-hour timer setting
- **Serviceability Improvement**
  - Breakdown Self Diagnosis function

## 4. Location of Controls and Components

### 4.1 Indoor Unit

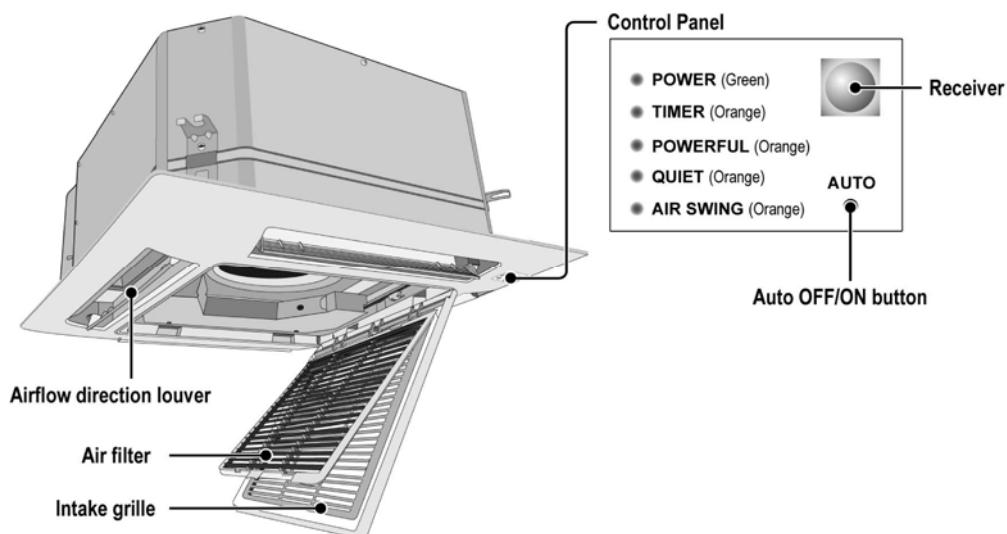

### 4.2 Outdoor Unit

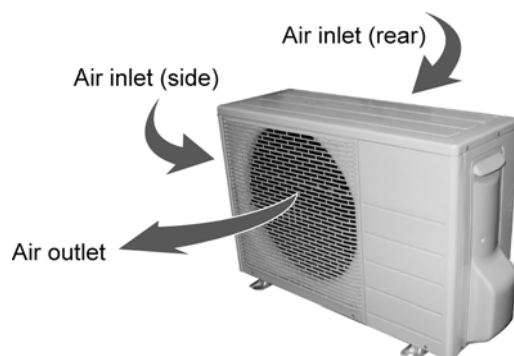

### 4.3 Remote Control

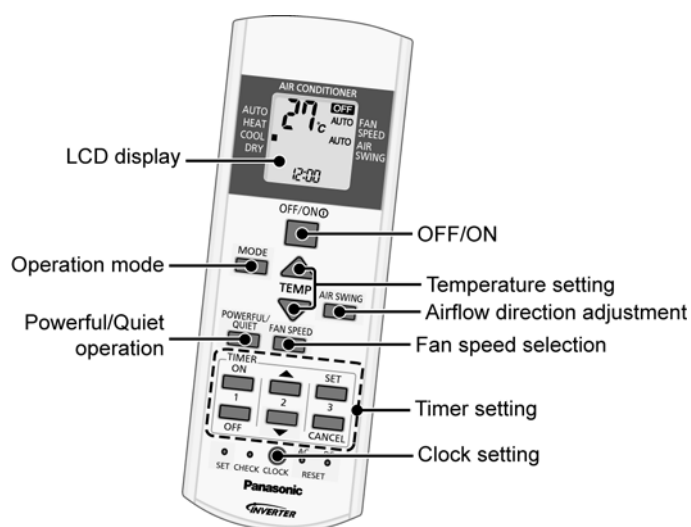



# 5. Dimensions

## 5.1 Indoor Unit

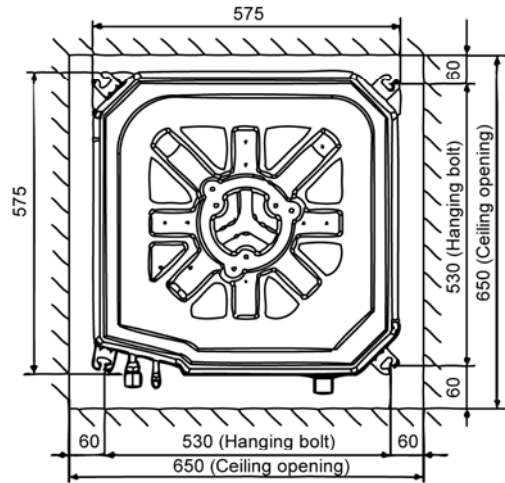
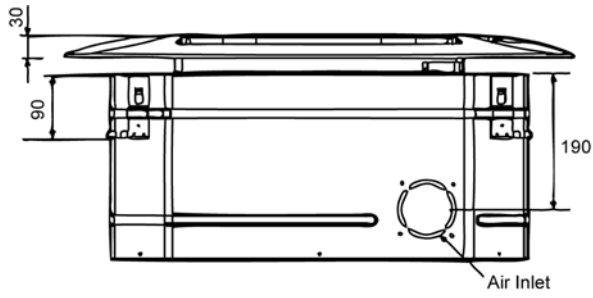

<Remote Control>

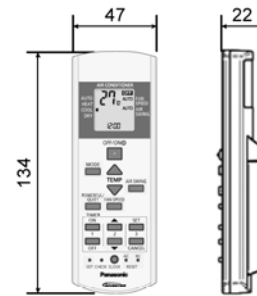

<Remote Control Holder>

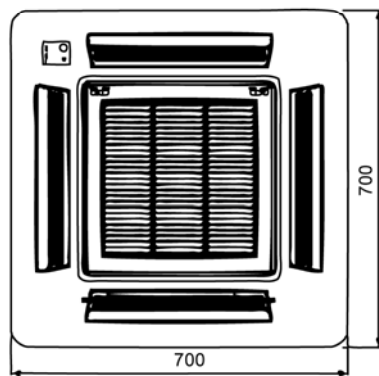
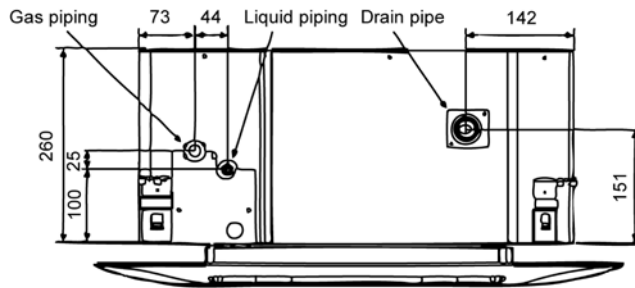
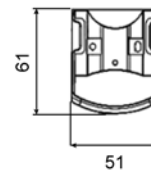

Unit : mm

## 5.2 Outdoor Unit

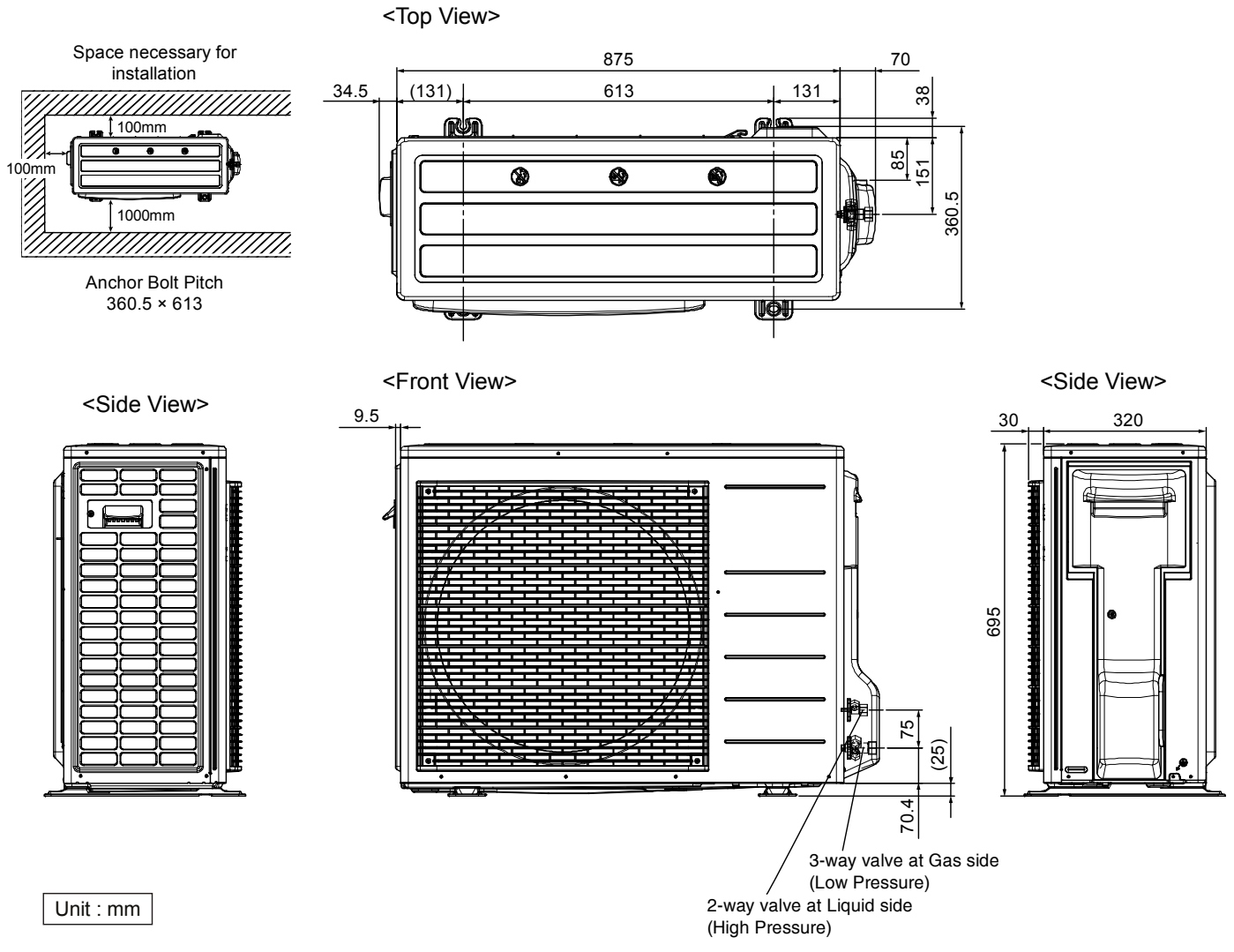

# 6. Refrigeration Cycle Diagram

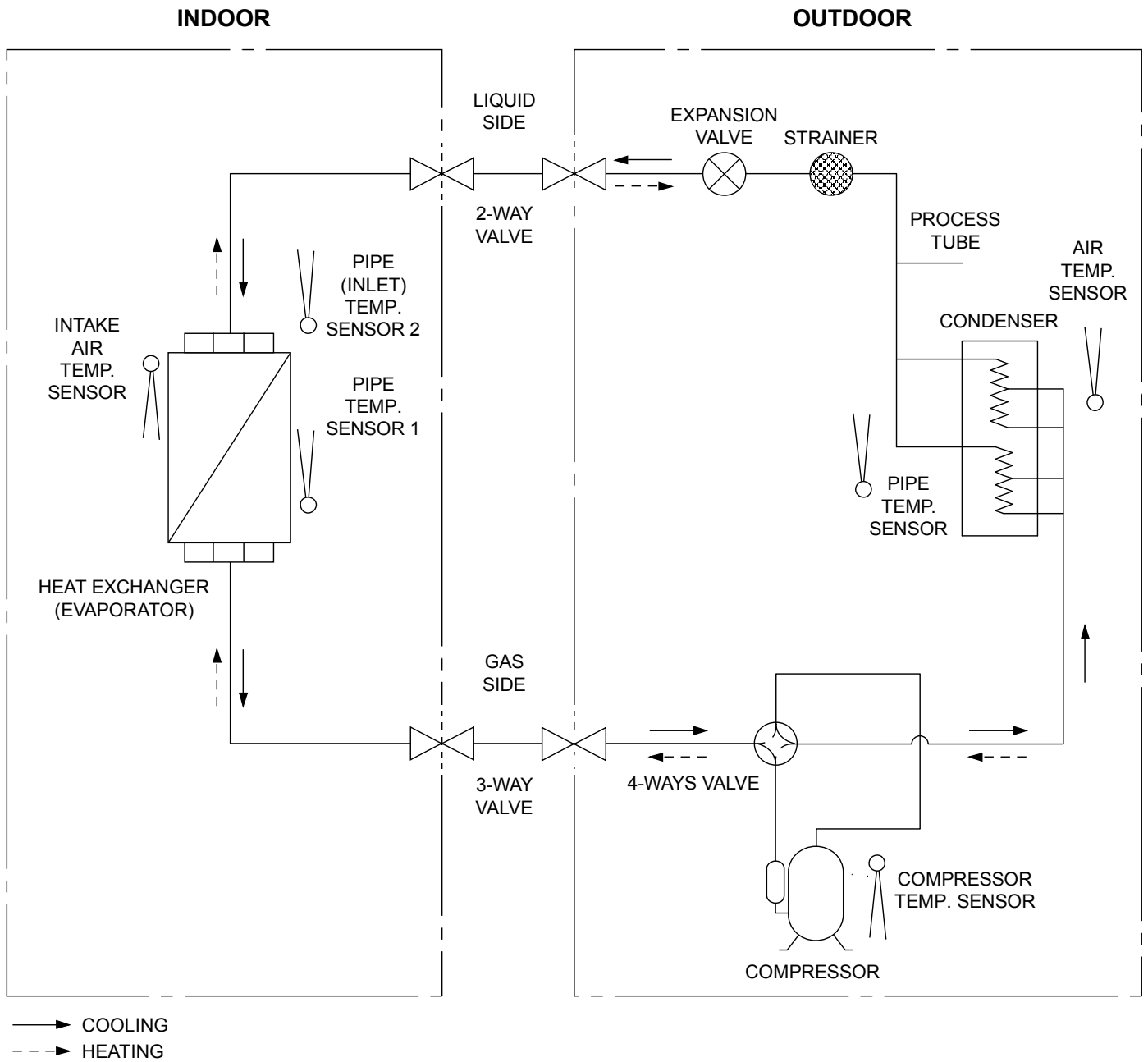

# 7. Block Diagram

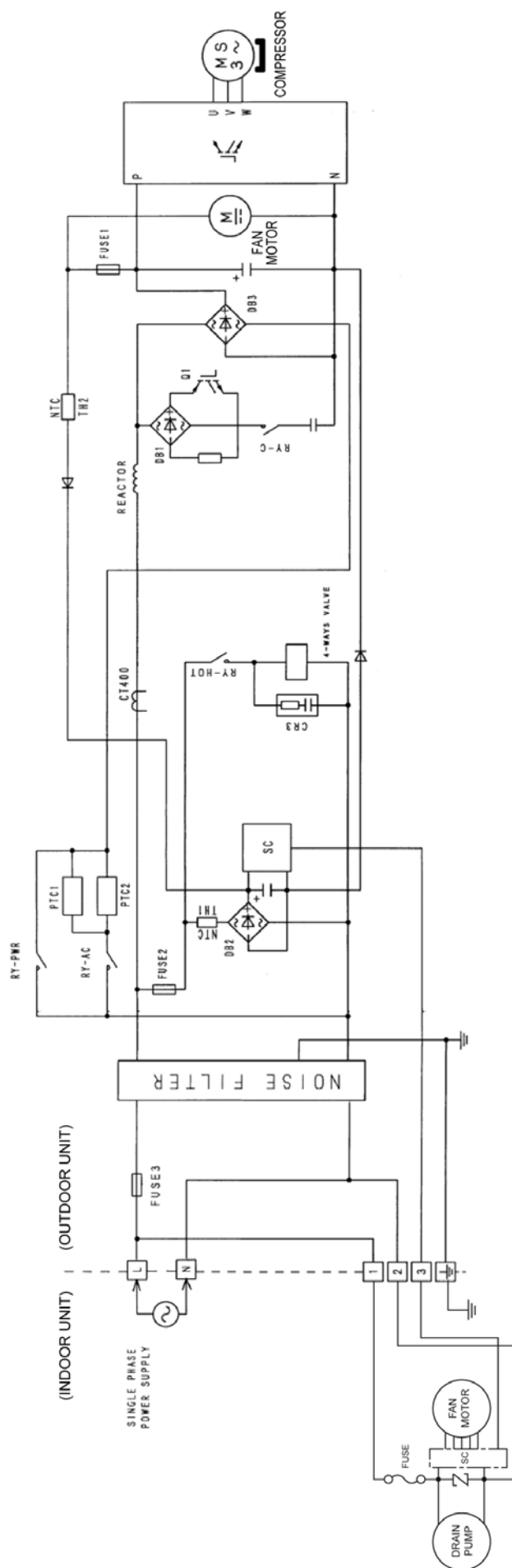

# 8. Wiring Connection Diagram

## 8.1 Indoor Unit

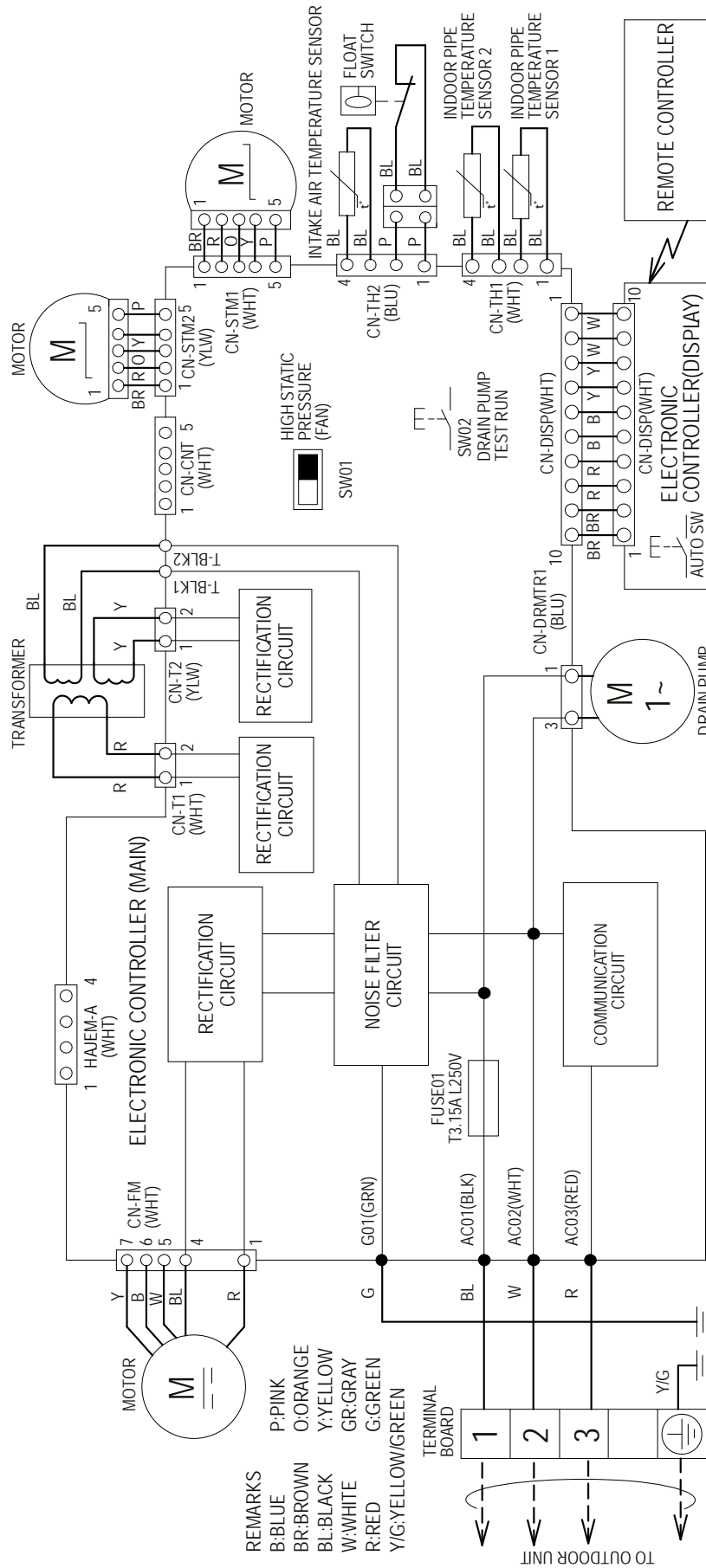

## 8.2 Outdoor Unit

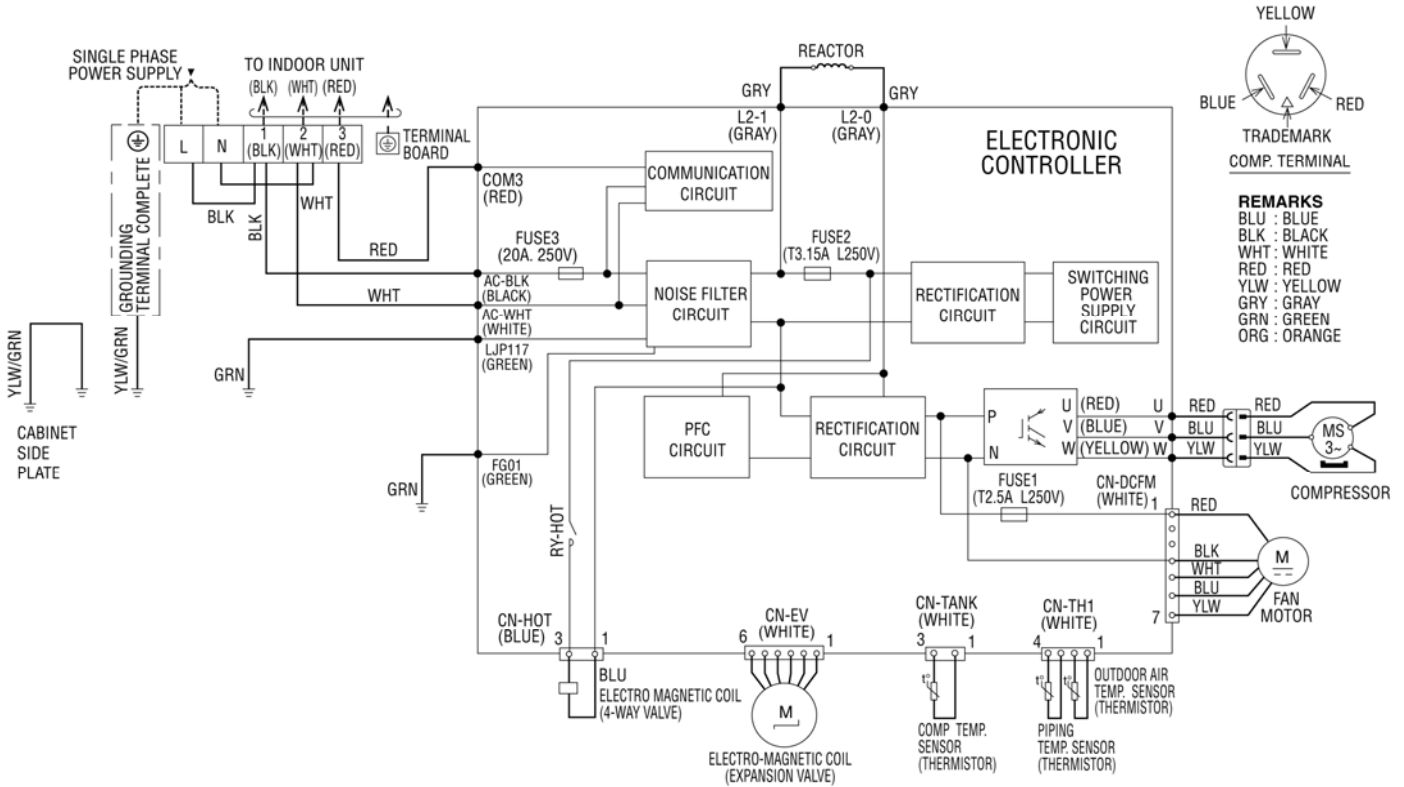

Resistance of Compressor Windings

CONNECTION	5RD132XBA21 (Ω)
U-V	1.897
U-W	1.907
V-W	1.882

Note: Resistance at 20°C of ambient temperature.

# 9. Electronic Circuit Diagram

## 9.1 Indoor Unit

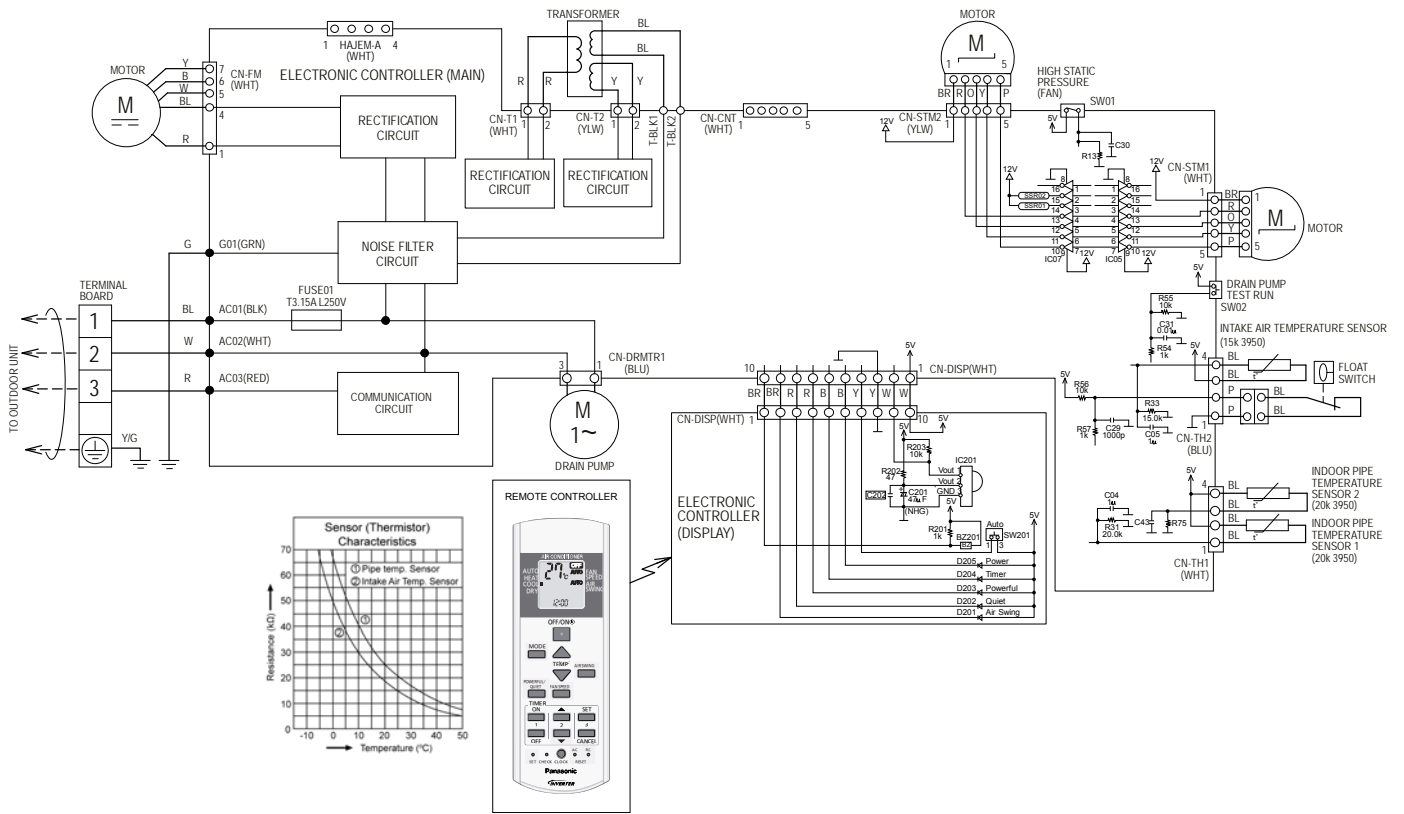

## 9.2 Outdoor Unit

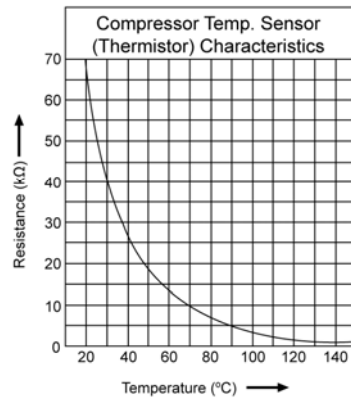
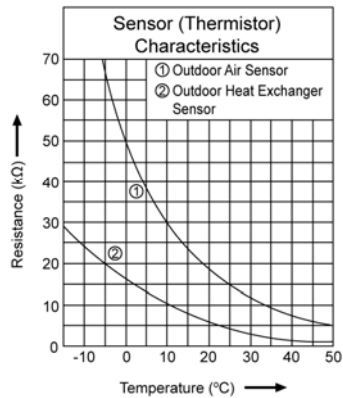
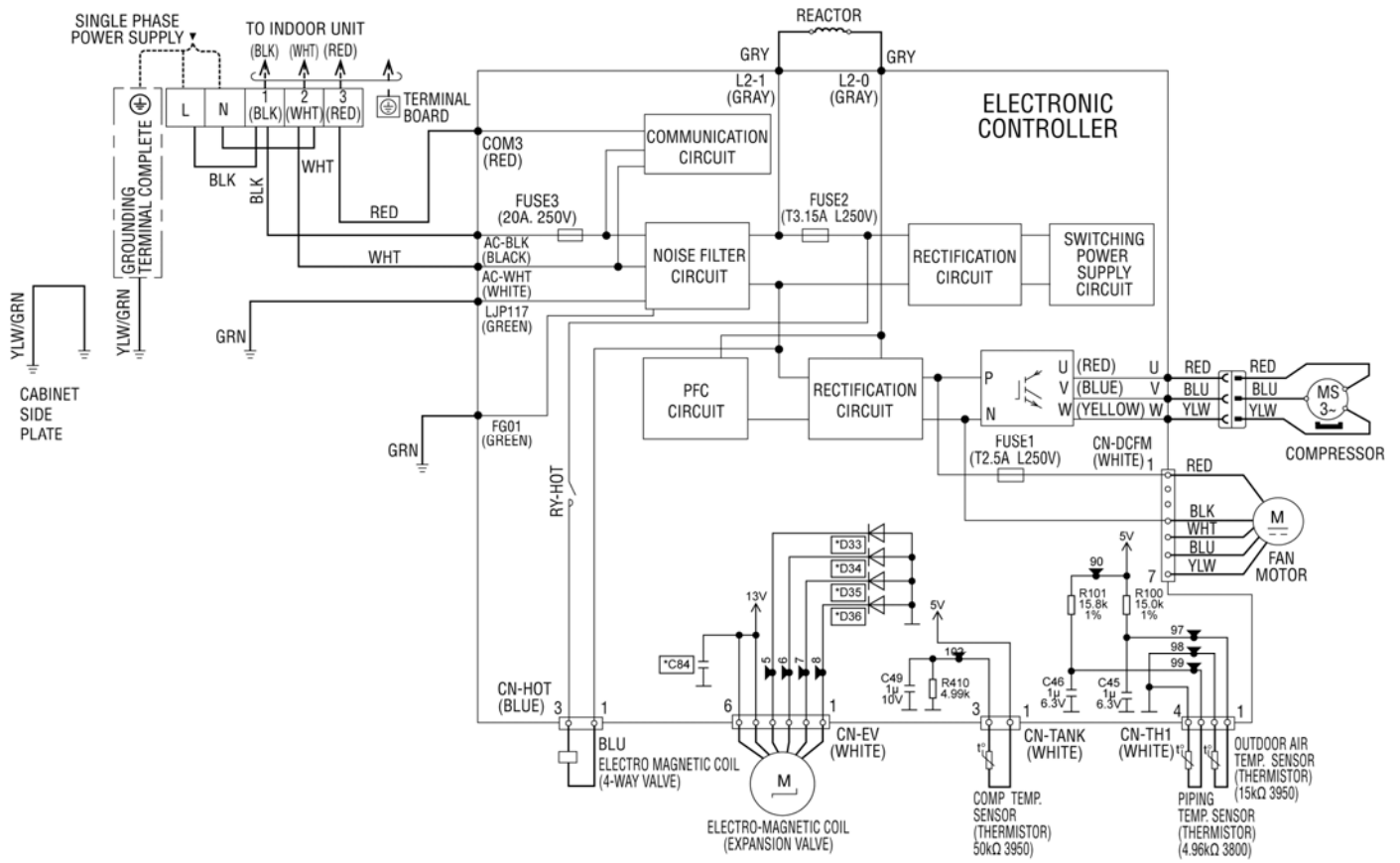



# 10. Printed Circuit Board

## 10.1 Indoor Unit

### 10.1.1 Main Printed Circuit Board

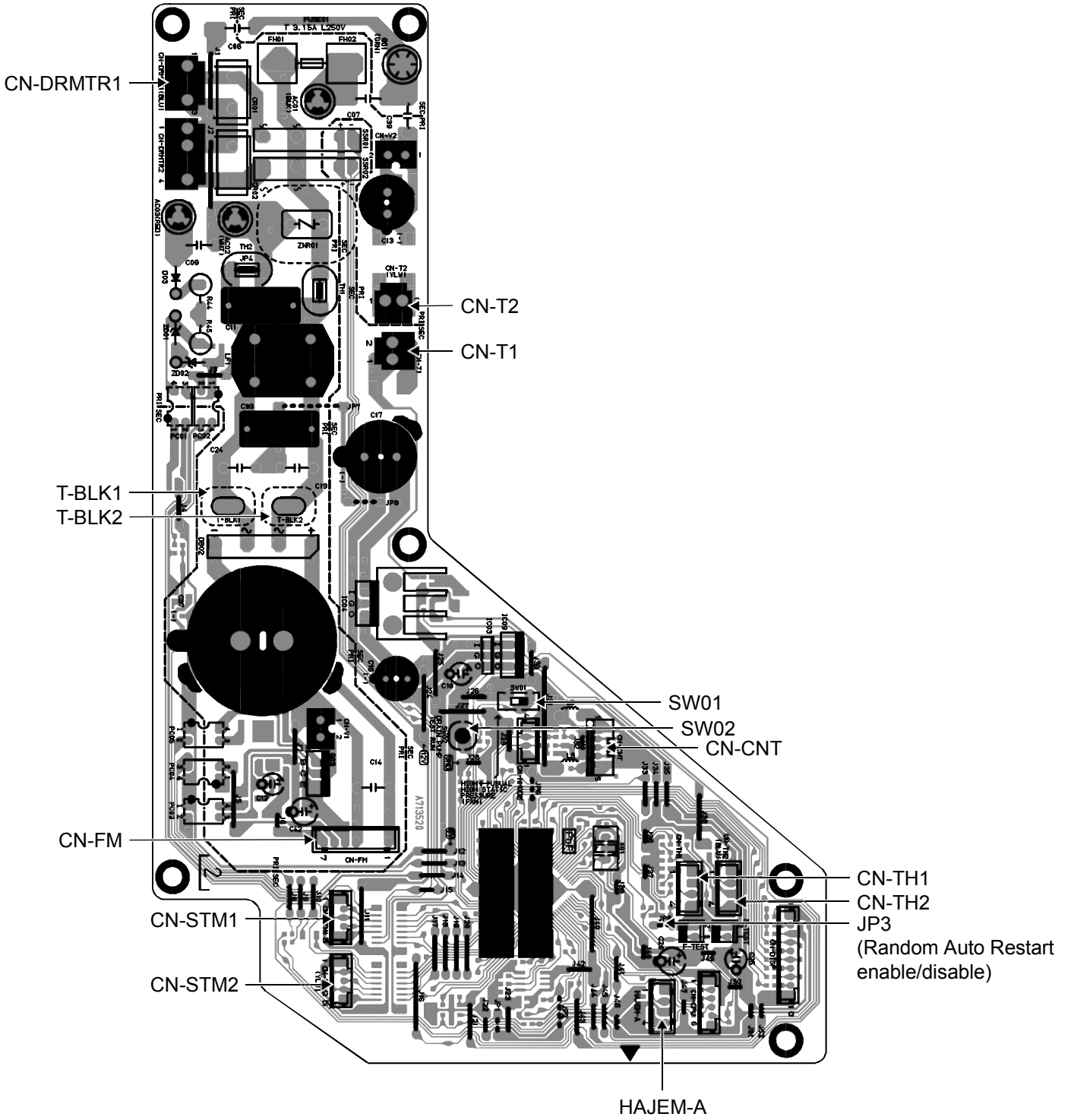

## 10.1.2 Display Printed Circuit Board

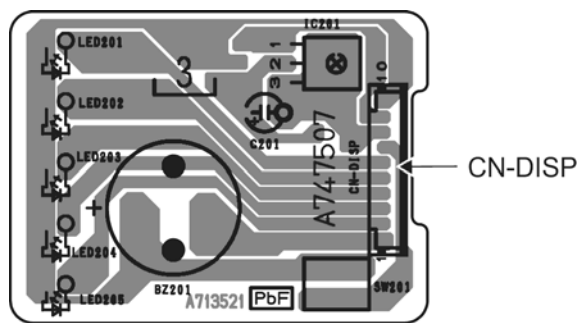

## 10.2 Outdoor Unit

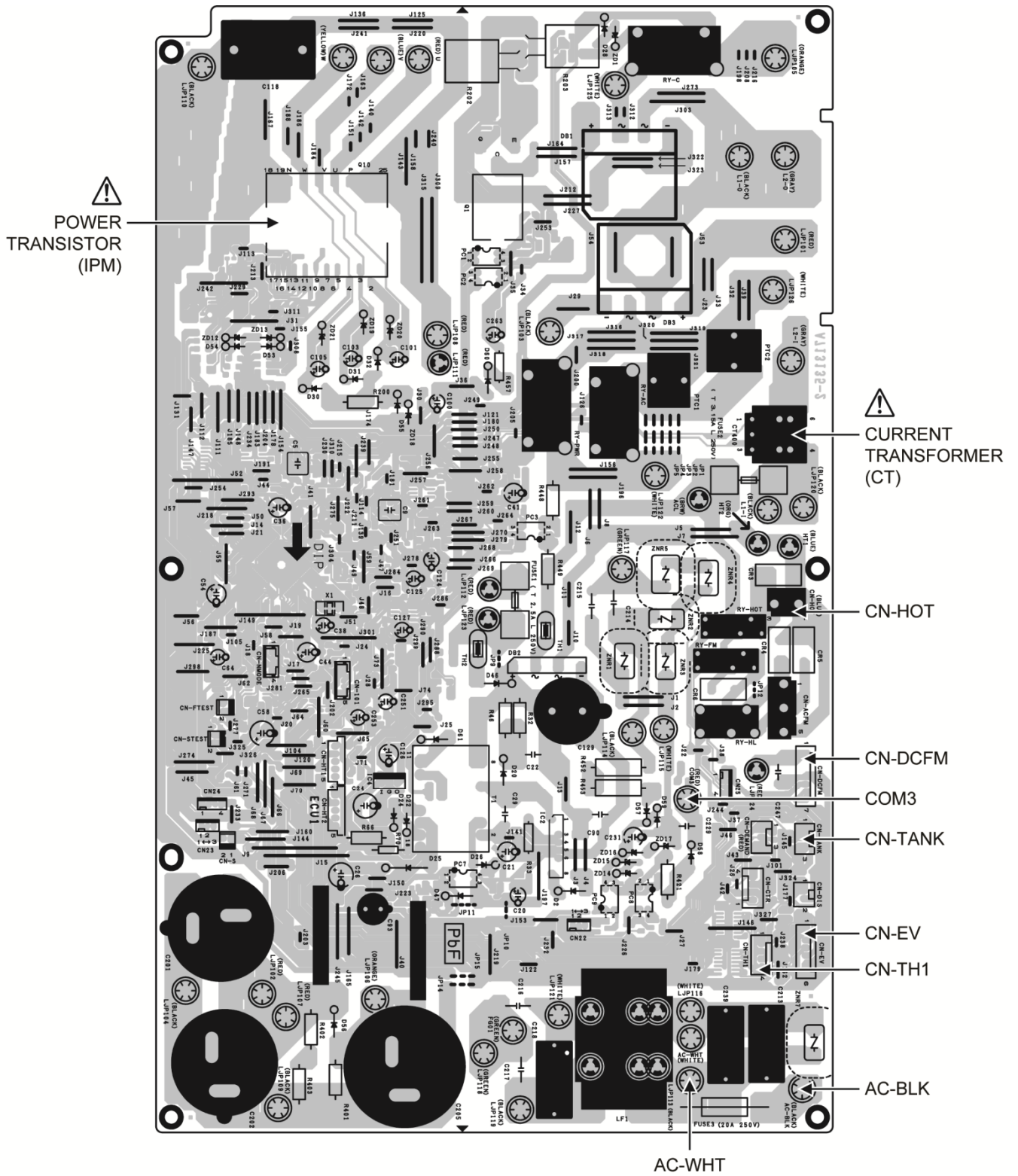

# 11. Installation Instruction

## 11.1 Indoor Unit

### 11.1.1 Selecting the Location for the Indoor Unit

Provide a check port on the piping side ceiling for repair and maintenance.

- Install the indoor unit once the following conditions are satisfied and after receiving the customer approval.
  - 1 The indoor unit must be within a maintenance space.
  - 2 The indoor unit must be free from any obstacles in path of the air inlet and outlet, and must allow spreading of air throughout the room.
  - 3 Recommended installation height for indoor unit shall be at least 2.5 m.

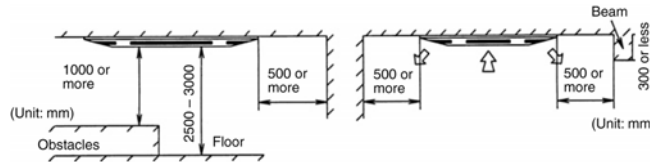

\* If the height from the floor to ceiling exceeds three meters, air flow distribution deteriorates and the effect is decreased.

#### ⚠ WARNING

- 4 The installation position must be able to support a load four times the indoor unit weight.
- 5 The indoor unit must be away from heat and steam sources, but avoid installing it near an entrance.
- 6 The indoor unit must allow easy draining.
- 7 The indoor unit must allow easy connection to the outdoor unit.
- 8 Place the indoor unit according to the height from the ceiling shown in the illustration below.
- 9 The indoor unit must be from at least 3m away from any noise-generating equipment. The electrical wiring must be shielded with a steel conduit.
- 10 If the power supply is subject to noise generation, add a suppressor.
- 11 Do not install the indoor unit in a laundry. Electric shocks may result.

**Note** • Thoroughly study the following installation locations

- 1 In such places as restaurants and kitchens, considerable amount of oil steam and flour adhere to the turbo fan, the fin of the heat exchanger and the drain pump, resulting in heat exchange reduction, spraying, dispersing of water drops, drain pump malfunction, etc.  
In these cases, take the following actions:
  - Make sure that the ventilation fan for smoke-collecting hood on a cooking table has sufficient capacity so that it draws oily steam which should not flow into the suction of the air conditioner.
  - Make enough distance from the cooking room to install the air conditioner in such place where it may not suck in oily steam.

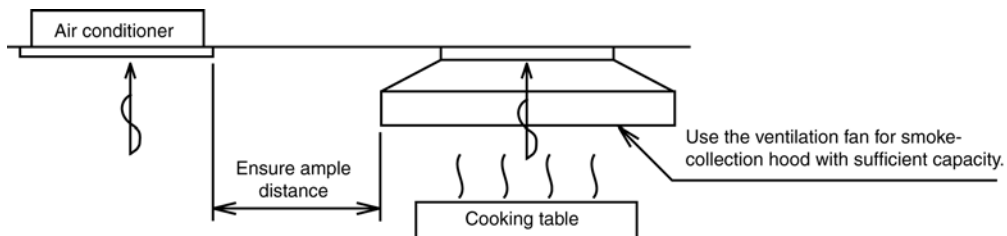

- 2 Avoid installing the air conditioner in such circumstances where cutting oil mist or iron powder exist especially in factories, etc.
- 3 Avoid places where inflammable gas is generated, flows-in, contaminated, or leaked.
- 4 Avoid places where sulphurous acid gas or corrosive gas can be generated.
- 5 Avoid places near high frequency generators.

Model Name	Height in ceiling
E18***** E21*****	280 mm or more

### 11.1.2 Installation of Indoor Unit

This air conditioner uses a drain up motor.  
Horizontally install the unit using a level gauge.

#### CEILING OPENING DIMENSIONS AND HANGING BOLT LOCATION

The paper model for installation expand or shrink according to temperature and humidity.  
Check on dimensions before using it.

**Caution** During the installation care must be taken not to damage electric wires.

- The dimensions of the paper model for installation are the same as those of the ceiling opening dimensions.
- Be sure to discuss the ceiling drilling work with the workers concerned.

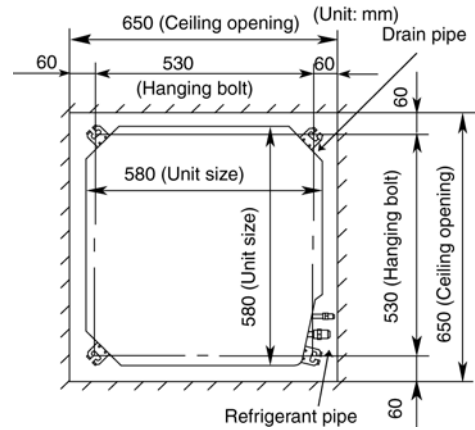

#### POSITIONS OF AIR CONDITIONER BODY AND CEILING SURFACE

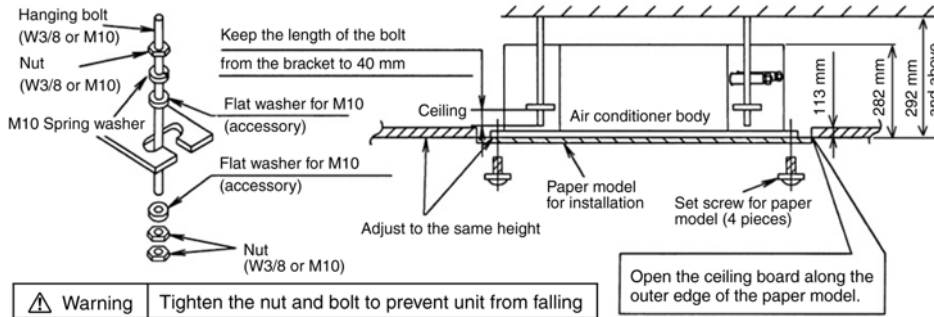

### 11.1.3 Refrigerant Piping

Refrigerant is charged to the outdoor unit. For details, see the manual for installation work of outdoor unit. (Additional charging, etc.)

- 1 Brazing for piping.
  - a. Execute brazing before tightening the flare nut.
  - b. Brazing must be executed while blowing nitrogen gas. (This prevents generation of oxidized scale in copper pipe.)
- 2 When there is a lot of brazings for long piping, install a strainer midway of the piping. (The strainer is locally supplied.)
- 3 Use clean copper pipe with inner wall surface free from mist and dust. Blow nitrogen gas or air to blow off dust in the pipe before connection.
- 4 Form the piping according to its routing. Avoid bending and bending back the same piping point more than three times. (This will result in hardening of the pipe).
- 5 After deforming the pipe, align centers of the union fitting of the indoor unit and the piping, and tighten them firmly with wrenches.
- 6 Connect pipe to the service valve or ball valve which is located below the outdoor unit.
- 7 After completed the piping connection, be sure to check if there is gas leakage in indoor and outdoor connection.

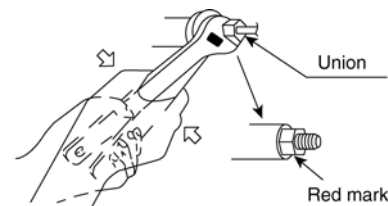

- Confirm the red mark of the union (thin side) is always at lower direction after connecting piping.

## Vacuum drying

After completing the piping connection, execute vacuum drying for the connecting piping and the indoor unit. The vacuum drying must be carried out by using the service ports of both the liquid and gas side valves.

**CAUTION** Use two wrenches and tighten with regular torque.

Do not overtighten, overtightening may cause gas leakage.

Piping size	Torque
6.35 mm (1/4")	[18 N•m (1.8 kgf•m)]
9.52 mm (3/8")	[42 N•m (4.3 kgf•m)]
12.7 mm (1/2")	[55 N•m (5.6 kgf•m)]
15.88 mm (5/8")	[65 N•m (6.6 kgf•m)]
19.05 mm (3/4")	[100 N•m (10.2 kgf•m)]

### 11.1.4 Indoor Unit Drain Piping

- During drain piping connection, be careful not to exert extra force on the drain port at the indoor unit. The outside diameter of the drain connection at the indoor unit is 32 mm.

Piping material: Polyvinyl chloride pipe VP-25 and pipe fittings.

- Be sure to perform heat insulation on the drain piping.

Heat insulation material: Polyethylene foam with thickness more than 8 mm (local supply).

- Drain piping must have down-slope (1/50 to 1/100); be sure not to provide up-and-down slope to prevent reversal flow.
- Be sure to check no air trap on drain hose and to ensure smooth water flow and no abnormal sound.

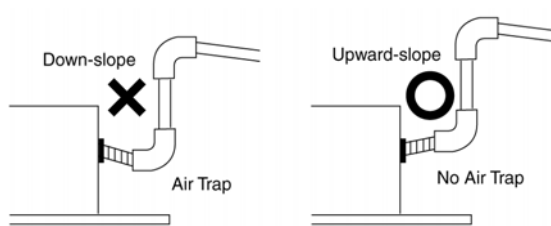
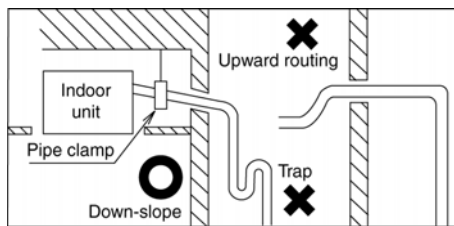

- The height of drain may be possible up to 750 mm.

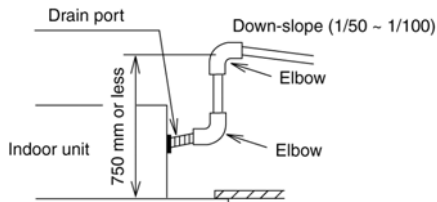

- When drain set piping, install as shown in the figure below.

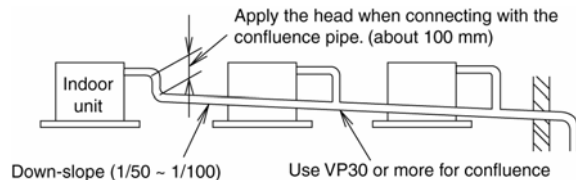

## Drain Test

The air conditioner uses a drain up motor to drain water. Use the following procedure to test the drain up motor operation.

- Connect the main drain pipe to exterior and leave it provisionally until the test comes to an end.
- Feed water to the flexible drain hose and check the piping for leakage.
- Be sure to check the drain up motor for normal operating and noise when electric wiring is complete.
- When the test is complete, connect the flexible drain hose to the drain port.
- Pour about 600-700cc of water in the drain pan of the indoor unit. (Pour from the position specified in the drawing by using a water supply bottle or other suitable tool.)
- Press the drain pump test run on pcb to start the drain motor, and verify water drainage. (The drain motor will automatically stop after operating for about five minutes.)

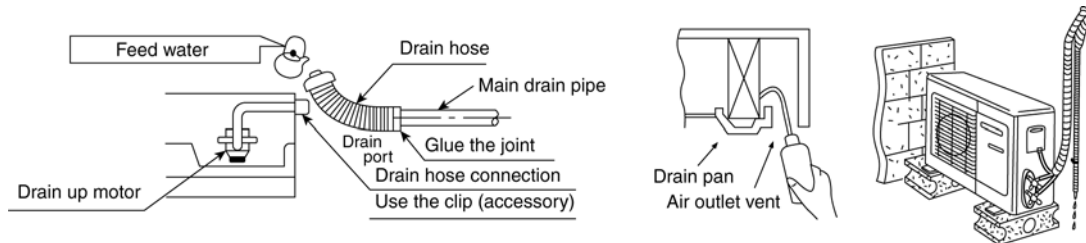

## 11.1.5 Heat Insulation



### CAUTION

Be sure to perform heat insulation on the drain, liquid and gas piping. Imperfection in heat insulation work leads to water leakage.

- 1 Use the heat insulation material for the refrigerant piping which has an excellent heat-resistance (over 120°C).

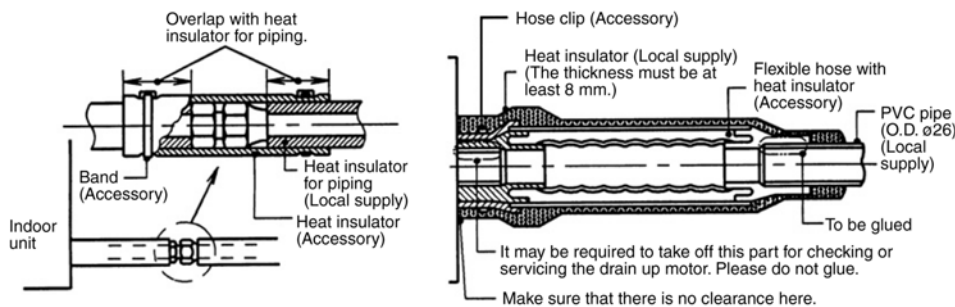

- 2 Precautions in high humidity circumstance.

This air conditioner has been tested according to the "JIS Standard Conditions with Mist" and have been confirmed that there are no faults. However, if it is operated for a long time in high humid atmosphere (dew point temperature: more than 23°C), water drops are liable to fall. In this case, add heat insulation material according to the following procedure:

- Heat insulation material to be prepared... Adiabatic glass wool with thickness 10 to 20 mm.
- Stick glass wool on all air conditioners that are located in ceiling atmosphere.
- In addition to the normal heat insulation (thickness: more than 8 mm) for refrigerant piping (gas piping: thick piping) and drain piping, add a further of 10 mm to 30 mm thickness material.

## Wall seal

- When the outdoor unit is installed on a higher position than the indoor unit, install the trap so as not to instill rain water into the wall by transmitting in piping.
- Stuff the space among piping, the electric wire, and- the drain hose with "Putty" and seal the penetration wall hole. Make sure that rain water do not instill into the wall.

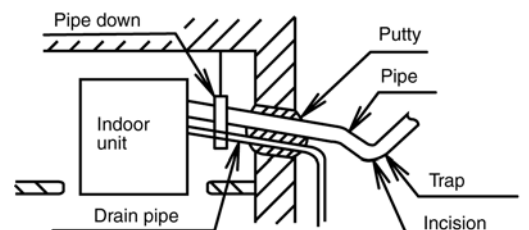

\* Put the incision at the trap part of the heat insulator (for water drain)

### 11.1.6 Connecting the Cable to the Indoor

- Remove the mounting screw, remove the control box cover, and then connect the wires by following the procedure given in the illustration.
- Connection cable between indoor unit and outdoor unit shall be approved polychloroprene sheathed  $4 \times 1.5 \text{ mm}^2$  flexible cord, type designation 60245 IEC 57 or heavier cord. Allowable connection cable length of each indoor unit shall be 30 m or less.
- Secure the connection cable onto the control board with the holder (clammer).
- Ensure the colour of wires of outdoor unit and the terminal Nos. are the same to the indoor's respectively.
- Earth wire shall be Yellow/Green (Y/G) in colour and longer than other AC wires for safety reason.

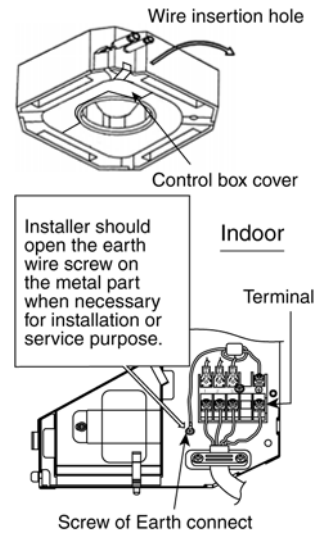

Terminals on the indoor unit	1	2	3	
Colour of wires				
Terminals on the outdoor unit	1	2	3	

**⚠ WARNING**

This equipment must be properly earthed.

#### 11.1.6.1 Wire Stripping and Connection Requirement

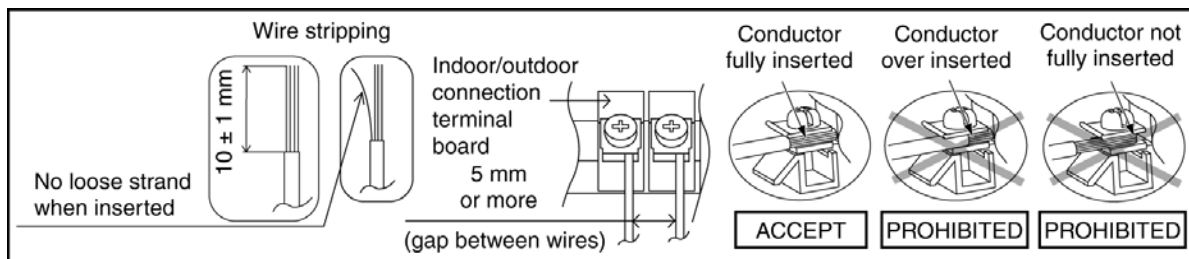

**⚠ WARNING**

**RISK OF FIRE**  
JOINING OF WIRES MAY CAUSE OVERHEATING AND FIRE.

Do not joint wires

- Use complete wire without joining.
- Use approved socket and plug with earth pin.
- Wire connection in this area must follow to national wiring rules.



### 11.1.7 Installation of Decorative Panel

The decorative panel has its installation direction. Confirm the direction by displaying the piping side.

- 1 Remove the air inlet grille by moving the catchers to center.

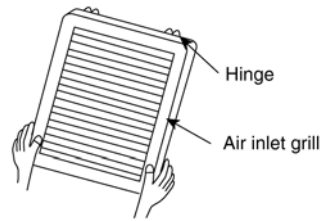
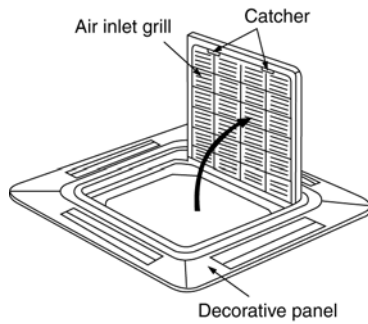

- \* Hang the hinge on the hole of decorative panel. (The direction of the installation is free.)

- 2 Fitting the decorative panel
  - o Temporarily secure the fixing screws (3 pcs.) before fitting the decorative panel. (For temporarily securing the front grille.)
  - o Place decorative panel on the screws (3 pcs.) before fitting, move decorative panel as illustrated and tighten all the screws (4 pcs.).

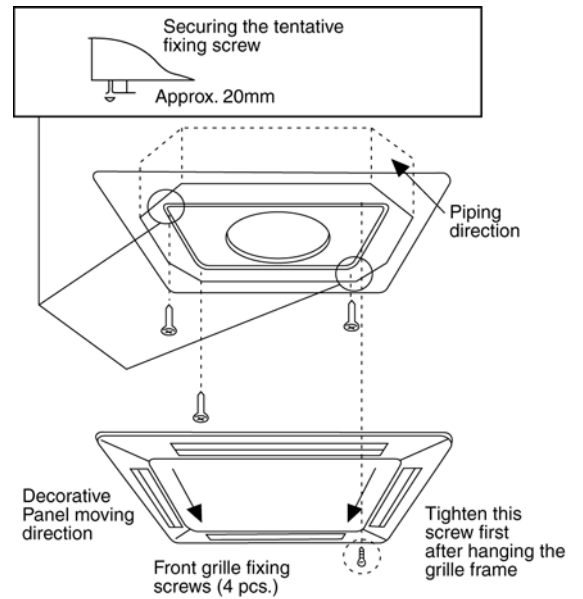

#### ⚠ CAUTION

- Check before hand the height from the ceiling to the unit.
- The front grille fitting direction is determined by the unit direction.
- Only use the screws with the length of 35mm which is provided, to fix the decorative panel.
- Do not use other screw which is longer it may cause damage to the drain-pan and other components.

- 3 Fit the decorative panel and ceiling wall together and confirm no gap in between. Readjust indoor unit height, if there is a gap between ceiling wall and decorative panel.

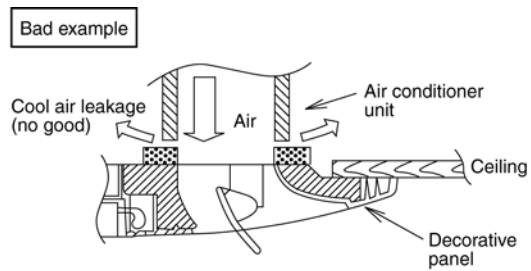
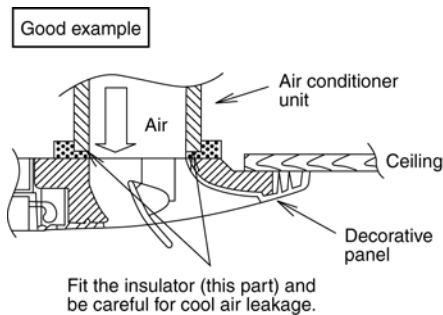

- 4 Open the indoor control box cover. (2 pcs)
- 5 Insert firmly the connector of cosmetic louver to indoor pcb CN-STM1, CN-STM2 and CN-DISP.  
Be caution not to clamp the cord in between control board and control board cover.
- 6 After complete, install back removed part follow opposite procedure.

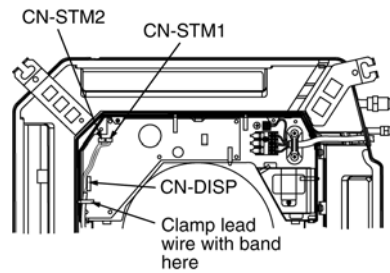

	<p><b>WARNING</b> Be sure to hook the air inlet grill string, to prevent grill from falling and causing injury from it.</p>
--	---

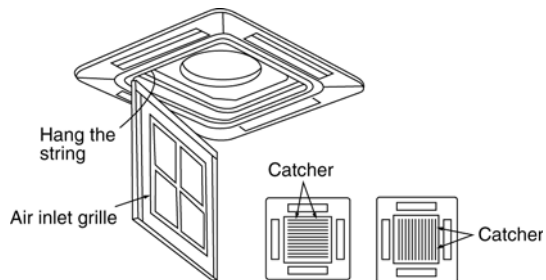

## 11.2 Outdoor Unit

### 11.2.1 Select the Best Location

- If an awning is built over the unit to prevent direct sunlight or rain, be careful that heat radiation from the condenser is not obstructed.
- There should not be any animal or plant which could be affected by hot air discharged.
- Keep the spaces indicated by arrows from wall, ceiling, fence or other obstacles.
- Do not place any obstacles which may cause a short circuit of the discharged air.
- If piping length is over the [piping length for additional gas], additional refrigerant should be added as shown in the table.

Model	Horse Power (HP)	Piping size		Std. Length (m)	Max. Elevation (m)	Min. Piping Length (m)	Max. Piping Length (m)	Additional Refrigerant (g/m)	Piping Length for add gas (m)
		Gas	Liquid						
E18****	2.0HP	12.7mm (1/2")	6.35mm (1/4")	5	20	3	30	20	10
E21****	2.25HP								

Example: For E18\*\*\*\*

If the unit is installed at 12 m distance, the quantity of additional refrigerant should be 40 g .... (12-10) m × 20 g/m = 40 g.

### 11.2.1.1 Indoor/Outdoor Installation Diagram

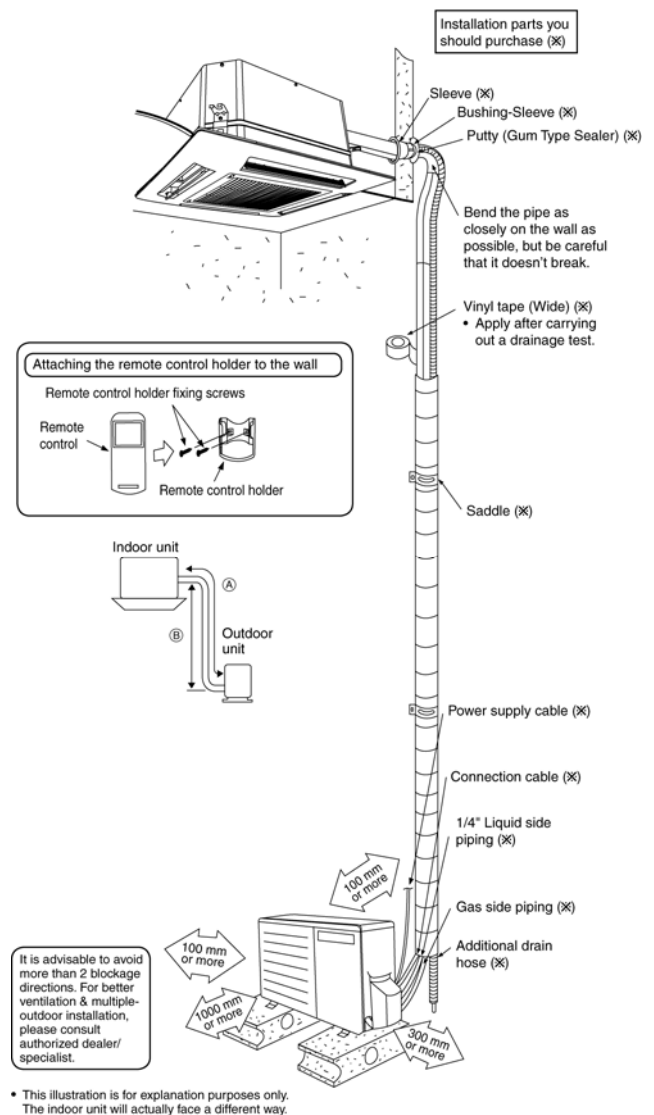

### 11.2.2 Install the Outdoor Unit

- After selecting the best location, start installation to Indoor/Outdoor Unit Installation Diagram.
  - 1 Fix the unit on concrete or rigid frame firmly and horizontally by bolt nut (ø10 mm).
  - 2 When installing at roof, please consider strong wind and earthquake. Please fasten the installation stand firmly with bolt or nails.

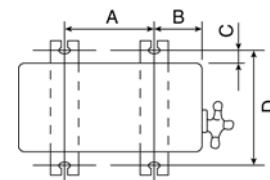

Model	A	B	C	D
E18****	613 mm	131 mm	16 mm	360.5 mm
E21****				

## 11.2.3 Connect the Piping

### 11.2.3.1 Connecting the Piping to Indoor Unit

Please make flare after inserting flare nut (locate at joint portion of tube assembly) onto the copper pipe. (In case of using long piping)

Connect the piping

- Align the center of piping and sufficiently tighten the flare nut with fingers.
- Further tighten the flare nut with torque wrench in specified torque as stated in the table.

Do not overtighten, overtightening may cause gas leakage.	
Piping size	Torque
6.35 mm (1/4")	[18 N•m (1.8 kgf•m)]
9.52 mm (3/8")	[42 N•m (4.3 kgf•m)]
12.7 mm (1/2")	[55 N•m (5.6 kgf•m)]
15.88 mm (5/8")	[65 N•m (6.6 kgf•m)]
19.05 mm (3/4")	[100 N•m (10.2 kgf•m)]

### 11.2.3.2 Connecting the Piping to Outdoor Unit

Decide piping length and then cut by using pipe cutter. Remove burrs from cut edge. Make flare after inserting the flare nut (locate at valve) onto the copper pipe. Align center of piping to valve and then tighten with torque wrench to the specified torque as stated in the table.

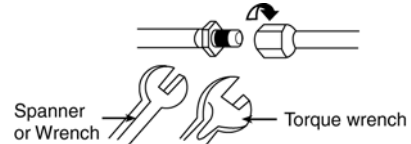

### 11.2.3.3 Connecting the Piping to Outdoor Multi

Decide piping length and then cut by using pipe cutter. Remove burrs from cut edge. Make flare after inserting the flare nut (locate at valve) onto the copper pipe. Align center of piping to valve and then tighten with torque wrench to the specified torque as stated in the table.

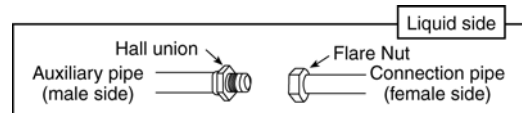

\* For Gas side piping please refer table and diagram below

Outdoor Multi combination model		Pipe size (refer to diagram)	Gas side
CS-E18***	CU-3E18***, CU-4E23***, CU-4E27***, CU-5E34***	① (CZ-MA1P)	
CS-E21***	CU-4E23***, CU-4E27***, CU-5E34***	② (CZ-MA2P)	

\* Kindly consult authorised dealer for connectivity validity.

## 11.2.4 Evacuation of the Equipment

WHEN INSTALLING AN AIR CONDITIONER, BE SURE TO EVACUATE THE AIR INSIDE THE INDOOR UNIT AND PIPES in the following procedure.

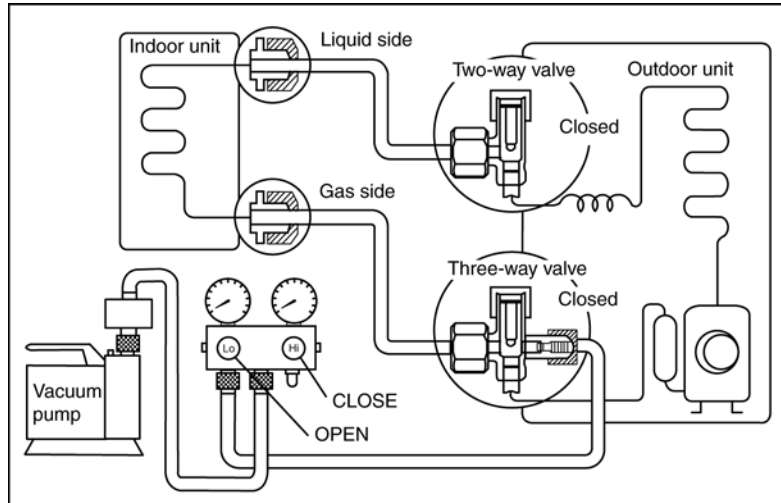

- 1 Connect a charging hose with a push pin to the Low side of a charging set and the service port of the 3-way valve.
  - Be sure to connect the end of the charging hose with the push pin to the service port.
- 2 Connect the center hose of the charging set to a vacuum pump.
- 3 Turn on the power switch of the vacuum pump and make sure that the needle in the gauge moves from 0 cmHg (0 MPa) to -76 cmHg (-0.1 MPa). Then evacuate the air approximately ten minutes.
- 4 Close the Low side valve of the charging set and turn off the vacuum pump. Make sure that the needle in the gauge does not move after approximately five minutes.
 

Note : BE SURE TO TAKE THIS PROCEDURE IN ORDER TO AVOID REFRIGERANT GAS LEAKAGE.
- 5 Disconnect the charging hose from the vacuum pump and from the service port of the 3-way valve.
- 6 Tighten the service port caps of the 3-way valve at a torque of 18 N•m with a torque wrench.
- 7 Remove the valve caps of both of the 2-way valve and 3-way valve. Position both of the valves to "OPEN" using a hexagonal wrench (4 mm).
- 8 Mount valve caps onto the 2-way valve and the 3-way valve.
  - Be sure to check for gas leakage.

- If gauge needle does not move from 0 cmHg (0 MPa) to -76 cmHg (-0.1 MPa), in the step ③ above take the following measure:
  - If the leak stops when the piping connections are tightened further, continue working from step ③.
  - If the leak does not stop when the connections are retightened, repair location of leak.
  - Do not release refrigerant during piping work for installation and reinstallation.
  - Take care of the liquid refrigerant, it may cause frostbite.

## 11.2.5 Connect the Cable to the Outdoor Unit

(FOR DETAIL REFER TO WIRING DIAGRAM AT UNIT)

- 1 Remove the control board cover from the unit by loosening the screw.
- 2 Cable connection to the power supply through Isolating Devices (Disconnecting means).
  - Connect approved type polychloroprene sheathed **power supply cord** 3 × 2.5 mm<sup>2</sup> type designation 60245 IEC 57 or heavier cord to the terminal board, and connect the others end of the cord to Isolating Devices (Disconnecting means).
- 3 **Connection cable** between indoor unit and outdoor unit shall be approved polychloroprene sheathed 4 × 1.5 mm<sup>2</sup> flexible cord, type designation 60245 IEC 57 or heavier cord. Allowable connection cable

length of each indoor unit shall be 30 m or less.

- 4 Connect the power supply cord and connection cable between indoor unit and outdoor unit according to the diagram below.

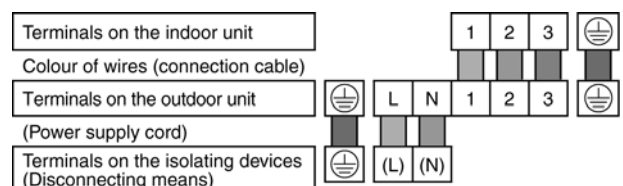

- 5 Secure the power supply cord and connection cable onto the control board with the holder.
- 6 Attach the control board cover back to the original position with screw.
- 7 For wire stripping and connection requirement, refer to instruction 10.1.6 of indoor unit.

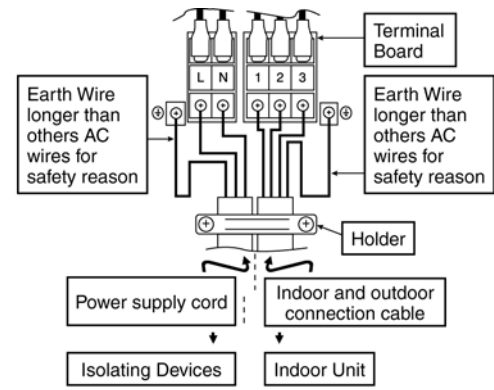

**⚠ WARNING**

⚡ This equipment must be properly earthed.

- Note: Isolating Devices (Disconnecting means) should have minimum 3.0 mm contact gap.
- Earth wire shall be Yellow/Green (Y/G) in colour and longer than other AC wires for safety reason.

## 11.2.6 Pipe Insulation

- 1 Please carry out insulation at pipe connection portion as mentioned in Indoor/Outdoor Unit Installation Diagram. Please wrap the insulated piping end to prevent water from going inside the piping.
- 2 If drain hose or connecting piping is in the room (where dew may form), please increase the insulation by using POLY-E FOAM with thickness 6 mm or above.

### 11.2.6.1 Cutting and Flaring the Piping

- 1 Please cut using pipe cutter and then remove the burrs.
- 2 Remove the burrs by using reamer. If burrs is not removed, gas leakage may be caused. Turn the piping end down to avoid the metal powder entering the pipe.
- 3 Please make flare after inserting the flare nut onto the copper pipes.

1. To cut

2. To remove burrs

3. To flare

Copper pipe

■ Improper flaring ■

Inclined Surface damaged, Cracked, Uneven thickness

When properly flared, the internal surface of the flare will evenly shine and be of even thickness. Since the flare part comes into contact with the connections, carefully check the flare finish.

## 11.2.7 Disposal of Outdoor Unit Drain Water

- If a drain elbow is used, the unit should be placed on a stand which is taller than 3 cm.
- If the unit is used in an area where temperature falls below 0°C for 2 or 3 days in succession, it is recommended not to use a drain elbow, for the drain water freezes and the fan will not rotate.

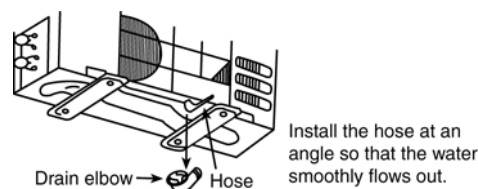

### 11.2.8 Auto Switch Operation

The following operations can be performed by pressing the "AUTO" switch.

- 1 AUTO OPERATION MODE  
The Auto operation will be activated immediately once the Auto Switch is pressed.
- 2 TEST RUN OPERATION (FOR PUMP DOWN/SERVICING PURPOSE)  
The Test Run operation will be activated if the Auto Switch is pressed continuously for more than 5 sec. to below 8 sec. A "pep" sound will occur at the fifth sec., in order to identify the starting of Test Run operation.

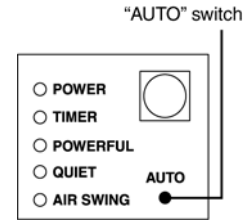

### 11.2.9 Changing the Remote Control Transmission Code

- 1 Press AUTO SW continuously for more than 11 sec to below 16 sec, A "pep", "pep", "pep" sound will occur at the eleventh sec.
- 2 Press the "A/C RESET" button once remote control signal will activate the remote control transmission code setting mode.
- 3 Press "OFF/ON" button. The new Remo-Con No. will be accepted and memorized, after which the new Remo-Con No. can be used.

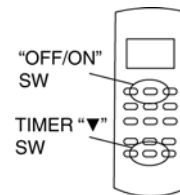

#### Remo-Con No. Change in Remote Control

- 1 Remove the batteries from the battery compartment of the Remote Control.
- 2 On the left side of the battery compartment, there is a small opening in the centre in which Jumper (J\_A) can be seen. In the accepted Remo-Con PCB shown beside, Jumper (J\_B) can be seen.

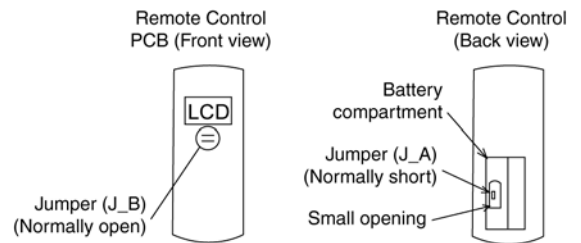

J_A	J_B	Remo-Con No.
Short	Open	A(Default)
Open	Open	B
Short	Short	C
Open	Short	D

## 12. Operation Control

### 12.1 Basic Function

Inverter control, which equipped with a microcomputer in determining the most suitable operating mode as time passes, automatically adjusts output power for maximum comfort always. In order to achieve the suitable operating mode, the microcomputer maintains the set temperature by measuring the temperature of the environment and performing temperature shifting. The compressor at outdoor unit is operating following the frequency instructed by the microcomputer at indoor unit that judging the condition according to internal setting temperature and intake air temperature.

#### 12.1.1 Internal Setting Temperature

Once the operation starts, remote control setting temperature will be taken as base value for temperature shifting processes. These shifting processes are depending on the air conditioner settings and the operation environment. The final shifted value will be used as internal setting temperature and it is updated continuously whenever the electrical power is supplied to the unit.

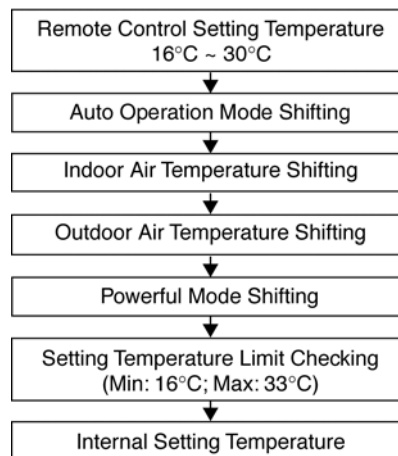

#### 12.1.2 Cooling Operation

##### 12.1.2.1 Thermostat control

- Compressor is OFF when Intake Air Temperature - Internal Setting Temperature < -1.5°C continue for 3 minutes.
- When compressor is OFF (Thermostat OFF) and AUTO FAN is set, the fan will stop periodically.
- Compressor is ON after waiting for 3 minutes, if the Intake Air Temperature - Internal Setting Temperature > Compressor OFF point.

#### 12.1.3 Soft Dry Operation

##### 12.1.3.1 Thermostat control

- Compressor is OFF when Intake Air Temperature - Internal Setting Temperature < -1.0°C continue for 3 minutes.
- When compressor is OFF (Thermostat OFF) and AUTO FAN is set, the fan will stop periodically.
- Compressor is ON after waiting for 3 minutes, if the Intake Air Temperature - Internal Setting Temperature > Compressor OFF point.

#### 12.1.4 Heating Operation

##### 12.1.4.1 Thermostat control

- Compressor is OFF when Intake Air Temperature - Internal Setting Temperature > +2.0°C continue for 3 minutes.
- Compressor is ON after waiting for 3 minutes, if the Intake Air Temperature - Internal Setting Temperature < Compressor OFF point.



### 12.1.5 Automatic Operation

- This mode can be set using remote control and the operation is decided by remote control setting temperature, remote control operation mode and indoor intake air temperature.
- During operation mode judgment, indoor fan motor (with speed of Lo-) is running for 30 seconds to detect the indoor intake air temperature.
- Every 10 minutes, the indoor temperature is judged.
- For the 1st judgment
  - If indoor intake temperature - remote control setting temperature  $\geq 2^{\circ}\text{C}$ , COOL mode is decided.
  - If  $-2^{\circ}\text{C} \leq$  indoor intake temperature - remote control setting temperature  $< 2^{\circ}\text{C}$ , DRY mode is decided.
  - If indoor intake temperature - remote control setting temperature  $< -2^{\circ}\text{C}$ , HEAT mode is decided.

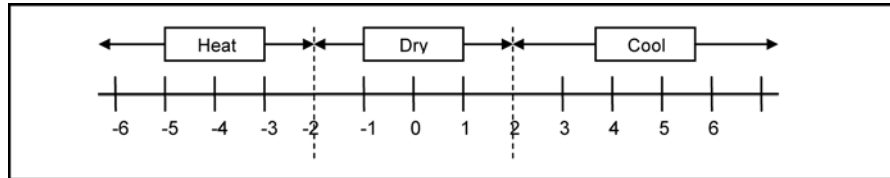

- For the 2nd judgment onwards
  - If indoor intake temperature - remote control setting temperature  $\geq 4^{\circ}\text{C}$ , if previous operate in DRY mode, then continue in DRY mode. otherwise COOL mode is decided.
  - If  $-2.5^{\circ}\text{C} \leq$  indoor intake temperature - remote control setting temperature  $< 4^{\circ}\text{C}$ , maintain with previous mode.
  - If indoor intake temperature - remote control setting temperature  $< -2.5^{\circ}\text{C}$ , HEAT mode is decided.

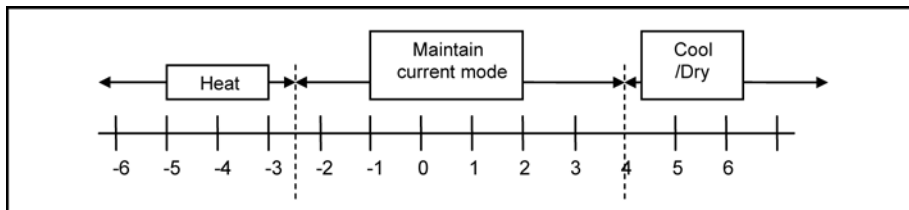

## 12.2 Indoor Fan Motor Operation

### 12.2.1 Basic Rotation Speed (rpm)

#### A. Basic Rotation Speed (rpm)

##### i. Manual Fan Speed

[Cooling, Dry]

- Fan motor's number of rotation is determined according to remote control setting.

Remote control	○	○	○	○	○
Tab	Hi	Me+	Me	Me-	Lo

[Heating]

- Fan motor's number of rotation is determined according to remote control setting.

Remote control	○	○	○	○	○
Tab	SHi	Me+	Me	Me-	Lo

##### ii Auto Fan Speed

[Cooling, Dry]

- According to room temperature and setting temperature, indoor fan speed is determined automatically.
- When set temperature is not achieved, the indoor fan will operate according to pattern below.

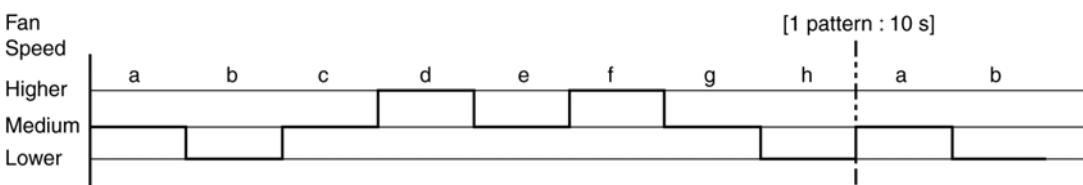

- When set temperature achieved, the indoor fan speed will be fixed. When thermostat off, the fan stop periodically.

[Heating]

- According to indoor pipe temperature, automatic heating fan speed is determined as follows.

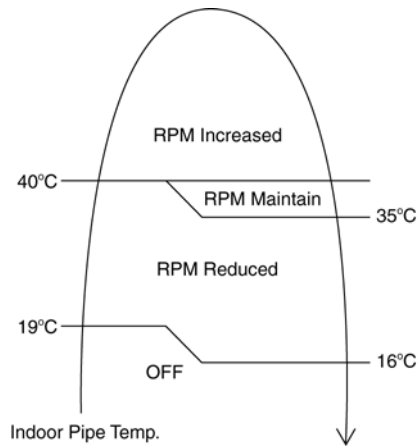

**B. Feedback control**

- Immediately after the fan motor started, feedback control is performed once every second.
- During fan motor on, if fan motor feedback  $\geq 2550$  rpm or  $< 50$  rpm continue for 10 seconds, then fan motor error counter increase, fan motor is then stop and restart. If the fan motor counter becomes 7 times, then H19 - fan motor error is detected. Operation stops and cannot on back.

**12.3 Outdoor Fan Motor Operation**

- It starts when compressor starts operation and it stops 30 seconds after compressor stops operation.

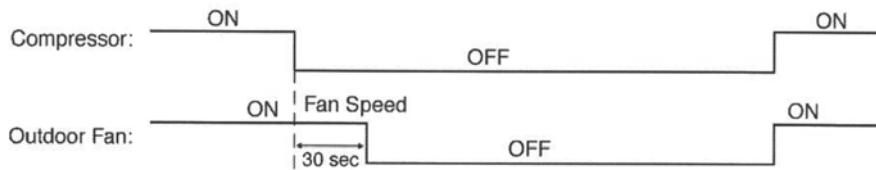

- During cooling operation, and outdoor ambient temperature is below 8°C, outdoor fan speed will be controlled according to outdoor piping temperature as following:

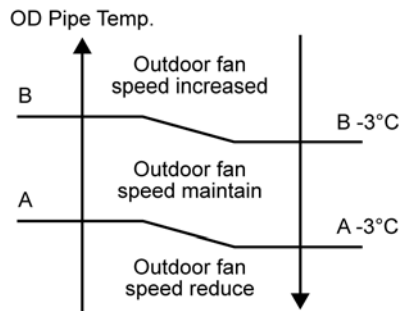

	OD Pipe Temperature
A	26°C
B	33°C

- During above condition, when indoor heat exchanger temperature is below 5°C, the outdoor fan will stop according to outdoor piping temperature as following:

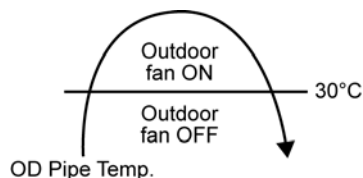

## 12.4 Airflow Direction

1. There is one type of airflow, vertical airflow (directed by horizontal vane).
2. Control of airflow direction can be automatic (angles of direction is determined by operation mode, heat exchanger temperature and intake air temperature) and manual (angles of direction can be adjusted using remote control).

### 12.4.1 Vertical Airflow

Operation Mode	Airflow Direction		Upper Vane Angle (°)						
			1	2	3	4	5		
Heating	Auto with Heat Exchanger	A	Upward fix		20				
		B	Downward fix		58				
		C	Upward fix		20				
	Manual		20	33	45	58	70		
Cooling	Auto		20 ~ 70						
	Manual		20	33	45	58	70		
Soft Dry	Auto		20 ~ 70						
	Manual		20	33	45	58	70		

1. Automatic vertical airflow direction can be set using remote control; the vane swings up and down within the angles as stated above. For heating mode operation, the angle of the vane depends on the indoor heat exchanger temperature as Figure 1 below. When the air conditioner is stopped using remote control, the vane will shift to close position.
2. Manual vertical airflow direction can be set using remote control; the angles of the vane are as stated above and the positions of the vane are as Figure 2 below. When the air conditioner is stopped using remote control, the vane will shift to close position.

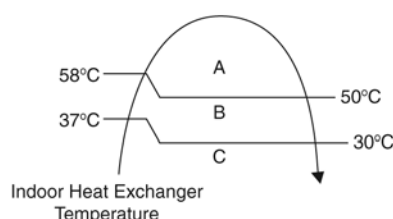

Figure 1

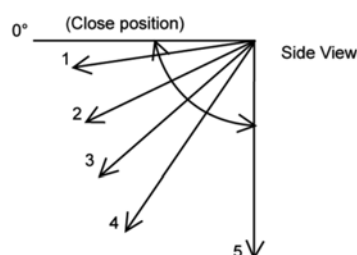

Figure 2

## 12.5 Quiet Operation (Cooling Mode/Cooling Area of Dry Mode)

- Purpose
  - To provide quiet cooling operation compare to normal operation.
- Control condition
  - Quiet operation start condition
    - When "POWERFUL/QUIET" button at remote control is pressed twice. POWERFUL/QUIET LED illuminates.
  - Quiet operation stop condition
    - When one of the following conditions is satisfied, quiet operation stops:
      - POWERFUL/QUIET button is pressed again.
      - Stop by OFF/ON switch.
      - Timer "off" activates.
    - When quiet operation is stopped, operation is shifted to normal operation with previous setting.
    - When fan speed is changed, quiet operation is shifted to quiet operation of the new fan speed.
    - When operation mode is changed, quiet operation is shifted to quiet operation of the new mode.
    - During quiet operation, if timer "on" activates, quiet operation maintains.
    - After off, when on back, quiet operation is not memorised.
- Control contents
  - Fan speed is changed from normal setting to quiet setting of respective fan speed. Fan speed for quiet operation is reduced from setting fan speed.

## 12.6 Quiet Operation (Heating)

- Purpose
  - To provide quiet heating operation compare to normal operation.
- Control condition
  - Quiet operation start condition
    - When “POWERFUL/QUIET” button at remote control is pressed. POWERFUL/QUIET LED illuminates.
  - Quiet operation stop condition
    - When one of the following conditions is satisfied, quiet operation stops:
      - POWERFUL/QUIET button is pressed again.
      - Stop by OFF/ON switch.
      - Timer “off” activates.
    - When quiet operation is stopped, operation is shifted to normal operation with previous setting.
    - When fan speed is changed, quiet operation is shifted to quiet operation of the new fan speed.
    - When operation mode is changed, quiet operation is shifted to quiet operation of the new mode, except fan mode only.
    - During quiet operation, if timer “on” activates, quiet operation maintains.
    - After off, when on back, quiet operation is not memorised.
- Control contents
  - Fan speed manual
    - Fan speed is changed from normal setting to quiet setting of respective fan speed.
    - Fan speed for quiet operation is reduced from setting fan speed.
  - Fan Speed Auto
    - Indoor FM RPM depends on pipe temp sensor of indoor heat exchanger.

## 12.7 Powerful Mode Operation

- When the powerful mode is selected, the internal setting temperature will shift lower up to 2°C (for Cooling/Soft Dry) or higher up to 3.5°C (for Heating) than remote control setting temperature for 20 minutes to achieve the setting temperature quickly.

## 12.8 Timer Control

- There are 2 sets of ON and OFF timer available to turn the unit ON or OFF at different preset time.
- If more than one timer had been set, the upcoming timer will be displayed and will activate in sequence.

### 12.8.1 ON Timer Control

- ON timer 1 and ON timer 2 can be set using remote control, the unit with timer set will start operate earlier than the setting time.  
This is to provide a comfortable environment when reaching the set ON time.
- 60 minutes before the set time, indoor (at fan speed of Lo-) and outdoor fan motor start operate for 30 seconds to determine the indoor intake air temperature and outdoor air temperature in order to judge the operation starting time.
- From the above judgment, the decided operation will start operate earlier than the set time as shown below.

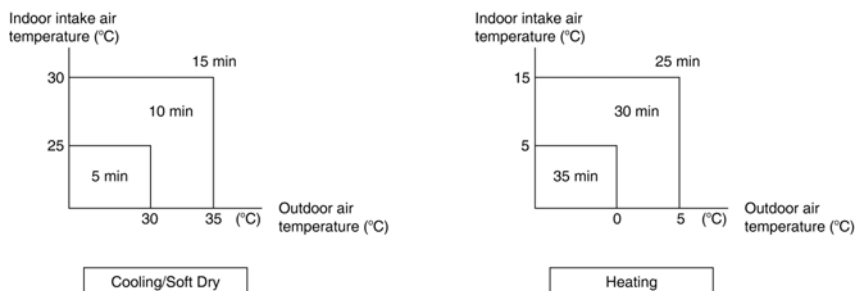

### 12.8.2 OFF Timer Control

OFF timer 1 and OFF timer 2 can be set using remote control, the unit with timer set will stop operate at set time.

## 12.9 Auto Restart Control

- When the power supply is cut off during the operation of air conditioner, the compressor will re-operate within three to four minutes (there are 10 patterns between 2 minutes 58 seconds and 3 minutes 52 seconds to be selected randomly) after power supply resumes.
- This type of control is not applicable during ON/OFF Timer setting.
- This control can be omitted by open the circuit of JP3 at indoor unit printed circuit board.

## 12.10 Indication Panel

LED	POWER	TIMER	POWERFUL	QUIET	AIR SWING
Color	Green	Orange	Orange	Orange	Orange
Light ON	Operation ON	Timer Setting ON	POWERFUL Mode ON	QUIET Mode ON	AIR SWING ON
Light OFF	Operation OFF	Timer Setting OFF	POWERFUL Mode OFF	QUIET Mode OFF	AIR SWING OFF

Note:

- If POWER LED is blinking, the possible operation of the unit are Hot Start, during Deice operation, operation mode judgment, or ON timer sampling.
- If Timer LED is blinking, there is an abnormality operation occurs.

## 12.11 Drain Pump Control Operation

Drain pump control

- This unit has built-in with drain pump.

Control content

- During COOL/DRY mode.
  - During COOL/DRY mode, drain pump starts 10 seconds after indoor fan motor starts.
  - The drain pump is always ON.
- After COOL/DRY mode, when unit turns OFF (power standby) or changes to HEAT mode.
  - The drain pump turns ON for 90 seconds immediately.
- Error judgment
  - When float switch detects ON signal continuously for 2 minutes 30 seconds, error code H21 are shown.
  - When float switch ON has operated 2 times within 20 minutes, error code H35 are shown.

## 12.12 HA Terminal (HAJEM-A)

- Enable digital connection from indoor unit to external devices.
- Control items:
  1. Start/stop input.
  2. Start/stop signal output.

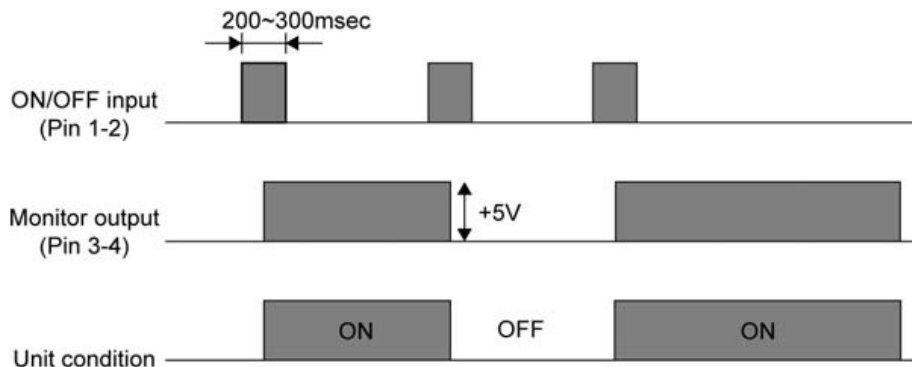

- Condition
  1. 1-2 (Pulse input): Unit ON/OFF condition switching with a pulse signal. (1 pulse signal: shortage status 200~300msec)
  2. 3-4 (Static output): 5V output during the unit ON. No output at OFF.

Example of wiring:

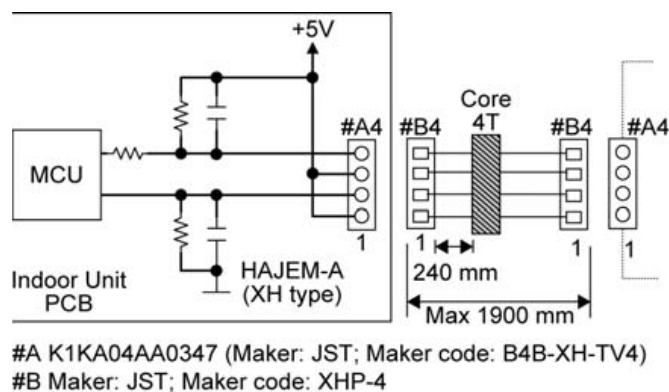

Note: The wire length from indoor unit to the external interface must be within 1.9 meters. The wire must be double insulation type and a ferrite core to be added to reduce noise. Proposed core spec is JOKE00000147 with Heat Shrinkage Tube.

The signal between indoor unit and the external interface must be isolated by photo-coupler of approval type (e.g: Semko, VDE etc).

# 13. Protection Control

## 13.1 Protection Control For All Operations

### 13.1.1 Restart Control (Time Delay Safety Control)

- The Compressor will not turn on within 3 minutes from the moment operation stops, although the unit is turned on again by pressing OFF/ON button at remote control within this period.
- This control is not applicable if the power supply is cut off and on again.
- This phenomenon is to balance the pressure inside the refrigerant cycle.

### 13.1.2 Total Running Current

- 1 When the outdoor unit total running current (AC) exceeds X value, the frequency instructed for compressor operation will be decreased.
- 2 If the running current does not exceed X value for 5 seconds, the frequency instructed will be increased.
- 3 However, if total outdoor unit running current exceeds Y value, compressor will be stopped immediately for 3 minutes.

Model	CS-E18RB4EAW CU-E18RBEA		CS-E21RB4EAW CU-E21RBEA	
	X (A)	Y (A)	X (A)	Y (A)
Cooling / Soft Dry (A)	11.96	14.75	12.35	14.75
Cooling / Soft Dry (B/C)	9.82		11.10	
Heating	10.53		12.27	

- 4 The first 30 minutes of cooling operation, (A) will be applied.

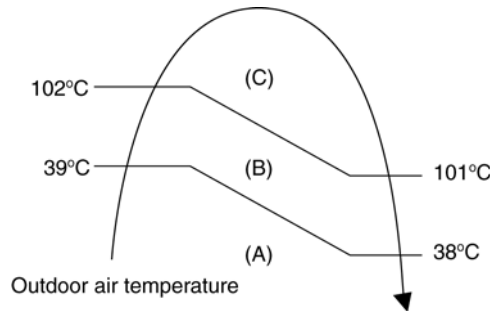

### 13.1.3 IPM (Power transistor) Prevention Control

- Overheating Prevention Control
  - 1 When the IPM temperature rises to 120°C, compressor operation will stop immediately.
  - 2 Compressor operation restarts after 3 minutes the temperature decreases to 110°C.
  - 3 If this condition repeats continuously 4 times within 20 minutes, timer LED will be blinking ("F96" is indicated).
- DC Peak Current Control
  - 1 When electric current to IPM exceeds set value of, 30.0 ± 5.0A, the compressor will stop operate. Then, operation will restart after 3 minutes.
  - 2 If the set value is exceeded again more than 30 seconds after the compressor starts, the operation will restart after 1 minute.
  - 3 If the set value exceeded again within 30 seconds after the compressor starts, the operation will restart after 1 minute. If this condition repeats continuously for 7 times, all indoor and outdoor relays will be cut off, timer LED will be blinking ("F99" is indicated).

### 13.1.4 Compressor Overheating Prevention Control

- Instructed frequency for compressor operation will be regulated by compressor top temperature. The changes of frequency are as below.
- If compressor top temperature exceeds 107°C, compressor will be stopped, occurs 4 times per 20 minutes, timer LED will be blinking. ("F97" is indicated.)

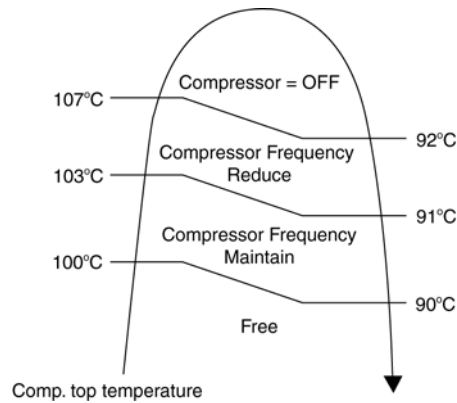

### 13.1.5 Low Pressure Prevention Control (Gas Leakage Detection)

- Control start conditions
  - For 5 minutes, the compressor continuously operates and outdoor total current is between 0.75A and 0.95A.
  - During Cooling and Soft Dry operations:  
Indoor suction temperature - indoor piping temperature is below 4°C.
  - During Heating operations :  
Indoor piping temperature - indoor suction is under 5°C.
- Control contents
  - Compressor stops (and restart after 3 minutes).
  - If the conditions above happen 2 times within 20 minutes, the unit will:
    - Stop operation
    - Timer LED blinks and "F91" indicated.

### 13.1.6 Low Frequency Protection Control 1

- When the compressor operate at frequency lower than 24 Hz continued for 20 minutes, the operation frequency will be changed to 23 Hz for 2 minutes.

### 13.1.7 Low Frequency Protection Control 2

- When all the below conditions comply, the compressor frequency will change to lower frequency.

Temperature, T, for:	Cooling/Soft Dry	Heating
Indoor intake air (°C)	T < 14 or T ≥ 30	T < 14 or T ≥ 28
Outdoor air (°C)	T < 13 or T ≥ 38	T < 4 or T ≥ 24
Indoor heat exchanger (°C)	T < 30	T ≥ 0



## 13.2 Protection Control For Cooling & Soft Dry Operation

### 13.2.1 Outdoor Air Temperature Control

- The compressor operating frequency is regulated in accordance to the outdoor air temperature as shown in the diagram below.
- This control will begin 1 minute after the compressor starts.
- Compressor frequency will adjust base on outdoor air temperature.

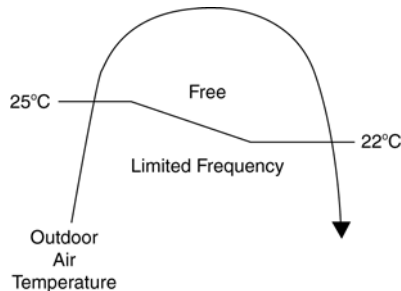

- The compressor will be stopped to avoid compressor overloading.

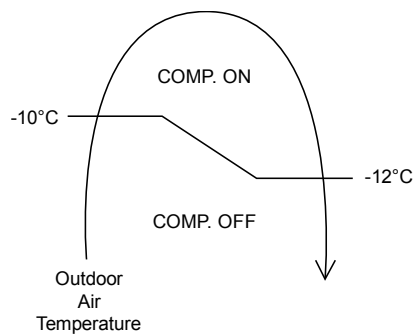

### 13.2.2 Cooling Overload Control

- Detects the Outdoor pipe temperature and carry out below restriction/limitation (Limit the compressor Operation frequency).
- The compressor stop if outdoor pipe temperature exceeds 63°C.
- If the compressor stops 4 times in 20 minutes, Timer LED blinking (F95 indicated: outdoor high pressure rise protection).

### 13.2.3 Freeze Prevention Control 1

- When indoor heat exchanger temperature is lower than 0°C continuously for 6 minutes, compressor will stop operating.
- Compressor will resume its operation after stop for 3 minutes and the indoor heat exchanger is higher than 5°C.
- At the same time, indoor fan speed will be higher than during its normal operation.
- If indoor heat exchanger temperature is higher than 13°C, the fan speed will return to its normal operation.

### 13.2.4 Freeze Prevention Control 2

- Control start conditions
  - During Cooling operation and soft dry operation
    - During thermo OFF condition, indoor intake temperature is less than 10°C or
    - Compressor stops for freeze prevention control
  - Either one of the conditions above occurs 5 times in 40 minutes.
- Control contents
  - Operation stops
  - Timer LED blinks and "H99" indicated

### 13.2.5 Dew Prevention Control 1

- To prevent dew formation at indoor unit discharge area.
- This control will be activated if:
  - Outdoor air temperature and Indoor pipe temperature judgment by microcontroller is fulfilled.
  - When Cooling or Dry mode is operated more than 20 minutes or more.
- This control stopped if:
  - Compressor stopped.
  - Remote control setting changed (fan speed / temperature).
  - Outdoor air temperature and indoor intake temperature changed.
- Fan speed will be adjusted accordingly in this control.

### 13.2.6 Odor Cut Control

- To reduce the odor released from the unit.
  - Start Condition
    - AUTO FAN Speed is selected during COOL or DRY operation.
    - During freeze prevention control and timer preliminary operation, this control is not applicable.
  - Control content
    - Depends on compressor conditions:
      1. Compressor OFF → Compressor ON.  
The indoor unit fan stops temporarily and then starts to blow at minimum airflow for 30 seconds.
      2. Compressor ON → Compressor OFF.  
The indoor unit fan stops for 90 seconds and then blows at minimum airflow for 20 seconds.

## 13.3 Protection Control For Heating Operation

### 13.3.1 Intake Air Temperature Control

Compressor will operate at limited freq., if indoor intake air temperature is 30°C or above.

### 13.3.2 Outdoor Air Temperature Control

- The Max current value is regulated when the outdoor air temperature rise above 14°C in order to avoid compressor overloading.

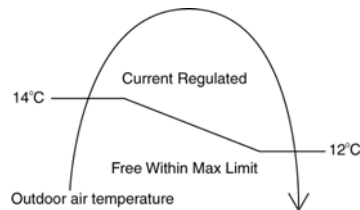

- The compressor will be stopped to avoid compressor overloading.

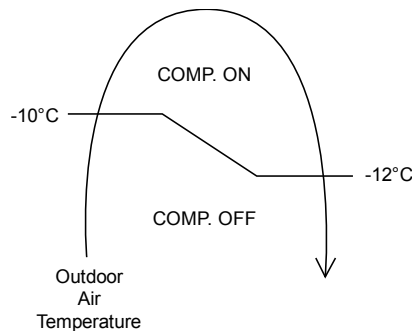

### 13.3.3 Overload Protection Control

- The compressor operating frequency is regulated in accordance to indoor heat exchanger temperature as shown below.
- If the heat exchanger temperature exceeds 60°C, compressor will stop.

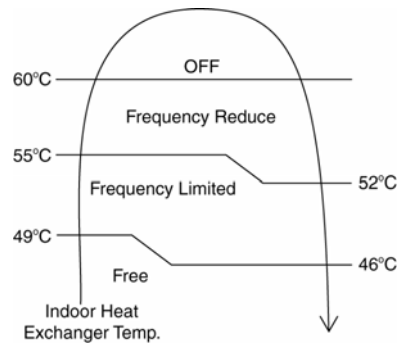

### 13.3.4 Low Temperature Compressor Oil Return Control

- In heating operation, if the outdoor temperature falls below -10°C when compressor starts, the compressor frequency will be regulated up to 600 seconds.

### 13.3.5 Cold Draught Prevention Control

- When indoor pipe temperature is low, cold draught operation starts where indoor fan speed will be reduced.

### 13.3.6 Deice Operation

- When outdoor pipe temperature and outdoor air temperature is low, deice operation start where indoor fan motor and outdoor fan motor stop and operation LED blinks.

# 14. Servicing Mode

## 14.1 Auto OFF/ON Button

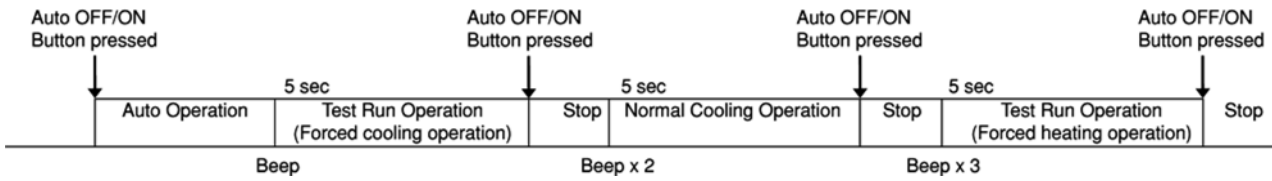

### 1 AUTO OPERATION MODE

The Auto operation will be activated immediately once the Auto OFF/ON button is pressed. This operation can be used to operate air conditioner with limited function if remote control is misplaced or malfunction.

### 2 TEST RUN OPERATION (FOR PUMP DOWN/SERVICING PURPOSE)

The Test Run operation will be activated if the Auto OFF/ON button is pressed continuously for more than 5 seconds. A “beep” sound will heard at the fifth seconds, in order to identify the starting of Test Run operation (Forced cooling operation). Within 5 minutes after Forced cooling operation start, the Auto OFF/ON button is pressed for more than 5 seconds. A 2 “beep” sounds will heard at the fifth seconds, in order to identify the starting of Normal cooling operation.

Within 5 minutes after Normal cooling operation start, the Auto OFF/ON button is pressed for more than 5 seconds. A 3 “beep” sounds will be heard at the fifth seconds, in order to identify the starting of Forced heating operation.

The Auto OFF/ON button may be used together with remote control to set / change the advance setting of air conditioner operation.

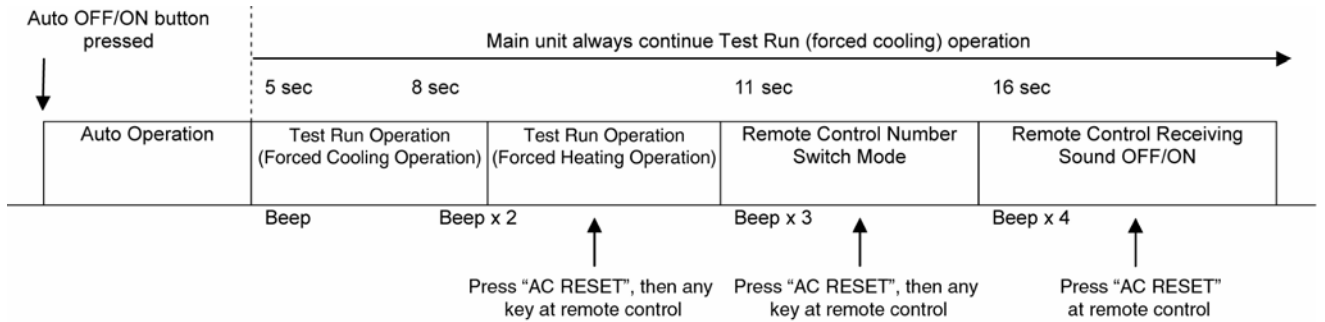

### 3 REMOTE CONTROL NUMBER SWITCH MODE

The Remote Control Number Switch Mode will be activated if the Auto OFF/ON button is pressed continuously for more than 11 seconds (3 “beep” sounds will occur at 11th seconds to identify the Remote Control Number Switch Mode is in standby condition) and press “AC RESET” button and then press any button at remote control to transmit and store the desired transmission code to the EEPROM.

There are 4 types of remote control transmission code could be selected and stored in EEPROM of indoor unit. The indoor unit will only operate when received signal with same transmission code from remote control. This could prevent signal interference when there are 2 or more indoor units installed nearby together. To change remote control transmission code, short or open jumpers at the remote control printed circuit board.

Remote Control Printed Circuit Board	Remote Control Printed Circuit Board		
	Jumper A (J_A)	Jumper B (JB)	Remote Control No.
	Short	Open	A (Default)
	Open	Open	B
	Short	Short	C
	Open	Short	D

- During Remote Control Number Switch Mode, press any button at remote control to transmit and store the transmission code to the EEPROM.

#### 4 REMOTE CONTROL RECEIVING SOUND OFF/ON MODE

The Remote Control Receiving Sound OFF/ON Mode will be activated if the Auto OFF/ON button is pressed continuously for more than 16 seconds (4 “beep” sounds will occur at 16th seconds to identify the Remote Control Receiving Sound Off/On Mode is in standby condition) and press “AC Reset” button at remote control.

Press “Auto OFF/ON button” to toggle remote control receiving sound.

- Short “beep”: Turn OFF remote control receiving sound.
- Long “beep”: Turn ON remote control receiving sound.

After Auto OFF/ON Button is pressed, the 20 seconds counter for Remote Control Receiving Sound OFF/ON Mode is restarted.

## **14.2 Remote Control Button**

### **14.2.1 SET Button**

- To check remote control transmission code and store the transmission code to EEPROM:
  - Press “Set” button continuously for 10 seconds by using pointer.
  - Press “Timer Set” button until a “beep” sound is heard as confirmation of transmission code changed.

### **14.2.2 RESET (RC)**

- To clear and restore the remote control setting to factory default.
  - Press once to clear the memory.

### **14.2.3 RESET (AC)**

- To restore the unit’s setting to factory default.
  - Press once to restore the unit’s setting.

### **14.2.4 TIMER ▲**

- To change indoor unit indicator’s LED intensity.
  - Press continuously for 5 seconds.

### **14.2.5 TIMER ▼**

- To change remote control display from Degree Celsius (°C) to Degree Fahrenheit (°F).
  - Press continuously for 10 seconds.

### 14.3 Outdoor PCB Test Run Operation (For Pump Down/Serviceing Purpose)

- The Test Run operation will be activated by short-circuiting CN-S (Pin 1 and 2) at outdoor unit PCB after power supplied to outdoor unit terminal 1 and 2. The unit forced to run rated frequency cooling operation mode.

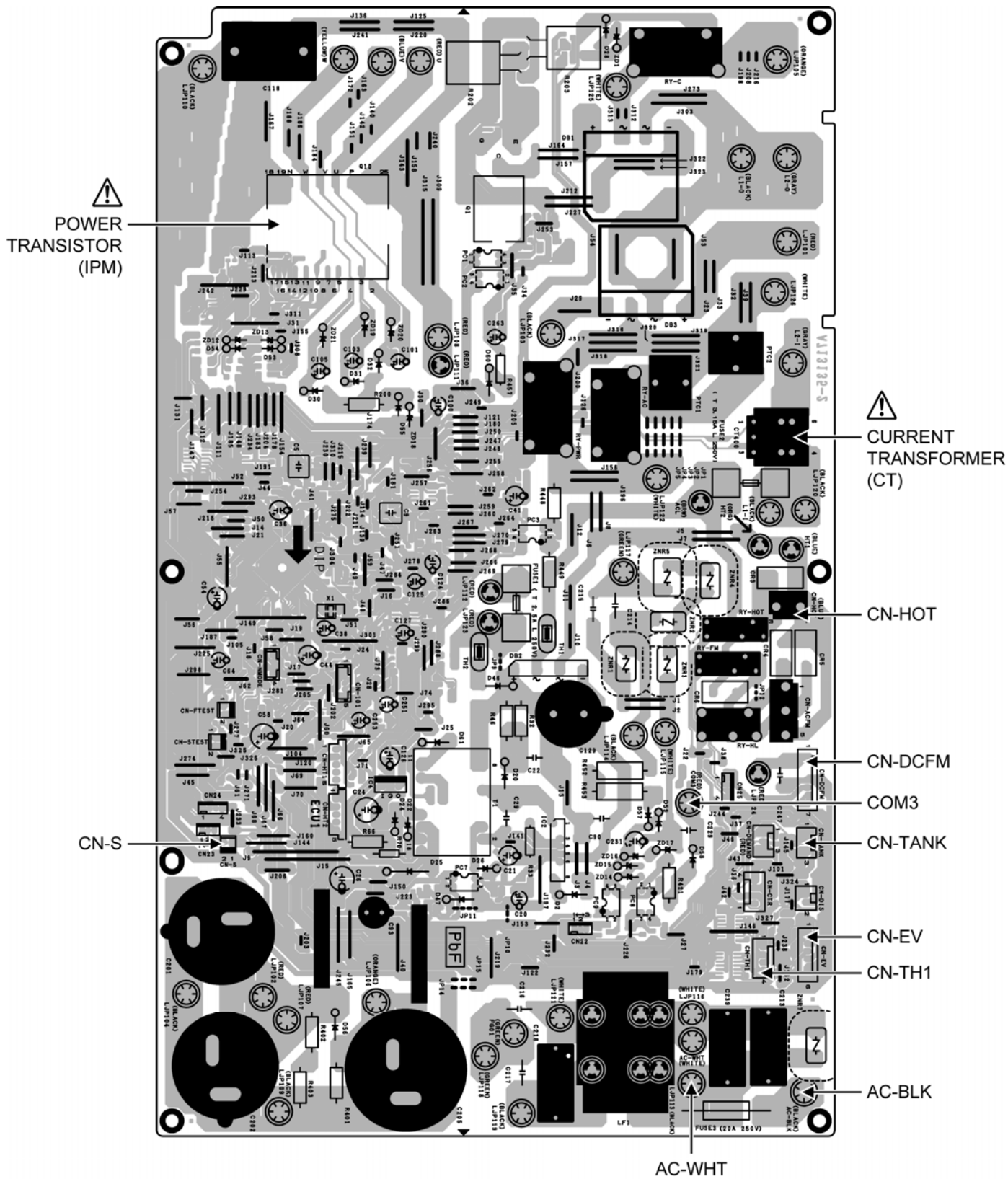

# 15. Troubleshooting Guide

## 15.1 Refrigeration Cycle System

In order to diagnose malfunctions, make sure that there are no electrical problems before inspecting the refrigeration cycle. Such problems include insufficient insulation, problem with the power source, malfunction of a compressor and a fan.

The normal outlet air temperature and pressure of the refrigeration cycle depends on various conditions, the standard values for them are shown in the table on the right.

Normal Pressure and Outlet Air Temperature (Standard)

	Gas Pressure MPa (kg/cm <sup>2</sup> G)	Outlet air Temperature (°C)
Cooling Mode	0.9 ~ 1.2 (9 ~ 12)	12 ~ 16
Heating Mode	2.3 ~ 2.9 (23 ~ 29)	36 ~ 45

- \*Condition:
- Indoor fan speed = High
  - Outdoor temperature 35°C at the cooling mode and 7°C at the heating mode
  - Compressor operates at rated frequency

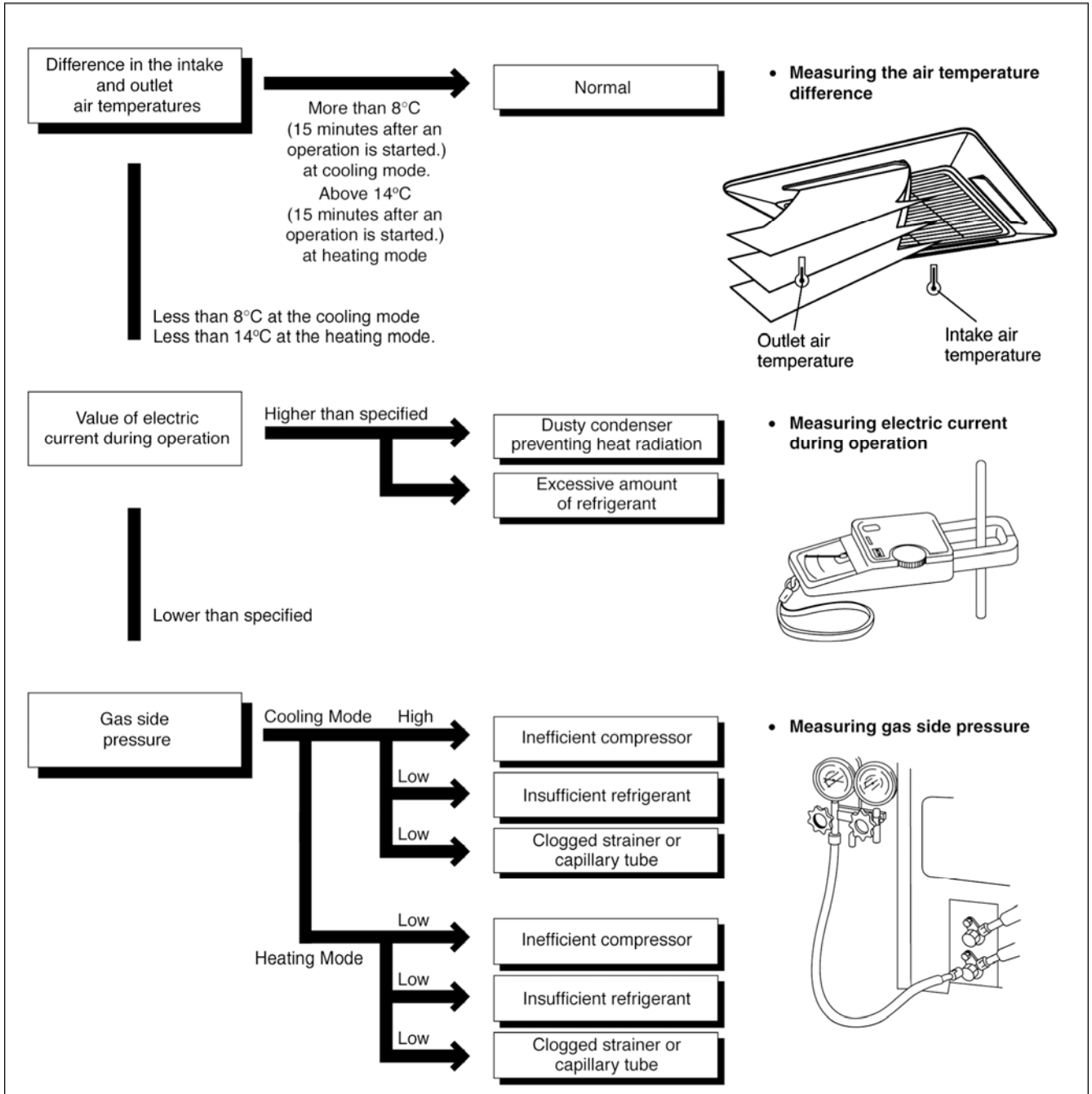

### 15.1.1 Relationship between the condition of the air conditioner and pressure and electric current

Condition of the air conditioner	Cooling Mode			Heating Mode		
	Low Pressure	High Pressure	Electric current during operation	Low Pressure	High Pressure	Electric current during operation
Insufficient refrigerant (gas leakage)	↘	↘	↘	↘	↘	↘
Clogged capillary tube or Strainer	↘	↘	↘	↗	↗	↗
Short circuit in the indoor unit	↘	↘	↘	↗	↗	↗
Heat radiation deficiency of the outdoor unit	↗	↗	↗	↘	↘	↘
Inefficient compression	↗	↘	↘	↗	↘	↘

- Carry out the measurement of pressure, electric current, and temperature fifteen minutes after an operation is started.



## 15.2 Breakdown Self Diagnosis Function

### 15.2.1 Self Diagnosis Function (Three Digits Alphanumeric Code)

- Once abnormality has occurred during operation, the unit will stop its operation, and Timer LED blinks.
  - Although Timer LED goes off when power supply is turned off, if the unit is operated under a breakdown condition, the LED will light up again.
  - In operation after breakdown repair, the Timer LED will no more blink. The last error code (abnormality) will be stored in IC memory.
- 6 When the latest abnormality code on the main unit and code transmitted from the remote controller are matched, power LED will light up for 30 seconds and a beep sound (continuously for 4 seconds) will be heard. If no codes are matched, power LED will light up for 0.5 seconds and no sound will be heard.
  - 7 The breakdown diagnosis mode will be canceled unless pressing the CHECK button continuously for 5 seconds or operating the unit for 30 seconds.
  - 8 The same diagnosis can be repeated by turning power on again.

### 15.2.2 To Make a Diagnosis

- 1 Timer LED start to blink and the unit automatically stops the operation.
- 2 Press the CHECK button on the remote controller continuously for 5 seconds.
- 3 “- -” will be displayed on the remote controller display.  
Note: Display only for “- -”. (No transmitting signal, no receiving sound and no Power LED blinking.)
- 4 Press the “TIMER” ▲ or ▼ button on the remote controller. The code “H00” (no abnormality) will be displayed and signal will be transmitted to the main unit.
- 5 Every press of the button (up or down) will increase abnormality numbers and transmit abnormality code signal to the main unit.
- 6 When the latest abnormality code on the main unit and code transmitted from the remote controller are matched, power LED will light up for 30 seconds and a beep sound (continuously for 4 seconds) will be heard. If no codes are matched, power LED will light up for 0.5 seconds and no sound will be heard.
- 7 The breakdown diagnosis mode will be canceled unless pressing the CHECK button continuously for 5 seconds or operating the unit for 30 seconds.
- 8 The LED will be off if the unit is turned off or the RESET button on the main unit is pressed.

### 15.2.3 To Display Memorized Error Code (Protective Operation)

- 1 Turn power on.
- 2 Press the CHECK button on the remote controller continuously for 5 seconds.
- 3 “- -” will be displayed on the remote controller display.  
Note: Display only for “- -”. (No transmitting signal, no receiving sound and no Power LED blinking.)
- 4 Press the “TIMER” ▲ or ▼ button on the remote controller. The code “H00” (no abnormality) will be displayed and signal will be transmitted to the main unit. The power LED lights up. If no abnormality is stored in the memory, three beeps sound will be heard.
- 5 Every press of the button (up or down) will increase abnormality numbers and transmit abnormality code signal to the main unit.

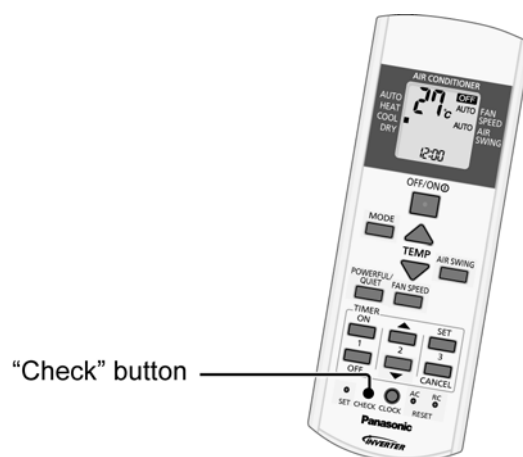

### 15.2.4 To Clear Memorized Error Code after Repair (Protective Operation)

- 1 Turn power on (in standby condition).
- 2 Press the AUTO button for 5 seconds (A beep receiving sound) on the main unit to operate the unit at Forced Cooling Operation modes.
- 3 Press the CHECK button on the remote controller for about 1 second with a pointed object to transmit signal to main unit. A beep sound is heard from main unit and the data is cleared.

### 15.2.5 Temporary Operation (Depending On Breakdown Status)

- 1 Press the AUTO button (A beep receiving sound) on the main unit to operate the unit. (Remote control will become possible.)
- 2 The unit can temporarily be used until repaired.

## 15.3 Error Codes Table

Diagnosis display	Abnormality / Protection control	Abnormality Judgment	Protection Operation	Problem	Check location
H00	No memory of failure	—	Normal operation	—	—
H11	Indoor/outdoor abnormal communication	After operation for 1 minute	Indoor fan only operation can start by entering into force cooling operation	Indoor/outdoor communication not establish	<ul style="list-style-type: none"> <li>Indoor/outdoor wire terminal</li> <li>Indoor/outdoor PCB</li> <li>Indoor/outdoor connection wire</li> </ul>
H12	Indoor unit capacity unmatched	90s after power supply	—	Total indoor capability more than maximum limit or less than minimum limit, or number of indoor unit less than two	<ul style="list-style-type: none"> <li>Indoor/outdoor connection wire</li> <li>Indoor/outdoor PCB</li> <li>Specification and combination table in catalogue</li> </ul>
H14	Indoor intake air temperature sensor abnormality	Continuous for 5s	—	Indoor intake air temperature sensor open or short circuit	<ul style="list-style-type: none"> <li>Indoor intake air temperature sensor lead wire and connector</li> </ul>
H15	Compressor temperature sensor abnormality	Continuous for 5s	—	Compressor temperature sensor open or short circuit	<ul style="list-style-type: none"> <li>Compressor temperature sensor lead wire and connector</li> </ul>
H16	Outdoor current transformer (CT) abnormality	—	—	Current transformer faulty or compressor faulty	<ul style="list-style-type: none"> <li>Outdoor PCB faulty or compressor faulty</li> </ul>
H19	Indoor fan motor mechanism lock	Continuous happen for 7 times	—	Indoor fan motor lock or feedback abnormal	<ul style="list-style-type: none"> <li>Fan motor lead wire and connector</li> <li>Fan motor lock or block</li> </ul>
H21	Indoor float switch operation abnormal	—	—	—	—
H23	Indoor heat exchanger temperature sensor abnormality	Continuous for 5s	—	Indoor heat exchanger temperature sensor open or short circuit	<ul style="list-style-type: none"> <li>Indoor heat exchanger temperature sensor lead wire and connector</li> </ul>
H24	Indoor heat exchanger temperature sensor 2 abnormality	Continuous for 5s	—	Indoor heat exchanger temperature sensor 2 open or short circuit	<ul style="list-style-type: none"> <li>Indoor heat exchanger temperature sensor 2 lead wire and connector</li> </ul>
H27	Outdoor air temperature sensor abnormality	Continuous for 5s	—	Outdoor air temperature sensor open or short circuit	<ul style="list-style-type: none"> <li>Outdoor air temperature sensor lead wire and connector</li> </ul>
H28	Outdoor heat exchanger temperature sensor 1 abnormality	Continuous for 5s	—	Outdoor heat exchanger temperature sensor 1 open or short circuit	<ul style="list-style-type: none"> <li>Outdoor heat exchanger temperature sensor 1 lead wire and connector</li> </ul>
H30	Outdoor discharge pipe temperature sensor abnormality	Continuous for 5s	—	Outdoor discharge pipe temperature sensor open or short circuit	<ul style="list-style-type: none"> <li>Outdoor discharge pipe temperature sensor lead wire and connector</li> </ul>
H33	Indoor / outdoor misconnection abnormality	—	—	Indoor and outdoor rated voltage different	<ul style="list-style-type: none"> <li>Indoor and outdoor units check</li> </ul>
H35	Indoor drain water adverse current abnormal	—	—	—	—
H38	Indoor/Outdoor mismatch (brand code)	—	—	Brand code not match	<ul style="list-style-type: none"> <li>Check indoor unit and outdoor unit</li> </ul>
H97	Outdoor fan motor mechanism lock	2 times happen within 30 minutes	—	Outdoor fan motor lock or feedback abnormal	<ul style="list-style-type: none"> <li>Outdoor fan motor lead wire and connector</li> <li>Fan motor lock or block</li> </ul>
H98	Indoor high pressure protection	—	—	Indoor high pressure protection (Heating)	<ul style="list-style-type: none"> <li>Check indoor heat exchanger</li> <li>Air filter dirty</li> <li>Air circulation short circuit</li> </ul>
H99	Indoor operating unit freeze protection	—	—	Indoor freeze protection (Cooling)	<ul style="list-style-type: none"> <li>Check indoor heat exchanger</li> <li>Air filter dirty</li> <li>Air circulation short circuit</li> </ul>
F11	4-way valve switching abnormality	4 times happen within 30 minutes	—	4-way valve switching abnormal	<ul style="list-style-type: none"> <li>4-way valve</li> <li>Lead wire and connector</li> </ul>
F90	Power factor correction (PFC) circuit protection	4 times happen within 10 minutes	—	Power factor correction circuit abnormal	<ul style="list-style-type: none"> <li>Outdoor PCB faulty</li> </ul>
F91	Refrigeration cycle abnormality	2 times happen within 20 minutes	—	Refrigeration cycle abnormal	<ul style="list-style-type: none"> <li>Insufficient refrigerant or valve close</li> </ul>
F93	Compressor abnormal revolution	4 times happen within 20 minutes	—	Compressor abnormal revolution	<ul style="list-style-type: none"> <li>Power transistor module faulty or compressor lock</li> </ul>

<b>Diagnosis display</b>	<b>Abnormality / Protection control</b>	<b>Abnormality Judgment</b>	<b>Protection Operation</b>	<b>Problem</b>	<b>Check location</b>
F95	Outdoor cooling high pressure protection	4 times happen within 20 minutes	—	Cooling high pressure protection	<ul style="list-style-type: none"> <li>• Check refrigeration system</li> <li>• Outdoor air circuit</li> </ul>
F96	Power transistor module overheating protection	4 times happen within 30 minutes	—	Power transistor module overheat	<ul style="list-style-type: none"> <li>• PCB faulty</li> <li>• Outdoor air circuit (fan motor)</li> </ul>
F97	Compressor overheating protection	3 times happen within 30 minutes	—	Compressor overheat	<ul style="list-style-type: none"> <li>• Insufficient refrigerant</li> </ul>
F98	Total running current protection	3 times happen within 20 minutes	—	Total current protection	<ul style="list-style-type: none"> <li>• Check refrigeration system</li> <li>• Power source or compressor lock</li> </ul>
F99	Outdoor direct current (DC) peak detection	Continuous happen for 7 times	—	Power transistor module current protection	<ul style="list-style-type: none"> <li>• Power transistor module faulty or compressor lock</li> </ul>

## 15.4 Self-diagnosis Method

### 15.4.1 H11 (Indoor/Outdoor Abnormal Communication)

#### Malfunction Decision Conditions

- During startup and operation of cooling and heating, the data received from outdoor unit in indoor unit signal transmission is checked whether it is normal.

#### Malfunction Caused

- Faulty indoor unit PCB.
- Faulty outdoor unit PCB.
- Indoor unit-outdoor unit signal transmission error due to wiring error.
- Indoor unit-outdoor unit signal transmission error due to breaking of wire in the connection wires between the indoor and outdoor units.

#### Troubleshooting

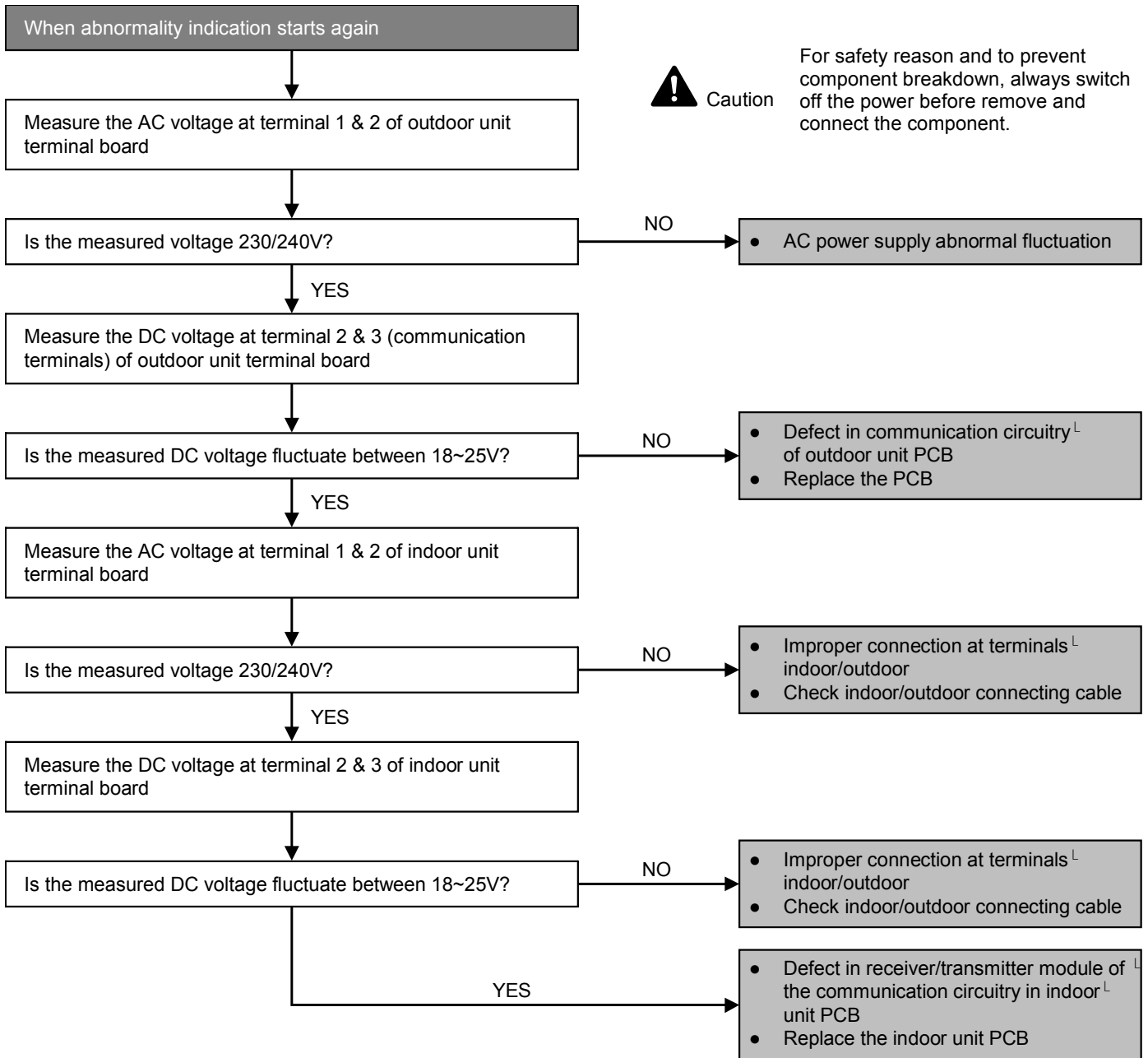

## 15.4.2 H12 (Indoor/Outdoor Capacity Rank Mismatched)

### Malfunction Decision Conditions

- During startup, error code appears when different types of indoor and outdoor units are interconnected.

### Malfunction Caused

- Wrong models interconnected.
- Wrong indoor unit or outdoor unit PCBs mounted.
- Indoor unit or outdoor unit PCBs defective.
- Indoor-outdoor unit signal transmission error due to wrong wiring.
- Indoor-outdoor unit signal transmission error due to breaking of wire 3 in the connection wires between the indoor and outdoor units.

### Troubleshooting

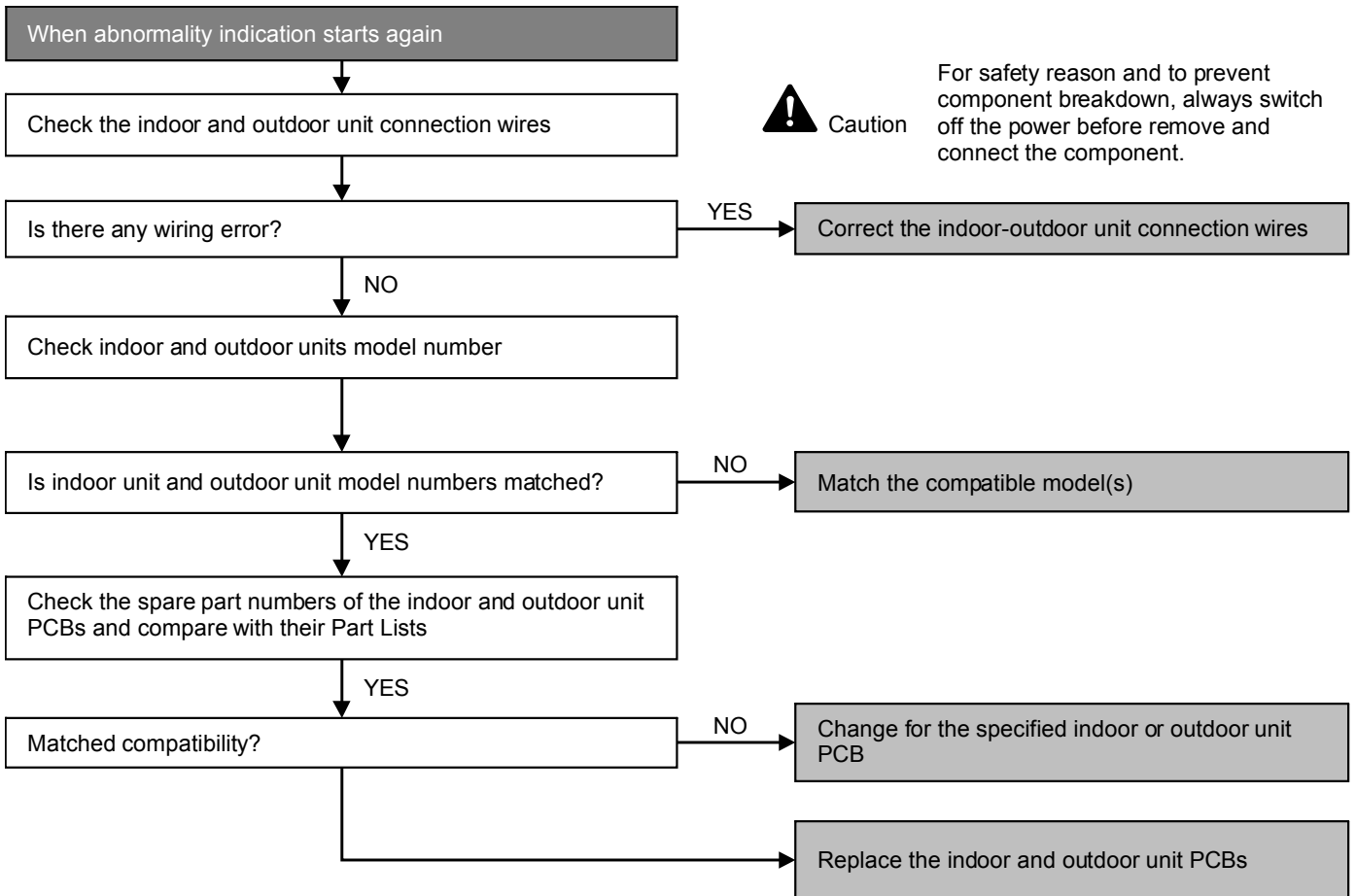

### 15.4.3 H14 (Indoor Intake Air Temperature Sensor Abnormality)

#### Malfunction Decision Conditions

- During startup and operation of cooling and heating, the temperatures detected by the indoor intake air temperature sensor are used to determine sensor errors.

#### Malfunction Caused

- Faulty connector connection.
- Faulty sensor.
- Faulty PCB.

#### Troubleshooting

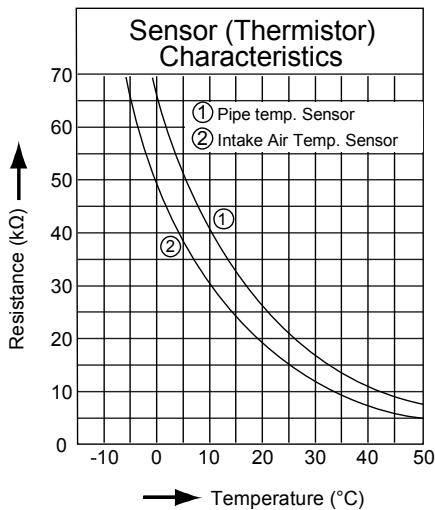
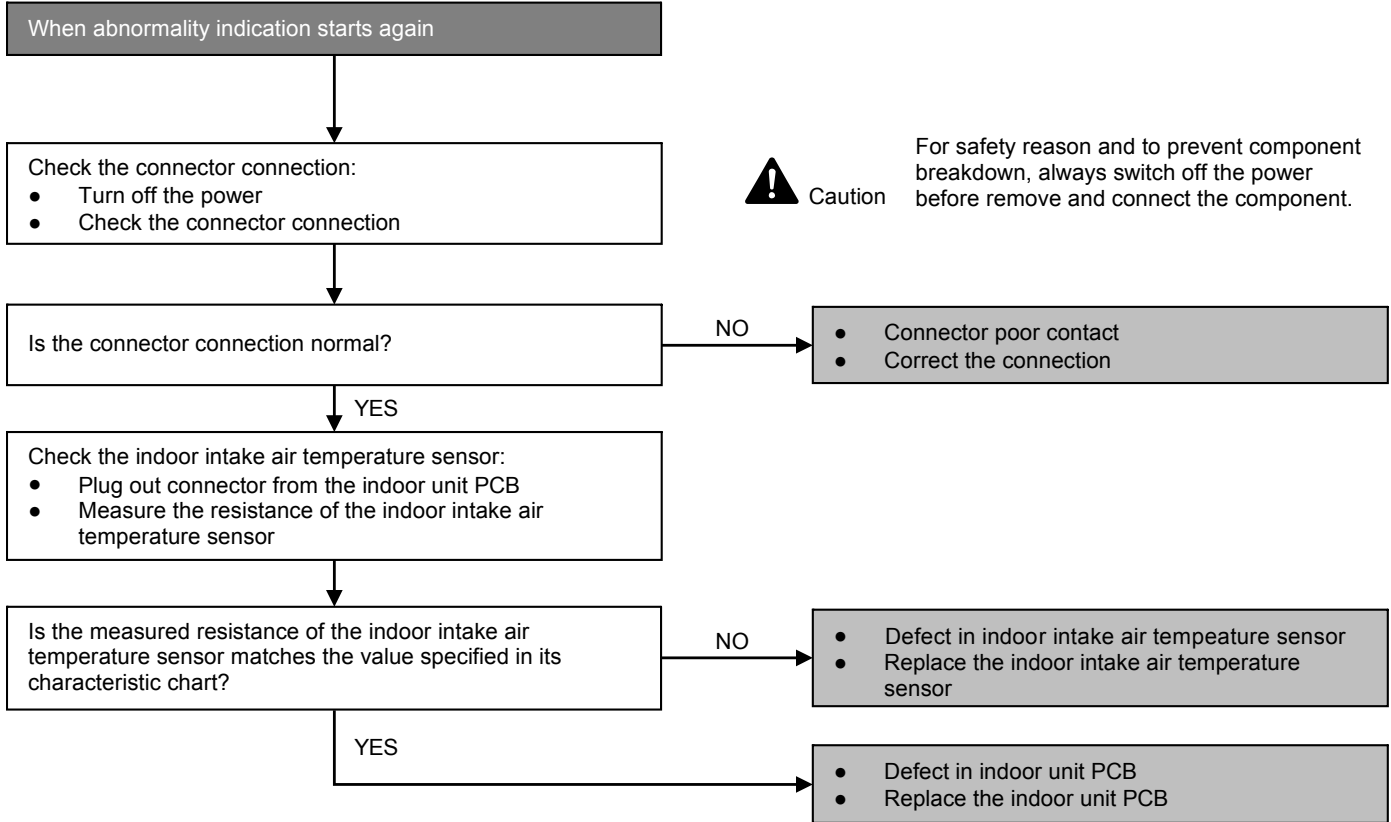

## 15.4.4 H15 (Compressor Temperature Sensor Abnormality)

### Malfunction Decision Conditions

- During startup and operation of cooling and heating, the temperatures detected by the outdoor compressor temperature sensor are used to determine sensor errors.

### Malfunction Caused

- Faulty connector connection.
- Faulty sensor.
- Faulty PCB.

### Troubleshooting

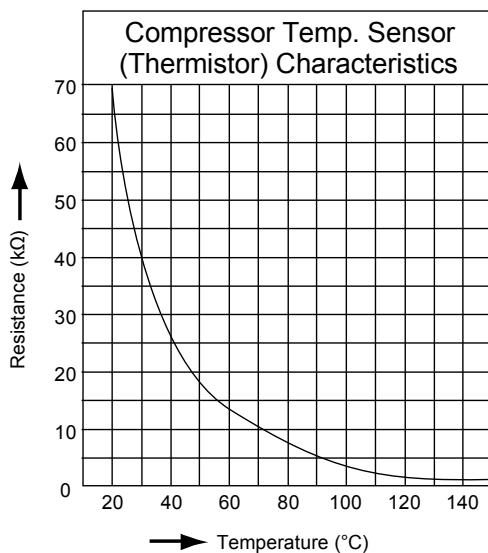
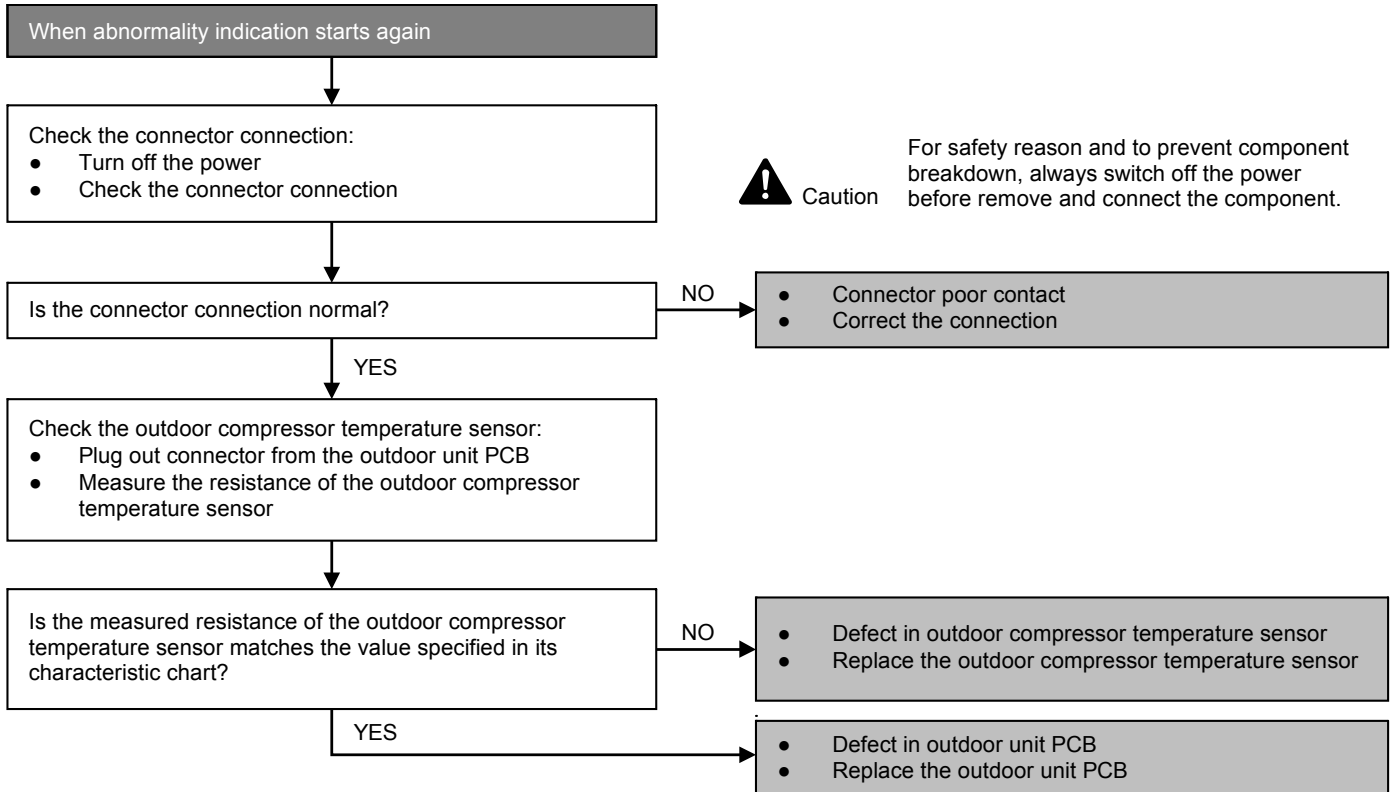

## 15.4.5 H16 (Outdoor Current Transformer)

### Malfunction Decision Conditions

- An input current, detected by Current Transformer CT, is below threshold value when the compressor is operating at certain frequency value for 3 minutes.

### Malfunction Caused

- Lack of gas
- Broken CT (current transformer)
- Broken Outdoor PCB

### Troubleshooting

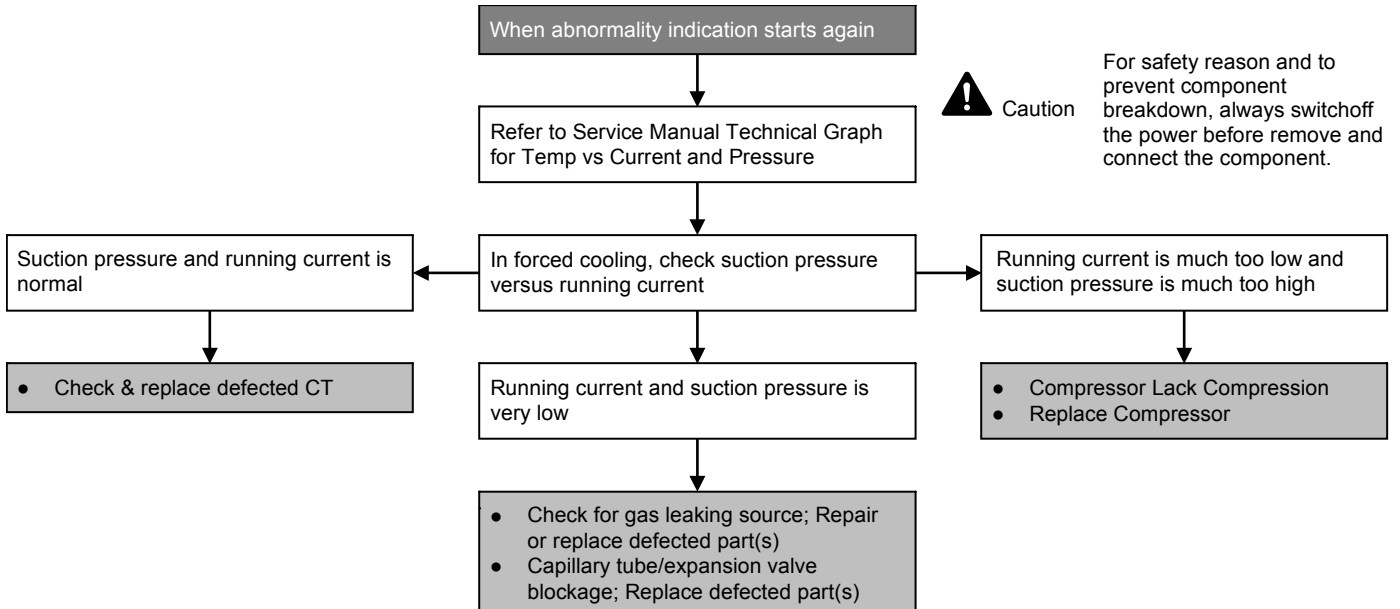



### 15.4.6 H19 (Indoor Fan Motor – DC Motor Mechanism Locked)

#### Malfunction Decision Conditions

- The rotation speed detected by the Hall IC during fan motor operation is used to determine abnormal fan motor (feedback of rotation > 2550rpm or < 50rpm)

#### Malfunction Caused

- Operation stops due to short circuit inside the fan motor winding.
- Operation stops due to breaking of wire inside the fan motor.
- Operation stops due to breaking of fan motor lead wires.
- Operation stops due to Hall IC malfunction.
- Operation error due to faulty indoor unit PCB.

#### Troubleshooting

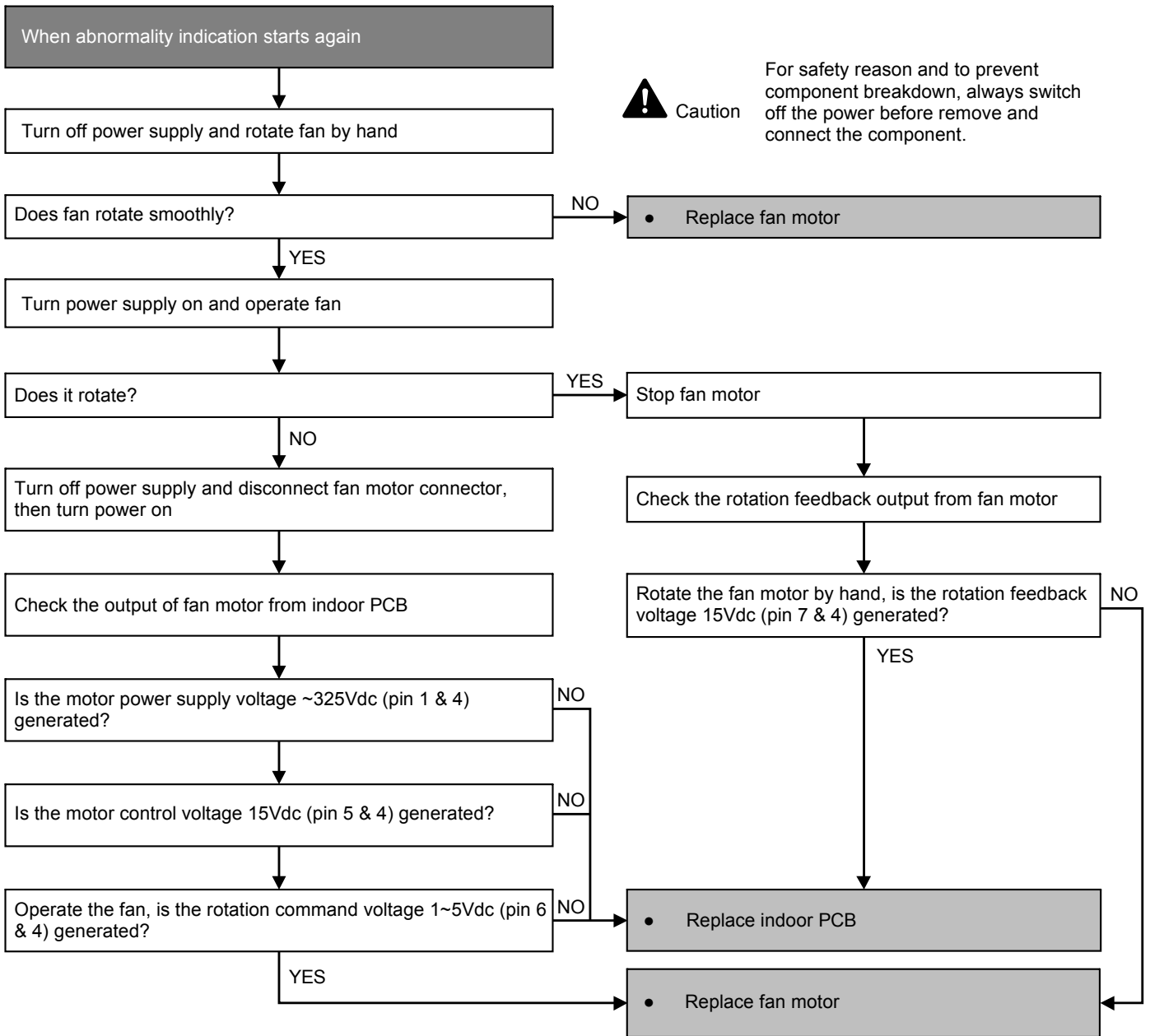

## 15.4.7 H23 (Indoor Pipe Temperature Sensor Abnormality)

### Malfunction Decision Conditions

- During startup and operation of cooling and heating, the temperatures detected by the indoor heat exchanger temperature sensor are used to determine sensor errors.

### Malfunction Caused

- Faulty connector connection.
- Faulty sensor.
- Faulty PCB.

### Troubleshooting

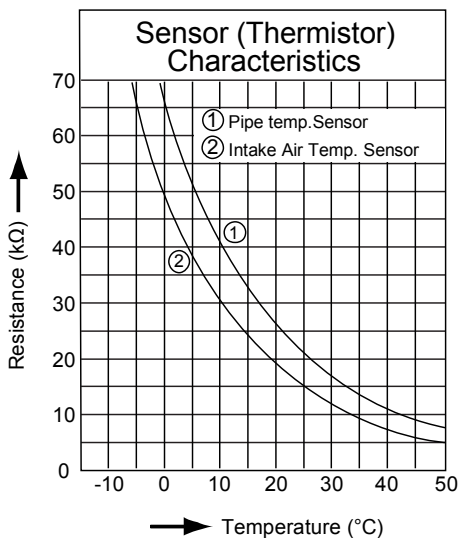
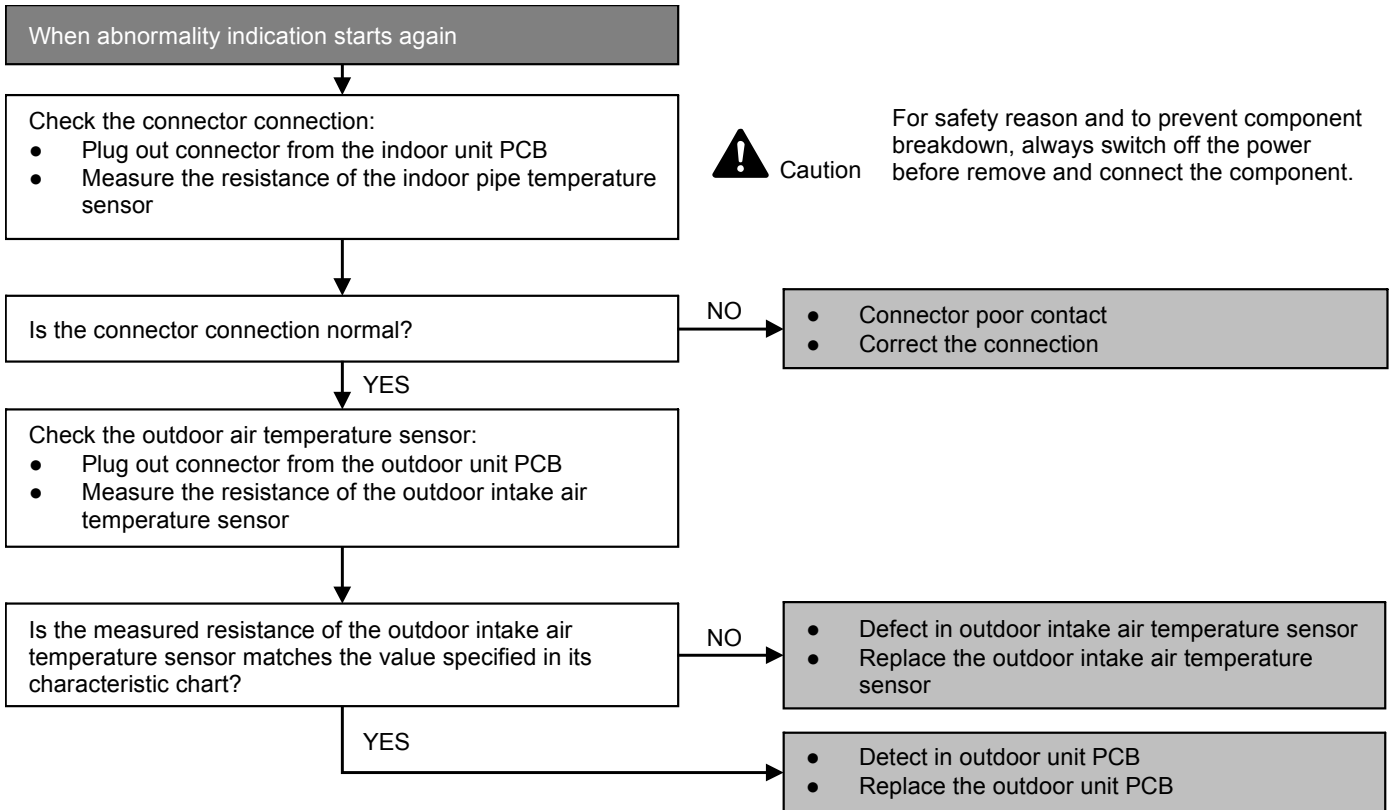

## 15.4.8 H24 (Indoor Pipe Temperature Sensor 2 Abnormality)

### Malfunction Decision Conditions

- During startup and operation of cooling and heating, the temperatures detected by the indoor heat exchanger temperature sensor 2 are used to determine sensor errors.

### Malfunction Caused

- Faulty connector connection.
- Faulty sensor.
- Faulty PCB.

### Troubleshooting

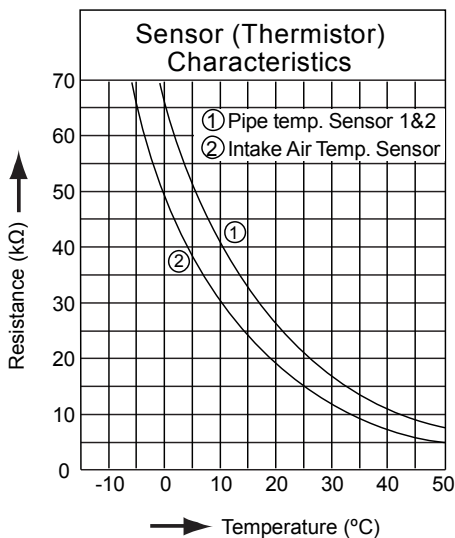
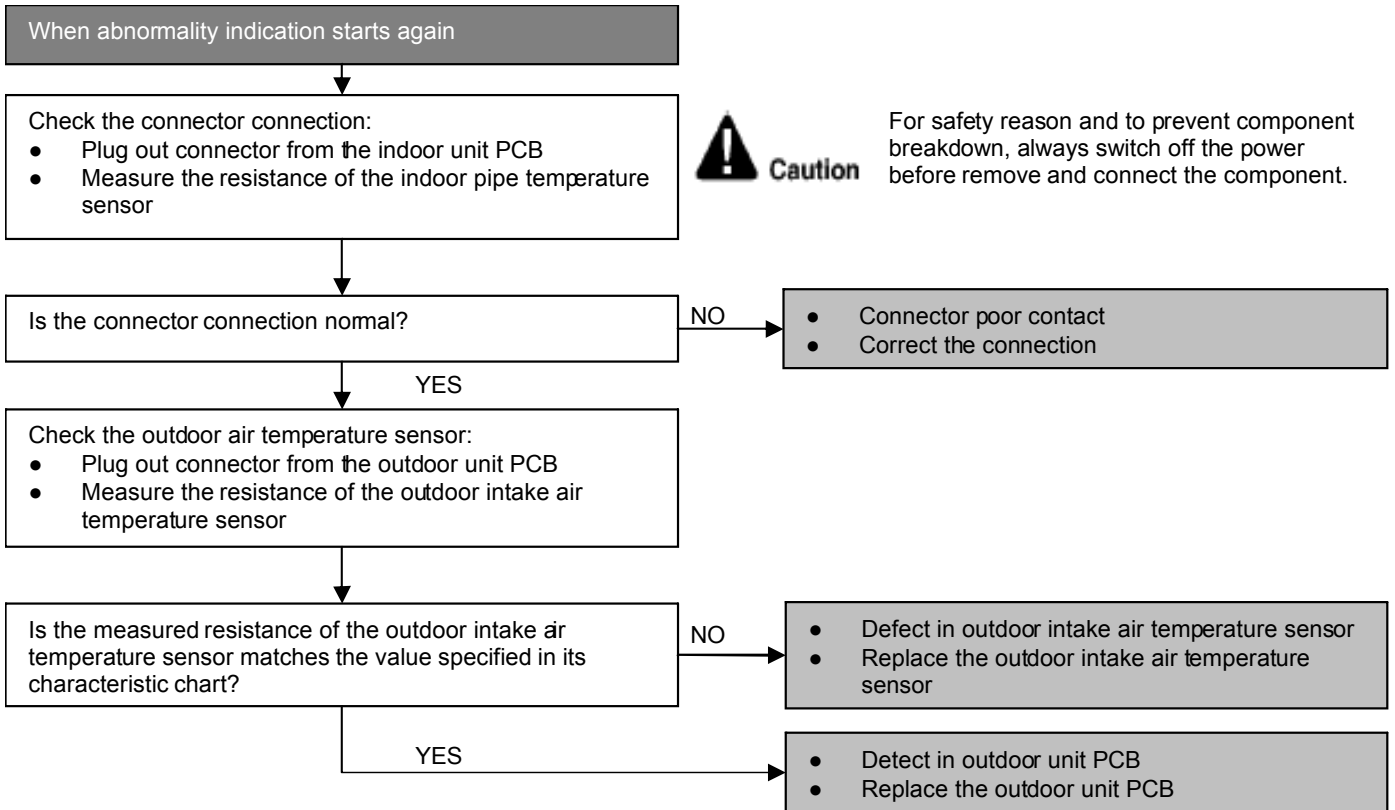

## 15.4.9 H27 (Outdoor Air Temperature Sensor Abnormality)

### Malfunction Decision Conditions

- During startup and operation of cooling and heating, the temperatures detected by the outdoor air temperature sensor are used to determine sensor errors.

### Malfunction Caused

- Faulty connector connection.
- Faulty sensor.
- Faulty PCB.

### Troubleshooting

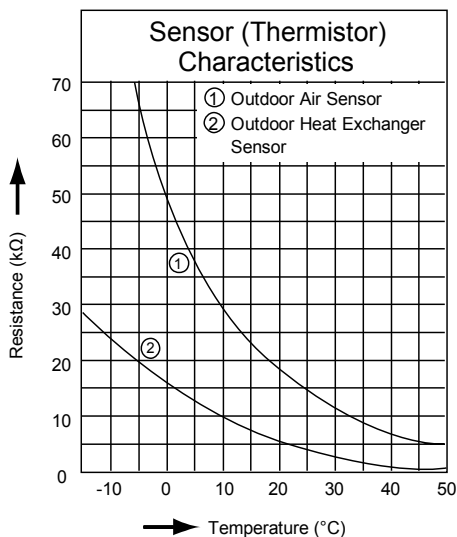
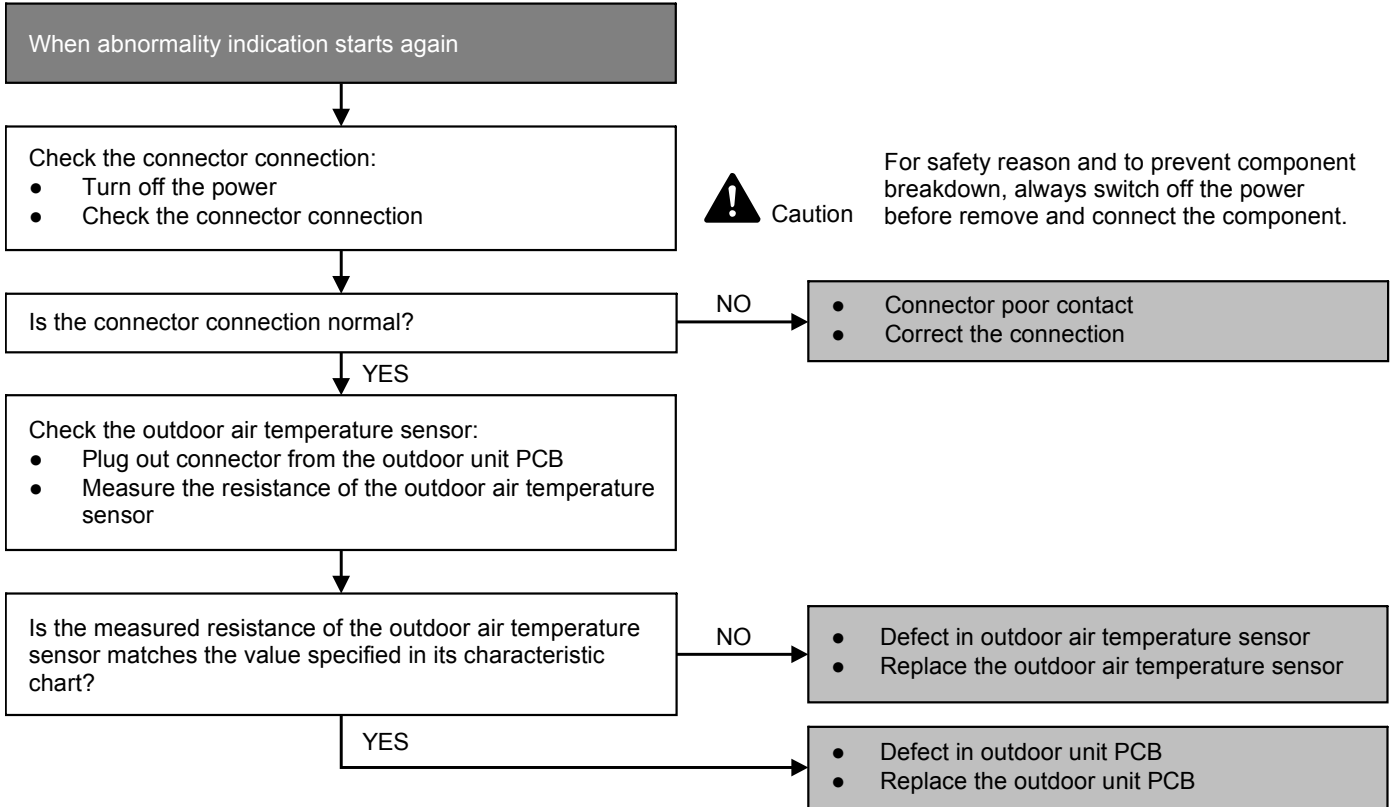

## 15.4.10 H28 (Outdoor Pipe Temperature Sensor Abnormality)

### Malfunction Decision Conditions

- During startup and operation of cooling and heating, the temperatures detected by the outdoor pipe temperature sensor are used to determine sensor errors.

### Malfunction Caused

- Faulty connector connection.
- Faulty sensor.
- Faulty PCB.

### Troubleshooting

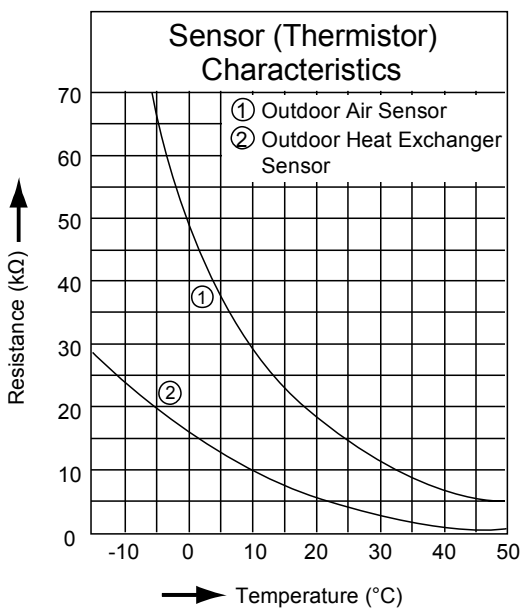
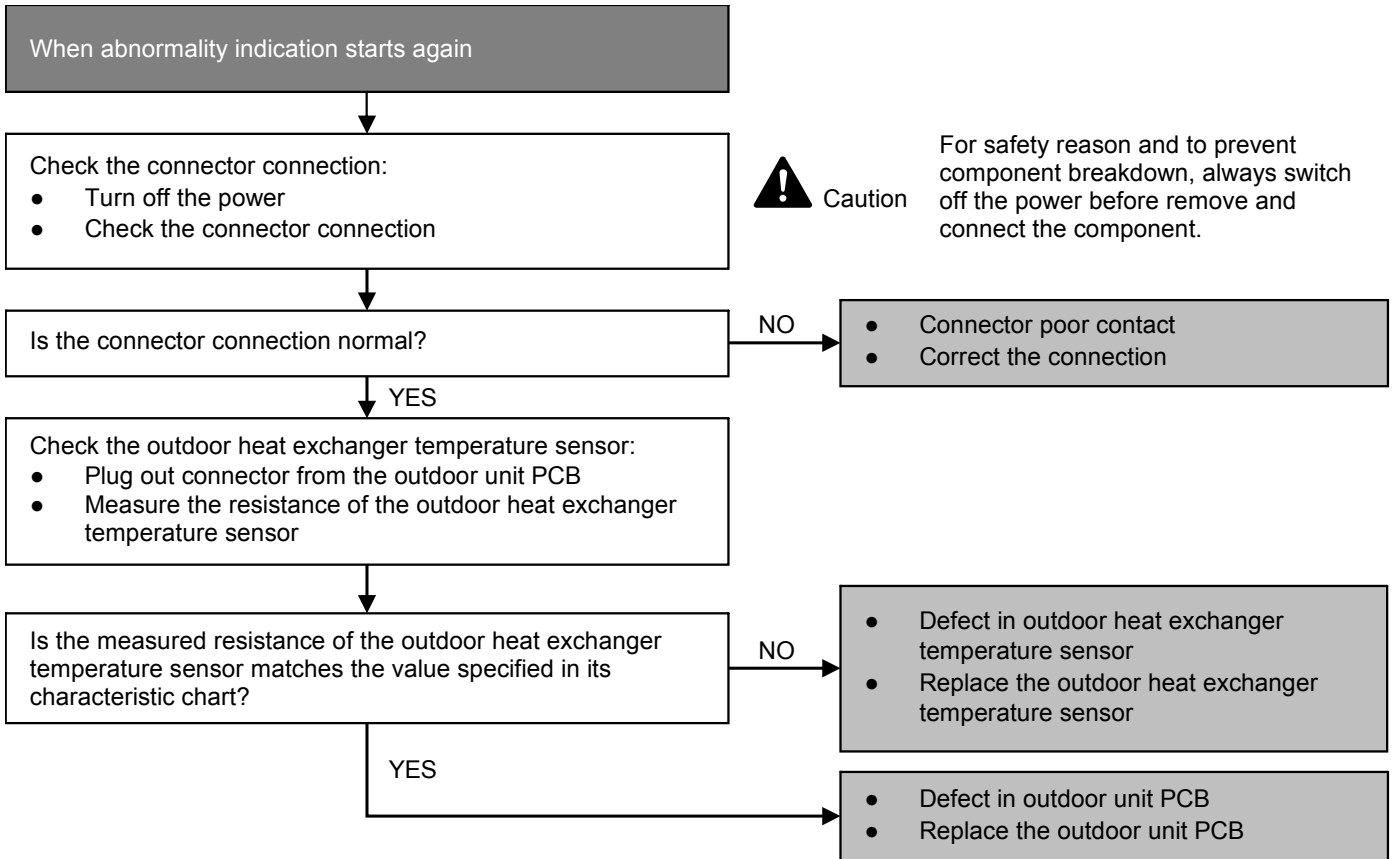

## 15.4.11 H30 (Compressor Discharge Temperature Sensor Abnormality)

### Malfunction Decision Conditions

- During startup and operation of cooling and heating, the temperatures detected by the outdoor discharge pipe temperature sensor are used to determine sensor errors.

### Malfunction Caused

- Faulty connector connection.
- Faulty sensor.
- Faulty PCB.

### Troubleshooting

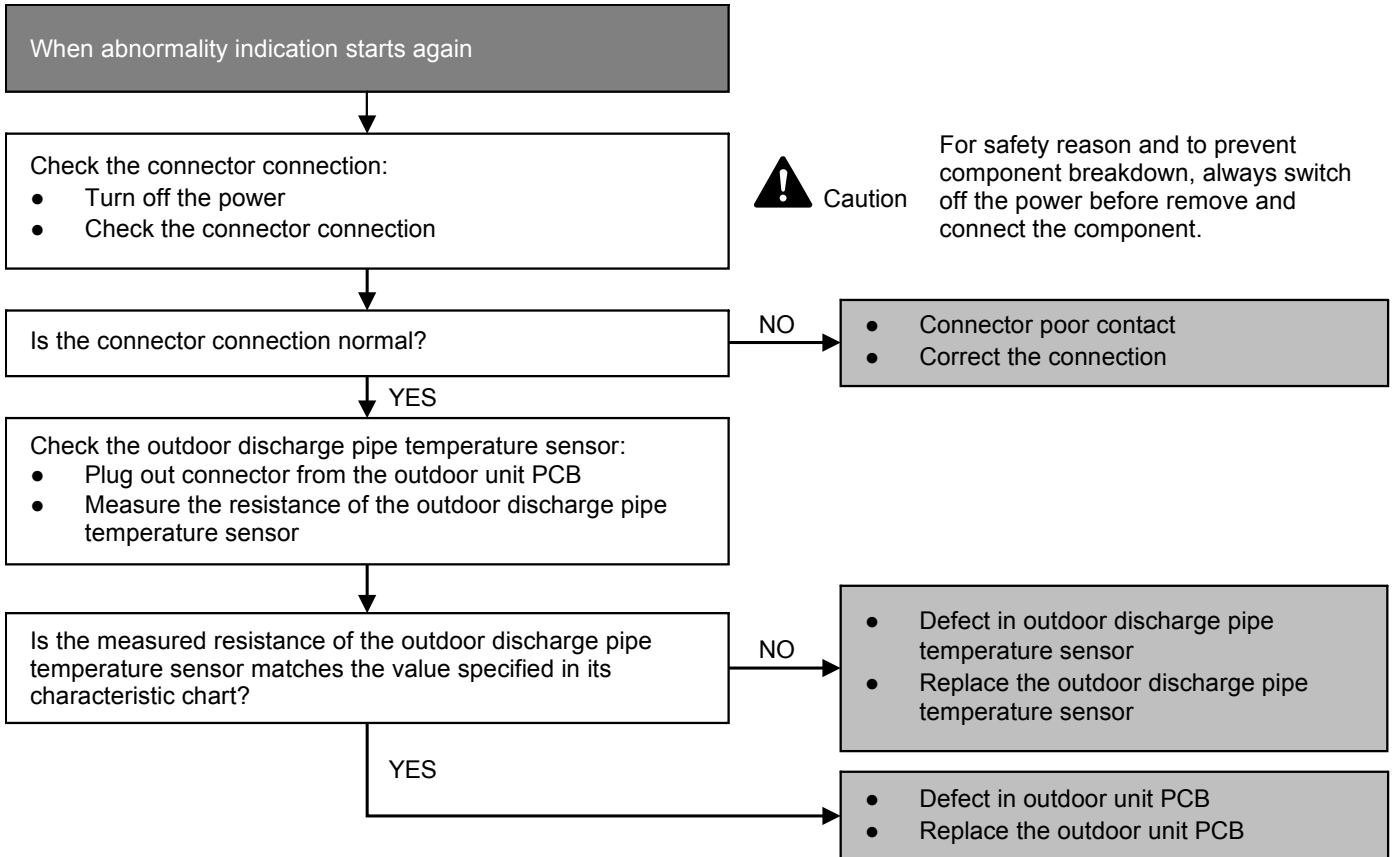

### 15.4.12 H33 (Unspecified Voltage between Indoor and Outdoor)

#### Malfunction Decision Conditions

- The supply power is detected for its requirement by the indoor/outdoor transmission.

#### Malfunction Caused

- Wrong models interconnected.
- Wrong indoor unit and outdoor unit PCBs used.
- Indoor unit or outdoor unit PCB defective.

#### Troubleshooting

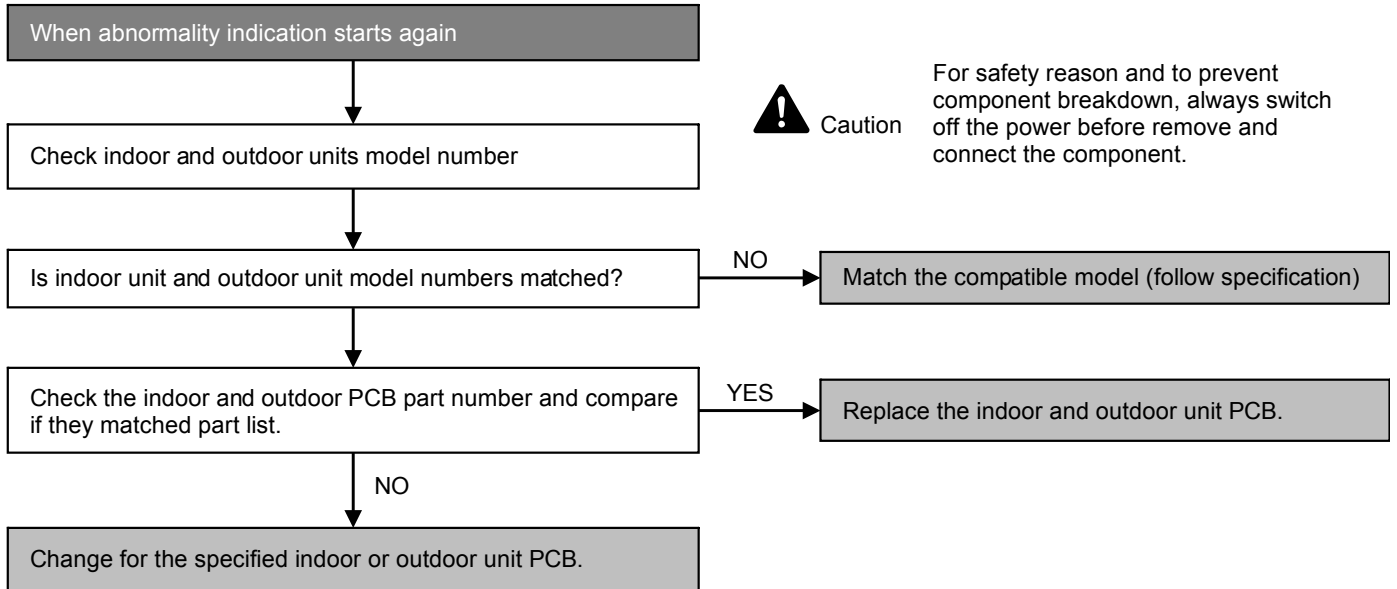

### 15.4.13 H97 (Outdoor Fan Motor – DC Motor Mechanism Locked)

#### Malfunction Decision Conditions

- The rotation speed detected by the Hall IC during fan motor operation is used to determine abnormal fan motor.

#### Malfunction Caused

- Operation stops due to short circuit inside the fan motor winding.
- Operation stops due to breaking of wire inside the fan motor.
- Operation stops due to breaking of fan motor lead wires.
- Operation stops due to Hall IC malfunction.
- Operation error due to faulty outdoor unit PCB.

#### Troubleshooting

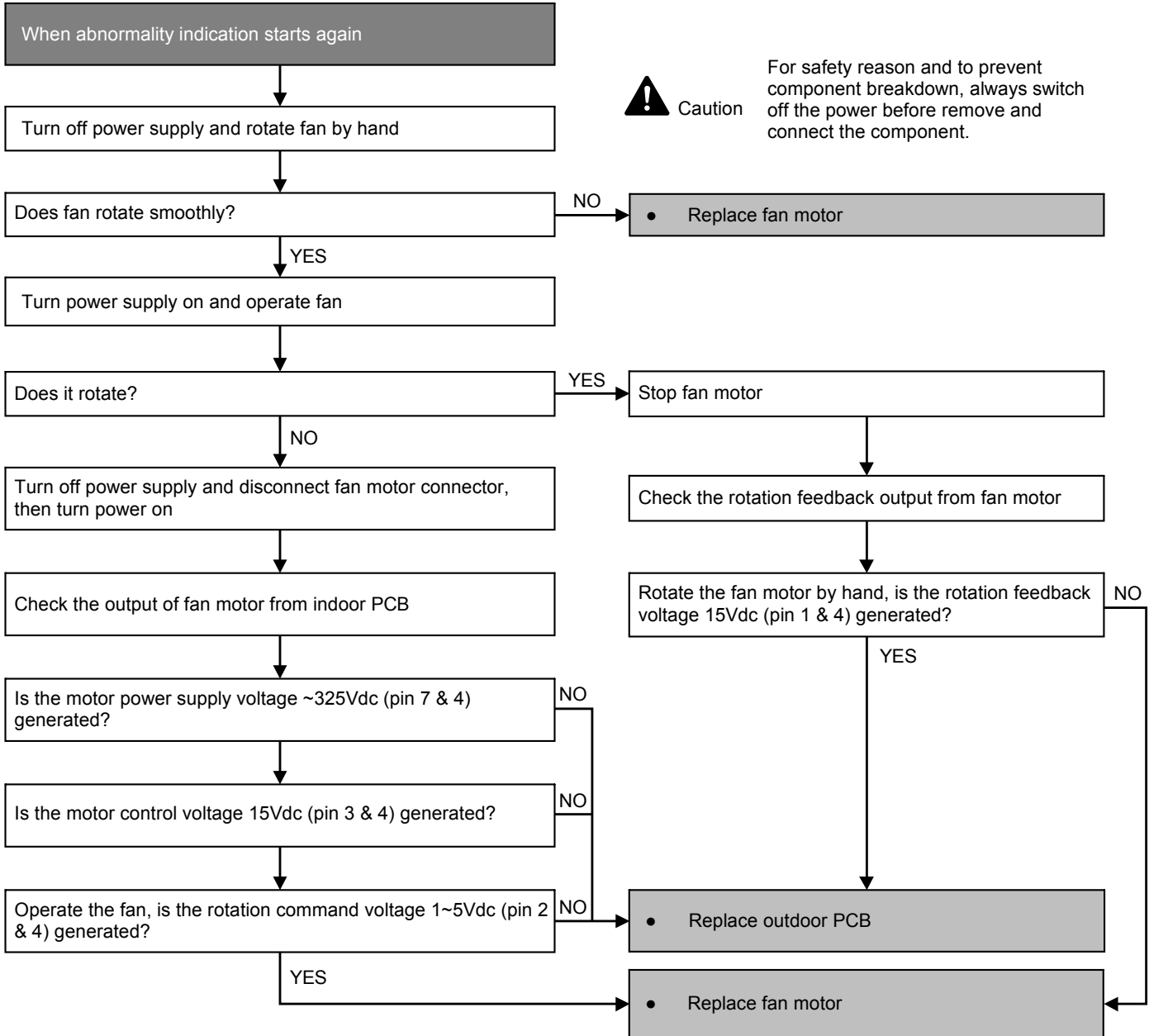



### 15.4.14 H98 (Error Code Stored in Memory and no alarm is triggered / no TIMER LED flashing)

#### Malfunction Decision Conditions

- Indoor high pressure is detected when indoor heat exchanger is detecting very high temperature when the unit is operating in heating operation.
- Phenomena: unit is stopping and re-starting very often in heating mode.

#### Malfunction Caused

- Indoor heat exchanger thermistor
- Clogged air filter or heat exchanger
- Over-bent pipe (liquid side)

#### Troubleshooting

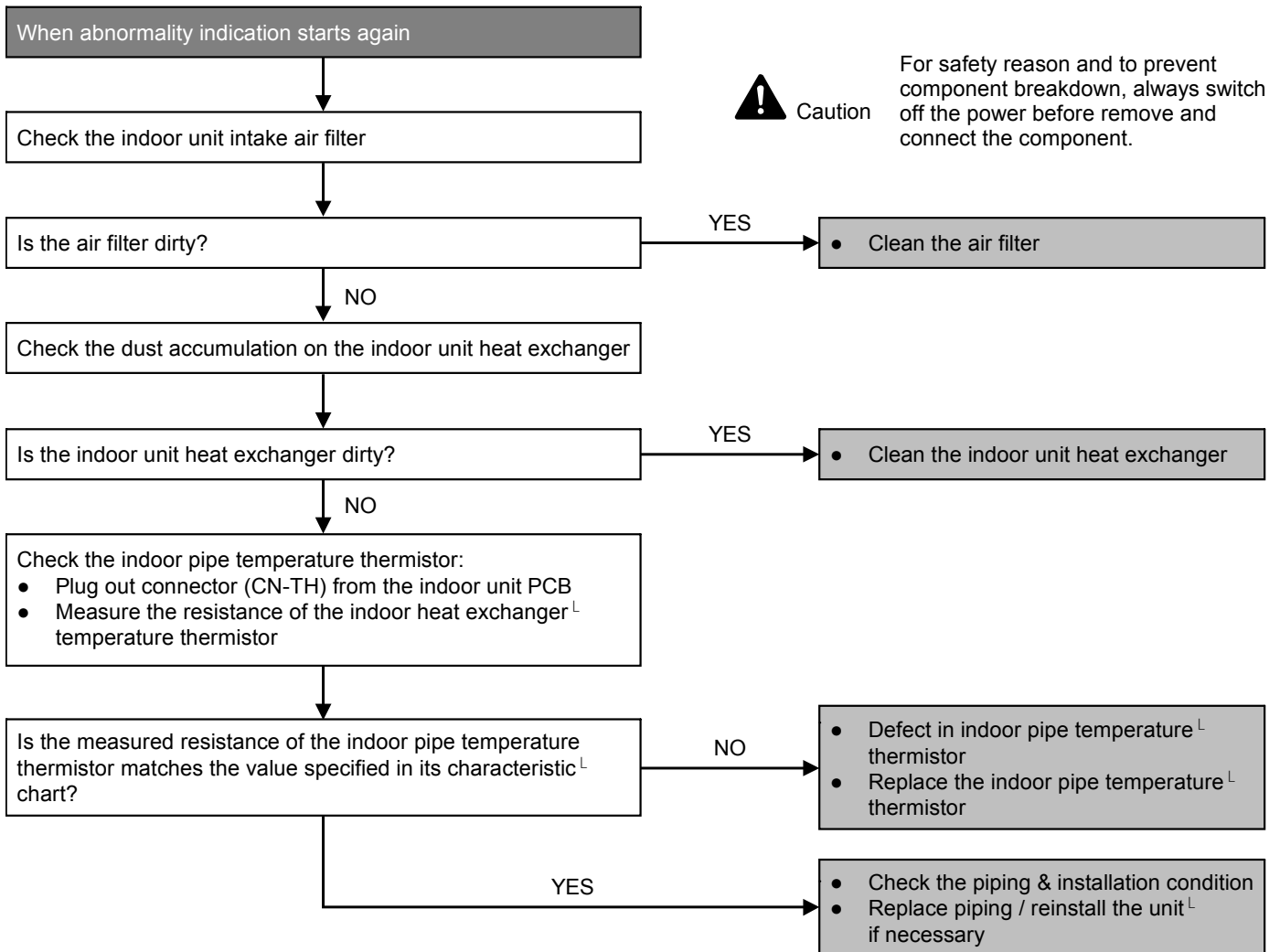

## 15.4.15 H99 (Indoor Freeze Prevention Protection: Cooling or Soft Dry)

Error Code will not display (no Timer LED blinking) but store in EEPROM

### Malfunction Decision Conditions

- Freeze prevention control takes place (when indoor pipe temperature is lower than 2°C)

### Malfunction Caused

- Air short circuit at indoor unit
- Clogged indoor unit air filter
- Dust accumulation on the indoor unit heat exchanger
- 2/3 way valve closed
- Faulty indoor unit fan motor
- Refrigerant shortage (refrigerant leakage)
- Clogged expansion valve or strainer
- Faulty indoor pipe temperature sensor
- Faulty indoor unit PCB

### Troubleshooting

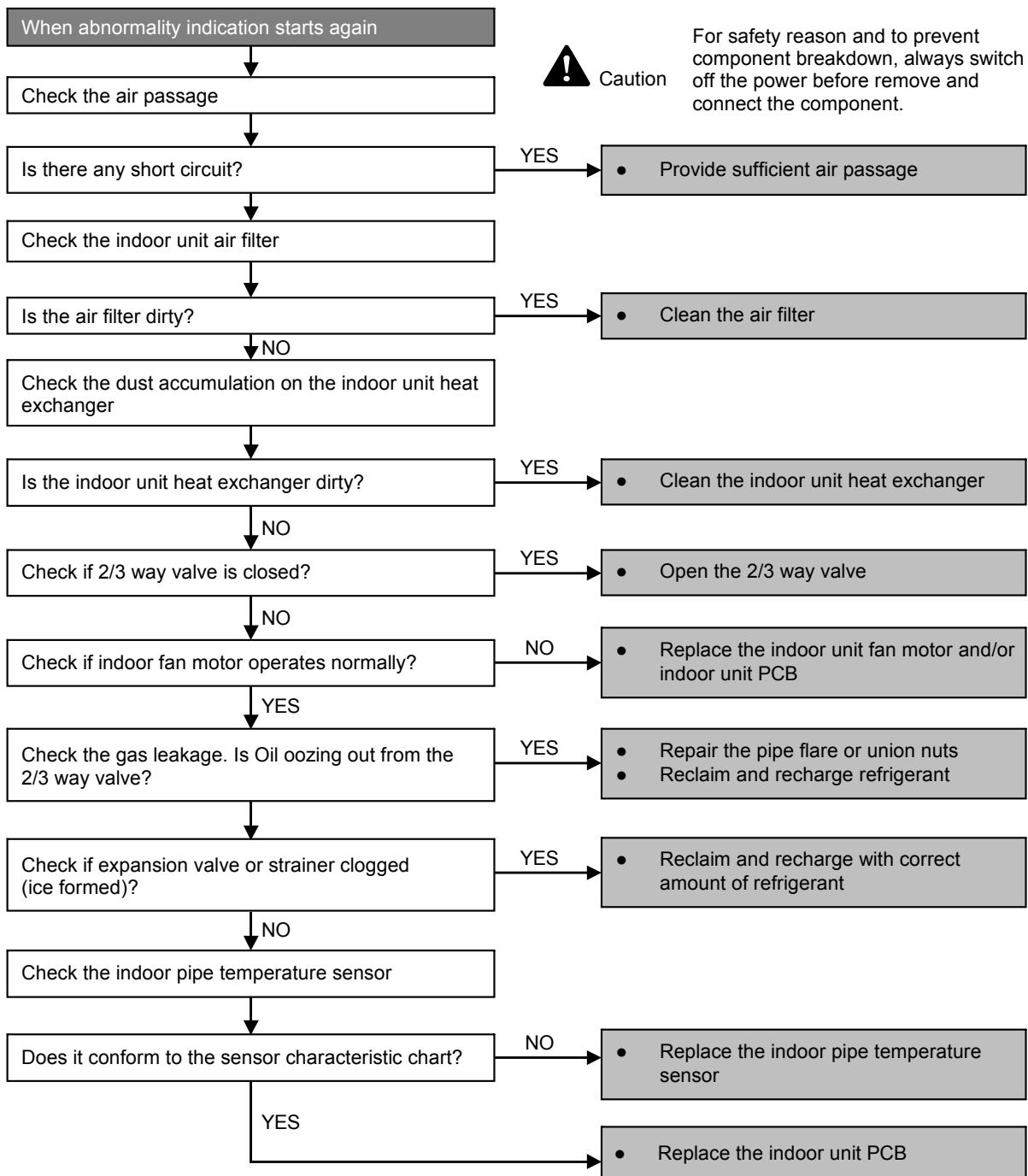

## 15.4.16 F11 (4-way Valve Switching Failure)

### Malfunction Decision Conditions

- When indoor heat exchanger is cold during heating (except deice) or when indoor heat exchanger is hot during cooling and compressor operating, the 4-way valve is detected as malfunction.

### Malfunction Caused

- Indoor heat exchanger (pipe) thermistor
- 4-way valve malfunction

### Troubleshooting

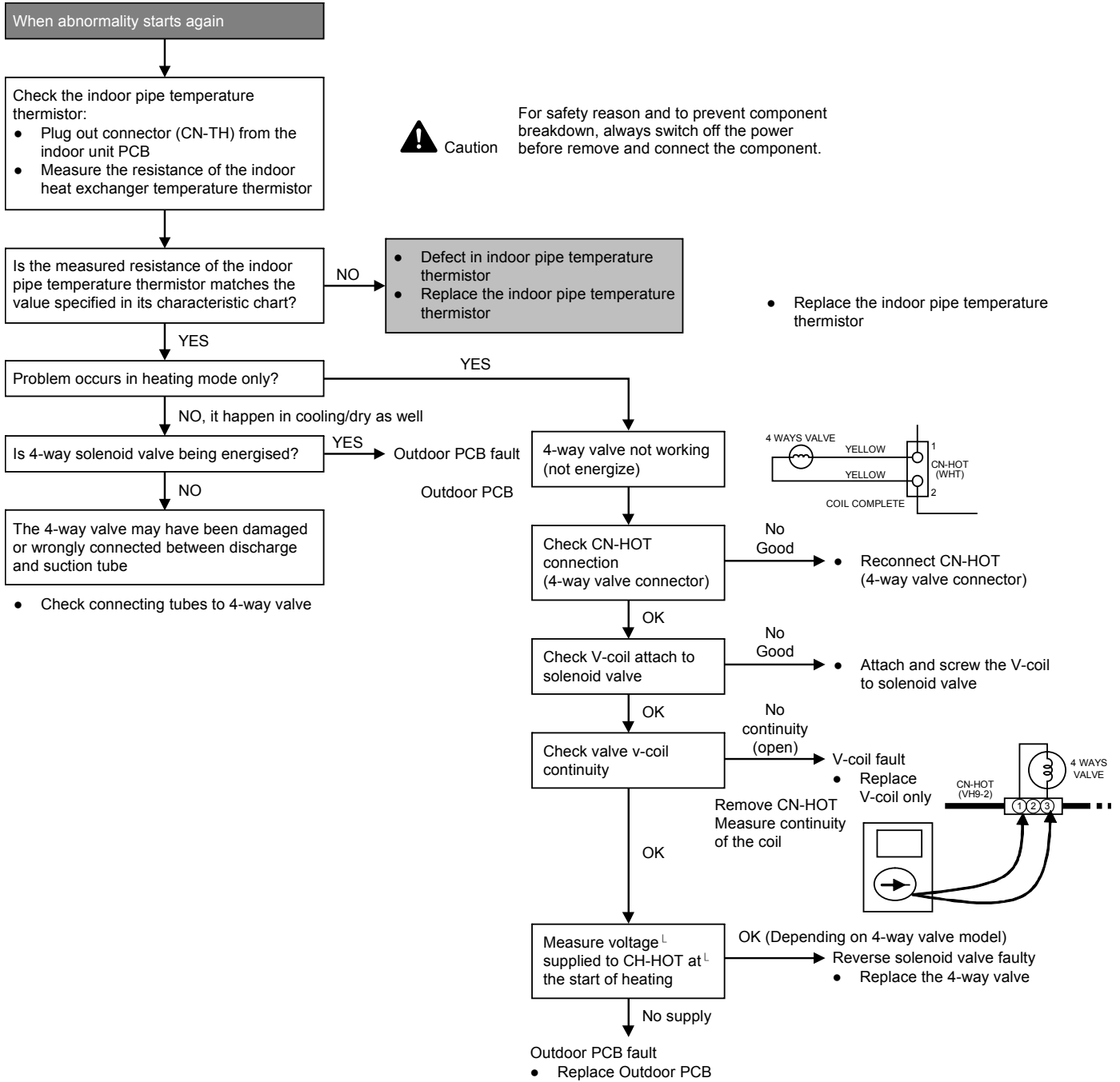

\* Check gas side pipe – for hot gas flow in cooling mode

## 15.4.17 F90 (Power Factor Correction Protection)

### Malfunction Decision Conditions

- To maintain DC voltage level supply to power transistor.
- To detect high DC voltage level after rectification.

### Malfunction Caused

- During startup and operation of cooling and heating, when Power Factor Correction (PFC) protection circuitry at the outdoor unit main PCB senses abnormal DC voltage level for power transistors.
- When DC voltage detected is LOW, transistor switching will turn ON by controller to push-up the DC level.
- When DC voltage detected is HIGH (391Vdc – 425Vdc), active LOW signal will send by the controller to turn OFF relay RY-C.

### Troubleshooting

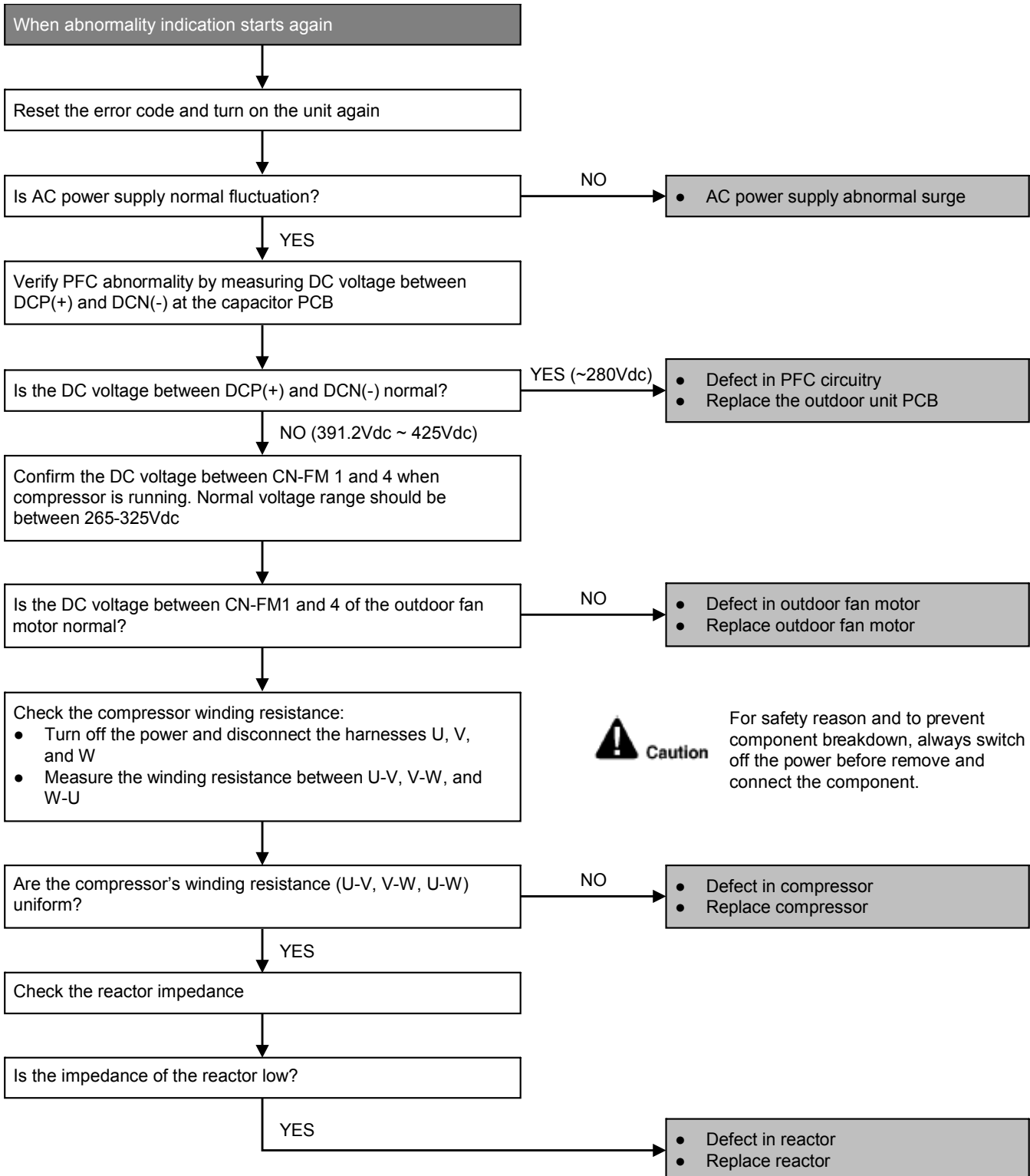

### 15.4.18 F91 (Refrigeration Cycle Abnormality)

#### Malfunction Decision Conditions

- The input current is low while the compressor is running at higher than the setting frequency.

#### Malfunction Caused

- Lack of gas.
- 3-way valve close.

#### Troubleshooting

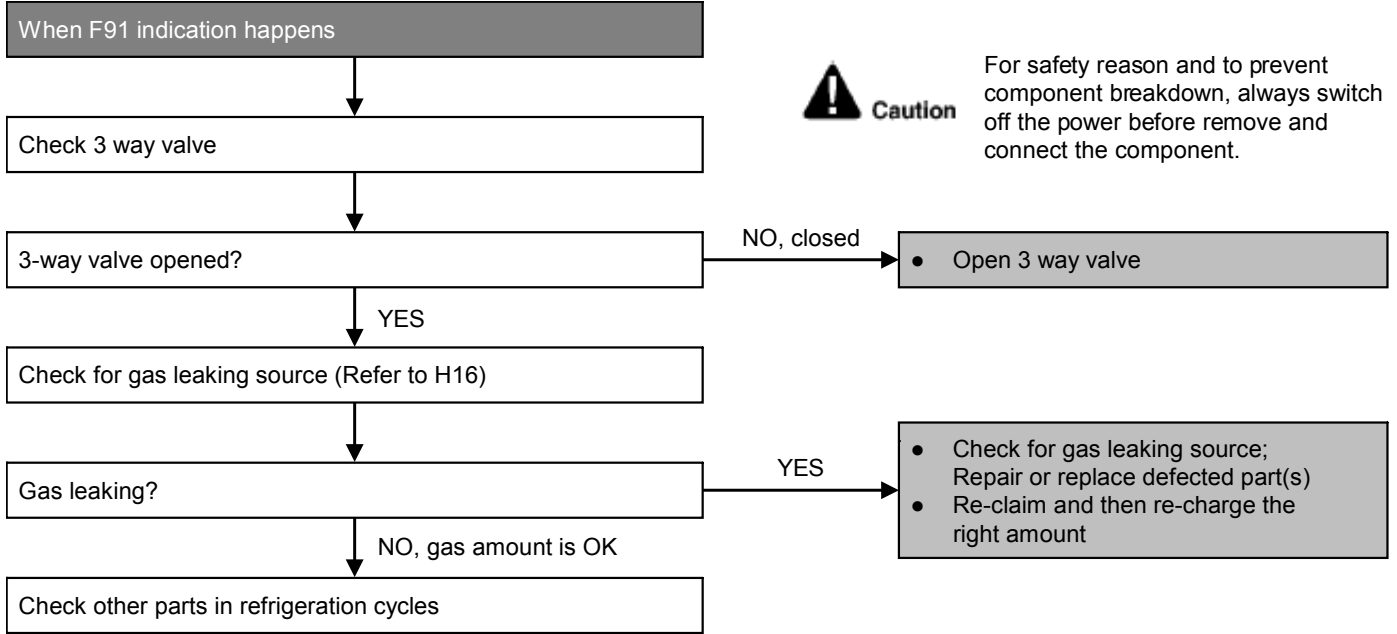

## 15.4.19 F93 (Compressor Rotation Failure)

### Malfunction Decision Conditions

- A compressor rotation failure is detected by checking the compressor running condition through the position detection circuit.

### Malfunction Caused

- Compressor terminal disconnect
- Faulty Outdoor PCB
- Faulty compressor

### Troubleshooting

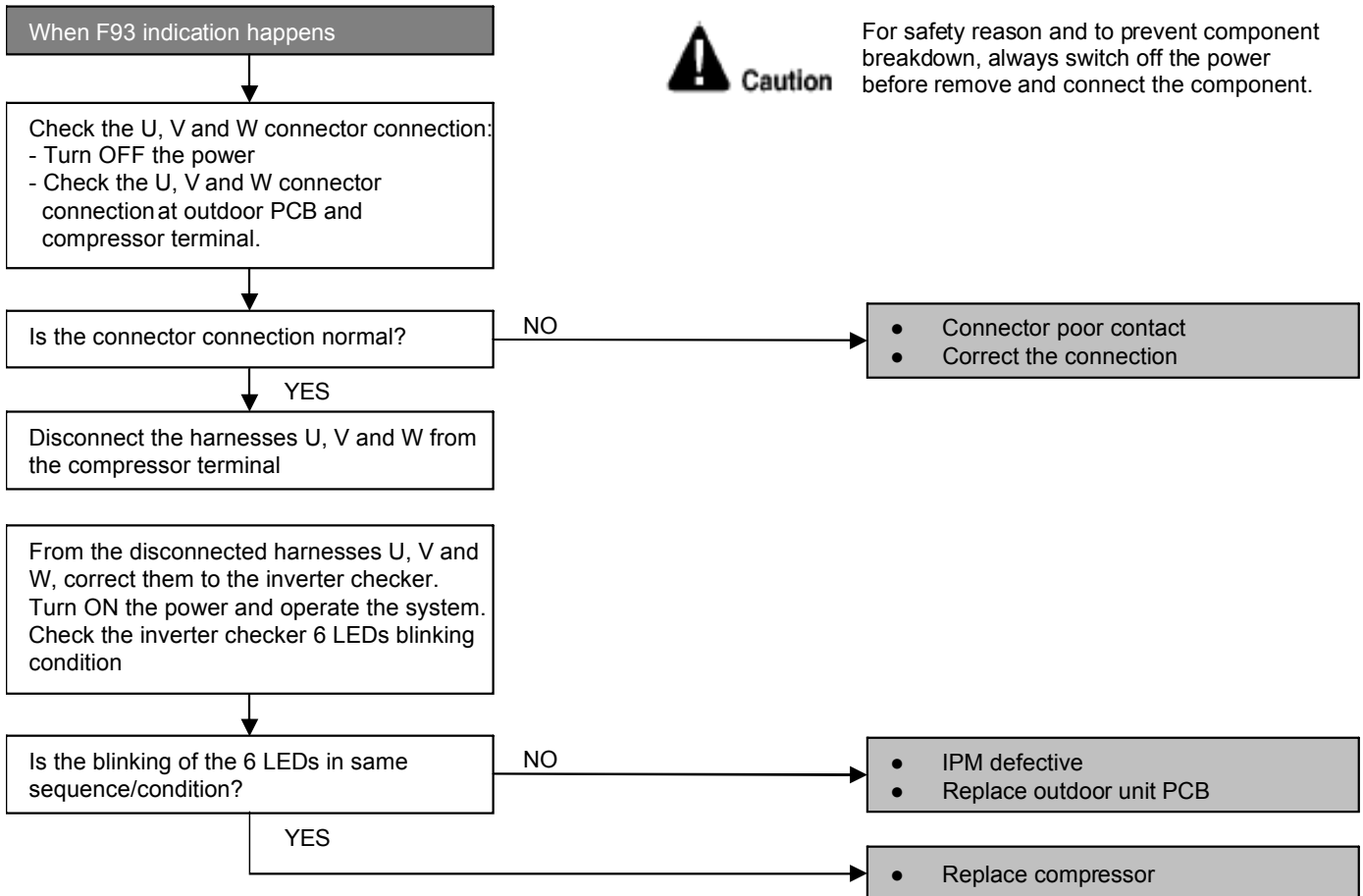

## 15.4.20 F95 (Outdoor High Pressure Protection: Cooling or Soft Dry)

### Malfunction Decision Conditions

- During operation of cooling or soft dry, when outdoor unit heat exchanger high temperature data is detected by the outdoor unit heat exchanger thermistor.

### Malfunction Caused

- Outdoor heat exchanger temperature rise due to short-circuit of hot discharge air flow.
- Outdoor heat exchanger temperature rise due to defective of outdoor fan motor.
- Outdoor heat exchange temperature rise due to defective outdoor heat exchanger thermistor.
- Outdoor heat exchanger temperature rise due to defective of outdoor unit PCB.

### Troubleshooting

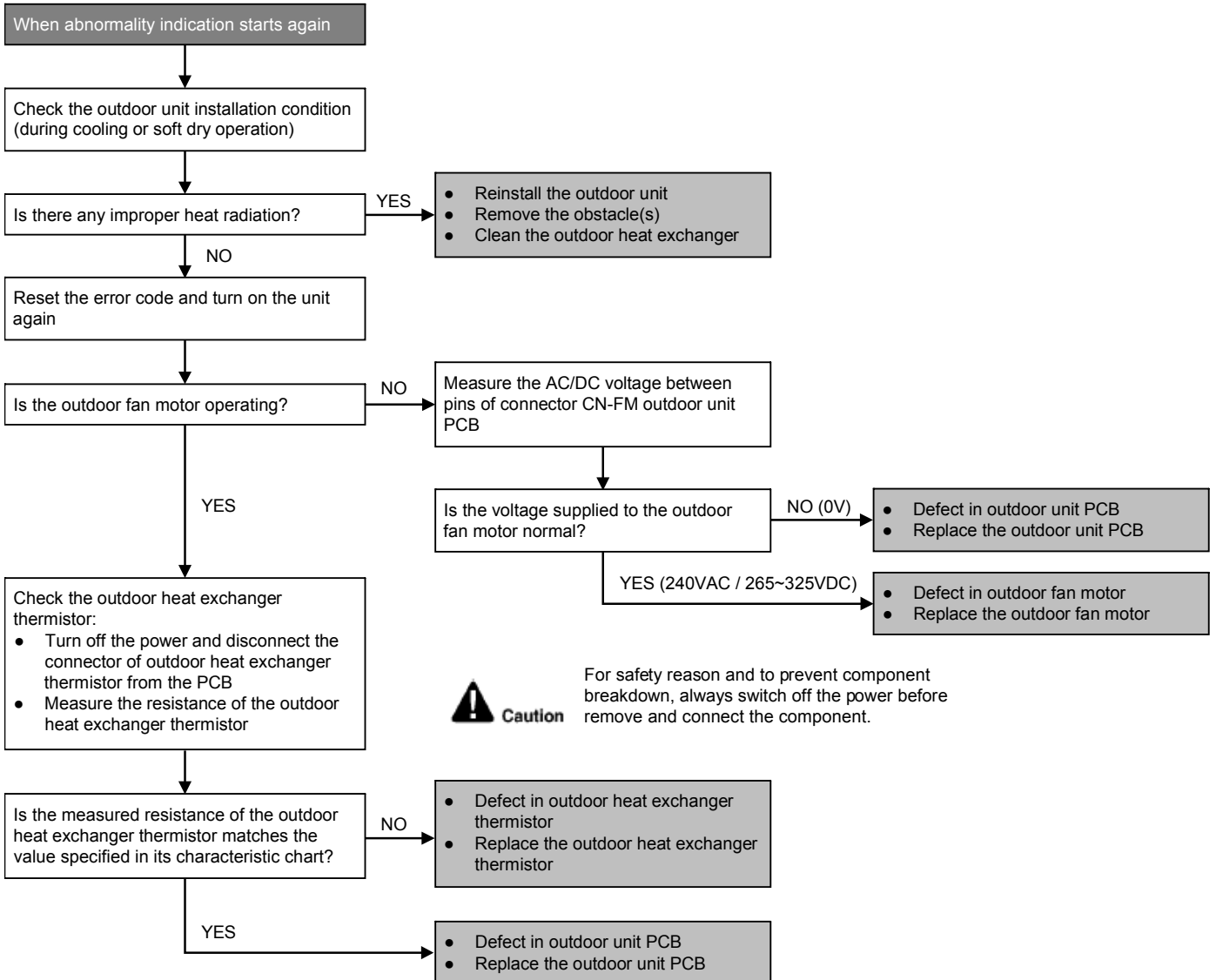

## 15.4.21 F96 (IPM Overheating)

### Malfunction Decision Conditions

- During operating of cooling and heating, when IPM temperature data (100°C) is detected by the IPM temperature sensor.

#### *Multi Models only*

- Compressor Overheating: During operation of cooling and heating, when the compressor OL is activated.
- Heat Sink Overheating: During operation of cooling and heating, when heat sink temperature data (90°C) is detected by the heat sink temperature sensor.

### Malfunction Caused

- IPM overheats due to short circuit of hot discharge air flow.
- IPM overheats due to defective of outdoor fan motor.
- IPM overheats due to defective of internal circuitry of IPM.
- IPM overheats due to defective IPM temperature sensor.

#### *Multi Models Only*

- Compressor OL connector poor contact.
- Compressor OL faulty.

### Troubleshooting

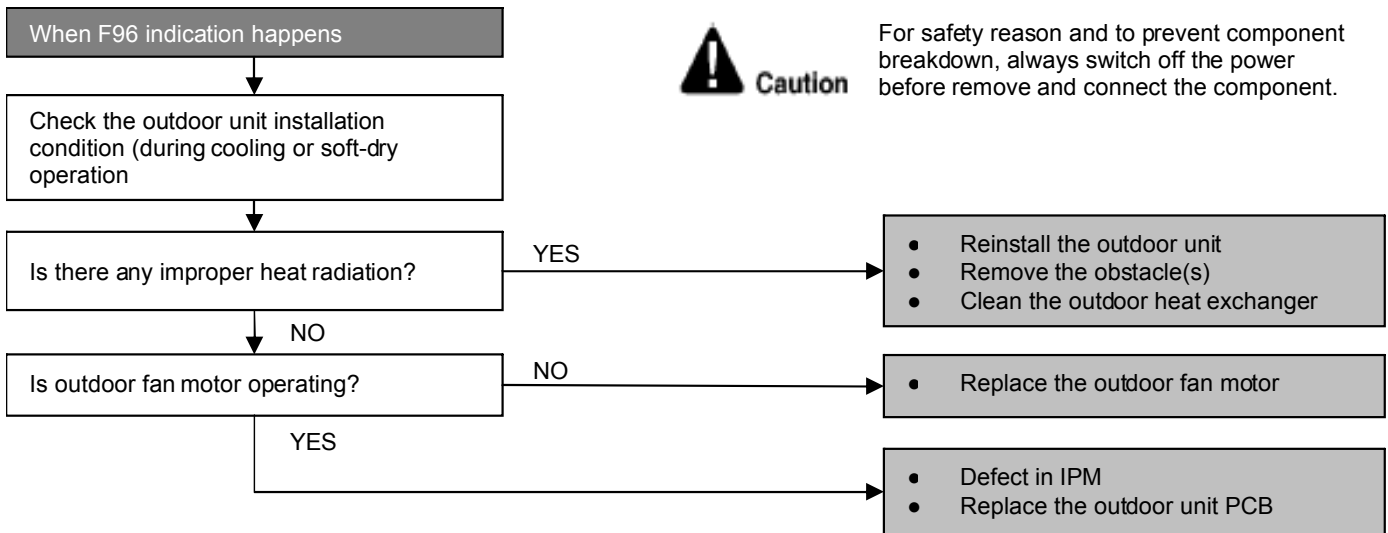



## 15.4.22 F97 (Compressor Overheating)

### Malfunction Decision Conditions

- During operation of cooling and heating, when compressor tank temperature data (112°C) is detected by the compressor tank temperature sensor.

### Malfunction Caused

- Faulty compressor tank temperature sensor
- 2/3 way valve closed
- Refrigerant shortage (refrigerant leakage)
- Faulty outdoor unit PCB
- Faulty compressor

### Troubleshooting

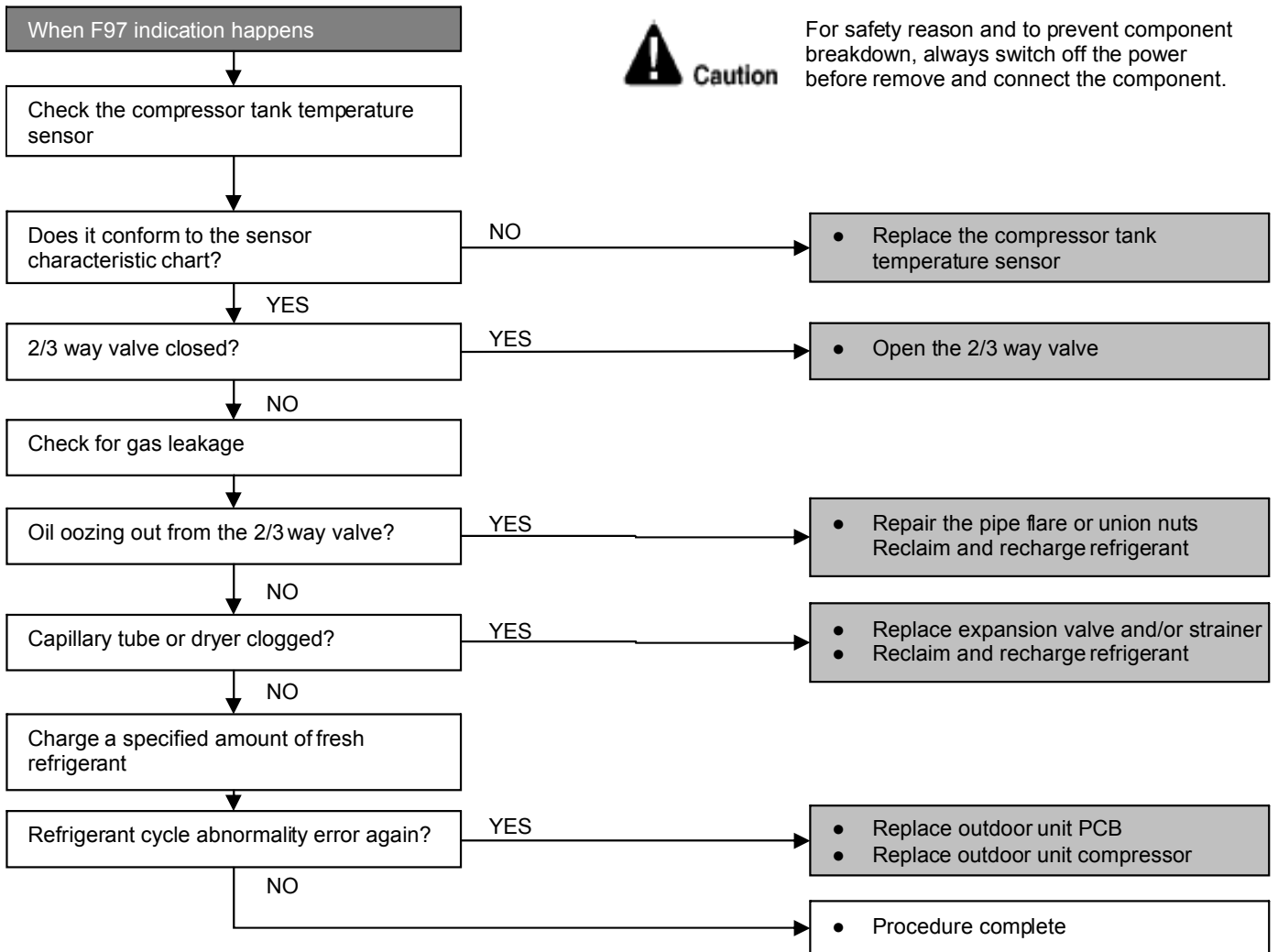

## 15.4.23 F98 (Input Over Current Detection)

### Malfunction Decision Conditions

- During operation of cooling and heating, when an input over-current (X value in Total Running Current Control) is detected by checking the input current value being detected by current transformer (CT) with the compressor running.

### Malfunction Caused

- Excessive refrigerant.
- Faulty outdoor unit PCB.

### Troubleshooting

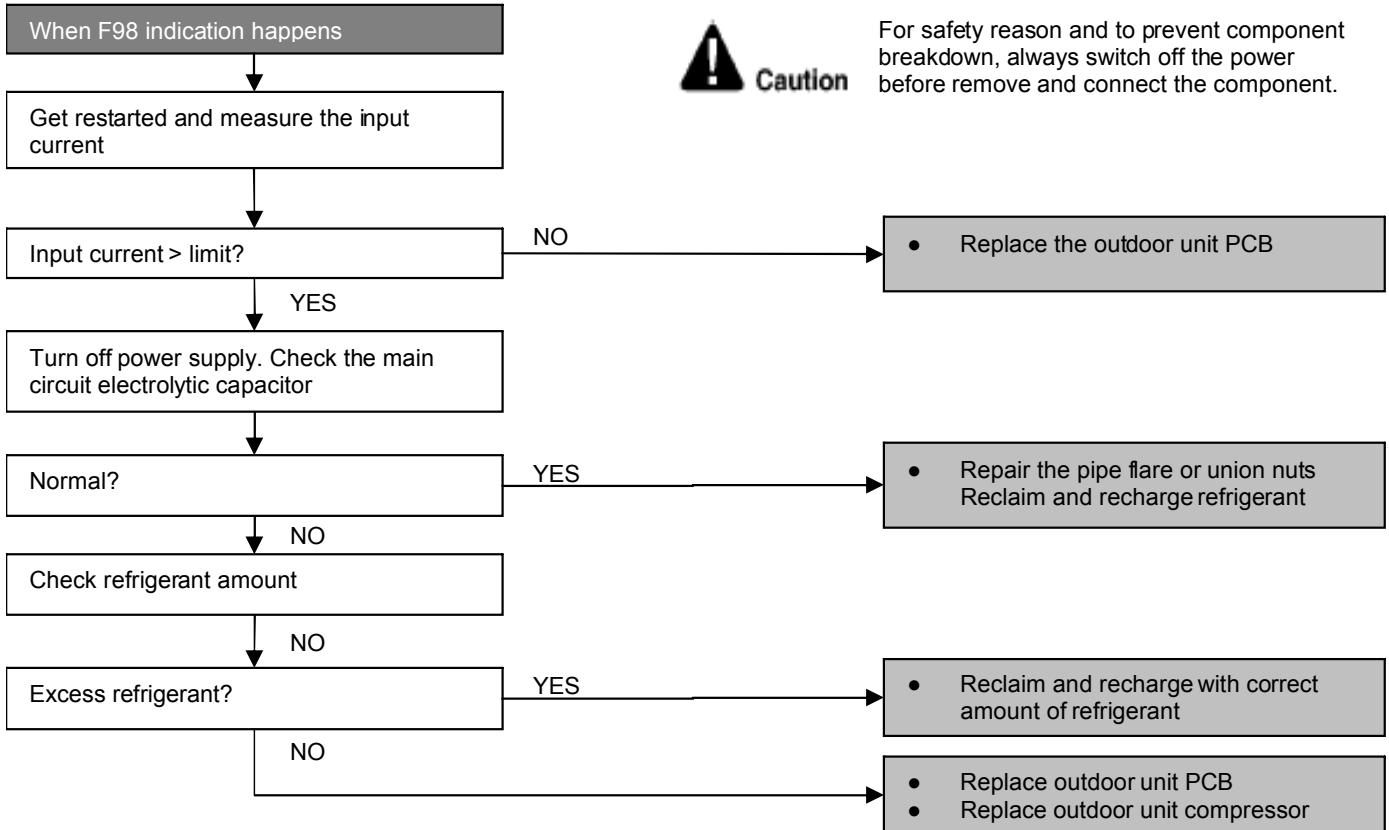

## 15.4.24 F99 (DC Peak Detection)

### Malfunction Decision Conditions

During startup and operation of cooling and heating, when inverter DC peak data is received by the outdoor internal DC Peak sensing circuitry.

### Malfunction Caused

- DC current peak due to compressor failure.
- DC current peak due to defective power transistor(s).
- DC current peak due to defective outdoor unit PCB.
- DC current peak due to short circuit.

### Troubleshooting

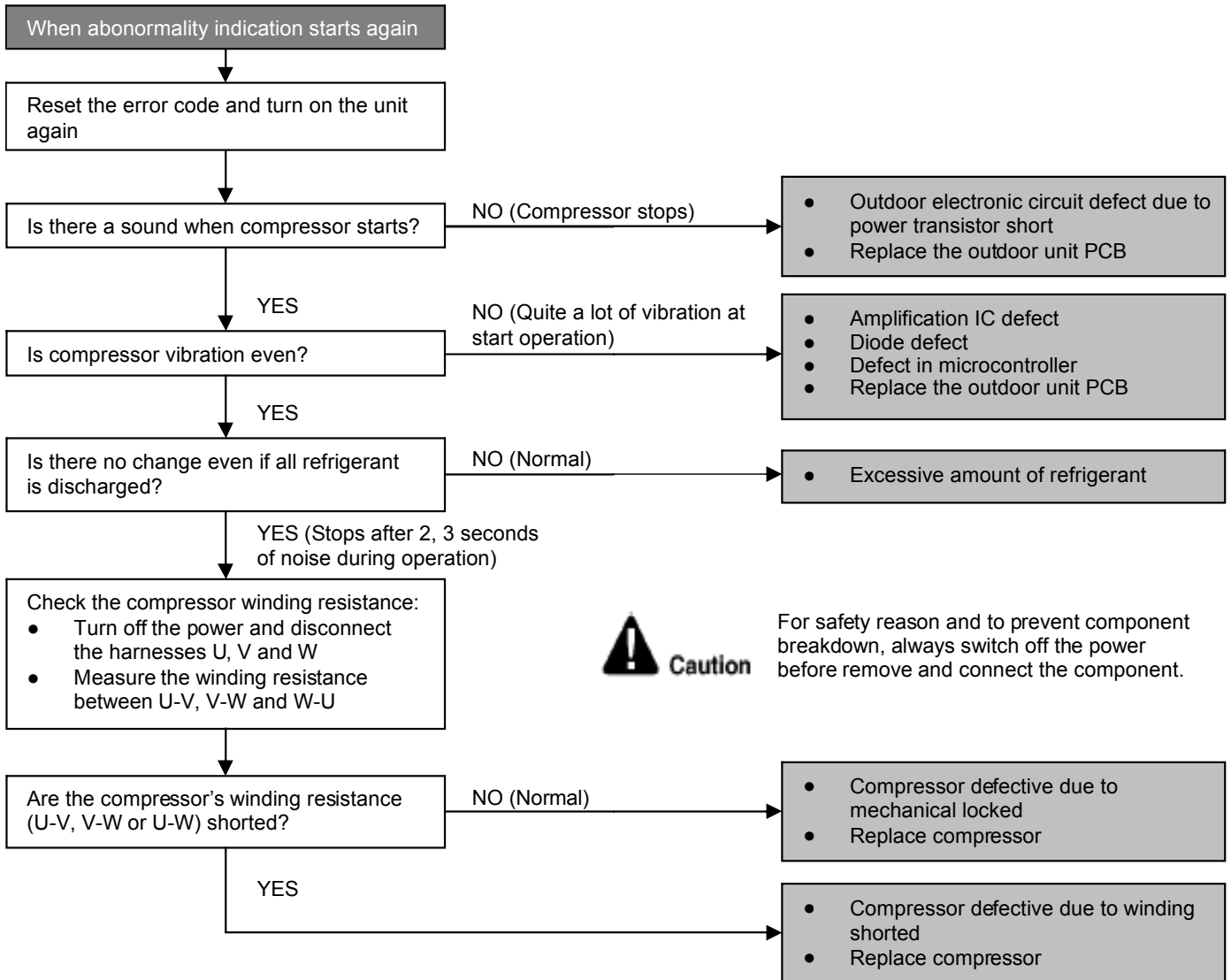

## 16. Disassembly and Assembly Instructions



### WARNING

High Voltage is generated in the electrical parts area by the capacitor. Ensure that the capacitor has discharged sufficiently before proceeding with repair work. Failure to heed this caution may result in electric shocks.

### 16.1 Disassembly of Parts

- 1 Open the Intake Grille from the Front Grille by moving the catchers to center (Fig.1).

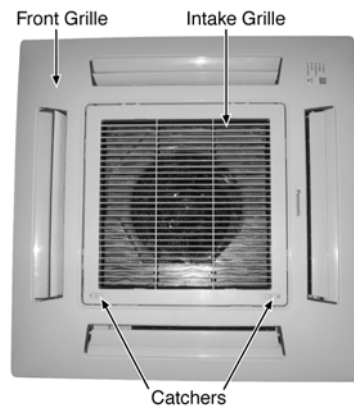

Fig. 1

- 2 Remove the Control Board Cover by removing the screws (Fig. 2).

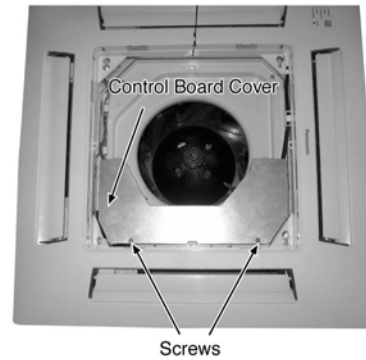

Fig. 2

- 3 Release the (Fig. 3):
  - CN-STM1 (WHT) connector.
  - CN-STM2 (YLW) connector.
  - CN-DISP (WHT) connector.
  - CN-FM (WHT) connector.
  - CN-TH1 (WHT) connector.
  - CN-TH2 (BLU) connector.
  - CN-DRMTR1 (BLU) connector.
  - AC01 (BLK), AC02 (WHT) and CN-DRMTR2 (RED) from Terminal Board.
  - G01 (GRN) screw.
  - Two T-BLK connectors.
  - CN-T1 (WHT).
  - CN-T2 (YLW).

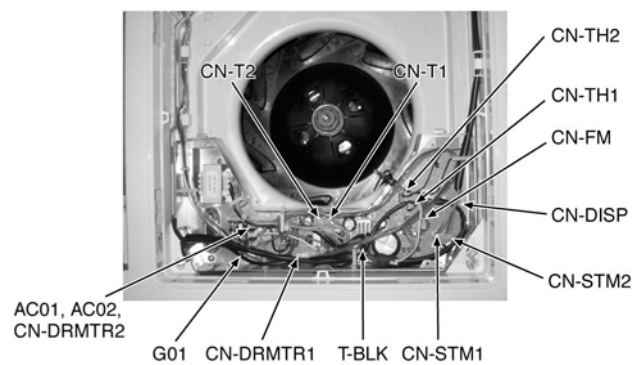

Fig. 3

- 4 To remove the Electronic Controller, release the 6 hooks that hold it to the Control Board (Fig. 4).

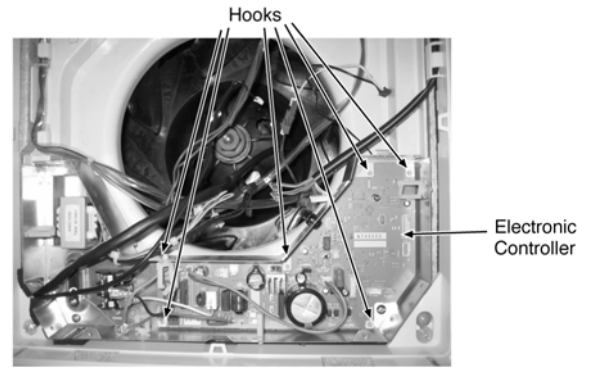

Fig. 4

- 5 Remove the Front Grille by removing the screw A and screws B, C & D half way open (Fig. 5).

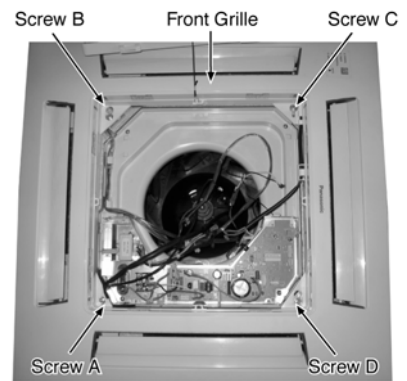

Fig. 5

- 6 Remove the Air Guider and Drain Pan complete by removing the screws (Fig. 6).

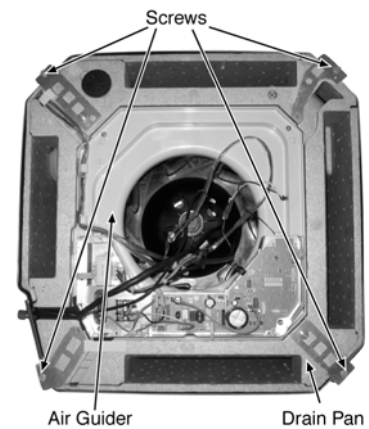

Fig. 6

- 7 Remove the Turbo Fan by removing the bolt (Fig. 7).

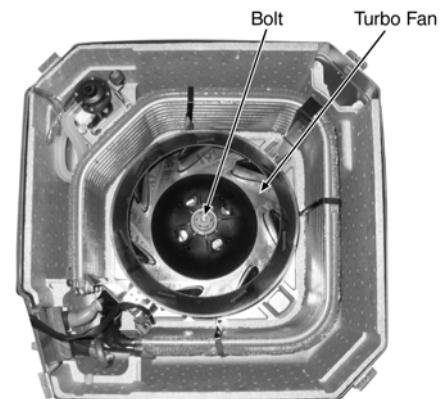

Fig. 7

- 8 Remove the Fan Motor by release the Fan Motor lead wire connectors and Fan Motor screws (Fig. 8).

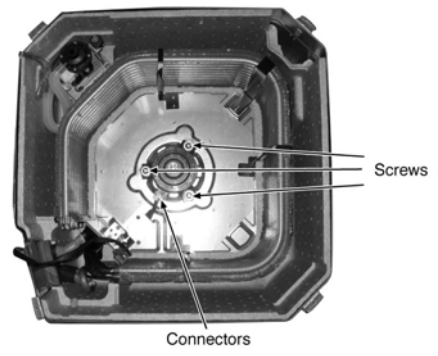

Fig. 8

## 16.2 Outdoor Electronic Controller Removal Procedure

- 1 Remove the 4 screws of the Top Panel.

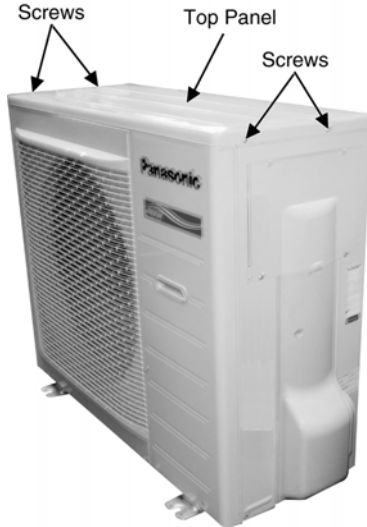

Fig. 1

- 2 Remove the 10 screws of the Front Panel.

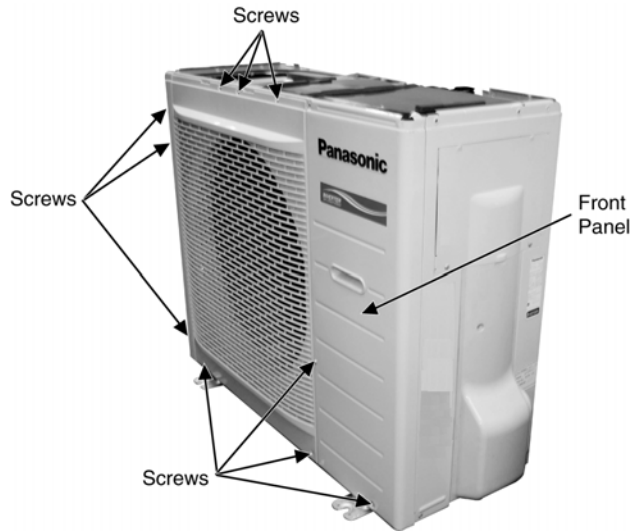

Fig. 2

- 3 Remove the Top Cover of the Electronic Controller.



Fig. 3

- 4 Remove the Control Board.

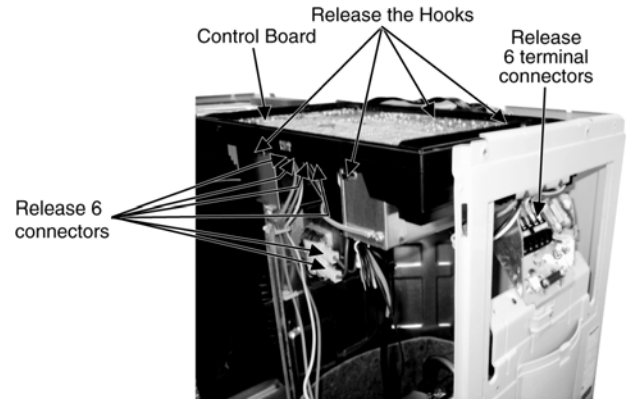

Fig. 4

- 5 Remove the 8 screws of the Electronic Controller.

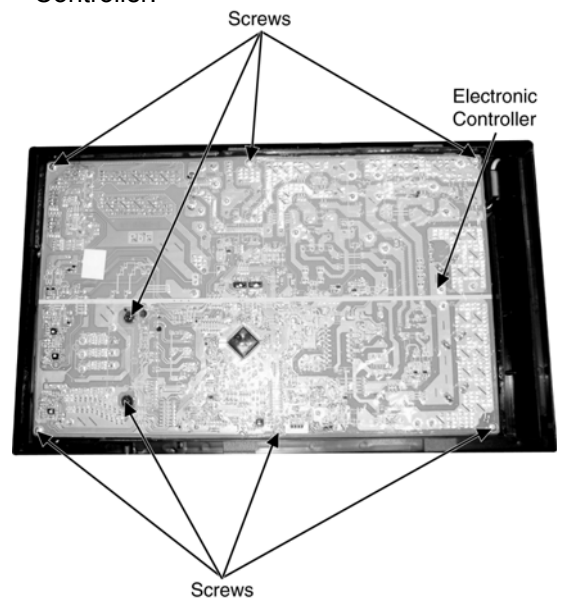

Fig. 5

**⚠ Caution!** When handling electronic controller, be careful of electrostatic discharge.

## 17. Technical Data

Technical data provided are based on the air conditioner running under free frequency.

### 17.1 Cool Mode Performance Data

Unit setting: Standard piping length, Hi Fan, Cool mode at 16°C

Voltage: 220/230V

#### 17.1.1 CS-E18RB4EAW CU-E18RBEA

Indoor (°C)		Outdoor DB (°C)											
DB	WB	-10			-7			0			5		
		TC	SHC	IP	TC	SHC	IP	TC	SHC	IP	TC	SHC	IP
27	19.0	6195	3200	1241	5800	4063	1130	5741	4041	1138	5809	4214	1094
	22.0	6281	3231	1104	6214	3152	1212	6284	3211	1187	6392	3259	1113
23	15.7	5207	4038	1165	4981	3899	1268	5126	3987	1198	4947	3906	1311
	18.4	4771	2936	752	5585	3225	1241	5637	3272	1225	5803	3337	1133
20	13.3	4003	3441	598	4017	3501	765	3777	3396	873	4035	3515	770
	15.8	4917	3082	1320	4966	2868	1386	5155	3169	1216	4951	3071	1304

Indoor (°C)		Outdoor DB (°C)								
DB	WB	16			25			35		
		TC	SHC	IP	TC	SHC	IP	TC	SHC	IP
27	19.0	6434	4476	950	5656	3996	1244	5000	3700	1600
	22.0	7095	3602	925	6195	3200	1241	5594	2969	1598
23	15.7	4836	3364	950	4658	3291	1284	4645	3437	1575
	18.4	5481	3217	708	4911	2888	980	4879	2859	1593
20	13.3	4183	3523	664	3415	1983	1228	3363	2488	1490
	15.8	5282	3219	808	4176	2184	1146	4027	2137	1494

(Dry bulb value based on 46% humidity)



### 17.1.2 CS-E21RB4EAW CU-E21RBEA

Indoor (°C)		Outdoor DB (°C)											
DB	WB	-10			-7			0			5		
		TC	SHC	IP	TC	SHC	IP	TC	SHC	IP	TC	SHC	IP
27	19.0	7310	3470	1590	6844	4406	1447	6774	4382	1459	6855	4569	1401
	22.0	7411	3504	1415	7332	3418	1553	7415	3482	1521	7543	3534	1426
23	15.7	6144	4379	1493	5877	4227	1624	6048	4323	1535	5838	4236	1680
	18.4	5629	3184	964	6590	3497	1590	6652	3548	1569	6847	3618	1452
20	13.3	4723	3731	766	4740	3797	980	4456	3682	1118	4761	3812	987
	15.8	5802	3342	1691	5860	3110	1776	6082	3436	1558	5842	3330	1670

Indoor (°C)		Outdoor DB (°C)								
DB	WB	16			25			35		
		TC	SHC	IP	TC	SHC	IP	TC	SHC	IP
27	19.0	7592	4853	1217	6674	4333	1594	5900	4012	2050
	22.0	8372	3906	1185	7310	3470	1590	6601	3219	2048
23	15.7	5706	3648	1217	5496	3568	1599	5481	3727	2018
	18.4	6468	3489	907	5795	3132	1256	5757	3100	2041
20	13.3	4936	3820	851	4030	2151	1574	3968	2698	1910
	15.8	6233	3490	1035	4928	2368	1468	4752	2317	1914

(Dry bulb value based on 46% humidity)

TC - Total Cooling Capacity (W)  
 SHC - Sensible Heat Capacity (W)  
 IP - Input Power (W)

## 17.2 Heat Mode Performance Data

Unit setting: Standard piping length, Hi Fan, Heat mode at 30°C  
Voltage: 220/230V

### 17.2.1 CS-E18RB4EAW CU-E18RBEA

Indoor (°C)	Outdoor WB (°C)									
	-10		-7		2		7		12	
	TC	IP	TC	IP	TC	IP	TC	IP	TC	IP
24	3566	1913	4321	2264	4919	2183	5225	1854	5657	1852
20	3800	1900	4370	2240	5140	2150	5600	1860	6164	1863
16	4053	1881	3932	1980	5169	2103	6025	1864	6583	1859

### 17.2.2 CS-E21RB4EAW CU-E21RBEA

Indoor (°C)	Outdoor WB (°C)									
	-10		-7		2		7		12	
	TC	IP	TC	IP	TC	IP	TC	IP	TC	IP
24	3753	2084	5014	2628	5550	2539	6531	2442	7071	2440
20	4000	2070	5070	2600	5800	2500	7000	2450	7705	2453
16	4267	2050	4562	2298	5832	2445	7532	2455	8228	2448

TC - Total Cooling Capacity (W)  
SHC - Sensible Heat Capacity (W)  
IP - Input Power (W)

## 18. Service Data

Service data provided are based on the air conditioner running under rated frequency during forced cooling / forced heating mode.

### 18.1 Cool Mode Outdoor Air Temperature Characteristic

Condition

- Indoor room temperature: 27°C DryBulb/19°C Wet Bulb
- Unit setting: Standard piping length, forced cooling at 16°C, Hi fan
- Compressor frequency: Rated for cooling operation
- Voltage: 220V/230V

#### 18.1.1 CS-E18RB4EAW CU-E18RBEA

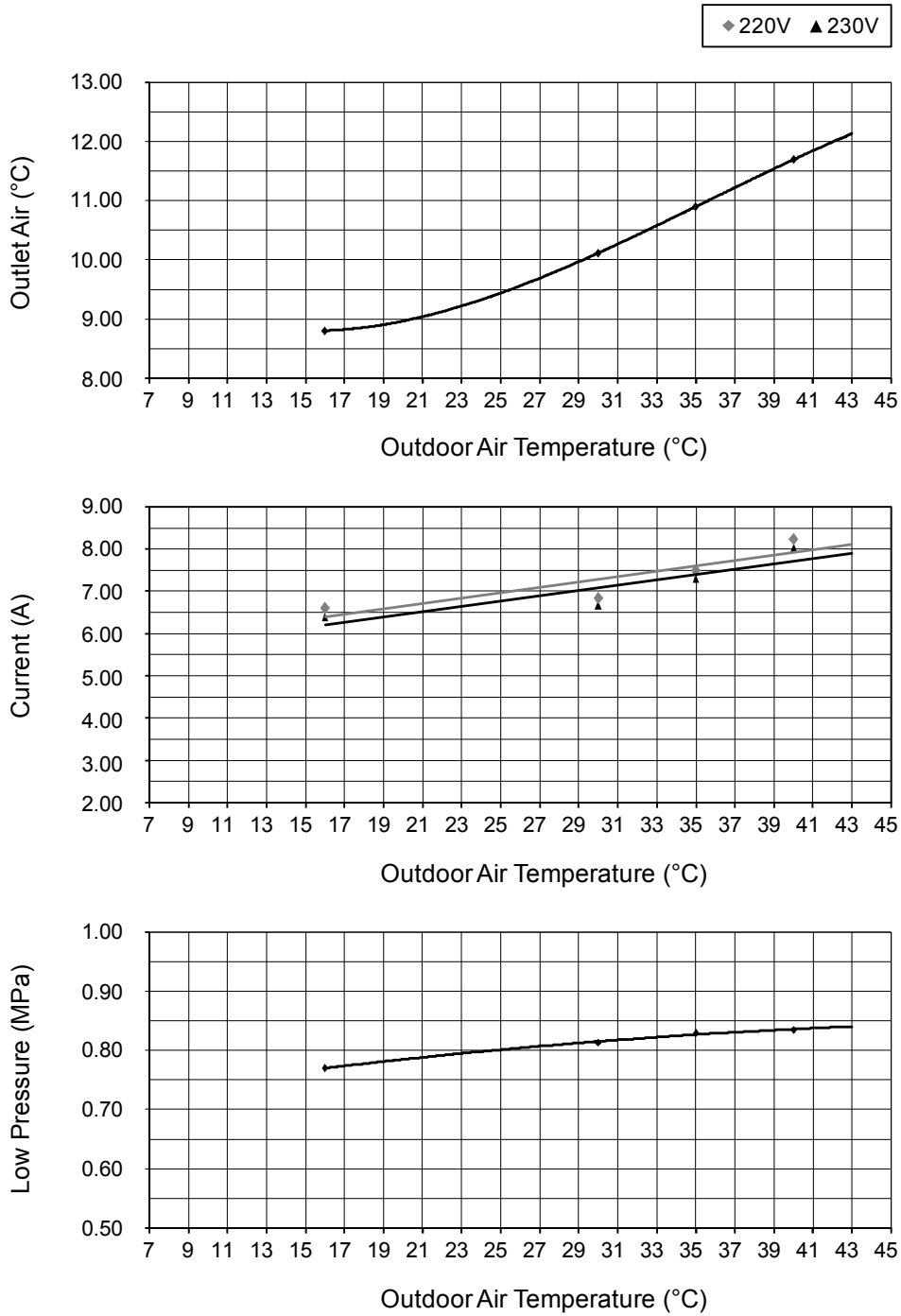

18.1.2 CS-E21RB4EAW CU-E21RBEA

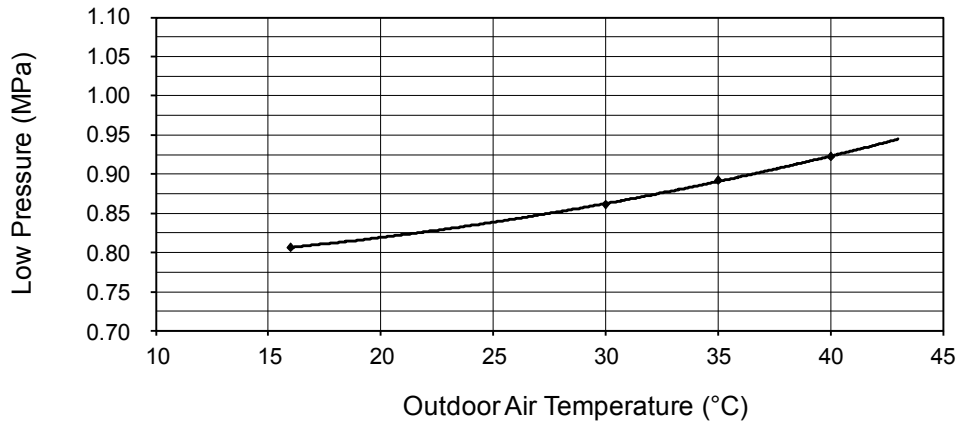
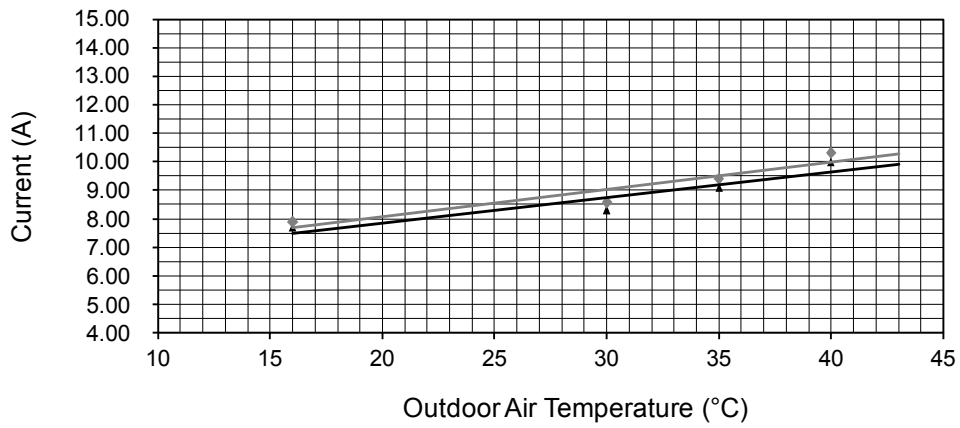
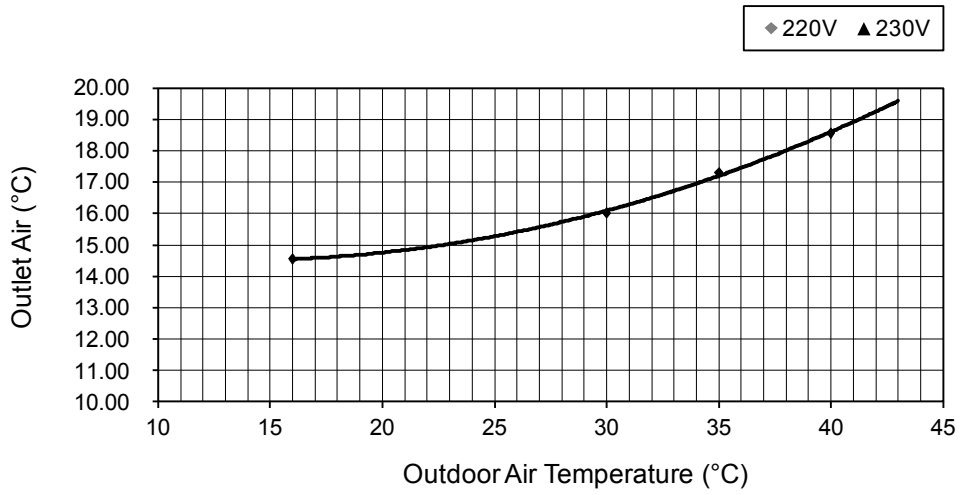

## 18.2 Heat Mode Outdoor Air Temperature Characteristic

Condition

- Indoor room temperature: 20°C DryBulb/ -°C Wet Bulb
- Unit setting: Standard piping length, forced heating at 30°C, Hi fan
- Compressor frequency: Rated for Heating operation
- Voltage: 220V/230V

### 18.2.1 CS-E18RB4EAW CU-E18RBEA

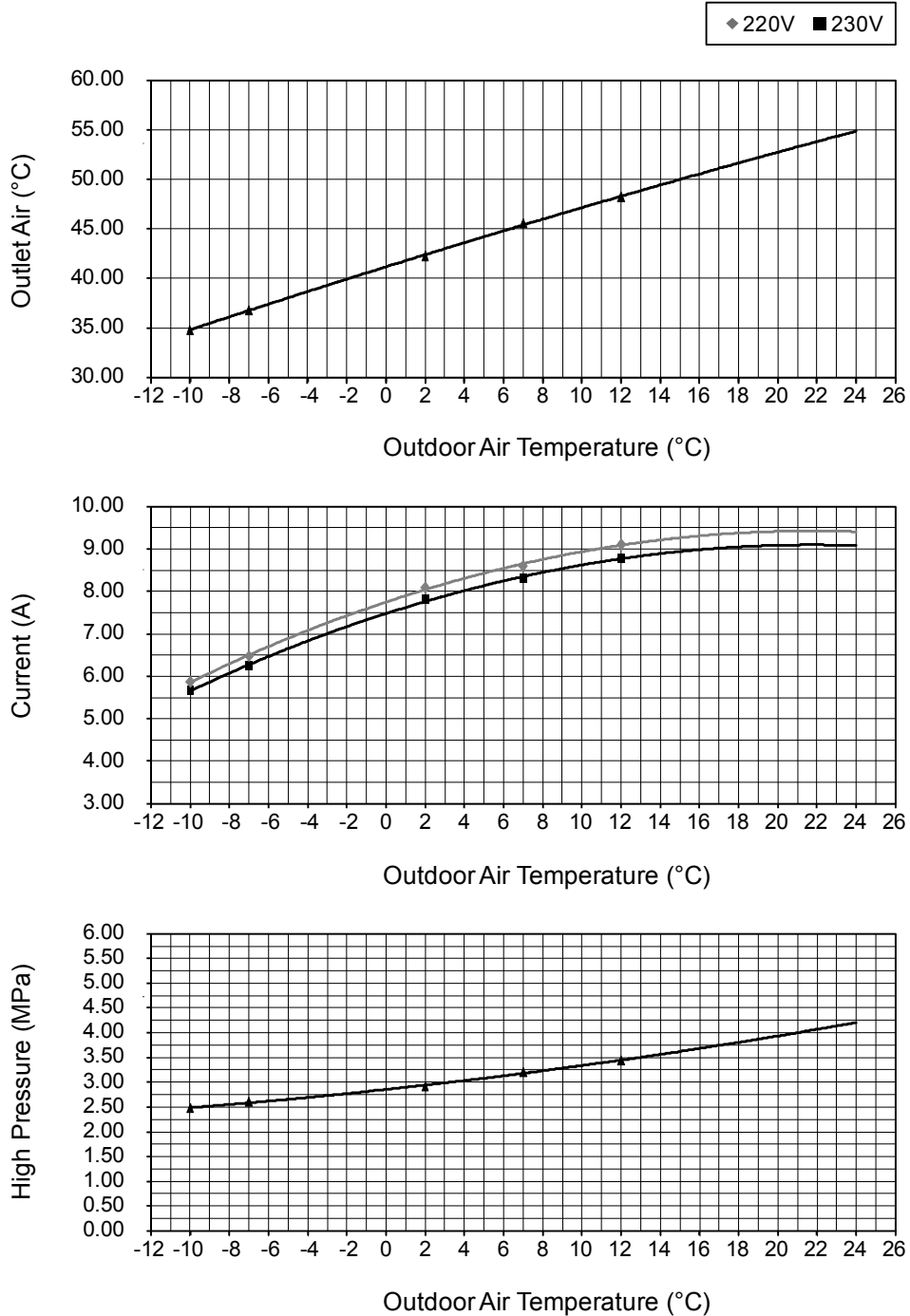

## 18.2.2 CS-E21RB4EAW CU-E21RBEA

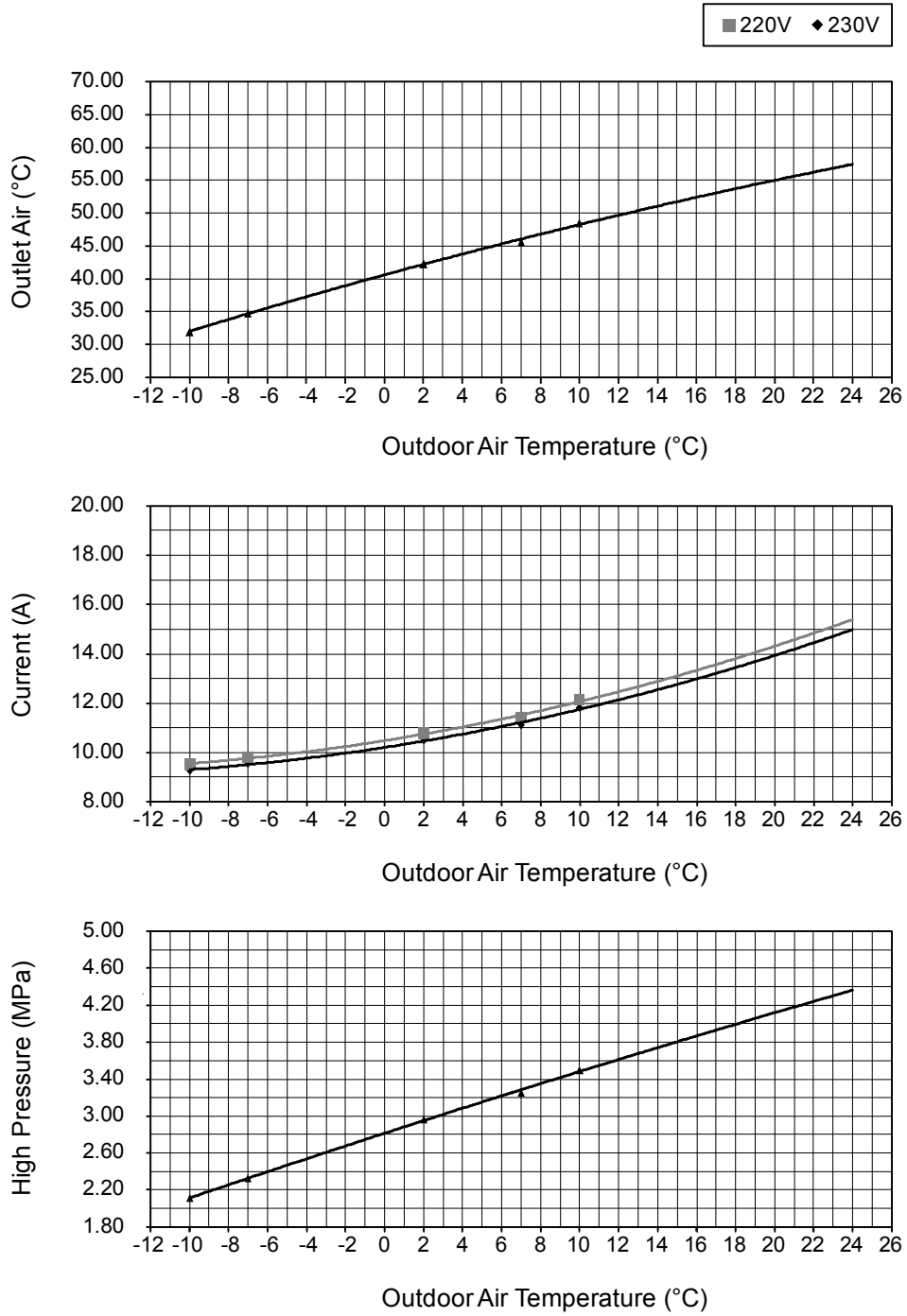

### 18.3 Piping Length Correction Factor

The characteristic of the unit has to be corrected in accordance with the piping length.

#### 18.3.1 CS-E18RB4EAW CU-E18RBEA CS-E21RB4EAW CU-E21RBEA

##### 18.3.1.1 Cooling Capacity

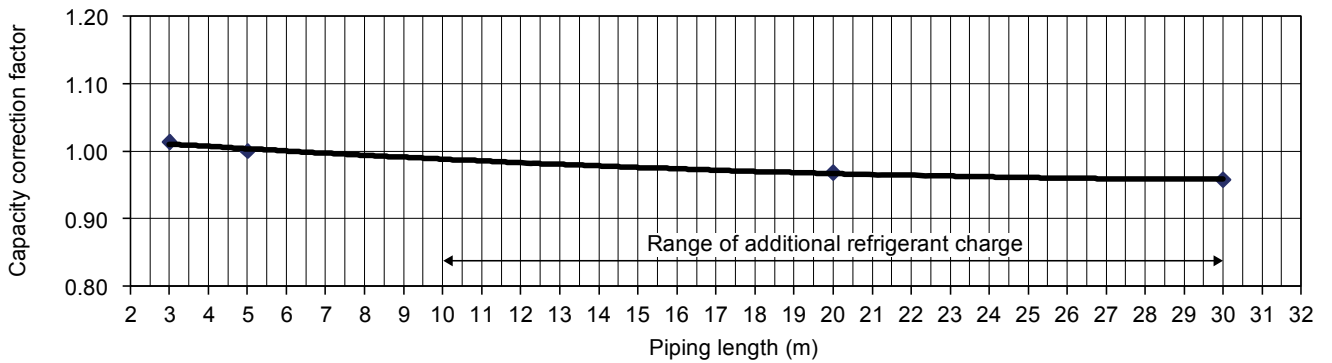

##### 18.3.1.2 Heating Capacity

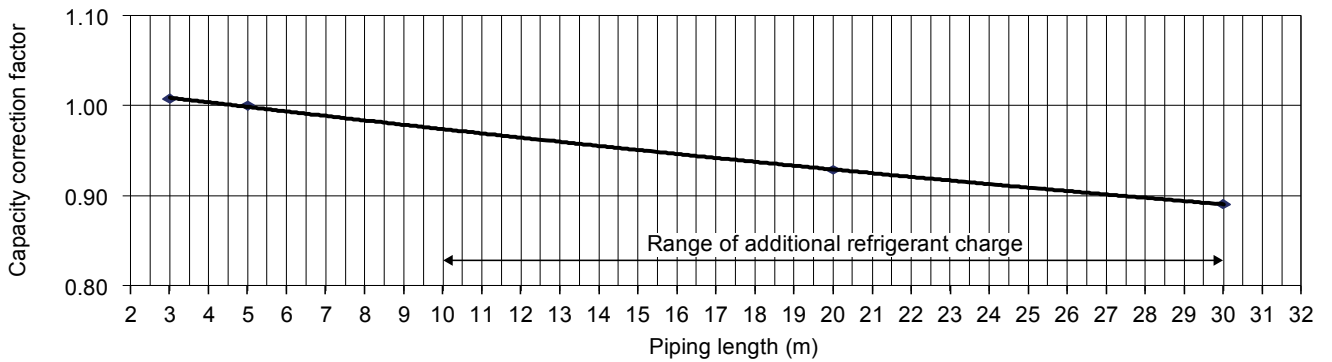

Note: The graphs show the factor after added right amount of additional refrigerant.

# 19. Exploded View and Replacement Parts List

## 19.1 Indoor Unit

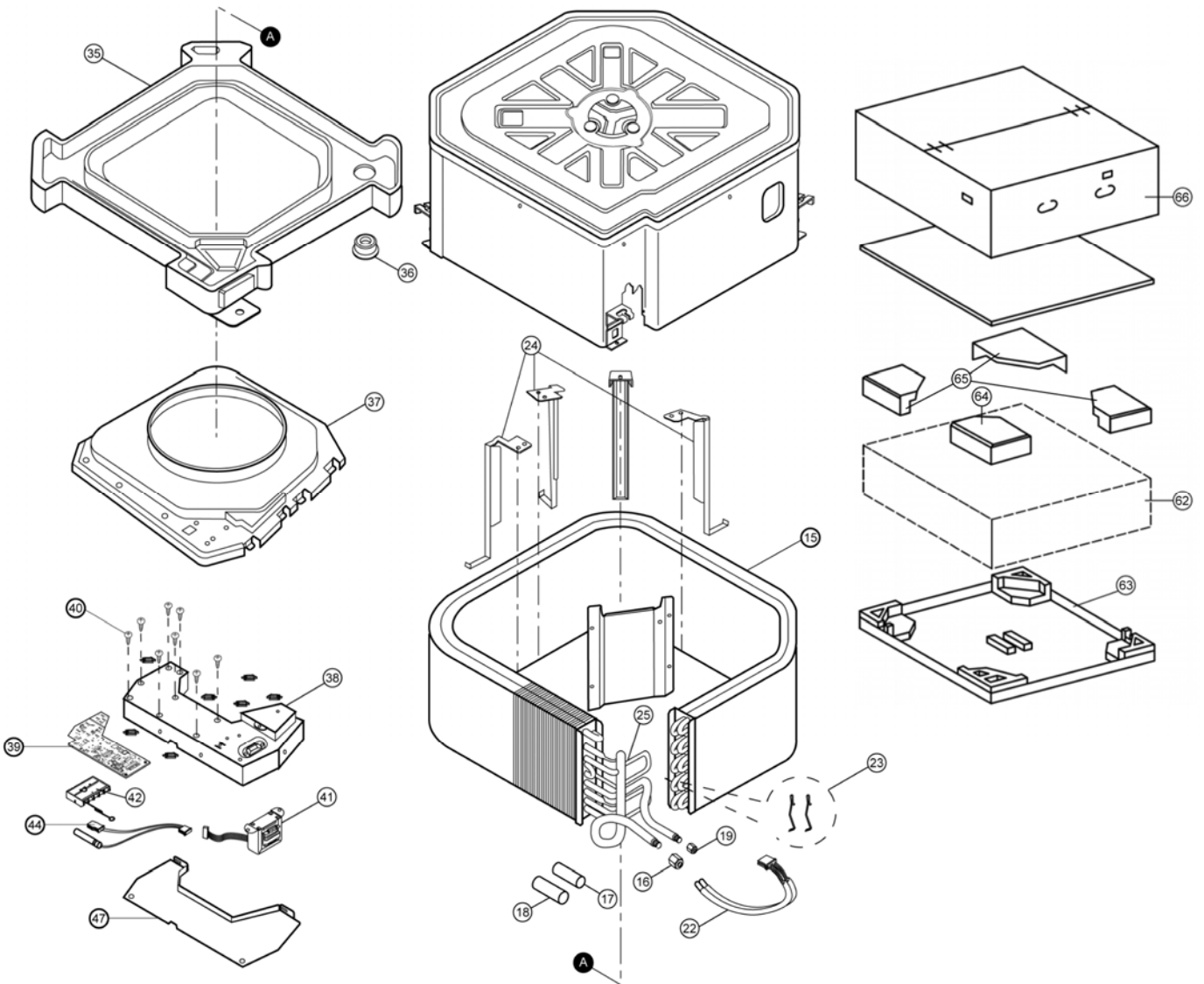



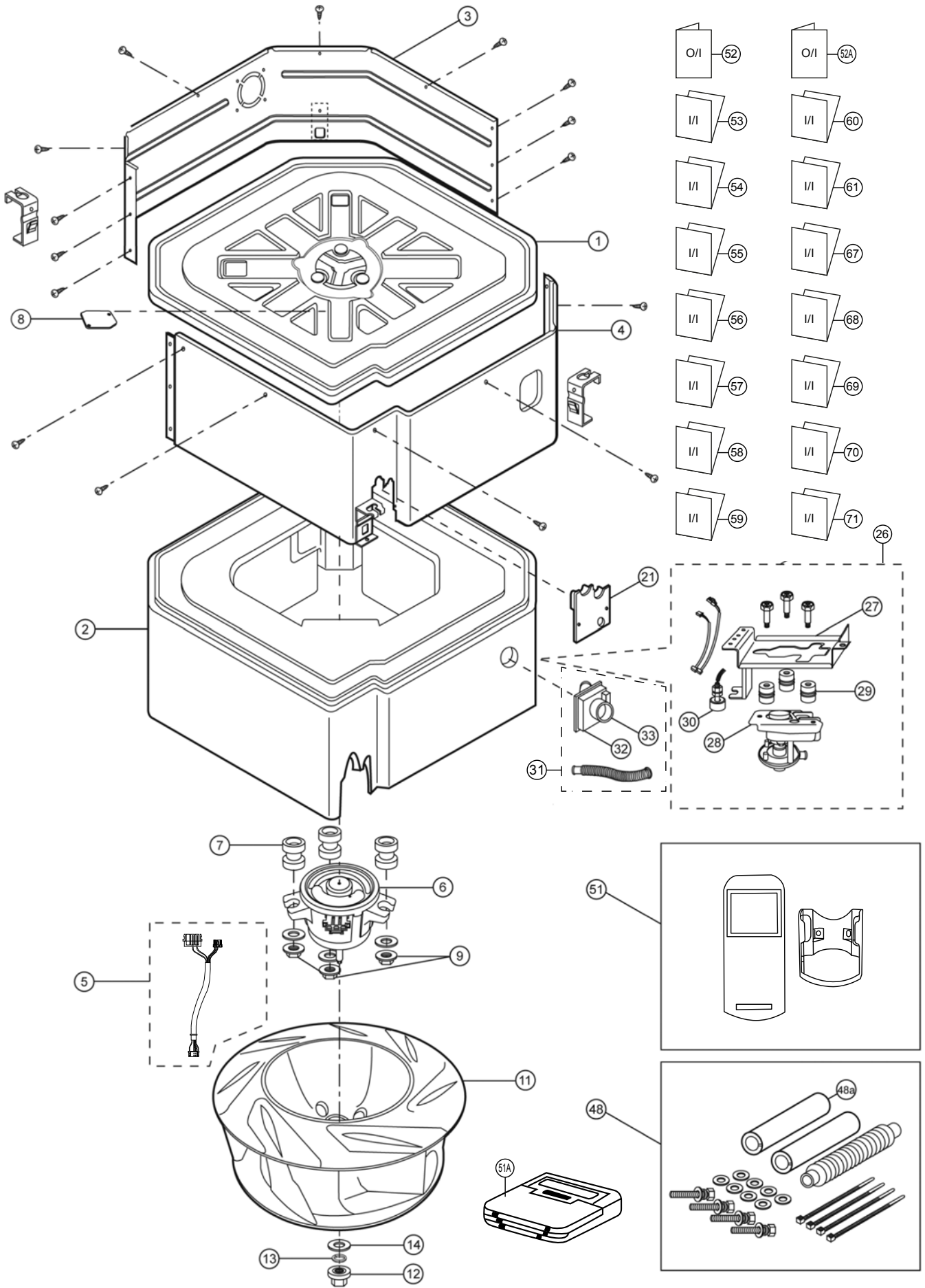

Note:  
 The above exploded view is for the purpose of parts disassembly and replacement.  
 The non-numbered parts are not kept as standard service parts.

<Model: CS-E18RB4EAW CS-E21RB4EAW>

SAFETY	REF. NO.	PART NAME & DESCRIPTION	QTY	CS-E18RB4EAW	CS-E21RB4EAW	REMARK
	1	BASE PAN ASS'Y	1	CWD52K1100	←	
	2	INNER POLYSTYRENE COMPLETE	1	CWG07C1047	←	
	3	CABINET SIDE PLATE ASS'Y	1	CWE041121	←	
	4	CABINET SIDE PLATE ASS'Y	1	CWE041122	←	
	5	LEAD WIRE - FAN MOTOR	1	CWA67C5136	←	
⚠	6	FAN MOTOR	1	EHDS50A40AC	←	O
	7	ANTI - VIBRATION BUSHING	3	CWH501065	←	
	8	CORD HOLDER	1	CWD741024	←	
	9	SCREW - FAN MOTOR	3	CWH561058	←	
	11	TURBO FAN	1	CWH03K1022	←	O
	12	NUT for TURBO FAN	1	CWH561042	←	
	13	SP WASHER	1	XWA8BFJ	←	
	14	WASHER	1	XWG8H22FJ	←	
	15	EVAPORATOR COMPLETE	1	CWB30C4888	CWB30C5038	
	16	FLARE NUT (1/2")	1	CWT251032	←	
	17	HEATPROOF TUBE	1	CWG021024	←	
	18	HEATPROOF TUBE	1	CWG021064	←	
	19	FLARE NUT (1/4")	1	CWT251030	←	
	21	PIPE COVER	1	CWD93C1050	←	
	22	SENSOR - EVAPORATOR	1	CWA50C2549	←	
	23	HOLDER SENSOR	1	CWH32143	←	
	24	EVAPORATOR SUPPORTER	3	CWD911529A	←	
	25	TUBE ASS'Y (CAPIL. TUBE)	1	CWT07K1188	←	
	26	DRAIN PUMP COMPLETE	1	CWB53C1025	←	
	27	PANEL DRAIN PUMP ASS'Y	1	CWD93K1021	←	
	28	DRAIN PUMP	1	CWB532059	←	
	29	ANTI - VIBRATION BUSHING	3	CWH501080	←	
	30	FLOAT SWITCH - DRAIN PUMP	1	CWA121233	←	
	31	FLEXIBLE PIPE	1	CWH85C1033	←	
	32	DRAIN NOZZLE	1	CWH411011	←	
	33	DRAIN HOSE HEAT INSULATION	1	CWG321050	←	
	35	DRAIN PAN - COMPLETE	1	CWH40C1034	←	
	36	DRAIN PLUG	1	CWB821008	←	
	37	AIR GUIDER BLOWER WHEEL	1	CWD321058	←	
	38	CONTROL BOARD CASING	1	CWH10K1102	←	
⚠	39	ELECTRONIC CONTROLLER (MAIN)	1	CWA73C9187	CWA73C9188	O
	40	SPACER	6	CWH541026	←	
	41	TRANSFORMER	1	CWA40C1030	←	O
⚠	42	TERMINAL BOARD ASS'Y	1	CWA28K1321	←	O
	44	LEADWIRE-AIR TEMP. SENSOR	1	CWA68C1507	←	
	47	CONTROL BOARD COVER	1	CWH13C1343	←	
	48	ACCESSORY COMPLETE	1	CWH82C1270	←	
	48A	HEATPROOF TUBE	1	CWG021025	←	
	51	WIRELESS REMOTE CONTROL COMPLETE	1	CWA75C4347	←	O
	51A	WIRED REMOTE CONTROL COMPLETE	1	CWA75C4516	←	O

SAFETY	REF. NO.	PART NAME & DESCRIPTION	QTY	CS-E18RB4EAW	CS-E21RB4EAW	REMARK
	52	OPERATING INSTRUCTION	1	CWF569900	←	
	52A	OPERATING INSTRUCTION	1	CWF569901	←	
	53	INSTALLATION INSTRUCTION	1	CWF616750	←	
	54	INSTALLATION INSTRUCTION	1	CWF616751	←	
	55	INSTALLATION INSTRUCTION	1	CWF616752	←	
	56	INSTALLATION INSTRUCTION	1	CWF616753	←	
	57	INSTALLATION INSTRUCTION	1	CWF616754	←	
	58	INSTALLATION INSTRUCTION	1	CWF616755	←	
	59	INSTALLATION INSTRUCTION	1	CWF616756	←	
	60	INSTALLATION INSTRUCTION	1	CWF616757	←	
	61	INSTALLATION INSTRUCTION	1	CWF616758	←	
	62	BAG	1	CWG86420	←	
	63	BASE BOARD - COMPLETE	1	CWG62C1047	←	
	64	SHOCK ABSORBER	1	CWG712509	←	
	65	SHOCK ABSORBER	3	CWG712510	←	
	66	C.C. CASE	1	CWG581294	←	
	67	INSTALLATION INSTRUCTION	1	CWF616759	←	
	68	INSTALLATION INSTRUCTION	1	CWF616760	←	
	69	INSTALLATION INSTRUCTION	1	CWF616761	←	
	70	INSTALLATION INSTRUCTION	1	CWF616762	←	
	71	INSTALLATION INSTRUCTION	1	CWF616763	←	

(Note)

- All parts are supplied from PAPAMY, Malaysia (Vendor Code: 00029488).
- "O" marked parts are recommended to be kept in stock.

## 19.2 CZ-BT20U (Front Grille Complete)

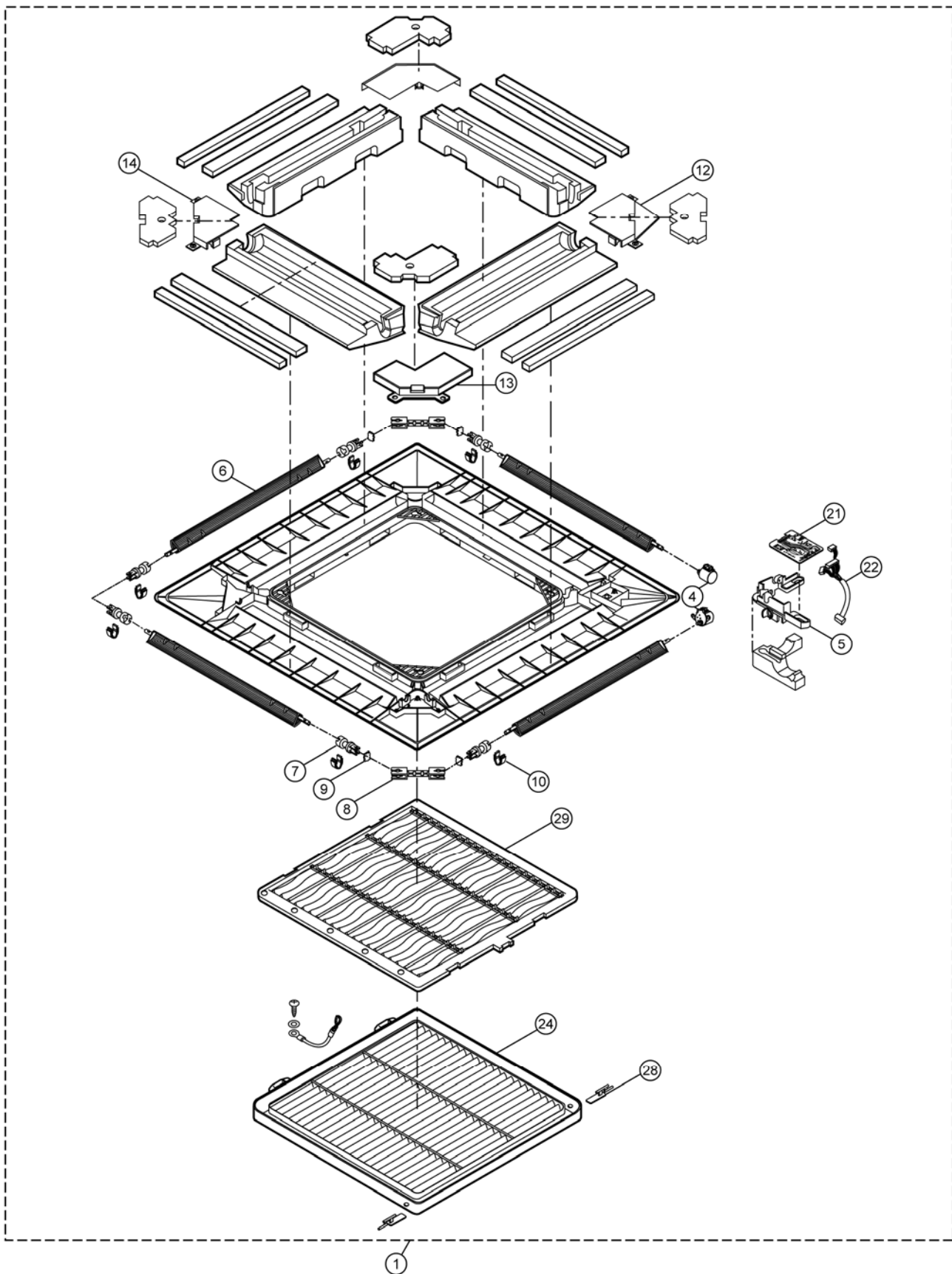

Note:  
The above exploded view is for the purpose of parts disassembly and replacement.  
The non-numbered parts are not kept as standard service parts.

SAFETY	REF. NO.	PART NAME & DESCRIPTION	QTY	PART NO.	REMARK
	1	FRONT GRILLE - COMPLETE	1	CWE11C6074	O
	4	A.S MOTOR DC SINGLE 12V 250 OHM	2	CWA981105J	O
	5	BRACKET - A.S.MOTOR	1	CWD932522	
	6	VANE	4	CWE241159	
	7	SHAFT	6	CWH631038	
	8	SHAFT	2	CWH631045	
	9	CONNECTOR - SHAFT	4	CWH081007	
	10	BEARING	6	CWH641008	
	12	PLATE COVER FOR A.S.MOTOR	1	CWD911459	
	13	PLATE COVER FOR CONNECTING SHAFT	2	CWD911460	
	14	PLATE COVER FOR END SHAFT	1	CWD911461	
	21	ELECTRONIC CONT. (RECEIVER & INDICATOR)	1	CWA748302	O
	22	LEAD WIRE - COMPLETE	1	CWA67C5576	
	24	INTAKE GRILLE	1	CWE221131	
	28	LEVER ARM	2	CWH651029	
	29	AIR FILTER	1	CWD001142	O

(Note)

- All parts are supplied from PAPAMY, Malaysia (Vendor Code: 00029488).
- "O" marked parts are recommended to be kept in stock.

## 19.3 Outdoor Unit

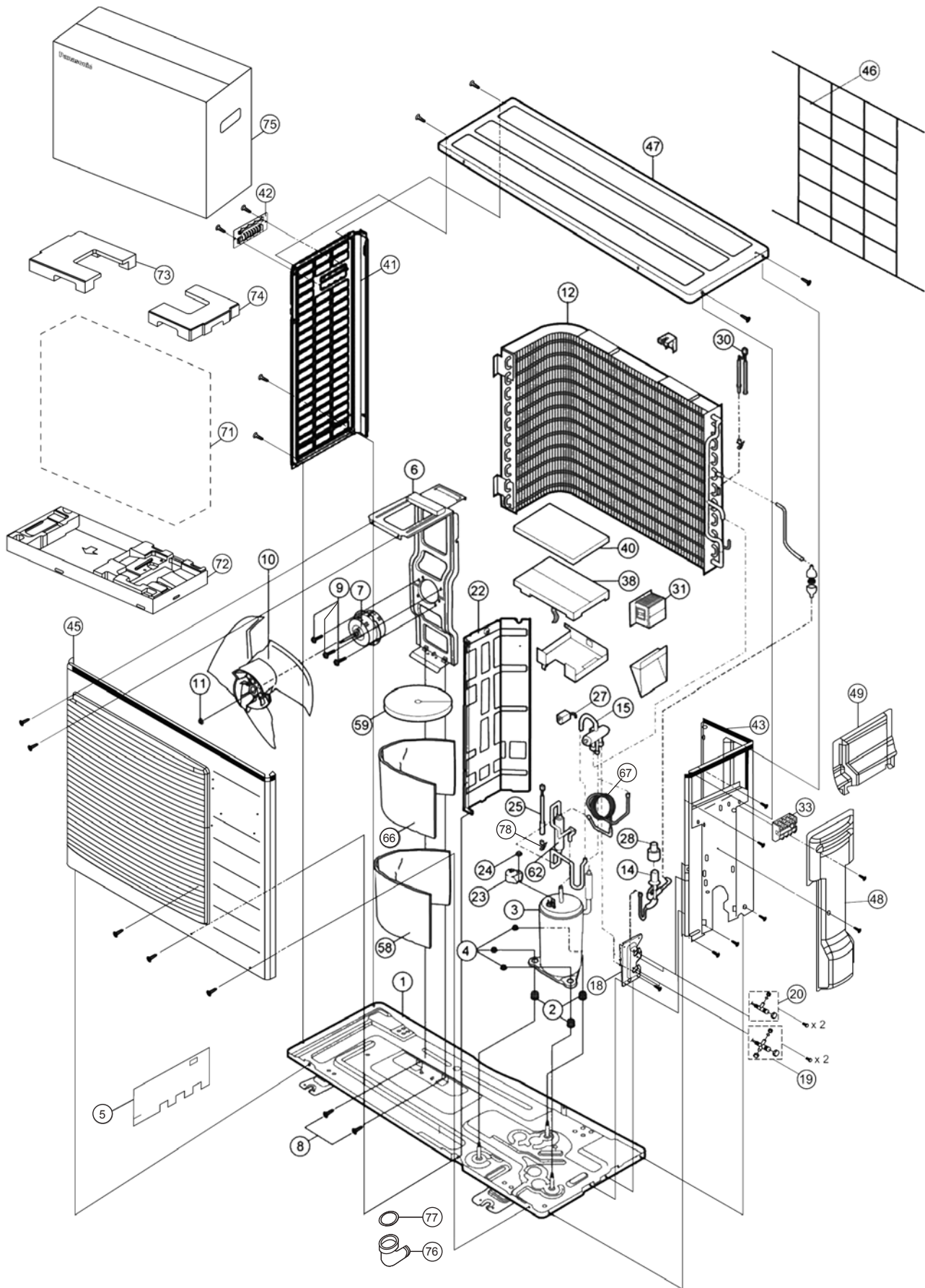

**Note**  
The above exploded view is for the purpose of parts disassembly and replacement.  
The non-numbered parts are not kept as standard service parts.

SAFETY	REF. NO.	PART NAME & DESCRIPTION	QTY.	CU-E18RBEA	CU-E21RBEA	REMARK
	1	CHASSIS COMPLETE	1	CWD52K1261	←	
	2	ANTI - VIBRATION BUSHING	3	CWH50077	←	
⚠	3	COMPRESSOR	1	5RD132XBA21	←	O
	4	NUT - COMPRESSOR MOUNT	3	CWH561096	←	
	5	SOUND PROOF MATERIAL	1	CWG302950	←	
	6	FAN MOTOR BRACKET	1	CWD541153	←	
⚠	7	FAN MOTOR	1	ARW8401AC	←	O
	8	SCREW - FAN MOTOR BRACKET	2	CWH551217	←	
	9	SCREW - FAN MOTOR MOUNT	4	CWH551106J	←	
	10	PROPELLER FAN ASSY	1	CWH03K1065	←	
	11	NUT - PROPELLER FAN	1	CWH56053J	←	
	12	CONDENSER	1	CWB32C3371	CWB32C4034	
	14	EXPANSION VALVE	1	CWB051016J	←	O
	15	4-WAYS VALVE	1	CWB001026J	←	O
	18	HOLDER COUPLING	1	CWH351227	←	
	19	3-WAY VALVE (GAS)	1	CWB011338	←	O
	20	2-WAYS VALVE (LIQUID)	1	CWB021454	CWB021292	O
	22	SOUND PROOF BOARD	1	CWH151257	←	
	23	TERMINAL COVER	1	CWH171039A	←	
	24	NUT - TERMINAL COVER	1	CWH7080300J	←	
	25	SENSOR COMPLETE (COMP TEMP)	1	CWA50C2185	←	O
⚠	27	V-COIL COMPLETE (4-WAY VALVE)	1	CWA43C2169J	←	O
⚠	28	V-COIL COMPLETE (EXP. VALVE)	1	CWA43C2257	←	O
	30	SENSOR - COMPLETE (AIR TEMP AND PIPE TEMP)	1	CWA50C2517	CWA50C3256	O
⚠	31	REACTOR	1	G0C203J00003	←	O
⚠	33	TERMINAL BOARD ASSY	1	CWA28K1110J	←	O
⚠	38	ELECTRONIC CONTROLLER - MAIN	1	CWA73C9189R	CWA73C9190R	O
	40	CONTROL BOARD COVER - TOP	1	CWH131333	←	
	41	CABINET SIDE PLATE (LEFT)	1	CWE041520A	←	
	42	HANDLE	1	CWE161010	←	
	43	CABINET SIDE PLATE (RIGHT)	1	CWE041555A	←	
	45	CABINET FRONT PLATE CO.	1	CWE06K1077	←	
	46	WIRE NET	1	CWD041155A	←	
	47	CABINET TOP PLATE	1	CWE031083A	←	
	48	CONTROL BOARD COVER - COMPLETE	1	CWH13C1238	←	
	49	CONTROL BOARD COVER	1	CWH131409A	←	
	58	SOUND PROOF MATERIAL	1	CWG302638	←	
	59	SOUND PROOF MATERIAL	1	CWG302630	←	
	62	OIL SEPARATER ASS'Y	1	CWB16K1024	←	
	66	SOUND PROOF MATERIAL	1	CWG302600	CWG302921	
	67	CAPILLARY TUBE ASS'Y	1	CWB15K1487	←	
	71	BAG	1	CWG861461	←	
	72	BASE BOARD - COMPLETE	1	CWG62C1131	←	
	73	SHOCK ABSORBER (LEFT)	1	CWG713217	←	
	74	SHOCK ABSORBER (RIGHT)	1	CWG713218	←	
	75	C.C.CASE	1	CWG568359	←	
	76	L - TUBE	1	CWH5850080	←	

SAFETY	REF. NO.	PART NAME & DESCRIPTION	QTY.	CU-E18RBEA	CU-E21RBEA	REMARK
	77	PACKING - L. TUBE	1	CWB81012	←	
	78	HOLDER SENSOR	1	CWH32143	←	

(NOTE)

- All parts are supplied from PAPAMY, Malaysia (Vendor Code: 00029488).
- “O” marked parts are recommended to be kept in stock.