

Scotsman®

SERVICE MANUAL

MAR	56
MAR	76
MAR	106
MAR	126
MAR	206
MAR	306

Scale ice machines

SCOTSMAN EUROPE - FRIMONT SPA
Via Puccini, 22 - 20010 Pogliano M.se - Milano - Italy
Tel. +39-02-93960.1 (Aut. Sel.)- Telefax +39-02-93550500
Direct Line to Service & Parts:
Phone +39-02-93960350 - Fax +39-02-93540449
Website: www.scotsman-ice.com
E-Mail: scotsman.europe@frimont.it



FOREWORD

The "MAR" ice makers make flake ice of "scale" type which is flat, hard dry and sub-cooled, giving to it an exceptional staying power for multiple chilling operations.

The design simplicity accounts for the confidence in MAR scale ice machines. Their ice making system has only one sealed moving part, resulting in a minimum of maintenance operations for continuous reliable machine service.

Ice is discharged through a large opening on the back of unit cabinet, when mounted on top of the refrigerated room, ice is gravity fed to storage area.

Rugged, solid, heavy duty, the stainless steel MAR cabinet has removable panels that facilitate the accessibility to mechanical and electrical parts. A console panel with lights monitoring water flow pressure, and temperature operating refrigerant pressure and motors overloading forewarn the system malfunction before becoming major trouble.

We suggest you to take time now to read this manual which contains a lot of valuable informations on the MAR ice making system.

If you have any further queries regarding the care or operation of the machine, please contact:



SCOTSMAN - EUROPE - FRIMONT SPA
Via Puccini, 22 - 20010 Bettolino di Pogliano (Milano) Italy
Tel. +39-02-93960.1 (Aut. Sel.)- Telefax +39-02-93550500
Direct Line to Service & Parts:
Phone +39-02-93960350 - Fax +39-02-93540449
Website: www.scotsman-ice.com
E-Mail: scotsman.europe@frimont.it

NOTE: *Whenever writing please state model no. and serial no. of the machine*

<u>TABLE OF CONTENTS</u>		page	
	Foreword		2
	Table of contents		3
	Specifications - MAR 56 - 76 - 106 - 126		4-5-6
	Specifications - MAR 206 - 306		7-8
	Remote cond.		9
Section I	GENERAL INFORMATIONS & INSTALLATIONS		
	Description		10
	Unpacking & Inspection		10
	Location & Levelling		11
	Electrical connections		12
	Water supply & Drain connections		12
	Remote air cooled condenser installation		13
	Ice level control		14
	Ice chute		15
	Final check list		15
	Unit installation practice		15-16
	Remote condenser installation practice		17
Section II	OPERATING INSTRUCTIONS		
	Start-up		18
	Water & Refrigerant circuit		19-20
Section III	PRINCIPLES OF OPERAZION - HOW IT WORKS		
	Ice maker		21
	Electrical / Refrigeration		22-23-24
	Refrigerant charge		25
	Mechanicals		25
Section IV	ADJUSTMENT & REMOVAL & REPLACEMENT PROCEDURES		
	Water regulator assy		26
	Automatic expansion valve		26
	V Belt change on pulley		26
	Compressor replacement		26
	Water cooled condens. replacement		27
	Water regulator replacement		27
	Drier replacement		27
	Drive motor replacement		28
	Gear Box replacement		29
	Fiber key replacement		29
Section V	MAINTENANCE & CLEANING INSTRUCTIONS		
	General		30
	Ice maker		30
	Cleaning instruction		30-31-32
Section VI	SERVICE DIAGNOSIS		
	Ice making - Refrigerant system		33-34
Section VII	WIRING DIAGRAMS		35
	MAR 56-76-106-126 - Wiring diagram		36-38
	MAR 206-306 - Wiring diagram Fig. 1		39-42

SPECIFICATIONS

MAR 56

AIR & WATER COOLED MODELS

ice making capacity

————— THICK SCALE ICE
 - - - - - THIN SCALE ICE

AIR COOLED MODELS

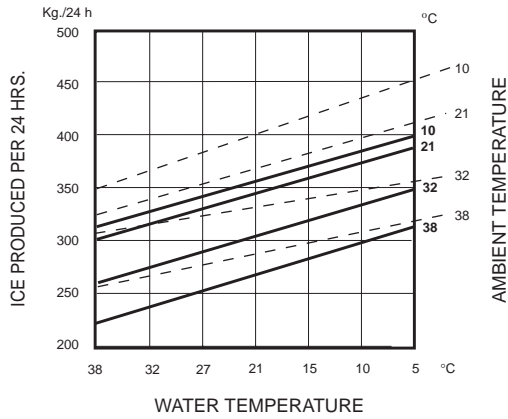

WATER COOLED MODELS

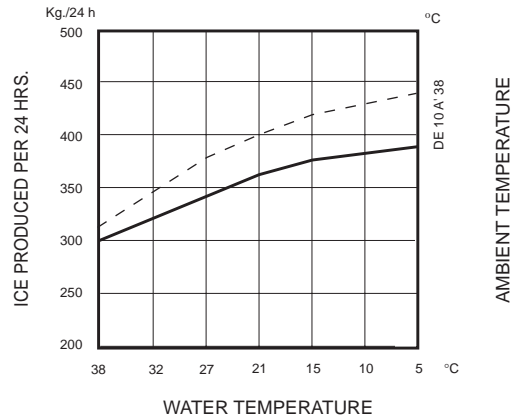

MAR 76

AIR & WATER COOLED MODELS

ice making capacity

————— THICK SCALE ICE
 - - - - - THIN SCALE ICE

AIR COOLED MODELS

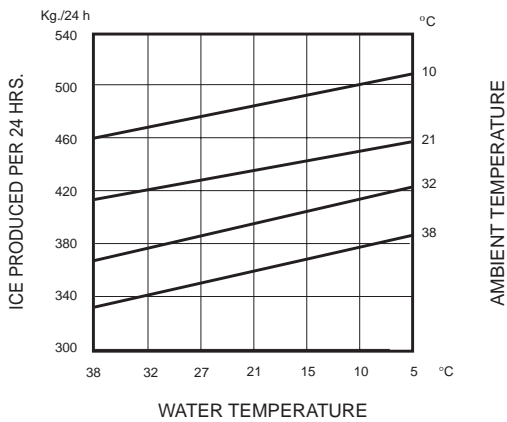

NOTE. Daily ice capacity is directly related to condenser air water inlet temperature, water temperature to make ice - and age of machine.
 To keep your **SCOTSMAN MAR** performing at its maximum capacity, it is necessary to perform periodic maintenance as outlined on page 29 of this manual.

SPECIFICATIONS

MAR 106

AIR & WATER COOLED MODELS

ice making capacity

————— THICK SCALE ICE
 - - - - - THIN SCALE ICE

AIR COOLED MODELS

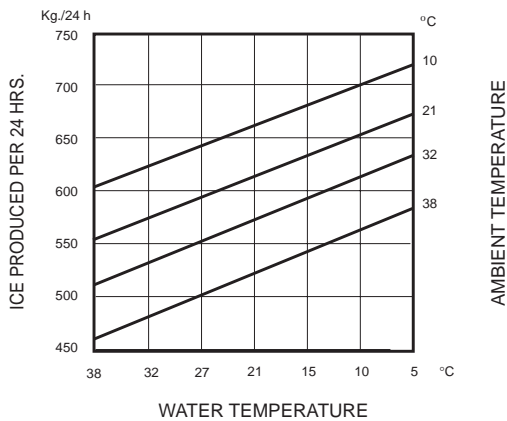

WATER COOLED MODELS

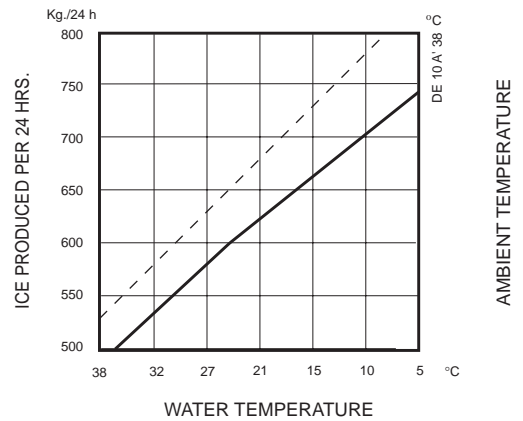

MAR 126

AIR & WATER COOLED MODELS

ice making capacity

————— THICK SCALE ICE
 - - - - - THIN SCALE ICE

AIR COOLED MODELS

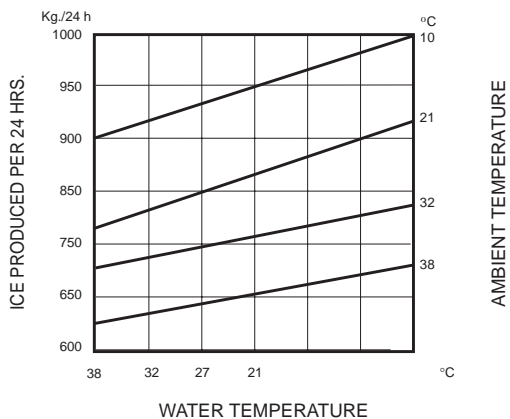

NOTE. Daily ice capacity is directly related to condenser air water inlet temperature, water temperature to make ice - and age of machine.
 To keep your **SCOTSMAN MAR** performing at its maximum capacity, it is necessary to perform periodic maintenance as outlined on page 29 of this manual.

MAR 56-76-106-126 - SPECIFICATIONS

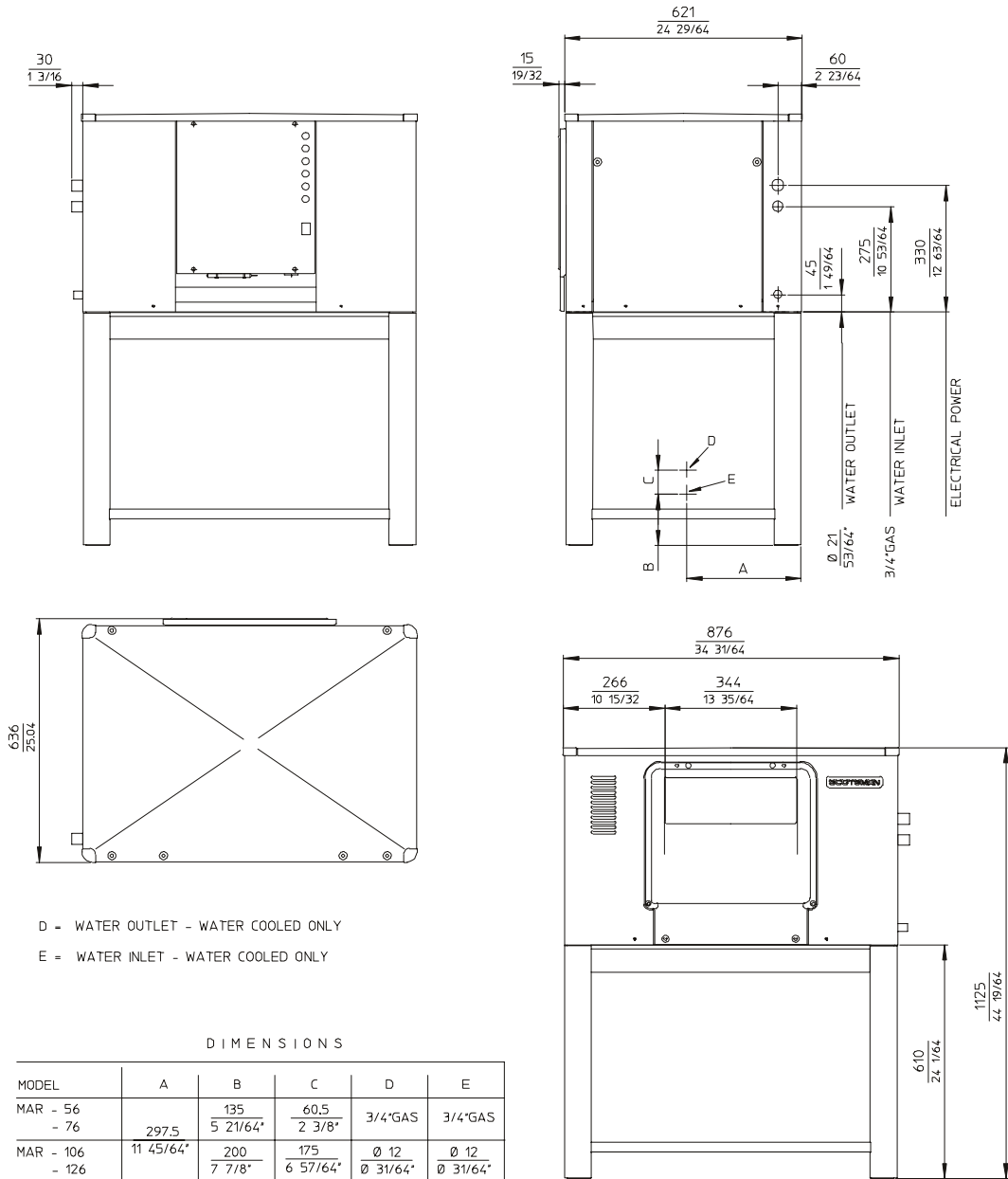

MODELS	Cond. Unit	Compr. (HP)	Water req. (l/h)		Power (KW)	Minimum wire size (mm)	Total Amps. 400 V	Finish	Shipping weight	
			* Cond.	Prod.					kg.	lbs.
MAR 56 AS	Air	2		16	2.2	5 x 1.5	2.7	Stainless	194	427
MAR 56 WS	Water	2	225	16	2.2	5 x 1.5	2.7	Steel	174	383
MAR 76 AS	Air	2.5		21	2.5	5 x 1.5	2.7	Stainless	204	450
MAR 76 WS	Water	2.5	300	21	2.5	5 x 1.5	2.7	Steel	201	442
MAR 106 AS	Air	4		30	3.5	5 x 1.5	5	Stainless	221	487
MAR 106 WS	Water	4	480	30	3.5	5 x 1.5	5	Steel	217	417
MAR 126 AS	Air	4.5		41	4.5	5 x 1.5	6.5	Stainless	226	497
MAR 126 WS	Water	4.5		41	4.5	5 x 1.5	6.5	Steel	222	488

BASIC ELECTRICALS: 400/50/3N

* at 21 °C amb. / 15 °C water temp.

SPECIFICATIONS

MAR 206

AIR & WATER COOLED MODELS

ice making capacity

————— THICK SCALE ICE
 - - - - - THIN SCALE ICE

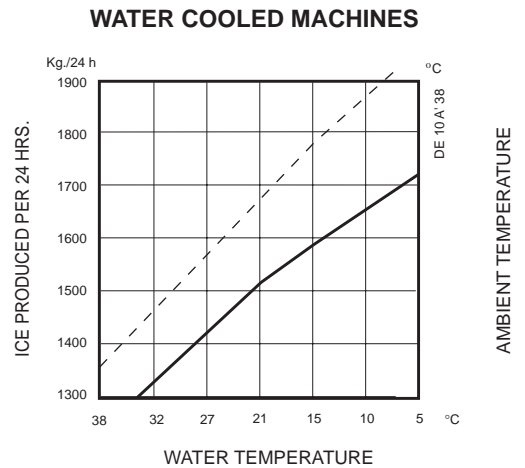
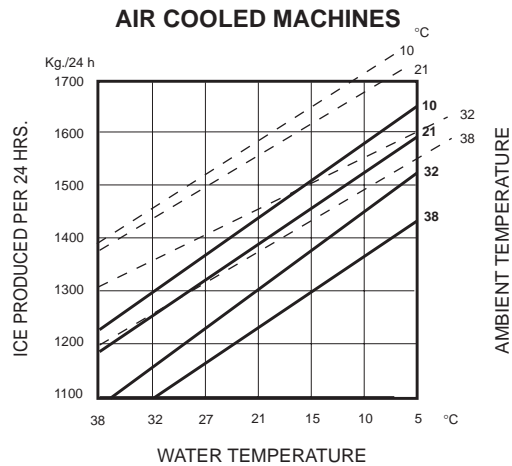

MAR 306

AIR & WATER COOLED MODELS

ice making capacity

————— THICK SCALE ICE
 - - - - - THIN SCALE ICE

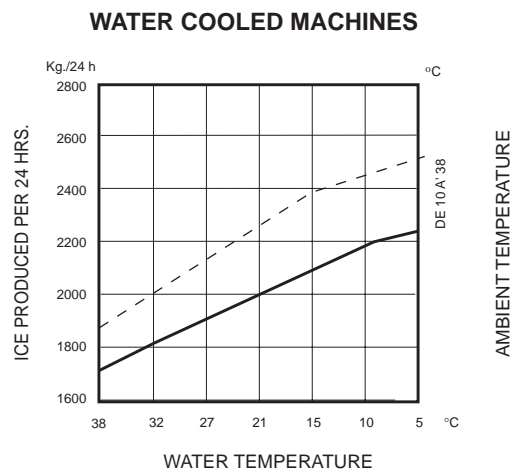
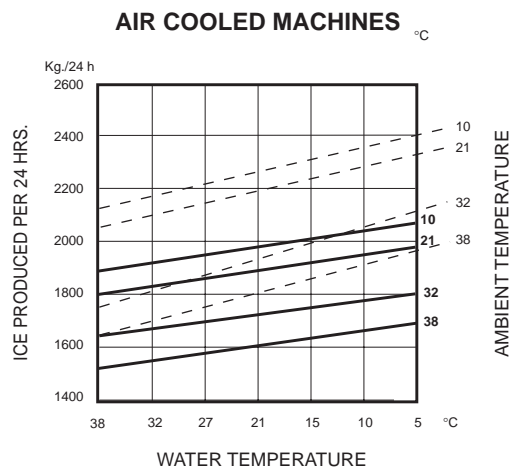

NOTE. Daily ice capacity is directly related to condenser air water inlet temperature, water temperature to make ice - and age of machine.
 To keep your **SCOTSMAN MAR** performing at its maximum capacity, it is necessary to perform periodic maintenance as outlined on page 29 of this manual.

MAR 206-306 - SPECIFICATIONS

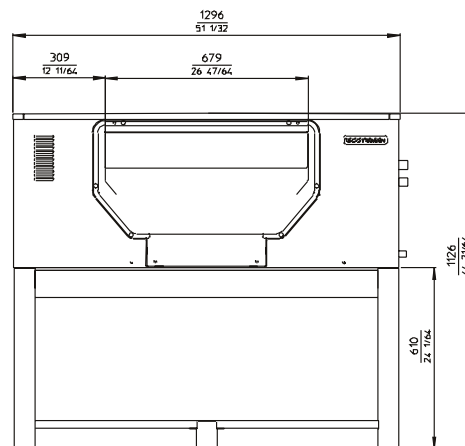
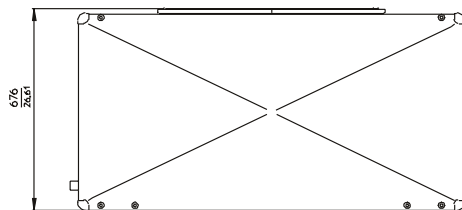
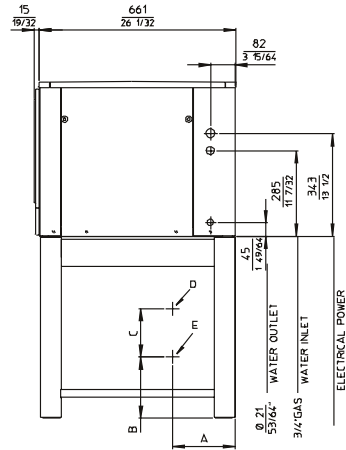
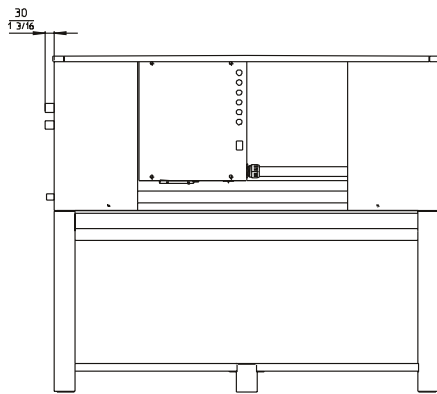

- D = WATER OUTLET - WATER COOLED ONLY
- E = WATER INLET - WATER COOLED ONLY

DIMENSIONS

MODEL	A	B	C	D	E
MAR - 206	210 8 17/64"	205 8 5/64"	165 6 1/2"	Ø 25 Ø 63/64"	Ø 20 Ø 51/64"
MAR - 306				Ø 25 Ø 63/64"	Ø 25 Ø 63/64"

MODELS	Cond. Unit	Compr. (HP)	Water req. (l/h)		Power (KW)	Minimum wire size (mm)	Total Amps. 400 V	Finish	Shipping weight	
			* Cond.	Prod.					kg.	lbs.
MAR 206 AS	Air	5		69	7	5 x 2.5	17	Stainless	374	824
MAR 206 WS	Water	5	1200	72	7	5 x 2.5	10	Steel	369	813
MAR 306 AS	Air	10		88	10	5 x 4	20	Stainless	383	844
MAR 306 WS	Water	10	1600	94	10	5 x 4	20	Steel	413	910

BASIC ELECTRICALS: 400/50/3N

* at 21 °C amb. / 15 °C water temp.

MAR 306 REMOTE CONDENSER

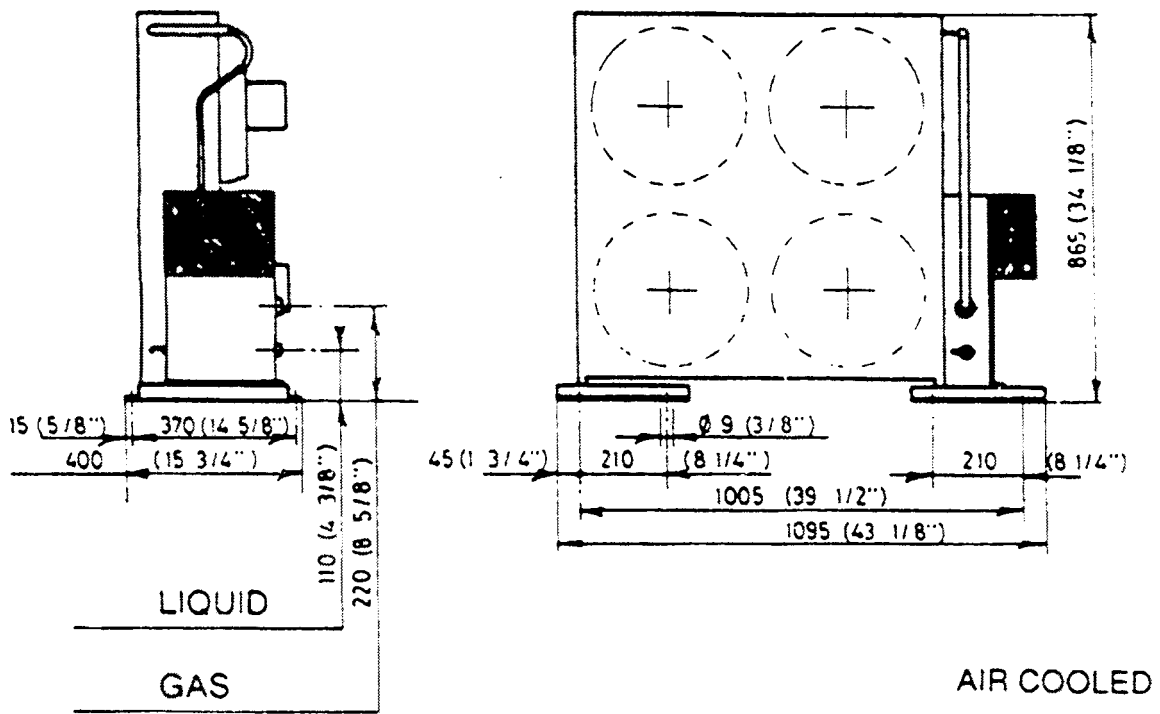

TECHNICAL SPECIFICATIONS

CONDENSER CAPACITY	FAN MOTOR	AIR FLOW
16200 Kcal/h	230/50/1 V - 0.7 A	4 x 1200 m ³ /h

NOTE. MAR 306 is not for out door installation. Fan motors are not weather proof.

SECTION I

GENERAL INFORMATION & INSTALLATION

1. DESCRIPTION

An attractive compact cabinet of stainless steel with control panel lights on the front. All panels are removable to allow easy access to electrical and mechanical components for cleaning and maintenance.

Sealed Refrigeration System

To provide quite efficient operation of the ice maker, the compressor is mounted on rubber cushions. The water cooled models have a tube within tube condenser with water regulation valve for correct condensing water flow. The air cooled models, except the MAR 306 have a built in condenser in copper and aluminium with the fan motor controlled by pressure control. The evaporator drum is powered by a separate drive motor connected by a V-belt and pulley system to a double gear box. The refrigerant used is R 404a controlled by automatic expansion valve.

Storage Bin or Ice Room

Since the MAR Scale is a continuous flow type ice maker and does not have its own attached storage bin, it is necessary to use an auxiliary bin or a pre-fabricated ice room for appropriate ice storage.

Ice storage situations are of two kinds:

- a) Short term storage
- b) Extended terms storage

Being, as stated, scale ice made by MAR machines flat, dry and subcooled, therefore with the tendency to stick together, particular attention is required for proper ice storage conditions for better ice handling. An insulated ice storage bin or rooms is always required, then according to ice end use application, this can be refrigerated on non-refrigerated.

Also a **weight volume ratio of 2,1 cu. mt. per ton**, must be taken into consideration for correct ice storage.

a) **Non-refrigerated room for short term storage.**

The scale ice is produced continuously for 24 hours per day, whereas the use period is generally for no longer than 8 hours per day.

Therefore storage facilities should be provided to accommodate a minimum of 16 hours of production, this means that every scale ice machine must be installed with a properly insulated storage room which should have a minimum capacity of 2/3 the daily ice production.

With a well insulated room and duly subcooled scale ice, the limited losses of heat through the walls of a properly designed room with adequate arrangements, are largely offset,

and excess melting will not occur. In most situations where whole quantity of ice produced is being used on a daily basis, it is not necessary to provide cooling for the ice storage room.

b) **Refrigerated room for extended storage and long distance conveying.**

When scale ice is to be transported at a considerable distance, such as aboard fishing vessels, or in locations with normal ambient temperatures conditions, or when used in industrial plants where demand is intermittent, its subcooling power must be absolutely preserved in the storage bin by a proper cooling system keeping air temperature at a pre-established and constant value. The ideal ice storage room is the type with mechanically refrigerated jacket space surrounding the ice bin. Good practice calls for an ice storage capacity of about two times the daily ice machines production with an inside temperature of -6°C minimum (20°F).

2. UNPACKING AND INSPECTION

1. Call your authorized SCOTSMAN Distributor od Dealer for proper installation.
2. Visually inspect the exterior of the shipping container and skid and any severe damage noted should be reported to the delivering carrier; and a concealed damage claim filled subject to internal inspection, with carrier representative present.
3. Remove the packing and remove the shipping bolts and the shipping base or skid.
4. When necessary, install the leg levellers in the cabinet base sockets; then, raise the cabinet to the upright position.
5. Remove screws and shipping tapes and all doors and service panels from the cabinet and inspect for any concealed damage. Notify carrier of any concealed damage claims as stated in step 2 above.
6. Remove all internal support packing, tape and wires in machinery compartment.
7. Check that refrigerant lines do not rub or touch lines or surfaces and that fan blades, if any, moves freely.
8. Check that compressor is snug on all mounting pads.
9. Use clean damp cloth or disposable paper wiper to wipe clean the exterior surface of the cabinet.

- See DATAPLATE on the cabinet base and check that the location source voltage corresponds with the voltage specified on the dataplate.

CAUTION - Unproper voltage supplied to the icemaker will void your parts replacement program.

- Remove the Manufacturer's registration Card from its envelope and fill in all spaces including: Model Number and serial Number taken from the aluminium plate located on the front of the Chassis base, with Front Panel removed.
Forward the completed, self addressed, registration card to the Scotsman Europe Frimont Factory.

3. LOCATION AND LEVELLING

**WARNING - The MAR Flakers are NOT designed for outdoors installation where air temperature are below 5°C (40°F) or above 40°C (100°F) and the water temperature is below 5°C (40°F) or above 35°C (95°F).
Extended periods of operation at temperatures exceeding these limitations will constitute misuse, under the terms of the SCOTSMAN Manufacturer's limited warranty coverage.**

- Stands** - A special stands should be built if the machine is located beside the bin. Care should be exercised in making the stand strong enough to support the weight. In designing the stand plan for the servicing of the machine from front, top and sides. It is also possible to locate the machine on top of the bin. Care should be used in selecting a bin that has been specially reinforced. Standard bins are usually not sufficiently reinforced for this purpose. An unsteady platform will cause excessive vibration. Specially built bins can provide proper support and allow for a servicing platform.

WARNING - Air Cooled version of MAR 76, MAR 106, MAR 126 and MAR 206 have the condensing air exhaust throughout the lower rear area (ice spout side) therefore it is necessary to avoid to position the ice maker with the rear side against any sort of wall that will prevent proper warm air dissipation. They must have on their rear side an air gap of 200 mm. MAR 56 has the air cooled condenser on the right side while MAR 306 has a se-parate remote air cooled condenser. (See instructions for remote condenser at 6).

CONDENSING AIR FLOW SCHEMATIC

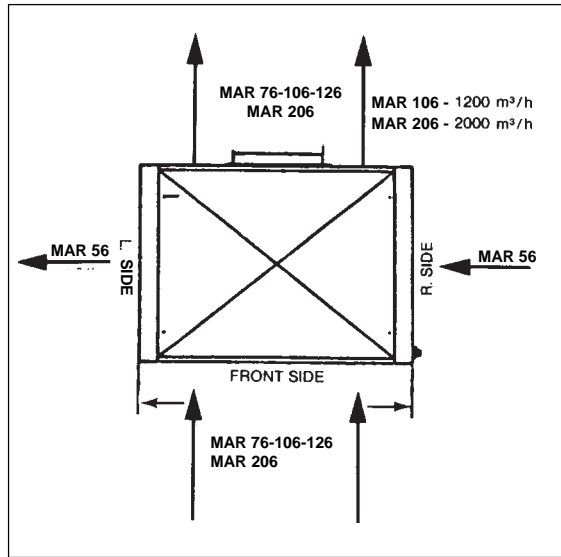

- Erection** - For elevations in excess of four feet or in close quarters, chain falls of fork lift truck should be used. For location under four feet, the use of skid boards and rollers is practical.

- Machine Site** - When selecting the permanent location of air cooled machines, consideration must be given to volume size of the room and to ventilation facilities for easy heat removal around the machine.

In doing this it worths to take on account that:

- MAR 56 AS - has a condenser heat rejection of 3000 Kcal/hr and fan motor draws air for 1200 m³/h.
- MAR 76 AS - has a condenser heat rejection of 4900 Kcal/hr and fan motor draws air for 1200 m³/h.
- MAR 106 AS - has a condenser heat rejection of 7500 Kcal/hr and the two fan motors draw air for 1200 m³/h each.
- MAR 126 AS - has a condenser heat rejection of 9750 Kcal/hr and the two fan motors draw air for 1200 m³/h each.
- MAR 206 AS - has a condenser heat rejection of 11000 Kcal/hr and the two fan motors draw air for 2000 m³/h each.
- MAR 306 AS - has a condenser heat rejection of 16200 Kcal/hr and the four fan motor draw air for 1200 m³/h each correspondind to 4800 m³/h in total.

- Position the MAR in the selected permanent location level the cabinet on both the left-to-right and front-to-rear directions. The levelling legs can be adjusted with an opened wrench. (See unit layout and dimensions at page 6 and 8).

4. ELECTRICAL CONNECTIONS

The machine has been wired ready for electric connections. See nameplate for current requirements to determine wire size to be used for electrical hook-up. The MAR flaker requires a solid earth ground wire. See wiring diagram.

Be certain the unit is connected to its own electrical circuit and individually fused.

The maximum allowable voltage variation, should not exceed ten percent of the nameplate rating, even under starting conditions.

Low voltages can cause erratic operation and may be responsible for serious damage to the overload switch and motor windings.

All external wiring should conform to the National, State and local electrical permit and services of a licensed electrician will be required.

WARNING - The compressor is equipped with a crankcase heater which has to be energized even when the ice maker is switched-off. So, make sure to connect the unit with the compressor crankcase heater constantly energized. After long inoperative periods remember to give current to the heater 4 hours before the ice-maker start-up.

Fuse protection of the unit should be made as follows:

MAR 56-76-106-126-206 - 3x16 Amps/400V
 MAR 306 WS - 3x24 Amps/400V
 MAR 306 ASR - 3x32 Amps/400V

WARNING - Drum drive motor is three-phases type. At unit start up, correct wiring is assured by 3 phases monitoring relay at power in. In addition proper drum rotation speed is monitored by a Hall Effect sensor. In case the drum is not rotating at all or it rotates too slow (less than 1/4 turn every 30 seconds) a special Electronic Control trips the unit OFF so to avoid that compressor can operate with the drum OFF (in case of fiber keys, drive motor or gear reducer breakage). In case of any field drive motor replacement, care must be taken to its wiring, checking the correct evaporator drum rotation that MUST be toward ice blade. In case of wrong evaporator drum rotation, turn the unit OFF and exchange two phases connection at drive motor control box.

5. WATER SUPPLY AND DRAIN CONNECTIONS

Separate water supplies are recommended.

A. Evaporator or ice making supply water should be run through a hand shut-off valve before entering unit. Evaporator supply water connection has a 3/4" male pipe fitting. This line also has factory installed water strainer internally mounted. Incoming water goes through the float reservoir and then to the drum reservoir. Connect to a good cold water supply with minimum 1/2 O.D. line. A check valve on this line will be required in some cases depending on local plumbing codes. The recommended minimum water pressure

is 1 bar (14 Psi). Do not operate this unit with fresh water supply below 1 bar (14 Psi). Maximum water pressure 5 bar (70 Psi).

B. The condenser water supply line connects to the following fitting sizes:

MAR 56 - 76	3/4" gas male
MAR 106 - 126	12 mm O.D. fitting
MAR 206	20 mm O.D. fitting
MAR 306	25 mm

Water supply line size must be adequate to water flow which, at 15°C temperature water, is:

225 lt/hr	for MAR 56
300 lt/hr	for MAR 76
480 lt/hr	for MAR 106
	lt/hr for MAR 126
1200 lt/hr	for MAR 206
1600 lt/hr	for MAR 306

Incoming water goes throughout the water regulating valve first and then to the water cooled condenser. Observe arrow on water regulating valve. Water supply must be installed to conform with local code. In some case a licensed plumber and/or a plumbing permit will be required.

Water Quality

Water quality is a factor of extreme importance for good operation of MAR machine. Water shouldn't be too hard neither too soft. Hard water will tend to create mineral deposits in water reservoir, evaporator drum and scraping blade, rendering rough the chute surface which prevents ice scales from sliding properly into ice channel. On the contrary, water too soft, (demineralized) will cause the ice skin to stick excessively on drum surface rendering difficult the scraping operation of same.

The ideal water should have a total hardness of about 15-20 french degrees.

Precaution Against Water Frost

Like for any other ice maker all necessary measures must be taken when the cold season is approaching to protect the water supply line and the MAR water system against winter freezing. If cooling tower is used several precautions should be observed, too.

1. Leave water regulating valve in the system.
2. Separate the make-up water for the reservoir from the tower water.
3. Use 3/4" tower water lines or larger, depending on the length of run. Over 30 feet, use 1" O.D. lines.
4. NOTICE: a cooling tower can freeze in the winter time and the MAR flaker will be in operation 12 months per year. An indoor tower and pump can be used with outdoors air ducted in and out if the fan cycles on water temperature to prevent freezing. An indoor sump can be used. An auxiliary tower and city-water hook-up will prove satisfactorily in some climates. Fresh water in the winter and tower water during the summer. Consult your tower and pump manufacturers for proper sizing. In no event should less than a Nominal 3 to 4 tons tower, or less than 3/4 HP high pressure tower, or less than 3/4 HP high pressure tower pump be used.

C. Drain (When not re-used).

The recommenden tubes for the condenser waste line are:

- MAR 56-76 - 3/4" GAS female fitting.
- MAR 106-126 - 12 mm I.D.
- MAR 206-306 - 25 mm I.D.

Water drip tray drain line is 21 m/m I.D. Tube to be connected with clamp to a 21 m/m hose barbed fitting for all models.

Waste water line must run to an open trapped vented drain. If drain is a long run, allow a pitch of 3 cm per meter.

6. REMOTE AIR-COOLED CONDENSER AND PRECHARGED REFRIGERANT LINES INSTALLATION (MAR 306 ONLY)

Use the following for planning the placement of the condenser relative to the ice machine

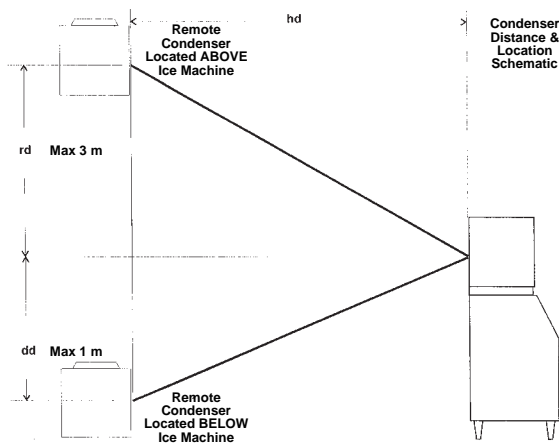

Location Limits - condenser location must not exceed ANY of the following limits:

- Maximum rise from the ice machine to the condenser is **3 physical meters**
- Maximum drop from the ice machine to the condenser is **1 physical meter**
- Physical line set maximum length is **6 meters**
- Line set length maximum is **9 meters.**

Calculation Formula:

- Drop = dd x 6.6 (dd = distance in meters)
- Rise = rd x 1.7 (rd = distance in meters)
- Horizontal Run = hd x 1 (hd = distance in meters)
- Calculation: Drop(s) + Rise(s) + Horizontal Run = dd+rd+hd = Calculated Line Length.

Configurations that do NOT meet these requirements must receive prior written authorization from Scotsman.

Do NOT:

- Route a line set that rises, then falls, then rises.
- Route a line set that falls, then rises, then falls.

Calculation Example 1:

The condenser is to be located 0.9 meter below the ice machine and then 3 meters away horizontally. $0.9 \text{ mt} \times 6.6 = 5.94 + 3 = 8.94$. This location would be acceptable.

Calculation Example 2:

The condenser is to be located 4 meters above and then 3 meters away horizontally.

$4 \times 1.7 = 6.8 \quad 6.8+3 = 9.8$. *9.8 is greater than the 9 maximum and is NOT acceptable.*

Operating a machine with an unacceptable configuration will void the refrigeration system warranty.

In a crate, separated by the unit crate are packed:

1. The air-cooled condenser mounted on the platform base with the electrical junction box, condenser shroud, fan motors, fan protection grid, fan motor speed, control and the refrigerant lines connection couplings.
2. One set of pre-charged refrigerant line with connection couplings on both ends of following variety. Liquid I.D. 12 m/m - Gas I.D. 22 m/m - 6 mts length.

The pre-charged refrigerant lines, 6 meters long, are equipped with self-sealing coupling connections and can be connected or disconnect few times without losing the refrigerant charge. The electric cord line, approx. 6 meters long, located on the left side of the unit has to be connected to the condenser junction box terminals.

The condenser fan motors are originally wired for 230 V single phase and have the following specifications:

- RPM 1300 (1559)
- WATTS 4x70
- AMPS 4x0,7

They operate at 230 V 50 Hz and are controlled by two pressure controls which are connected to the system high side.

The fan controls are set to cut-out and cut-in the fan motor so as to maintain the Hi pressure between 15 and 17 bar.

A. Location consideration:

1. Limit to 6 meters the lenght of the precharged refrigerant lines from the ice-maker to the remote condenser.
2. Maximum vertical rise of 3 meters between the ice maker and the remote condenser.
3. Best available location, protected from the extremes of dirt, dust, rain, sun and wind.

B. Unpacking and inspection:

1. Visually inspect the exterior of the shipping container and any severe damage noted, should be reported to delivering carrier; and a concealed damage claim filled subject to internal inspection with carrier representative present.
2. Uncrate the remote condenser and pre-charged refrigerant lines and inspect for any concealed damage claims, as stated in step 1 above.
3. Check that the pre-charged refrigerant lines are intact, not kinked, and that there is no sealed puncture or loss or refrigerant.

C. Remote condenser - Wall attachment

1. Install and attach the remote condenser to the wall of the building, using the methods and practices of building standards that conforms to and meets the local building code requirements in your area.
2. Removal junction box cover from remote condenser and connect the electrical power lines coming from the unit to the wires of the fan motors by means of the connecting terminal board placed into the junction box following the wires color fitted on the same.

D. Pre-charged refrigerant lines

1. The set of pre-charged refrigerant lines consists of a self-sealing liquid line and a self-sealing discharge line. One coupling on each line is fitted with a Schrader valve, which provides the servicemen with access for refrigerant evacuation through tubes, refrigerant charging and service gauges application when necessary.
2. When possible, route the maximum length of the pre-charged refrigerant lines inside the building, with the minimum length outside, to prevent vandalism and to minimize the condenser effect that exposed lines can produce in cold weather. Insulate lines that will be exposed to outside temperatures that will be below freezing, for extended periods of time.

CAUTION - Each coupling on the set of pre-charged refrigerant lines, the refrigerant fittings on the remote condenser and on the icemaker chassis are self-sealing and should be tightened 1/4 turn more than snug tight. ALWAYS USE TWO WRENCHES WHEN TIGHTENING THESE FITTINGS ONE AS A BACKUP WRENCH TO PREVENT TWISTING OF TUBING AND POSSIBLE KINKING OR LINE RUPTURE.

3. Connect the small dia refrigerant line coupling to the unit fitting labelled "LIQUID" on the right side of the icemaker chassis.
 4. Connect the large dia refrigerant line coupling to the unit fitting labelled "GAS" on the right side of the icemaker chassis.
 5. Connect the small dia refrigerant line coupling with Schrader valve to the condenser fitting labelled "LIQUID".
 6. Connect the large dia refrigerant line coupling with Schrader valve to the condenser fitting labelled "GAS".
- E. Excess length of pre-charged refrigerant lines; at installations where the icemaker chassis-to-remote condenser refrigerant line path is substantially less than the length of pre-charged refrigerant lines to be installed, route

and dress the excess refrigerant line as follows.

1. Follow straight line routing when possible.
2. Retain excess pre-charged refrigerant line inside the building.
3. Spiral the excess length of the precharged refrigerant lines in the best selected inside location and in a manner that prevents refrigerant trapping.

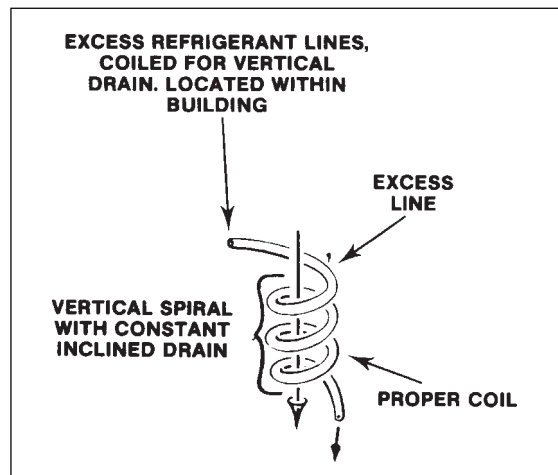

CAUTION - DO NOT kink or crimp the refrigerant lines. DO NOT bend excess refrigerant lines in a vertical loop (s), which allow trapping of refrigerant in LOW sections during OFF time. Bend and shape excess refrigerant lines in VERTICAL spirals, not HORIZONTAL spirals. See Figure above.

7. ICE LEVEL CONTROL

The MAR flake ice system are equipped with and adjustable thermostatic control that cuts off ice making operation when its sensing bulb gets in contact with the ice deposited in the storage bin. The temperature range dial goes from +10°C to -35°C and its long capillary (3.5 m.) attaching the liquid filled bulb, should be conveniently positioned in the storage room at the desired height by holding it with an appropriate bracket to be arranged in accordance with the location possibilities. These controls may or may not be used, it depends of storage room arrangement and its inner temperature that must be higher, anyway, to that of the ice produced. In case of a prevailing low temperature (below -20°C) created by the sub-cooled ice that is staging above the ice level, which will prevent a positive function of the ice level thermostatic control, the thermostatic sensing bulb must be removed from the storage room.

The MAR ice system are also equipped with a timer which allows to present the system operations time in relation to the quantity (level) of the ice desired. This timer function takes place of the ice level control.

8. ICE CHUTE

Mar compact unit are supplied with its own ice chute. In addition optional kits for various solutions are available on request.

9. FINAL CHECK LIST

1. Is the cabinet level 3 (IMPORTANT).
2. Have all electrical and piping connections been made?
3. Has the voltage been tested and checked against the nameplate rating?
4. Is the water supply line shut-off valve installed and electrical wiring properly connected?
5. Have the Bin and Cabinet been wiped clean?
6. Have the compressor hold down bolts been checked to be sure the compressor is floating on the mounting springs?

7. Has the owner/user been instructed on how to operate the ice maker?

8. Has the Manufacturer's Registration Card been properly filled out? Check for correct Model and Serial numbers from serial nameplate then mail the completed card to the Frimont Scotsman Europe Factory.

9. Check all refrigerant lines and conduit lines, to guard against vibration or rugging and possible failure.

10. Is the cabinet in a room where ambient temperatures are a minimum of 5°C (40°F) all year around?

11. Has water supply pressure been checked to insure a minimum of 1 bar (14 psi) and max of 5 bar (70 psi)?

12. Has the owner been given name and telephone number of the authorized SCOTSMAN Service Agency serving him?

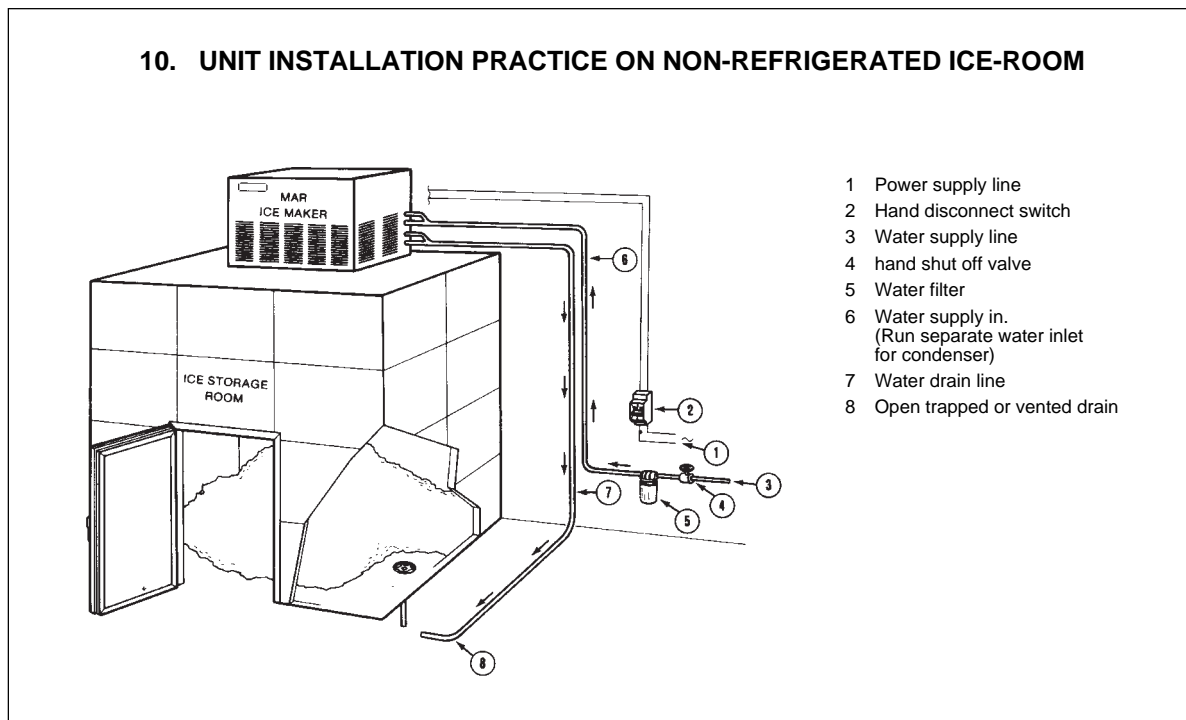

**11. UNIT INSTALLATION PRACTICE ON REFRIGERATED ICE STORAGE ROOM
(Jacket system)**

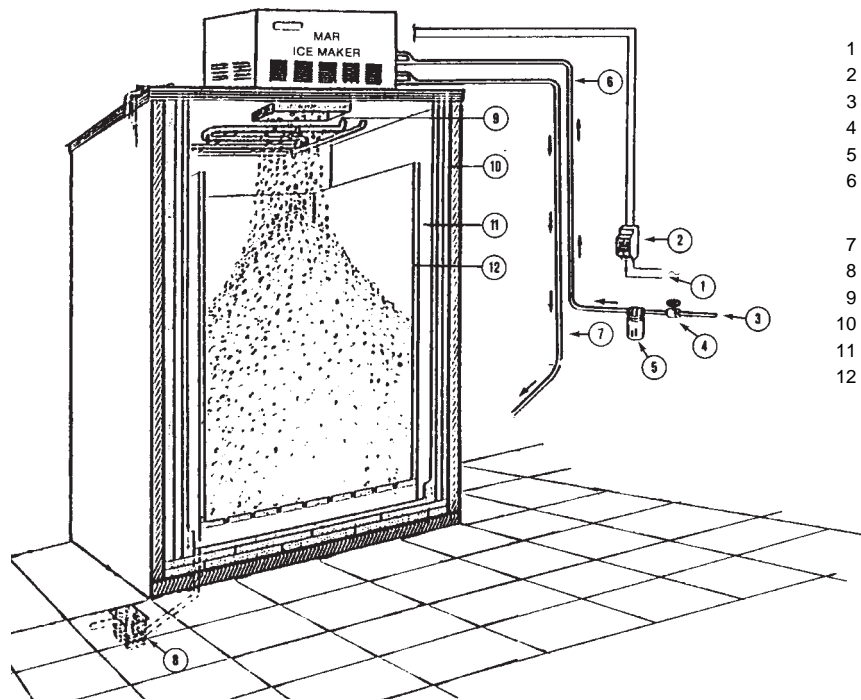

- 1 Power supply line
- 2 Hand disconnect switch
- 3 Water supply line
- 4 Hand shut off valve
- 5 Water filter
- 6 Water supply in.
(Run separate water inlet for condenser)
- 7 Water drain line
- 8 Open trapped or vented drain
- 9 REFRIGERANT COIL
- 10 Insulated panel
- 11 Air gap
- 12 Ice bulkhead

MAR 306 REMOTE CONDENSER

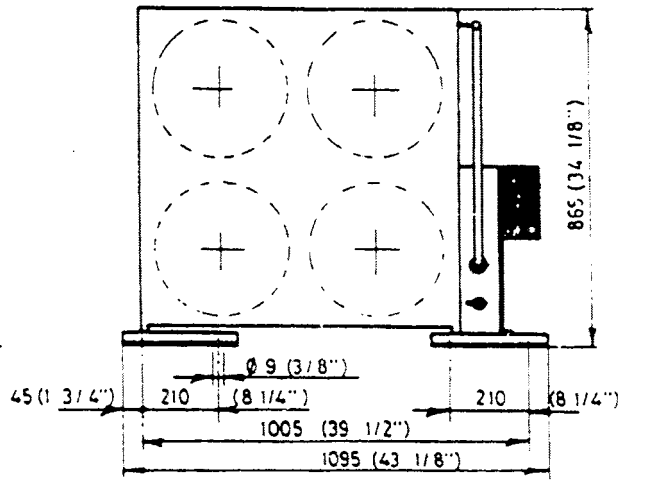
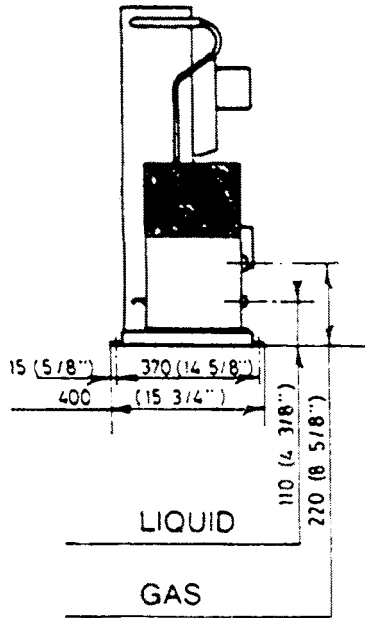

AIR COOLED

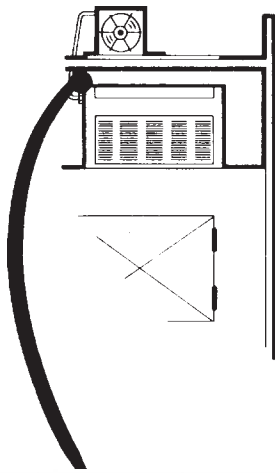

Installation on roof or any location higher than the icemaker.

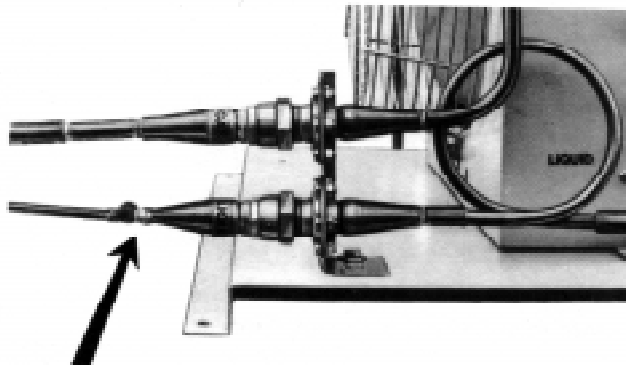
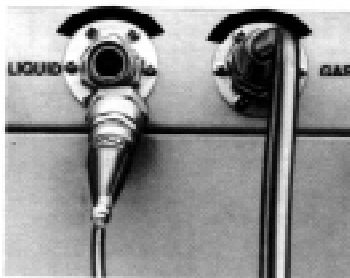
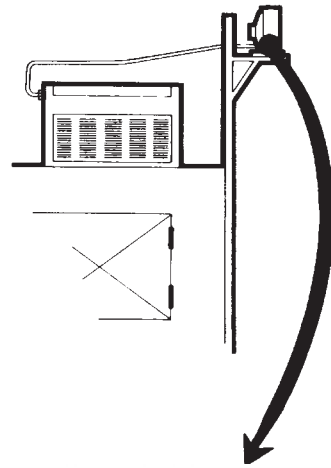

Service Schrader valves

SEZIONE II

OPERATING INSTRUCTION

1. COMPLETE UNIT START-UP

1. Remove all panels and open the water supply line shut-off valve for both the evaporator drum and in the case of a water cooled machine, to the condenser.
2. Observe the water filling operations.
 - a) Water flows into the float reservoir first.
 - b) Water is filling the freezing drum basin.
 - c) Float moves up as water level rises in water reservoir.
 - d) Float stops water flow when water reaches suitable operation level.
Now, water surrounds bottom half of freezing drum.
3. Move the manual ON-OFF toggle of main disconnect switch to ON position. The green light on console panel will glow.
4. MAR uses an electrical "three phases monitoring relay" which alerts installer in case of wrong wiring by keeping green LED ON only. In this case change phase connection wiring.



5. Correct wiring is shown by both LEDs Green and Orange steady ON together.

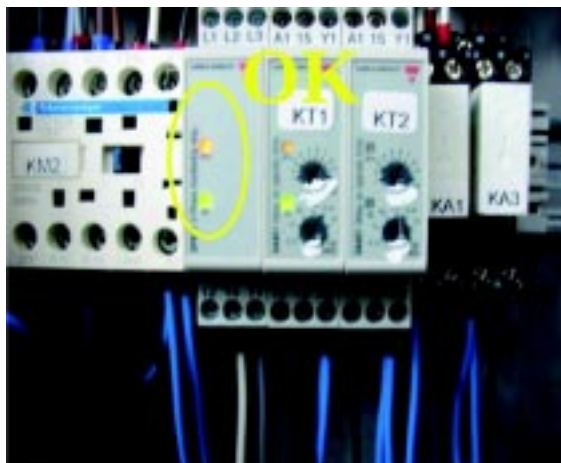

6. Observe immediately that evaporator drum rotates in the right direction, namely toward the scraping blade.
7. Meanwhile unit is under power KT1 relay compressor device is energized as well in order to delay compressor start up by 18'. Later (KT1 orange LED blinks during this delay). On normal operation - compressor ON - KT1 LEDs (orange and green) are steady ON together.



NOTE. In case on any temporally Ice maker trip OFF (not alarm) due to NO/LOW water pressure, bin full, ice spout switch activation unit stops by only keeping drive motor operating for 18' in order to clear evaporator by ice. KT2 delay relay LEDs steady ON (orange and green) during this delay.



WARNING - Correct Drum rotation - The evaporator drum drive motor is a threephase motor wired for 400 V. It is of extreme importance to check immediately upon unit start-up that motor rotates **CLOCKWISE** in order that gear motor pulley rotates in the direction of the **ARROW**. Should the motor turn counterclockwise, it is necessary to instantly switch-off the unit and interchange one polarity at terminal block connection of main electric cord.

Motor Shaft Pulley

MAR units are generally equipped with two pulleys (not on MAR 126) and by changing from one to the other the speed of drum can be changed.

MAR Machines are factory delivered with pulley to rotate the evaporator drum at the lowest possible R.P.M. to obtain "THICK" (2 mm gauge) scale ice. Replacing standard by alternative/supplied pulley on motor shaft evaporator drum R.P.M. increases to the point to produce "THIN" (1 mm gauge) scale ice.

8. Make sure that the automatic expansion valve opens and that refrigerant fluid starts to flow through it.

NOTE. At first compressor start-up, the suction pressure declines rapidly to 0.2 bar, causing the intervention of the pressure control, which will interrupt the entire unit operation. This control being automatic re-set type, will resume the unit operation after few seconds. The unit will start and stop few more times, due to the lo-pressure control cut-out and in, until system refrigerant pressure set on their normal values.

9. After two or three minutes of operation, observe that ice skin begin to form on the revolving drum surface and it is scraped by the blade.
10. Left the system operate for about 20 minutes. Check for any excess noise beyond normal compressor noise.
 - a) Vibrating type from touching lines.

- b) Compressor loose at one or more holddown bolts.
- c) Drivemotor pulley misaligned with gear box pulley causing V belt vibration.
- d) Check compressor oil level through sight glass (Except MAR 56/76/106/126).

11. On water cooled machine check the water flowing out from condenser to see if it is correct. Cooling water flow is controlled by a pressure water regulating valve. No valve adjustment of water valve should be necessary unless the inlet temperature of cooling water is relatively high. Normal head pressure should be 17 bar on MAR 56, MAR 76, MAR 106 and MAR 126; 16 bar on MAR 206 and 14 bar on MAR 306.

12. Observe that evaporator drum is frosted all-over from end to end. If this is not the case setting of the refrigerant expansion valve may be necessary. For proper adjustment of this valve turn the valve setting stem of one eight of a turn counterckwise to allow more refrigerant flow until the evaporator drum surface is evenly frosted from end to end. In case you have an excessive frost back in the suction line and frost starts to form on compressor suction service valve slightly turn clockwise the expansion valve setting stem until the frost back on compressor service valve melts over.

The suction pressure should range between 0.6 bar and 2.5 bar depending on model, water temperature and level.
See indications on page 25.

2. WATER AND REFRIGERANT CIRCUIT

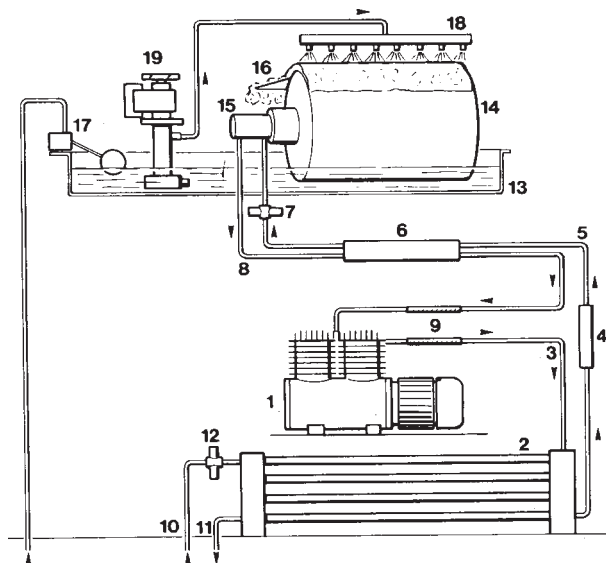

- | | | |
|-------------------|-----------------------------|-----------------------------|
| 1. Compressor | 7. Expansion valve | 13. Drum water basin |
| 2. Condenser | 8. Vapor line | 14. Evaporator drum |
| 3. Discharge line | 9. Vibration absorbers | 15. Refrig. lines manifold. |
| 4. Drier | 10. Condensing water-inlet | 16. Scraping blade |
| 5. Liquid line | 11. Condensing water-outlet | 17. Float reservoir |
| 6. Heat exchanger | 12. Water regulating valve | 18. Spray bar |

13. Thoroughly explain the owner/user the significant specifications of the MAR ice maker, the start-up and operation, going through the procedure in the operating instructions. Answer all questions about the icemaker, by the owner and inform the owner of the name and telephone number of the Scotsman Service station serving him.
14. Fit and secure all unit panels previously removed.

WARNING - Whenever stopping the machine to keep it off operation for some time, it is recommendable to shut close the water inlet valve to interrupt the water supply.

SECTION III

PRINCIPLES OF OPERATION - HOW IT WORKS

1. ICE MAKER

The revolving drum which may be of different size depending on the ice maker capacity, is basically made of a cylinder skeleton covered by a stainless steel jacket.

A channel, about 15 m/m deep and 15 m/m wide is machined in a spiral pattern that goes from one end to the other of the cylinder skeleton.

The end of the machined channel communicate with a bore made in the left cylinder journal. The head manifold on the left side is for both liquid refrigerant inlet and vapor refrigerant outlet.

When cylinder metal jacket is forced and sealed on the cylinder skeleton, the spiral pattern channel made for the refrigerant flow becomes virtually the evaporator serpentine.

The metered refrigerant that reaches the evaporator serpentine by passing through the bore in the left side cylinder journal, boils and evaporates as it comes in contact with the drum metal jacket. About one third on the cylinder drum is constantly submerged in water.

This will allow the cylinder metal jacket to draw a film of water that, as soon as it comes afloat, freezes almost instantly due to the heat absorption created by the boiling refrigerant circulating in the inner serpentine and scrubbing with the jacket inner surface.

The ice layer of the emerged cylinder sector has a fraction of time to solidify, dry and eventually subcool before contacting the edge of the horizontal scraping blade.

The scraping blade, of heavy duty metal, cause the peels off of the ice sheet formed on the drum jacket by racking it while it advances on the revolving drum.

The ice sheet is so dry that, when it gets in contact with the scraping blade, it cracks in a form of irregular shaped chips. The refrigerant leaves the evaporator serpentine to return to the compressor via suction line through the bore of the head manifold on the left side cylinder.

The refrigerant sealing in the manifold is assured by an especially designed sealing device.

The cylinder is driven by a separate drive motor and gear reducer located on the right side.

Four motors are constantly in motion:

- a) the compressor
- b) the drive motor
- c) the fan motor
- d) water pump

The gear reducer, the driving belt with its pulley and the revolving drum with the rotating part of the sealing devices are the mechanical parts in motion.

2. PRINCIPLES OF OPERATION - HOW IT WORKS

1. Water drawing area
2. Water sprayed freezing cooling area
3. Sub-cooling area
4. Water reservoir float valve
5. Water feeding line
6. Scraping blade
7. Spray bar
8. Water reservoir
9. Revolving drum
10. Water pump
11. Water drain hole

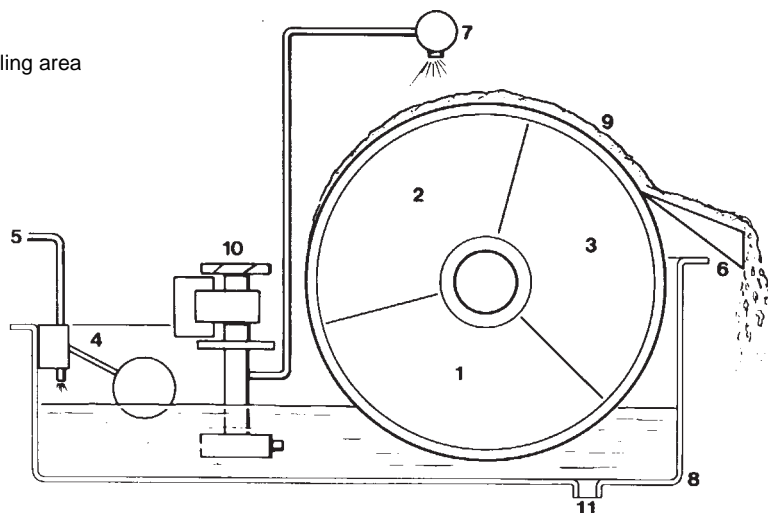

3. ELECTRICAL / REFRIGERATION

The electrical circuit consists of the compressor motor, drive motor, water pump, condenser fan motor and control (on air cooled version), main controls (ON-OFF compressor Switch - Timer - Contactor), safety controls - Thermal protection for compressor - Hi and Lo pressure switches - water failure switch, compressor and drive motor delay timer, three phases monitoring relay.

A. Compressor unit - (see Technical Specification Table for H.P.).

The compressor used on the MAR 56 - 76 - 106 - 126 is hermetic reciprocating type compressors while on MAR 206 and 306 is semihermetic type. All of them operating with R 404a.

All compressors are equipped with a crankcase heater element and are thermally protected. Cooling is achieved with refrigerant passing through suction valve and by a separate fan motor on water cooled version only.

a) Compressor Crankcase Heater

Must be constantly energized particularly during OFF period of ice maker operations. The temperature provided by the heating element into the crankcase prevents that refrigerant dilutes with oil.

b) Compressor Thermal Protector (Thermistor) on MAR 206 and 306

A thermistor is a solid state semiconductor which permits or allows more electrons to flow through it as the material's temperature increases. Today thermistors are used in place of a bimetal strip or in place of a temperature sensitive power element as a safety device in electric motors by stopping the electric power flow to a motor if the motor windings temperature increases to the danger point.

B. Drive Motor

The evaporator drum drive motor is a three phase motor of 1/2 HP wired for 380/220 Volts 50/60 Hz - 1,2/2,1 Amps - 1400 R.P.M. with inherent thermal protector.

IMPORTANT - When this motor is disconnected or the entire unit is disconnected, it is necessary - **when resuming the electrical connection to immediately make sure that drive motor rotates clockwise facing the unit front.**

Failure to this, may result in wrong rotation of evaporator drum with the risk of major damages to the system.

C. Timer

It will be mainly used to pre-set the system operation time in relation to the desired amount to ice.

Therefore it takes the function of an Ice Level Control in the storage area. This timer can be remotely located if desired.

D. Hi Pressure Cut-Out Hand Reset

This high pressure control prevents operation at high refrigerant pressure.

Shuts-off entire system in case of water failure to condenser on water cooled units and of fan motor failure on air cooled machines.

Factory cut-out setting are:

air cooled	34±2 bar (480±30 psi)
water cooled	30 bar (420 psi)

E. Water Failure Switch

This switch used as safety device when low or interrupted supply water conditions are encountered.

Operates on pressure between supply line and feed line to water reservoir.

Range is 0.5 bar (7 psi) off and 0.8 bar (12 psi) on.

Cuts off complete unit and Resets automatically.

F. Lo-Pressure Cut-Out Automatic Reset

Lo Pressure Control prevents operation at vacuum refrigerant suction pressure.

Shuts off entire system in case of refrigerant failure in the system.

Factory setting cut-out: 0,2 bar.

G. Condenser Fan Motor Air Cooled Units

The fan Motors used are permanent capacitor type fan motors. Electrical supply to the fan motors is 230 V, 50 Hz - 0,7 Amp. for MAR 56, 76, 106, 126 10 and 306 - 0,9 Amp. for MAR 206.

H. Fan Motor Pressure Control











MAR Air Cooled version are equipped with a pressure control which is a reverse acting automatic re-set control directly connected to the fan motor. Its function is to maintain the head pressure between the cut-in and cut out setting values which are 15÷17 bar.

I. Control Console

Located on the front of the unit cabinet, is a visual control console that monitors unit performance automatically.

Any interruption or significant reduction in water or electrical supply causes an instant stop to the operation of the MAR flaker system. At the same time a warning light is activated on the control console telling the user of the ice maker stoppage and also the reason why.

If the stoppage is caused by its refrigerant pressures or overloading in the compressor a red light glows. Both controls that activate the red lights are manual reset type controls, therefore the cause of the stoppage should be diagnosed and corrected before reoperating the ice maker.

	HI PRESSURE TOO HIGH
	WATER PRESSURE TOO LOW
	ICE LEVEL CONTROL CUT OUT
	COMPRESSOR PROTECTOR CUT OUT
	WRONG 3-PH MONITORING
	SPOUT SWITCH CUT OUT
	LOW SUCTION PRESSURE CUT OUT
	GEAR MOTOR THERMAL PROTECTOR CUT OUT
	SLOW-NO DRUM ROTATION CUT OUT
	IN OPERATION

J. Water Cooled Condenser

Tube within a tube condenser.

K. Water Regulating Valve

Penn made. Valve must be set to maintain head pressure at 17 bar (240 psi) for MAR 56-76, 15 bar (210 psi) for MAR 106-126, 16 bar (225 psi) for MAR 206 and 14 bar (195 psi) for MAR 306.

L. Automatic Expansion Valve (A.E.V.) M.O.P.

The automatic expansion valve controls the refrigerant when passing from the liquid line to the evaporator. As the pressure decreases on the low side, the expansion Valve open and refrigerant escapes into the evaporator drum channel where it absorbs heat from water while evaporating. The valve maintains a constant pressure in the evaporator coil when the system is running independently of the amount of refrigerant in the system.

This valve has an adjustment which may be manually regulated to give the evaporator coil the desired amount of refrigerant.

Turning the adjustment to the left, counterclockwise, will increase the rate of flow which is controlled by the pressure in the evaporator.

When the compressor is not running the valve will remain closed as the low side pressure will be high enough to close the expansion valve.

- MAR 56 -76 - 106 - 126 are generally equipped with an expansion valve having an orifice of 2,5 mm set for 3,0 bar of pressure.

- MAR 206 - 306 is also equipped with an expansion valve having an orifice of 4,5 mm set for 3.0 bar of pressure.

M. Evaporator Drum

Refrigerant inlet/outlet takes place on left side journal.

The drum body is covered by a jacket in special stainless steel resistant to the water corrosion.

The front edge of the scraping blade must have a clearance of minimum 0.05 mm from cylinder metal jacket.

N. Refrigerant Seal System

Housed in the refrigerant inlet/outlet manifold located on the evaporator drum left side journal, is a leakproof joint. This joint is made with seals that are carefully designed and installed. The seals use two rubbing surfaces. One surface turns with the cylinder journal and is sealed on it with an O ring of synthetic material. The other surface is stationary and fitted in its housing with leak-proof O ring.

The rubbing surfaces (optically flats) are made of two different material that are: hardened steel for the rotating ring and graphite for the stationary ring.

The rotating parts are:

- a) the clip retainer ring
- b) the spring collar
- c) the compression spring
- d) the stainless steel seal ring with O ring.

The stationary parts are:

- a) the graphitic ring with O ring
- b) the stainless steel housing ring with gasket and O rings.

O. Heat Exchanger

A heat exchanger is mounted in the suction and liquid line to reduce flash gas in the liquid line, to reduce liquid refrigerant in the suction line and to subcool the liquid refrigerant thereby increasing the operating efficiency.

P. Sight Glass

A sight glass is installed in the liquid line. The sight glass will show bubbles if the system is low on refrigerant.

Q. Filter Drier

All MAR units mount a "Solid-core antiacid filter drier" on liquid line. This drier may be installed in any position provided that the arrow on its body point in the direction of refrigerant flow.

R. Contactor

MAR contactors have 3 or 5 contacts normally open and 1 contact normally closed. The N.C. contact is generally used to keep the crankcase heater energized during the OFF periods. The contactor coil is generally at 230 V 50 Hz 1 Ph and kept energized by the system controls that are connected in series.

S. Thermostat (Ice level control)

When storage room temperature is higher to that of the ice being made, the ice level can be positively controlled by this thermostat, the sensing bulb of which must be positioned to the wanted level that will, obviously correspond to the desired ice level in storage room.

The temperature range dial must be set on to the proper temperature in order that the control may cut-out or may cut-in respectively when its sensing bulb gets buried into the ice cone and when is freed from the ice.

This thermostat can be a valid control if it is used in non-refrigerated storage rooms as in these cases it is influenced just by the ice temperature.

T. Ice Spout Safety Switch

Located on top of the Ice Spout, the Safety Switch is operated by a plate on top of the ice chute by the ice backing up in the spout. The switch will shut-off the entire ice making mechanism.

U. Ice Level Control

Must have its sensing capillary extended into ice room in a way that it could be contacted by the ice when storage ice room becomes filled. It terminates ice production when its capillary gets in contact with ice. It is wired in series with all other controls. It is factory set to cut-out at 1,5°C and cut-in at 4°C.

V. ON/OFF switch

The manual start-up or switching of the entire system requires the attention of the operator who may instantly keep control of the situation, supplied.

W. Compressor Delay timer

Delays the start up of the compressor by 18' at every start up of the ice maker. Supplied.

X. Drum rotation delay timer

Delays drum STOP by 18' at every trip OFF of the ice maker. Supplied.

Y. 3 - phases monitoring relay

On the power IN, it checks and assures correct rotation of the drive motor - evaporator drum. Supplied.

Z. Drum rotation control

It operates using the Hall effect sensor / principle. In case the drum is not rotating at all (or it rotates too slow - less than 1/4 turn every 30") such relay trips the unit OFF so to avoid that in case of fiber keys breakage, the drive motor - gear reducer and compressor can operate with the drum OFF. Supplied.

4. REFRIGERANT CHARGE

WATER COOLED MODELS

The below refrigerant charge is approximate. When charging, set at 15 or 17 bar head pressure according to the model and charge so that frost line extends out of the evaporator two third way to compressor after fifteen minutes of operation.

AIR COOLED MODELS

When charging set at 16 bar (225 psi) the head pressure.

REFRIGERANT CHARGE AND OPERATING PRESSURES

	MAR 56-76		MAR 106		MAR 126		MAR 206		MAR 306	
	A	W	A	W	A	W	A	W	A	W
Refrig. charge (gr)	1500	1000	2000	1150	2200	1250	4100	2300	5900	2500
Head press. (bar)	15-17	17	15-17	15	15-17	15	15-17	16	15-17	14
Head press. (psi)	212-245	245	212-245	212	212-245	212	212-245	230	212-245	200
Suction press. (bar)	2.2	1.8	1.6	1.6	1.6	1.6	1.9	1.9	1.0	1.75
Suction press. (psi)	32	26	23	23	23	23	27	27	14	11

5. MECHANICALS

A. Motor Shaft Pulley

MAR units are generally equipped with two pulley and by changing the belt from one to the other, the speed of drum can be changed. MAR Machines are factory delivered with pulley to rotate the evaporator drum at the lowest possible R.P.M. to obtain "THICK" (2 mm gauge) scale ice. Replacing standard by alternative/supplied pulley on motor shaft evaporator drum R.P.M. increases to the point to produce "THIN" (1 mm gauge) scale ice.

	R.P.M. for "thick" ice	R.P.M. for "thin" ice
MAR 56 AS/WS	0.9	1.25
MAR 76 AS/WS	1.1	1.25
MAR 106 AS/WS	1.5	2.3
MAR 126 AS/WS	2.4	****
MAR 206 AS/WS	1.05	1.6
MAR 306 AS	1.6	2.9
MAR 306 WS	1.8	2.9

V belts used on motor shaft pulley and gear box are type:

MAR 56	MAR 76	MAR 106	MAR 126	MAR 206	MAR 306
XPZ750		XPZ 900		XPZ 937	

B. V Belt

V belt used on motor shaft pulley and gear box. When changing the V belt be careful to adjust it for proper tension and alignment. It should be snug not tight. A way to roughly check belt tension is to apply a firm hand pressure in the middle of the longest belt span. If the belt is correctly tensioned, you should be able to depress it about 10 mm out of line.

C. Gear Reducer

Then gear reducer is mounted on the right side frame of evaporator drum basin to which it is firmly secured with four nuts. The gear reducer bore in which passes the drum shaft to be driven, has a keyway. Two fiber keys are used to engage the gear reducer to the drum shaft, they are in series in the gear reducer bore, and shaft keyways. Should the driving strain be excessive, the two fiber keys will shear. MAR 56-76-106-126 are equipped with a gear reducer having a ratio of 1/600. MAR 206 and 306 have a gear reducer with a ratio of 1/552. The gear reducers are greased for life, therefore they do not require any maintenance.

SECTION IV

ADJUSTMENT & REMOVAL & REPLACEMENT PROCEDURES

The procedures provided in this section are arranged in order to make specific adjustment and removal and replacement information easy to locate.

Read the instructions thoroughly before performing any adjustment or removal or replacement procedures.

1. ADJUSTMENT OF THE WATER REGULATOR ASSY (Water Cooled Models)

Adjustments can be performed on the Water Regulator Assembly to increase or decrease the head pressure.

To adjust the Water Regulator Assembly:

- A. To INCREASE the Head Pressure: rotate the adjusting screw on the Water Regulator Assembly IN or CLOCKWISE.
- B. To DECREASE the Head Pressure: rotate the adjusting screw on the Water Regulator Assembly OUT or COUNTERCLOCKWISE.

2. ADJUSTMENT OF THE AUTOMATIC EXPANSION VALVE

The end to end frost on evaporator drum is the result of the correct expansion valve setting.

This valve may be manually regulated by means of the adjusting stem.

Turning the adjustment to the left counterclockwise, will increase the rate of refrigerant flow.

Turning the adjustment to the right (clockwise), the refrigerant flow to the evaporator is reduced. Use hex head wrench for manual adjusting operations.

WARNING - Be sure the electrical power supply and water supply are OFF, before starting any of the following REMOVAL AND REPLACEMENT procedures as a precaution to prevent possible personal injury or damage to equipment.

3. CHANGING V BELT FROM SMALLER PULLEY GROOVE TO LARGER PULLEY GROOVE TO MAKE THIN ICE.

1. Remove top, front right panel and right side panels.
2. Through the front, by means of socket wrench, slightly unloose two head hex screw securing the sleigh that supports the motor.

3. Through the right side, slightly unloose the nut located in correspondence of the sleigh button hole.
4. The sleigh with the motor should be able to slide vertically.
5. Slid-off V belt from motor pulley.
6. Unloose and remove hex head screw that secure step pulley on motor shaft.
7. Remove step pulley from motor shaft and replace the same with alternative-supplied one.
8. Tighten pulley on motor shaft by means of hex head screw previously removed.
9. Place V belt on groove of motor pulley and of gear box pulley.
10. Raise the sleigh with motor and pulley to give a rough tension to V. Belt.
11. Tighten slightly the two hex head bolts and the nut previously unloosed.
12. Correct tension of V belt by moving upward or downward the Sleigh/Drive Motor assembly.
13. When satisfied with V belt tension, which should be snug but not tight, proceed to definitively tighten the hex head bolts and nuts that secure motor support sleigh to side frame of drum basin.

4. REMOVAL AND REPLACEMENT OF THE COMPRESSOR ASSEMBLY

NOTE. Always install a replacement Drier, anytime the sealed Refrigeration System is opened. Do not replace the Drier until all other repairs or replacements have been completed.

- A. To remove the Compressor Assembly:
 - 1) Remove cover from the Compressor Junction Box.
 - 2) Disconnect the electrical leads at the Compressor Junction Box that originate in the Control Box.
 - 3) Recover the refrigerant from the system and transfer it in a bottle so to reclaim or recycle it.
 - 4) Disconnect the suction line from the compressor.

- 5) Disconnect the discharge line from the compressor.
 - 6) Remove four bolts, lockwashers and washers which secure the compressor to the Chassis mounting base.
 - 7) Slide the compressor and remove it through the rear side opening of the Cabinet.
- B. To replace the Compressor Assembly, reverse the removal procedures.

5. REMOVAL AND REPLACEMENT OF THE WATER COOLED CONDENSER.

NOTE. Always install a replacement Drier, anytime the Sealed Refrigeration System is opened. Do not replace the Drier, until all other repairs or replacements have been completed.

- A. To remove Condenser:
- 1) Recover the refrigerant from the system and transfer it in a bottle so to reclaim or recycle it.
 - 2) Unsolder the refrigerant inlet and outlet lines from the condenser.
 - 3) Disconnect the water inlet and outlet lines from the condenser.
 - 4) Remove bolts, lockwashers and washers which secure the Condenser to the Chassis mounting base.
 - 5) Remove the Condenser from cabinet.

NOTE. Thoroughly evacuate the System to remove moisture and non-condensable.

- B. To replace the Condenser, reverse the removal procedures.

6. REMOVAL AND REPLACEMENT OF THE WATER REGULATOR ASSEMBLY (Water-cooled Models)

- A. To remove the Water Regulator Assembly:
- 1) Recover the refrigerant from the system and transfer it in a bottle so to reclaim or recycle it.
 - 2) Unsolder the capillary line from the Water regulator assembly where connected at the process header.
 - 3) Disconnect the water inlet line at the rear of the water regulator.
 - 4) Disconnect the condenser water inlet tube at the front of the water regulator.
 - 5) Remove two screws, lockwashers and washers which attach the Water Regulator Assembly bracket to the Chassis base and remove the Water Regulator Assembly and bracket.

NOTE. Thoroughly evacuate the System to remove moisture and non-condensables.

- B. To replace the Water Regulator Assembly reverse the removal procedures.

7. REMOVAL AND REPLACEMENT OF THE DRIER

- A. To remove the Drier:
- 1) Recover the refrigerant from the system and transfer it in a bottle so to reclaim or recycle it.
 - 2) Unsolder the refrigeration lines at each end of Drier and remove the Drier.
- B) To replace the Drier:

CAUTION - 1. If the factory seal is broken on the replacement drier, exposition it to the atmosphere, more than a few minutes, the Drier will absorb moisture from the atmosphere and lose substantial ability for moisture removal. **2.** Be sure the replacement Drier is installed with the arrow positioned in the direction of the refrigerant flow.

- 1) Remove the factory seals from the replacement drier and install the drier in the refrigerant lines with the arrow positioned in the direction of the refrigerant flow.
- 2) Solder the refrigeration lines at each end of drier.
- 3) Purge the system and check for leaks.
- 4) Thoroughly evacuate the system to remove moisture and non-condensables.
- 5) Charge the system with refrigerant, by weight. SEE NAMEPLATE.
- 6) Re-mount all Service Panels.

8. INSTRUCTION FOR REMOVAL AND REPLACEMENT OF REFRIGERANT MECHANISMS OF SCOTSMAN ICE MAKERS "MAR" SERIES

1. Before removing the refrigerant manifold it is necessary - at first - to close the valve on liquid line. Upon low pressure switch cut-off, the main switch must be put in "OFF" position, then it is necessary to purge the refrigerant system. After these operations, the flare fitting at the inlet of refrigerant manifold can be disconnected as shown.
2. Remove the 4 allen screws of refrigerant outlet fitting to manifold.
3. Unloose and remove the 6 nuts with respective washers that secure the refrigerant manifold (1).
4. When removed the refrigerant manifold unloose and remove one of the three screws (11) securing the seal mechanism ring to the drum shaft journal.

5. Fit in place of it the screw of 4 MA supplied in the kit then tighten its nut.
6. Gradually unloose the two remaining screws and the nut till release the spring of seal mechanism.
7. Unloose the last screw to remove the seal mechanism ring as well as the seal mechanism S.S. ring and its spring.
8. Withdraw entirely the stainless steel ring (6) that houses the graphitic seal ring.
9. Check to see the surface conditions of cylinder shaft journal. It is of extreme importance that this surface be clean, smooth and polished. In case of scored surface it is necessary to stroke on it a very fine sand paper stripe. Check to see that washer (5) be properly clean and positioned with keyway to match the key.
10. If necessary replace the 0 rings of the S.S. ring that houses the graphitic ring.
11. Proceed attentively to examine the graphitic surface of the seal ring. If this surface is no more perfect and optically flat, proceed to replace the seal ring in the following way. Lubricate the outer surface of the new seal ring with compressor oil and place it at the inferior of the housing ring.
12. Place on drum shaft the steel ring housing the graphite.
13. Mount on drum shaft journal the remaining portion of seal mechanism (S.S. ring and spring) (9) then the seal mechanism ring (10).
14. Fit the screw of 4 MA with its nut in one of the three threaded holes then screw down the nut in order to compress the spring.
15. When the seal mechanism spring has been partially compressed fit the other two screws and full compress the spring by screwing down gradually the three tightening point.
16. After have tightened the screws unloose the tie rod screw and replace it with the third one.
17. Clean carefully the inner surface of refrigerant manifold. Check to see the good condition of the seal ring (8) and fit it in its seat inside the refrigerant manifold. Fit on shaft end the washer (12) which keeps in place the seal ring (13) inside the refrigerant manifold and fit inside the manifold the gasket.
18. Position the manifold on the six monting studs, fit the six mounting nuts and washers and tighten all them down by means of a 10 mm. wrench.
19. Connect the outlet refrigerant line to the corresponding port of the manifold and tighten it with the four head needed screw.
20. Connect the refrigerant inlet line on its manifold fitting and tighten the fitting flarenut.

9. REMOVAL AND REPLACEMENT OF THE DRIVE MOTOR

- A. To remove the drive motor assembly:
 - 1) Remove screws and front, top and right side panels.
 - 2) Slid-off V belt from motor pulley.
 - 3) Unloose and remove hex head screw securing the pulley to motor shaft.
 - 4) Disconnect wire leads to motor.
 - 5) Remove two hex head bolts, lockwashers and washer, and nut which attach the sleigh support plate of motor to the side frame of evaporator drum basin.
 - 6) Lift the sleigh plate with the drive motor out of the Chassis.
 - 7) Unloose and remove 4 Nuts securing the motor to the sleigh plate.
- B. To replace the Drive Motor Assembly reverse the removal procedure.

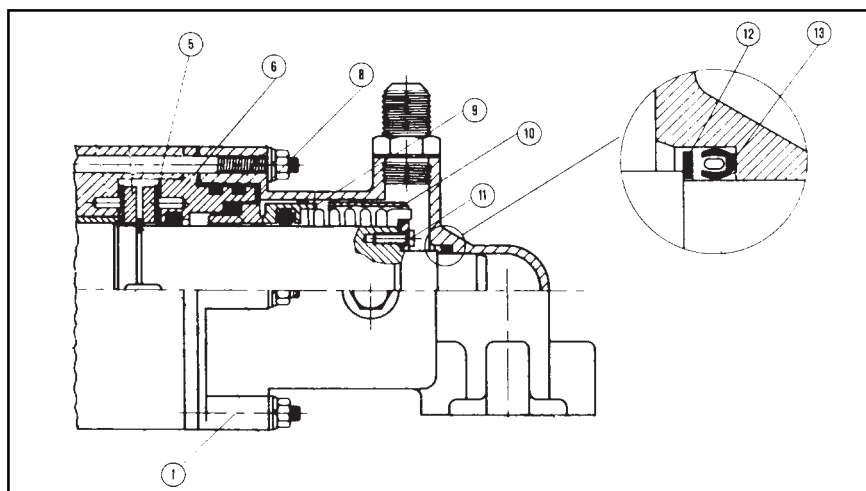

10. REMOVAL AND REPLACEMENT OF GEAR BOX

- A. Remove screws and front, top and right side panels.
- 1) Slid-off V Belt from gear box pulley.
 - 2) Remove screw securing pulley on gear box input shaft.
 - 3) Remove four nuts and washers which secure the gear box to the evaporator basin side frame.
 - 4) With a mallet hit a bit the gear box to create some looseness.
 - 5) With the help to two screw driver inserted between basin wall and flanged end of gear box, force the gear box to clear away from basin wall if you encounter an excessive resistance in this. It better to use a Puller.

- 6) When gear box is cleared away from the wall where it is mounted, pull it out from cylinder shaft.
- B. To install the Gear Box Assembly reverse the removal procedure taking care to center keyway of gear box bore to keys on cylinder shaft.

11. REPLACEMENT OF FIBER KEYS

- A. The replacement of fiber keys is necessary only when the keys are broken, so that they do not engage the gear motor with the evaporator drum drive shaft. In practical terms, the gear box does not drive the evaporator drum.
- B. To reach the fiber keys to be replaced it is necessary to remove the complete gear box. For this operation perform all steps at point 11.

SECTION V

MAINTENANCE & CLEANING INSTRUCTIONS

1. GENERAL

The periods and procedure for maintenance and cleaning are given as guides and are not to be construed as absolute or invariable.

Cleaning especially will vary depending upon local water conditions and the ice volume produced and each ice maker must be maintained individually in accordance with its own particular location requirements.

2. ICEMAKER

THE FOLLOWING MAINTENANCE MUST BE SCHEDULED AT LEAST TWO TIMES PER YEAR ON THIS ICE MAKER. CALL YOUR AUTHORIZED SCOTSMAN SERVICE AGENCY.

1. Check and clean water line Strainer in water inlet fittings.
2. Remove top panel and evaporator cover depress the float to ensure that a full stream of water enters Drum Reservoirs.
3. Check that the ice maker cabinet is level in side-to-side and front-to-rear directions.
4. Clean the drum basin and exterior of the drum assembly using a solution of SCOTSMAN Ice Machine Cleaner. Refer to procedure VI-3, CLEANING ICE MAKER.

NOTE. *Cleaning requirements vary according local water conditions and individual user operation.*

5. When doubtful about refrigeration charge, check gauge for compressor head pressure. Please refer to the operating pressures as printed on page 26.
6. Check gauge for Suction Line Pressure which varies between:

2.2 bar (32 psi)	MAR 56-76 AS
1.8 bar (26 psi)	MAR 56-76 WS
1.6 bar (22 psi)	MAR 106-126 AS-WS
1.9 bar (27 psi)	MAR 206 AS-WS
1.0 bar (14 psi)	MAR 306 AS
0.75 bar (10 psi)	MAR 306 WS

 Depending upon water inlet temperature.
7. Check setting and function of all the pressure controls also make sure that their corresponding lights will glow.
8. Check drive motor operation. Normal operating temperatures are about 60°C (160°F) which is hot to touch. Check with amperometer Amps drawn.
9. Check V belt for concealed signs of wear and that has the correct tension. Check pulleys alignments and also that drive motor and gear box hold down bolts are tight enough.

10. Make sure that water lines in water cooled condenser are free from any excess of water minerals: otherwise arrange to clean the tubes with a power driven wire brush or running through it a weak acid solution made with 20 percent of hydrochloric acid.
11. Check for refrigerant leaks and for proper frost line, which should frost out of accumulator at least half way to the compressor and in some areas, back to service valve.
12. Check for water leaks. Tighten drain line connections. Pour water down drain to be sure that drain line is open and clear.
13. Check the quality of ice. Ice flakers should be dry and have a thickness gauge of about 1.5÷2.0 mm.
14. Check the thermostatic Ice Control Bulb (whenever used) location and thermostatic function.
15. Check compressor oil level through sight glass (where used). Stop unit operation and after 10" see that oil level is 2/3 millimeters above center line of sight glass.
16. Be sure that plexiglass chute at spout opening is securely fastened with its hold down button and that its surface is smooth and clean from any water mineral deposit.

3. CLEANING INSTRUCTION

1. Disconnect power front the unit.
2. Remove screws and top panel
3. Remove evaporator cover panel
4. Close water inlet valve located at evaporator side onto water inlet line.



5. Press water hose clamp in order to release it



6. Lift the water pump up to release it from sliding holding screw



7. Carefully push little bit water sump bracket

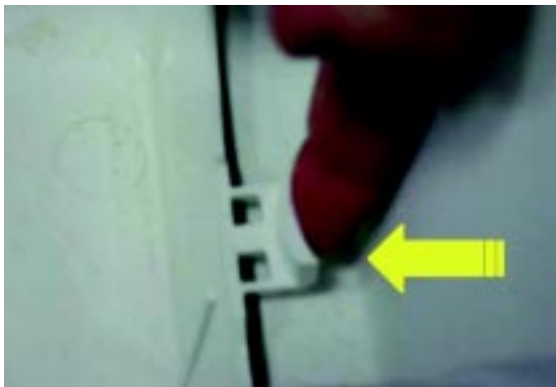

in order to release it

8. Lift the water reservoir up for a while and bend it in order to dump contained liquid

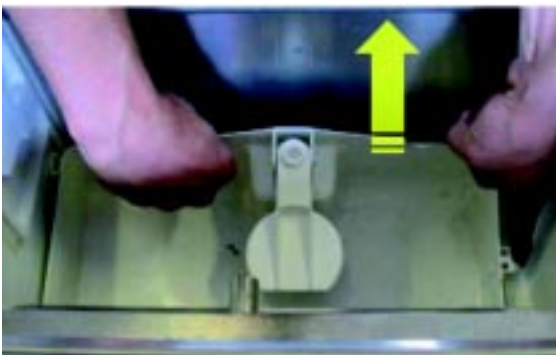

9. Push water hose quick fitting ring

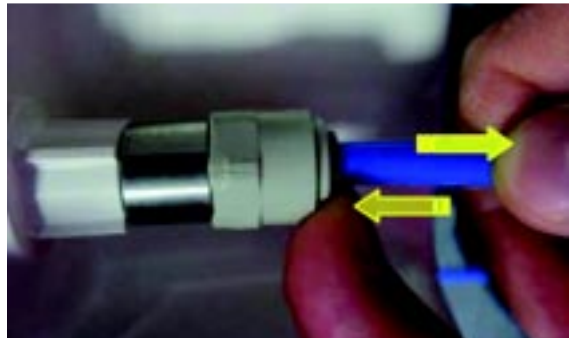

.....to release the nylon tube



.....and remove water sump from evaporator basin

10. By the help of flat screwdriver easily open little bit float valve holding arms and remove it from holders



11. Check nozzle orifice condition. In case of obstruction clean it by pin



12. Prepare a solution in a bucket by mixing for:
MAR 56-76-106-126
 1/2 liter of SCOTSMAN CLEANER with
 5 liters of warm (40-50°C) water
MAR 206-306
 1 liter of SCOTSMAN CLEANER with
 10 liters of warm (40-50°C) water

WARNING: When using any chemical, wear hands protection (gloves). SCOTSMAN Ice Machines Cleaner contains phosphoric and Hydroxiacetic acid. These compound are corrosive and may cause burns if swallowed. DO NOT induce vomiting. Give large amount of water or milk. Call Physician immediately. In case of external contact, flush with fresh water. KEEP OUT OF THE REACH O CHILDREN.

13. Dip the water reservoir removed at #7 into the cleaning solution and clean it by sponge and/or suitable brush.



14. Once reservoir is duly cleaned, dump float valve in the solution and remove any kind of scale or mineral deposit then rinse the same by fresh water.
 15. Place again float valve into its bracket
 16. Reinstall water sump with float valve.

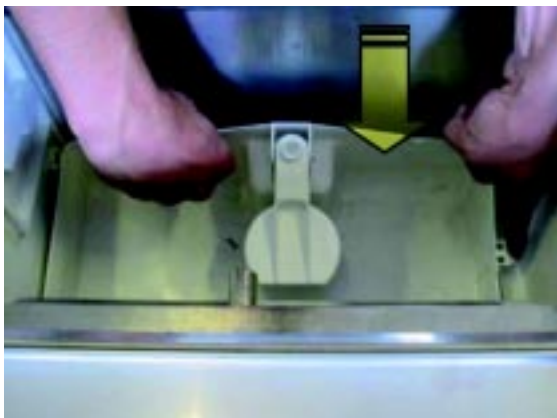

17. Reinstall water pump removed at #6.
 18. Reconnect water inlet hose removed at #5.

19. Slowly pour the solution mixed at #12 in the water reservoir till to 2 cm (7,87") below top edge.
 20. Plug IN the ice maker and let the unit in operation for about 10 minutes.
 21. Disconnect again unit from power.
 22. Repeat again from #5 to #9 thus to dump reservoir from chemical solution and later rinse all parts by fresh water.



23. Reinstall all removed part from #9 to #5.
 24. Prepare as per #12 using SCOTSMAN sanitizer rather than cleaner. Possible sanitizing solution could be by mixing:

MAR 56 - 76 - 106 - 126
 1,5 cl (5 oz) of sanitizer with 5 lt (1 gallon)

MAR 206 - 306
 3 cl (10 oz) of sanitizer with 10 lt (2 gallons) of warm potable water.

NEVER MIX CLEANING WITH SANITIZING SOLUTION

25. Pour sanitizing solution in the water reservoir.
 26. Plug IN again the unit and let the sanitizing solution re-circulating for about 5 minutes.
 27. Repeat #5 to #8.
 28. Lift the water sump up for a while in order to dump sanitizing solution stored in the same then relocate the same.
 29. Reinstall water pump and connect water inlet hose.
 30. Open water inlet valve previously closed at #4.
 31. Ice produced during the first 5 minutes must be thrown away in order to avoid any possible chemical contamination.

CAUTION - NEVER use ice produced from any chemical solution. Be sure none falls into storage bin.

SECTION VI

SERVICE DIAGNOSIS

The Service Diagnosis Section is for use in aiding the servicemen in diagnosing a particular problem for pin-pointing the area in which the problems lines, thus an ever available reference for proper corrective action.

The following chart lists corrective actions for the causes of known symptoms of certain problems that can occur in the ice making refrigeration system.

1. ICE MAKING - REFRIGERATION SYSTEM

SYMPTON	POSSYBLE CAUSE	CORRECTION
3rd Red Light glows- Lo-water pressure.	Intermittent water supply or too low water pressure.	Water shut-off valve closed. Check and clean water strainer.
The unit does not make ice.	Fiber key in gear reducer bore broken. V-belt loose or broken.	Remove Gear box and change fiber key. Check. Repair or replace.
The compressor runs but no ice is made.	Gear in gear box stripped. Pulley loose on motor shaft. Water not entering reservoir.	Check and replace. Repair. Check and clean. Water float valve to be cleaned.
2nd Red Light glows- Hi-pressure excessive.	Hi-pressure control cut-off unit operation.	Check cooling water at condenser. Condenser tube clogged-up. Water regulating valve to be re-adjusted. Fan motor out of operations.
1st Green Light is off. Unit will not run.	Blown fuse. Loose electrical connection. Switch in OFF position. Inoperative master switch. Spout switch cut-out. Contactor coil-open winding.	Replace fuse and check for cause of blow fuse. Check wiring. Turn switch to ON. Replace switch. Check ice chute arrangement. Replace contactor.

SYMPTON	POSSYBLE CAUSE	CORRECTION
Excessive noise.	Misaligned V-belt. Gear reducer loose on frame. Drive motor end-play or worm bearings. Motor compressor not floating on rubber cushions. Water level in evaporator drum basin too low.	Aligne V-belt. Tighten. Repair or replace. Loosen hold-down bolts. Set water level as shown on page 27.
Excessive vibration.	Ice formation underneath blade-frictioning against rotating drum.	Remove blade amd melt-up ice formation. Adjust water level as shown on page 27.
Compressor cycles	Water regulating valve too close. AEV valve closed. Non-condensable gases in sustem.	Open water valve. Adjust. Purge-off.
Making wet ice	Surrounging air temperature above 40°C (100°F) Under-or-over-charge of refrigerant. Closed AEV. Faulty compressor valve plate.	Correct or move unit to cooled location. Re-charge with proper amount. Adjust valve for correct refrigerant flow. Repair or replace.
Low ice production.	Loss of refrigerant, under or overcharge of refrigerant. Plugged condenser water tubes. Low water level in the reservoir. Overcharge of oil in system.	Check and recharge with proper amount of refrigerant. Clean condensor. Check float valve operation. Check at oil sight glass. Lower to 1/2 sight glass.
8th Light glows- Evaporator - drum doesn't turn (ice maker OFF).	Evaporator - drum speed very low - 1/4 rotation in more then 30"	Gear Reducer shaft's fiber key breakage. V belt slipping Effect hall sensor failure. Effect hall magnetic pins demagnetized.
7th Light glows- Wrong 3 phases monitoring relay cut out.	Wrong power voltage cable wiring.	Interchange phases plug IN.

SECTION VII

WIRING DIAGRAMS

This section is provided as an aid in understanding the electrical circuit of the Mar Flaker.

The Wiring Diagrams in this Section are:

Pag. 36-38 - Wiring Diagram - MAR 56-76-106-126 WS and AS

Pag. 39-42 - Wiring Diagram - MAR 206-306 WS and AS.

WARNING - When conducting a continuity check of the MAR Flaker:



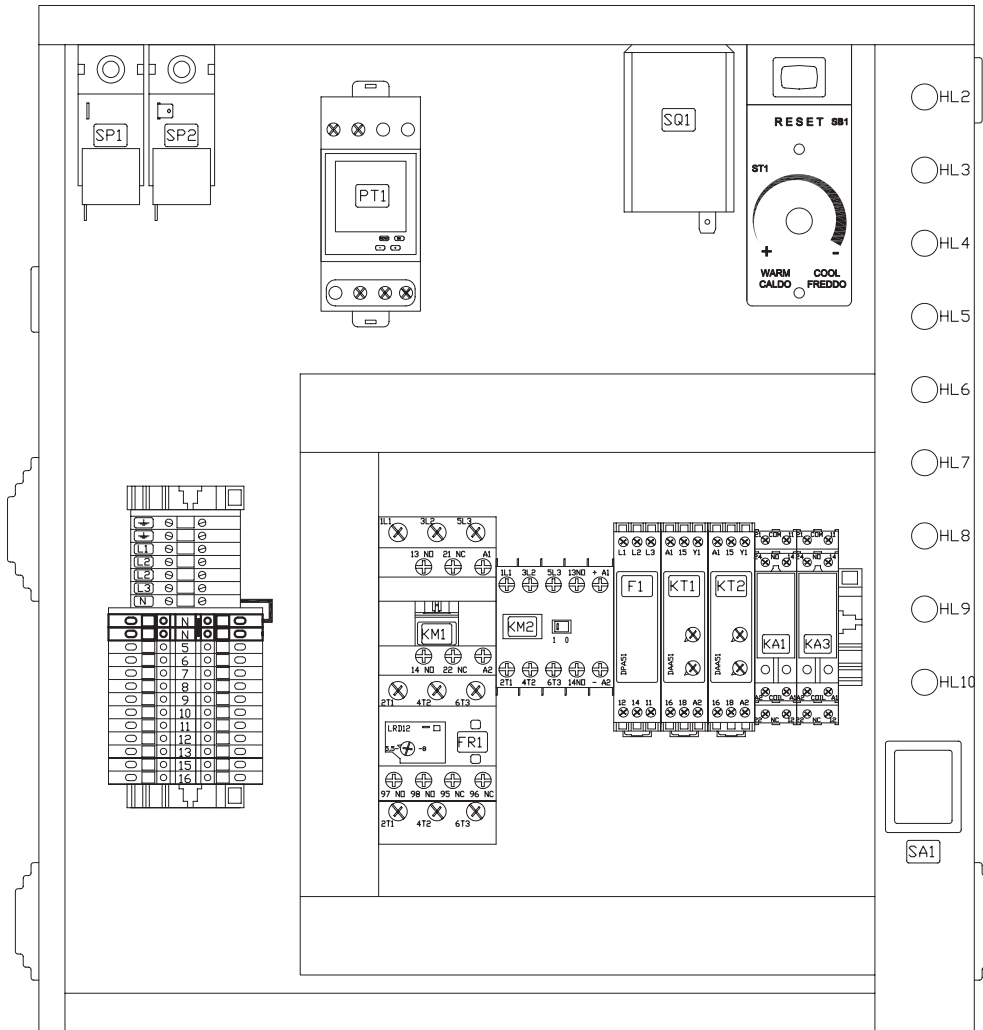



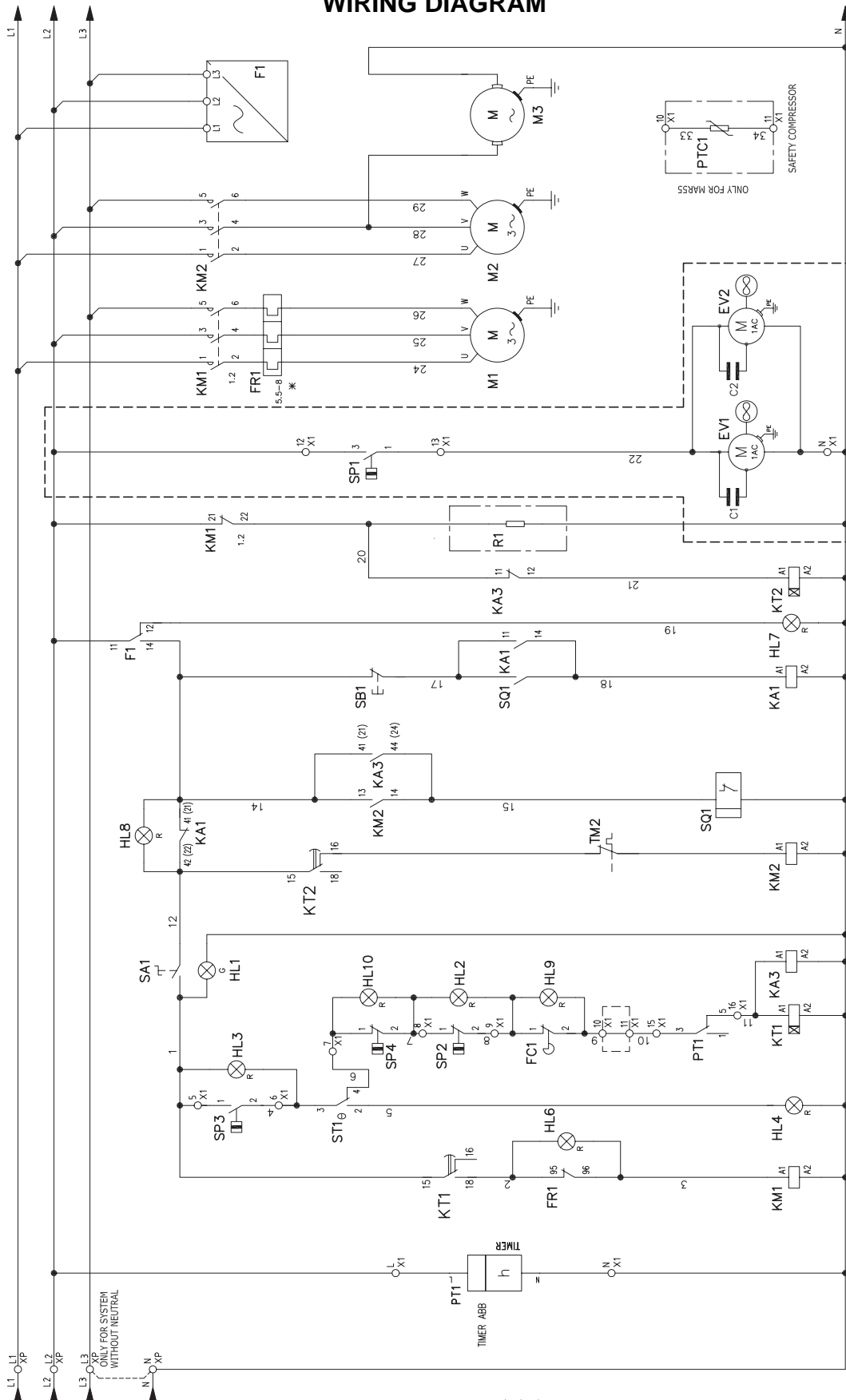

























1. Disconnect the main power source.
2. **DO NOT** use an incandescent lamp or jumper wire, conduct all tests with a voltohmmeter.



MAR 56-76-106-126 - AS and WS WIRING DIAGRAM



----- JUST FOR COOLED UNIT * 12-18 A FOR MODELS MAR 105-106/ 125-126 230 Vac 60 Hz

Sim.\Sym:		Funzione\Use Type	Fan motor Ventilatore	Sigla\Item	EV1	Funzione\Use Type		Sim.\Sym:		Sigla\Item	HL8	Funzione\Use Type	Drum rotation / drive motor thermal protector alarm Allarme rotazione cilindro / termica motoriduttore	Sim.\Sym:		Sigla\Item	M3	Funzione\Use Type	Water pump Pompa acqua
Sim.\Sym:		Funzione\Use Type	Fan motor Ventilatore	Sigla\Item	EV2	Funzione\Use Type		Sim.\Sym:		Sigla\Item	HL9	Funzione\Use Type	Spout switch light Spia int. bocchetta	Sim.\Sym:		Sigla\Item	PTC1	Funzione\Use Type	Compressor protector Protezione compressore
Sim.\Sym:		Funzione\Use Type	3-phase monitoring relay Controllo sequenza fasi	Sigla\Item	F1	Funzione\Use Type		Sim.\Sym:		Sigla\Item	HL10	Funzione\Use Type	LOW pressure alarm Allarme bassa pressione	Sim.\Sym:		Sigla\Item	PT1	Funzione\Use Type	Timer 0-24 HR Timer 0-24 HR
Sim.\Sym:		Funzione\Use Type	Spout switch Interruttore bocchetta	Sigla\Item	FC1	Funzione\Use Type		Sim.\Sym:		Sigla\Item	KA1	Funzione\Use Type	Drum rotation control relay Relè controllo rotazione	Sim.\Sym:		Sigla\Item	R1	Funzione\Use Type	Crankcase heater Resistenza riscaldamento
Sim.\Sym:		Funzione\Use Type	Compressor thermal protector Termica compressore	Sigla\Item	FR1	Funzione\Use Type		Sim.\Sym:		Sigla\Item	KA3	Funzione\Use Type	Drive motor start relay Relè partenza anticipata motoriduttore	Sim.\Sym:		Sigla\Item	SA1	Funzione\Use Type	Master Switch Interruttore Principale
Sim.\Sym:		Funzione\Use Type	Power ON Macchina in funzione	Sigla\Item	HL1	Funzione\Use Type		Sim.\Sym:		Sigla\Item	KM1	Funzione\Use Type	Compressor contactor Teleruttore compressore	Sim.\Sym:		Sigla\Item	SB1	Funzione\Use Type	Reset push button Pulsante reset
Sim.\Sym:		Funzione\Use Type	HI pressure alarm Allarme alta pressione	Sigla\Item	HL2	Funzione\Use Type		Sim.\Sym:		Sigla\Item	KM2	Funzione\Use Type	Drive motor contactor Teleruttore motoriduttore	Sim.\Sym:		Sigla\Item	SP1	Funzione\Use Type	FAN pressure control Pressostato ventilatori
Sim.\Sym:		Funzione\Use Type	Water alarm Allarme mancanza acqua	Sigla\Item	HL3	Funzione\Use Type		Sim.\Sym:		Sigla\Item	KT1	Funzione\Use Type	Compressor timer delay Ritardatore compressore	Sim.\Sym:		Sigla\Item	SP2	Funzione\Use Type	HI pressure control safety Pressostato sicurezza alta pressione
Sim.\Sym:		Funzione\Use Type	Bin full Magazzino pieno	Sigla\Item	HL4	Funzione\Use Type		Sim.\Sym:		Sigla\Item	KT2	Funzione\Use Type	Drive-motor timer delay Ritardatore motoriduttore	Sim.\Sym:		Sigla\Item	SP3	Funzione\Use Type	Water pressure control Controllo bassa pressione acqua
Sim.\Sym:		Funzione\Use Type	Compressor thermal protector alarm Allarme protezione termica compressore	Sigla\Item	HL6	Funzione\Use Type		Sim.\Sym:		Sigla\Item	M1	Funzione\Use Type	Compressor Compressore	Sim.\Sym:		Sigla\Item	SP4	Funzione\Use Type	LOW pressure control Pressostato bassa pressione
Sim.\Sym:		Funzione\Use Type	Wrong phase alarm Allarme sequenza fasi	Sigla\Item	HL7	Funzione\Use Type		Sim.\Sym:		Sigla\Item	M2	Funzione\Use Type	Drive motor Motoriduttore	Sim.\Sym:		Sigla\Item	SQ1	Funzione\Use Type	Drum rotation control board Schema controllo rotazione

MAR 206-306 - AS and WS WIRING DIAGRAM

FIG. 1

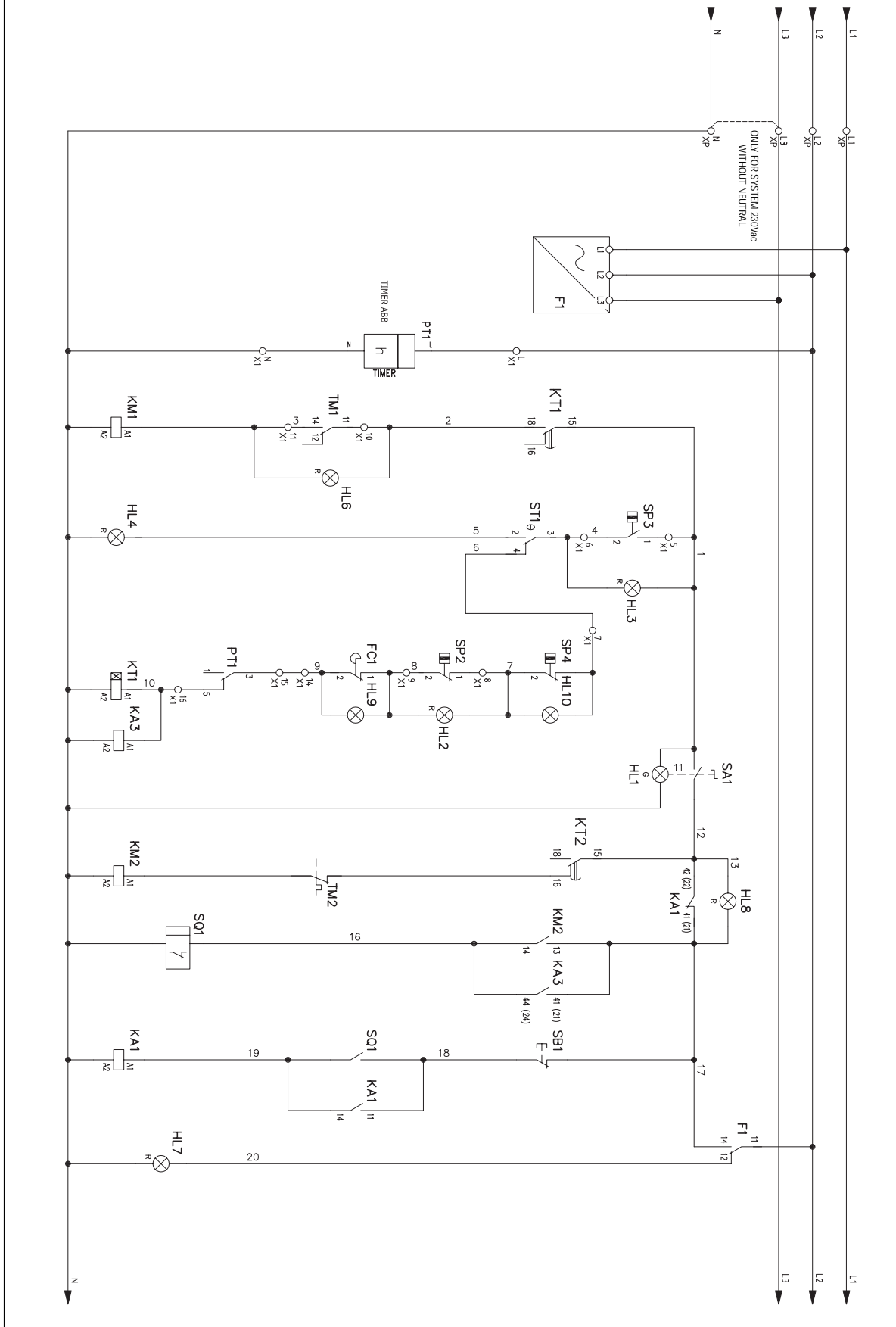

Sim.\Sym.	Sigla \Item	Funzione \Use Type	Sim.\Sym.	Sigla \Item	Funzione \Use Type	Sim.\Sym.	Sigla \Item	Funzione \Use Type
	EV1	Fan motor Ventilatore		HL7	Wrong phase alarm Allarme sequenza fasi		HL8	Drum rotation / drive motor thermal protector alarm Allarme rotazione cilindro / termica motoriduttore
	EV2	Fan motor Ventilatore		HL9	Spout switch light Spia int. bocchetta		HL10	LOW pressure alarm Allarme bassa pressione
	EV3	Fan motor Ventilatore		KA1	Drum rotation control relay Relé controllo rotazione		KA3	Drive motor start relay Relé partenza anticipata motoriduttore
	EV4	Fan motor Ventilatore		KM1	Compressor contactor Contattore compressore		KM2	Drive motor contactor Teleruttore motoriduttore
	F1	3-phase monitoring relay Controllo sequenza fasi		KT1	Compressor timer delay Ritardatore compressore		KT2	Drive-motor timer delay Ritardatore motoriduttore
	FC1	Spout switch Interruttore bocchetta		M1	Compressor Compressore			
	HL1	Power ON Macchina in funzione						
	HL2	HI pressure alarm Allarme alta pressione						
	HL3	Water alarm Allarme mancanza acqua						
	HL4	Bin Full Magazzino pieno						
	HL6	Compressor thermal protector alarm Allarme termica compressore						
	M2	Drive motor Moto riduttore		M3	Water pump Pompa acqua			
	PT1	Timer 0-24 HR Timer 0-24 HR		R1	Crankcase heater Resistenza compressore		SA1	Switch Interruttore
				SB1	Reset push button Pulsante reset		SP1	FAN pressure control Pressostato ventilatori
				SP2	HI pressure control-safety Pressostato di alta-sicurezza		SP3	Water pressure control Pressostato acqua
				SP4	Low pressure control Pressostato di bassa		TM2	Drive-motor thermal protector Protezione termica motoriduttore

