

# Scotsman®

SERVICE MANUAL

**EC 46**

**EC 56**

**EC 86**

**Cubers  
with storage**

SCOTSMAN EUROPE - FRIMONT SPA  
Via Puccini, 22 - 20010 Pogliano M.se - Milano - Italy  
Tel. +39-02-93960.1 (Aut. Sel.)- Telefax +39-02-93550500  
Direct Line to Service & Parts:  
Phone +39-02-93960350 - Fax +39-02-93540449  
Website: [www.scotsman-ice.com](http://www.scotsman-ice.com)  
E-Mail: [scotsman.europe@frimont.it](mailto:scotsman.europe@frimont.it)



MS 1000.94 REV. 10/2008

**INDICE**

Table of contents	page	2
Specifications EC 46		3
Specifications EC 56		5
Specifications EC 86		7

**GENERAL INFORMATION AND INSTALLATION**

Introduction		9
Unpacking and Inspection		9
Location and levelling		9
Electrical connections		9
Water supply and drain connections		10
Final check list		10
Installation practice		11

**OPERATING INSTRUCTIONS**

Start up		12
Operational checks		12

**OPERATING PRINCIPLES (How it works)**

Freezing cycle		13
Harvest cycle		13
Electrical sequence		17
Components description		17

**ADJUSTMENT, REMOVAL AND REPLACEMENT PROCEDURES**

Adjustment of the cube size		20
Wiring diagram		21
Service diagnosis		24

**MAINTENANCE AND CLEANING INSTRUCTIONS**

General		26
Icemaker		26
Clean - Replace of air condenser filter		26
Cleaning instructions of water system		26

**SPECIFICATIONS**

**CUBER MODEL EC 46**

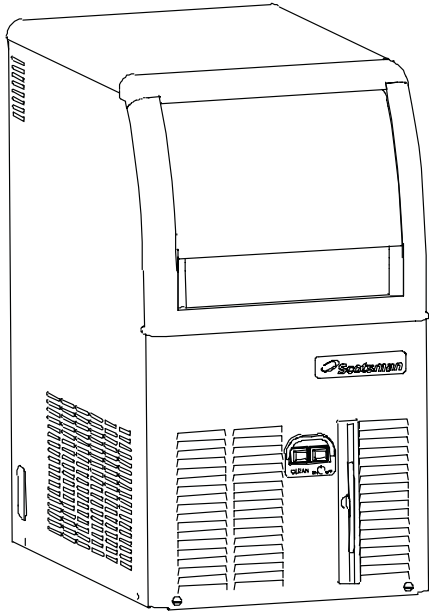

Important operating requirements:

	MIN.	MAX.
Air temperature	10°C	40°C
Water temperature	5°C	35°C
Water pressure	1 bar	5 bar
Electr. voltage variations from voltage rating specified on nameplate	-10%	+10%

**ice making capacity**

**AIR COOLED MODELS**

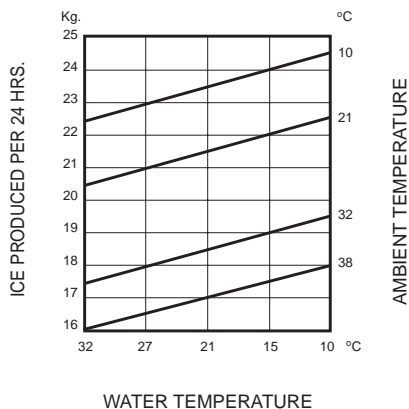

**WATER COOLED MODELS**

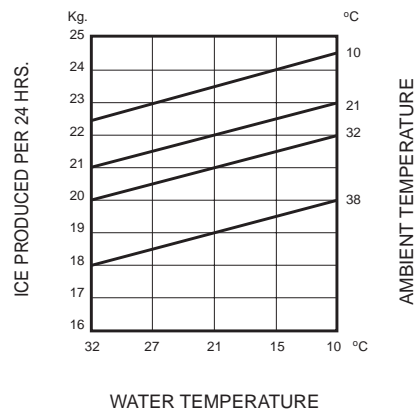

**NOTE.** With the unit in "built-in" conditions, the ice production is gradually reduced in respect to the levels shown in the graf, up to a maximum of 10% at room temperatures higher than 32° C. The daily ice-making capacity is directly related to the condenser air inlet temperature, water temperature conditions of the condenser air filter and age of the machine. To keep your SCOTSMAN CUBER at peak performance levels, periodic maintenance checks must be carried out as indicated on Maintenance and Cleaning section of this manual.

### SPECIFICATIONS

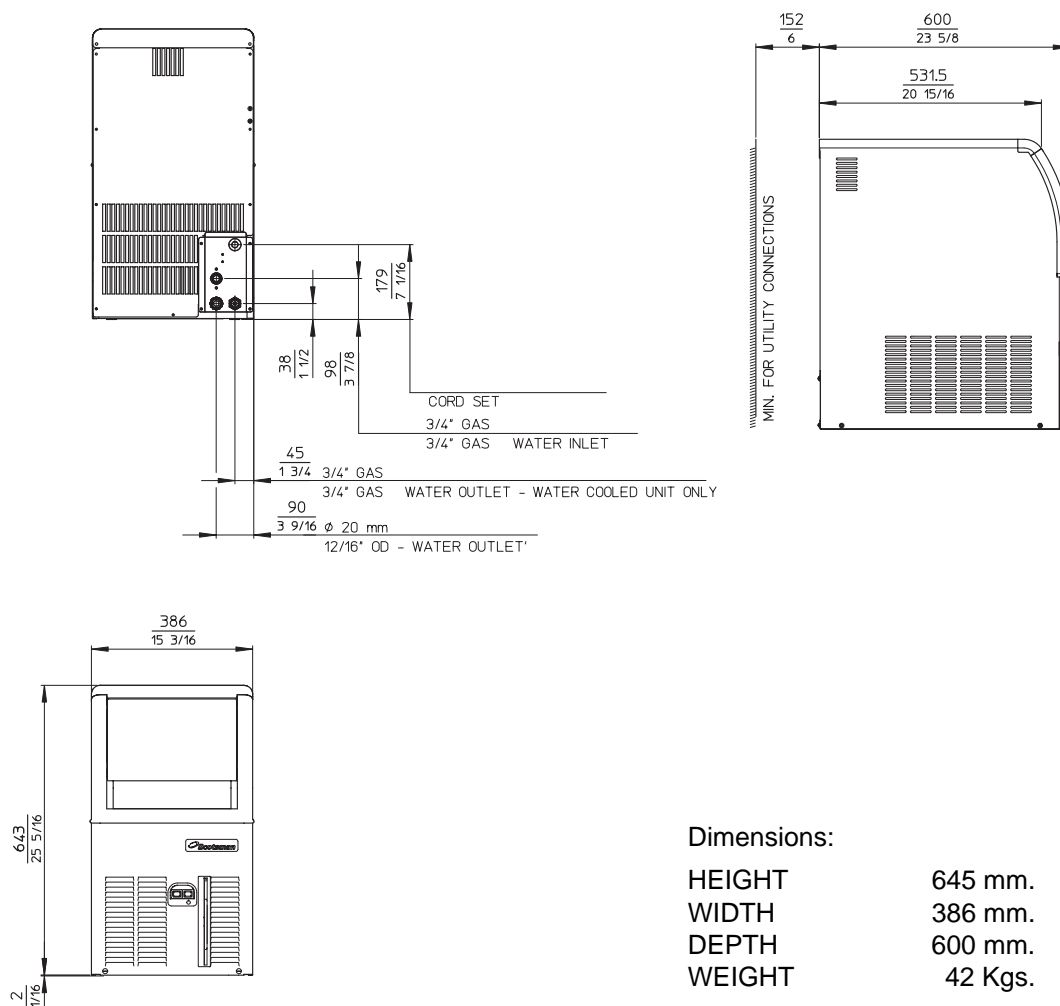

### EC 46 - CUBER machine specifications

Model	Cond. unit	Finish	Comp. HP	Bin Capacity	Water req. lt/24 HR	
EC 46 AS 6 EC 46 WS 6	Air Water	Stainless steel	1/4	9 Kg.	77 350*	
Basic electr.	Amps	Start Amps	Watts	Electric power cons. Kwh per 24 Hr	Nr. of wires	Amps fuse
230/50/1	2.1	12	400	8	3 x 1.5 mm <sup>2</sup>	10
				6		
Cubes per harvest: 18 medium * A 15°C water temperature						

**SPECIFICATIONS**

**CUBER MODEL EC 56**

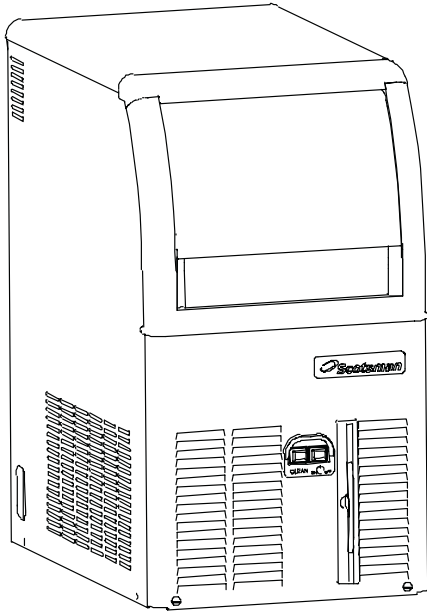

Important operating requirements:

	MIN.	MAX.
Air temperature	10°C	40°C
Water temperature	5°C	35°C
Water pressure	1 bar	5 bar
Electr. voltage variations from voltage rating specified on nameplate	-10%	+10%

**ice making capacity**

**AIR COOLED MODELS**

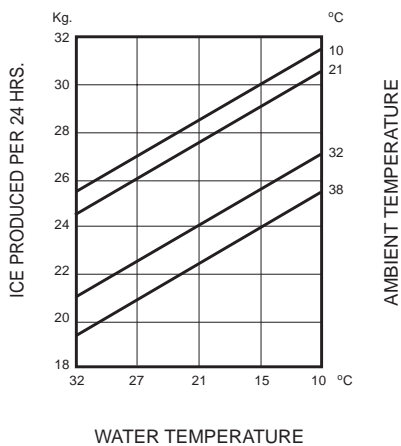

**WATER COOLED MODELS**

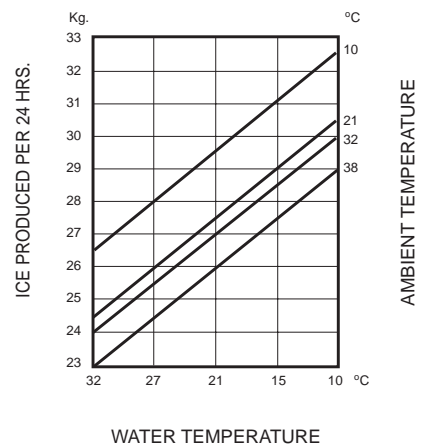

**NOTE.** With the unit in "built-in" conditions, the ice production is gradually reduced in respect to the levels shown in the graf, up to a maximum of 10% at room temperatures higher than 32°C. The daily ice-making capacity is directly related to the condenser air inlet temperature, water temperature conditions of the condenser air filter and age of the machine. To keep your SCOTSMAN CUBER at peak performance levels, periodic maintenance checks must be carried out as indicated on Maintenance and Cleaning section of this manual.

**SPECIFICATIONS**

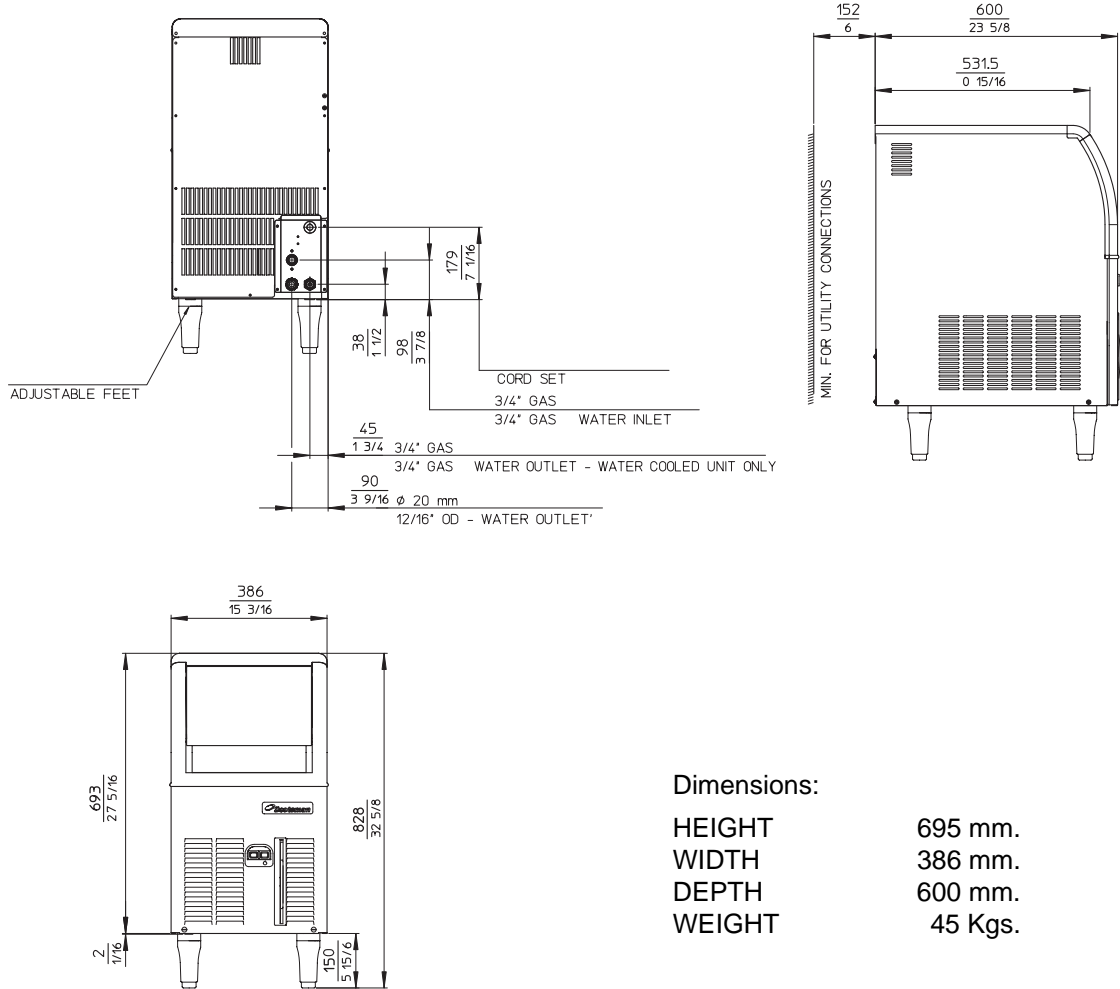

Dimensions:  
 HEIGHT 695 mm.  
 WIDTH 386 mm.  
 DEPTH 600 mm.  
 WEIGHT 45 Kgs.

**EC 56 - CUBER  
 machine specifications**

Model	Cond. unit	Finish	Comp. HP	Bin Capacity	Water req. lt/24 HR	
EC 56 AS 6 EC 56 WS 6	Air Water	Stainless steel	1/4	12.5 Kg.	90 270*	
Basic electr.	Amps	Start Amps	Watts	Electric power cons. Kwh per 24 Hr	Nr. of wires	Amps fuse
230/50/1	2.1	12	400	7.6	3 x 1.5 mm <sup>2</sup>	10
				7		
Cubes per harvest: 24 medium * A 15°C water temperature						

**SPECIFICATIONS**

**CUBER MODEL EC 86**

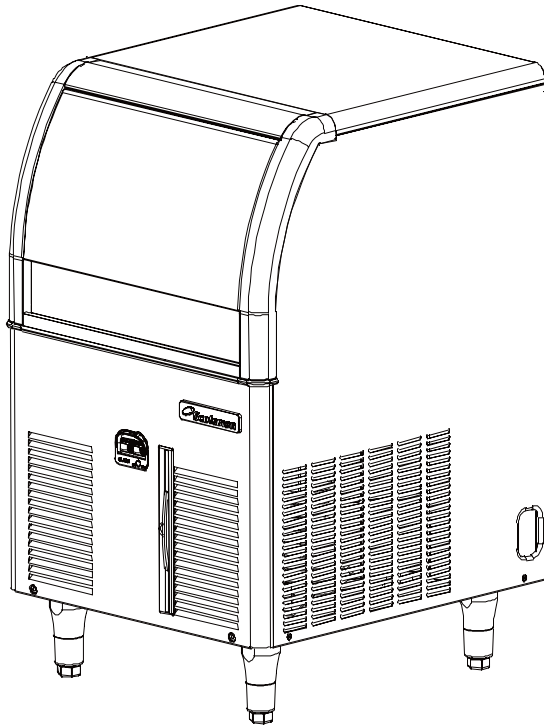

Important operating requirements:

	MIN.	MAX.
Air temperature	10°C	40°C
Water temperature	5°C	35°C
Water pressure	1 bar	5 bar
Electr. voltage variations from voltage rating specified on nameplate	-10%	+10%

**ice making capacity**

**AIR COOLED MODELS**

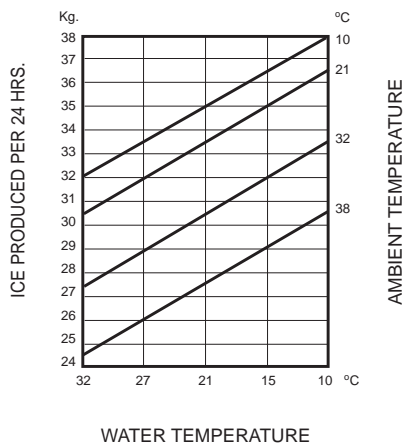

**WATER COOLED MODELS**

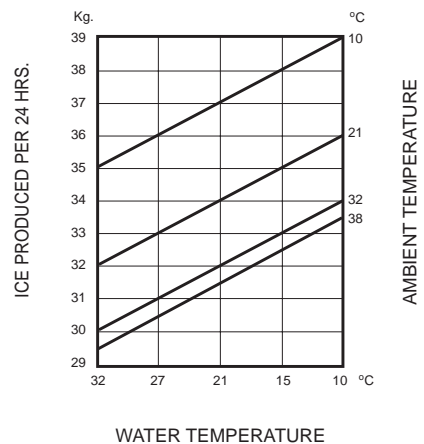

**NOTE.** With the unit in "built-in" conditions, the ice production is gradually reduced in respect to the levels shown in the graf, up to a maximum of 10% at room temperatures higher than 32° C. The daily ice-making capacity is directly related to the condenser air inlet temperature, water temperature conditions of the condenser air filter and age of the machine. To keep your SCOTSMAN CUBER at peak performance levels, periodic maintenance checks must be carried out as indicated on Maintenance and Cleaning section of this manual.

### SPECIFICATIONS

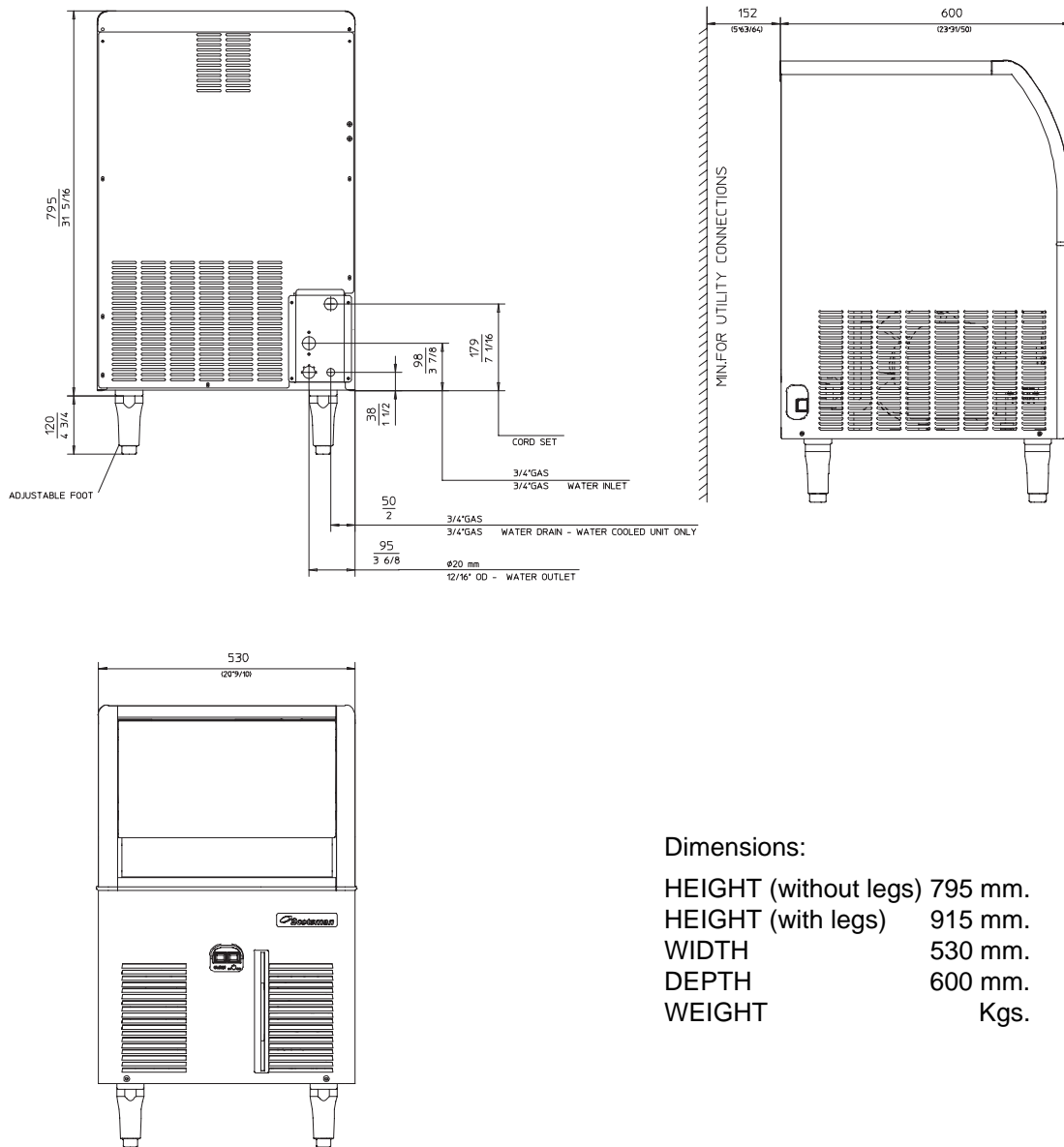

**Dimensions:**

- HEIGHT (without legs) 795 mm.
- HEIGHT (with legs) 915 mm.
- WIDTH 530 mm.
- DEPTH 600 mm.
- WEIGHT Kgs.

### EC 86 - CUBER machine specifications

Model	Cond. unit	Finish	Comp. HP	Bin Capacity	Water req. lt/24 HR	
EC 86 AS 6 EC 86 WS 6	Air Water	Stainless steel	3/8	19 Kg.	143 500*	
Basic electr.	Amps	Start Amps	Watts	Electric power cons. Kwh per 24 Hr	Nr. of wires	Amps fuse
230/50/1	3.3	18	480	8.9	3 x 1.5 mm <sup>2</sup>	10
				8.4		
Cubes per harvest: 24 medium * A 15°C water temperature						



## GENERAL INFORMATION AND INSTALLATION

### A. INTRODUCTION

This manual provides the specifications and the step-by-step procedures for the installation, start-up and operation, maintenance and cleaning for the SCOTSMAN EC series icemakers.

These Cubers are quality designed, engineered and manufactured.

Their ice making systems are thoroughly tested providing the utmost in flexibility to fit the needs of a particular user.

These icemakers have been engineered to our own rigid safety and performance standards.

**NOTE.** *To retain the safety and performance built into this icemaker, it is important that installation and maintenance be conducted in the manner outlined in this manual.*

### B. UNPACKING AND INSPECTION

1. Call your authorized SCOTSMAN Distributor or Dealer for proper installation.
2. Visually inspect the exterior of the packing and skid. Any severe damage noted should be reported to the delivering carrier and a concealed damage claim form filled in subject to inspection of the contents with the carrier's representative present.
3.
  - a) Cut and remove the plastic strip securing the carton box to the skid.
  - b) Cut open the top of the carton and remove the polystyrene protection sheet.
  - c) Pull out the polystyrene posts from the corners and then remove the carton.
4. Remove the front panel of the unit and inspect for any concealed damage. Notify carrier of your claim for the concealed damage as stated in step 2 above.
5. Check that refrigerant lines do not rub against or touch other lines or surfaces, and that the fan blade moves freely.
6. Check that the compressor fits snugly onto all its mounting pads.
7. Remove all internal support packing and masking tape.

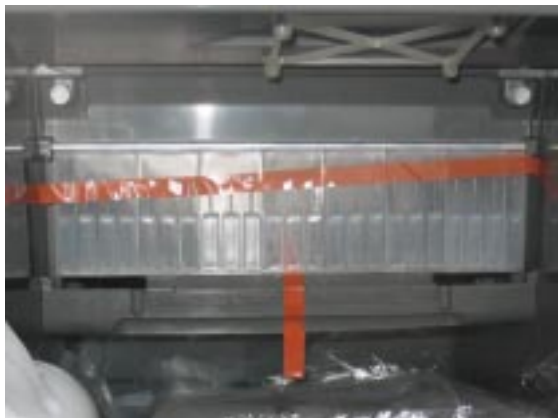

8. Use clean damp cloth to wipe the surfaces inside the storage bin and the outside of the cabinet.

9. See data plate on the rear side of the unit and check that local main voltage corresponds with the voltage specified on it.

**CAUTION.** **Incorrect voltage supplied to the icemaker will void your parts replacement program.**

10. Remove the manufacturer's registration card from the inside of the User Manual and fill-in all parts including: Model and Serial Number taken from the data plate.

Forward the completed self-addressed registration card to Frimont factory.

11. If necessary, on model EC 56, replace the four standard legs with the taller ones supplied in the machine and adjust them to level the unit.

### C. LOCATION AND LEVELLING

**WARNING.** **This Ice Cuber is designed for indoor installation only. Extended periods of operation at temperatures exceeding the following limitations will constitute misuse under the terms of the SCOTSMAN Manufacturer's Limited Warranty resulting in LOSS of warranty coverage.**

1. Position the unit in the selected permanent location.  
Criteria for selection of location include:
  - a) Minimum room temperature 10°C (50°F) and maximum room temperature 40°C (100°F).
  - b) Water inlet temperatures: minimum 5°C (40°F) and maximum 35°C (90°F).
  - c) Well ventilated location for air cooled models.
  - d) Service access: adequate space must be left for all service connections through the rear of the ice maker. A minimum clearance of 15 cm (6") must be left at the sides of the unit for routing cooling air drawn into and exhausted out of the compartment to maintain proper condensing operation of air cooled models.
2. Level the unit in both the left to right and front to rear directions.

### D. ELECTRICAL CONNECTIONS

See data plate for current requirements to determine wire size to be used for electrical connections. All SCOTSMAN icemakers require a solid earth wire.

All SCOTSMAN ice machines are supplied from the factory completely pre-wired and require only electrical power connections to the wire cord provided at rear of the unit.

Make sure that the ice machine is connected to its own circuit and individually fused (see data plate for fuse size).

The maximum allowable voltage variation should not exceed -10% and + 10% of the data plate rating. Low voltage can cause faulty functioning and may be responsible for serious damage to the overload switch and motor windings.

**NOTE.** All external wiring should conform to national, state and local standards and regulations.

Check voltage on the line and the ice maker's data plate before connecting the unit.

## E. WATER SUPPLY AND DRAIN CONNECTIONS

### GENERAL

When choosing the water supply for the ice cuber consideration should be given to:

- a) Length of run
- b) Water clarity and purity
- c) Adequate water supply pressure

Since water is the most important single ingredient in producing ice you cannot emphasize too much the three items listed above.

Low water pressure, below 1 bar may cause malfunction of the ice maker unit.

Water containing excessive minerals will tend to produce cloudy coloured ice cubes, plus scale build-up on parts of the water system.

### WATER SUPPLY

#### Air Cooled Versions

Connect the 3/4" male fitting of the solenoid water inlet valve, using the flexible tube supplied, to the cold water supply line with regular plumbing fitting and a shut-off valve installed in an accessible position between the water supply line and the unit.

If water contains a high level of impurities, it is advisable to consider the use an appropriate water filter or conditioner.

#### Water Cooled Versions

On Water Cooled version the water inlet solenoid valve has two separate outlets one for the condenser and the second for the production of ice.

### WATER DRAIN

The recommended drain tube is a plastic or flexible tube with 18 mm (3/4") I.D. which runs to an open trapped and vented drain.

### WATER DRAIN - WATER COOLED MODELS

Connect the 3/4" male fitting of the condenser water drain, utilizing a second flexible hose, to the open trapped and vented drain.

**NOTE.** The water supply and the water drain must be installed to conform with the local code. In some case a licensed plumber and/ or a plumbing permit is required.

The EC series Ice Cubers can pump out water up to 1.5 m rise

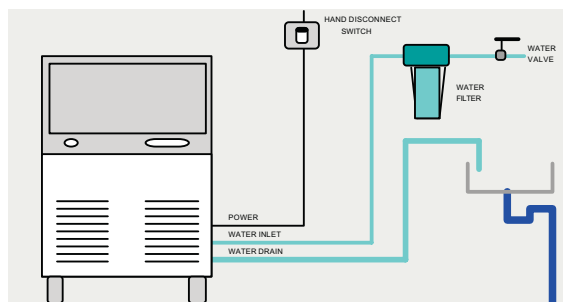

or to 30 m on horizontal length.

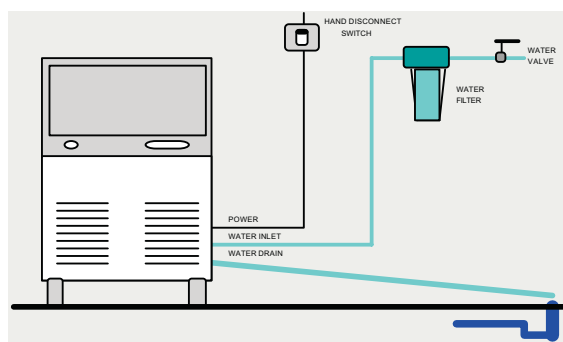

## F. FINAL CHECK LIST

1. Is the unit in a room where ambient temperatures are within a minimum of 10°C (50°F) even in winter months?
2. Is there at least a 15 cm (6") clearance around the unit for proper air circulation?
3. Is the unit level? (IMPORTANT)
4. Have all the electrical and plumbing connections been made, and is the water supply shut-off valve open?

- 5. Has the voltage been tested and checked against the data plate rating?
- 6. Has the water supply pressure been checked to ensure a water pressure of at least 1 bar (14 psi).
- 7. Check all refrigerant lines and conduit lines to guard against vibrations and possible failure.
- 8. Have the bolts holding the compressor down been checked to ensure that the compressor is snugly fitted onto the mounting pads?

- 9. Have the bin liner and cabinet been wiped clean?
- 10. Has the owner/user been given the User Manual and been instructed on the importance of periodic maintenance checks?
- 11. Has the Manufacturer's registration card been filled in properly? Check for correct model and serial number against the serial plate and mail the registration card to the factory.
- 12. Has the owner been given the name and the phone number of the authorized SCOTSMAN Service Agency serving him?

### G. INSTALLATION PRACTICE

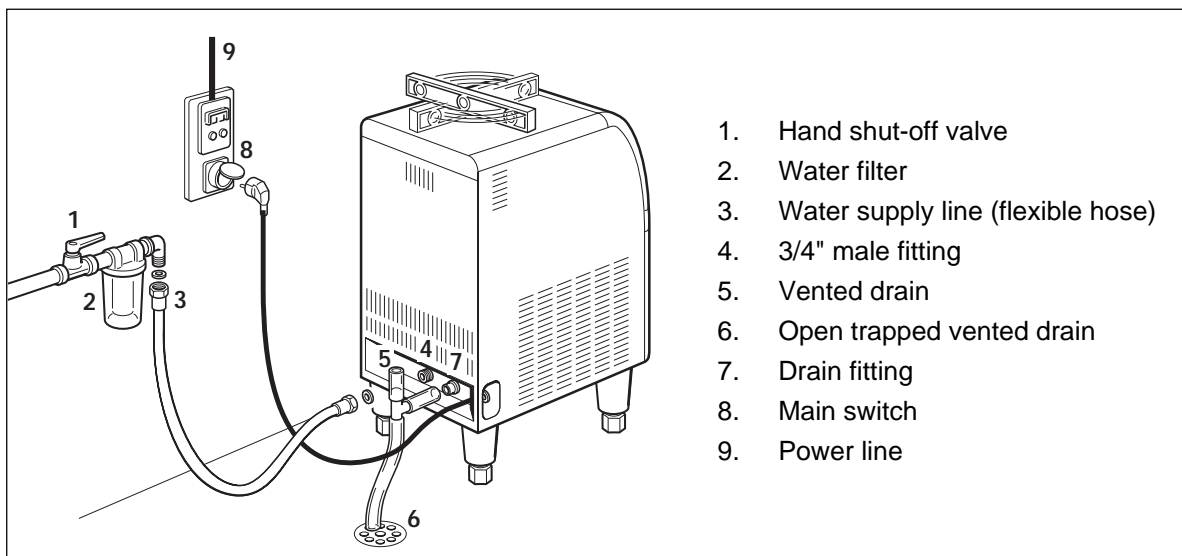

**WARNING.** This icemaker is not designed for outdoor installation and will not function in ambient temperatures below 10°C (50°F) or above 40°C (100°F). This icemaker will malfunction with water temperatures below 5°C (40°F) or above 35°C (90°F).

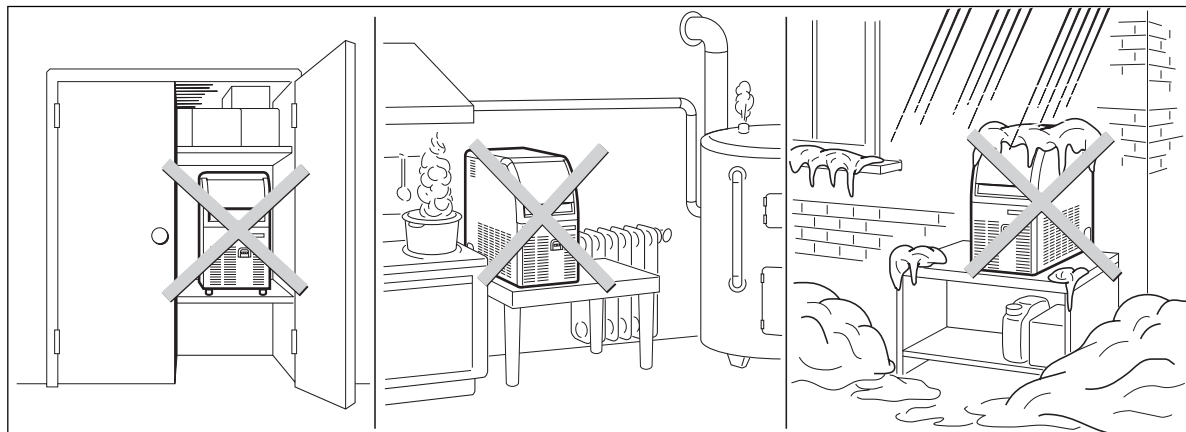

## OPERATING INSTRUCTIONS

### START UP

After having correctly installed the ice maker and completed the plumbing and electrical connections, perform the following "Start-up" procedure.

**A.** Withdraw the condenser air filter then remove the unit front panel and locate the cleaning switch on the control box.

**B.** Set the cleaning switch in the cleaning position. This will close the electrical circuit to the water inlet valve and to the hot gas valve

**C.** Switch ON the power line disconnect switch and push the green button switch. Unit will start up in charging cycle mode. During this cycle the components energized are:

**WATER INLET SOLENOID VALVE**

**HOT GAS SOLENOID VALVE**

The **Water pump** and the **Fan motor** in the air cooled versions, are also in operation.

**D.** Let unit stay in charging cycle for about three/four minutes till water is coming out from the drain hose, then move the cleaning switch to the operation position.

**NOTE.** During the charging cycle, the water inlet solenoid valve is energized. The water flows through the valve to the back side of the evaporator platen and then down to fill up the icemaker sump for the next freezing cycle.

### OPERATIONAL CHECKS

**E.** The unit now starts its first freezing cycle with the following components in operation:

**COMPRESSOR**

**WATER PUMP**

**FAN MOTOR** in air cooled version

**F.** Check to see through the ice discharge opening that the spray system is correctly seated and that the water jets uniformly reach the interior of the inverted cup molds; also make sure that the plastic curtain is hanging freely and there is not excessive water spilling through it.

**G.** The ice making process takes place thereby, with the water sprayed into the molds that gets gradually refrigerated by the heat exchanged with the refrigerant flowing into the evaporator serpentine.

**H.** When the evaporator temperature reaches a preset value the evaporator thermostat or cube size control changes its contacts; the freezing cycle ends and starts the defrost or harvest cycle. Freezing time will range between 20 and 22 minutes in a 21°C ambient temperature. Longer time for temperature above, shorter when below. Average complete cycle range is about 23 to 25 minutes.

**I.** Check, during the first defrost/harvest cycle, that the incoming water flows correctly into the sump in order to re-fill it and the surplus overflows through the overflow drain tube.

**J.** As soon as the water into the Sealed Water Reservoir reaches the maximum level, the two metal pins close the electrical contact through the water, transmitting a low voltage current to the PC Board.

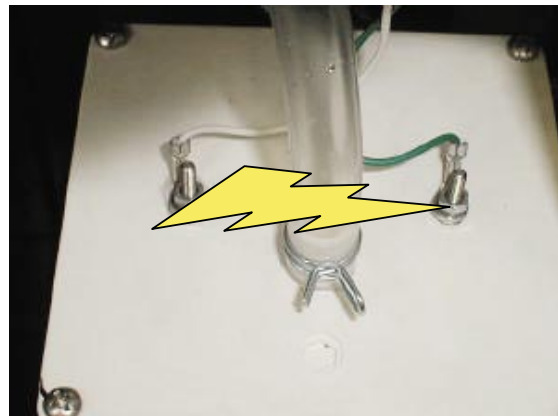

The PC Board energises the Water Drain Pump for 8 seconds pumping out most of the water contained into the Sealed Water Reservoir.

**K.** Check the texture of ice cubes just released. Right size must have a small depression (about 5-6 mm) in their crown.

If not, wait for the second defrost/harvest cycle before performing any adjustment.

**L.** If required, the length of the freezing cycle can be modified by turning the knob of the cube size control or evaporator thermostat located in front of the control box until the desired size is achieved.

If the ice cubes are shallow and cloudy, it is possible that the ice maker runs short of water during the end of the freezing cycle or, the quality of the supplied water requires the use of an appropriate water filter or conditioner.

**M.** During the defrost or harvest cycle hold a handful of ice cubes against the bulb of the storage bin thermostat; the icemaker switch OFF in about one-two minutes.

Take out the ice from the storage bin thermostat. The ice maker should restart automatically in three-four minutes.

**NOTE.** The bin thermostat is factory set at 1°C (35°F) OUT and 4°C (39°F) IN.

**N.** Re-fit the unit front panel then instruct the owner/user on the general operation of the ice machine and about the cleaning and care it requires.

## PRINCIPLE OF OPERATION

### How it works

In the **SCOTSMAN** cube ice makers the water used to make the ice is kept constantly in circulation by a water pump which primes it to the spray system nozzles from where it is diverted into the inverted cup molds of the evaporator (Fig. A).

A small quantity of the sprayed water freezes into ice; the rest of it cascades by gravity into the sump assembly below for recirculation.

### FREEZING CYCLE (Fig. B)

The hot gas refrigerant discharged out from the compressor reaches the condenser where, being cooled down, condenses into liquid. Flowing into the liquid line it passes through the drier/filter, then it goes all the way through the capillary tube where it loses its pressure.

Next the refrigerant enters into the evaporator serpentine (which has a larger diameter than the capillary tube) and starts to boil off; this reaction is emphasized by the heat transferred by the sprayed water.

The refrigerant then increases in volume and changes entirely into vapor.

The vapor refrigerant then passes through the suction accumulator (used to prevent that any small amount of liquid refrigerant may reach the compressor) and through the suction line. In both the accumulator and the suction line it exchanges heat with the refrigerant flowing into the capillary tube (warmer), before to be sucked in the compressor and to be recirculated as hot compressed refrigerant gas.

The freezing cycle is controlled by the evaporator thermostat which has its bulb in contact with the evaporator serpentine.

The electrical components in operation during the freezing cycle are:

#### COMPRESSOR

#### WATER PUMP

#### FAN MOTOR (in air cooled version)

On the air cooled versions the refrigerant head pressure is gradually reduced from a value of approx. **11 bars (155 psig)** at the beginning of the freezing cycle with the unit at 21°C (70°F) ambient temperature, to a minimum value of approx. **7 bars (100 psig)** just at the end of the freezing cycle few seconds before the starting of the defrost cycle.

The declining of the pressure is relied to the reduction of the evaporating pressure, caused by the progressive growth of the ice thickness into the inverted cup molds and to the flow of air down through the air cooled condenser by the fan motor.

The above values are in relation as well to the ambient temperature of the ice maker site and they are subject to rise with the increase of this temperature.

On the water cooled versions the refrigerant head pressure ranges between **8.5 and 10 bars (120÷140 psig)** being controlled by an automatic hi pressure control that energizes a water solenoid valve located on the water line to the condenser, which rates the cooling water to the condenser.

At the start of the freezing cycle the refrigerant suction or lo-pressure lowers rapidly to **1.0 bar - 14 psig** then it declines gradually - in relation with the growing of the ice thickness - to reach, at the end of the cycle, approx. **0÷0.1 bar - 0÷1.5 psig** with the cubes fully formed in the cup molds. The total length of the freezing cycle ranges from 23 to 25 minutes.

### DEFROST OR HARVEST CYCLE (Fig. D)

When the temperature of the evaporator thermostat, in contact with the evaporator serpentine, drops to a pre-set value it changes its electrical contacts energizing the following components:

#### COMPRESSOR

#### WATER INLET SOLENOID VALVE

#### HOT GAS SOLENOID VALVE

The incoming water, passing through the water inlet valve and the flow control, runs over the evaporator platen and then flows by gravity through the dribbler holes down into the sump/reservoir (Fig. C).

The water filling the sump/reservoir forces part of the surplus water from the previous freezing cycle to go out to the waste through the overflow pipe. This overflow limits the level of the sump water which will be used to produce the next batch of ice cubes.

Meanwhile the refrigerant, as hot gas discharged from the compressor, flows through the hot gas valve directly into the evaporator serpentine by-passing the condenser.

The hot gas circulating into the serpentine of the evaporator warms up the copper molds causing the harvest of the ice cubes. The ice cubes, released from the cups, drop by gravity onto a slanted cube chute, then through a curtained opening they fall into the storage bin.

When the temperature of the evaporator thermostat bulb reaches the value of +3÷4°C their electrical contacts move back to the previous position activating a new freezing cycle and deenergizing both the hot gas and the water inlet valves (closed).

**NOTE.** The length of the defrost/harvest cycle (not adjustable) changes according to the ambient temperature (shorter for hi ambient temperature and longer for low one).

FIG. A

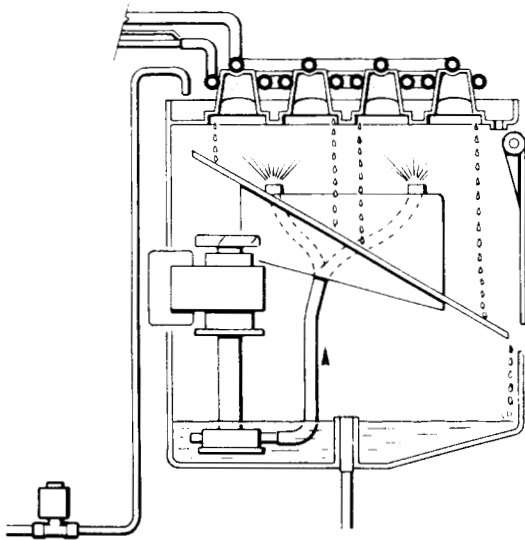

FIG. B

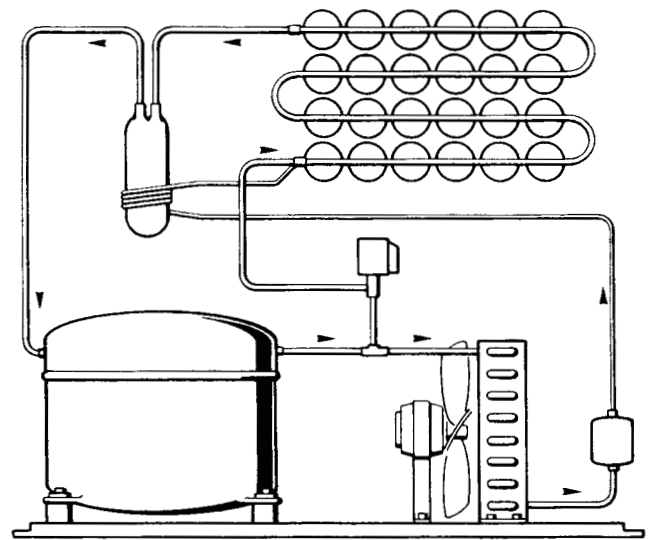

FIG. C

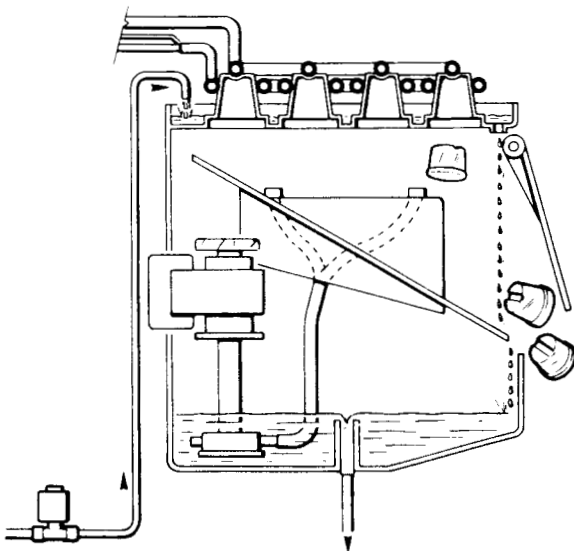
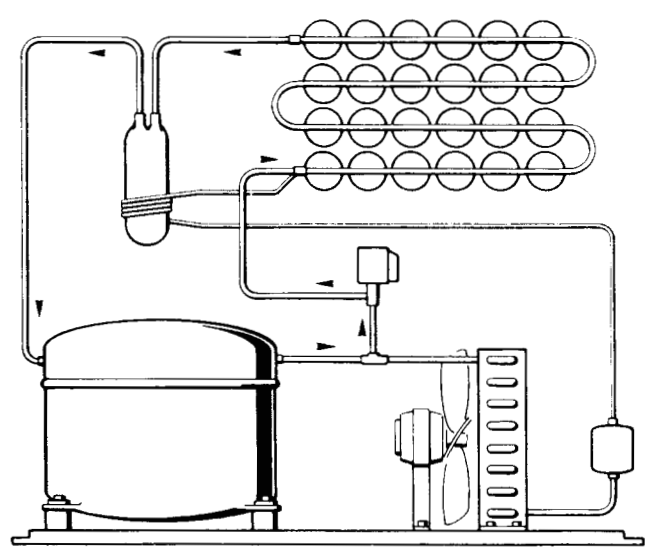

FIG. D



## PWD SYSTEM

### COMPONENTS

The components of the Pump Out Water Drain System are

- Sealed water tank
- PC Board & Sensor
- Sealed Water Pump
- Check Valve

### OPERATION

All water coming from the overflow, and from the melted ice is collected inside the Sealed Water Reservoir.

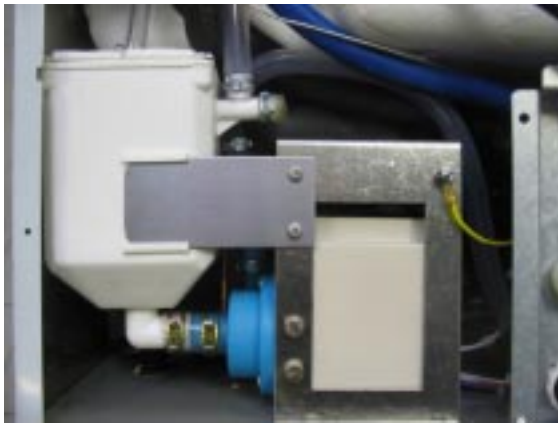

As soon as the water into the Sealed Water Reservoir reaches the maximum level, the two metal pins close the electrical contact through the water, transmitting a low voltage current to the PC Board.

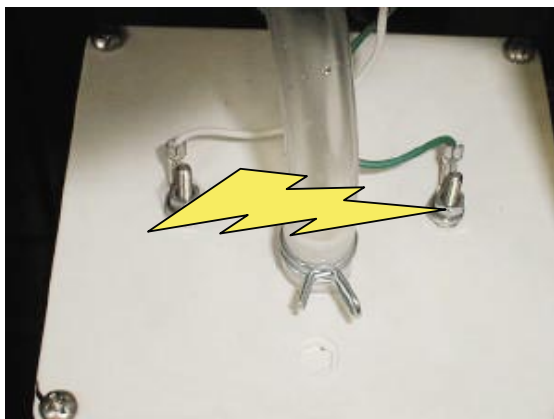

The PC Board activates the Water Drain Pump for 8 seconds pumping out most of

the water contained into the Sealed Water Reservoir.



The water can be pumped out up to 1.5 m rise or

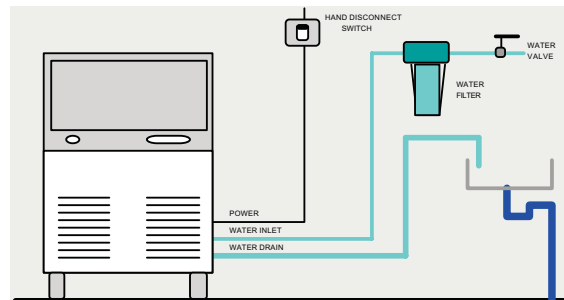

to 30 m on horizontal length.

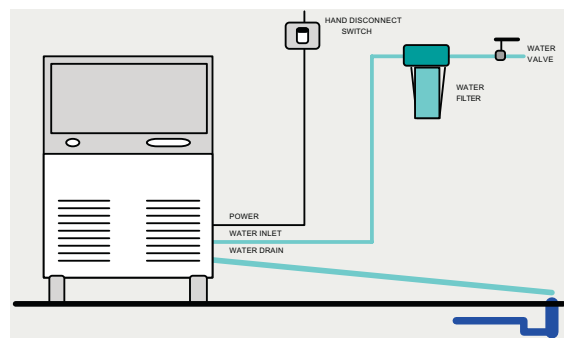

A Check Valve, located on the water drain hose, prevents the coming back of the discharged water.



### SCHEMATIC SYSTEM

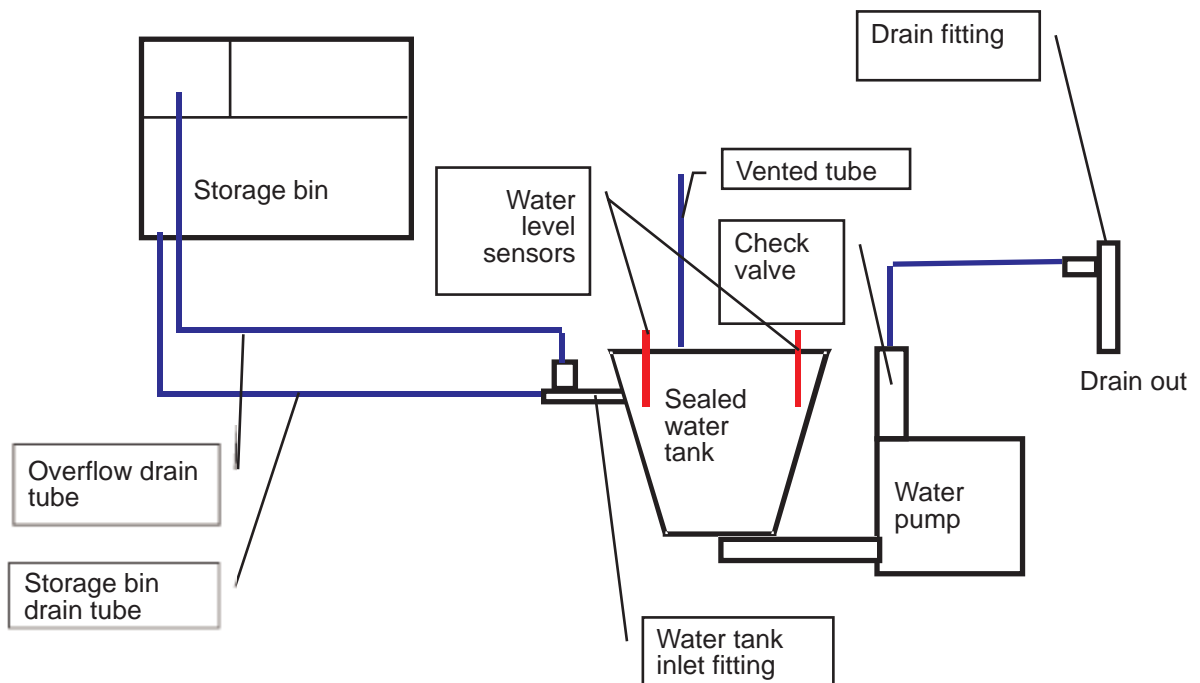



**OPERATION - ELECTRICAL SEQUENCE**

The following charts illustrate which switches and components are ON or OFF during the two phases of the icemaking cycle.

Refer to the wiring diagram for reference.

**FREEZING CYCLE**

Electrical components	ON	OFF
Compressor .....	●	
Water Pump .....	●	
Fan Motor (Air cooled only) .....	●	
Hot Gas Valve .....		●
Inlet Water Valve .....		●

Electrical Controls	CLOSE	OPEN
Evaporator Thermostat (contacts 3-4) ...	●	
Evaporator Thermostat (contacts 3-2) ...		●
Bin Thermostat .....	●	

**HARVEST CYCLE**

Electrical components	ON	OFF
Compressor .....	●	
Water Pump .....		●
Fan Motor (Air cooled only) .....		●
Hot Gas Valve .....	●	
Inlet Water Valve .....	●	

Electrical Controls	CLOSE	OPEN
Evaporator Thermostat (contacts 3-4) ...		●
Evaporator Thermostat (contacts 3-2) ...	●	
Bin Thermostat .....	●	

**Freeze Cycle**

Average Discharge Pressure  
A/C: 7 ÷ 11 bars (100÷155 psig)

Average Discharge Pressure  
W/C: 8.5 ÷ 10 bars (120÷140 psig)

Suction Pressure  
End Freeze Cycle: 0 ÷ 0.1 bar (0 ÷ 1.5 psig)

**REFRIGERANT METERING DEVICE:**  
capillary tube

**REFRIGERANT CHARGE (R 134 A)**

Model	Air cooled	Water cooled
EC 46	260 gr ( 9.5 oz.)	250 gr (9.0 oz.)
EC 56	260 gr ( 9.5 oz.)	250 gr (9.0 oz.)
EC 86	280 gr (10.0 oz.)	250 gr (9.0 oz.)

**COMPONENTS DESCRIPTION**

**A. WATER PUMP**

The water pump operates continually throughout the freezing cycle.

The pump primes the water from the sump to the spray system and through the spray nozzles sprays it into the inverted cup molds to be frozen into crystal clear ice cubes.

**B. WATER INLET SOLENOID VALVE - 3/4 MALE FITTING**

The water inlet solenoid valve is energized only during the defrost cycle.

When energized it allows a metered amount of incoming water to flow over the evaporator cavity to assist the hot gas in defrosting the ice cubes. The water running over the evaporator cavity drops by gravity, through the dribbler holes of the platen, into the sump.

On water cooled versions the water inlet solenoid valve has one inlet and two outlets with two separate solenoids energized the first (ice production) by the contacts 3-2 of the evaporator thermostat and the second (water cooled condenser) by a specific hi pressure control.

**C. HOT GAS SOLENOID VALVE**

The hot gas solenoid valve consists basically in two parts: the valve body and the valve coil.

Located on the hot gas line, this valve is energized by the contacts 3-2 of the evaporator thermostat during the defrost cycle.

During the defrost cycle the hot gas valve coil is activated so to attract the hot gas valve piston in order to give way to the hot gas discharged from compressor to flow directly into the evaporator serpentine to defrost the formed ice cubes.

**D. BIN THERMOSTAT**

The bin thermostat control body is located in the front of control box behind the front louvered panel.

The thermostat sensing tube is located into a bulb holder on the side wall of the ice storage bin where it automatically shuts the icemaker OFF when in contact with the ice and re-starts the icemaker when the ice is removed. Factory settings are 1°C (35°F) OUT and 4°C (39°F) IN.

**E. CUBE SIZE CONTROL (EVAPORATOR THERMOSTAT)**

The cube size control (evaporator thermostat) body is located in the front of control box behind the front louvered panel; it's basically a reverse acting temperature control which closes the contacts 3-2 when its temperature decreases and closes the opposite contacts 3-4 when the temperature rises.

The thermostat sensing bulb is located into a plastic tube (bulb holder) secured by two clips directly to the evaporator serpentine.

This control determines the length of the freezing cycle and correspondingly the size of the cubes. A lower setting will produce a larger cube (oversize) while a higher setting a smaller cube (shallow size).

When closed on contacts 3-2 it activates the defrost or harvest cycle components.

The cube size control is set up in the factory (knob in the black dot position) and doesn't require any adjustment when the ambient temperature remains between 15 and 30°C (60 and 90°F).

#### F. FAN MOTOR (Air cooled version)

The fan motor is electrically connected in parallel to the water pump and it operates continuously only during the freezing cycle keeping the proper head pressure by circulating air through the condenser fins.

#### G. COMPRESSOR

The hermetic compressor is the heart of the refrigerant system and it is used to circulate and retrieve the refrigerant throughout the entire system. It compresses the low pressure refrigerant vapor causing its temperature to rise and become high pressure hot vapor (hot gas) which is then released through the discharge valve.

#### H. WATER SPRAY SYSTEM

Through its nozzles it sprays the water in each individual cup to be frozen into ice.

#### I. CLEANING SWITCH

Located on the bottom side of the control box is used to energize the water inlet and the hot gas valves so to charge the water into the sump of the machine when needed.

#### J. HI PRESSURE CONTROL (Water cooled version)

Used only on the water cooled versions it operates to keep between 8.5 and 10 bars (120 ÷ 140 psig) the hi-side or discharge pressure of the refrigerant system by energizing the coil of the water inlet solenoid valve that control the cooling water flow to the condenser.

#### K. GREEN MASTER SWITCH PUSH BUTTON

Located in the front of the machine it's used to switch ON and OFF the unit by pushing its green push button. When ON, its green light is ON as well.

#### L. RED ALARM/RE-SET PUSH BUTTON

Located in the front of the machine (just beside the Master Switch) it works in conjunction with

the Cleaning Remind Board and it's activated when:

- Condensing temperature is higher than 70°C (air cooled version) - **ON steady with machine in OFF mode**
- Condensing temperature is higher than 60°C (water cooled version) - **ON steady with machine in OFF mode**
- Condenser sensor out of order - **Blinking twice and repeat with machine in OFF mode**
- Condenser air filter need to be cleaned - **ON steady with machine in ON mode**
- Water system need to be cleaned - **Slow blinking with machine in ON mode.**

On the first two cases it's possible to Re-Set the operation of the machine pushing and hold the Red Alarm Re-Set Button by 5" till the Red Light is OFF.

On the third case, it's necessary first to replace the condenser sensor then, push and hold for 5" the Red Re-Set Button.

#### M. CLEANING REMIND AND PWD PC BOARD

Located on the front left side of the machine, it works in conjunction with the condenser sensor and the Red Alarm Re-Set Push Button.

It is used to energise the Water Drain Pump any time the level of the water into the Sealed water Reservoir reaches the upper metal pins (low power electrical circuit closed through the water). The water pump is kept energised by the PWD PC Board for 8 seconds.

It consists of a Printed Circuit Board with a step down transformer (230V - 12V), a relay, a Dip Switch with two keys, a Jumper for the set up of the Cut OFF/Alarm condensing temperature (70°C - jumper OUT - for air cooled version and 60°C - jumper IN - for water cooled version), a green four contacts connector for power IN and OUT, a Red socket for the Water Level Sensor, a Black socket for the Condenser Sensor and a White socket for the Red Alarm Re-Set Push Button.

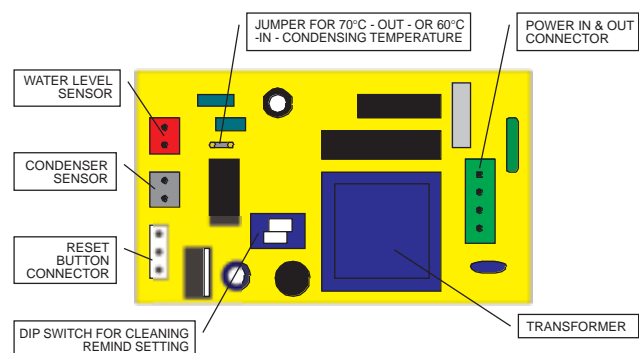

The main function of this PC Board is to switch OFF the machine when the condensing temperature is higher of its setting value or signal out the need for the cleaning of the condenser air filter (air cooled only) or of the water system.

The time between the signal out for the cleaning of the water system can be modified according to the setting of the two Dip Switches as below:

TIME	1	2
1 MONTH	ON	ON
3 MONTHS	OFF	ON
6 MONTHS	ON	OFF
1 YEAR	OFF	OFF

Once cleaned the water system, it's necessary to cancel the time stored into the PC Board by pushing and hold for more than 20" the Red Alarm Re-Set Button till it starts to blink. This PC Board is also used to energise the Water Pump to pump out the collected water inside the sealed water tank. In case the water level sensor transmit the signal to the PC Board for more than 5 minutes continuously the PC Board trip OFF the entire machine lighting ON the Red Alarm light that starts to blink fast (0.5" ON - 0.5" OFF).

**WARNING: to assure the correct operation of the Water level sensors, the water must have a minimal electrical of 10 µs.**

**N. SEALED WATER RESERVOIR**

Located on the bottom side of the unit, it is used to collect all water coming from the:

- Overflow
- Water Drain Valve
- Storage bin

On its top cover are secured two metal pins (Water Level Sensor) connected to the PWD PC Board.

**O. WATER DRAIN PUMP**

Placed beside the Sealed Water Reservoir is used to pump out the water contained into the tank. It is energised, by the PWD PC Board, for just few seconds.

**P. CHECK VALVE**

Placed on the discharge hose of the water pump, it prevents the coming back of the pumped out water.

**Q. CONDENSER AIR FILTER (Air cooled version)**

Located in front of the air cooled condenser can be removed by withdrawing it through the opening of the front panel for cleaning or replacing. A lower plastic guide, installed inside the unit, is used for the correct sliding and location of the air filter.

**R. CONDENSER SENSOR**

The condenser temperature sensor probe, located within the condenser fins (air cooled version) or in contact with the tube coil (water cooled version) detects the condenser temperature variations and signals them by supplying current, at low voltage, to the P.C. BOARD. In case the condenser temperature rises and reaches **70°C (160°F)** - on air cooled models - or **60°C (140°F)** - on water cooled models - the current arriving to the micro processor is such to cause an immediate and total stop of the machine operation.

## ADJUSTMENT PROCEDURES

### A. ADJUSTMENT OF THE CUBE SIZE CONTROL

**CAUTION.** Before performing actual adjustment of the cube size control, check other possible causes for cube size problems, refer to section IV, service diagnosis for problem review and analysis.

**Adjustment of the cube size control is performed:**

A. If ice cubes are shallow size (Indentation is too deep):

1. Locate the cube size control knob in the front of control box.
2. Rotate the adjusting knob one eighth of a turn clockwise.
3. Observe size of ice cubes in next two ice cube harvest and repeat step 2 above, in one-eighth turn increments, until proper ice cube size is achieved.

B. If ice cubes are oversize (Indentation is too full) or they are not released:

1. Locate the cube size control knob in the front of control box.
2. Rotate the adjusting knob one eighth of a turn counterclockwise.
3. Observe size of ice cubes in next two ice cube harvest and repeat step 2 above, in one-eighth turn increments, until proper ice cube size is achieved.

Once the control knob is set to obtain the ice cubes in the proper shape, the ice maker does not require any more immediate attention.

### 2. ADJUSTMENT OF THE BIN LEVEL CONTROL

Adjustment of the bin level control is normally performed, to cause more ice to be produced to result in a higher ice level in the bin; or, to cause less ice to be produced, to result in a response to a too cold or too much ice condition, be sure to adjust only in a maximum of one-eighth turn of control knob rotation at a time.

Clockwise rotation corresponds to a colder setting. Counterclockwise rotation corresponds to a warmer setting.

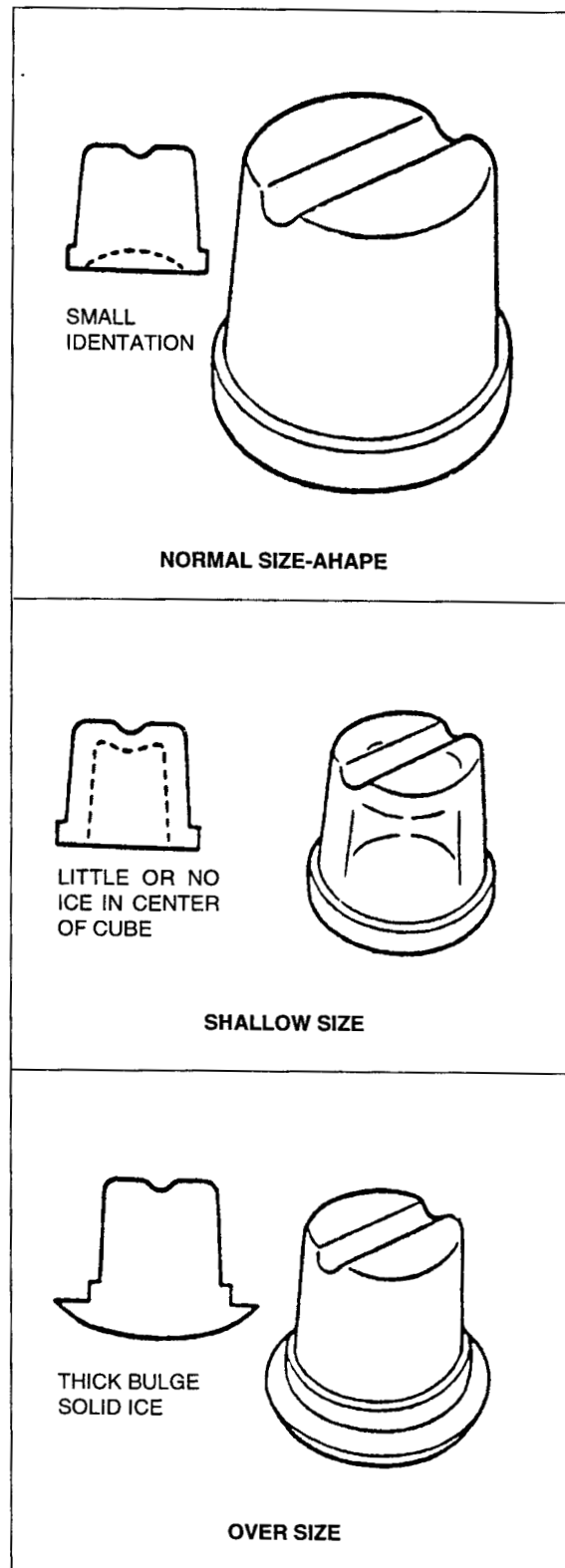

## WIRING DIAGRAM

**EC 46 - EC 56 AIR AND WATER COOLED 230/50-60/1**  
 The unit is shown on freezing cycle

- BK BLACK
- BN BROWN
- BU BLUE
- GY GREY
- GNYE GREEN-YELLOW
- GN GREEN
- RD RED
- YE YELLOW
- WH WHITE
- OG ORANGE
- PK PINK

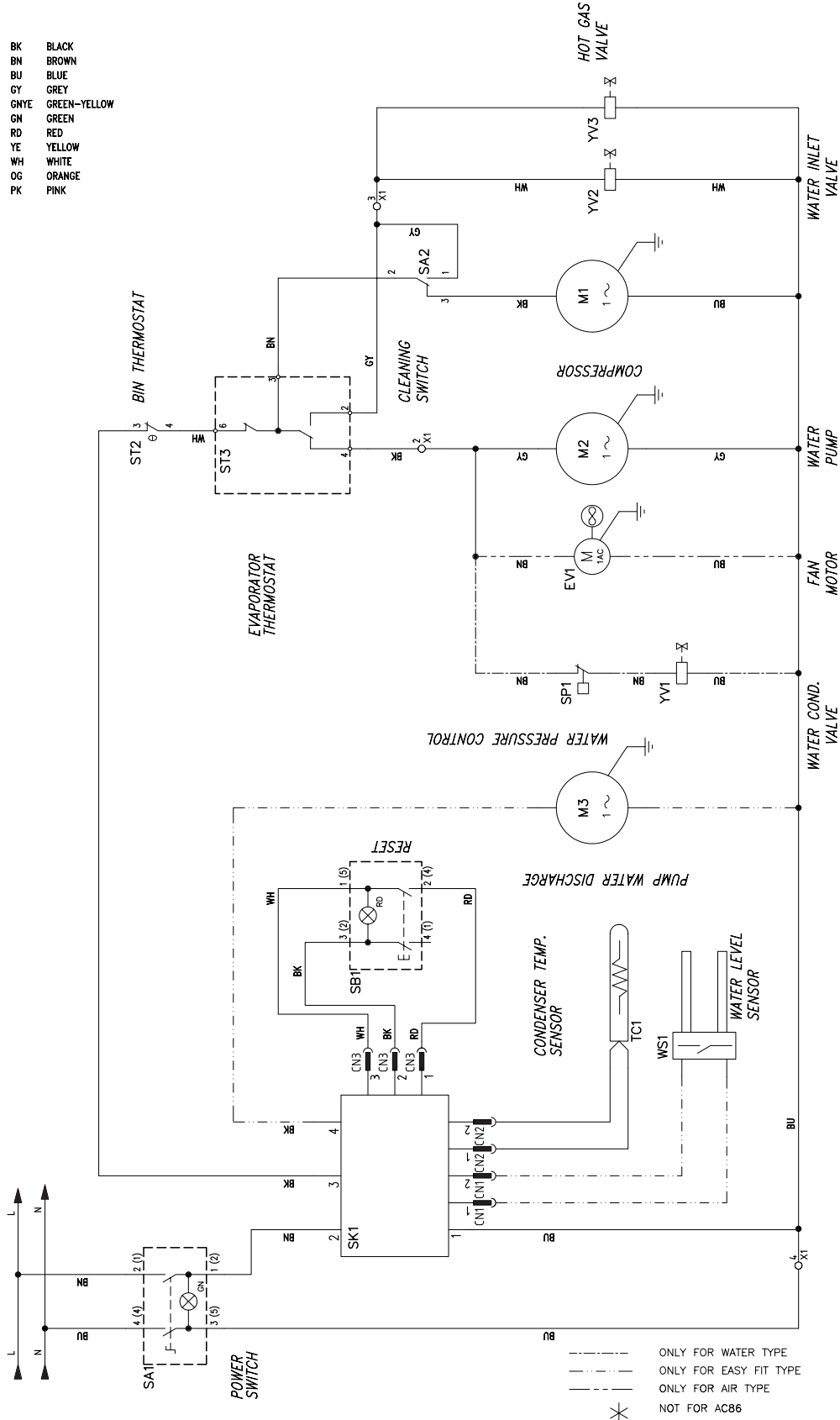

# WIRING DIAGRAM

EC 86 AIR AND WATER COOLED 230/50/1  
The unit is shown on freezing cycle

- BK BLACK
- BN BROWN
- BU BLUE
- GY GREY
- GNYE GREEN-YELLOW
- GN GREEN
- RD RED
- YE YELLOW
- WH WHITE
- OG ORANGE
- PK PINK

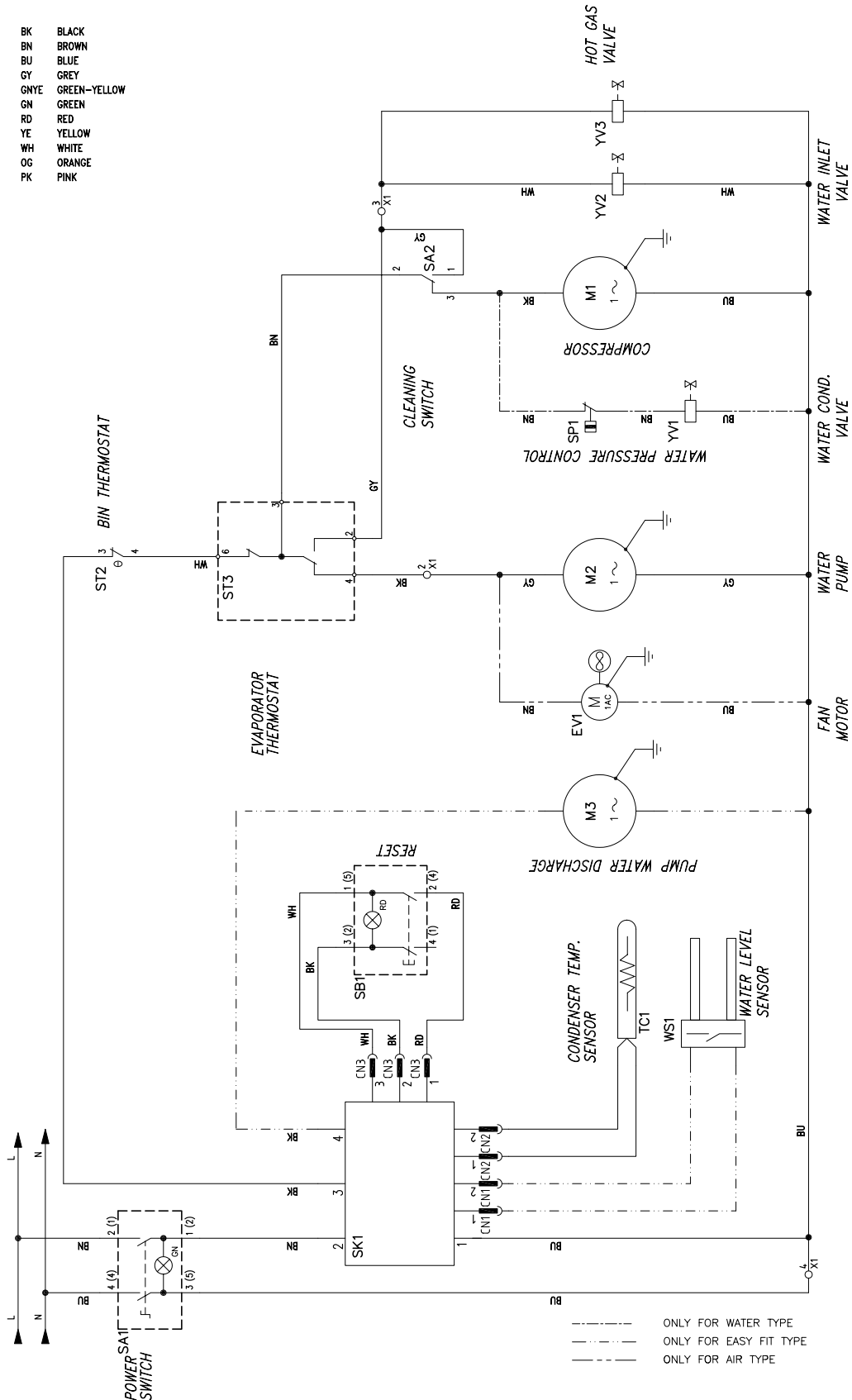

## WIRING DIAGRAM

### EC 86 AIR AND WATER COOLED 230/60/1

The unit is shown on freezing cycle

- BK BLACK
- BN BROWN
- BU BLUE
- GY GREY
- GNYE GREEN-YELLOW
- GN GREEN
- RD RED
- YE YELLOW
- WH WHITE
- OG ORANGE
- PK PINK

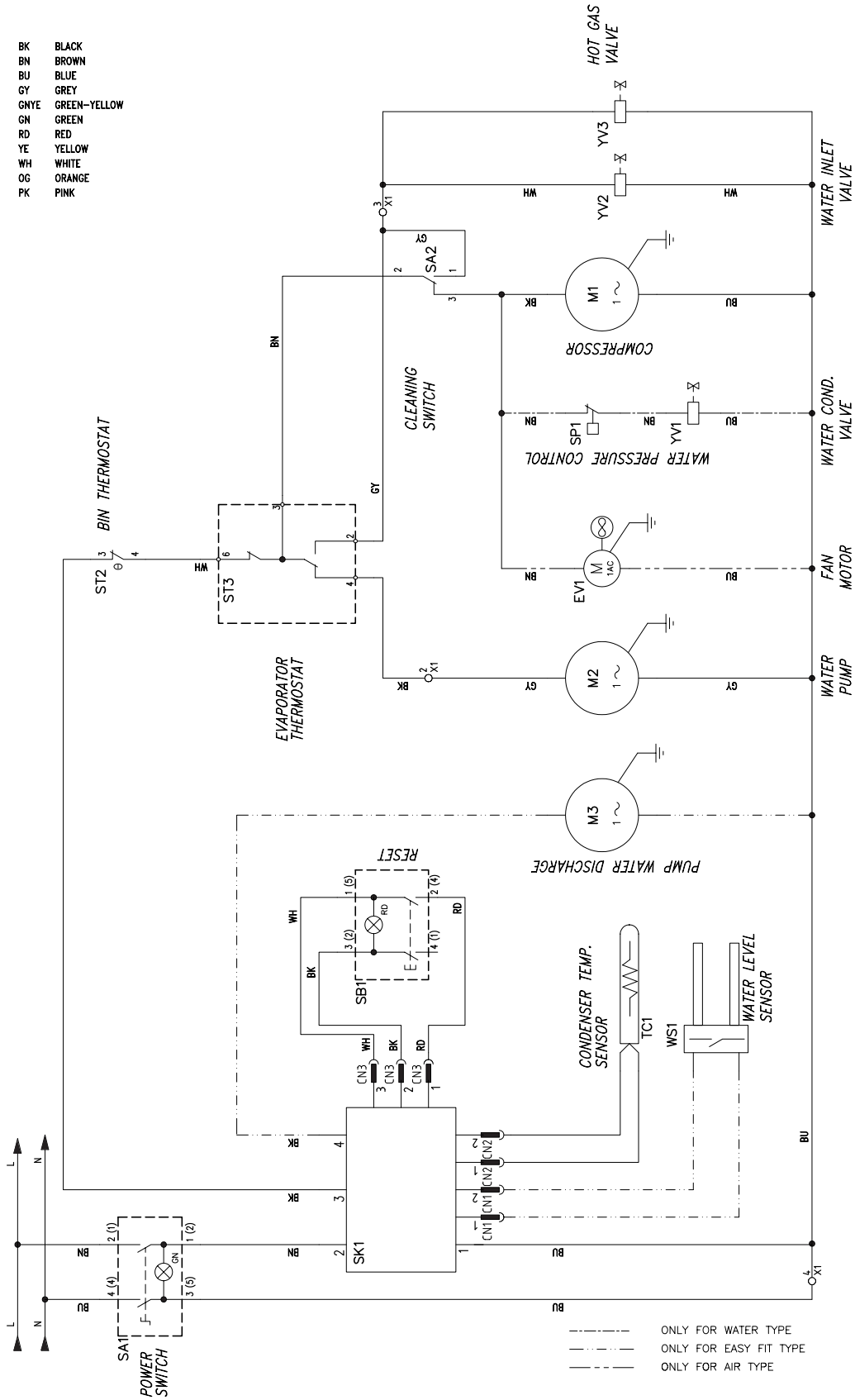

**SERVICE DIAGNOSIS**

<b>SYMPTON</b>	<b>POSSIBLE CAUSE</b>	<b>SUGGESTED CORRECTION</b>
Unit will not run	Blown fuse	Replace fuse & check for cause of blown fuse.
	Main switch in OFF position	Turn switch to ON position
	Bin thermostat set improperly	Adjust rotating its setting screw
	Loose electrical connections	Check wiring
Red Alarm light ON with unit ON	Condensing temperature > 60°C	Clean the air cooled condenser filter
Red Alarm light ON with unit OFF	Too Hi Condensing Temperature	Reset the machine (Push & hold the Reset Button for 5") and check for reason why
Red Alarm light Blinking Twice and repeat	Condenser sensor out of order	Replace it
Red Alarm light blinks fast	Problem in pumping out water	Check for correct operation of pumping out water pump, water level sensor and drain tube
Compressor cycles intermittently	Low voltage	Check circuit for overloading Check voltage at the supply to the building. If low, contact the power company
	Non-condensable gas in system	Purge the system
	Dirty condenser	Clean with vacuun cleaner, air or stiff brush. (DO NOT use wire brush).
	Air circulation blocked	Allow sufficient air space all around unit.
	Compressor starting device with loose wires	Check for loose wires in starting device.
Cubes too small	Cube size control set improperly	Check and adjust for proper operation.
	Capillary tube partially restricted	Blow charge, add new gas & drier, after evacuating system with vacuum pump.
	Moisture in the system	Same as above.
	Shortage of water	See remedies for shortage of water.
	Shortage of refrigerant	Check for leaks & recharge.
Cloudy cubes	Shortage of water	See remedies for shortage of water.
	Dirty water supply	Use water softner or water filter.
	Accumulated impurities	Use SCOTSMAN Ice Machine cleaner.
Shortage of water	Water spilling out through curtain	Check or replace curtain.
	Water solenoid valve not opening	Replace valve.
	Water leak in sump area	Locate and repair.
	Water flow control plugged	Remove and clean.



**SERVICE DIAGNOSIS**

<b>SYMPTON</b>	<b>POSSIBLE CAUSE</b>	<b>SUGGESTED CORRECTION</b>
Irregular cubes size & some cloudy	Some jets plugged Shortage of water Unit not levelled Poor pumping	Remove jet cover and clean. See shortage of water. Level as required. Check and/or replace the water pump.
Cubes too large	Cube size control set improperly	Check and adjust for proper operation.
Decreased ice capacity	Inefficient compressor Leaky water valve Non-condensable gas in system Poor air circulation or excessive hot location Overcharge of refrigerant Capillary tube partially restricted Undercharge of refrigerant Discharge head pressure too high Clogged air filter	Replace. Repair or replace. Purge the system. Relocate the unit or provide for more ventilation. Correct the charge. Purge off slowly. Blow charge, add new gas & drier, after evacuating system with vacuum pump. Charge to data plate indication. See incorrect discharge pressure. Clean or replace.
Poor harvest	Restriction in incoming water line Too short defrost time Cube size control set for too large cubes Water inlet valve not opening Hot gas valve orifice restricted Air vented holes in mold cups plugged Discharge head pressure too low	Check water valve strainer and flow control. If necessary enlarge the flow control orifice. Check temperature control. Replace if necessary. Re-set cube size control. Valve coil with open winding. Replace valve. Replace hot gas valve assy. Clean out holes. See incorrect discharge pressure
Unit won't harvest	Inoperative cube size control Hot gas valve not opening Water solenoid valve not opening	Replace cube size control Valve coil with open winding. Replace valve. Valve coil with open winding. Replace valve.
Incorrect discharge pressure	Dirty air filter Inoperative hi press control (Water cooled) Water inlet valve to condenser partially clogged	Clean or replace. Replace. Clean or replace.
Excessive water in unit base	Water tubing leaking	Check. Tighten or replace.

## MAINTENANCE AND CLEANING INSTRUCTIONS

### A. GENERAL

The periods and the procedures for maintenance and cleaning are given as guides and are not to be construed as absolute or invariable. Cleaning, especially, will vary depending upon local water and ambient conditions and the ice volume produced; and, each icemaker must be maintained individually, in accordance with its particular location requirements.

### B. ICEMAKER

The following maintenance should be scheduled at least two times per year on these icemakers.

1. Check and clean the water line strainer.
2. Check that the icemaker is levelled in side to side and in front to rear directions.
3. Check for water leaks and tighten drain line connections. Pour water down bin drain line to be sure that drain line is open and clear.
4. Check size, condition and texture of ice cubes. Perform adjustment of cube size control as required.
5. Check the bin thermostat to test shut-off. Put a showfull of ice cubes in contact with the bin thermostat bulb for at least one minute. This should cause the ice maker to shut off.

Within few seconds after the removal of the showfull of ice from bin thermostat bulb, the icemaker restarts.

**NOTE.** Within minutes after the ice is removed from the bulb holder tube, the sensing bulb inside the tube will warm up and cause the icemaker to restart. This control is factory set and should not be reset until testing is performed.

6. Check for refrigerant leaks.

**NOTE.** The new EC series, in the air cooled version, are standard equipped with an air condenser filter as well as a Cleaning Reminder Board to remind to the end user the need for the cleaning of the air filter or of the water system (Red Alarm Light ON Steady or Blinking respectively with machine in operation).

### C. CLEAN - REPLACE OF AIR CONDENSER FILTER

1. Withdraw the air filter from the front through the opening of the front panel.



2. Blow pressurised air on the opposite direction of the condenser air flow so to remove the dust accumulated.
3. If pressurised air is not available, use tap water always in the counter flow air direction. Once cleaned shake it so to remove most of the accumulated water, then dry it using an hair dryer.

**NOTE.** In case the air filter strainer is damaged replace it with a new one.

4. Install it again by pushing it through the front panel opening.

### D. CLEANING INSTRUCTIONS OF WATER SYSTEM

1. Remove the front and top panels to gain access either to the control box and to the evaporator.
2. Make sure that all ice cubes have been released from their cups, then switch OFF the machine at front master button switch.
3. Scoop out all the ice cubes stored into the bin in order to prevent them from being contaminated with the cleaning solution.

4. Remove the plastic cup located on the bottom of sump/freezing chamber to drain out all water and scale deposits.



5. Unloose the two thumb screws and remove the curtain.



6. Lift up the entire spray platen from its bottom seat and take it out to clean it separately.

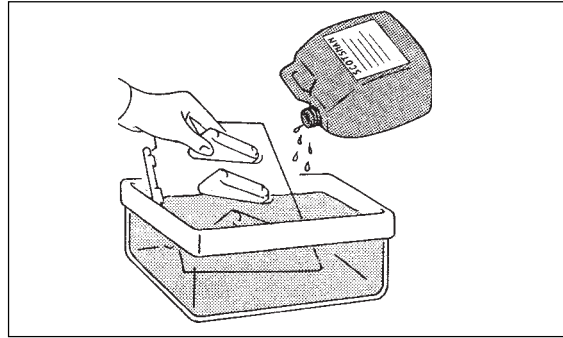

7. Using a bottle, pour fresh water into the bottom of the sump/freezing chamber to clean out most of scale deposit.

8. Install again the spray platen, the curtain as well as the bottom plastic cup.

9. Prepare the cleaning solution by diluting in a plastic container two liters of warm water (45°-50°C) with 0,2 liters of Ice Machine Cleaner.

**WARNING. The SCOTSMAN Ice Machine Cleaner contains Phosphoric and Hydroxyacetic acids. These compounds are corrosive and may cause burns if swallowed, DO NOT induce vomiting. Give large amounts of water or milk. Call Physician immediately. In case of external contact flush with water. KEEP OUT OF THE REACH OF CHILDREN.**

10. Remove the evaporator cover then slowly pour onto the evaporator platen the cleaning solution. With the help of a brush dissolve the most resistant and remote scale deposits in the platen.

11. Switch ON again the machine at front master button switch to start the icemaking process. Allow the ice maker to operate for about 20 minutes. Then turn the cleaning switch to the "cleaning" position (II) till the release of the ice cubes from their cups.

**NOTE. The amount of Cleaner and the time needed for the cleaning of water system depends of the water conditions.**

12. Switch OFF the ice maker at master button switch then flush out the cleaning solution from the sump reservoir by taking off the sump plastic cup. Once flushed out install again the sump plastic cup.

13. Pour onto the evaporator cavity two or three liters of clean potable water to rinse the mold cups and the platen.

14. Switch ON again the machine. The water pump is again in operation to circulate the water in order to rinse the entire water system.

Do the operation as per steps 12 and 13 twice so to be sure no more traces of descaling solution remains into the sump.

15. With machine in OFF mode pour on the upper side of the evaporator platen fresh water with a capfull of sanitizing solution then turn again the machine in normal operating mode so to sanitize all the water system for approx. 10 minutes.

**NOTE.** *Do not mix descaling with sanitizing solution to avoid the generation of a very aggressive acid.*

16. Switch OFF the machine and flush out the sanitizing solution from the sump reservoir then with the switch in "cleaning" position (II), switch it ON again.

When water starts overflowing through the drain line, set the switch to "operation" (I) position. The unit is now ready to resume normal operation.

17. Place again the evaporator cover and the unit service panels.

18. At completion of the freezing and harvest cycle make sure of proper texture and clearness of the ice cubes and that, they do not have any acid taste.

**ATTENTION.** *In case the ice cubes are cloudy-white and have an acid taste, melt them immediately by pouring on them some warm water. This to prevent that somebody could use them.*

19. Wipe clean and rinse the inner surfaces of the storage bin.

**REMEMBER.** *To prevent the accumulation of undesirable bacteria it is necessary to sanitize every week the interior of the storage bin.*