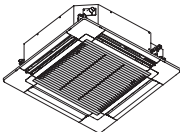
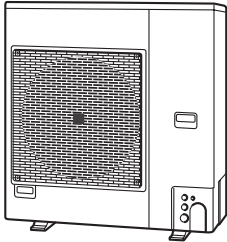
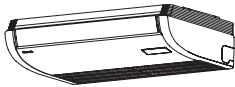

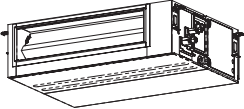


## TECHNICAL DATA & SERVICE MANUAL



Indoor Unit		Outdoor Unit
	4-Way Cassette	
	Ceiling	
	Wall Mounted	
	Low Silhouette Ducted	

### ■ R32 Models

Model No.

#### Indoor Units

Type	Indoor Units Type	36	45	50	60	71	100	125	140
U2	4-Way Cassette	–	–	S-50PU2E5B	S-60PU2E5B	S-71PU2E5B	S-100PU2E5B	S-125PU2E5B	S-140PU2E5B
T2	Ceiling	–	–	S-50PT2E5B	S-60PT2E5B	S-71PT2E5B	S-100PT2E5B	S-125PT2E5B	S-140PT2E5B
K2	Wall Mounted	–	–	S-50PK2E5B	S-60PK2E5B	S-71PK2E5B	S-100PK2E5B	–	–
F1	Low Silhouette Ducted	–	–	S-50PF1E5B	S-60PF1E5B	S-71PF1E5B	S-100PF1E5B	S-125PF1E5B	S-140PF1E5B

#### Outdoor Units

Type	Outdoor Units Type	36	50	60	71	100	125	140
PZ2	Single Split (1-phase)	–	–	–	–	U-100PZ2E5	U-125PZ2E5	U-140PZ2E5
	Single Split (3-phase)	–	–	–	–	U-100PZ2E8	U-125PZ2E8	U-140PZ2E8

## IMPORTANT!

### Please Read Before Starting

This air conditioner must be installed by the sales dealer or installer.  
This information is provided for use only by authorized persons.

**For safe installation and trouble-free operation, you must:**

- Carefully read this instruction booklet before beginning.
- Follow each installation or repair step exactly as shown.
- This air conditioner shall be installed in accordance with National Wiring Regulations.
- That compliance with national gas regulations shall be observed.
- The product meets the technical requirements of EN/IEC 61000-3-3.
- Pay close attention to all warning and caution notices given in this manual.



#### WARNING

This symbol refers to a hazard or unsafe practice which can result in severe personal injury or death.



#### CAUTION

This symbol refers to a hazard or unsafe practice which can result in personal injury or product or property damage.

#### If Necessary, Get Help

These instructions are all you need for most installation sites and maintenance conditions. If you require help for a special problem, contact our sales/service outlet or your certified dealer for additional instructions.

#### In Case of Improper Installation

The manufacturer shall in no way be responsible for improper installation or maintenance service, including failure to follow the instructions in this document.



#### WARNING

- Do not use means to accelerate the defrosting process or to clean, other than those recommended by the manufacturer.
- The appliance shall be stored in a room without continuously operating ignition sources (for example: open flames, an operating gas appliance or an operating electric heater).
- Do not pierce or burn.
- Be aware that refrigerants may not contain an odour.

- The following checks shall be applied to installations using flammable refrigerants. Appliance shall be installed, operated and stored in a room with a floor area larger than [Amin] m<sup>2</sup>. As for [Amin], see the section "CHECK OF DENSITY LIMIT".


## SPECIAL PRECAUTIONS



### WARNING When Wiring



**ELECTRICAL SHOCK CAN CAUSE SEVERE PERSONAL INJURY OR DEATH. ONLY A QUALIFIED, EXPERIENCED ELECTRICIAN SHOULD ATTEMPT TO WIRE THIS SYSTEM.**

- Do not supply power to the unit until all wiring and tubing are completed or reconnected and checked.
- Highly dangerous electrical voltages are used in this system. Carefully refer to the wiring diagram and these instructions when wiring. Improper connections and inadequate grounding can cause **accidental injury or death.**
- Connect all wiring tightly. Loose wiring may cause overheating at connection points and a possible fire hazard.
- Provide a power outlet to be used exclusively for each unit.
- Provide a power outlet exclusively for each unit, and full disconnection means having a contact separation by 3 mm in all poles must be incorporated in the fixed wiring in accordance with the wiring rules.
- To prevent possible hazards from insulation failure, the unit must be grounded. 

- Check that cabling will not be subject to wear, corrosion, excessive pressure, vibration, sharp edges or any other adverse environmental effects. The check shall also take into account the effects of aging or continual vibration from sources such as compressors or fans.
- This equipment is strongly recommended to be installed with Earth Leakage Circuit Breaker (ELCB) or Residual Current Device (RCD). Otherwise, it may cause electrical shock and fire in case of equipment breakdown or insulation breakdown.

### When Transporting

- It may need two or more people to carry out the installation work.
- Be careful when picking up and moving the indoor and outdoor units. Get a partner to help, and bend your knees when lifting to reduce strain on your back. Sharp edges or thin aluminum fins on the air conditioner can cut your fingers.

### When storing...



#### WARNING

- The appliance shall be stored in a well-ventilated area where the room size corresponds to the room area as specified for operation.
- The appliance shall be stored in a room without continuously operating open flames (for example: an operating gas appliance) and ignition sources (for example: an operating electric heater).
- The appliance shall be stored so as to prevent mechanical damage from occurring.

### When Installing...

- Select an installation location which is rigid and strong enough to support or hold the unit, and select a location for easy maintenance.

- In cases that require mechanical ventilation, ventilation openings shall be kept clear of obstruction.
- An unventilated area where the appliance using flammable refrigerants is installed shall be so constructed that should any refrigerant leak, it will not stagnate so as to create a fire or explosion hazard.

#### ...In a Room

Properly insulate any tubing run inside a room to prevent “sweating” that can cause dripping and water damage to walls and floors.



#### CAUTION

Keep the fire alarm and the air outlet at least 1.5 m away from the unit.

#### ...In Moist or Uneven Locations

Use a raised concrete pad or concrete blocks to provide a solid, level foundation for the outdoor unit. This prevents water damage and abnormal vibration.

#### ...In an Area with High Winds

Securely anchor the outdoor unit down with bolts and a metal frame. Provide a suitable air baffle.

#### ...In a Snowy Area (for Heat Pump-type Systems)

Install the outdoor unit on a raised platform that is higher than drifting snow. Provide snow vents.

#### ...At least 2.5 m (Excepting Type K2 [1.8 m])

Indoor unit of this air conditioner shall be installed in a height of at least 2.5 m.

#### ...In laundry rooms

Do not install in laundry rooms. Indoor unit is not drip proof.

### When Connecting Refrigerant Tubing

Pay particular attention to refrigerant leakages.



## WARNING

- When performing piping work, do not mix air except for specified refrigerant (R32) in refrigeration cycle. It causes capacity down, and risk of explosion and injury due to high tension inside the refrigerant cycle.
- If the refrigerant comes in contact with a flame, it produces a toxic gas.
- Do not add or replace refrigerant other than specified type. It may cause product damage, burst and injury, etc.
- Ventilate the room immediately, in the event that is refrigerant gas leaks during the installation. Be careful not to allow contact of the refrigerant gas with a flame as this will cause the generation of toxic gas.
- Keep all tubing runs as short as possible.
- Use the flare method for connecting tubing.
- Apply refrigerant lubricant to the matching surfaces of the flare and union tubes before connecting them, then tighten the nut with a torque wrench for a leak-free connection.
- Check carefully for leaks before starting the test run.
- Do not leak refrigerant while piping work for an installation or re-installation, and while repairing refrigeration parts. Handle liquid refrigerant carefully as it may cause frostbite.
- Under no circumstances shall potential sources of ignition be used in the searching or detection of refrigerant leaks.
- A halide torch (or any other detector using a naked flame) shall not be used.
- Electronic leak detectors may be used to detect refrigerant leaks but, the sensitivity may not be adequate, or may need re-calibration. (Detection equipment shall be calibrated in a refrigerant-free area.)
- Ensure that the detector is not a potential source of ignition and is suitable for the refrigerant used.
- Leak detection equipment shall be set at a percentage of the lower flammable limit (LFL) of the refrigerant and shall be calibrated to the refrigerant employed and the appropriate percentage of gas (25 % maximum) is confirmed.
- Leak detection fluids are suitable for use with most refrigerants but the use of detergents containing chlorine shall be avoided as the chlorine may react with the refrigerant and corrode the copper pipe-work.
- If a leak is suspected, all naked flames shall be removed/extinguished.
- If a leakage of refrigerant is found which requires brazing, all of the refrigerant shall be recovered from the system, or isolated (by means of shut off valves) in a part of the system remote from the leak. Oxygen free nitrogen (OFN) shall then be purged through the system both before and during the brazing process.

## When Servicing

- Contact to the sales dealer or service dealer for a repair.
- Be sure to turn off the power before servicing.
- Turn the power OFF at the main power box (mains), wait at least 10 minutes until it is discharged, then open the unit to check or repair electrical parts and wiring.
- Keep your fingers and clothing away from any moving parts.
- Clean up the site after you finish, remembering to check that no metal scraps or bits of wiring have been left inside the unit.





## WARNING

- This product must not be modified or disassembled under any circumstances. Modified or disassembled unit may cause fire, electric shock or injury.
- Do not clean inside the indoor and outdoor units by users. Engage authorized dealer or specialist for cleaning.
- In case of malfunction of this appliance, do not repair by yourself. Contact to the sales dealer or service dealer for a repair and disposal.



## CAUTION

- Ventilate any enclosed areas when installing or testing the refrigeration system. Leaked refrigerant gas, on contact with fire or heat, can produce dangerously toxic gas.
- Confirm after installation that no refrigerant gas is leaking. If the gas comes in contact with a burning stove, gas water heater, electric room heater or other heat source, it can cause the generation of toxic gas.

## Others

When disposal of the product, do follow the precautions in “12. Recovery” on page 1-11-1-6 and comply with national regulations.



## WARNING

- Do not sit or step on the unit. You may fall down accidentally.



## CAUTION

- Do not touch the air inlet or the sharp aluminum fins of the outdoor unit. You may get injured.
- Do not stick any object into the FAN CASE. You may be injured and the unit may be damaged.

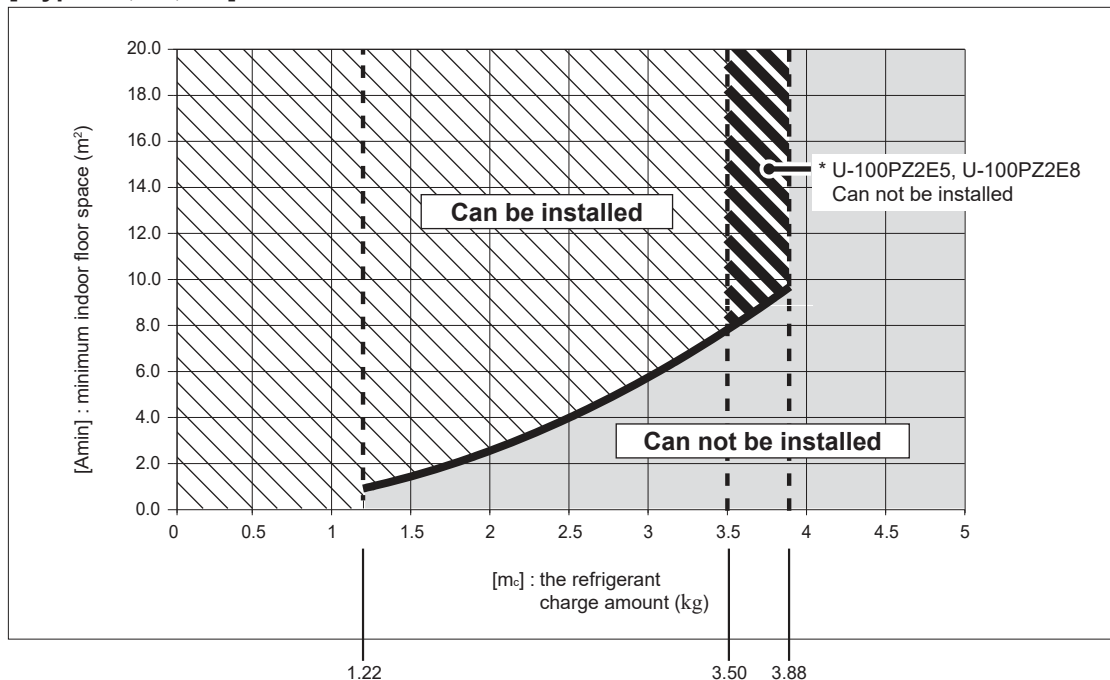


## CHECK OF DENSITY LIMIT

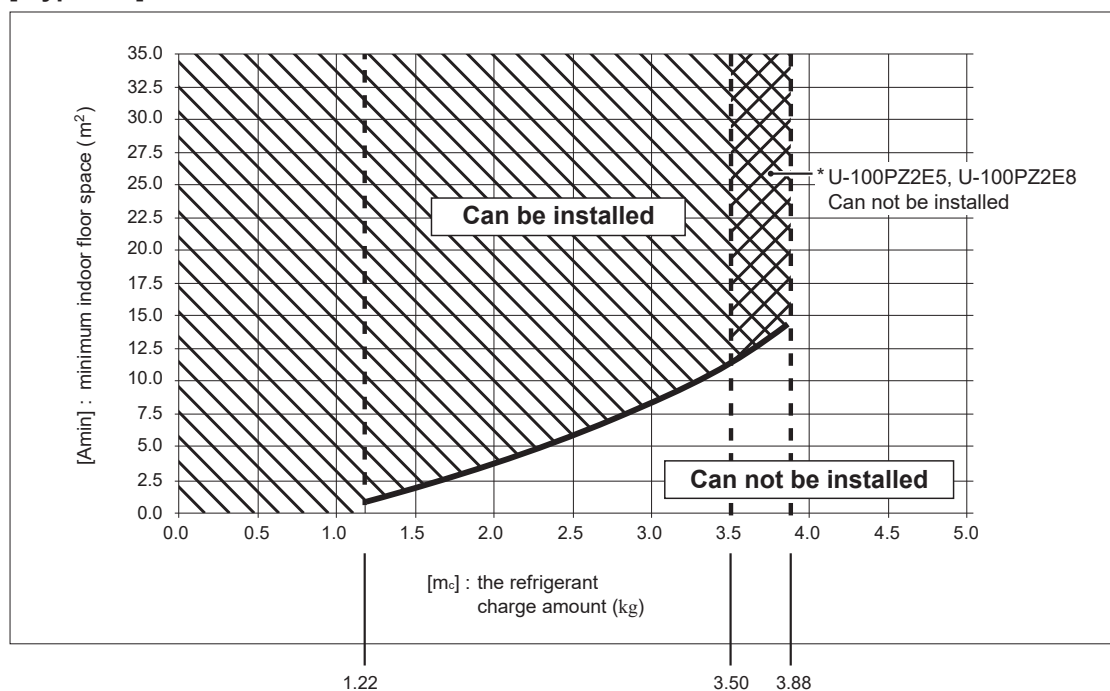
The refrigerant (R32), which is used in the air conditioner, is a flammable refrigerant. So the requirements for installation space of appliance are determined according to the refrigerant charge amount [ $m_c$ ] used in the appliance.

The minimum indoor floor space compared with the amount of refrigerant is roughly as follows:

### [ Type U2, T2, F1 ]



### [ Type K2 ]



[ $m_c$ ] : The refrigerant charge amount (Total of refrigerant at shipment and refrigerant charge amount in the field).

[ $m_{max}$ ] : Maximum refrigerant charge amount

	U-100PZ2E5 U-100PZ2E8	U-125PZ2E5 U-125PZ2E8	U-140PZ2E5 U-140PZ2E8
[ $m_{max}$ ]	3.50	3.88	3.88

[ $m_c$ ]  $\leq$  1.22 : Can be installed

1.22 < [ $m_c$ ]  $\leq$  [ $m_{max}$ ] : Installation possible with in the range of slanted line part

[ $m_c$ ] > [ $m_{max}$ ] : Can not be installed

# Precautions for Installation Using New Refrigerant

## 1. Care regarding tubing

### 1-1. Process tubing

- **Material:** Use seamless phosphorous deoxidized copper tube for refrigeration. Wall thickness shall comply with the applicable legislation. The minimal wall thickness must be in accordance with the table below.
- **Tubing size:** Be sure to use the sizes indicated in the table below.  
For the renewal tubing size, refer to the Technical Data.
- Use a tube cutter when cutting the tubing, and be sure to remove any flash. This also applies to distribution joints (optional).
- When bending tubing, use a bending radius that is 4 times the outer diameter of the tubing or larger.



**CAUTION** Use sufficient care in handling the tubing. Seal the tubing ends with caps or tape to prevent dirt, moisture, or other foreign substances from entering. These substances can result in system malfunction.

Unit: mm

Material		Temper - O (Soft copper tube)			
Copper tube	Outer diameter	6.35	9.52	12.7	15.88
	Wall thickness	0.8	0.8	0.8	1.0

1-2. Prevent impurities including water, dust and oxide from entering the tubing. Impurities can cause R32 refrigerant deterioration and compressor defects. Due to the features of the refrigerant and refrigerating machine oil, the prevention of water and other impurities becomes more important than ever.

## 2. Be sure to recharge the refrigerant only in liquid form.

2-1. Since refrigerant composition changes and performance decreases when gas leaks, collect the remaining refrigerant and recharge the required total amount of new refrigerant after fixing the leak.

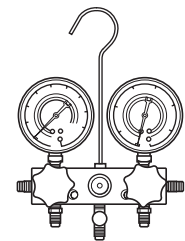
## 3. Different tools required

3-1. Tool specifications have been changed due to the characteristics of R32.

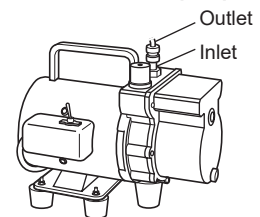
Some tools for R22- and R407C-type refrigerant systems cannot be used.

Item	Different tools? (From R22 and R407C)	R410A tools compatible with R32?	Remarks
Manifold gauge	Yes	Yes	Types of refrigerant, refrigerating machine oil, and pressure gauge are different.
Charge hose	Yes	Yes	To resist higher pressure, material must be changed.
Vacuum pump	Yes	Yes	Use a conventional vacuum pump if it is equipped with a check valve. If it has no check valve, purchase and attach a vacuum pump adapter.
Leak detector	Yes	Yes	Leak detectors for CFC and HCFC that react to chlorine do not function because R32 and R410A contains no chlorine. Leak detectors for HFC can be used for R32 and R410A.
Flaring oil	Yes	Yes	For systems that use R22, apply mineral oil (Suniso oil) to the flare nuts on the tubing to prevent refrigerant leakage. For machines that use R32 or R410A, apply synthetic oil (ether oil) to the flare nuts.

Manifold gauge



Vacuum pump

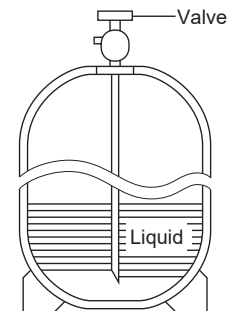


\* Using tools for R22 and R407C can cause defects.

### Single-outlet valve

(with siphon tube)

Liquid refrigerant should be recharged with the cylinder standing on end as shown.



## Important Information Regarding The Refrigerant Used

This product contains fluorinated greenhouse gases. Do not vent gases into the atmosphere.

Refrigerant type: R32


GWP<sup>(1)</sup> value: 675

<sup>(1)</sup>GWP = global warming potential

Periodical inspections for refrigerant leaks may be required depending on European or local legislation. Please contact your local dealer for more information.

Fill in the blanks below with the indelible ink pens.

- 1 : the factory refrigerant charge of the product
- 2 : the additional refrigerant amount charged in the field
- 1 + 2 : the total refrigerant charge
- $(1 + 2) \times 3 / 1000$ : CO<sub>2</sub> equivalent in tons; multiply the total refrigerant charge by GWP value, then divided by 1000.

 **This product contains fluorinated greenhouse gases.**  
CO<sub>2</sub> equivalent amount is shown in "CO<sub>2</sub> eq." 4

**R32**

GWP : 675 3

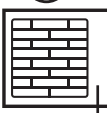

① =  kg 1

② =  kg 2

---

① + ② =  kg 3

"CO<sub>2</sub> eq."  
 $\frac{(\text{①} + \text{②}) \times \text{③}}{1\ 000} =$   ton 8

①  ② 

7 5 6

1. Factory refrigerant charge of the product: see unit name plate
2. Additional refrigerant amount charged in the field\*
3. Total refrigerant charge
4. Contains fluorinated greenhouse gases
5. Outdoor unit
6. Refrigerant cylinder and manifold for charging
7. GWP(global warming potential) of the refrigerant used in this product
8. CO<sub>2</sub> equivalent of fluorinated greenhouse gases contained in this product

\* See the section "1-5. Tubing Size"



# Combination of Indoor and Outdoor Units

**PZ2**

Single-phase

	36	45	50	60	71	100	125	140
<b>U2</b>						S-100PU2E5B U-100PZ2E5	S-125PU2E5B U-125PZ2E5	S-140PU2E5B U-140PZ2E5
			S-50PU2E5B x2 U-100PZ2E5	S-60PU2E5B x2 U-125PZ2E5	S-71PU2E5B x2 U-140PZ2E5			
<b>T2</b>						S-100PT2E5B U-100PZ2E5	S-125PT2E5B U-125PZ2E5	S-140PT2E5B U-140PZ2E5
			S-50PT2E5B x2 U-100PZ2E5	S-60PT2E5B x2 U-125PZ2E5	S-71PT2E5B x2 U-140PZ2E5			
<b>K2</b>						S-100PK2E5B U-100PZ2E5		
			S-50PK2E5B x2 U-100PZ2E5	S-60PK2E5B x2 U-125PZ2E5	S-71PK2E5B x2 U-140PZ2E5			
<b>F1</b>						S-100PF1E5B U-100PZ2E5	S-125PF1E5B U-125PZ2E5	S-140PF1E5B U-140PZ2E5
			S-50PF1E5B x2 U-100PZ2E5	S-60PF1E5B x2 U-125PZ2E5	S-71PF1E5B x2 U-140PZ2E5			

## Combination of Indoor and Outdoor Units

**PZ2**

**3-phase**

	36	45	50	60	71	100	125	140
<b>U2</b>						S-100PU2E5B U-100PZ2E8	S-125PU2E5B U-125PZ2E8	S-140PU2E5B U-140PZ2E8
			S-50PU2E5B x2 U-100PZ2E8	S-60PU2E5B x2 U-125PZ2E8	S-71PU2E5B x2 U-140PZ2E8			
<b>T2</b>						S-100PT2E5B U-100PZ2E8	S-125PT2E5B U-125PZ2E8	S-140PT2E5B U-140PZ2E8
			S-50PT2E5B x2 U-100PZ2E8	S-60PT2E5B x2 U-125PZ2E8	S-71PT2E5B x2 U-140PZ2E8			
<b>K2</b>						S-100PK2E5B U-100PZ2E8		
			S-50PK2E5B x2 U-100PZ2E8	S-60PK2E5B x2 U-125PZ2E8	S-71PK2E5B x2 U-140PZ2E8			
<b>F1</b>						S-100PF1E5B U-100PZ2E8	S-125PF1E5B U-125PZ2E8	S-140PF1E5B U-140PZ2E8
			S-50PF1E5B x2 U-100PZ2E8	S-60PF1E5B x2 U-125PZ2E8	S-71PF1E5B x2 U-140PZ2E8			

# — CONTENTS —

<b>Section 1. SPECIFICATIONS</b> .....	<b>1-1-1-1</b>
1-1. Unit Specifications .....	1-1-1-2
1-2. Dimensional Data .....	1-2-1
1-3. Refrigerant Flow Diagram .....	1-3-1
1-4. Operating Range .....	1-4-1
1-5. Capacity Correction Graph According to Temperature Condition .....	1-5-1
1-6. Noise Criterion Curves .....	1-6-1
1-7. Indoor Fan Performance .....	1-7-1
1-8. Airflow Distance Chart .....	1-8-1
1-9. Fresh Air Intake .....	1-9-1
1-10. Electrical Wiring .....	1-10-1
1-11. Installation Instructions .....	1-11-1-1
■ Outdoor Unit .....	1-11-1-1
■ Indoor Unit .....	1-11-2-1
1-12. Capacity Table .....	1-12-1-1
1. Cooling Capacity Performance Data .....	1-12-1-1
2. Heating Capacity Performance Data .....	1-12-2-1
1-13. Product Fiche .....	1-13-1
1-14. Information Table.....	1-14-1
<b>Section 2. TEST RUN</b> .....	<b>2-1</b>
■ U-100PZ2E5, U-125PZ2E5, U-140PZ2E5, U-100PZ2E8, U-125PZ2E8, U-140PZ2E8	
2-1. PRECAUTIONS REGARDING TEST RUN .....	2-2
2-2. CHECKS AFTER INSTALLATION HAVE COMPLETED .....	2-3
2-3. REGARDING DELIVERY TO THE CUSTOMER .....	2-3
<b>Section 3. ELECTRICAL DATA</b> .....	<b>3-1</b>
3-1. Indoor Units (Electric Wiring Diagram) .....	3-2
3-2. Outdoor Units (Electric Wiring Diagram) .....	3-6

<b>Section 4. CONTROL FUNCTIONS .....</b>	<b>4-1</b>
4-1. Room Temperature Control .....	4-2
4-2. Heating Standby .....	4-4
4-3. Automatic Fan Speed Control .....	4-5
4-4. Drain Pump Control .....	4-6
4-5. Automatic Heating/Cooling Control .....	4-7
4-6. Automatic Flap Control .....	4-8
4-7. Filter Sign .....	4-8
4-8. Fan Control during Dry Mode .....	4-9
4-9. Ventilation Fan Output .....	4-9
4-10. T10 Terminal .....	4-9
4-11. Parameter .....	4-10
4-12. Control Functions .....	4-11
4-13. Outdoor Units Control PCB (CR-PCB, HIC-PCB) .....	4-17
4-14. Functions of Outdoor Unit PCB .....	4-23
4-15. Self-Diagnostics Function Table .....	4-26
<b>Section 5. TROUBLE DIAGNOSIS.....</b>	<b>5-1</b>
5-1. Contents of Remote Controller Switch Alarm Display .....	5-2
5-2. Outdoor Unit Control Panel LED Display .....	5-4
5-3. PAC System Alarm Codes .....	5-5
5-4. Inspection of Parts (Outdoor Unit).....	5-61
5-5. Symptom: Thermostat in OFF continues or cycles OFF & ON too frequently .....	5-62
5-6. How to Clean Heat Exchanger .....	5-63
5-7. How to Replace Fan Motor .....	5-64
<b>Section 6. OUTDOOR UNIT MAINTENANCE REMOTE CONTROLLER .....</b>	<b>6-1</b>
6-1. Overview .....	6-2
6-2. Functions .....	6-2
6-3. Normal Display Operations and Functions .....	6-3
6-4. Monitoring Operations: Display of Indoor Unit and Outdoor Unit Sensor Temperatures .....	6-8
6-5. Monitoring the Outdoor Unit Alarm History: Display of Outdoor Unit Alarm History .....	6-10
6-6. Settings Modes: Setting the Outdoor Unit EEPROM .....	6-11
<b>Section 7. REMOTE CONTROLLER FUNCTIONS SECTION .....</b>	<b>7-1</b>
7-1. Simple Settings Function .....	7-2
7-2. List of Simple Setting Items .....	7-4
7-3. Detailed Settings Function .....	7-5
7-4. List of Detailed Setting Items .....	7-7
7-5. Simple Setting Items .....	7-11
7-6. Detailed Setting Items .....	7-13
7-7. Remote Controller Servicing Functions .....	7-17
7-8. Test Run Function .....	7-19

**Section 8. HOW TO INSTALL THE WIRELESS REMOTE CONTROLLER RECEIVER ..... 8-1**

- Important Safety Instructions ..... 8-2
- Optional Controller (Remote Controller) ..... 8-3
- 8-1. Names and Functions ..... 8-3
- 8-2. Installing Batteries ..... 8-5
- 8-3. Setting the Current Time ..... 8-5
- 8-4. Operation ..... 8-6
- 8-5. Timer Operation ..... 8-7
- 8-6. Adjusting the Wind Direction ..... 8-8
- 8-7. Operating Multiple In/Outdoor Units Simultaneously (Group Control) ..... 8-8
- 8-8. Using the Remote Controller ..... 8-9
- 8-9. For Best Results ..... 8-9
- 8-10. Addresses ..... 8-9
- 8-11. Emergency Operation ..... 8-11
- 8-12. Miscellaneous Settings ..... 8-12
- 8-13. Before Requesting Service ..... 8-13
- How to Install the Wireless Remote Controller Receiver ..... 8-14
- 8-14. Common to All Models ..... 8-14
- 8-15. CZ-RWSU3 ..... 8-16
- 8-16. CZ-RWST3N ..... 8-18
- 8-17. CZ-RWSC3 ..... 8-20
- 8-18. Type K2 ..... 8-24
- 8-19. Common to All Models ..... 8-25

– MEMO –

# 1. SPECIFICATIONS

<b>1-1. Unit Specifications .....</b>	<b>1-1-1-2</b>
<b>PZ2</b>	
1. 4-Way Cassette Type (U2) .....	1-1-1-2
2. Ceiling Type (T2) .....	1-1-2-1
3. Wall Mounted Type (K2) .....	1-1-3-1
4. Low Silhouette Ducted Type (F1) .....	1-1-4-1
<b>1-2. Dimensional Data .....</b>	<b>1-2-1</b>
(A) Indoor Units .....	1-2-1
(B) Outdoor Units .....	1-2-8
<b>1-3. Refrigerant Flow Diagram .....</b>	<b>1-3-1</b>
<b>1-4. Operating Range .....</b>	<b>1-4-1</b>
<b>1-5. Capacity Correction Graph According to Temperature Condition .....</b>	<b>1-5-1</b>
<b>1-6. Noise Criterion Curves .....</b>	<b>1-6-1</b>
<b>1-7. Indoor Fan Performance .....</b>	<b>1-7-1</b>
<b>1-8. Airflow Distance Chart .....</b>	<b>1-8-1</b>
<b>1-9. Fresh Air Intake .....</b>	<b>1-9-1</b>
<b>1-10. Electrical Wiring .....</b>	<b>1-10-1</b>
<b>1-11. Installation Instructions .....</b>	<b>1-11-1-1</b>
<b>Outdoor Unit</b> .....	1-11-1-1
1. U-100PZ2E5, U-125PZ2E5, U-140PZ2E5, .....	1-11-1-1
U-100PZ2E8, U-125PZ2E8, U-140PZ2E8	
<b>Indoor Unit</b> .....	1-11-2-1
2. 4-Way Cassette Type (U2) .....	1-11-2-1
3. Ceiling Type (T2) .....	1-11-3-1
4. Wall Mounted Type (K2) .....	1-11-4-1
5. Low Silhouette Ducted Type (F1) .....	1-11-5-1
<b>1-12. Capacity Table .....</b>	<b>1-12-1-1</b>
1. Cooling Capacity Performance Data .....	1-12-1-1
2. Heating Capacity Performance Data .....	1-12-2-1
<b>1-13. Product Fiche .....</b>	<b>1-13-1</b>
<b>1-14. Information Table .....</b>	<b>1-14-1</b>

# Simultaneous (Twin) -Type

## 1-1. Unit Specifications

**PZ2**

### 1. 4-Way Cassette Type S-50PU2E5B×2 / U-100PZ2E5

INDOOR		MODEL	S-50PU2E5B×2			-			-		
PANEL		MODEL	Standard type:CZ-KPU3×2 / ECONAVI type:CZ-KPU3A×2			-			-		
OUTDOOR		MODEL	-			U-100PZ2E5			-		
Branch pipe		MODEL	-			-			-		
Performance test condition					ISO5151 / EN14511 / EN12102 / EN14825						
Power supply		Ø, Hz	1Ø 50Hz			1Ø 50Hz			Min	Max	
		V	220V	230V	240V	220V	230V	240V			
C O L I N G	Capacity	kW	10.0	10.0	10.0	-	-	-	3.0	11.5	
		BTU/h	34100	34100	34100	-	-	-	10200	39200	
	Current	A	0.27×2	0.26×2	0.25×2	12.3	11.7	11.2	-	-	
		W	29×2	29×2	29×2	2.562k	2.562k	2.562k	-	-	
	Input power	TOTAL W	-			2.620k	2.620k	2.620k	560	4.000k	
		Annual consumption	TOTAL kWh <sup>*4</sup>	-			-	1310	-	-	-
	EER/EER CLASS		TOTAL (W/W) <sup>15</sup> ("A"-G)	-	-	-	3.82	3.82/A	3.82	5.36	2.88
	Erp <sup>*6</sup>	Pdesign	kW	-	-	-	-	10.0	-	-	-
		SEER	(W/W)	-	-	-	-	6.8	-	-	-
		Annual consumption	kWh	-	-	-	-	515	-	-	-
		Class		-	-	-	-	A++	-	-	-
	Power factor	%	-	-	-	95	95	95	-	-	
	Noise indoor	dB-A (H/M/L) <sup>*7</sup>	32/29/27			-			-	-	
		Power Level dB	47/44/42			-			-	-	
Noise outdoor	dB-A (H/L)	-			52/-			-	-		
	Power Level dB	-			70/-			-	-		
H E A T I N G	Capacity	kW	10.0	10.0	10.0	-	-	-	3.0	14.0	
		BTU/h	34100	34100	34100	-	-	-	10200	47800	
	Current	A	0.26×2	0.25×2	0.24×2	9.45	9.05	8.65	-	-	
		W	27×2	27×2	27×2	1.976k	1.976k	1.976k	-	-	
	Input power	TOTAL W	-			2.030k	2.030k	2.030k	560	3.900k	
		COP/COP CLASS	TOTAL (W/W) <sup>15</sup> ("A"-G)	-	-	-	4.93	4.93/A	4.93	5.36	3.59
	Erp <sup>*6</sup>	Pdesign at -10°C	kW	-	-	-	-	10.0	-	-	-
		Tbivalent	°C	-	-	-	-	-10	-	-	-
		SCOP	(W/W)	-	-	-	-	4.4	-	-	-
		Annual consumption	kWh	-	-	-	-	3182	-	-	-
	Class	elbu(-10°C)	kW	-	-	-	-	0.00	-	-	-
				-	-	-	-	A+	-	-	-
	Power factor	%	-	-	-	95	95	95	-	-	
	Noise indoor	dB-A (H/M/L) <sup>*7</sup>	32/29/27			-			-	-	
Power Level dB		47/44/42			-			-	-		
Noise outdoor	dB-A (H/L)	-			52/-			-	-		
	Power Level dB	-			70/-			-	-		
EXTRA LOW TEMP Total capacity(kW) / Input power(W) / COP											
Max Current(A) / Max Input power(W)		0.27×2/29×2	0.26×2/29×2	0.25×2/29×2	25.0/5.25k	25.0/5.50k	25.0/5.70k	-			
Starting current(A) (Cooling/Heating)		-	-	-	12.3/9.45	11.7/9.05	11.2/8.65	-			
Comp output(W)		-			2.50k	2.50k	2.50k	-			
Network Impedance(ΩMAX.)		-			-			-			
Fan motor output (Indoor/Outdoor) W		60			120			-			
Moisture removal volume		L/h(Pt/h)	3.2	(1.6×2)	(6.8)	-			-		
External static pressure		Pa	-			-			-		
Indoor Air flow <sup>*7</sup>	Cooling	m³/min (ft³/min)	16.5×2/13.5×2/11.5×2 (583)×2/(477)×2/(406)×2			-			-	-	
	Heating	m³/min (ft³/min)	16.5×2/13.5×2/11.5×2 (583)×2/(477)×2/(406)×2			-			-	-	
Outdoor Air flow	Cooling	m³/min (ft³/min)	-			76.0 (2683)			-	-	
	Heating	m³/min (ft³/min)	-			70.0 (2472)			-	-	
Refrigerant type / amount g(oz)		-			R32	2.60k	(91.7)	-			
Product dimension	Height	mm(inch)	256 (10-5/64)			996 (39- 7/32)			-		
	Width	mm(inch)	840 (33-5/64)			980 (38-37/64)			-		
	Depth	mm(inch)	840 (33-5/64)			370 (14- 9/16)			-		
Product dimension (Panel)		H×W×D mm, inch	33.5×950×950 (1-11/32×37-13/32×37-13/32)			-			-		
Packing dimension	Height	mm(inch)	302 (11-57/64)			1134 (44-41/64)			-		
	Width	mm(inch)	898 (35-3/8)			1095 (43-7/64)			-		
	Depth	mm(inch)	898 (35-3/8)			529 (20-53/64)			-		
Weight	(NET)	kg(lb)	19 (42)			90 (199)			-		
	(GROSS)	kg(lb)	26 (57)			98 (216)			-		
	Panel (NET)	kg(lb)	5 (11)			-			-		
Layers limit (actually)		11 (12)			2 (3)			-			
Operation condition	Cool (DBT)	18°C ~ 32°C			-10°C ~ 43°C			-			
	Heat (DBT)	16°C ~ 30°C			-15°C ~ 24°C			-			
MAX WORKING PRESSURE HP/LP MPa (bar)		4.15/2.55 (41.5/25.5)			-			-			
P I P I N G	Pipe diameter mm (inch)	(Liquid)Ø6.35(1/4) (Gas)Ø12.7(1/2)			(Liquid)Ø9.52(3/8) (Gas)Ø15.88(5/8)			-			
	Connecting method, Standard length m(ft)	flared type, 5.0(16.4)			flared type, 5.0(16.4)			-			
Pipe length range m (ft)		5 ~ 50m (16.4 ~ 164.0)			-			-			
Indoor unit & Outdoor unit height difference m (ft)		15m(OD located lower)/30m(OD located higher) (49.2/98.4)			-			-			
Add gas amount g/m (oz/ft)		45g/m (0.484)			-			-			
Pipe length for additional gas m (ft)		30m (98.4)			-			-			

\*1 In case it is necessary to indicate the air flow volume in (l/s), the value in (m³/min.) shall be multiplied by 16.7 and rounded down the decimal point.

\*2 If the EUROVENT Certified models can be operated under the "extra-low" temperature condition, -7°C dry bulb and -8°C wet-bulb temperatures with rated voltage 230V shall be used.

\*3 Network Impedance shall be applicable for EUROPE and CHINA models.

\*4 The annual consumption is calculated by multiplying the input power at 230V(400V) by an average of 500 hours per year in cooling mode.

\*5 EER and COP classification is at 230V(400V) only in accordance with EU directive 2002/31/EC.

\*6 SEER and SCOP classification is at 230V(400V) only in accordance with EN-14825. For heating, SCOP indicates the value of only Average heating season, Other fiche data indicates in an attached sheet

\*7 H: High at setting 5 stage (Level 5), M: Middle at setting 5 stage (Level 3), L: Low at setting 5 stage (Level 1)



# Simultaneous (Twin) -Type

## 1-1. Unit Specifications

**PZ2**

### 1. 4-Way Cassette Type S-60PU2E5B×2 / U-125PZ2E5

INDOOR		MODEL	S-60PU2E5B ×2			-			-	
PANEL		MODEL	Standard type: CZ-KPU3×2 / ECONAVI type: CZ-KPU3A×2			-			-	
OUTDOOR		MODEL	-			U-125PZ2E5			-	
Branch pipe		MODEL	-			-			-	
Performance test condition					ISO5151 / EN14511 / EN12102 / EN14825					
Power supply		Ø, Hz	1Ø 50Hz			1Ø 50Hz				
		V	220V	230V	240V	220V	230V	240V	Min	Max
C O O L I N G	Capacity	kW	12.5	12.5	12.5	-	-	-	3.2	13.5
		BTU/h	42700	42700	42700	-	-	-	10900	46100
	Current	A	0.36×2	0.35×2	0.34×2	16.5	15.8	15.1	-	-
		W	38×2	38×2	38×2	3.414k	3.414k	3.414k	-	-
	Input power	TOTAL W	-			3.490k	3.490k	3.490k	600	4.800k
		TOTAL kWh <sup>*4</sup>	-			-	1745	-	-	-
	Annual consumption	TOTAL kWh <sup>*4</sup>	-			-	1745	-	-	-
	EER/EER CLASS	TOTAL (W/W) <sup>*5</sup> ("A"-°G)	-	-	-	3.58	3.58/A	3.58	5.33	2.81
	Erp <sup>*6</sup>	P <sub>design</sub>	kW	-	-	-	-	12.5	-	-
		η <sub>s,c</sub>	%	-	-	-	-	270.8	-	-
		Annual consumption	kWh	-	-	-	-	-	-	-
		Class		-	-	-	-	-	-	-
	Power factor	%	-	-	-	94	94	94	-	-
	Noise indoor	dB-A (H/M/L) <sup>*7</sup>	36/31/28			-			-	-
Power Level dB		51/46/43			-			-	-	
Noise outdoor	dB-A (H/L)	-			55/-			-	-	
	Power Level dB	-			73/-			-	-	
H E A T I N G	Capacity	kW	12.5	12.5	12.5	-	-	-	3.3	15.0
		BTU/h	42700	42700	42700	-	-	-	11300	51200
	Current	A	0.35×2	0.34×2	0.33×2	13.3	12.7	12.2	-	-
		W	36×2	36×2	36×2	2.748k	2.748k	2.748k	-	-
	Input power	TOTAL W	-			2.820k	2.820k	2.820k	600	4.200k
		TOTAL kWh <sup>*4</sup>	-			-	-	-	-	-
	COP/COP CLASS	TOTAL (W/W) <sup>*5</sup> ("A"-°G)	-	-	-	4.43	4.43/A	4.43	5.50	3.57
	Erp <sup>*6</sup>	P <sub>design</sub> at -10°C	kW	-	-	-	-	12.5	-	-
		T <sub>bivalent</sub>	°C	-	-	-	-	-10	-	-
		η <sub>s,h</sub>	%	-	-	-	-	157.4	-	-
		Annual consumption	kWh	-	-	-	-	-	-	-
	elbu(-10°C)	kW	-	-	-	-	0.00	-	-	-
		Class		-	-	-	-	-	-	-
	Power factor	%	-	-	-	94	94	94	-	-
Noise indoor	dB-A (H/M/L) <sup>*7</sup>	36/31/28			-			-	-	
	Power Level dB	51/46/43			-			-	-	
Noise outdoor	dB-A (H/L)	-			55/-			-	-	
	Power Level dB	-			73/-			-	-	
EXTRA LOW TEMP <sup>†</sup> Total capacity(kW) / Input power(W) / COP		-			-			-		
Max Current(A) / Max Input power(W)		0.36×2/38×2	0.35×2/38×2	0.34×2/38×2	29.0/6.00k	29.0/6.30k	29.0/6.60k	-		
Starting current(A) (Cooling/Heating)		-	-	-	16.5/13.3	15.8/12.7	15.1/12.2	-		
Comp output(W)		-			2.80k	2.80k	2.80k	-		
Network Impedance(ΩMAX.)		-			-			-		
Fan motor output (Indoor/Outdoor) W		60			120			-		
Moisture removal volume		L/h(Pt/h)	3.4	(1.7×2)	(7.2)	-			-	
External static pressure		Pa	-			-			-	
Indoor Air flow <sup>*7</sup>	Cooling	m <sup>3</sup> /min (ft <sup>3</sup> /min)	21.0×2/16.0×2/13.0×2 (742)×2/(565)×2/(459)×2			-			-	
	Heating	m <sup>3</sup> /min (ft <sup>3</sup> /min)	21.0×2/16.0×2/13.0×2 (742)×2/(565)×2/(459)×2			-			-	
Outdoor Air flow	Cooling	m <sup>3</sup> /min (ft <sup>3</sup> /min)	-			86.0 (3037)			-	
	Heating	m <sup>3</sup> /min (ft <sup>3</sup> /min)	-			78.0 (2754)			-	
Refrigerant type / amount g(oz)		-			R32	2.98k	(105.1)	-		
Product dimension	Height	mm(inch)	256 (10-5/64)			996 (39- 7/32)			-	
	Width	mm(inch)	840 (33-5/64)			980 (38-37/64)			-	
	Depth	mm(inch)	840 (33-5/64)			370 (14- 9/16)			-	
Product dimension (Panel)		H×W×D mm, inch	33.5×950×950 (1-11/32×37-13/32×37-13/32)			-			-	
Packing dimension	Height	mm(inch)	302 (11-57/64)			1134 (44-41/64)			-	
	Width	mm(inch)	898 (35-3/8)			1095 (43-7/64)			-	
	Depth	mm(inch)	898 (35-3/8)			529 (20-53/64)			-	
Weight	(NET)	kg(lb)	20 (44)			94 (207)			-	
	(GROSS)	kg(lb)	27 (60)			102 (224)			-	
	Panel (NET)	kg(lb)	5 (11)			-			-	
Layers limit (actually)		11 (12)			2 (3)			-		
Operation condition	Cool (DBT)	18°C ~ 32°C			-10°C ~ 43°C			-		
	Heat (DBT)	16°C ~ 30°C			-15°C ~ 24°C			-		
MAX WORKING PRESSURE HP/LP MPa (bar)		4.15/2.55 (41.5/25.5)			-			-		
P I	Pipe diameter mm (inch)	(Liquid)Ø9.52(3/8) (Gas)Ø15.88(5/8)			(Liquid)Ø9.52(3/8) (Gas)Ø15.88(5/8)			-		
	Connecting method, Standard length m(ft)	flared type, 5.0(16.4)			flared type, 5.0(16.4)			-		
P I	Pipe length range m (ft)	5 ~ 50m (16.4 ~ 164.0)			-			-		
N I	Indoor unit & Outdoor unit height difference m (ft)	15m(OD located lower)/30m(OD located higher) (49.2/98.4)			-			-		
N I	Add gas amount g/m (oz/ft)	45g/m (0.484)			-			-		
N I	Pipe length for additional gas m (ft)	30m (98.4)			-			-		

\*1 In case it is necessary to indicate the air flow volume in (l/s), the value in (m<sup>3</sup>/min.) shall be multiplied by 16.7 and rounded down the decimal point.  
 \*2 If the EUROVENT Certified models can be operated under the "extra-low" temperature condition, -7°C dry bulb and -8°C wet-bulb temperatures with rated voltage 230V shall be used.  
 \*3 Network Impedance shall be applicable for EUROPE and CHINA models.  
 \*4 The annual consumption is calculated by multiplying the input power at 230V(400V) by an average of 500 hours per year in cooling mode.  
 \*5 EER and COP classification is at 230V(400V) only in accordance with EU directive 2002/31/EC.  
 \*6 η<sub>s,c</sub> and η<sub>s,h</sub> classification is at 230V(400V) only in accordance with EN-14825. For heating, η<sub>s,h</sub> indicates the value of only Average heating season.  
 \*7 H: High at setting 5 stage (Level 5), M: Middle at setting 5 stage (Level 3), L: Low at setting 5 stage (Level 1)

# 1 Simultaneous (Twin) -Type

## 1-1. Unit Specifications

**PZ2**

### 1. 4-Way Cassette Type S-71PU2E5B×2 / U-140PZ2E5

INDOOR		MODEL	S-71PU2E5B ×2			-			-		
PANEL		MODEL	Standard type: CZ-KPU3×2 / ECONAVI type: CZ-KPU3A×2			-			-		
OUTDOOR		MODEL	-			U-140PZ2E5			-		
Branch pipe		MODEL	-			-			-		
Performance test condition					ISO5151 / EN14511 / EN12102 / EN14825						
Power supply		Ø, Hz	1Ø 50Hz			1Ø 50Hz			Min	Max	
		V	220V	230V	240V	220V	230V	240V			
C O O L I N G	Capacity	kW	14.0	14.0	14.0	-	-	-	3.3	15.0	
		BTU/h	47800	47800	47800	-	-	-	11300	51200	
	Current	A	0.40×2	0.39×2	0.38×2	20.6	19.7	18.9	-	-	
		W	42×2	42×2	42×2	4.256k	4.256k	4.256k	-	-	
	Input power	TOTAL W	-			4.340k	4.340k	4.340k	620	5.500k	
		Annual consumption	TOTAL kWh *4	-			-	2170	-	-	-
	EER/EER CLASS	TOTAL (W/W) *5 / ("A"-°G)	-	-	-	3.23	3.23/A	3.23	5.32	2.73	
	Erp *6	Pdesign	kW	-	-	-	-	14.0	-	-	-
		η <sub>s.c</sub>	%	-	-	-	-	260.3	-	-	-
		Annual consumption	kWh	-	-	-	-	-	-	-	-
		Class		-	-	-	-	-	-	-	-
	Power factor	%	-	-	-	94	94	94	-	-	
	Noise indoor	dB-A (H/M/L) *7	37/31/28			-			-	-	
		Power Level dB	52/46/43			-			-	-	
Noise outdoor	dB-A (H/L)	-			56/-			-	-		
	Power Level dB	-			74/-			-	-		
H E A T I N G	Capacity	kW	14.0	14.0	14.0	-	-	-	3.4	16.0	
		BTU/h	47800	47800	47800	-	-	-	11600	54600	
	Current	A	0.39×2	0.38×2	0.37×2	15.8	15.1	14.5	-	-	
		W	40×2	40×2	40×2	3.270k	3.270k	3.270k	-	-	
	Input power	TOTAL W	-			3.350k	3.350k	3.350k	620	4.800k	
		COP/COP CLASS	TOTAL (W/W) *5 / ("A"-°G)	-	-	-	4.18	4.18/A	4.18	5.48	3.33
	Erp *6	Pdesign at -10°C	kW	-	-	-	-	14.0	-	-	-
		Tbivalent	°C	-	-	-	-	-7	-	-	-
		η <sub>s.h</sub>	%	-	-	-	-	152.5	-	-	-
		Annual consumption	kWh	-	-	-	-	-	-	-	-
		elbu(-10°C)	kW	-	-	-	-	3.30	-	-	-
	Class		-	-	-	-	-	-	-	-	
	Power factor	%	-	-	-	94	94	94	-	-	
	Noise indoor	dB-A (H/M/L) *7	37/31/28			-			-	-	
Power Level dB		52/46/43			-			-	-		
Noise outdoor	dB-A (H/L)	-			56/-			-	-		
	Power Level dB	-			74/-			-	-		
EXTRA LOW TEMP Total capacity(kW) / Input power(W) / COP											
Max Current(A) / Max Input power(W)		0.40×2/42×2	0.39×2/42×2	0.38×2/42×2	30.0/6.25k	30.0/6.50k	30.0/6.80k				
Starting current(A) (Cooling/Heating)		-	-	-	20.6/15.8	19.7/15.1	18.9/14.5				
Comp output(W)						3.00k	3.00k	3.00k			
Network Impedance(ΩMAX.)											
Fan motor output (Indoor/Outdoor) W				60		120					
Moisture removal volume		L/h(Pt/h)	5.0	(2.5×2)	(10.6)						
External static pressure		Pa									
Indoor Air flow *7	Cooling	m³/min (ft³/min)	22.0×2/16.0×2/13.0×2 (777)×2/(565)×2/(459)×2						-	-	
	Heating	m³/min (ft³/min)	22.0×2/16.0×2/13.0×2 (777)×2/(565)×2/(459)×2						-	-	
Outdoor Air flow	Cooling	m³/min (ft³/min)	-			89.0 (3143)			-	-	
	Heating	m³/min (ft³/min)	-			83.0 (2931)			-	-	
Refrigerant type / amount g(oz)						R32	2.98k	(105.1)			
Product dimension	Height	mm(inch)	256 (10-5/64)			996 (39- 7/32)					
	Width	mm(inch)	840 (33-5/64)			980 (38-37/64)					
	Depth	mm(inch)	840 (33-5/64)			370 (14- 9/16)					
Product dimension (Panel)		H×W×D mm, inch	33.5×950×950 (1-11/32×37-13/32×37-13/32)								
Packing dimension	Height	mm(inch)	302 (11-57/64)			1134 (44-41/64)					
	Width	mm(inch)	898 (35-3/8)			1095 (43-7/64)					
	Depth	mm(inch)	898 (35-3/8)			529 (20-53/64)					
Weight	(NET)	kg(lb)	20 (44)			94 (207)					
	(GROSS)	kg(lb)	27 (60)			102 (224)					
	Panel (NET)	kg(lb)	5 (11)								
Layers limit (actually)				11 (12)		2 (3)					
Operation condition	Cool (DBT)	18°C ~ 32°C			-10°C ~ 43°C						
	Heat (DBT)	16°C ~ 30°C			-15°C ~ 24°C						
MAX WORKING PRESSURE HP/LP MPa (bar)						4.15/2.55 (41.5/25.5)					
P I	Pipe diameter mm (inch)	(Liquid)Ø9.52(3/8) (Gas)Ø15.88(5/8)			(Liquid)Ø9.52(3/8) (Gas)Ø15.88(5/8)						
	Connecting method, Standard length m(ft)	flared type, 5.0(16.4)			flared type, 5.0(16.4)						
P I	Pipe length range m (ft)			5 ~ 50m (16.4 ~ 164.0)							
N G	Indoor unit & Outdoor unit height difference m (ft)	15m(OD located lower)/30m(OD located higher) (49.2/98.4)									
	Add gas amount g/m (oz/ft)				45g/m (0.484)						
N G	Pipe length for additional gas m (ft)			30m (98.4)							

\*1 In case it is necessary to indicate the air flow volume in (l/s), the value in (m³/min.) shall be multiplied by 16.7 and rounded down the decimal point.

\*2 If the EUROVENT Certified models can be operated under the "extra-low" temperature condition, -7°C dry bulb and -8°C wet-bulb temperatures with rated voltage 230V shall be used.

\*3 Network Impedance shall be applicable for EUROPE and CHINA models.

\*4 The annual consumption is calculated by multiplying the input power at 230V(400V) by an average of 500 hours per year in cooling mode.

\*5 EER and COP classification is at 230V(400V) only in accordance with EU directive 2002/31/EC.

\*6 η<sub>s.c</sub> and η<sub>s.h</sub> classification is at 230V(400V) only in accordance with EN-14825. For heating, η<sub>s.h</sub> indicates the value of only Average heating season.

\*7 H: High at setting 5 stage (Level 5), M: Middle at setting 5 stage (Level 3), L: Low at setting 5 stage (Level 1)

# Single-Type

## 1-1. Unit Specifications

**PZ2**

### 1. 4-Way Cassette Type S-100PU2E5B / U-100PZ2E5

INDOOR		MODEL	S-100PU2E5B			-			-		
PANEL		MODEL	Standard type: CZ-KPU3 / ECONAVI type: CZ-KPU3A			-			-		
OUTDOOR		MODEL	-			U-100PZ2E5			-		
Branch pipe		MODEL	-			-			-		
Performance test condition					ISO5151 / EN14511 / EN12102 / EN14825						
Power supply		Ø, Hz	1Ø 50Hz			1Ø 50Hz			Min	Max	
		V	220V	230V	240V	220V	230V	240V			
C O O L I N G	Capacity	kW	10.0	10.0	10.0	-	-	-	3.0	11.5	
		BTU/h	34100	34100	34100	-	-	-	10200	39200	
	Current	A	0.82	0.79	0.76	12.1	11.5	11.1	-	-	
		W	100	100	100	2.520k	2.520k	2.520k	-	-	
	Input power	TOTAL W	-	-	-	2.620k	2.620k	2.620k	560	4.000k	
		Annual consumption	TOTAL kWh**	-	-	-	-	1310	-	-	-
	EER/EER CLASS	TOTAL (W/W) <sup>1)</sup> ("A"~"G")	-	-	-	3.82	3.82/A	3.82	5.36	2.88	
	Erp <sup>5)</sup>	Pdesign	kW	-	-	-	-	10.0	-	-	-
		SEER	(W/W)	-	-	-	-	6.8	-	-	-
		Annual consumption	kWh	-	-	-	-	515	-	-	-
		Class		-	-	-	-	A++	-	-	-
	Power factor	%	-	-	-	95	95	95	-	-	
	Noise indoor	dB-A (H/M/L) <sup>7)</sup>	45/38/32			-			-	-	
		Power Level dB	60/53/47			-			-	-	
Noise outdoor	dB-A (H/L)	-			52/-			-	-		
	Power Level dB	-			70/-			-	-		
H E A T I N G	Capacity	kW	10.0	10.0	10.0	-	-	-	3.0	14.0	
		BTU/h	34100	34100	34100	-	-	-	10200	47800	
	Current	A	0.81	0.78	0.75	9.25	8.85	8.50	-	-	
		W	95	95	95	1.935k	1.935k	1.935k	-	-	
	Input power	TOTAL W	-	-	-	2.030k	2.030k	2.030k	560	3.900k	
		COP/COP CLASS	TOTAL (W/W) <sup>1)</sup> ("A"~"G")	-	-	-	4.93	4.93/A	4.93	5.36	3.59
	Erp <sup>5)</sup>	Pdesign at -10°C	kW	-	-	-	-	10.0	-	-	-
		Tbivalent	°C	-	-	-	-	-10	-	-	-
		SCOP	(W/W)	-	-	-	-	4.4	-	-	-
		Annual consumption	kWh	-	-	-	-	3182	-	-	-
	Class	elbu(-10°C)	kW	-	-	-	-	0.00	-	-	-
				-	-	-	-	A+	-	-	-
	Power factor	%	-	-	-	95	95	95	-	-	
	Noise indoor	dB-A (H/M/L) <sup>7)</sup>	45/38/32			-			-	-	
Power Level dB		60/53/47			-			-	-		
Noise outdoor	dB-A (H/L)	-			52/-			-	-		
	Power Level dB	-			70/-			-	-		
EXTRA LOW TEMP Total capacity(kW) / Input power(W) / COP											
Max Current(A) / Max Input power(W)		0.82/100	0.79/100	0.76/100	25.0/5.25k	25.0/5.50k	25.0/5.70k				
Starting current(A) (Cooling/Heating)		-	-	-	12.1/9.25	11.5/8.85	11.1/8.50				
Comp output(W)						2.50k	2.50k	2.50k			
Network Impedance(ΩMAX.)											
Fan motor output (Indoor/Outdoor) W				90			120				
Moisture removal volume		L/h(Pt/h)		2.7	(5.7)						
External static pressure		Pa									
Indoor Air flow <sup>7)</sup>	Cooling	m³/min (ft³/min)		36.0/26.0/18.0 (1271)/(918)/(636)							
	Heating	m³/min (ft³/min)		36.0/26.0/18.0 (1271)/(918)/(636)							
Outdoor Air flow	Cooling	m³/min (ft³/min)				76.0 (2683)					
	Heating	m³/min (ft³/min)				70.0 (2472)					
Refrigerant type / amount g(oz)						R32	2.60k	(91.7)			
Product dimension	Height	mm(inch)		319 (12-9/16)		996 (39- 7/32)					
	Width	mm(inch)		840 (33-5/64)		980 (38-37/64)					
	Depth	mm(inch)		840 (33-5/64)		370 (14- 9/16)					
Product dimension (Panel)		H×W×D mm, inch		33.5×950×950 (1-11/32×37-13/32×37-13/32)							
Packing dimension	Height	mm(inch)		365 (14-3/8)		1134 (44-41/64)					
	Width	mm(inch)		898 (35-3/8)		1095 (43-7/64)					
	Depth	mm(inch)		898 (35-3/8)		529 (20-53/64)					
Weight	(NET)	kg(lb)		25 (55)		90 (199)					
	(GROSS)	kg(lb)		32 (71)		98 (216)					
	Panel (NET)	kg(lb)		5 (11)							
Layers limit (actually)				11 (12)		2 (3)					
Operation condition	Cool (DBT)			18°C ~ 32°C		-10°C ~ 43°C					
	Heat (DBT)			16°C ~ 30°C		-15°C ~ 24°C					
MAX WORKING PRESSURE HP/LP MPa (bar)						4.15/2.55 (41.5/25.5)					
P I	Pipe diameter mm (inch)			(Liquid)Ø9.52(3/8) (Gas)Ø15.88(5/8)		(Liquid)Ø9.52(3/8) (Gas)Ø15.88(5/8)					
	Connecting method, Standard length m(ft)			flared type, 5.0(16.4)		flared type, 5.0(16.4)					
P I	Pipe length range m (ft)			5 ~ 50m (16.4 ~ 164.0)							
N G	Indoor unit & Outdoor unit height difference m (ft)			15m(OD located lower)/30m(OD located higher) (49.2/98.4)							
	Add gas amount g/m (oz/ft)			45g/m (0.484)							
N G	Pipe length for additional gas m (ft)			30m (98.4)							

\*1 In case it is necessary to indicate the air flow volume in (l/s), the value in (m³/min.) shall be multiplied by 16.7 and rounded down the decimal point.  
 \*2 If the EUROVENT Certified models can be operated under the "extra-low" temperature condition, -7°C dry bulb and -8°C wet-bulb temperatures with rated voltage 230V shall be used.  
 \*3 Network Impedance shall be applicable for EUROPE and CHINA models.  
 \*4 The annual consumption is calculated by multiplying the input power at 230V(400V) by an average of 500 hours per year in cooling mode.  
 \*5 EER and COP classification is at 230V(400V) only in accordance with EU directive 2002/31/EC.  
 \*6 SEER and SCOP classification is at 230V(400V) only in accordance with EN-14825. For heating, SCOP indicates the value of only Average heating season, Other fiche data indicates in an attached sheet  
 \*7 H: High at setting 5 stage (Level 5), M: Middle at setting 5 stage (Level 3), L: Low at setting 5 stage (Level 1)

# Single-Type

## 1-1. Unit Specifications

**PZ2**

### 1. 4-Way Cassette Type S-125PU2E5B / U-125PZ2E5

INDOOR		MODEL	S-125PU2E5B								
PANEL		MODEL	Standard type: CZ-KPU3 / ECONAVI type: CZ-KPU3A								
OUTDOOR		MODEL				U-125PZ2E5					
Branch pipe		MODEL									
Performance test condition					ISO5151 / EN14511 / EN12102 / EN14825						
Power supply		Ø, Hz	1Ø 50Hz			1Ø 50Hz			Min	Max	
		V	220V	230V	240V	220V	230V	240V			
C O O L I N G	Capacity	kW	12.5	12.5	12.5	-	-	-	3.2	13.5	
		BTU/h	42700	42700	42700	-	-	-	10900	46100	
	Current	A	0.91	0.88	0.85	16.3	15.6	15.0	-	-	
		W	110	110	110	3.380k	3.380k	3.380k	-	-	
	Input power	TOTAL W	-	-	-	3.490k	3.490k	3.490k	600	4.800k	
		Annual consumption	TOTAL kWh <sup>*4</sup>	-	-	-	-	1745	-	-	-
	EER/EER CLASS	TOTAL (W/W) <sup>*5</sup> ("A"-*G")	-	-	-	3.58	3.58/A	3.58	5.33	2.81	
	Erp <sup>*6</sup>	Pdesign	kW	-	-	-	-	12.5	-	-	-
		η <sub>s.c</sub>	%	-	-	-	-	267.1	-	-	-
		Annual consumption	kWh	-	-	-	-	-	-	-	-
Class			-	-	-	-	-	-	-	-	
Power factor	%	-	-	-	94	94	94	-	-		
Noise indoor	dB-A (H/M/L) <sup>*7</sup>	46/39/33						-	-		
	Power Level dB	61/54/48						-	-		
Noise outdoor	dB-A (H/L)				55/-			-	-		
	Power Level dB				73/-			-	-		
H E A T I N G	Capacity	kW	12.5	12.5	12.5	-	-	-	3.3	15.0	
		BTU/h	42700	42700	42700	-	-	-	11300	51200	
	Current	A	0.90	0.87	0.84	13.1	12.6	12.0	-	-	
		W	105	105	105	2.715k	2.715k	2.715k	-	-	
	Input power	TOTAL W	-	-	-	2.820k	2.820k	2.820k	600	4.200k	
		COP/COP CLASS	TOTAL (W/W) <sup>*5</sup> ("A"-*G")	-	-	-	4.43	4.43/A	4.43	5.50	3.57
	Erp <sup>*6</sup>	Pdesign at -10°C	kW	-	-	-	-	12.5	-	-	-
		Tbivalent	°C	-	-	-	-	-10	-	-	-
		η <sub>s.h</sub>	%	-	-	-	-	157.3	-	-	-
		Annual consumption elbu(-10°C)	kWh	-	-	-	-	-	-	-	-
Class		-	-	-	-	-	-	-	-		
Power factor	%	-	-	-	94	94	94	-	-		
Noise indoor	dB-A (H/M/L) <sup>*7</sup>	46/39/33						-	-		
	Power Level dB	61/54/48						-	-		
Noise outdoor	dB-A (H/L)				55/-			-	-		
	Power Level dB				73/-			-	-		
EXTRA LOW TEMP Total capacity(kW) / Input power(W) / COP											
Max Current(A) / Max Input power(W)		0.91/110	0.88/110	0.85/110	29.0/6.00k	29.0/6.30k	29.0/6.60k				
Starting current(A) (Cooling/Heating)		-	-	-	16.3/13.1	15.6/12.6	15.0/12.0				
Comp output(W)						2.80k	2.80k	2.80k			
Network Impedance(ΩMAX.)											
Fan motor output (Indoor/Outdoor) W				90		120					
Moisture removal volume		L/h(Pt/h)		4.8 (10.1)							
External static pressure		Pa									
Indoor Air flow <sup>*7</sup>	Cooling	m³/min (ft³/min)		37.0/27.0/19.0 (1307)/(953)/(671)							
	Heating	m³/min (ft³/min)		37.0/27.0/19.0 (1307)/(953)/(671)							
Outdoor Air flow	Cooling	m³/min (ft³/min)				86.0 (3037)					
	Heating	m³/min (ft³/min)				78.0 (2754)					
Refrigerant type / amount g(oz)						R32 2.98k (105.1)					
Product dimension	Height	mm(inch)		319 (12-9/16)		996 (39- 7/32)					
	Width	mm(inch)		840 (33-5/64)		980 (38-37/64)					
	Depth	mm(inch)		840 (33-5/64)		370 (14- 9/16)					
Product dimension (Panel)		H×W×D mm, inch		33.5×950×950 (1-11/32×37-13/32×37-13/32)							
Packing dimension	Height	mm(inch)		365 (14-3/8)		1134 (44-41/64)					
	Width	mm(inch)		898 (35-3/8)		1095 (43-7/64)					
	Depth	mm(inch)		898 (35-3/8)		529 (20-53/64)					
Weight	(NET)	kg(lb)		25 (55)		94 (207)					
	(GROSS)	kg(lb)		32 (71)		102 (224)					
	Panel (NET)	kg(lb)		5 (11)							
Layers limit (actually)				11 (12)		2 (3)					
Operation condition	Cool (DBT)			18°C ~ 32°C		-10°C ~ 43°C					
	Heat (DBT)			16°C ~ 30°C		-15°C ~ 24°C					
MAX WORKING PRESSURE HP/LP MPa (bar)						4.15/2.55 (41.5/25.5)					
P I	Pipe diameter mm (inch)	(Liquid)Ø9.52(3/8) (Gas)Ø15.88(5/8)			(Liquid)Ø9.52(3/8) (Gas)Ø15.88(5/8)						
	Connecting method, Standard length m(ft)	flared type, 5.0(16.4)			flared type, 5.0(16.4)						
P I	Pipe length range m (ft)			5 ~ 50m (16.4 ~ 164.0)							
	Indoor unit & Outdoor unit height difference m (ft)			15m(OD located lower)/30m(OD located higher) (49.2/98.4)							
N G	Add gas amount g/m (oz/ft)			45g/m (0.484)							
	Pipe length for additional gas m (ft)			30m (98.4)							

\*1 In case it is necessary to indicate the air flow volume in (l/s), the value in (m³/min.) shall be multiplied by 16.7 and rounded down the decimal point.  
 \*2 If the EUROVENT Certified models can be operated under the "extra-low" temperature condition, -7°C dry bulb and -8°C wet-bulb temperatures with rated voltage 230V shall be used.  
 \*3 Network Impedance shall be applicable for EUROPE and CHINA models.  
 \*4 The annual consumption is calculated by multiplying the input power at 230V(400V) by an average of 500 hours per year in cooling mode.  
 \*5 EER and COP classification is at 230V(400V) only in accordance with EU directive 2002/31/EC.  
 \*6 η<sub>s.c</sub> and η<sub>s.h</sub> classification is at 230V(400V) only in accordance with EN-14825. For heating, η<sub>s.h</sub> indicates the value of only Average heating season.  
 \*7 H: High at setting 5 stage (Level 5), M: Middle at setting 5 stage (Level 3), L: Low at setting 5 stage (Level 1)

# Single-Type

## 1-1. Unit Specifications

PZ2

### 1. 4-Way Cassette Type S-140PU2E5B / U-140PZ2E5

INDOOR		MODEL	S-140PU2E5B			-			-		
PANEL		MODEL	Standard type: CZ-KPU3 / ECONAVI type: CZ-KPU3A			-			-		
OUTDOOR		MODEL	-			U-140PZ2E5			-		
Branch pipe		MODEL	-			-			-		
Performance test condition					ISO5151 / EN14511 / EN12102 / EN14825						
Power supply		Ø, Hz	1Ø 50Hz			1Ø 50Hz			Min	Max	
		V	220V	230V	240V	220V	230V	240V			
C O O L I N G	Capacity	kW	14.0	14.0	14.0	-	-	-	3.3	15.0	
		BTU/h	47800	47800	47800	-	-	-	11300	51200	
	Current	A	0.97	0.94	0.91	20.4	19.5	18.7	-	-	
		W	120	120	120	4.220k	4.220k	4.220k	-	-	
	Input power	TOTAL W	-			4.340k	4.340k	4.340k	620	5.500k	
		Annual consumption	TOTAL kWh**	-			-	2170	-	-	-
	EER/EER CLASS	TOTAL (W/W) <sup>1)</sup> ("A"~"G")	-			3.23	3.23/A	3.23	5.32	2.73	
	Erp <sup>4)</sup>	Pdesign	kW	-	-	-	-	14.0	-	-	-
		η <sub>s.c</sub>	%	-	-	-	-	257.3	-	-	-
		Annual consumption	kWh	-	-	-	-	-	-	-	-
		Class		-	-	-	-	-	-	-	-
	Power factor	%	-	-	-	94	94	94	-	-	
	Noise indoor	dB-A (H/M/L) <sup>7)</sup>	47/40/34			-			-	-	
Power Level dB		62/55/49			-			-	-		
Noise outdoor	dB-A (H/L)	-			56/-			-	-		
	Power Level dB	-			74/-			-	-		
H E A T I N G	Capacity	kW	14.0	14.0	14.0	-	-	-	3.4	16.0	
		BTU/h	47800	47800	47800	-	-	-	11600	54600	
	Current	A	0.96	0.93	0.90	15.6	15.0	14.3	-	-	
		W	115	115	115	3.235k	3.235k	3.235k	-	-	
	Input power	TOTAL W	-			3.350k	3.350k	3.350k	620	4.800k	
		COP/COP CLASS	TOTAL (W/W) <sup>1)</sup> ("A"~"G")	-	-	-	4.18	4.18/A	4.18	5.48	3.33
	Erp <sup>4)</sup>	Pdesign at -10°C	kW	-	-	-	-	14.0	-	-	-
		Tbivalent	°C	-	-	-	-	-7	-	-	-
		η <sub>s.h</sub>	%	-	-	-	-	152.4	-	-	-
		Annual consumption	kWh	-	-	-	-	-	-	-	-
		elbu(-10°C)	kW	-	-	-	-	3.10	-	-	-
	Class		-	-	-	-	-	-	-	-	
	Power factor	%	-	-	-	94	94	94	-	-	
Noise indoor	dB-A (H/M/L) <sup>7)</sup>	47/40/34			-			-	-		
	Power Level dB	62/55/49			-			-	-		
Noise outdoor	dB-A (H/L)	-			56/-			-	-		
	Power Level dB	-			74/-			-	-		
EXTRA LOW TEMP <sup>2)</sup> Total capacity(kW) / Input power(W) / COP											
Max Current(A) / Max Input power(W)		0.97/120	0.94/120	0.91/120	30.0/6.25k	30.0/6.50k	30.0/6.80k				
Starting current(A) (Cooling/Heating)		-	-	-	20.4/15.6	19.5/15.0	18.7/14.3				
Comp output(W)		-			3.00k	3.00k	3.00k				
Network Impedance(ΩMAX.)		-			-						
Fan motor output (Indoor/Outdoor) W		90			120						
Moisture removal volume		L/h(Pt/h)	6.0 (12.6)			-					
External static pressure		Pa	-			-					
Indoor Air flow <sup>7)</sup>	Cooling	m <sup>3</sup> /min (ft <sup>3</sup> /min)	38.0/29.0/20.0 (1342)/(1024)/(706)			-			-	-	
	Heating	m <sup>3</sup> /min (ft <sup>3</sup> /min)	38.0/29.0/20.0 (1342)/(1024)/(706)			-			-	-	
Outdoor Air flow	Cooling	m <sup>3</sup> /min (ft <sup>3</sup> /min)	-			89.0 (3143)			-	-	
	Heating	m <sup>3</sup> /min (ft <sup>3</sup> /min)	-			83.0 (2931)			-	-	
Refrigerant type / amount g(oz)						R32	2.98k	(105.1)	-		
Product dimension	Height	mm(inch)	319 (12-9/16)			996 (39- 7/32)					
	Width	mm(inch)	840 (33-5/64)			980 (38-37/64)					
	Depth	mm(inch)	840 (33-5/64)			370 (14- 9/16)					
Product dimension (Panel)		H×W×D mm, inch	33.5×950×950 (1-11/32×37-13/32×37-13/32)			-					
Packing dimension	Height	mm(inch)	365 (14-3/8)			1134 (44-41/64)					
	Width	mm(inch)	898 (35-3/8)			1095 (43-7/64)					
	Depth	mm(inch)	898 (35-3/8)			529 (20-53/64)					
Weight	(NET)	kg(lb)	25 (55)			94 (207)					
	(GROSS)	kg(lb)	32 (71)			102 (224)					
	Panel (NET)	kg(lb)	5 (11)			-					
Layers limit (actually)		11 (12)			2 (3)						
Operation condition	Cool (DBT)	18°C ~ 32°C			-10°C ~ 43°C						
	Heat (DBT)	16°C ~ 30°C			-15°C ~ 24°C						
MAX WORKING PRESSURE HP/LP MPa (bar)						4.15/2.55 (41.5/25.5)					
P I	Pipe diameter mm (inch)	(Liquid)Ø9.52(3/8) (Gas)Ø15.88(5/8)			(Liquid)Ø9.52(3/8) (Gas)Ø15.88(5/8)						
	Connecting method, Standard length m(ft)	flared type, 5.0(16.4)			flared type, 5.0(16.4)						
P I	Pipe length range m (ft)	5 ~ 50m (16.4 ~ 164.0)									
	Indoor unit & Outdoor unit height difference m (ft)	15m(OD located lower)/30m(OD located higher) (49.2/98.4)									
N G	Add gas amount g/m (oz/ft)	45g/m (0.484)									
	Pipe length for additional gas m (ft)	30m (98.4)									

\*1 In case it is necessary to indicate the air flow volume in (l/s), the value in (m<sup>3</sup>/min.) shall be multiplied by 16.7 and rounded down the decimal point.  
\*2 If the EUROVENT Certified models can be operated under the "extra-low" temperature condition, -7°C dry bulb and -8°C wet-bulb temperatures with rated voltage 230V shall be used.  
\*3 Network Impedance shall be applicable for EUROPE and CHINA models.  
\*4 The annual consumption is calculated by multiplying the input power at 230V(400V) by an average of 500 hours per year in cooling mode.  
\*5 EER and COP classification is at 230V(400V) only in accordance with EU directive 2002/31/EC.  
\*6 η<sub>s.c</sub> and η<sub>s.h</sub> classification is at 230V(400V) only in accordance with EN-14825. For heating, η<sub>s.h</sub> indicates the value of only Average heating season.  
\*7 H: High at setting 5 stage (Level 5), M: Middle at setting 5 stage (Level 3), L: Low at setting 5 stage (Level 1)

# Simultaneous (Twin) -Type

## 1-1. Unit Specifications

**PZ2**

### 1. 4-Way Cassette Type S-50PU2E5B×2 / U-100PZ2E8

INDOOR		MODEL	S-50PU2E5B ×2								
PANEL		MODEL	Standard type: CZ-KPU3×2 / ECONAVI type: CZ-KPU3A×2								
OUTDOOR		MODEL				U-100PZ2E8					
Branch pipe		MODEL									
Performance test condition					ISO5151 / EN14511 / EN12102 / EN14825						
Power supply		Ø, Hz	1Ø 50Hz			3Ø 50Hz			Min	Max	
		V	220V	230V	240V	380V	400V	415V			
C O O L I N G	Capacity	kW	10.0	10.0	10.0	-	-	-	3.0	11.5	
		BTU/h	34100	34100	34100	-	-	-	10200	39200	
	Current	A	0.27×2	0.26×2	0.25×2	4.20	3.95	3.85	-	-	
		W	29×2	29×2	29×2	2.562k	2.562k	2.562k	-	-	
	Input power	TOTAL W				2.620k	2.620k	2.620k	560	4.000k	
		Annual consumption	TOTAL kWh <sup>*4</sup>				-	1310	-	-	-
	EER/EER CLASS		TOTAL (W/W) <sup>15</sup> ("A"-G)	-	-	-	3.82	3.82/A	3.82	5.36	2.88
	Erp <sup>*6</sup>	Pdesign	kW	-	-	-	-	10.0	-	-	-
		SEER	(W/W)	-	-	-	-	6.7	-	-	-
		Annual consumption	kWh	-	-	-	-	521	-	-	-
		Class		-	-	-	-	A++	-	-	-
	Power factor		%	-	-	-	93	93	93	-	-
	Noise indoor	dB-A (H/M/L) <sup>*7</sup>	32/29/27						-	-	-
		Power Level dB	47/44/42						-	-	-
	Noise outdoor	dB-A (H/L)				52/-			-	-	-
		Power Level dB				70/-			-	-	-
H E A T I N G	Capacity	kW	10.0	10.0	10.0	-	-	-	3.0	14.0	
		BTU/h	34100	34100	34100	-	-	-	10200	47800	
	Current	A	0.26×2	0.25×2	0.24×2	3.20	3.05	2.95	-	-	
		W	27×2	27×2	27×2	1.976k	1.976k	1.976k	-	-	
	Input power	TOTAL W				2.030k	2.030k	2.030k	560	3.900k	
		COP/COP CLASS	TOTAL (W/W) <sup>15</sup> ("A"-G)	-	-	-	4.93	4.93/A	4.93	5.36	3.59
	Erp <sup>*6</sup>	Pdesign at -10°C	kW	-	-	-	-	10.0	-	-	-
		Tbivalent	°C	-	-	-	-	-10	-	-	-
		SCOP	(W/W)	-	-	-	-	4.4	-	-	-
		Annual consumption	kWh	-	-	-	-	3182	-	-	-
	Class	elbu(-10°C)	kW	-	-	-	-	0.00	-	-	-
				-	-	-	-	A+	-	-	-
	Power factor		%	-	-	-	93	93	93	-	-
	Noise indoor	dB-A (H/M/L) <sup>*7</sup>	32/29/27						-	-	-
		Power Level dB	47/44/42						-	-	-
	Noise outdoor	dB-A (H/L)				52/-			-	-	-
Power Level dB					70/-			-	-	-	
EXTRA LOW TEMP   Total capacity(kW) / Input power(W) / COP											
Max Current(A) / Max Input power(W)		0.27×2/29×2		0.26×2/29×2	0.25×2/29×2	9.00/5.55k	9.00/5.80k	9.00/6.05k			
Starting current(A) (Cooling/Heating)						4.20/3.20	3.95/3.05	3.85/2.95			
Comp output(W)						2.50k	2.50k	2.50k			
Network Impedance(ΩMAX.)											
Fan motor output (Indoor/Outdoor) W				60			120				
Moisture removal volume		L/h(Pt/h)	3.2	(1.6×2)	(6.8)						
External static pressure		Pa									
Indoor Air flow <sup>*7</sup>	Cooling	m³/min (ft³/min)	16.5×2/13.5×2/11.5×2 (583)×2/(477)×2/(406)×2						-	-	
	Heating	m³/min (ft³/min)	16.5×2/13.5×2/11.5×2 (583)×2/(477)×2/(406)×2						-	-	
Outdoor Air flow	Cooling	m³/min (ft³/min)				76.0 (2683)			-	-	
	Heating	m³/min (ft³/min)				70.0 (2472)			-	-	
Refrigerant type / amount g(oz)						R32	2.60k	(91.7)			
Product dimension	Height	mm(inch)	256 (10-5/64)			996 (39- 7/32)					
	Width	mm(inch)	840 (33-5/64)			980 (38-37/64)					
	Depth	mm(inch)	840 (33-5/64)			370 (14- 9/16)					
Product dimension (Panel)		H×W×D mm, inch	33.5×950×950 (1-11/32×37-13/32×37-13/32)								
Packing dimension	Height	mm(inch)	302 (11-57/64)			1134 (44-41/64)					
	Width	mm(inch)	898 (35-3/8)			1095 (43-7/64)					
	Depth	mm(inch)	898 (35-3/8)			529 (20-53/64)					
Weight	(NET)	kg(lb)	19 (42)			90 (199)					
	(GROSS)	kg(lb)	26 (57)			98 (216)					
	Panel (NET)	kg(lb)	5 (11)								
Layers limit (actually)				11 (12)	2 (3)						
Operation condition	Cool (DBT)	18°C ~ 32°C			-10°C ~ 43°C						
	Heat (DBT)	16°C ~ 30°C			-15°C ~ 24°C						
MAX WORKING PRESSURE HP/LP MPa (bar)				4.15/2.55 (41.5/25.5)							
P I	Pipe diameter mm (inch)	(Liquid)Ø6.35(1/4) (Gas)Ø12.7(1/2)			(Liquid)Ø9.52(3/8) (Gas)Ø15.88(5/8)						
	Connecting method, Standard length m(ft)	flared type, 5.0(16.4)			flared type, 5.0(16.4)						
P I	Pipe length range m (ft)	5 ~ 50m (16.4 ~ 164.0)									
N G	Indoor unit & Outdoor unit height difference m (ft)	15m(OD located lower)/30m(OD located higher) (49.2/98.4)									
	Add gas amount g/m (oz/ft)	45g/m (0.484)									
N G	Pipe length for additional gas m (ft)	30m (98.4)									

\*1 In case it is necessary to indicate the air flow volume in (l/s), the value in (m³/min.) shall be multiplied by 16.7 and rounded down the decimal point.

\*2 If the EUROVENT Certified models can be operated under the "extra-low" temperature condition, -7°C dry bulb and -8°C wet-bulb temperatures with rated voltage 230V shall be used.

\*3 Network Impedance shall be applicable for EUROPE and CHINA models.

\*4 The annual consumption is calculated by multiplying the input power at 230V(400V) by an average of 500 hours per year in cooling mode.

\*5 EER and COP classification is at 230V(400V) only in accordance with EU directive 2002/31/EC.

\*6 SEER and SCOP classification is at 230V(400V) only in accordance with EN-14825. For heating, SCOP indicates the value of only Average heating season. Other fiche data indicates in an attached sheet

\*7 H: High at setting 5 stage (Level 5), M: Middle at setting 5 stage (Level 3), L: Low at setting 5 stage (Level 1)

# Simultaneous (Twin) -Type

## 1-1. Unit Specifications

PZ2

### 1. 4-Way Cassette Type S-60PU2E5Bx2 / U-125PZ2E8

INDOOR		MODEL	S-60PU2E5B ×2			-			-		
PANEL		MODEL	Standard type: CZ-KPU3×2 / ECONAVI type: CZ-KPU3A×2			-			-		
OUTDOOR		MODEL	-			U-125PZ2E8			-		
Branch pipe		MODEL	-			-			-		
Performance test condition					ISO5151 / EN14511 / EN12102 / EN14825						
Power supply		∅, Hz	1∅ 50Hz			3∅ 50Hz					
		V	220V	230V	240V	380V	400V	415V	Min	Max	
C O O L I N G	Capacity	kW	12.5	12.5	12.5	-	-	-	3.2	13.5	
		BTU/h	42700	42700	42700	-	-	-	10900	46100	
	Current	A	0.36×2	0.35×2	0.34×2	5.50	5.25	5.05	-	-	
		W	38×2	38×2	38×2	3.414k	3.414k	3.414k	-	-	
	Input power	TOTAL W	-			3.490k	3.490k	3.490k	600	4.800k	
		Annual consumption	TOTAL kWh <sup>*4</sup>	-			-	1745	-	-	-
	EER/EER CLASS	TOTAL (W/W) <sup>*5</sup> ("A"-°G)	-	-	-	3.58	3.58/A	3.58	5.33	2.81	
	Erp <sup>*6</sup>	Pdesign	kW	-	-	-	-	12.5	-	-	-
		η <sub>s.c</sub>	%	-	-	-	-	269.8	-	-	-
		Annual consumption	kWh	-	-	-	-	-	-	-	-
		Class		-	-	-	-	-	-	-	-
	Power factor	%	-	-	-	94	94	94	-	-	
	Noise indoor	dB-A (H/M/L) <sup>*7</sup>	36/31/28			-			-	-	
		Power Level dB	51/46/43			-			-	-	
Noise outdoor	dB-A (H/L)	-			55/-			-	-		
	Power Level dB	-			73/-			-	-		
H E A T I N G	Capacity	kW	12.5	12.5	12.5	-	-	-	3.3	15.0	
		BTU/h	42700	42700	42700	-	-	-	11300	51200	
	Current	A	0.35×2	0.34×2	0.33×2	4.45	4.20	4.05	-	-	
		W	36×2	36×2	36×2	2.748k	2.748k	2.748k	-	-	
	Input power	TOTAL W	-			2.820k	2.820k	2.820k	600	4.200k	
		COP/COP CLASS	TOTAL (W/W) <sup>*5</sup> ("A"-°G)	-	-	-	4.43	4.43/A	4.43	5.50	3.57
	Erp <sup>*6</sup>	Pdesign at -10°C	kW	-	-	-	-	12.5	-	-	-
		Tbivalent	°C	-	-	-	-	-10	-	-	-
		η <sub>s.h</sub>	%	-	-	-	-	157.4	-	-	-
		Annual consumption	kWh	-	-	-	-	-	-	-	-
		elbu(-10°C)	kW	-	-	-	-	0.00	-	-	-
	Class		-	-	-	-	-	-	-	-	
	Power factor	%	-	-	-	94	94	94	-	-	
	Noise indoor	dB-A (H/M/L) <sup>*7</sup>	36/31/28			-			-	-	
Power Level dB		51/46/43			-			-	-		
Noise outdoor	dB-A (H/L)	-			55/-			-	-		
	Power Level dB	-			73/-			-	-		
EXTRA LOW TEMP Total capacity(kW) / Input power(W) / COP		-			-			-			
Max Current(A) / Max Input power(W)		0.36×2/38×2	0.35×2/38×2	0.34×2/38×2	10.0/6.20k	10.0/6.50k	10.0/6.75k	-			
Starting current(A) (Cooling/Heating)		-	-	-	5.50/4.45	5.25/4.20	5.05/4.05	-			
Comp output(W)		-			2.80k	2.80k	2.80k	-			
Network Impedance(ΩMAX.)		-			-			-			
Fan motor output (Indoor/Outdoor) W		60			120			-			
Moisture removal volume		L/h(Pt/h)	3.4	(1.7×2)	(7.2)	-			-		
External static pressure		Pa	-			-			-		
Indoor Air flow <sup>*7</sup>	Cooling	m³/min (ft³/min)	21.0×2/16.0×2/13.0×2 (742)×2/(565)×2/(459)×2			-			-	-	
	Heating	m³/min (ft³/min)	21.0×2/16.0×2/13.0×2 (742)×2/(565)×2/(459)×2			-			-	-	
Outdoor Air flow	Cooling	m³/min (ft³/min)	-			86.0 (3037)			-	-	
	Heating	m³/min (ft³/min)	-			78.0 (2754)			-	-	
Refrigerant type / amount g(oz)		-			R32	2.98k	(105.1)	-			
Product dimension	Height	mm(inch)	256 (10-5/64)			996 (39- 7/32)			-		
	Width	mm(inch)	840 (33-5/64)			980 (38-37/64)			-		
	Depth	mm(inch)	840 (33-5/64)			370 (14- 9/16)			-		
Product dimension (Panel)		H×W×D mm, inch	33.5×950×950 (1-11/32×37-13/32×37-13/32)			-			-		
Packing dimension	Height	mm(inch)	302 (11-57/64)			1134 (44-41/64)			-		
	Width	mm(inch)	898 (35-3/8)			1095 (43-7/64)			-		
	Depth	mm(inch)	898 (35-3/8)			529 (20-53/64)			-		
Weight	(NET)	kg(lb)	20 (44)			94 (207)			-		
	(GROSS)	kg(lb)	27 (60)			102 (224)			-		
	Panel (NET)	kg(lb)	5 (11)			-			-		
Layers limit (actually)		11 (12)			2 (3)			-			
Operation condition	Cool (DBT)	18°C ~ 32°C			-10°C ~ 43°C			-			
	Heat (DBT)	16°C ~ 30°C			-15°C ~ 24°C			-			
MAX WORKING PRESSURE HP/LP MPa (bar)		4.15/2.55 (41.5/25.5)			-			-			
P I	Pipe diameter mm (inch)	(Liquid)∅9.52(3/8) (Gas)∅15.88(5/8)			(Liquid)∅9.52(3/8) (Gas)∅15.88(5/8)			-			
	Connecting method, Standard length m(ft)	flared type, 5.0(16.4)			flared type, 5.0(16.4)			-			
P I	Pipe length range m (ft)	5 ~ 50m (16.4 ~ 164.0)			-			-			
	Indoor unit & Outdoor unit height difference m (ft)	15m(OD located lower)/30m(OD located higher) (49.2/98.4)			-			-			
N G	Add gas amount g/m (oz/ft)	45g/m (0.484)			-			-			
	Pipe length for additional gas m (ft)	30m (98.4)			-			-			

\*1 In case it is necessary to indicate the air flow volume in (l/s), the value in (m³/min.) shall be multiplied by 16.7 and rounded down the decimal point.  
 \*2 If the EUROVENT Certified models can be operated under the "extra-low" temperature condition, -7°C dry bulb and -8°C wet-bulb temperatures with rated voltage 230V shall be used.  
 \*3 Network Impedance shall be applicable for EUROPE and CHINA models.  
 \*4 The annual consumption is calculated by multiplying the input power at 230V(400V) by an average of 500 hours per year in cooling mode.  
 \*5 EER and COP classification is at 230V(400V) only in accordance with EU directive 2002/31/EC.  
 \*6 η<sub>s.c</sub> and η<sub>s.h</sub> classification is at 230V(400V) only in accordance with EN-14825. For heating, η<sub>s.h</sub> indicates the value of only Average heating season.  
 \*7 H: High at setting 5 stage (Level 5), M: Middle at setting 5 stage (Level 3), L: Low at setting 5 stage (Level 1)

# Simultaneous (Twin) -Type

## 1-1. Unit Specifications

**PZ2**

### 1. 4-Way Cassette Type S-71PU2E5B×2 / U-140PZ2E8

INDOOR		MODEL	S-71PU2E5B ×2			-			-		
PANEL		MODEL	Standard type: CZ-KPU3×2 / ECONAVI type: CZ-KPU3A×2			-			-		
OUTDOOR		MODEL	-			U-140PZ2E8			-		
Branch pipe		MODEL	-			-			-		
Performance test condition		ISO5151 / EN14511 / EN12102 / EN14825									
Power supply		Ø, Hz	1Ø 50Hz			3Ø 50Hz			Min	Max	
		V	220V	230V	240V	380V	400V	415V			
C O O L I N G	Capacity	kW	14.0	14.0	14.0	-	-	-	3.3	15.0	
		BTU/h	47800	47800	47800	-	-	-	11300	51200	
	Current	A	0.40×2	0.39×2	0.38×2	6.90	6.55	6.30	-	-	
		W	42×2	42×2	42×2	4.256k	4.256k	4.256k	-	-	
	Input power	TOTAL W	-			4.340k	4.340k	4.340k	620	5.500k	
		Annual consumption	TOTAL kWh <sup>*4</sup>	-			-	2170	-	-	-
	EER/EER CLASS	TOTAL (W/W) <sup>1)</sup> ("A"-°G)	-	-	-	3.23	3.23/A	3.23	5.32	2.73	
	Erp <sup>*6</sup>	P <sub>design</sub>	kW	-	-	-	-	14.0	-	-	-
		η <sub>s,c</sub>	%	-	-	-	-	259.4	-	-	-
		Annual consumption	kWh	-	-	-	-	-	-	-	-
Class			-	-	-	-	-	-	-	-	
Power factor	%	-	-	-	94	94	94	-	-		
Noise indoor	dB-A (H/M/L) <sup>*7</sup>	37/31/28			-			-	-		
	Power Level dB	52/46/43			-			-	-		
Noise outdoor	dB-A (H/L)	-			56/-			-	-		
	Power Level dB	-			74/-			-	-		
H E A T I N G	Capacity	kW	14.0	14.0	14.0	-	-	-	3.4	16.0	
		BTU/h	47800	47800	47800	-	-	-	11600	54600	
	Current	A	0.39×2	0.38×2	0.37×2	5.30	5.00	4.85	-	-	
		W	40×2	40×2	40×2	3.270k	3.270k	3.270k	-	-	
	Input power	TOTAL W	-			3.350k	3.350k	3.350k	620	4.800k	
		COP/COP CLASS	TOTAL (W/W) <sup>1)</sup> ("A"-°G)	-	-	-	4.18	4.18/A	4.18	5.48	3.33
	Erp <sup>*6</sup>	P <sub>design</sub> at -10°C	kW	-	-	-	-	14.0	-	-	-
		T <sub>bivalent</sub>	°C	-	-	-	-	-7	-	-	-
		η <sub>s,h</sub>	%	-	-	-	-	152.5	-	-	-
		Annual consumption	kWh	-	-	-	-	-	-	-	-
elbu(-10°C)		kW	-	-	-	-	3.30	-	-	-	
Class			-	-	-	-	-	-	-	-	
Power factor	%	-	-	-	94	94	94	-	-		
Noise indoor	dB-A (H/M/L) <sup>*7</sup>	37/31/28			-			-	-		
	Power Level dB	52/46/43			-			-	-		
Noise outdoor	dB-A (H/L)	-			56/-			-	-		
	Power Level dB	-			74/-			-	-		
EXTRA LOW TEMP Total capacity(kW) / Input power(W) / COP		-									
Max Current(A) / Max Input power(W)		0.40×2/42×2	0.39×2/42×2	0.38×2/42×2	10.5/6.50k	10.5/6.85k	10.5/7.10k	-			
Starting current(A) (Cooling/Heating)		-	-	-	6.90/5.30	6.55/5.00	6.30/4.85	-			
Comp output(W)		-			3.00k	3.00k	3.00k	-			
Network Impedance(ΩMAX.)		-			-			-			
Fan motor output (Indoor/Outdoor) W		60			120			-			
Moisture removal volume		L/h(Pt/h)	5.0	(2.5×2)	(10.6)	-			-		
External static pressure		Pa	-			-			-		
Indoor Air flow <sup>*7</sup>	Cooling	m <sup>3</sup> /min (ft <sup>3</sup> /min)	22.0×2/16.0×2/13.0×2 (777)×2/(565)×2/(459)×2			-			-	-	
	Heating	m <sup>3</sup> /min (ft <sup>3</sup> /min)	22.0×2/16.0×2/13.0×2 (777)×2/(565)×2/(459)×2			-			-	-	
Outdoor Air flow	Cooling	m <sup>3</sup> /min (ft <sup>3</sup> /min)	-			89.0 (3143)			-	-	
	Heating	m <sup>3</sup> /min (ft <sup>3</sup> /min)	-			83.0 (2931)			-	-	
Refrigerant type / amount g(oz)		-			R32	2.98k	(105.1)	-			
Product dimension	Height	mm(inch)	256 (10-5/64)			996 (39- 7/32)			-		
	Width	mm(inch)	840 (33-5/64)			980 (38-37/64)			-		
	Depth	mm(inch)	840 (33-5/64)			370 (14- 9/16)			-		
Product dimension (Panel)		H×W×D mm, inch	33.5×950×950 (1-11/32×37-13/32×37-13/32)			-			-		
Packing dimension	Height	mm(inch)	302 (11-57/64)			1134 (44-41/64)			-		
	Width	mm(inch)	898 (35-3/8)			1095 (43-7/64)			-		
	Depth	mm(inch)	898 (35-3/8)			529 (20-53/64)			-		
Weight	(NET)	kg(lb)	20 (44)			94 (207)			-		
	(GROSS)	kg(lb)	27 (60)			102 (224)			-		
	Panel (NET)	kg(lb)	5 (11)			-			-		
Layers limit (actually)		11 (12)			2 (3)			-			
Operation condition	Cool (DBT)	18°C ~ 32°C			-10°C ~ 43°C			-			
	Heat (DBT)	16°C ~ 30°C			-15°C ~ 24°C			-			
MAX WORKING PRESSURE HP/LP MPa (bar)		4.15/2.55 (41.5/25.5)									
P I P I N G	Pipe diameter mm (inch)	(Liquid)Ø9.52(3/8) (Gas)Ø15.88(5/8)			(Liquid)Ø9.52(3/8) (Gas)Ø15.88(5/8)			-			
	Connecting method, Standard length m(ft)	flared type, 5.0(16.4)			flared type, 5.0(16.4)			-			
Pipe length range m (ft)		5 ~ 50m (16.4 ~ 164.0)									
Indoor unit & Outdoor unit height difference m (ft)		15m(OD located lower)/30m(OD located higher) (49.2/98.4)									
Add gas amount g/m (oz/ft)		45g/m (0.484)									
Pipe length for additional gas m (ft)		30m (98.4)									

\*1 In case it is necessary to indicate the air flow volume in (l/s), the value in (m<sup>3</sup>/min.) shall be multiplied by 16.7 and rounded down the decimal point.

\*2 If the EUROVENT Certified models can be operated under the "extra-low" temperature condition, -7°C dry bulb and -8°C wet-bulb temperatures with rated voltage 230V shall be used.

\*3 Network Impedance shall be applicable for EUROPE and CHINA models.

\*4 The annual consumption is calculated by multiplying the input power at 230V(400V) by an average of 500 hours per year in cooling mode.

\*5 EER and COP classification is at 230V(400V) only in accordance with EU directive 2002/31/EC.

\*6 η<sub>s,c</sub> and η<sub>s,h</sub> classification is at 230V(400V) only in accordance with EN-14825. For heating, η<sub>s,h</sub> indicates the value of only Average heating season.

\*7 H: High at setting 5 stage (Level 5), M: Middle at setting 5 stage (Level 3), L: Low at setting 5 stage (Level 1)



# Single-Type

## 1-1. Unit Specifications

**PZ2**

### 1. 4-Way Cassette Type S-100PU2E5B / U-100PZ2E8

INDOOR	MODEL	S-100PU2E5B			-			-			
PANEL	MODEL	Standard type: CZ-KPU3 / ECONAVI type: CZ-KPU3A			-			-			
OUTDOOR	MODEL	-			U-100PZ2E8			-			
Branch pipe	MODEL	-			-			-			
Performance test condition		ISO5151 / EN14511 / EN12102 / EN14825									
Power supply		Ø, Hz	1Ø 50Hz			3Ø 50Hz			Min	Max	
		V	220V	230V	240V	380V	400V	415V			
C O O L I N G	Capacity	kW	10.0	10.0	10.0	-	-	-	3.0	11.5	
		BTU/h	34100	34100	34100	-	-	-	10200	39200	
	Current	A	0.82	0.79	0.76	4.10	3.90	3.75	-	-	
		W	100	100	100	2.520k	2.520k	2.520k	-	-	
	Input power	TOTAL W	-			2.620k	2.620k	2.620k	560	4.000k	
		Annual consumption	TOTAL kWh**	-			-	1310	-	-	-
	EER/EER CLASS	TOTAL (W/W) <sup>1)</sup> ("A"~"G")	-	-	-	3.82	3.82/A	3.82	5.36	2.88	
	Erp <sup>5)</sup>	Pdesign	kW	-	-	-	-	10.0	-	-	-
		SEER	(W/W)	-	-	-	-	6.7	-	-	-
		Annual consumption	kWh	-	-	-	-	521	-	-	-
Class			-	-	-	-	A++	-	-	-	
Power factor	%	-	-	-	93	93	93	-	-		
Noise indoor	dB-A (H/M/L) <sup>7)</sup>	45/38/32			-			-	-		
	Power Level dB	60/53/47			-			-	-		
Noise outdoor	dB-A (H/L)	-			52/-			-	-		
	Power Level dB	-			70/-			-	-		
H E A T I N G	Capacity	kW	10.0	10.0	10.0	-	-	-	3.0	14.0	
		BTU/h	34100	34100	34100	-	-	-	10200	47800	
	Current	A	0.81	0.78	0.75	3.15	3.00	2.90	-	-	
		W	95	95	95	1.935k	1.935k	1.935k	-	-	
	Input power	TOTAL W	-			2.030k	2.030k	2.030k	560	3.900k	
		COP/COP CLASS	TOTAL (W/W) <sup>1)</sup> ("A"~"G")	-	-	-	4.93	4.93/A	4.93	5.36	3.59
	Erp <sup>5)</sup>	Pdesign at -10°C	kW	-	-	-	-	10.0	-	-	-
		Tbivalent	°C	-	-	-	-	-10	-	-	-
		SCOP	(W/W)	-	-	-	-	4.4	-	-	-
		Annual consumption	kWh	-	-	-	-	3182	-	-	-
Class	elbu(-10°C)	kW	-	-	-	-	0.00	-	-	-	
			-	-	-	-	A+	-	-	-	
Power factor	%	-	-	-	93	93	93	-	-		
Noise indoor	dB-A (H/M/L) <sup>7)</sup>	45/38/32			-			-	-		
	Power Level dB	60/53/47			-			-	-		
Noise outdoor	dB-A (H/L)	-			52/-			-	-		
	Power Level dB	-			70/-			-	-		
EXTRA LOW TEMP Total capacity(kW) / Input power(W) / COP		-									
Max Current(A) / Max Input power(W)		0.82/100	0.79/100	0.76/100	9.00/5.55k	9.00/5.80k	9.00/6.05k	-			
Starting current(A) (Cooling/Heating)		-	-	-	4.10/3.15	3.90/3.00	3.75/2.90	-			
Comp output(W)		-			2.50k	2.50k	2.50k	-			
Network Impedance(ΩMAX.)		-			-			-			
Fan motor output (Indoor/Outdoor) W		90			120			-			
Moisture removal volume		L/h(Pt/h)	2.7	(5.7)		-			-		
External static pressure		Pa	-			-			-		
Indoor Air flow <sup>7)</sup>	Cooling	m³/min (ft³/min)	36.0/26.0/18.0 (1271)/(918)/(636)			-			-		
	Heating	m³/min (ft³/min)	36.0/26.0/18.0 (1271)/(918)/(636)			-			-		
Outdoor Air flow	Cooling	m³/min (ft³/min)	-			76.0 (2683)			-		
	Heating	m³/min (ft³/min)	-			70.0 (2472)			-		
Refrigerant type / amount g(oz)		-			R32	2.60k	(91.7)	-			
Product dimension	Height	mm(inch)	319 (12-9/16)			996 (39- 7/32)			-		
	Width	mm(inch)	840 (33-5/64)			980 (38-37/64)			-		
	Depth	mm(inch)	840 (33-5/64)			370 (14- 9/16)			-		
Product dimension (Panel)		H×W×D mm, inch	33.5×950×950 (1-11/32×37-13/32×37-13/32)			-			-		
Packing dimension	Height	mm(inch)	365 (14-3/8)			1134 (44-41/64)			-		
	Width	mm(inch)	898 (35-3/8)			1095 (43-7/64)			-		
	Depth	mm(inch)	898 (35-3/8)			529 (20-53/64)			-		
Weight	(NET)	kg(lb)	25 (55)			90 (199)			-		
	(GROSS)	kg(lb)	32 (71)			98 (216)			-		
	Panel (NET)	kg(lb)	5 (11)			-			-		
Layers limit (actually)		11 (12)			2 (3)			-			
Operation condition	Cool (DBT)	18°C ~ 32°C			-10°C ~ 43°C			-			
	Heat (DBT)	16°C ~ 30°C			-15°C ~ 24°C			-			
MAX WORKING PRESSURE HP/LP MPa (bar)		4.15/2.55 (41.5/25.5)									
P I	Pipe diameter mm (inch)	(Liquid)Ø9.52(3/8) (Gas)Ø15.88(5/8)			(Liquid)Ø9.52(3/8) (Gas)Ø15.88(5/8)			-			
	Connecting method, Standard length m(ft)	flared type, 5.0(16.4)			flared type, 5.0(16.4)			-			
P I	Pipe length range m (ft)	5 ~ 50m (16.4 ~ 164.0)									
N G	Indoor unit & Outdoor unit height difference m (ft)	15m(OD located lower)/30m(OD located higher) (49.2/98.4)									
	Add gas amount g/m (oz/ft)	45g/m (0.484)									
N G	Pipe length for additional gas m (ft)	30m (98.4)									

\*1 In case it is necessary to indicate the air flow volume in (l/s), the value in (m³/min.) shall be multiplied by 16.7 and rounded down the decimal point.  
 \*2 If the EUROVENT Certified models can be operated under the "extra-low" temperature condition, -7°C dry bulb and -8°C wet-bulb temperatures with rated voltage 230V shall be used.  
 \*3 Network Impedance shall be applicable for EUROPE and CHINA models.  
 \*4 The annual consumption is calculated by multiplying the input power at 230V(400V) by an average of 500 hours per year in cooling mode.  
 \*5 EER and COP classification is at 230V(400V) only in accordance with EU directive 2002/31/EC.  
 \*6 SEER and SCOP classification is at 230V(400V) only in accordance with EN-14825. For heating, SCOP indicates the value of only Average heating season, Other fiche data indicates in an attached sheet  
 \*7 H: High at setting 5 stage (Level 5), M: Middle at setting 5 stage (Level 3), L: Low at setting 5 stage (Level 1)

# Single-Type

## 1-1. Unit Specifications

**PZ2**

### 1. 4-Way Cassette Type S-125PU2E5B / U-125PZ2E8

INDOOR	MODEL	S-125PU2E5B			-			-			
PANEL	MODEL	Standard type: CZ-KPU3 / ECONAVI type: CZ-KPU3A			-			-			
OUTDOOR	MODEL	-			U-125PZ2E8			-			
Branch pipe	MODEL	-			-			-			
Performance test condition		ISO5151 / EN14511 / EN12102 / EN14825									
Power supply		Ø, Hz	1Ø 50Hz			3Ø 50Hz			Min	Max	
		V	220V	230V	240V	380V	400V	415V			
C O O L I N G	Capacity	kW	12.5	12.5	12.5	-	-	-	3.2	13.5	
		BTU/h	42700	42700	42700	-	-	-	10900	46100	
	Current	A	0.91	0.88	0.85	5.45	5.20	5.00	-	-	
		W	110	110	110	3.380k	3.380k	3.380k	-	-	
	Input power	TOTAL W	-	-	-	3.490k	3.490k	3.490k	600	4.800k	
		Annual consumption	TOTAL kWh**	-	-	-	-	1745	-	-	-
	EER/EER CLASS	TOTAL (W/W) <sup>1)</sup> ("A"~"G")	-	-	-	3.58	3.58/A	3.58	5.33	2.81	
	Erp <sup>4)</sup>	Pdesign	kW	-	-	-	-	12.5	-	-	-
		η <sub>s.c</sub>	%	-	-	-	-	266.1	-	-	-
		Annual consumption	kWh	-	-	-	-	-	-	-	-
		Class		-	-	-	-	-	-	-	-
	Power factor	%	-	-	-	94	94	94	-	-	
	Noise indoor	dB-A (H/M/L) <sup>7)</sup>	46/39/33			-			-	-	
		Power Level dB	61/54/48			-			-	-	
Noise outdoor	dB-A (H/L)	-			55/-			-	-		
	Power Level dB	-			73/-			-	-		
H E A T I N G	Capacity	kW	12.5	12.5	12.5	-	-	-	3.3	15.0	
		BTU/h	42700	42700	42700	-	-	-	11300	51200	
	Current	A	0.90	0.87	0.84	4.40	4.15	4.00	-	-	
		W	105	105	105	2.715k	2.715k	2.715k	-	-	
	Input power	TOTAL W	-	-	-	2.820k	2.820k	2.820k	600	4.200k	
		COP/COP CLASS	TOTAL (W/W) <sup>1)</sup> ("A"~"G")	-	-	-	4.43	4.43/A	4.43	5.50	3.57
	Erp <sup>4)</sup>	Pdesign at -10°C	kW	-	-	-	-	12.5	-	-	-
		Tbivalent	°C	-	-	-	-	-10	-	-	-
		η <sub>s.h</sub>	%	-	-	-	-	157.3	-	-	-
		Annual consumption	kWh	-	-	-	-	-	-	-	-
		elbu(-10°C)	kW	-	-	-	-	0.00	-	-	-
		Class		-	-	-	-	-	-	-	-
	Power factor	%	-	-	-	94	94	94	-	-	
	Noise indoor	dB-A (H/M/L) <sup>7)</sup>	46/39/33			-			-	-	
Power Level dB		61/54/48			-			-	-		
Noise outdoor	dB-A (H/L)	-			55/-			-	-		
	Power Level dB	-			73/-			-	-		
EXTRA LOW TEMP Total capacity(kW) / Input power(W) / COP		-									
Max Current(A) / Max Input power(W)		0.91/110	0.88/110	0.85/110	10.0/6.20k	10.0/6.50k	10.0/6.75k	-			
Starting current(A) (Cooling/Heating)		-	-	-	5.45/4.40	5.20/4.15	5.00/4.00	-			
Comp output(W)		-			2.80k	2.80k	2.80k	-			
Network Impedance(ΩMAX.)		-			-			-			
Fan motor output (Indoor/Outdoor) W		90			120			-			
Moisture removal volume		L/h(Pt/h)	4.8	(10.1)		-			-		
External static pressure		Pa	-			-			-		
Indoor Air flow <sup>*7)</sup>	Cooling	m <sup>3</sup> /min (ft <sup>3</sup> /min)	37.0/27.0/19.0 (1307)/(953)/(671)			-			-		
	Heating	m <sup>3</sup> /min (ft <sup>3</sup> /min)	37.0/27.0/19.0 (1307)/(953)/(671)			-			-		
Outdoor Air flow	Cooling	m <sup>3</sup> /min (ft <sup>3</sup> /min)	-			86.0 (3037)			-		
	Heating	m <sup>3</sup> /min (ft <sup>3</sup> /min)	-			78.0 (2754)			-		
Refrigerant type / amount g(oz)		-			R32	2.98k	(105.1)	-			
Product dimension	Height	mm(inch)	319 (12-9/16)			996 (39- 7/32)			-		
	Width	mm(inch)	840 (33-5/64)			980 (38-37/64)			-		
	Depth	mm(inch)	840 (33-5/64)			370 (14- 9/16)			-		
Product dimension (Panel)		H×W×D mm, inch	33.5×950×950 (1-11/32×37-13/32×37-13/32)			-			-		
Packing dimension	Height	mm(inch)	365 (14-3/8)			1134 (44-41/64)			-		
	Width	mm(inch)	898 (35-3/8)			1095 (43-7/64)			-		
	Depth	mm(inch)	898 (35-3/8)			529 (20-53/64)			-		
Weight	(NET)	kg(lb)	25 (55)			94 (207)			-		
	(GROSS)	kg(lb)	32 (71)			102 (224)			-		
	Panel (NET)	kg(lb)	5 (11)			-			-		
Layers limit (actually)		11 (12)			2 (3)			-			
Operation condition	Cool (DBT)	18°C ~ 32°C			-10°C ~ 43°C			-			
	Heat (DBT)	16°C ~ 30°C			-15°C ~ 24°C			-			
MAX WORKING PRESSURE HP/LP MPa (bar)		4.15/2.55 (41.5/25.5)									
P I	Pipe diameter mm (inch)	(Liquid)Ø9.52(3/8) (Gas)Ø15.88(5/8)			(Liquid)Ø9.52(3/8) (Gas)Ø15.88(5/8)			-			
	Connecting method, Standard length m(ft)	flared type, 5.0(16.4)			flared type, 5.0(16.4)			-			
P I	Pipe length range m (ft)	5 ~ 50m (16.4 ~ 164.0)									
N I	Indoor unit & Outdoor unit height difference m (ft)	15m(OD located lower)/30m(OD located higher) (49.2/98.4)									
N I	Add gas amount g/m (oz/ft)	45g/m (0.484)									
N I	Pipe length for additional gas m (ft)	30m (98.4)									

\*1 In case it is necessary to indicate the air flow volume in (l/s), the value in (m<sup>3</sup>/min.) shall be multiplied by 16.7 and rounded down the decimal point.

\*2 If the EUROVENT Certified models can be operated under the "extra-low" temperature condition, -7°C dry bulb and -8°C wet-bulb temperatures with rated voltage 230V shall be used.

\*3 Network Impedance shall be applicable for EUROPE and CHINA models.

\*4 The annual consumption is calculated by multiplying the input power at 230V(400V) by an average of 500 hours per year in cooling mode.

\*5 EER and COP classification is at 230V(400V) only in accordance with EU directive 2002/31/EC.

\*6 η<sub>s.c</sub> and η<sub>s.h</sub> classification is at 230V(400V) only in accordance with EN-14825. For heating, η<sub>s.h</sub> indicates the value of only Average heating season.

\*7 H: High at setting 5 stage (Level 5), M: Middle at setting 5 stage (Level 3), L: Low at setting 5 stage (Level 1)

# Single-Type

## 1-1. Unit Specifications

**PZ2**

### 1. 4-Way Cassette Type S-140PU2E5B / U-140PZ2E8

INDOOR	MODEL	S-140PU2E5B			-			-			
PANEL	MODEL	Standard type: CZ-KPU3 / ECONAVI type: CZ-KPU3A			-			-			
OUTDOOR	MODEL	-			U-140PZ2E8			-			
Branch pipe	MODEL	-			-			-			
Performance test condition		ISO5151 / EN14511 / EN12102 / EN14825									
Power supply		Ø, Hz	1Ø 50Hz			3Ø 50Hz			Min	Max	
		V	220V	230V	240V	380V	400V	415V			
C O O L I N G	Capacity	kW	14.0	14.0	14.0	-	-	-	3.3	15.0	
		BTU/h	47800	47800	47800	-	-	-	11300	51200	
	Current	A	0.97	0.94	0.91	6.85	6.50	6.25	-	-	
		W	120	120	120	4.220k	4.220k	4.220k	-	-	
	Input power	TOTAL W	-			4.340k	4.340k	4.340k	620	5.500k	
		Annual consumption	TOTAL kWh**	-			-	2170	-	-	-
	EER/EER CLASS	TOTAL (W/W) <sup>1)</sup> ("A"~"G")	-	-	-	3.23	3.23/A	3.23	5.32	2.73	
	E r p * 6	Pdesign	kW	-	-	-	-	14.0	-	-	-
		η <sub>s.c</sub>	%	-	-	-	-	256.5	-	-	-
		Annual consumption	kWh	-	-	-	-	-	-	-	-
Class			-	-	-	-	-	-	-	-	
Power factor	%	-	-	-	94	94	94	-	-		
Noise indoor	dB-A (H/M/L) <sup>*7</sup>	47/40/34			-			-	-		
	Power Level dB	62/55/49			-			-	-		
Noise outdoor	dB-A (H/L)	-			56/-			-	-		
	Power Level dB	-			74/-			-	-		
H E A T I N G	Capacity	kW	14.0	14.0	14.0	-	-	-	3.4	16.0	
		BTU/h	47800	47800	47800	-	-	-	11600	54600	
	Current	A	0.96	0.93	0.90	5.25	4.95	4.80	-	-	
		W	115	115	115	3.235k	3.235k	3.235k	-	-	
	Input power	TOTAL W	-			3.350k	3.350k	3.350k	620	4.800k	
		COP/COP CLASS	TOTAL (W/W) <sup>1)</sup> ("A"~"G")	-	-	-	4.18	4.18/A	4.18	5.48	3.33
	E r p * 6	Pdesign at -10°C	kW	-	-	-	-	14.0	-	-	-
		Tbivalent	°C	-	-	-	-	-7	-	-	-
		η <sub>s.h</sub>	%	-	-	-	-	152.4	-	-	-
		Annual consumption	kWh	-	-	-	-	-	-	-	-
Class	elbu(-10°C)	kW	-	-	-	-	3.10	-	-	-	
	Class		-	-	-	-	-	-	-	-	
Power factor	%	-	-	-	94	94	94	-	-		
Noise indoor	dB-A (H/M/L) <sup>*7</sup>	47/40/34			-			-	-		
	Power Level dB	62/55/49			-			-	-		
Noise outdoor	dB-A (H/L)	-			56/-			-	-		
	Power Level dB	-			74/-			-	-		
EXTRA LOW TEMP Total capacity(kW) / Input power(W) / COP		-									
Max Current(A) / Max Input power(W)		0.97/120	0.94/120	0.91/120	10.5/6.50k	10.5/6.85k	10.5/7.10k	-			
Starting current(A) (Cooling/Heating)		-	-	-	6.85/5.25	6.50/4.95	6.25/4.80	-			
Comp output(W)		-			3.00k	3.00k	3.00k	-			
Network Impedance(ΩMAX.)		-			-			-			
Fan motor output (Indoor/Outdoor) W		60			120			-			
Moisture removal volume		L/h(Pt/h)	6.0 (12.6)			-			-		
External static pressure		Pa	-			-			-		
Indoor Air flow <sup>*7</sup>	Cooling	m <sup>3</sup> /min (ft <sup>3</sup> /min)	38.0/29.0/20.0 (1342)/(1024)/(706)			-			-	-	
	Heating	m <sup>3</sup> /min (ft <sup>3</sup> /min)	38.0/29.0/20.0 (1342)/(1024)/(706)			-			-	-	
Outdoor Air flow	Cooling	m <sup>3</sup> /min (ft <sup>3</sup> /min)	-			89.0 (3143)			-	-	
	Heating	m <sup>3</sup> /min (ft <sup>3</sup> /min)	-			83.0 (2931)			-	-	
Refrigerant type / amount g(oz)		-			R32	2.98k	(105.1)	-			
Product dimension	Height	mm(inch)	319 (12-9/16)			996 (39- 7/32)			-		
	Width	mm(inch)	840 (33-5/64)			980 (38-37/64)			-		
	Depth	mm(inch)	840 (33-5/64)			370 (14- 9/16)			-		
Product dimension (Panel)		H×W×D mm, inch	33.5×950×950 (1-11/32×37-13/32×37-13/32)			-			-		
Packing dimension	Height	mm(inch)	365 (14-3/8)			1134 (44-41/64)			-		
	Width	mm(inch)	898 (35-3/8)			1095 (43-7/64)			-		
	Depth	mm(inch)	898 (35-3/8)			529 (20-53/64)			-		
Weight	(NET)	kg(lb)	25 (55)			94 (207)			-		
	(GROSS)	kg(lb)	32 (71)			102 (224)			-		
	Panel (NET)	kg(lb)	5 (11)			-			-		
Layers limit (actually)		11 (12)			2 (3)			-			
Operation condition	Cool (DBT)	18°C ~ 32°C			-10°C ~ 43°C			-			
	Heat (DBT)	16°C ~ 30°C			-15°C ~ 24°C			-			
MAX WORKING PRESSURE HP/LP MPa (bar)		4.15/2.55 (41.5/25.5)									
P I P I N G	Pipe diameter mm (inch)	(Liquid)Ø9.52(3/8) (Gas)Ø15.88(5/8)			(Liquid)Ø9.52(3/8) (Gas)Ø15.88(5/8)			-			
	Connecting method, Standard length m(ft)	flared type, 5.0(16.4)			flared type, 5.0(16.4)			-			
Pipe length range m (ft)		5 ~ 50m (16.4 ~ 164.0)									
Indoor unit & Outdoor unit height difference m (ft)		15m(OD located lower)/30m(OD located higher) (49.2/98.4)									
Add gas amount g/m (oz/ft)		45g/m (0.484)									
Pipe length for additional gas m (ft)		30m (98.4)									

\*1 In case it is necessary to indicate the air flow volume in (l/s), the value in (m<sup>3</sup>/min.) shall be multiplied by 16.7 and rounded down the decimal point.  
 \*2 If the EUROVENT Certified models can be operated under the "extra-low" temperature condition, -7°C dry bulb and -8°C wet-bulb temperatures with rated voltage 230V shall be used.  
 \*3 Network Impedance shall be applicable for EUROPE and CHINA models.  
 \*4 The annual consumption is calculated by multiplying the input power at 230V(400V) by an average of 500 hours per year in cooling mode.  
 \*5 EER and COP classification is at 230V(400V) only in accordance with EU directive 2002/31/EC.  
 \*6 η<sub>s.c</sub> and η<sub>s.h</sub> classification is at 230V(400V) only in accordance with EN-14825. For heating, η<sub>s.h</sub> indicates the value of only Average heating season.  
 \*7 H: High at setting 5 stage (Level 5), M: Middle at setting 5 stage (Level 3), L: Low at setting 5 stage (Level 1)

# Simultaneous (Twin) -Type

## 1-1. Unit Specifications

**PZ2**

## 2. Ceiling Type S-50PT2E5Bx2 / U-100PZ2E5

INDOOR		MODEL	S-50PT2E5Bx2			-			-		
PANEL		MODEL	-			-			-		
OUTDOOR		MODEL	-			U-100PZ2E5			-		
Branch pipe		MODEL	-			-			-		
Performance test condition					ISO5151 / EN14511 / EN12102 / EN14825						
Power supply		Ø, Hz	1Ø 50Hz			1Ø 50Hz			Min	Max	
		V	220V	230V	240V	220V	230V	240V			
C O O L I N G	Capacity	kW	10.0	10.0	10.0	-	-	-	3.0	11.5	
		BTU/h	34100	34100	34100	-	-	-	10200	39200	
	Current	A	0.39×2	0.38×2	0.37×2	12.8	12.2	11.7	-	-	
		W	40×2	40×2	40×2	2.670k	2.670k	2.670k	-	-	
	Input power	TOTAL W	-			2.750k	2.750k	2.750k	560	4.100k	
		Annual consumption	TOTAL kWh **	-			-	1375	-	-	-
	EER/EER CLASS	TOTAL (W/W) <sup>1)</sup> ("A"-~"G")	-	-	-	3.64	3.64/A	3.64	5.36	2.80	
	Erp <sup>5)</sup>	Pdesign	kW	-	-	-	-	10.0	-	-	-
		SEER	(W/W)	-	-	-	-	6.3	-	-	-
		Annual consumption	kWh	-	-	-	-	551	-	-	-
		Class		-	-	-	-	A++	-	-	-
	Power factor	%	-	-	-	95	95	95	-	-	
	Noise indoor	dB-A (H/M/L)	37×2/33×2/29×2			-			-	-	
		Power Level dB	55×2/51×2/47×2			-			-	-	
Noise outdoor	dB-A (H/L)	-			52/-			-	-		
	Power Level dB	-			70/-			-	-		
H E A T I N G	Capacity	kW	10.0	10.0	10.0	-	-	-	3.0	14.0	
		BTU/h	34100	34100	34100	-	-	-	10200	47800	
	Current	A	0.39×2	0.38×2	0.37×2	10.9	10.4	10.0	-	-	
		W	40×2	40×2	40×2	2.280k	2.280k	2.280k	-	-	
	Input power	TOTAL W	-			2.360k	2.360k	2.360k	560	4.000k	
		COP/COP CLASS	TOTAL (W/W) <sup>1)</sup> ("A"-~"G")	-	-	-	4.24	4.24/A	4.24	5.36	3.50
	Erp <sup>5)</sup>	Pdesign at -10°C	kW	-	-	-	-	10.0	-	-	-
		Tbivalent	°C	-	-	-	-	-7	-	-	-
		SCOP	(W/W)	-	-	-	-	4	-	-	-
		Annual consumption	kWh	-	-	-	-	3495	-	-	-
		elbu(-10°C)	kW	-	-	-	-	2.07	-	-	-
	Class		-	-	-	-	A+	-	-	-	
	Power factor	%	-	-	-	95	95	95	-	-	
	Noise indoor	dB-A (H/M/L)	37×2/33×2/29×2			-			-	-	
Power Level dB		55×2/51×2/47×2			-			-	-		
Noise outdoor	dB-A (H/L)	-			52/-			-	-		
	Power Level dB	-			70/-			-	-		
EXTRA LOW TEMP   Total capacity(kW) / Input power(W) / COP											
Max Current(A) / Max Input power(W)		0.39×2/80×2		0.38×2/80×2	0.37×2/80×2	25.0/5.25k	25.0/5.50k	25.0/5.70k	-		
Starting current(A) (Cooling/Heating)		-		-	-	12.8/10.9	12.2/10.4	11.7/10.0	-		
Comp output(W)		-		-	-	2.50k	2.50k	2.50k	-		
Network Impedance(ΩMAX.)		-		-	-	-			-		
Fan motor output (Indoor/Outdoor) W		-		43	-			120	-		
Moisture removal volume		L/h(Pt/h)	5.6	(2.8×2)	(11.8)	-			-		
External static pressure		Pa	-			-			-		
Indoor Air flow	Cooling	m³/min (ft³/min)	15.0×2/12.5×2/10.5×2 (530×2)/(441×2)/(371×2)			-			-	-	
	Heating	m³/min (ft³/min)	15.0×2/12.5×2/10.5×2 (530×2)/(441×2)/(371×2)			-			-	-	
Outdoor Air flow	Cooling	m³/min (ft³/min)	-			76.0 (2683)			-	-	
	Heating	m³/min (ft³/min)	-			70.0 (2472)			-	-	
Refrigerant type / amount g(oz)		-		-	-	R32	2.60k	(91.7)	-		
Product dimension	Height	mm(inch)	235 (9-1/4)			996 (39- 7/32)			-		
	Width	mm(inch)	960 (37-25/32)			980 (38-37/64)			-		
	Depth	mm(inch)	690 (27-5/32)			370 (14- 9/16)			-		
Product dimension (Panel)		H×W×D mm, inch	-			-			-		
Packing dimension	Height	mm(inch)	360 (14-11/64)			1134 (44-41/64)			-		
	Width	mm(inch)	1025 (40-23/64)			1095 (43-7/64)			-		
	Depth	mm(inch)	820 (32-9/32)			529 (20-53/64)			-		
Weight	(NET)	kg(lb)	27 (60)			90 (199)			-		
	(GROSS)	kg(lb)	34 (75)			98 (216)			-		
	Panel (NET)	kg(lb)	-			-			-		
Layers limit (actually)		9 (10)			2 (3)			-			
Operation condition	Cool (DBT)	18°C ~ 32°C			-10°C ~ 43°C			-			
	Heat (DBT)	16°C ~ 30°C			-15°C ~ 24°C			-			
MAX WORKING PRESSURE HP/LP MPa (bar)		4.15/2.55 (41.5/25.5)			-			-			
P I	Pipe diameter mm (inch)	(Liquid)Ø6.35(1/4) (Gas)Ø12.7(1/2)			(Liquid)Ø9.52(3/8) (Gas)Ø15.88(5/8)			-			
	Connecting method, Standard length m(ft)	flared type, 5.0(16.4)			flared type, 5.0(16.4)			-			
P I	Pipe length range m (ft)	5 ~ 50m (16.4 ~ 164.0)			-			-			
N G	Indoor unit & Outdoor unit height difference m (ft)	15m(OD located lower)/30m(OD located higher) (49.2/98.4)			-			-			
	Add gas amount g/m (oz/ft)	45g/m (0.484)			-			-			
N G	Pipe length for additional gas m (ft)	30m (98.4)			-			-			

\*1 In case it is necessary to indicate the air flow volume in (l/s), the value in (m³/min.) shall be multiplied by 16.7 and rounded down the decimal point.

\*2 If the EUROVENT Certified models can be operated under the "extra-low" temperature condition, -7°C dry bulb and -8°C wet-bulb temperatures with rated voltage 230V shall be used.

\*3 Network Impedance shall be applicable for EUROPE and CHINA models.

\*4 The annual consumption is calculated by multiplying the input power at 230V(400V) by an average of 500 hours per year in cooling mode.

\*5 EER and COP classification is at 230V(400V) only in accordance with EU directive 2002/31/EC.

\*6 SEER and SCOP classification is at 230V(400V) only in accordance with EN-14825. For heating, SCOP indicates the value of only Average heating season, Other fiche data indicates in an attached sheet

# Simultaneous (Twin) -Type

## 1-1. Unit Specifications

**PZ2**

### 2. Ceiling Type S-60PT2E5Bx2 / U-125PZ2E5

INDOOR		MODEL	S-60PT2E5Bx2			-			-		
PANEL		MODEL	-			-			-		
OUTDOOR		MODEL	-			U-125PZ2E5			-		
Branch pipe		MODEL	-			-			-		
Performance test condition					ISO5151 / EN14511 / EN12102 / EN14825						
Power supply		Ø, Hz	1Ø 50Hz			1Ø 50Hz			Min	Max	
		V	220V	230V	240V	220V	230V	240V			
C O O L I N G	Capacity	kW	12.5	12.5	12.5	-	-	-	3.2	13.5	
		BTU/h	42700	42700	42700	-	-	-	10900	46100	
	Current	A	0.42x2	0.41x2	0.40x2	17.7	16.9	16.2	-	-	
		W	50x2	50x2	50x2	3.660k	3.660k	3.660k	-	-	
	Input power	TOTAL W	-			3.760k	3.760k	3.760k	600	4.880k	
		Annual consumption	TOTAL kWh **	-			-	1880	-	-	-
	EER/EER CLASS	TOTAL (W/W) <sup>1)</sup> ("A"-~"G")	-			3.32	3.32/A	3.32	5.33	2.77	
	Erp <sup>6)</sup>	Pdesign	kW	-	-	-	-	12.5	-	-	-
		η <sub>s.c</sub>	%	-	-	-	-	241.4	-	-	-
		Annual consumption	kWh	-	-	-	-	-	-	-	-
Class			-	-	-	-	-	-	-	-	
Power factor	%	-	-	-	94	94	94	-	-		
Noise indoor	dB-A (H/M/L)	38x2/34x2/30x2			-			-	-		
	Power Level dB	56x2/52x2/48x2			-			-	-		
Noise outdoor	dB-A (H/L)	-			55/-			-	-		
	Power Level dB	-			73/-			-	-		
H E A T I N G	Capacity	kW	12.5	12.5	12.5	-	-	-	3.3	15.0	
		BTU/h	42700	42700	42700	-	-	-	11300	51200	
	Current	A	0.42x2	0.41x2	0.40x2	15.0	14.4	13.8	-	-	
		W	50x2	50x2	50x2	3.110k	3.110k	3.110k	-	-	
	Input power	TOTAL W	-			3.210k	3.210k	3.210k	730	4.400k	
		COP/COP CLASS	TOTAL (W/W) <sup>1)</sup> ("A"-~"G")	-			3.89	3.89/A	3.89	4.52	3.41
	Erp <sup>6)</sup>	Pdesign at -10°C	kW	-	-	-	-	12.5	-	-	-
		Tbivalent	°C	-	-	-	-	-7	-	-	-
		η <sub>s.h</sub>	%	-	-	-	-	147.6	-	-	-
		Annual consumption	kWh	-	-	-	-	-	-	-	-
elbu(-10°C)		kW	-	-	-	-	2.90	-	-	-	
Class			-	-	-	-	-	-	-	-	
Power factor	%	-	-	-	94	94	94	-	-		
Noise indoor	dB-A (H/M/L)	38x2/34x2/30x2			-			-	-		
	Power Level dB	56v2/52v2/48x2			-			-	-		
Noise outdoor	dB-A (H/L)	-			55/-			-	-		
	Power Level dB	-			73/-			-	-		
EXTRA LOW TEMP Total capacity(kW) / Input power(W) / COP											
Max Current(A) / Max Input power(W)		0.42x2/50x2	0.41x2/50x2	0.40x2/50x2	29.0/6.00k	29.0/6.30k	29.0/6.60k				
Starting current(A) (Cooling/Heating)		-	-	-	17.7/15.0	16.9/14.4	16.2/13.8				
Comp output(W)						2.80k	2.80k	2.80k			
Network Impedance(ΩMAX.)											
Fan motor output (Indoor/Outdoor) W				74		120					
Moisture removal volume		L/h(Pt/h)	6.8	(3.4x2)	(14.3)						
External static pressure		Pa									
Indoor	Cooling	m³/min (ft³/min)	20.0x2/17.0x2/14.5x2 (706x2)/(600x2)/(512x2)						-	-	
	Heating	m³/min (ft³/min)	20.0x2/17.0x2/14.5x2 (706x2)/(600x2)/(512x2)						-	-	
Outdoor	Cooling	m³/min (ft³/min)				86.0 (3037)			-	-	
	Heating	m³/min (ft³/min)				78.0 (2754)			-	-	
Refrigerant type / amount (g/oz)						R32	2.98k	(105.1)			
Product dimension	Height	mm(inch)	235 (9-1/4)			996 (39- 7/32)					
	Width	mm(inch)	1275 (50-3/16)			980 (38-37/64)					
	Depth	mm(inch)	690 (27-5/32)			370 (14- 9/16)					
Product dimension (Panel)		HxWxD mm, inch									
Packing dimension	Height	mm(inch)	360 (14-11/64)			1134 (44-41/64)					
	Width	mm(inch)	1340 (52-3/4)			1095 (43-7/64)					
	Depth	mm(inch)	820 (32-9/32)			529 (20-53/64)					
Weight	(NET)	kg(lb)	33 (73)			94 (207)					
	(GROSS)	kg(lb)	42 (93)			102 (224)					
	Panel (NET)	kg(lb)	-			-					
Layers limit (actually)				9 (10)		2 (3)					
Operation condition	Cool (DBT)	18°C ~ 32°C			-10°C ~ 43°C						
	Heat (DBT)	16°C ~ 30°C			-15°C ~ 24°C						
MAX WORKING PRESSURE HP/LP MPa (bar)						4.15/2.55 (41.5/25.5)					
P I P I N G	Pipe diameter mm (inch)	(Liquid)Ø9.52(3/8) (Gas)Ø15.88(5/8)			(Liquid)Ø9.52(3/8) (Gas)Ø15.88(5/8)						
	Connecting method, Standard length m(ft)	flared type, 5.0(16.4)			flared type, 5.0(16.4)						
Pipe length range m (ft)				5 ~ 50m (16.4 ~ 164.0)							
Indoor unit & Outdoor unit height difference m (ft)				15m(OD located lower)/30m(OD located higher) (49.2/98.4)							
Add gas amount g/m (oz/ft)				45g/m (0.484)							
Pipe length for additional gas m (ft)				30m (98.4)							

\*1 In case it is necessary to indicate the air flow volume in (l/s), the value in (m³/min.) shall be multiplied by 16.7 and rounded down the decimal point.  
 \*2 If the EUROVENT Certified models can be operated under the "extra-low" temperature condition, -7°C dry bulb and -8°C wet-bulb temperatures with rated voltage 230V shall be used.  
 \*3 Network Impedance shall be applicable for EUROPE and CHINA models.  
 \*4 The annual consumption is calculated by multiplying the input power at 230V(400V) by an average of 500 hours per year in cooling mode.  
 \*5 EER and COP classification is at 230V(400V) only in accordance with EU directive 2002/31/EC.  
 \*6 η<sub>s.c</sub> and η<sub>s.h</sub> classification is at 230V(400V) only in accordance with EN-14825. For heating, η<sub>s.h</sub> indicates the value of only Average heating season.

# 1 Simultaneous (Twin) -Type

## 1-1. Unit Specifications

**PZ2**

## 2. Ceiling Type S-71PT2E5Bx2 / U-140PZ2E5

INDOOR		MODEL	S-71PT2E5Bx2			-			-		
PANEL		MODEL	-			-			-		
OUTDOOR		MODEL	-			U-140PZ2E5			-		
Branch pipe		MODEL	-			-			-		
Performance test condition					ISO5151 / EN14511 / EN12102 / EN14825						
Power supply		Ø, Hz	1Ø 50Hz			1Ø 50Hz			Min	Max	
		V	220V	230V	240V	220V	230V	240V			
C O L I N G	Capacity	kW	14.0	14.0	14.0	-	-	-	3.3	15.0	
		BTU/h	47800	47800	47800	-	-	-	11300	51200	
	Current	A	0.45x2	0.44x2	0.43x2	22.1	21.2	20.3	-	-	
		W	55x2	55x2	552	4.590k	4.590k	4.590k	-	-	
	Input power	TOTAL W	-			4.700k	4.700k	4.700k	620	5.500k	
		Annual consumption	TOTAL kWh**	-			-	2350	-	-	-
	EER/EER CLASS	TOTAL (W/W) <sup>1/2</sup> ("A"-°G)	-	-	-	2.98	2.98/C	2.98	5.32	2.73	
	Erp <sup>6</sup>	Pdesign	kW	-	-	-	-	14.0	-	-	-
		η <sub>s.c</sub>	%	-	-	-	-	227.5	-	-	-
		Annual consumption	kWh	-	-	-	-	-	-	-	-
		Class		-	-	-	-	-	-	-	-
	Power factor	%	-	-	-	94	94	94	-	-	
	Noise indoor	dB-A (H/M/L)	39x2/35x2/31x2			-			-	-	
		Power Level dB	57x2/53x2/49x2			-			-	-	
Noise outdoor	dB-A (H/L)	-			56/-			-	-		
	Power Level dB	-			74/-			-	-		
H E A T I N G	Capacity	kW	14.0	14.0	14.0	-	-	-	3.4	16.0	
		BTU/h	47800	47800	47800	-	-	-	11600	54600	
	Current	A	0.45x2	0.44x2	0.43x2	17.8	17.0	16.3	-	-	
		W	55x2	55x2	55x2	3.670k	3.670k	3.670k	-	-	
	Input power	TOTAL W	-			3.780k	3.780k	3.780k	620	5.200k	
		COP/COP CLASS	TOTAL (W/W) <sup>1/2</sup> ("A"-°G)	-	-	-	3.70	3.70/A	3.70	5.48	3.08
	Erp <sup>6</sup>	Pdesign at -10°C	kW	-	-	-	-	13.6	-	-	-
		Tbivalent	°C	-	-	-	-	-7	-	-	-
		η <sub>s.h</sub>	%	-	-	-	-	145.4	-	-	-
		Annual consumption	kWh	-	-	-	-	-	-	-	-
		elbu(-10°C)	kW	-	-	-	-	3.20	-	-	-
		Class		-	-	-	-	-	-	-	-
	Power factor	%	-	-	-	94	94	94	-	-	
	Noise indoor	dB-A (H/M/L)	39x2/35x2/31x2			-			-	-	
Power Level dB		57x2/53x2/49x2			-			-	-		
Noise outdoor	dB-A (H/L)	-			56/-			-	-		
	Power Level dB	-			74/-			-	-		
EXTRA LOW TEMP Total capacity(kW) / Input power(W) / COP											
Max Current(A) / Max Input power(W)		0.45x2/55x2	0.44x2/55x2	0.43x2/55x2	30.0/6.25k	30.0/6.50k	30.0/6.80k				
Starting current(A) (Cooling/Heating)		-	-	-	22.1/17.8	21.2/17.0	20.3/16.3				
Comp output(W)						3.00k	3.00k	3.00k			
Network Impedance(ΩMAX.)											
Fan motor output (Indoor/Outdoor) W				74		120					
Moisture removal volume		L/h(Pt/h)	8.4	(4.2x2)	(17.6)						
External static pressure		Pa									
Indoor	Cooling	m³/min (ft³/min)	21.0x2/18.0x2/15.5x2 (742x2)/(636x2)/(547x2)						-	-	
	Heating	m³/min (ft³/min)	21.0x2/18.0x2/15.5x2 (742x2)/(636x2)/(547x2)						-	-	
Outdoor	Cooling	m³/min (ft³/min)	-			89.0 (3143)			-	-	
	Heating	m³/min (ft³/min)	-			83.0 (2931)			-	-	
Refrigerant type / amount (g/oz)						R32	2.98k	(105.1)			
Product dimension	Height	mm(inch)	235 (9-1/4)			996 (39-7/32)					
	Width	mm(inch)	1275 (50-3/16)			980 (38-37/64)					
	Depth	mm(inch)	690 (27-5/32)			370 (14-9/16)					
Product dimension (Panel)		HxWxD mm, inch	-			-					
Packing dimension	Height	mm(inch)	360 (14-11/64)			1134 (44-41/64)					
	Width	mm(inch)	1340 (52-3/4)			1095 (43-7/64)					
	Depth	mm(inch)	820 (32-9/32)			529 (20-53/64)					
Weight	(NET)	kg(lb)	33 (73)			94 (207)					
	(GROSS)	kg(lb)	42 (93)			102 (224)					
	Panel (NET)	kg(lb)	-			-					
Layers limit (actually)				9 (10)		2 (3)					
Operation condition	Cool (DBT)	18°C ~ 32°C			-10°C ~ 43°C						
	Heat (DBT)	16°C ~ 30°C			-15°C ~ 24°C						
MAX WORKING PRESSURE HP/LP MPa (bar)						4.15/2.55 (41.5/25.5)					
P	Pipe diameter mm (inch)	(Liquid)Ø9.52(3/8) (Gas)Ø15.88(5/8)			(Liquid)Ø9.52(3/8) (Gas)Ø15.88(5/8)						
	Connecting method, Standard length m(ft)	flared type, 5.0(16.4)			flared type, 5.0(16.4)						
P	Pipe length range m (ft)	5 ~ 50m (16.4 ~ 164.0)									
I	Indoor unit & Outdoor unit height difference m (ft)	15m(OD located lower)/30m(OD located higher) (49.2/98.4)									
N	Add gas amount g/m (oz/ft)	45g/m (0.484)									
G	Pipe length for additional gas m (ft)	30m (98.4)									

\*1 In case it is necessary to indicate the air flow volume in (l/s), the value in (m³/min.) shall be multiplied by 16.7 and rounded down the decimal point.

\*2 If the EUROVENT Certified models can be operated under the "extra-low" temperature condition, -7°C dry bulb and -8°C wet-bulb temperatures with rated voltage 230V shall be used.

\*3 Network Impedance shall be applicable for EUROPE and CHINA models.

\*4 The annual consumption is calculated by multiplying the input power at 230V(400V) by an average of 500 hours per year in cooling mode.

\*5 EER and COP classification is at 230V(400V) only in accordance with EU directive 2002/31/EC.

\*6 η<sub>s.c</sub> and η<sub>s.h</sub> classification is at 230V(400V) only in accordance with EN-14825. For heating, η<sub>s.h</sub> indicates the value of only Average heating season.

# Single -Type

## 1-1. Unit Specifications

PZ2

### 2. Ceiling Type S-100PT2E5B / U-100PZ2E5

INDOOR		MODEL	S-100PT2E5B			-			-	
PANEL		MODEL	-			-			-	
OUTDOOR		MODEL	-			U-100PZ2E5			-	
Branch pipe		MODEL	-			-			-	
Performance test condition					ISO5151 / EN14511 / EN12102 / EN14825					
Power supply		Ø, Hz	1Ø 50Hz			1Ø 50Hz			Min	Max
		V	220V	230V	240V	220V	230V	240V		
C O L I N G	Capacity	kW	10.0	10.0	10.0	-	-	-	3.0	11.5
		BTU/h	34100	34100	34100	-	-	-	10200	39200
	Current	A	0.69	0.67	0.65	12.8	12.2	11.7	-	-
		W	80	80	80	2.670k	2.670k	2.670k	-	-
	Input power	TOTAL W	-	-	-	2.750k	2.750k	2.750k	560	4.100k
		TOTAL kWh **	-	-	-	-	1375	-	-	-
	Annual consumption	TOTAL kWh **	-	-	-	-	1375	-	-	-
	EER/EEER CLASS	TOTAL (W/W) <sup>1)</sup> ("A"-~"G")	-	-	-	3.64	3.64/A	3.64	5.36	2.80
	Erp <sup>5)</sup>	Pdesign	kW	-	-	-	-	10.0	-	-
		SEER	(W/W)	-	-	-	-	6.5	-	-
		Annual consumption	kWh	-	-	-	-	535	-	-
		Class		-	-	-	-	A++	-	-
	Power factor	%	-	-	-	95	95	95	-	-
	Noise indoor	dB-A (H/M/L)	42/37/35			-			-	-
Power Level dB		60/55/53			-			-	-	
Noise outdoor	dB-A (H/L)	-			52/-			-	-	
	Power Level dB	-			70/-			-	-	
H E A T I N G	Capacity	kW	10.0	10.0	10.0	-	-	-	3.0	14.0
		BTU/h	34100	34100	34100	-	-	-	10200	47800
	Current	A	0.69	0.67	0.65	10.9	10.4	10.0	-	-
		W	80	80	80	2.280k	2.280k	2.280k	-	-
	Input power	TOTAL W	-	-	-	2.360k	2.360k	2.360k	560	4.000k
		TOTAL kWh **	-	-	-	-	4.24	4.24/A	4.24	5.36
	COP/COP CLASS	TOTAL (W/W) <sup>1)</sup> ("A"-~"G")	-	-	-	4.24	4.24/A	4.24	5.36	3.50
	Erp <sup>5)</sup>	Pdesign at -10°C	kW	-	-	-	-	10.0	-	-
		Tbivalent	°C	-	-	-	-	-7	-	-
		SCOP	(W/W)	-	-	-	-	4.2	-	-
		Annual consumption	kWh	-	-	-	-	3324	-	-
	Class	elbu(-10°C)	kW	-	-	-	-	2.07	-	-
				-	-	-	-	A+	-	-
	Power factor	%	-	-	-	95	95	95	-	-
Noise indoor	dB-A (H/M/L)	42/37/35			-			-	-	
	Power Level dB	60/55/53			-			-	-	
Noise outdoor	dB-A (H/L)	-			52/-			-	-	
	Power Level dB	-			70/-			-	-	
EXTRA LOW TEMP   Total capacity(kW) / Input power(W) / COP										
Max Current(A) / Max Input power(W)			0.69/80	0.67/80	0.65/80	25.0/5.25k	25.0/5.50k	25.0/5.70k	-	
Starting current(A) (Cooling/Heating)			-	-	-	12.8/10.9	12.2/10.4	11.7/10.0	-	
Comp output(W)			-			2.50k	2.50k	2.50k	-	
Network Impedance(ΩMAX.)			-			-			-	
Fan motor output (Indoor/Outdoor) W			111			120			-	
Moisture removal volume		L/h(Pt/h)	6.0	(12.6)		-			-	
External static pressure		Pa	-			-			-	
Indoor Air flow	Cooling	m³/min (ft³/min)	30.0/25.0/23.0 (1059)/(883)/(812)			-			-	
	Heating	m³/min (ft³/min)	30.0/25.0/23.0 (1059)/(883)/(812)			-			-	
Outdoor Air flow	Cooling	m³/min (ft³/min)	-			76.0 (2683)			-	
	Heating	m³/min (ft³/min)	-			70.0 (2472)			-	
Refrigerant type / amount g(oz)			-			R32	2.60k	(91.7)	-	
Product dimension	Height	mm(inch)	235 (9-1/4)			996 (39- 7/32)			-	
	Width	mm(inch)	1590 (62-19/32)			980 (38-37/64)			-	
	Depth	mm(inch)	690 (27-5/32)			370 (14- 9/16)			-	
Product dimension (Panel)		H×W×D mm, inch	-			-			-	
Packing dimension	Height	mm(inch)	360 (14-11/64)			1134 (44-41/64)			-	
	Width	mm(inch)	1655 (65-5/32)			1095 (43-7/64)			-	
	Depth	mm(inch)	820 (32-9/32)			529 (20-53/64)			-	
Weight	(NET)	kg(lb)	40 (88)			90 (199)			-	
	(GROSS)	kg(lb)	49 (108)			98 (216)			-	
	Panel (NET)	kg(lb)	-			-			-	
Layers limit (actually)			9 (10)			2 (3)			-	
Operation condition	Cool (DBT)		18°C ~ 32°C			-10°C ~ 43°C			-	
	Heat (DBT)		16°C ~ 30°C			-15°C ~ 24°C			-	
MAX WORKING PRESSURE HP/LP MPa (bar)			4.15/2.55 (41.5/25.5)			-			-	
P I	Pipe diameter mm (inch)		(Liquid)Ø9.52(3/8) (Gas)Ø15.88(5/8)			(Liquid)Ø9.52(3/8) (Gas)Ø15.88(5/8)			-	
	Connecting method, Standard length m(ft)		flared type, 5.0(16.4)			flared type, 5.0(16.4)			-	
P I	Pipe length range m (ft)		5 ~ 50m (16.4 ~ 164.0)			-			-	
N G	Indoor unit & Outdoor unit height difference m (ft)		15m(OD located lower)/30m(OD located higher) (49.2/98.4)			-			-	
	Add gas amount g/m (oz/ft)		45g/m (0.484)			-			-	
N G	Pipe length for additional gas m (ft)		30m (98.4)			-			-	

\*1 In case it is necessary to indicate the air flow volume in (l/s), the value in (m³/min.) shall be multiplied by 16.7 and rounded down the decimal point.  
 \*2 If the EUROVENT Certified models can be operated under the "extra-low" temperature condition, -7°C dry bulb and -8°C wet-bulb temperatures with rated voltage 230V shall be used.  
 \*3 Network Impedance shall be applicable for EUROPE and CHINA models.  
 \*4 The annual consumption is calculated by multiplying the input power at 230V(400V) by an average of 500 hours per year in cooling mode.  
 \*5 EER and COP classification is at 230V(400V) only in accordance with EU directive 2002/31/EC.  
 \*6 SEER and SCOP classification is at 230V(400V) only in accordance with EN-14825. For heating, SCOP indicates the value of only Average heating season, Other fiche data indicates in an attached sheet

# Single -Type

## 1-1. Unit Specifications

**PZ2**

## 2. Ceiling Type S-125PT2E5B / U-125PZ2E5

INDOOR		MODEL	S-125PT2E5B			-			-		
PANEL		MODEL	-			-			-		
OUTDOOR		MODEL	-			U-125PZ2E5			-		
Branch pipe		MODEL	-			-			-		
Performance test condition					ISO5151 / EN14511 / EN12102 / EN14825						
Power supply		Ø, Hz	1Ø 50Hz			1Ø 50Hz			Min	Max	
		V	220V	230V	240V	220V	230V	240V			
C O O L I N G	Capacity	kW	12.5	12.5	12.5	-	-	-	3.2	13.5	
		BTU/h	42700	42700	42700	-	-	-	10900	46100	
	Current	A	0.89	0.86	0.83	17.6	16.9	16.2	-	-	
		W	110	110	110	3.650k	3.650k	3.650k	-	-	
	Input power	TOTAL W	-	-	-	3.760k	3.760k	3.760k	600	4.880k	
		Annual consumption	TOTAL kWh **	-	-	-	-	1880	-	-	-
	EER/EER CLASS	TOTAL (W/W) <sup>1)</sup> ("A"~"G")	-	-	-	3.32	3.32/A	3.32	5.33	2.77	
	Erp <sup>5)</sup>	P <sub>design</sub>	kW	-	-	-	-	12.5	-	-	-
		η <sub>s.c</sub>	%	-	-	-	-	227.8	-	-	-
		Annual consumption	kWh	-	-	-	-	-	-	-	-
		Class		-	-	-	-	-	-	-	-
	Power factor	%	-	-	-	94	94	94	-	-	
	Noise indoor	dB-A (H/M/L)	46/40/36			-			-	-	
		Power Level dB	64/58/54			-			-	-	
Noise outdoor	dB-A (H/L)	-			55/-			-	-		
	Power Level dB	-			73/-			-	-		
H E A T I N G	Capacity	kW	12.5	12.5	12.5	-	-	-	3.3	15.0	
		BTU/h	42700	42700	42700	-	-	-	11300	51200	
	Current	A	0.89	0.86	0.83	15.0	14.3	13.7	-	-	
		W	110	110	110	3.100k	3.100k	3.100k	-	-	
	Input power	TOTAL W	-	-	-	3.210k	3.210k	3.210k	730	4.400k	
		COP/COP CLASS	TOTAL (W/W) <sup>1)</sup> ("A"~"G")	-	-	-	3.89	3.89/A	3.89	4.52	3.41
	Erp <sup>5)</sup>	P <sub>design</sub> at -10°C	kW	-	-	-	-	12.5	-	-	-
		T <sub>bivalent</sub>	°C	-	-	-	-	-7	-	-	-
		η <sub>s.h</sub>	%	-	-	-	-	146.9	-	-	-
		Annual consumption	kWh	-	-	-	-	-	-	-	-
		elbu(-10°C)	kW	-	-	-	-	2.70	-	-	-
		Class		-	-	-	-	-	-	-	-
	Power factor	%	-	-	-	94	94	94	-	-	
	Noise indoor	dB-A (H/M/L)	46/40/36			-			-	-	
Power Level dB		64/58/54			-			-	-		
Noise outdoor	dB-A (H/L)	-			55/-			-	-		
	Power Level dB	-			73/-			-	-		
EXTRA LOW TEMP Total capacity(kW) / Input power(W) / COP											
Max Current(A) / Max Input power(W)		0.89/110	0.86/110	0.83/110	29.0/6.00k	29.0/6.30k	29.0/6.60k				
Starting current(A) (Cooling/Heating)		-	-	-	17.6/15.0	16.9/14.3	16.2/13.7				
Comp output(W)						2.80k	2.80k	2.80k			
Network Impedance(ΩMAX.)											
Fan motor output (Indoor/Outdoor) W				111		120					
Moisture removal volume		L/h(Pt/h)	7.9	(16.6)							
External static pressure		Pa									
Indoor Air flow	Cooling	m <sup>3</sup> /min (ft <sup>3</sup> /min)	34.0/28.0/24.0 (1201)/(989)/(848)						-	-	
	Heating	m <sup>3</sup> /min (ft <sup>3</sup> /min)	34.0/28.0/24.0 (1201)/(989)/(848)						-	-	
Outdoor Air flow	Cooling	m <sup>3</sup> /min (ft <sup>3</sup> /min)				86.0 (3037)			-	-	
	Heating	m <sup>3</sup> /min (ft <sup>3</sup> /min)				78.0 (2754)			-	-	
Refrigerant type / amount g(oz)						R32	2.98k	(105.1)			
Product dimension	Height	mm(inch)	235 (9-1/4)			996 (39- 7/32)					
	Width	mm(inch)	1590 (62-19/32)			980 (38-37/64)					
	Depth	mm(inch)	690 (27-5/32)			370 (14- 9/16)					
Product dimension (Panel)		H×W×D mm, inch									
Packing dimension	Height	mm(inch)	360 (14-11/64)			1134 (44-41/64)					
	Width	mm(inch)	1655 (65-5/32)			1095 (43-7/64)					
	Depth	mm(inch)	820 (32-9/32)			529 (20-53/64)					
Weight	(NET)	kg(lb)	40 (88)			94 (207)					
	(GROSS)	kg(lb)	49 (108)			102 (224)					
	Panel (NET)	kg(lb)									
Layers limit (actually)				9 (10)		2 (3)					
Operation condition	Cool (DBT)	18°C ~ 32°C			-10°C ~ 43°C						
	Heat (DBT)	16°C ~ 30°C			-15°C ~ 24°C						
MAX WORKING PRESSURE HP/LP MPa (bar)						4.15/2.55 (41.5/25.5)					
P I	Pipe diameter mm (inch)	(Liquid)Ø9.52(3/8) (Gas)Ø15.88(5/8)			(Liquid)Ø9.52(3/8) (Gas)Ø15.88(5/8)						
	Connecting method, Standard length m(ft)	flared type, 5.0(16.4)			flared type, 5.0(16.4)						
P I	Pipe length range m (ft)				5 ~ 50m (16.4 ~ 164.0)						
N I	Indoor unit & Outdoor unit height difference m (ft)				15m(OD located lower)/30m(OD located higher) (49.2/98.4)						
N G	Add gas amount g/m (oz/ft)				45g/m (0.484)						
	Pipe length for additional gas m (ft)				30m (98.4)						

\*1 In case it is necessary to indicate the air flow volume in (l/s), the value in (m<sup>3</sup>/min.) shall be multiplied by 16.7 and rounded down the decimal point.

\*2 If the EUROVENT Certified models can be operated under the "extra-low" temperature condition, -7°C dry bulb and -8°C wet-bulb temperatures with rated voltage 230V shall be used.

\*3 Network Impedance shall be applicable for EUROPE and CHINA models.

\*4 The annual consumption is calculated by multiplying the input power at 230V(400V) by an average of 500 hours per year in cooling mode.

\*5 EER and COP classification is at 230V(400V) only in accordance with EU directive 2002/31/EC.

\*6 η<sub>s.c</sub> and η<sub>s.h</sub> classification is at 230V(400V) only in accordance with EN-14825. For heating, η<sub>s.h</sub> indicates the value of only Average heating season.



# Single -Type

## 1-1. Unit Specifications

PZ2

### 2. Ceiling Type S-140PT2E5B / U-140PZ2E5

INDOOR	MODEL	S-140PT2E5B			-			-		
PANEL	MODEL	-			-			-		
OUTDOOR	MODEL	-			U-140PZ2E5			-		
Branch pipe	MODEL	-			-			-		
Performance test condition		ISO5151 / EN14511 / EN12102 / EN14825								
Power supply		Ø, Hz	1Ø 50Hz			1Ø 50Hz			Min	Max
		V	220V	230V	240V	220V	230V	240V		
C O O L I N G	Capacity	kW	14.0	14.0	14.0	-	-	-	3.3	15.0
		BTU/h	47800	47800	47800	-	-	-	11300	51200
	Current	A	0.94	0.91	0.88	22.1	21.2	20.3	-	-
		W	120	120	120	4.580k	4.580k	4.580k	-	-
	Input power	TOTAL W	-			4.700k	4.700k	4.700k	620	5.500k
		TOTAL kWh **	-			-	2350	-	-	-
	EER/EER CLASS	TOTAL (W/W) <sup>1)</sup> ("A"~"G")	-	-	-	2.98	2.98/C	2.98	5.32	2.73
	Erp <sup>5)</sup>	Pdesign	kW	-	-	-	-	14.0	-	-
		η <sub>s.c</sub>	%	-	-	-	-	216.6	-	-
		Annual consumption	kWh	-	-	-	-	-	-	-
		Class		-	-	-	-	-	-	-
	Power factor	%	-	-	-	94	94	94	-	-
	Noise indoor	dB-A (H/M/L)	47/41/37			-			-	-
		Power Level dB	65/59/55			-			-	-
	Noise outdoor	dB-A (H/L)	-			56/-			-	-
Power Level dB		-			74/-			-	-	
H E A T I N G	Capacity	kW	14.0	14.0	14.0	-	-	-	3.4	16.0
		BTU/h	47800	47800	47800	-	-	-	11600	54600
	Current	A	0.94	0.91	0.88	17.7	16.9	16.2	-	-
		W	120	120	120	3.660k	3.660k	3.660k	-	-
	Input power	TOTAL W	-			3.780k	3.780k	3.780k	620	5.200k
		TOTAL (W/W) <sup>1)</sup> ("A"~"G")	-	-	-	3.70	3.70/A	3.70	5.48	3.08
	Erp <sup>5)</sup>	Pdesign at -10°C	kW	-	-	-	-	13.6	-	-
		Tbivalent	°C	-	-	-	-	-7	-	-
		η <sub>s.h</sub>	%	-	-	-	-	144.8	-	-
		Annual consumption	kWh	-	-	-	-	-	-	-
		elbu(-10°C)	kW	-	-	-	-	3.00	-	-
	Class		-	-	-	-	-	-	-	
	Power factor	%	-	-	-	94	94	94	-	-
	Noise indoor	dB-A (H/M/L)	47/41/37			-			-	-
		Power Level dB	65/59/55			-			-	-
Noise outdoor	dB-A (H/L)	-			56/-			-	-	
	Power Level dB	-			74/-			-	-	
EXTRA LOW TEMP Total capacity(kW) / Input power(W) / COP		-			-			-		
Max Current(A) / Max Input power(W)		0.94/120	0.91/120	0.88/120	30.0/6.25k	30.0/6.50k	30.0/6.80k	-		
Starting current(A) (Cooling/Heating)		-	-	-	22.1/17.7	21.2/16.9	20.3/16.2	-		
Comp output(W)		-			3.00k	3.00k	3.00k	-		
Network Impedance(ΩMAX.)		-			-			-		
Fan motor output (Indoor/Outdoor) W		111			120			-		
Moisture removal volume		L/h(Pt/h)	9.0	(18.9)	-			-		
External static pressure		Pa	-			-			-	
Indoor Air flow	Cooling	m³/min (ft³/min)	35.0/29.0/25.0 (1236)/(1024)/(883)			-			-	-
	Heating	m³/min (ft³/min)	35.0/29.0/25.0 (1236)/(1024)/(883)			-			-	-
Outdoor Air flow	Cooling	m³/min (ft³/min)	-			89.0 (3143)			-	-
	Heating	m³/min (ft³/min)	-			83.0 (2931)			-	-
Refrigerant type / amount g(oz)		-			R32	2.98k	(105.1)	-		
Product dimension	Height	mm(inch)	235 (9-1/4)			996 (39- 7/32)			-	
	Width	mm(inch)	1590 (62-19/32)			980 (38-37/64)			-	
	Depth	mm(inch)	690 (27-5/32)			370 (14- 9/16)			-	
Product dimension (Panel)		H×W×D mm, inch	-			-			-	
Packing dimension	Height	mm(inch)	360 (14-11/64)			1134 (44-41/64)			-	
	Width	mm(inch)	1655 (65-5/32)			1095 (43-7/64)			-	
	Depth	mm(inch)	820 (32-9/32)			529 (20-53/64)			-	
Weight	(NET)	kg(lb)	40 (88)			94 (207)			-	
	(GROSS)	kg(lb)	49 (108)			102 (224)			-	
	Panel (NET)	kg(lb)	-			-			-	
Layers limit (actually)		9 (10)			2 (3)			-		
Operation condition	Cool (DBT)	18°C ~ 32°C			-10°C ~ 43°C			-		
	Heat (DBT)	16°C ~ 30°C			-15°C ~ 24°C			-		
MAX WORKING PRESSURE HP/LP MPa (bar)		4.15/2.55 (41.5/25.5)								
P I	Pipe diameter mm (inch)	(Liquid)Ø9.52(3/8) (Gas)Ø15.88(5/8)			(Liquid)Ø9.52(3/8) (Gas)Ø15.88(5/8)			-		
	Connecting method, Standard length m(ft)	flared type, 5.0(16.4)			flared type, 5.0(16.4)			-		
P I	Pipe length range m (ft)	5 ~ 50m (16.4 ~ 164.0)								
N I	Indoor unit & Outdoor unit height difference m (ft)	15m(OD located lower)/30m(OD located higher) (49.2/98.4)								
N G	Add gas amount g/m (oz/ft)	45g/m (0.484)								
	Pipe length for additional gas m (ft)	30m (98.4)								

\*1 In case it is necessary to indicate the air flow volume in (l/s), the value in (m³/min.) shall be multiplied by 16.7 and rounded down the decimal point.  
 \*2 If the EUROVENT Certified models can be operated under the "extra-low" temperature condition, -7°C dry bulb and -8°C wet-bulb temperatures with rated voltage 230V shall be used.  
 \*3 Network Impedance shall be applicable for EUROPE and CHINA models.  
 \*4 The annual consumption is calculated by multiplying the input power at 230V(400V) by an average of 500 hours per year in cooling mode.  
 \*5 EER and COP classification is at 230V(400V) only in accordance with EU directive 2002/31/EC.  
 \*6 η<sub>s.c</sub> and η<sub>s.h</sub> classification is at 230V(400V) only in accordance with EN-14825. For heating, η<sub>s.h</sub> indicates the value of only Average heating season.

# Simultaneous (Twin) -Type

## 1-1. Unit Specifications

**PZ2**

### 2. Ceiling Type S-50PT2E5Bx2 / U-100PZ2E8

INDOOR		MODEL	S-50PT2E5Bx2			-			-	
PANEL		MODEL	-			-			-	
OUTDOOR		MODEL	-			U-100PZ2E8			-	
Branch pipe		MODEL	-			-			-	
Performance test condition					ISO5151 / EN14511 / EN12102 / EN14825					
Power supply		Ø, Hz	1Ø 50Hz			3Ø 50Hz			Min	Max
		V	220V	230V	240V	380V	400V	415V		
C O L I N G	Capacity	kW	10.0	10.0	10.0	-	-	-	3.0	11.5
		BTU/h	34100	34100	34100	-	-	-	10200	39200
	Current	A	0.39x2	0.38x2	0.37x2	4.35	4.15	4.00	-	-
		W	40x2	40x2	40x2	2.670k	2.670k	2.670k	-	-
	Input power	TOTAL W	-	-	-	2.750k	2.750k	2.750k	560	4.100k
		TOTAL kWh <sup>*4</sup>	-	-	-	-	1375	-	-	-
	Annual consumption	TOTAL kWh <sup>*4</sup>	-	-	-	-	1375	-	-	-
	EER/EER CLASS	TOTAL (W/W) <sup>*5</sup> ("A"-G)	-	-	-	3.82	3.82/A	3.82	5.36	2.80
	Erp <sup>*6</sup>	Pdesign	kW	-	-	-	-	10.0	-	-
		SEER	(W/W)	-	-	-	-	6.3	-	-
		Annual consumption	kWh	-	-	-	-	554	-	-
		Class		-	-	-	-	A++	-	-
	Power factor	%	-	-	-	93	93	93	-	-
	Noise indoor	dB-A (H/M/L)	37x2/33x2/29x2			-			-	-
		Power Level dB	55x2/51x2/47x2			-			-	-
	Noise outdoor	dB-A (H/L)	-			52/-			-	-
Power Level dB		-			70/-			-	-	
H E A T I N G	Capacity	kW	10.0	10.0	10.0	-	-	-	3.0	14.0
		BTU/h	34100	34100	34100	-	-	-	10200	47800
	Current	A	0.39x2	0.38x2	0.37x2	3.70	3.55	3.40	-	-
		W	40x2	40x2	40x2	2.280k	2.280k	2.280k	-	-
	Input power	TOTAL W	-	-	-	2.360k	2.360k	2.360k	560	4.000k
		TOTAL kWh <sup>*4</sup>	-	-	-	-	2360	-	-	-
	COP/COP CLASS	TOTAL (W/W) <sup>*5</sup> ("A"-G)	-	-	-	4.93	4.93/A	4.93	5.36	3.50
	Erp <sup>*6</sup>	Pdesign at -10°C	kW	-	-	-	-	10.0	-	-
		Tbivalent	°C	-	-	-	-	-7	-	-
		SCOP	(W/W)	-	-	-	-	4	-	-
		Annual consumption	kWh	-	-	-	-	3495	-	-
		elbu(-10°C)	kW	-	-	-	-	2.07	-	-
	Class		-	-	-	-	A+	-	-	
	Power factor	%	-	-	-	93	93	93	-	-
	Noise indoor	dB-A (H/M/L)	37x2/33x2/29x2			-			-	-
		Power Level dB	55x2/51x2/47x2			-			-	-
Noise outdoor	dB-A (H/L)	-			52/-			-	-	
	Power Level dB	-			70/-			-	-	
EXTRA LOW TEMP Total capacity(kW) / Input power(W) / COP										
Max Current(A) / Max Input power(W)		0.39x2/80x2		0.38x2/80x2	0.37x2/80x2	9.00/5.55k	9.00/5.80k	9.00/6.05k	-	
Starting current(A) (Cooling/Heating)		-		-	-	4.35/3.70	4.15/3.55	4.00/3.40	-	
Comp output(W)		-		-	-	2.50k	2.50k	2.50k	-	
Network Impedance(ΩMAX.)		-		-	-	-	-	-	-	
Fan motor output (Indoor/Outdoor) W		-		43	-	-	120	-	-	
Moisture removal volume		L/h(Pt/h)		5.6	(2.8x2)	(11.8)	-	-	-	
External static pressure		Pa		-	-	-	-	-	-	
Indoor Air flow	Cooling	m³/min (ft³/min)	15.0x2/12.5x2/10.5x2 (530x2)/(441x2)/(371x2)			-			-	-
	Heating	m³/min (ft³/min)	15.0x2/12.5x2/10.5x2 (530x2)/(441x2)/(371x2)			-			-	-
Outdoor Air flow	Cooling	m³/min (ft³/min)	-			76.0 (2683)			-	-
	Heating	m³/min (ft³/min)	-			70.0 (2472)			-	-
Refrigerant type / amount g(oz)		-		-	-	R32	2.60k	(91.7)	-	
Product dimension	Height	mm(inch)	235 (9-1/4)			996 (39- 7/32)			-	-
	Width	mm(inch)	960 (37-25/32)			980 (38-37/64)			-	-
	Depth	mm(inch)	690 (27-5/32)			370 (14- 9/16)			-	-
Product dimension (Panel)		HxWxD mm, inch		-	-	-	-	-	-	
Packing dimension	Height	mm(inch)	360 (14-11/64)			1134 (44-41/64)			-	-
	Width	mm(inch)	1025 (40-23/64)			1095 (43-7/64)			-	-
	Depth	mm(inch)	820 (32-9/32)			529 (20-53/64)			-	-
Weight	(NET)	kg(lb)	27 (60)			90 (199)			-	-
	(GROSS)	kg(lb)	34 (75)			98 (216)			-	-
	Panel (NET)	kg(lb)	-			-			-	-
	Layers limit (actually)	9 (10)		2 (3)		-		-	-	
Operation condition	Cool (DBT)	18°C ~ 32°C			-10°C ~ 43°C			-	-	
	Heat (DBT)	16°C ~ 30°C			-15°C ~ 24°C			-	-	
MAX WORKING PRESSURE HP/LP MPa (bar)		4.15/2.55		(41.5/25.5)		-		-	-	
P I P I N G	Pipe diameter mm (inch)	(Liquid)Ø6.35(1/4) (Gas)Ø12.7(1/2)			(Liquid)Ø9.52(3/8) (Gas)Ø15.88(5/8)			-	-	
	Connecting method, Standard length m(ft)	flared type, 5.0(16.4)			flared type, 5.0(16.4)			-	-	
Pipe length range m (ft)		5 ~ 50m (16.4 ~ 164.0)		-		-		-	-	
Indoor unit & Outdoor unit height difference m (ft)		15m(OD located lower)/30m(OD located higher) (49.2/98.4)		-		-		-	-	
Add gas amount g/m (oz/ft)		45g/m (0.484)		-		-		-	-	
Pipe length for additional gas m (ft)		30m (98.4)		-		-		-	-	

\*1 In case it is necessary to indicate the air flow volume in (l/s), the value in (m³/min.) shall be multiplied by 16.7 and rounded down the decimal point.

\*2 If the EUROVENT Certified models can be operated under the "extra-low"temperature condition, -7°C dry bulb and -8°C wet-bulb temperatures with rated voltage 230V shall be used.

\*3 Network Impedance shall be applicable for EUROPE and CHINA models.

\*4 The annual consumption is calculated by multiplying the input power at 230V(400V) by an average of 500 hours per year in cooling mode.

\*5 EER and COP classification is at 230V(400V) only in accordance with EU directive 2002/31/EC.

\*6 SEER and SCOP classification is at 230V(400V) only in accordance with EN-14825. For heating, SCOP indicates the value of only Average heating season, Other fiche data indicates in an attached sheet

# Simultaneous (Twin) -Type

## 1-1. Unit Specifications

**PZ2**

### 2. Ceiling Type S-60PT2E5Bx2 / U-125PZ2E8

INDOOR		MODEL	S-60PT2E5Bx2			-			-		
PANEL		MODEL	-			-			-		
OUTDOOR		MODEL	-			U-125PZ2E8			-		
Branch pipe		MODEL	-			-			-		
Performance test condition					ISO5151 / EN14511 / EN12102 / EN14825						
Power supply		Ø, Hz	1Ø 50Hz			3Ø 50Hz			Min	Max	
		V	220V	230V	240V	380V	400V	415V			
C O L I N G	Capacity	kW	12.5	12.5	12.5	-	-	-	3.2	13.5	
		BTU/h	42700	42700	42700	-	-	-	10900	46100	
	Current	A	0.42x2	0.41x2	0.40x2	5.90	5.60	5.40	-	-	
		W	50x2	50x2	50x2	3.660k	3.660k	3.660k	-	-	
	Input power	TOTAL W	-			3.760k	3.760k	3.760k	600	4.880k	
		Annual consumption	TOTAL kWh **	-			-	1880	-	-	-
	EER/EER CLASS	TOTAL (W/W) **/ ("A"- "G")	-	-	-	3.32	3.32/A	3.32	5.33	2.77	
	Erp *6	Pdesign	kW	-	-	-	-	12.5	-	-	-
		η s,c	%	-	-	-	-	240.5	-	-	-
		Annual consumption	kWh	-	-	-	-	-	-	-	-
		Class		-	-	-	-	-	-	-	-
	Power factor	%	-	-	-	94	94	94	-	-	
	Noise indoor	dB-A (H/M/L)	38x2/34x2/30x2			-			-	-	
		Power Level dB	56x2/52x2/48x2			-			-	-	
Noise outdoor	dB-A (H/L)	-			55/-			-	-		
	Power Level dB	-			73/-			-	-		
H E A T I N G	Capacity	kW	12.5	12.5	12.5	-	-	-	3.3	15.0	
		BTU/h	42700	42700	42700	-	-	-	11300	51200	
	Current	A	0.42x2	0.41x2	0.40x2	5.00	4.80	4.60	-	-	
		W	50x2	50x2	50x2	3.110k	3.110k	3.110k	-	-	
	Input power	TOTAL W	-			3.210k	3.210k	3.210k	730	4.400k	
		COP/COP CLASS	TOTAL (W/W) **/ ("A"- "G")	-	-	-	3.89	3.89/A	3.89	4.52	3.41
	Erp *6	Pdesign at -10°C	kW	-	-	-	-	12.5	-	-	-
		Tbivalent	°C	-	-	-	-	-7	-	-	-
		η s,h	%	-	-	-	-	147.6	-	-	-
		Annual consumption	kWh	-	-	-	-	-	-	-	-
		elbu(-10°C)	kW	-	-	-	-	2.90	-	-	-
	Class		-	-	-	-	-	-	-	-	
	Power factor	%	-	-	-	94	94	94	-	-	
	Noise indoor	dB-A (H/M/L)	38x2/34x2/30x2			-			-	-	
Power Level dB		56x2/52x2/48x2			-			-	-		
Noise outdoor	dB-A (H/L)	-			55/-			-	-		
	Power Level dB	-			73/-			-	-		
EXTRA LOW TEMP   Total capacity(kW) / Input power(W) / COP											
Max Current(A) / Max Input power(W)		0.42x2/50x2		0.41x2/50x2		0.40x2/50x2		10.0/6.20k	10.0/6.50k	10.0/6.75k	
Starting current(A) (Cooling/Heating)		-		-		-		5.90/5.00	5.60/4.80	5.40/4.60	
Comp output(W)		-		-		-		2.80k	2.80k	2.80k	
Network Impedance(ΩMAX.)		-		-		-		-	-	-	
Fan motor output (Indoor/Outdoor) W		-		74		-		120	-	-	
Moisture removal volume		L/h(Pt/h)		6.8 (3.4x2) (14.3)		-		-	-	-	
External static pressure		Pa		-		-		-	-	-	
Indoor Air flow	Cooling	m³/min (ft³/min)	20.0x2/17.0x2/14.5x2 (706x2)/(600x2)/(512x2)			-			-	-	
	Heating	m³/min (ft³/min)	20.0x2/17.0x2/14.5x2 (706x2)/(600x2)/(512x2)			-			-	-	
Outdoor Air flow	Cooling	m³/min (ft³/min)	-			86.0 (3037)			-	-	
	Heating	m³/min (ft³/min)	-			78.0 (2754)			-	-	
Refrigerant type / amount g(oz)		-		-		R32		2.98k	(105.1)	-	
Product dimension	Height	mm(inch)	235 (9-1/4)			996 (39- 7/32)			-	-	
	Width	mm(inch)	1275 (50-3/16)			980 (38-37/64)			-	-	
	Depth	mm(inch)	690 (27-5/32)			370 (14- 9/16)			-	-	
Product dimension (Panel)		HxWxD mm, inch		-		-		-	-	-	
Packing dimension	Height	mm(inch)	360 (14-11/64)			1134 (44-41/64)			-	-	
	Width	mm(inch)	1340 (52-3/4)			1095 (43-7/64)			-	-	
	Depth	mm(inch)	820 (32-9/32)			529 (20-53/64)			-	-	
Weight	(NET)	kg(lb)	33 (73)			94 (207)			-	-	
	(GROSS)	kg(lb)	42 (93)			102 (224)			-	-	
	Panel (NET)	kg(lb)	-			-			-	-	
Layers limit (actually)		9 (10)		2 (3)		-		-	-		
Operation condition		Cool (DBT)		18°C ~ 32°C		-10°C ~ 43°C		-	-		
		Heat (DBT)		16°C ~ 30°C		-15°C ~ 24°C		-	-		
MAX WORKING PRESSURE HP/LP MPa (bar)					4.15/2.55 (41.5/25.5)						
P	Pipe diameter mm (inch)		(Liquid)Ø9.52(3/8) (Gas)Ø15.88(5/8)			(Liquid)Ø9.52(3/8) (Gas)Ø15.88(5/8)			-	-	
	Connecting method, Standard length m(ft)		flared type, 5.0(16.4)			flared type, 5.0(16.4)			-	-	
P	Pipe length range m (ft)		5 ~ 50m (16.4 ~ 164.0)			-			-	-	
I	Indoor unit & Outdoor unit height difference m (ft)		15m(OD located lower)/30m(OD located higher) (49.2/98.4)			-			-	-	
N	Add gas amount g/m (oz/ft)		45g/m (0.484)			-			-	-	
G	Pipe length for additional gas m (ft)		30m (98.4)			-			-	-	

\*1 In case it is necessary to indicate the air flow volume in (l/s), the value in (m³/min.) shall be multiplied by 16.7 and rounded down the decimal point.  
 \*2 If the EUROVENT Certified models can be operated under the "extra-low"temperature condition, -7°C dry bulb and -8°C wet-bulb temperatures with rated voltage 230V shall be used.  
 \*3 Network Impedance shall be applicable for EUROPE and CHINA models.  
 \*4 The annual consumption is calculated by multiplying the input power at 230V(400V) by an average of 500 hours per year in cooling mode.  
 \*5 EER and COP classification is at 230V(400V) only in accordance with EU directive 2002/31/EC.  
 \*6 η s,c and η s,h classification is at 230V(400V) only in accordance with EN-14825. For heating, η s,h indicates the value of only Average heating season.

# Simultaneous (Twin) -Type

## 1-1. Unit Specifications

**PZ2**

## 2. Ceiling Type S-71PT2E5Bx2 / U-140PZ2E8

INDOOR		MODEL	S-71PT2E5Bx2			-			-		
PANEL		MODEL	-			-			-		
OUTDOOR		MODEL	-			U-140PZ2E8			-		
Branch pipe		MODEL	-			-			-		
Performance test condition					ISO5151 / EN14511 / EN12102 / EN14825						
Power supply		Ø, Hz	1Ø 50Hz			3Ø 50Hz			Min	Max	
		V	220V	230V	240V	380V	400V	415V			
C O L I N G	Capacity	kW	14.0	14.0	14.0	-	-	-	3.3	15.0	
		BTU/h	47800	47800	47800	-	-	-	11300	51200	
	Current	A	0.45×2	0.44×2	0.43×2	7.40	7.05	6.80	-	-	
		W	55×2	55×2	55×2	4.590k	4.590k	4.590k	-	-	
	Input power	TOTAL W	-			4.700k	4.700k	4.700k	620	5.500k	
		Annual consumption	TOTAL kWh **	-			-	2350	-	-	-
	EER/EER CLASS	TOTAL (W/W) <sup>15</sup> ("A"-G)	-	-	-	2.98	2.98/C	2.98	5.32	2.73	
	Erp <sup>16</sup>	Pdesign	kW	-	-	-	-	14.0	-	-	-
		η <sub>s,c</sub>	%	-	-	-	-	226.9	-	-	-
		Annual consumption	kWh	-	-	-	-	-	-	-	-
		Class		-	-	-	-	-	-	-	-
	Power factor	%	-	-	-	94	94	94	-	-	
	Noise indoor	dB-A (H/M/L)	39×2/35×2/31×2			-			-	-	
		Power Level dB	57×2/53×2/49×2			-			-	-	
Noise outdoor	dB-A (H/L)	-			56/-			-	-		
	Power Level dB	-			74/-			-	-		
H E A T I N G	Capacity	kW	14.0	14.0	14.0	-	-	-	3.4	16.0	
		BTU/h	47800	47800	47800	-	-	-	11600	54600	
	Current	A	0.45×2	0.44×2	0.43×2	5.95	5.65	5.45	-	-	
		W	55×2	55×2	55×2	3.680k	3.680k	3.680k	-	-	
	Input power	TOTAL W	-			3.780k	3.780k	3.780k	620	5.200k	
		COP/COP CLASS	TOTAL (W/W) <sup>15</sup> ("A"-G)	-	-	-	3.70	3.70/A	3.70	5.48	3.08
	Erp <sup>16</sup>	Pdesign at -10°C	kW	-	-	-	-	13.6	-	-	-
		Tbivalent	°C	-	-	-	-	-7	-	-	-
		η <sub>s,h</sub>	%	-	-	-	-	145.4	-	-	-
		Annual consumption	kWh	-	-	-	-	-	-	-	-
		elbu(-10°C)	kW	-	-	-	-	3.20	-	-	-
	Class		-	-	-	-	-	-	-	-	
	Power factor	%	-	-	-	94	94	94	-	-	
	Noise indoor	dB-A (H/M/L)	39×2/35×2/31×2			-			-	-	
Power Level dB		57×2/53×2/49×2			-			-	-		
Noise outdoor	dB-A (H/L)	-			56/-			-	-		
	Power Level dB	-			74/-			-	-		
EXTRA LOW TEMP Total capacity(kW) / Input power(W) / COP											
Max Current(A) / Max Input power(W)		0.45×2/55×2		0.44×2/55×2	0.43×2/55×2	10.5/6.50k	10.5/6.85k	10.5/7.10k	-		
Starting current(A) (Cooling/Heating)		-		-	-	7.40/5.95	7.05/5.65	6.80/5.45	-		
Comp output(W)		-		-	-	3.00k	3.00k	3.00k	-		
Network Impedance(ΩMAX.)		-		-	-	-	-	-	-		
Fan motor output (Indoor/Outdoor) W		-		74	-	-	120	-	-		
Moisture removal volume		L/h(Pt/h)		8.4	(4.2×2)	(17.6)	-	-	-		
External static pressure		Pa		-			-			-	
Indoor Air flow	Cooling	m³/min (ft³/min)	21.0×2/18.0×2/15.5×2 (742×2)/(636×2)/(547×2)			-			-	-	
	Heating	m³/min (ft³/min)	21.0×2/18.0×2/15.5×2 (742×2)/(636×2)/(547×2)			-			-	-	
Outdoor Air flow	Cooling	m³/min (ft³/min)	-			89.0 (3143)			-	-	
	Heating	m³/min (ft³/min)	-			83.0 (2931)			-	-	
Refrigerant type / amount g(oz)		-		-	-	R32	2.98k	(105.1)	-		
Product dimension	Height	mm(inch)	235 (9-1/4)			996 (39- 7/32)			-		
	Width	mm(inch)	1275 (50-3/16)			980 (38-37/64)			-		
	Depth	mm(inch)	690 (27-5/32)			370 (14- 9/16)			-		
Product dimension (Panel)		H×W×D mm, inch		-			-			-	
Packing dimension	Height	mm(inch)	360 (14-11/64)			1134 (44-41/64)			-		
	Width	mm(inch)	1340 (52-3/4)			1095 (43-7/64)			-		
	Depth	mm(inch)	820 (32-9/32)			529 (20-53/64)			-		
Weight	(NET)	kg(lb)	33 (73)			94 (207)			-		
	(GROSS)	kg(lb)	42 (93)			102 (224)			-		
	Panel (NET)	kg(lb)	-			-			-		
Layers limit (actually)		9 (10)		2 (3)		-		-			
Operation condition		Cool (DBT)	18°C ~ 32°C			-10°C ~ 43°C			-		
		Heat (DBT)	16°C ~ 30°C			-15°C ~ 24°C			-		
MAX WORKING PRESSURE HP/LP MPa (bar)					4.15/2.55 (41.5/25.5)						
P	Pipe diameter mm (inch)		(Liquid)Ø9.52(3/8) (Gas)Ø15.88(5/8)			(Liquid)Ø9.52(3/8) (Gas)Ø15.88(5/8)			-		
	Connecting method, Standard length m(ft)		flared type, 5.0(16.4)			flared type, 5.0(16.4)			-		
P	Pipe length range m (ft)		5 ~ 50m (16.4 ~ 164.0)			-			-		
I	Indoor unit & Outdoor unit height difference m (ft)		15m(OD located lower)/30m(OD located higher) (49.2/98.4)			-			-		
N	Add gas amount g/m (oz/ft)		45g/m (0.484)			-			-		
G	Pipe length for additional gas m (ft)		30m (98.4)			-			-		

\*1 In case it is necessary to indicate the air flow volume in (l/s), the value in (m³/min.) shall be multiplied by 16.7 and rounded down the decimal point.

\*2 If the EUROVENT Certified models can be operated under the "extra-low"temperature condition, -7°C dry bulb and -8°C wet-bulb temperatures with rated voltage 230V shall be used.

\*3 Network Impedance shall be applicable for EUROPE and CHINA models.

\*4 The annual consumption is calculated by multiplying the input power at 230V(400V) by an average of 500 hours per year in cooling mode.

\*5 EER and COP classification is at 230V(400V) only in accordance with EU directive 2002/31/EC.

\*6 η<sub>s,c</sub> and η<sub>s,h</sub> classification is at 230V(400V) only in accordance with EN-14825. For heating, η<sub>s,h</sub> indicates the value of only Average heating season.

# Single -Type

## 1-1. Unit Specifications

PZ2

### 2. Ceiling Type S-100PT2E5B / U-100PZ2E8

INDOOR	MODEL	S-100PT2E5B			-			-		
PANEL	MODEL	-			-			-		
OUTDOOR	MODEL	-			U-100PZ2E8			-		
Branch pipe	MODEL	-			-			-		
Performance test condition		ISO5151 / EN14511 / EN12102 / EN14825								
Power supply		Ø, Hz	1Ø 50Hz			3Ø 50Hz			Min	Max
		V	220V	230V	240V	380V	400V	415V		
C O L I N G	Capacity	kW	10.0	10.0	10.0	-	-	-	3.0	11.5
		BTU/h	34100	34100	34100	-	-	-	10200	39200
	Current	A	0.69	0.67	0.65	4.35	4.15	4.00	-	-
		W	80	80	80	2.670k	2.670k	2.670k	-	-
	Input power	TOTAL W	-			2.750k	2.750k	2.750k	560	4.100k
		Annual consumption	TOTAL kWh **	-			-	1375	-	-
	EER/EEER CLASS	TOTAL (W/W) <sup>1)</sup> ("A"-~"G")	-	-	-	3.82	3.82/A	3.82	5.36	2.80
	Erp <sup>5)</sup>	Pdesign	kW	-	-	-	-	10.0	-	-
		SEER	(W/W)	-	-	-	-	6.5	-	-
		Annual consumption	kWh	-	-	-	-	538	-	-
		Class		-	-	-	-	A++	-	-
	Power factor	%	-	-	-	93	93	93	-	-
	Noise indoor	dB-A (H/M/L)	42/37/35			-			-	-
		Power Level dB	60/55/53			-			-	-
Noise outdoor	dB-A (H/L)	-			52/-			-	-	
	Power Level dB	-			70/-			-	-	
H E A T I N G	Capacity	kW	10.0	10.0	10.0	-	-	-	3.0	14.0
		BTU/h	34100	34100	34100	-	-	-	10200	47800
	Current	A	0.69	0.67	0.65	3.70	3.55	3.40	-	-
		W	80	80	80	2.280k	2.280k	2.280k	-	-
	Input power	TOTAL W	-			2.360k	2.360k	2.360k	560	4.000k
		COP/COP CLASS	TOTAL (W/W) <sup>1)</sup> ("A"-~"G")	-	-	-	4.93	4.93/A	4.93	5.36
	Erp <sup>5)</sup>	Pdesign at -10°C	kW	-	-	-	-	10.0	-	-
		Tbivalent	°C	-	-	-	-	-7	-	-
		SCOP	(W/W)	-	-	-	-	4.2	-	-
		Annual consumption	kWh	-	-	-	-	3324	-	-
	Class	elbu(-10°C)	kW	-	-	-	-	2.07	-	-
				-	-	-	-	A+	-	-
	Power factor	%	-	-	-	93	93	93	-	-
	Noise indoor	dB-A (H/M/L)	42/37/35			-			-	-
Power Level dB		60/55/53			-			-	-	
Noise outdoor	dB-A (H/L)	-			52/-			-	-	
	Power Level dB	-			70/-			-	-	
EXTRA LOW TEMP Total capacity(kW) / Input power(W) / COP		-								
Max Current(A) / Max Input power(W)		0.69/80	0.67/80	0.65/80	9.00/5.55k	9.00/5.80k	9.00/6.05k	-		
Starting current(A) (Cooling/Heating)		-	-	-	4.35/3.70	4.15/3.55	4.00/3.40	-		
Comp output(W)		-			2.50k	2.50k	2.50k	-		
Network Impedance(ΩMAX.)		-								
Fan motor output (Indoor/Outdoor) W		111			120			-		
Moisture removal volume		L/h(Pt/h)	6.0	(12.6)		-			-	
External static pressure		Pa	-							
Indoor Air flow	Cooling	m³/min (ft³/min)	30.0/25.0/23.0 (1059)/(883)/(812)			-			-	
	Heating	m³/min (ft³/min)	30.0/25.0/23.0 (1059)/(883)/(812)			-			-	
Outdoor Air flow	Cooling	m³/min (ft³/min)	-			76.0 (2683)			-	
	Heating	m³/min (ft³/min)	-			70.0 (2472)			-	
Refrigerant type / amount g(oz)		-			R32	2.60k	(91.7)	-		
Product dimension	Height	mm(inch)	235 (9-1/4)			996 (39- 7/32)			-	
	Width	mm(inch)	1590 (62-19/32)			980 (38-37/64)			-	
	Depth	mm(inch)	690 (27-5/32)			370 (14- 9/16)			-	
Product dimension (Panel)		H×W×D mm, inch	-							
Packing dimension	Height	mm(inch)	360 (14-11/64)			1134 (44-41/64)			-	
	Width	mm(inch)	1655 (65-5/32)			1095 (43-7/64)			-	
	Depth	mm(inch)	820 (32-9/32)			529 (20-53/64)			-	
Weight	(NET)	kg(lb)	40 (88)			90 (199)			-	
	(GROSS)	kg(lb)	49 (108)			98 (216)			-	
	Panel (NET)	kg(lb)	-							
Layers limit (actually)		9 (10)			2 (3)			-		
Operation condition	Cool (DBT)	18°C ~ 32°C			-10°C ~ 43°C			-		
	Heat (DBT)	16°C ~ 30°C			-15°C ~ 24°C			-		
MAX WORKING PRESSURE HP/LP MPa (bar)		4.15/2.55 (41.5/25.5)								
P I	Pipe diameter mm (inch)	(Liquid)Ø9.52(3/8) (Gas)Ø15.88(5/8)			(Liquid)Ø9.52(3/8) (Gas)Ø15.88(5/8)			-		
	Connecting method, Standard length m(ft)	flared type, 5.0(16.4)			flared type, 5.0(16.4)			-		
P I	Pipe length range m (ft)	5 ~ 50m (16.4 ~ 164.0)								
N G	Indoor unit & Outdoor unit height difference m (ft)	15m(OD located lower)/30m(OD located higher) (49.2/98.4)								
	Add gas amount g/m (oz/ft)	45g/m (0.484)								
N G	Pipe length for additional gas m (ft)	30m (98.4)								

\*1 In case it is necessary to indicate the air flow volume in (l/s), the value in (m³/min.) shall be multiplied by 16.7 and rounded down the decimal point.  
 \*2 If the EUROVENT Certified models can be operated under the "extra-low" temperature condition, -7°C dry bulb and -8°C wet-bulb temperatures with rated voltage 230V shall be used.  
 \*3 Network Impedance shall be applicable for EUROPE and CHINA models.  
 \*4 The annual consumption is calculated by multiplying the input power at 230V(400V) by an average of 500 hours per year in cooling mode.  
 \*5 EER and COP classification is at 230V(400V) only in accordance with EU directive 2002/31/EC.  
 \*6 SEER and SCOP classification is at 230V(400V) only in accordance with EN-14825. For heating, SCOP indicates the value of only Average heating season, Other fiche data indicates in an attached sheet

# Single -Type

## 1-1. Unit Specifications

**PZ2**

## 2. Ceiling Type S-125PT2E5B / U-125PZ2E8

INDOOR		MODEL	S-125PT2E5B			-			-		
PANEL		MODEL	-			-			-		
OUTDOOR		MODEL	-			U-125PZ2E8			-		
Branch pipe		MODEL	-			-			-		
Performance test condition					ISO5151 / EN14511 / EN12102 / EN14825						
Power supply		Ø, Hz	1Ø 50Hz			3Ø 50Hz			Min	Max	
		V	220V	230V	240V	380V	400V	415V			
C O O L I N G	Capacity	kW	12.5	12.5	12.5	-	-	-	3.2	13.5	
		BTU/h	42700	42700	42700	-	-	-	10900	46100	
	Current	A	0.89	0.86	0.83	5.90	5.60	5.40	-	-	
		W	110	110	110	3.650k	3.650k	3.650k	-	-	
	Input power	TOTAL W	-	-	-	3.760k	3.760k	3.760k	600	4.880k	
		Annual consumption	TOTAL kWh **	-	-	-	-	1880	-	-	-
	EER/EER CLASS	TOTAL (W/W) <sup>1)</sup> ("A"~"G")	-	-	-	3.32	3.32/A	3.32	5.33	2.77	
	Erp <sup>5)</sup>	Pdesign	kW	-	-	-	-	12.5	-	-	-
		η <sub>s.c</sub>	%	-	-	-	-	227.1	-	-	-
		Annual consumption	kWh	-	-	-	-	-	-	-	-
		Class		-	-	-	-	-	-	-	-
	Power factor	%	-	-	-	94	94	94	-	-	
	Noise indoor	dB-A (H/M/L)	46/40/36			-			-	-	
		Power Level dB	64/58/54			-			-	-	
Noise outdoor	dB-A (H/L)	-			55/-			-	-		
	Power Level dB	-			73/-			-	-		
H E A T I N G	Capacity	kW	12.5	12.5	12.5	-	-	-	3.3	15.0	
		BTU/h	42700	42700	42700	-	-	-	11300	51200	
	Current	A	0.89	0.86	0.83	5.00	4.75	4.60	-	-	
		W	110	110	110	3.100k	3.100k	3.100k	-	-	
	Input power	TOTAL W	-	-	-	3.210k	3.210k	3.210k	730	4.400k	
		COP/COP CLASS	TOTAL (W/W) <sup>1)</sup> ("A"~"G")	-	-	-	3.89	3.89/A	3.89	4.52	3.41
	Erp <sup>5)</sup>	Pdesign at -10°C	kW	-	-	-	-	12.5	-	-	-
		Tbivalent	°C	-	-	-	-	-7	-	-	-
		η <sub>s.h</sub>	%	-	-	-	-	146.9	-	-	-
		Annual consumption	kWh	-	-	-	-	-	-	-	-
		elbu(-10°C)	kW	-	-	-	-	2.70	-	-	-
		Class		-	-	-	-	-	-	-	-
	Power factor	%	-	-	-	94	94	94	-	-	
	Noise indoor	dB-A (H/M/L)	46/40/36			-			-	-	
Power Level dB		64/58/54			-			-	-		
Noise outdoor	dB-A (H/L)	-			55/-			-	-		
	Power Level dB	-			73/-			-	-		
EXTRA LOW TEMP Total capacity(kW) / Input power(W) / COP											
Max Current(A) / Max Input power(W)		0.89/110	0.86/110	0.83/110	10.0/6.20k	10.0/6.50k	10.0/6.75k				
Starting current(A) (Cooling/Heating)		-	-	-	5.90/5.00	5.60/4.75	5.40/4.60				
Comp output(W)						2.80k	2.80k	2.80k			
Network Impedance(ΩMAX.)											
Fan motor output (Indoor/Outdoor) W				111		120					
Moisture removal volume		L/h(Pt/h)	7.9	(16.6)							
External static pressure		Pa									
Indoor Air flow	Cooling	m³/min (ft³/min)	34.0/28.0/24.0 (1201)/(989)/(848)						-	-	
	Heating	m³/min (ft³/min)	34.0/28.0/24.0 (1201)/(989)/(848)						-	-	
Outdoor Air flow	Cooling	m³/min (ft³/min)				86.0 (3037)			-	-	
	Heating	m³/min (ft³/min)				78.0 (2754)			-	-	
Refrigerant type / amount (g/oz)						R32	2.98k	(105.1)			
Product dimension	Height	mm(inch)	235 (9-1/4)			996 (39- 7/32)					
	Width	mm(inch)	1590 (62-19/32)			980 (38-37/64)					
	Depth	mm(inch)	690 (27-5/32)			370 (14- 9/16)					
Product dimension (Panel)		H×W×D mm, inch									
Packing dimension	Height	mm(inch)	360 (14-11/64)			1134 (44-41/64)					
	Width	mm(inch)	1655 (65-5/32)			1095 (43-7/64)					
	Depth	mm(inch)	820 (32-9/32)			529 (20-53/64)					
Weight	(NET)	kg(lb)	40 (88)			94 (207)					
	(GROSS)	kg(lb)	49 (108)			102 (224)					
	Panel (NET)	kg(lb)									
Layers limit (actually)				9 (10)		2 (3)					
Operation condition	Cool (DBT)	18°C ~ 32°C			-10°C ~ 43°C						
	Heat (DBT)	16°C ~ 30°C			-15°C ~ 24°C						
MAX WORKING PRESSURE HP/LP MPa (bar)						4.15/2.55 (41.5/25.5)					
P I	Pipe diameter mm (inch)	(Liquid)Ø9.52(3/8) (Gas)Ø15.88(5/8)			(Liquid)Ø9.52(3/8) (Gas)Ø15.88(5/8)						
	Connecting method, Standard length m(ft)	flared type, 5.0(16.4)			flared type, 5.0(16.4)						
P I	Pipe length range m (ft)				5 ~ 50m (16.4 ~ 164.0)						
N I	Indoor unit & Outdoor unit height difference m (ft)				15m(OD located lower)/30m(OD located higher) (49.2/98.4)						
N G	Add gas amount g/m (oz/ft)				45g/m (0.484)						
	Pipe length for additional gas m (ft)				30m (98.4)						

\*1 In case it is necessary to indicate the air flow volume in (l/s), the value in (m³/min.) shall be multiplied by 16.7 and rounded down the decimal point.

\*2 If the EUROVENT Certified models can be operated under the "extra-low" temperature condition, -7°C dry bulb and -8°C wet-bulb temperatures with rated voltage 230V shall be used.

\*3 Network Impedance shall be applicable for EUROPE and CHINA models.

\*4 The annual consumption is calculated by multiplying the input power at 230V(400V) by an average of 500 hours per year in cooling mode.

\*5 EER and COP classification is at 230V(400V) only in accordance with EU directive 2002/31/EC.

\*6 η<sub>s.c</sub> and η<sub>s.h</sub> classification is at 230V(400V) only in accordance with EN-14825. For heating, η<sub>s.h</sub> indicates the value of only Average heating season.

# Single -Type

## 1-1. Unit Specifications

**PZ2**

## 2. Ceiling Type S-140PT2E5B / U-140PZ2E8

INDOOR	MODEL	S-140PT2E5B			-			-	-		
PANEL	MODEL	-			-			-	-		
OUTDOOR	MODEL	-			U-140PZ2E8			-	-		
Branch pipe	MODEL	-			-			-	-		
Performance test condition		ISO5151 / EN14511 / EN12102 / EN14825									
Power supply		Ø, Hz	1Ø 50Hz			3Ø 50Hz			Min	Max	
		V	220V	230V	240V	380V	400V	415V			
C O O L I N G	Capacity	kW	14.0	14.0	14.0	-	-	-	3.3	15.0	
		BTU/h	47800	47800	47800	-	-	-	11300	51200	
	Current	A	0.94	0.91	0.88	7.40	7.05	6.80	-	-	
		W	120	120	120	4.580k	4.580k	4.580k	-	-	
	Input power	TOTAL W	-			4.700k	4.700k	4.700k	620	5.500k	
		Annual consumption	TOTAL kWh**	-			-	2350	-	-	-
	EER/EER CLASS	TOTAL (W/W) <sup>1)</sup> ("A"~"G")	-			2.98	2.98/C	2.98	5.32	2.73	
	Erp*6	Pdesign	kW	-	-	-	-	14.0	-	-	-
		η <sub>s.c</sub>	%	-	-	-	-	216	-	-	-
		Annual consumption	kWh	-	-	-	-	-	-	-	-
Class			-	-	-	-	-	-	-	-	
Power factor	%	-	-	-	94	94	94	-	-		
Noise indoor	dB-A (H/M/L)	47/41/37			-			-	-		
	Power Level dB	65/59/55			-			-	-		
Noise outdoor	dB-A (H/L)	-			56/-			-	-		
	Power Level dB	-			74/-			-	-		
H E A T I N G	Capacity	kW	14.0	14.0	14.0	-	-	-	3.4	16.0	
		BTU/h	47800	47800	47800	-	-	-	11600	54600	
	Current	A	0.94	0.91	0.88	5.90	5.60	5.40	-	-	
		W	120	120	120	3.660k	3.660k	3.660k	-	-	
	Input power	TOTAL W	-			3.780k	3.780k	3.780k	620	5.200k	
		COP/COP CLASS	TOTAL (W/W) <sup>1)</sup> ("A"~"G")	-	-	-	3.70	3.70/A	3.70	5.48	3.08
	Erp*6	Pdesign at -10°C	kW	-	-	-	-	13.6	-	-	-
		Tbivalent	°C	-	-	-	-	-7	-	-	-
		η <sub>s.h</sub>	%	-	-	-	-	144.8	-	-	-
		Annual consumption	kWh	-	-	-	-	-	-	-	-
elbu(-10°C)		kW	-	-	-	-	3.00	-	-	-	
Class		-	-	-	-	-	-	-	-		
Power factor	%	-	-	-	94	94	94	-	-		
Noise indoor	dB-A (H/M/L)	47/41/37			-			-	-		
	Power Level dB	65/59/55			-			-	-		
Noise outdoor	dB-A (H/L)	-			56/-			-	-		
	Power Level dB	-			74/-			-	-		
EXTRA LOW TEMP Total capacity(kW) / Input power(W) / COP		-			-			-	-		
Max Current(A) / Max Input power(W)		0.94/120	0.91/120	0.88/120	10.5/6.50k	10.5/6.85k	10.5/7.10k	-	-		
Starting current(A) (Cooling/Heating)		-	-	-	7.40/5.90	7.05/5.60	6.80/5.40	-	-		
Comp output(W)		-			3.00k	3.00k	3.00k	-	-		
Network Impedance(ΩMAX.)		-			-			-	-		
Fan motor output (Indoor/Outdoor) W		111			120			-	-		
Moisture removal volume		L/h(Pt/h)	9.0	(18.9)	-			-	-		
External static pressure		Pa	-			-			-	-	
Indoor Air flow	Cooling	m³/min (ft³/min)	35.0/29.0/25.0 (1236)/(1024)/(883)			-			-	-	
	Heating	m³/min (ft³/min)	35.0/29.0/25.0 (1236)/(1024)/(883)			-			-	-	
Outdoor Air flow	Cooling	m³/min (ft³/min)	-			89.0 (3143)			-	-	
	Heating	m³/min (ft³/min)	-			83.0 (2931)			-	-	
Refrigerant type / amount g(oz)		-			R32	2.98k	(105.1)	-	-		
Product dimension	Height	mm(inch)	235 (9-1/4)			996 (39- 7/32)			-	-	
	Width	mm(inch)	1590 (62-19/32)			980 (38-37/64)			-	-	
	Depth	mm(inch)	690 (27-5/32)			370 (14- 9/16)			-	-	
Product dimension (Panel)		H×W×D mm, inch	-			-			-	-	
Packing dimension	Height	mm(inch)	360 (14-11/64)			1134 (44-41/64)			-	-	
	Width	mm(inch)	1655 (65-5/32)			1095 (43-7/64)			-	-	
	Depth	mm(inch)	820 (32-9/32)			529 (20-53/64)			-	-	
Weight	(NET)	kg(lb)	40 (88)			94 (207)			-	-	
	(GROSS)	kg(lb)	49 (108)			102 (224)			-	-	
	Panel (NET)	kg(lb)	-			-			-	-	
Layers limit (actually)		9 (10)			2 (3)			-	-		
Operation condition	Cool (DBT)	18°C ~ 32°C			-10°C ~ 43°C			-	-		
	Heat (DBT)	16°C ~ 30°C			-15°C ~ 24°C			-	-		
MAX WORKING PRESSURE HP/LP MPa (bar)		4.15/2.55 (41.5/25.5)			-			-	-		
P I	Pipe diameter mm (inch)	(Liquid)Ø9.52(3/8) (Gas)Ø15.88(5/8)			(Liquid)Ø9.52(3/8) (Gas)Ø15.88(5/8)			-	-		
	Connecting method, Standard length m(ft)	flared type, 5.0(16.4)			flared type, 5.0(16.4)			-	-		
P I	Pipe length range m (ft)	5 ~ 50m (16.4 ~ 164.0)			-			-	-		
N G	Indoor unit & Outdoor unit height difference m (ft)	15m(OD located lower)/30m(OD located higher) (49.2/98.4)			-			-	-		
Add gas amount g/m (oz/ft)		45g/m (0.484)			-			-	-		
Pipe length for additional gas m (ft)		30m (98.4)			-			-	-		

\*1 In case it is necessary to indicate the air flow volume in (l/s), the value in (m³/min.) shall be multiplied by 16.7 and rounded down the decimal point.  
 \*2 If the EUROVENT Certified models can be operated under the "extra-low" temperature condition, -7°C dry bulb and -8°C wet-bulb temperatures with rated voltage 230V shall be used.  
 \*3 Network Impedance shall be applicable for EUROPE and CHINA models.  
 \*4 The annual consumption is calculated by multiplying the input power at 230V(400V) by an average of 500 hours per year in cooling mode.  
 \*5 EER and COP classification is at 230V(400V) only in accordance with EU directive 2002/31/EC.  
 \*6 η<sub>s.c</sub> and η<sub>s.h</sub> classification is at 230V(400V) only in accordance with EN-14825. For heating, η<sub>s.h</sub> indicates the value of only Average heating season.

# Simultaneous (Twin) -Type

## 1-1. Unit Specifications

**PZ2**

### 3. Wall Mounted Type S-50PK2E5Bx2 / U-100PZ2E5

INDOOR		MODEL	S-50PK2E5B x2			-			-				
PANEL		MODEL	-			-			-				
OUTDOOR		MODEL	-			U-100PZ2E5			-				
Branch pipe		MODEL	-			CZ-P155BK1			-				
Performance test condition					ISO5151 / EN14511 / EN12102/ EN14825								
Power supply		Ø, Hz	1Ø 50Hz			1Ø 50Hz			Min	Max			
		V	220V	230V	240V	220V	230V	240V					
C O O L I N G	Capacity	kW	10.0	10.0	10.0	-	-	-	3.0	11.0			
		BTU/h	34100	34100	34100	-	-	-	10200	37500			
	Current	A	0.40x2	0.39x2	0.38x2	13.5	12.9	12.3	-	-			
		W	35x2	35x2	35x2	2.810k	2.810k	2.810k	-	-			
	Input power	TOTAL W	-	-	-	2.880k	2.880k	2.880k	560	4.000k			
		Annual consumption	TOTAL kWh **	-	-	-	-	1440	-	-	-		
	EER/EER CLASS	TOTAL (W/W) <sup>1)</sup> ("A"-G)	-	-	-	3.47	3.47/A	3.47	5.36	2.75			
	Erp <sup>5)</sup>	Pdesign	kW	-	-	-	-	10.0	-	-	-		
		SEER	(W/W)	-	-	-	-	6.4	-	-	-		
		Annual consumption	kWh	-	-	-	-	547	-	-	-		
		Class		-	-	-	-	A++	-	-	-		
	Power factor	%	-	-	-	95	95	95	-	-			
	Noise indoor	dB-A (H/M/L) <sup>7)</sup>	40x2 / 36x2 / 32x2			-			-	-			
Power Level dB		56x2 / 52x2 / 48x2			-			-	-				
Noise outdoor	dB-A (H/L)	-			52/-			-	-				
	Power Level dB	-			70/-			-	-				
H E A T I N G	Capacity	kW	10.0	10.0	10.0	-	-	-	3.0	12.4			
		BTU/h	34100	34100	34100	-	-	-	10200	42300			
	Current	A	0.40x2	0.39x2	0.38x2	11.8	11.3	10.9	-	-			
		W	35x2	35x2	35x2	2.470k	2.470k	2.470k	-	-			
	Input power	TOTAL W	-	-	-	2.540k	2.540k	2.540k	560	3.900k			
		COP/COP CLASS	TOTAL (W/W) <sup>1)</sup> ("A"-G)	-	-	-	3.94	3.94/A	3.94	5.36	3.18		
	Erp <sup>5)</sup>	Pdesign at -10°C	kW	-	-	-	-	10.0	-	-	-		
		Tbivalent	°C	-	-	-	-	-7	-	-	-		
		SCOP	(W/W)	-	-	-	-	3.9	-	-	-		
		Annual consumption	kWh	-	-	-	-	3590	-	-	-		
	Class	elbu(-10°C)	kW	-	-	-	-	1.69	-	-	-		
				-	-	-	-	A	-	-	-		
	Power factor	%	-	-	-	95	95	95	-	-			
Noise indoor	dB-A (H/M/L) <sup>7)</sup>	40x2 / 36x2 / 32x2			-			-	-				
	Power Level dB	56x2 / 52x2 / 48x2			-			-	-				
Noise outdoor	dB-A (H/L)	-			52/-			-	-				
	Power Level dB	-			70/-			-	-				
EXTRA LOW TEMP   Total capacity(kW) / Input power(W) / COP													
Max Current(A) / Max Input power(W)		0.40x2/35x2		0.39x2/35x2		0.38x2/35x2		25.0/5.25k		25.0/5.50k		25.0/5.70k	
Starting current(A) (Cooling/Heating)		-		-		-		13.5/11.8		12.9/11.3		12.3/10.9	
Comp output(W)		-		-		-		2.50k		2.50k		2.50k	
Network Impedance(ΩMAX.)		-		-		-		-		-		-	
Fan motor output (Indoor/Outdoor) W		-		54		-		120		-		-	
Moisture removal volume		L/h(Pt/h)		3.6		(1.8x2)		(7.6)		-		-	
External static pressure		Pa		-		-		-		-		-	
Indoor Air flow <sup>7)</sup>	Cooling	m <sup>3</sup> /min (ft <sup>3</sup> /min)		16.0x2/13.5x2/11.0x2 (565x2)/(477x2)/(388x2)		-		-		-		-	
	Heating	m <sup>3</sup> /min (ft <sup>3</sup> /min)		16.0x2/13.5x2/11.0x2 (565x2)/(477x2)/(388x2)		-		-		-		-	
Outdoor Air flow	Cooling	m <sup>3</sup> /min (ft <sup>3</sup> /min)		-		-		76.0 (2683)		-		-	
	Heating	m <sup>3</sup> /min (ft <sup>3</sup> /min)		-		-		70.0 (2472)		-		-	
Refrigerant type / amount g(oz)		-		-		-		R32		2.60k		(91.7)	
Product dimension	Height	mm(inch)		302 (11-29/32)		-		996 (39- 7/32)		-		-	
	Width	mm(inch)		1120 (44-3/32)		-		980 (38-37/64)		-		-	
	Depth	mm(inch)		236 (9-9/32)		-		370 (14- 9/16)		-		-	
Product dimension (Panel)		HxWxD mm, inch		-		-		-		-		-	
Packing dimension	Height	mm(inch)		282 (11-1/8)		-		1134 (44-41/64)		-		-	
	Width	mm(inch)		1190 (46-7/8)		-		1095 (43-7/64)		-		-	
	Depth	mm(inch)		378 (14-29/32)		-		529 (20-53/64)		-		-	
Weight	(NET)	kg(lb)		13 (29)		-		90 (199)		-		-	
	(GROSS)	kg(lb)		16 (36)		-		98 (216)		-		-	
	Panel (NET)	kg(lb)		-		-		-		-		-	
Layers limit (actually)		-		11(12)		-		2 (3)		-		-	
Operation condition	Cool (DBT)	18°C ~ 32°C		-		-		-10°C ~ 43°C		-		-	
	Heat (DBT)	16°C ~ 30°C		-		-		-15°C ~ 24°C		-		-	
MAX WORKING PRESSURE HP/LP MPa (bar)		-		-		-		4.15/2.55 (41.5/25.5)		-		-	
P I	Pipe diameter mm (inch)	(Liquid)Ø6.35(1/4) (Gas)Ø12.7(1/2)		-		-		(Liquid)Ø9.52(3/8) (Gas)Ø15.88(5/8)		-		-	
	Connecting method, Standard length m(ft)	flared type, 5.0(16.4)		-		-		flared type, 5.0(16.4)		-		-	
P I	Pipe length range m (ft)	-		5 ~ 50m (16.4 ~ 164.0)		-		-		-		-	
N G	Indoor unit & Outdoor unit height difference m (ft)	15m(OD located lower)/30m(OD located higher) (49.2/98.4)		-		-		-		-		-	
	Add gas amount g/m (oz/ft)	-		45g/m (0.484)		-		-		-		-	
N G	Pipe length for additional gas m (ft)	-		30m (98.4)		-		-		-		-	

\*1 In case it is necessary to indicate the air flow volume in (l/s), the value in (m<sup>3</sup>/min.) shall be multiplied by 16.7 and rounded down the decimal point.

\*2 If the EUROVENT Certified models can be operated under the "extra-low" temperature condition, -7°C dry bulb and -8°C wet-bulb temperatures with rated voltage 230V shall be used.

\*3 Network Impedance shall be applicable for EUROPE and CHINA models.

\*4 The annual consumption is calculated by multiplying the input power at 230V(400V) by an average of 500 hours per year in cooling mode.

\*5 EER and COP classification is at 230V(400V) only in accordance with EU directive 2002/31/EC.

\*6 SEER and SCOP classification is at 230V(400V) only in accordance with EN-14825. For heating, SCOP indicates the value of only Average heating season, Other fiche data indicates in an attached sheet

\*7 H: High at setting 5 stage (Level 5), M: Middle at setting 5 stage (Level 3), L: Low at setting 5 stage (Level 1)



# Simultaneous (Twin) -Type

## 1-1. Unit Specifications

PZ2

### 3. Wall Mounted Type S-60PK2E5B×2 / U-125PZ2E5

INDOOR		MODEL	S-60PK2E5B ×2			-			-		
PANEL		MODEL	-			-			-		
OUTDOOR		MODEL	-			U-125PZ2E5			-		
Branch pipe		MODEL	-			CZ-P155BK1			-		
Performance test condition					ISO5151 / EN14511 / EN12102/ EN14825						
Power supply		Ø, Hz	1Ø 50Hz			1Ø 50Hz			Min	Max	
		V	220V	230V	240V	220V	230V	240V			
C O O L I N G	Capacity	kW	12.5	12.5	12.5	-	-	-	3.2	13.2	
		BTU/h	42700	42700	42700	-	-	-	10900	45000	
	Current	A	0.60×2	0.59×2	0.58×2	18.3	17.5	16.8	-	-	
		W	60×2	60×2	60×2	3.780k	3.780k	3.780k	-	-	
	Input power	TOTAL W	-			3.900k	3.900k	3.900k	600	4.800k	
		Annual consumption	TOTAL kWh **	-			-	1950	-	-	-
	EER/EER CLASS	TOTAL (W/W) **/ ("A"-~"G")	-	-	-	3.21	3.21/A	3.21	5.33	2.75	
	Erp *6	Pdesign	kW	-	-	-	-	12.5	-	-	-
		η <sub>s.c</sub>	%	-	-	-	-	237	-	-	-
		Annual consumption	kWh	-	-	-	-	-	-	-	-
Class			-	-	-	-	-	-	-	-	
Power factor	%	-	-	-	94	94	94	-	-		
Noise indoor	dB-A (H/M/L) *7	47×2/44×2/40×2			-			-	-		
	Power Level dB	63×2/60×2/56×2			-			-	-		
Noise outdoor	dB-A (H/L)	-			55/-			-	-		
	Power Level dB	-			73/-			-	-		
H E A T I N G	Capacity	kW	12.5	12.5	12.5	-	-	-	3.3	15.0	
		BTU/h	42700	42700	42700	-	-	-	11300	51200	
	Current	A	0.60×2	0.59×2	0.58×2	15.7	15.0	14.4	-	-	
		W	60×2	60×2	60×2	3.240k	3.240k	3.240k	-	-	
	Input power	TOTAL W	-			3.360k	3.360k	3.360k	600	4.600k	
		COP/COP CLASS	TOTAL (W/W) **/ ("A"-~"G")	-	-	-	3.72	3.72/A	3.72	5.50	3.26
	Erp *6	Pdesign at -10°C	kW	-	-	-	-	12.5	-	-	-
		Tbivalent	°C	-	-	-	-	-7	-	-	-
		η <sub>s.h</sub>	%	-	-	-	-	139.7	-	-	-
		Annual consumption	kWh	-	-	-	-	-	-	-	-
elbu(-10°C)		kW	-	-	-	-	2.40	-	-	-	
Class			-	-	-	-	-	-	-	-	
Power factor	%	-	-	-	94	94	94	-	-		
Noise indoor	dB-A (H/M/L) *7	47×2/44×2/40×2			-			-	-		
	Power Level dB	63×2/60×2/56×2			-			-	-		
Noise outdoor	dB-A (H/L)	-			55/-			-	-		
	Power Level dB	-			73/-			-	-		
EXTRA LOW TEMP   Total capacity(kW) / Input power(W) / COP											
Max Current(A) / Max Input power(W)		0.60×2/60×2	0.59×2/60×2	0.58×2/60×2	29.0/6.00k	29.0/6.30k	29.0/6.60k	-			
Starting current(A) (Cooling/Heating)		-	-	-	18.3/15.7	17.5/15.0	16.8/14.4	-			
Comp output(W)		-			2.80k	2.80k	2.80k	-			
Network Impedance(ΩMAX.)		-			-			-			
Fan motor output (Indoor/Outdoor) W		54			120			-			
Moisture removal volume		L/h(Pt/h)	4.0	(2.0×2)	(8.4)	-			-		
External static pressure		Pa	-			-			-		
Indoor Air flow *7	Cooling	m³/min (ft³/min)	20.0×2/17.5×2/14.5×2 (706×2)/(618×2)/(512×2)			-			-	-	
	Heating	m³/min (ft³/min)	20.0×2/17.5×2/14.5×2 (706×2)/(618×2)/(512×2)			-			-	-	
Outdoor Air flow	Cooling	m³/min (ft³/min)	-			86.0 (3037)			-	-	
	Heating	m³/min (ft³/min)	-			78.0 (2754)			-	-	
Refrigerant type / amount g(oz)		-			R32	2.98k	(105.1)	-			
Product dimension	Height	mm(inch)	302 (11-29/32)			996 (39- 7/32)			-		
	Width	mm(inch)	1120 (44-3/32)			980 (38-37/64)			-		
	Depth	mm(inch)	236 (9-9/32)			370 (14- 9/16)			-		
Product dimension (Panel)		H×W×D mm, inch	-			-			-		
Packing dimension	Height	mm(inch)	282 (11-1/8)			1134 (44-41/64)			-		
	Width	mm(inch)	1190 (46-7/8)			1095 (43-7/64)			-		
	Depth	mm(inch)	378 (14-29/32)			529 (20-53/64)			-		
Weight	(NET)	kg(lb)	14 (31)			94 (207)			-		
	(GROSS)	kg(lb)	17 (38)			102 (224)			-		
	Panel (NET)	kg(lb)	-			-			-		
Layers limit (actually)		11(12)			2 (3)			-			
Operation condition	Cool (DBT)	18°C ~ 32°C			-10°C ~ 43°C			-			
	Heat (DBT)	16°C ~ 30°C			-15°C ~ 24°C			-			
MAX WORKING PRESSURE HP/LP MPa (bar)					4.15/2.55 (41.5/25.5)						
P I P I N G	Pipe diameter mm (inch)		(Liquid)Ø9.52(3/8) (Gas)Ø15.88(5/8)			(Liquid)Ø9.52(3/8) (Gas)Ø15.88(5/8)			-		
	Connecting method, Standard length m(ft)		flared type, 5.0(16.4)			flared type, 5.0(16.4)			-		
Pipe length range		m (ft)		5 ~ 50m (16.4 ~ 164.0)							
Indoor unit & Outdoor unit height difference		m (ft)		15m(OD located lower)/30m(OD located higher) (49.2/98.4)							
Add gas amount		g/m (oz/ft)		45g/m (0.484)							
Pipe length for additional gas		m (ft)		30m (98.4)							

\*1 In case it is necessary to indicate the air flow volume in (l/s), the value in (m³/min.) shall be multiplied by 16.7 and rounded down the decimal point.  
 \*2 If the EUROVENT Certified models can be operated under the "extra-low" temperature condition, -7°C dry bulb and -8°C wet-bulb temperatures with rated voltage 230V shall be used.  
 \*3 Network Impedance shall be applicable for EUROPE and CHINA models.  
 \*4 The annual consumption is calculated by multiplying the input power at 230V(400V) by an average of 500 hours per year in cooling mode.  
 \*5 EER and COP classification is at 230V(400V) only in accordance with EU directive 2002/31/EC.  
 \*6 η<sub>s.c</sub> and η<sub>s.h</sub> classification is at 230V(400V) only in accordance with EN-14825. For heating, η<sub>s.h</sub> indicates the value of only Average heating season.  
 \*7 H: High at setting 5 stage (Level 5), M: Middle at setting 5 stage (Level 3), L: Low at setting 5 stage (Level 1)

# 1 Simultaneous (Twin) -Type

## 1-1. Unit Specifications

**PZ2**

### 3. Wall Mounted Type S-71PK2E5B×2 / U-140PZ2E5

INDOOR		MODEL	S-71PK2E5B ×2			-			-		
PANEL		MODEL	-			-			-		
OUTDOOR		MODEL	-			U-140PZ2E5			-		
Branch pipe		MODEL	-			CZ-P155BK1			-		
Performance test condition					ISO5151 / EN14511 / EN12102/ EN14825						
Power supply		Ø, Hz	1Ø 50Hz			1Ø 50Hz			Min	Max	
		V	220V	230V	240V	220V	230V	240V			
C O O L I N G	Capacity	kW	14.0	14.0	14.0	-	-	-	3.3	15.0	
		BTU/h	47800	47800	47800	-	-	-	11300	51200	
	Current	A	0.60×2	0.59×2	0.58×2	22.8	21.9	20.9	-	-	
		W	60×2	60×2	60×2	4.720k	4.720k	4.720k	-	-	
	Input power	TOTAL W	-	-	-	4.840k	4.840k	4.840k	620	5.600k	
		TOTAL kWh **	-	-	-	-	2420	-	-	-	
	Annual consumption	TOTAL kWh **	-	-	-	-	2420	-	-	-	
	EER/EER CLASS	TOTAL (W/W) **/ ("A"-~"G")	-	-	-	2.89	2.89/C	2.89	5.32	2.68	
	Erp *6	Pdesign	kW	-	-	-	-	14.0	-	-	-
		η <sub>s.c</sub>	%	-	-	-	-	228.6	-	-	-
Annual consumption		kWh	-	-	-	-	-	-	-	-	
Class			-	-	-	-	-	-	-	-	
Power factor	%	-	-	-	94	94	94	-	-		
Noise indoor	dB-A (H/M/L) *7	47×2/44×2/40×2			-			-	-		
	Power Level dB	63×2/60×2/56×2			-			-	-		
Noise outdoor	dB-A (H/L)	-			56/-			-	-		
	Power Level dB	-			74/-			-	-		
H E A T I N G	Capacity	kW	14.0	14.0	14.0	-	-	-	3.4	16.0	
		BTU/h	47800	47800	47800	-	-	-	11600	54600	
	Current	A	0.60×2	0.59×2	0.58×2	18.5	17.7	17.0	-	-	
		W	60×2	60×2	60×2	3.830k	3.830k	3.830k	-	-	
	Input power	TOTAL W	-	-	-	3.950k	3.950k	3.950k	620	5.000k	
		TOTAL kWh **	-	-	-	-	3.54	3.54/B	3.54	5.48	3.20
	COP/COP CLASS	TOTAL (W/W) **/ ("A"-~"G")	-	-	-	3.54	3.54/B	3.54	5.48	3.20	
	Erp *6	Pdesign at -10°C	kW	-	-	-	-	13.6	-	-	-
		Tbivalent	°C	-	-	-	-	-7	-	-	-
		η <sub>s.h</sub>	%	-	-	-	-	137.7	-	-	-
Annual consumption		kWh	-	-	-	-	-	-	-	-	
Class	elbu(-10°C)	kW	-	-	-	-	2.80	-	-	-	
			-	-	-	-	-	-	-	-	
Power factor	%	-	-	-	94	94	94	-	-		
Noise indoor	dB-A (H/M/L) *7	47×2/44×2/40×2			-			-	-		
	Power Level dB	63×2/60×2/56×2			-			-	-		
Noise outdoor	dB-A (H/L)	-			56/-			-	-		
	Power Level dB	-			74/-			-	-		
EXTRA LOW TEMP   Total capacity(kW) / Input power(W) / COP											
Max Current(A) / Max Input power(W)		0.60×2/60×2	0.59×2/60×2	0.58×2/60×2	30.0/6.25k	30.0/6.50k	30.0/6.80k				
Starting current(A) (Cooling/Heating)		-	-	-	22.8/18.5	21.9/17.7	20.9/17.0				
Comp output(W)						3.00k	3.00k	3.00k			
Network Impedance(ΩMAX.)											
Fan motor output (Indoor/Outdoor) W				54		120					
Moisture removal volume		L/h(Pt/h)	6.0	(3.0×2)	(12.6)						
External static pressure		Pa									
Indoor Air flow *7	Cooling	m³/min (ft³/min)	20.0×2/17.5×2/14.5×2 (706×2)/(618×2)/(512×2)						-	-	
	Heating	m³/min (ft³/min)	20.0×2/17.5×2/14.5×2 (706×2)/(618×2)/(512×2)						-	-	
Outdoor Air flow	Cooling	m³/min (ft³/min)				89.0 (3143)			-	-	
	Heating	m³/min (ft³/min)				83.0 (2931)			-	-	
Refrigerant type / amount g(oz)						R32	2.98k	(105.1)			
Product dimension	Height	mm(inch)	302 (11-29/32)			996 (39- 7/32)					
	Width	mm(inch)	1120 (44-3/32)			980 (38-37/64)					
	Depth	mm(inch)	236 (9-9/32)			370 (14- 9/16)					
Product dimension (Panel)		H×W×D mm, inch									
Packing dimension	Height	mm(inch)	282 (11-1/8)			1134 (44-41/64)					
	Width	mm(inch)	1190 (46-7/8)			1095 (43-7/64)					
	Depth	mm(inch)	378 (14-29/32)			529 (20-53/64)					
Weight	(NET)	kg(lb)	14 (31)			94 (207)					
	(GROSS)	kg(lb)	17 (38)			102 (224)					
	Panel (NET)	kg(lb)									
Layers limit (actually)				11(12)		2 (3)					
Operation condition	Cool (DBT)	18°C ~ 32°C			-10°C ~ 43°C						
	Heat (DBT)	16°C ~ 30°C			-15°C ~ 24°C						
MAX WORKING PRESSURE HP/LP MPa (bar)						4.15/2.55 (41.5/25.5)					
P I	Pipe diameter mm (inch)	(Liquid)Ø9.52(3/8) (Gas)Ø15.88(5/8)			(Liquid)Ø9.52(3/8) (Gas)Ø15.88(5/8)						
	Connecting method, Standard length m(ft)	flared type, 5.0(16.4)			flared type, 5.0(16.4)						
P I	Pipe length range m (ft)			5 ~ 50m (16.4 ~ 164.0)							
	Indoor unit & Outdoor unit height difference m (ft)			15m(OD located lower)/30m(OD located higher) (49.2/98.4)							
N G	Add gas amount g/m (oz/ft)			45g/m (0.484)							
	Pipe length for additional gas m (ft)			30m (98.4)							

\*1 In case it is necessary to indicate the air flow volume in (l/s), the value in (m³/min.) shall be multiplied by 16.7 and rounded down the decimal point.  
\*2 If the EUROVENT Certified models can be operated under the "extra-low" temperature condition, -7°C dry bulb and -8°C wet-bulb temperatures with rated voltage 230V shall be used.  
\*3 Network Impedance shall be applicable for EUROPE and CHINA models.  
\*4 The annual consumption is calculated by multiplying the input power at 230V(400V) by an average of 500 hours per year in cooling mode.  
\*5 EER and COP classification is at 230V(400V) only in accordance with EU directive 2002/31/EC.  
\*6 η<sub>s.c</sub> and η<sub>s.h</sub> classification is at 230V(400V) only in accordance with EN-14825. For heating, η<sub>s.h</sub> indicates the value of only Average heating season.  
\*7 H: High at setting 5 stage (Level 5), M: Middle at setting 5 stage (Level 3), L: Low at setting 5 stage (Level 1)

# Single -Type

## 1-1. Unit Specifications

PZ2

### 3. Wall Mounted Type S-100PK2E5B / U-100PZ2E5

INDOOR		MODEL	S-100PK2E5B			-			-		
PANEL		MODEL	-			-			-		
OUTDOOR		MODEL	-			U-100PZ2E5			-		
Branch pipe		MODEL	-			-			-		
Performance test condition					ISO5151 / EN14511 / EN12102/ EN14825						
Power supply		Ø, Hz	1Ø 50Hz			1Ø 50Hz			Min	Max	
		V	220V	230V	240V	220V	230V	240V			
Capacity		kW	9.0	9.0	9.0	-	-	-	3.0	9.7	
		BTU/h	30700	30700	30700	-	-	-	10200	33100	
Current		A	0.70	0.68	0.66	12.1	11.5	11.1	-	-	
Input power		W	75	75	75	2.515k	2.515k	2.515k	-	-	
		TOTAL W	-	-	-	2.590k	2.590k	2.590k	560	3.100k	
Annual consumption		TOTAL kWh **	-	-	-	-	1295	-	-	-	
EER/EER CLASS		TOTAL (W/W) <sup>15</sup> / ("A"~"G")	-	-	-	3.47	3.47/A	3.47	5.36	3.13	
C O L I N G	Erp *6	Pdesign	kW	-	-	-	9.0	-	-	-	
		SEER	(W/W)	-	-	-	6.5	-	-	-	
		Annual consumption	kWh	-	-	-	-	485	-	-	-
		Class		-	-	-	-	A++	-	-	-
		Power factor	%	-	-	-	95	95	95	-	-
Noise indoor	dB-A (H/M/L) *7		49/45/41			-			-	-	
	Power Level dB		65/61/57			-			-	-	
Noise outdoor	dB-A (H/L)		-			52/-			-	-	
	Power Level dB		-			70/-			-	-	
H E A T I N G	Erp *6	Capacity	kW	9.0	9.0	9.0	-	-	-	3.0	10.5
			BTU/h	30700	30700	30700	-	-	-	10200	35800
		Current	A	0.70	0.68	0.66	10.6	10.2	9.70	-	-
		Input power	W	75	75	75	2.215k	2.215k	2.215k	-	-
			TOTAL W	-	-	-	2.290k	2.290k	2.290k	560	2.950k
COP/COP CLASS		TOTAL (W/W) <sup>15</sup> / ("A"~"G")	-	-	-	3.93	3.93 /A	3.93	5.36	3.56	
Erp *6	Pdesign at -10°C	kW	-	-	-	-	9.0	-	-	-	
	Tbivalent	°C	-	-	-	-	-7	-	-	-	
	SCOP	(W/W)	-	-	-	-	3.9	-	-	-	
	Annual consumption	kWh	-	-	-	-	3231	-	-	-	
	elbu(-10°C)	kW	-	-	-	-	1.25	-	-	-	
Class		-	-	-	-	A	-	-	-		
Power factor	%	-	-	-	95	95	95	-	-		
Noise indoor	dB-A (H/M/L) *7		49/45/41			-			-	-	
	Power Level dB		65/61/57			-			-	-	
Noise outdoor	dB-A (H/L)		-			52/-			-	-	
	Power Level dB		-			70/-			-	-	
EXTRA LOW TEMP   Total capacity(kW) / Input power(W) / COP											
Max Current(A) / Max Input power(W)			0.70/75	0.68/75	0.66/75	25.0/5.25k	25.0/5.50k	25.0/5.70k	-		
Starting current(A) (Cooling/Heating)			-	-	-	12.1/10.6	11.5/10.2	11.1/9.70	-		
Comp output(W)						2.50k	2.50k	2.50k	-		
Network Impedance(ΩMAX.)						-			-		
Fan motor output (Indoor/Outdoor) W			54			120			-		
Moisture removal volume			L/h(Pt/h)	4.3	(9.0)	-			-		
External static pressure			Pa	-			-			-	
Indoor Air flow *7	Cooling	m³/min (ft³/min)	22.0 / 18.5 /15.0 (777) / (653) /(530)			-			-	-	
	Heating	m³/min (ft³/min)	22.0 / 18.5 /15.0 (777) / (653) /(530)			-			-	-	
Outdoor Air flow	Cooling	m³/min (ft³/min)	-			76.0 (2683)			-	-	
	Heating	m³/min (ft³/min)	-			70.0 (2472)			-	-	
Refrigerant type / amount g(oz)						R32	2.60k	(91.7)	-		
Product dimension	Height	mm(inch)	302 (11-29/32)			996 (39- 7/32)			-		
	Width	mm(inch)	1120 (44-3/32)			980 (38-37/64)			-		
	Depth	mm(inch)	236 (9-9/32)			370 (14- 9/16)			-		
Product dimension (Panel)		H×W×D mm, inch	-			-			-		
Packing dimension	Height	mm(inch)	282 (11-1/8)			1134 (44-41/64)			-		
	Width	mm(inch)	1190 (46-7/8)			1095 (43-7/64)			-		
	Depth	mm(inch)	378 (14-29/32)			529 (20-53/64)			-		
Weight	(NET)	kg(lb)	14 (31)			90 (199)			-		
	(GROSS)	kg(lb)	17 (38)			98 (216)			-		
	Panel (NET)	kg(lb)	-			-			-		
Layers limit (actually)			11(12)			2 (3)			-		
Operation condition	Cool (DBT)		18°C ~ 32°C			-10°C ~ 43°C			-		
	Heat (DBT)		16°C ~ 30°C			-15°C ~ 24°C			-		
MAX WORKING PRESSURE		HP/LP MPa (bar)	4.15/2.55 (41.5/25.5)			-			-		
P I P I N G	Pipe diameter	mm (inch)	(Liquid)Ø9.52(3/8) (Gas)Ø15.88(5/8)			(Liquid)Ø9.52(3/8) (Gas)Ø15.88(5/8)			-		
	Connecting method, Standard length	m(ft)	flared type, 5.0(16.4)			flared type, 5.0(16.4)			-		
Pipe length range		m (ft)	5 ~ 50m (16.4 ~ 164.0)			-			-		
Indoor unit & Outdoor unit height difference		m (ft)	15m(OD located lower)/30m(OD located higher) (49.2/98.4)			-			-		
Add gas amount		g/m (oz/ft)	45g/m (0.484)			-			-		
Pipe length for additional gas		m (ft)	30m (98.4)			-			-		

\*1 In case it is necessary to indicate the air flow volume in (l/s), the value in (m³/min.) shall be multiplied by 16.7 and rounded down the decimal point.  
 \*2 If the EUROVENT Certified models can be operated under the "extra-low"temperature condition, -7°C dry bulb and -8°C wet-bulb temperatures with rated voltage 230V shall be used.  
 \*3 Network Impedance shall be applicable for EUROPE and CHINA models.  
 \*4 The annual consumption is calculated by multiplying the input power at 230V(400V) by an average of 500 hours per year in cooling mode.  
 \*5 EER and COP classification is at 230V(400V) only in accordance with EU directive 2002/31/EC.  
 \*6 SEER and SCOP classification is at 230V(400V) only in accordance with EN-14825. For heating, SCOP indicates the value of only Average heating season, Other fiche data indicates in an attached sheet  
 \*7 H: High at setting 5 stage (Level 5), M: Middle at setting 5 stage (Level 3), L: Low at setting 5 stage (Level 1)

# Simultaneous (Twin) -Type

## 1-1. Unit Specifications

**PZ2**

### 3. Wall Mounted Type S-50PK2E5Bx2 / U-100PZ2E8

INDOOR		MODEL	S-50PK2E5B ×2			-			-		
PANEL		MODEL	-			-			-		
OUTDOOR		MODEL	-			U-100PZ2E8			-		
Branch pipe		MODEL	-			CZ-P155BK1			-		
Performance test condition					ISO5151 / EN14511 / EN12102/ EN14825						
Power supply		Ø, Hz	1Ø 50Hz			3Ø 50Hz			Min	Max	
		V	220V	230V	240V	380V	400V	415V			
C O O L I N G	Capacity	kW	10.0	10.0	10.0	-	-	-	3.0	11.0	
		BTU/h	34100	34100	34100	-	-	-	10200	37500	
	Current	A	0.40×2	0.39×2	0.38×2	7.95	7.55	7.30	-	-	
		W	35×2	35×2	35×2	2.810k	2.810k	2.810k	-	-	
	Input power	TOTAL W	-			2.880k	2.880k	2.880k	560	4.000k	
		Annual consumption	TOTAL kWh **	-			-	1440	-	-	-
	EER/EER CLASS	TOTAL (W/W) <sup>1)</sup> ("A"~"G")	-	-	-	3.47	3.47/A	3.47	5.36	2.75	
	Erp <sup>5)</sup>	Pdesign	kW	-	-	-	-	10.0	-	-	-
		SEER	(W/W)	-	-	-	-	6.4	-	-	-
		Annual consumption	kWh	-	-	-	-	547	-	-	-
		Class		-	-	-	-	A++	-	-	-
	Power factor	%	-	-	-	93	93	93	-	-	
	Noise indoor	dB-A (H/M/L) <sup>7)</sup>	40×2 / 36×2 / 32×2			-			-	-	
		Power Level dB	56×2 / 52×2 / 48×2			-			-	-	
Noise outdoor	dB-A (H/L)	-			52/-			-	-		
	Power Level dB	-			70/-			-	-		
H E A T I N G	Capacity	kW	10.0	10.0	10.0	-	-	-	3.0	12.4	
		BTU/h	34100	34100	34100	-	-	-	10200	42300	
	Current	A	0.40×2	0.39×2	0.38×2	7.00	6.65	6.40	-	-	
		W	35×2	35×2	35×2	2.470k	2.470k	2.470k	-	-	
	Input power	TOTAL W	-			2.540k	2.540k	2.540k	560	3.900k	
		COP/COP CLASS	TOTAL (W/W) <sup>1)</sup> ("A"~"G")	-	-	-	3.94	3.94/A	3.94	5.36	3.18
	Erp <sup>5)</sup>	Pdesign at -10°C	kW	-	-	-	-	10.0	-	-	-
		Tbivalent	°C	-	-	-	-	-7	-	-	-
		SCOP	(W/W)	-	-	-	-	3.9	-	-	-
		Annual consumption	kWh	-	-	-	-	3590	-	-	-
	Class	elbu(-10°C)	kW	-	-	-	-	1.69	-	-	-
				-	-	-	-	A	-	-	-
	Power factor	%	-	-	-	93	93	93	-	-	
	Noise indoor	dB-A (H/M/L) <sup>7)</sup>	40×2 / 36×2 / 32×2			-			-	-	
Power Level dB		56×2 / 52×2 / 48×2			-			-	-		
Noise outdoor	dB-A (H/L)	-			52/-			-	-		
	Power Level dB	-			70/-			-	-		
EXTRA LOW TEMP Total capacity(kW) / Input power(W) / COP											
Max Current(A) / Max Input power(W)		0.40×2/35×2	0.39×2/35×2	0.38×2/35×2	9.00/5.55k	9.00/5.80k	9.00/6.05k	-			
Starting current(A) (Cooling/Heating)		-	-	-	7.95/7.00	7.55/6.65	7.30/6.40	-			
Comp output(W)		-			2.50k	2.50k	2.50k	-			
Network Impedance(ΩMAX.)		-			-			-			
Fan motor output (Indoor/Outdoor) W		54			120			-			
Moisture removal volume		L/h(Pt/h)	3.6	(1.8×2)	(7.6)	-			-		
External static pressure		Pa	-			-			-		
Indoor Air flow <sup>7)</sup>	Cooling	m <sup>3</sup> /min (ft <sup>3</sup> /min)	16.0×2/13.5×2/11.0×2 (565×2)/(477×2)/(388×2)			-			-	-	
	Heating	m <sup>3</sup> /min (ft <sup>3</sup> /min)	16.0×2/13.5×2/11.0×2 (565×2)/(477×2)/(388×2)			-			-	-	
Outdoor Air flow	Cooling	m <sup>3</sup> /min (ft <sup>3</sup> /min)	-			76.0 (2683)			-	-	
	Heating	m <sup>3</sup> /min (ft <sup>3</sup> /min)	-			70.0 (2472)			-	-	
Refrigerant type / amount g(oz)		-			R32	2.60k	(91.7)	-			
Product dimension	Height	mm(inch)	302 (11-29/32)			996 (39- 7/32)			-		
	Width	mm(inch)	1120 (44-3/32)			980 (38-37/64)			-		
	Depth	mm(inch)	236 (9-9/32)			370 (14- 9/16)			-		
Product dimension (Panel)		H×W×D mm, inch	-			-			-		
Packing dimension	Height	mm(inch)	282 (11-1/8)			1134 (44-41/64)			-		
	Width	mm(inch)	1190 (46-7/8)			1095 (43-7/64)			-		
	Depth	mm(inch)	378 (14-29/32)			529 (20-53/64)			-		
Weight	(NET)	kg(lb)	13 (29)			90 (199)			-		
	(GROSS)	kg(lb)	16 (36)			98 (216)			-		
	Panel (NET)	kg(lb)	-			-			-		
Layers limit (actually)		11(12)			2 (3)			-			
Operation condition	Cool (DBT)	18°C ~ 32°C			-10°C ~ 43°C			-			
	Heat (DBT)	16°C ~ 30°C			-15°C ~ 24°C			-			
MAX WORKING PRESSURE HP/LP MPa (bar)		4.15/2.55 (41.5/25.5)			-			-			
P I	Pipe diameter mm (inch)	(Liquid)Ø6.35(1/4) (Gas)Ø12.7(1/2)			(Liquid)Ø9.52(3/8) (Gas)Ø15.88(5/8)			-			
	Connecting method, Standard length m(ft)	flared type, 5.0(16.4)			flared type, 5.0(16.4)			-			
P I	Pipe length range m (ft)	5 ~ 50m (16.4 ~ 164.0)			-			-			
N G	Indoor unit & Outdoor unit height difference m (ft)	15m(OD located lower)/30m(OD located higher) (49.2/98.4)			-			-			
	Add gas amount g/m (oz/ft)	45g/m (0.484)			-			-			
N G	Pipe length for additional gas m (ft)	30m (98.4)			-			-			

\*1 In case it is necessary to indicate the air flow volume in (l/s), the value in (m<sup>3</sup>/min.) shall be multiplied by 16.7 and rounded down the decimal point.

\*2 If the EUROVENT Certified models can be operated under the "extra-low" temperature condition, -7°C dry bulb and -8°C wet-bulb temperatures with rated voltage 230V shall be used.

\*3 Network Impedance shall be applicable for EUROPE and CHINA models.

\*4 The annual consumption is calculated by multiplying the input power at 230V(400V) by an average of 500 hours per year in cooling mode.

\*5 EER and COP classification is at 230V(400V) only in accordance with EU directive 2002/31/EC.

\*6 SEER and SCOP classification is at 230V(400V) only in accordance with EN-14825. For heating, SCOP indicates the value of only Average heating season, Other fiche data indicates in an attached sheet

\*7 H: High at setting 5 stage (Level 5), M: Middle at setting 5 stage (Level 3), L: Low at setting 5 stage (Level 1)

# Simultaneous (Twin) -Type

## 1-1. Unit Specifications

**PZ2**

### 3. Wall Mounted Type S-60PK2E5B×2 / U-125PZ2E8

INDOOR		MODEL	S-60PK2E5B ×2			-			-				
PANEL		MODEL	-			-			-				
OUTDOOR		MODEL	-			U-125PZ2E8			-				
Branch pipe		MODEL	-			CZ-P155BK1			-				
Performance test condition					ISO5151 / EN14511 / EN12102/ EN14825								
Power supply		Ø, Hz	1Ø 50Hz			3Ø 50Hz							
		V	220V	230V	240V	380V	400V	415V	Min	Max			
C O O L I N G	Capacity	kW	12.5	12.5	12.5	-	-	-	3.2	13.2			
		BTU/h	42700	42700	42700	-	-	-	10900	45000			
	Current	A	0.60×2	0.59×2	0.58×2	10.6	10.1	9.70	-	-			
		W	60×2	60×2	60×2	3.780k	3.780k	3.780k	-	-			
	Input power	TOTAL W	-			3.900k	3.900k	3.900k	600	4.800k			
		Annual consumption	TOTAL kWh **	-			-	1950	-	-	-		
	EER/EER CLASS	TOTAL (W/W) **/ ("A"-~"G")	-	-	-	3.21	3.21/A	3.21	5.33	2.75			
	Erp *6	Pdesign	kW	-	-	-	-	12.5	-	-	-		
		η <sub>s.c</sub>	%	-	-	-	-	236.3	-	-	-		
		Annual consumption	kWh	-	-	-	-	-	-	-	-		
Class			-	-	-	-	-	-	-	-			
Power factor	%	-	-	-	94	94	94	-	-				
Noise indoor	dB-A (H/M/L) *7	47×2/44×2/40×2			-			-	-				
	Power Level dB	63×2/60×2/56×2			-			-	-				
Noise outdoor	dB-A (H/L)	-			55/-			-	-				
	Power Level dB	-			73/-			-	-				
H E A T I N G	Capacity	kW	12.5	12.5	12.5	-	-	-	3.3	15.0			
		BTU/h	42700	42700	42700	-	-	-	11300	51200			
	Current	A	0.60×2	0.59×2	0.58×2	9.05	8.60	8.30	-	-			
		W	60×2	60×2	60×2	3.240k	3.240k	3.240k	-	-			
	Input power	TOTAL W	-			3.360k	3.360k	3.360k	600	4.600k			
		COP/COP CLASS	TOTAL (W/W) **/ ("A"-~"G")	-	-	-	3.72	3.72/A	3.72	5.50	3.26		
	Erp *6	Pdesign at -10°C	kW	-	-	-	-	12.5	-	-	-		
		Tbivalent	°C	-	-	-	-	-7	-	-	-		
		η <sub>s.h</sub>	%	-	-	-	-	139.7	-	-	-		
		Annual consumption	kWh	-	-	-	-	-	-	-	-		
Class	elbu(-10°C)	kW	-	-	-	-	2.40	-	-	-			
	Class		-	-	-	-	-	-	-	-			
Power factor	%	-	-	-	94	94	94	-	-				
Noise indoor	dB-A (H/M/L) *7	47×2/44×2/40×2			-			-	-				
	Power Level dB	63×2/60×2/56×2			-			-	-				
Noise outdoor	dB-A (H/L)	-			55/-			-	-				
	Power Level dB	-			73/-			-	-				
EXTRA LOW TEMP   Total capacity(kW) / Input power(W) / COP													
Max Current(A) / Max Input power(W)		0.60×2/60×2		0.59×2/60×2		0.58×2/60×2		10.0 /6.20k		10.0 /6.50k		10.0 /6.75k	
Starting current(A) (Cooling/Heating)		-		-		-		10.6/9.05		10.1/8.60		9.70/8.30	
Comp output(W)		-		-		-		2.80k		2.80k		2.80k	
Network Impedance(ΩMAX.)		-		-		-		-		-		-	
Fan motor output (Indoor/Outdoor) W		-		54		-		120		-		-	
Moisture removal volume		L/h(Pt/h)		4.0		(2.0×2)		(8.4)		-		-	
External static pressure		Pa		-		-		-		-		-	
Indoor Air flow *7	Cooling	m³/min (ft³/min)		20.0×2/17.5×2/14.5×2 (706×2)/(618×2)/(512×2)		-		-		-		-	
	Heating	m³/min (ft³/min)		20.0×2/17.5×2/14.5×2 (706×2)/(618×2)/(512×2)		-		-		-		-	
Outdoor Air flow	Cooling	m³/min (ft³/min)		-		-		86.0 (3037)		-		-	
	Heating	m³/min (ft³/min)		-		-		78.0 (2754)		-		-	
Refrigerant type / amount g(oz)		-		-		-		R32		2.98k		(105.1)	
Product dimension	Height	mm(inch)		302 (11-29/32)		-		996 (39- 7/32)		-		-	
	Width	mm(inch)		1120 (44-3/32)		-		980 (38-37/64)		-		-	
	Depth	mm(inch)		236 (9-9/32)		-		370 (14- 9/16)		-		-	
Product dimension (Panel)		H×W×D mm, inch		-		-		-		-		-	
Packing dimension	Height	mm(inch)		282 (11-1/8)		-		1134 (44-41/64)		-		-	
	Width	mm(inch)		1190 (46-7/8)		-		1095 (43-7/64)		-		-	
	Depth	mm(inch)		378 (14-29/32)		-		529 (20-53/64)		-		-	
Weight	(NET)	kg(lb)		14 (31)		-		94 (207)		-		-	
	(GROSS)	kg(lb)		17 (38)		-		102 (224)		-		-	
	Panel (NET)	kg(lb)		-		-		-		-		-	
Layers limit (actually)				11(12)		-		2 (3)		-		-	
Operation condition	Cool (DBT)			18°C ~ 32°C		-		-10°C ~ 43°C		-		-	
	Heat (DBT)			16°C ~ 30°C		-		-15°C ~ 24°C		-		-	
MAX WORKING PRESSURE HP/LP MPa (bar)					4.15/2.55 (41.5/25.5)								
P	Pipe diameter mm (inch)		(Liquid)Ø9.52(3/8) (Gas)Ø15.88(5/8)			(Liquid)Ø9.52(3/8) (Gas)Ø15.88(5/8)			-				
	Connecting method, Standard length m(ft)		flared type, 5.0(16.4)			flared type, 5.0(16.4)			-				
P	Pipe length range m (ft)		5 ~ 50m (16.4 ~ 164.0)					-					
I	Indoor unit & Outdoor unit height difference m (ft)		15m(OD located lower)/30m(OD located higher) (49.2/98.4)					-					
N	Add gas amount g/m (oz/ft)		45g/m (0.484)					-					
G	Pipe length for additional gas m (ft)		30m (98.4)					-					

\*1 In case it is necessary to indicate the air flow volume in (l/s), the value in (m³/min.) shall be multiplied by 16.7 and rounded down the decimal point.  
 \*2 If the EUROVENT Certified models can be operated under the "extra-low" temperature condition, -7°C dry bulb and -8°C wet-bulb temperatures with rated voltage 230V shall be used.  
 \*3 Network Impedance shall be applicable for EUROPE and CHINA models.  
 \*4 The annual consumption is calculated by multiplying the input power at 230V(400V) by an average of 500 hours per year in cooling mode.  
 \*5 EER and COP classification is at 230V(400V) only in accordance with EU directive 2002/31/EC.  
 \*6 η<sub>s.c</sub> and η<sub>s.h</sub> classification is at 230V(400V) only in accordance with EN-14825. For heating, η<sub>s.h</sub> indicates the value of only Average heating season.  
 \*7 H: High at setting 5 stage (Level 5), M: Middle at setting 5 stage (Level 3), L: Low at setting 5 stage (Level 1)

# Simultaneous (Twin) -Type

## 1-1. Unit Specifications

**PZ2**

### 3. Wall Mounted Type S-71PK2E5B×2 / U-140PZ2E8

INDOOR		MODEL	S-71PK2E5B ×2			-			-		
PANEL		MODEL	-			-			-		
OUTDOOR		MODEL	-			U-140PZ2E8			-		
Branch pipe		MODEL	-			CZ-P155BK1			-		
Performance test condition					ISO5151 / EN14511 / EN12102/ EN14825						
Power supply		Ø, Hz	1Ø 50Hz			3Ø 50Hz			Min	Max	
		V	220V	230V	240V	380V	400V	415V			
C O O L I N G	Capacity	kW	14.0	14.0	14.0	-	-	-	3.3	15.0	
		BTU/h	47800	47800	47800	-	-	-	11300	51200	
	Current	A	0.60×2	0.59×2	0.58×2	13.2	12.6	12.1	-	-	
		W	60×2	60×2	60×2	4.720k	4.720k	4.720k	-	-	
	Input power	TOTAL W	-	-	-	4.840k	4.840k	4.840k	620	5.600k	
		Annual consumption	TOTAL kWh **	-	-	-	2420	-	-	-	-
	EER/EER CLASS	TOTAL (W/W) <sup>1)</sup> ("A"-~"G")	-	-	-	2.89	2.89/C	2.89	5.32	2.68	
	Erp <sup>5)</sup>	P <sub>design</sub>	kW	-	-	-	-	14.0	-	-	-
		η <sub>s,c</sub>	%	-	-	-	-	228	-	-	-
		Annual consumption	kWh	-	-	-	-	-	-	-	-
		Class		-	-	-	-	-	-	-	-
	Power factor	%	-	-	-	94	94	94	-	-	
	Noise indoor	dB-A (H/M/L) <sup>7)</sup>	47×2/44×2/40×2			-			-	-	
		Power Level dB	63×2/60×2/56×2			-			-	-	
Noise outdoor	dB-A (H/L)	-			56/-			-	-		
	Power Level dB	-			74/-			-	-		
H E A T I N G	Capacity	kW	14.0	14.0	14.0	-	-	-	3.4	16.0	
		BTU/h	47800	47800	47800	-	-	-	11600	54600	
	Current	A	0.60×2	0.59×2	0.58×2	10.7	10.2	9.8	-	-	
		W	60×2	60×2	60×2	3.830k	3.830k	3.830k	-	-	
	Input power	TOTAL W	-	-	-	3.950k	3.950k	3.950k	620	5.000k	
		COP/COP CLASS	TOTAL (W/W) <sup>1)</sup> ("A"-~"G")	-	-	-	3.54	3.54/B	3.54	5.48	3.20
	Erp <sup>5)</sup>	P <sub>design</sub> at -10°C	kW	-	-	-	-	13.6	-	-	-
		T <sub>bivalent</sub>	°C	-	-	-	-	-7	-	-	-
		η <sub>s,h</sub>	%	-	-	-	-	137.7	-	-	-
		Annual consumption	kWh	-	-	-	-	-	-	-	-
		elbu(-10°C)	kW	-	-	-	-	2.80	-	-	-
		Class		-	-	-	-	-	-	-	-
	Power factor	%	-	-	-	94	94	94	-	-	
	Noise indoor	dB-A (H/M/L) <sup>7)</sup>	47×2/44×2/40×2			-			-	-	
Power Level dB		63×2/60×2/56×2			-			-	-		
Noise outdoor	dB-A (H/L)	-			56/-			-	-		
	Power Level dB	-			74/-			-	-		
EXTRA LOW TEMP Total capacity(kW) / Input power(W) / COP											
Max Current(A) / Max Input power(W)		0.60×2/60×2	0.59×2/60×2	0.58×2/60×2	10.5/6.50k	10.5/6.85k	10.5/7.10k				
Starting current(A) (Cooling/Heating)		-	-	-	13.2/10.7	12.6/10.2	12.1/9.80				
Comp output(W)						3.00k	3.00k	3.00k			
Network Impedance(ΩMAX.)											
Fan motor output (Indoor/Outdoor) W				54		120					
Moisture removal volume		L/h(Pt/h)	6.0	(3.0×2)	(12.6)						
External static pressure		Pa									
Indoor Air flow <sup>7)</sup>	Cooling	m <sup>3</sup> /min (ft <sup>3</sup> /min)	20.0×2/17.5×2/14.5×2 (706×2)/(618×2)/(512×2)						-	-	
	Heating	m <sup>3</sup> /min (ft <sup>3</sup> /min)	20.0×2/17.5×2/14.5×2 (706×2)/(618×2)/(512×2)						-	-	
Outdoor Air flow	Cooling	m <sup>3</sup> /min (ft <sup>3</sup> /min)				89.0 (3143)			-	-	
	Heating	m <sup>3</sup> /min (ft <sup>3</sup> /min)				83.0 (2931)			-	-	
Refrigerant type / amount g(oz)						R32	2.98k	(105.1)			
Product dimension	Height	mm(inch)	302 (11-29/32)			996 (39- 7/32)					
	Width	mm(inch)	1120 (44-3/32)			980 (38-37/64)					
	Depth	mm(inch)	236 (9-9/32)			370 (14- 9/16)					
Product dimension (Panel)		H×W×D mm, inch									
Packing dimension	Height	mm(inch)	282 (11-1/8)			1134 (44-41/64)					
	Width	mm(inch)	1190 (46-7/8)			1095 (43-7/64)					
	Depth	mm(inch)	378 (14-29/32)			529 (20-53/64)					
Weight	(NET)	kg(lb)	14 (31)			94 (207)					
	(GROSS)	kg(lb)	17 (38)			102 (224)					
	Panel (NET)	kg(lb)									
Layers limit (actually)				11(12)		2 (3)					
Operation condition	Cool (DBT)	18°C ~ 32°C			-10°C ~ 43°C						
	Heat (DBT)	16°C ~ 30°C			-15°C ~ 24°C						
MAX WORKING PRESSURE HP/LP MPa (bar)						4.15/2.55 (41.5/25.5)					
P I	Pipe diameter mm (inch)	(Liquid)Ø9.52(3/8) (Gas)Ø15.88(5/8)			(Liquid)Ø9.52(3/8) (Gas)Ø15.88(5/8)						
	Connecting method, Standard length m(ft)	flared type, 5.0(16.4)			flared type, 5.0(16.4)						
P I	Pipe length range m (ft)			5 ~ 50m (16.4 ~ 164.0)							
N I	Indoor unit & Outdoor unit height difference m (ft)			15m(OD located lower)/30m(OD located higher) (49.2/98.4)							
N I	Add gas amount g/m (oz/ft)			45g/m (0.484)							
N I	Pipe length for additional gas m (ft)			30m (98.4)							

\*1 In case it is necessary to indicate the air flow volume in (l/s), the value in (m<sup>3</sup>/min.) shall be multiplied by 16.7 and rounded down the decimal point.

\*2 If the EUROVENT Certified models can be operated under the "extra-low" temperature condition, -7°C dry bulb and -8°C wet-bulb temperatures with rated voltage 230V shall be used.

\*3 Network Impedance shall be applicable for EUROPE and CHINA models.

\*4 The annual consumption is calculated by multiplying the input power at 230V(400V) by an average of 500 hours per year in cooling mode.

\*5 EER and COP classification is at 230V(400V) only in accordance with EU directive 2002/31/EC.

\*6 η<sub>s,c</sub> and η<sub>s,h</sub> classification is at 230V(400V) only in accordance with EN-14825. For heating, η<sub>s,h</sub> indicates the value of only Average heating season.

\*7 H: High at setting 5 stage (Level 5), M: Middle at setting 5 stage (Level 3), L: Low at setting 5 stage (Level 1)

# Single -Type

## 1-1. Unit Specifications

PZ2

### 3. Wall Mounted Type S-100PK2E5B / U-100PZ2E8

INDOOR		MODEL	S-100PK2E5B			-			-		
PANEL		MODEL	-			-			-		
OUTDOOR		MODEL	-			U-100PZ2E8			-		
Branch pipe		MODEL	-			-			-		
Performance test condition					ISO5151 / EN14511 / EN12102/ EN14825						
Power supply		Ø, Hz	1Ø 50Hz			3Ø 50Hz			Min	Max	
		V	220V	230V	240V	380V	400V	415V			
Capacity		kW	9.0	9.0	9.0	-	-	-	3.0	9.7	
		BTU/h	30700	30700	30700	-	-	-	10200	33100	
Current		A	0.70	0.68	0.66	4.10	3.90	3.75	-	-	
Input power		W	75	75	75	2.515k	2.515k	2.515k	-	-	
		TOTAL W	-			2.590k	2.590k	2.590k	560	3.100k	
Annual consumption		TOTAL kWh **	-			-	1295	-	-	-	
EER/EER CLASS		TOTAL (W/W) <sup>1)</sup> ("A"~"G")	-	-	-	3.47	3.47/A	3.47	5.36	3.13	
C O L I N G	Erp *6	Pdesign	kW	-	-	-	9.0	-	-	-	
		SEER	(W/W)	-	-	-	6.5	-	-	-	
		Annual consumption	kWh	-	-	-	485	-	-	-	
		Class		-	-	-	-	A++	-	-	
Power factor		%	-	-	-	93	93	93	-	-	
Noise indoor		dB-A (H/M/L) *7	49/45/41			-			-	-	
		Power Level dB	65/61/57			-			-	-	
Noise outdoor		dB-A (H/L)	-			52/-			-	-	
		Power Level dB	-			70/-			-	-	
H E A T I N G	Capacity	kW	9.0	9.0	9.0	-	-	-	3.0	10.5	
		BTU/h	30700	30700	30700	-	-	-	10200	35800	
	Current	A	0.70	0.68	0.66	3.60	3.45	3.30	-	-	
		W	75	75	75	2.215k	2.215k	2.215k	-	-	
	Input power	TOTAL W	-			2.290k	2.290k	2.290k	560	2.950k	
		COP/COP CLASS	TOTAL (W/W) <sup>1)</sup> ("A"~"G")	-	-	-	3.93	3.93 /A	3.93	5.36	3.56
	Erp *6	Pdesign at -10°C	kW	-	-	-	-	9.0	-	-	
		Tbivalent	°C	-	-	-	-	-7	-	-	
		SCOP	(W/W)	-	-	-	-	3.9	-	-	
		Annual consumption	kWh	-	-	-	-	3231	-	-	
	Class	elbu(-10°C)	kW	-	-	-	-	1.40	-	-	
				-	-	-	-	A	-	-	
	Power factor		%	-	-	-	93	93	93	-	-
	Noise indoor		dB-A (H/M/L) *7	49/45/41			-			-	-
		Power Level dB	65/61/57			-			-	-	
Noise outdoor		dB-A (H/L)	-			52/-			-	-	
		Power Level dB	-			70/-			-	-	
EXTRA LOW TEMP   Total capacity(kW) / Input power(W) / COP											
Max Current(A) / Max Input power(W)			0.70/75	0.68/75	0.66/75	9.00/5.55k	9.00/5.80k	9.00/6.05k	-		
Starting current(A) (Cooling/Heating)			-	-	-	4.10/3.60	3.90/3.45	3.75/3.30	-		
Comp output(W)			-			2.50k	2.50k	2.50k	-		
Network Impedance(ΩMAX.)			-			-			-		
Fan motor output (Indoor/Outdoor) W			54			120			-		
Moisture removal volume		L/h(Pt/h)	4.3	(9.0)		-			-		
External static pressure		Pa	-			-			-		
Indoor Air flow *7	Cooling	m³/min (ft³/min)	22.0/18.5/15.0 (777)/(653)/(530)			-			-		
	Heating	m³/min (ft³/min)	22.0/18.5/15.0 (777)/(653)/(530)			-			-		
Outdoor Air flow	Cooling	m³/min (ft³/min)	-			76.0 (2683)			-		
	Heating	m³/min (ft³/min)	-			70.0 (2472)			-		
Refrigerant type / amount g(oz)			-			R32	2.60k	(91.7)	-		
Product dimension	Height	mm(inch)	302 (11-29/32)			996 (39- 7/32)			-		
	Width	mm(inch)	1120 (44-3/32)			980 (38-37/64)			-		
	Depth	mm(inch)	236 (9-9/32)			370 (14- 9/16)			-		
Product dimension (Panel)		H×W×D mm, inch	-			-			-		
Packing dimension	Height	mm(inch)	282 (11-1/8)			1134 (44-41/64)			-		
	Width	mm(inch)	1190 (46-7/8)			1095 (43-7/64)			-		
	Depth	mm(inch)	378 (14-29/32)			529 (20-53/64)			-		
Weight	(NET)	kg(lb)	14 (31)			90 (199)			-		
	(GROSS)	kg(lb)	17 (38)			98 (216)			-		
	Panel (NET)	kg(lb)	-			-			-		
Layers limit (actually)			11(12)			2 (3)			-		
Operation condition	Cool (DBT)		18°C ~ 32°C			-10°C ~ 43°C			-		
	Heat (DBT)		16°C ~ 30°C			-15°C ~ 24°C			-		
MAX WORKING PRESSURE HP/LP MPa (bar)			4.15/2.55 (41.5/25.5)			-			-		
P I P I N G	Pipe diameter mm (inch)		(Liquid)Ø9.52(3/8) (Gas)Ø15.88(5/8)			(Liquid)Ø9.52(3/8) (Gas)Ø15.88(5/8)			-		
	Connecting method, Standard length m(ft)		flared type, 5.0(16.4)			flared type, 5.0(16.4)			-		
Pipe length range m (ft)			5 ~ 50m (16.4 ~ 164.0)			-			-		
Indoor unit & Outdoor unit height difference m (ft)			15m(OD located lower)/30m(OD located higher) (49.2/98.4)			-			-		
Add gas amount g/m (oz/ft)			45g/m (0.484)			-			-		
Pipe length for additional gas m (ft)			30m (98.4)			-			-		

\*1 In case it is necessary to indicate the air flow volume in (l/s), the value in (m³/min.) shall be multiplied by 16.7 and rounded down the decimal point.  
 \*2 If the EUROVENT Certified models can be operated under the "extra-low" temperature condition, -7°C dry bulb and -8°C wet-bulb temperatures with rated voltage 230V shall be used.  
 \*3 Network Impedance shall be applicable for EUROPE and CHINA models.  
 \*4 The annual consumption is calculated by multiplying the input power at 230V(400V) by an average of 500 hours per year in cooling mode.  
 \*5 EER and COP classification is at 230V(400V) only in accordance with EU directive 2002/31/EC.  
 \*6 SEER and SCOP classification is at 230V(400V) only in accordance with EN-14825. For heating, SCOP indicates the value of only Average heating season, Other fiche data indicates in an attached sheet  
 \*7 H: High at setting 5 stage (Level 5), M: Middle at setting 5 stage (Level 3), L: Low at setting 5 stage (Level 1)

# Simultaneous (Twin) -Type

## 1-1. Unit Specifications

**PZ2**

### 4. Low Silhouette Ducted Type S-50PF1E5B×2 / U-100PZ2E5

INDOOR		MODEL	S-50PF1E5B ×2			-			-		
PANEL		MODEL	-			-			-		
OUTDOOR		MODEL	-			U-100PZ2E5			-		
Branch pipe		MODEL	-			CZ-P155BK1			-		
Performance test condition		ISO13253 / EN14511 / EN12102/ EN14825									
Power supply		Ø, Hz	1Ø 50Hz			1Ø 50Hz			Min	Max	
		V	220V	230V	240V	220V	230V	240V			
C O L I N G	Capacity	kW	10.0	10.0	10.0	-	-	-	3.0	11.5	
		BTU/h	34100	34100	34100	-	-	-	10200	39200	
	Current	A	0.77×2	0.74×2	0.71×2	12.1	11.6	11.1	-	-	
		W	100×2	100×2	100×2	2.535k	2.535k	2.535k	-	-	
	Input power	TOTAL W	-			2.735k	2.735k	2.735k	560	4.090k	
		Annual consumption	TOTAL kWh**	-			-	1367.5	-	-	-
	EER/EER CLASS	TOTAL (W/W) <sup>1)</sup> ("A"-~"G")	-	-	-	3.66	3.66/A	3.66	5.36	2.81	
	Erp <sup>5)</sup>	Pdesign	kW	-	-	-	-	10.0	-	-	-
		SEER	(W/W)	-	-	-	-	5.4	-	-	-
		Annual consumption	kWh	-	-	-	-	648	-	-	-
		Class		-	-	-	-	A	-	-	-
	Power factor	%	-	-	-	95	95	95	-	-	
	Noise indoor	dB-A (H/M/L)	34×2/30×2/26×2			-			-	-	
		Power Level dB	56×2/52×2/48×2			-			-	-	
Noise outdoor	dB-A (H/L)	-			52/-			-	-		
	Power Level dB	-			70/-			-	-		
H E A T I N G	Capacity	kW	10.0	10.0	10.0	-	-	-	3.0	14.0	
		BTU/h	34100	34100	34100	-	-	-	10200	47800	
	Current	A	0.77×2	0.74×2	0.71×2	10.10	9.70	9.30	-	-	
		W	100×2	100×2	100×2	2.120k	2.120k	2.120k	-	-	
	Input power	TOTAL W	-			2.320k	2.320k	2.320k	560	3.990k	
		COP/COP CLASS	TOTAL (W/W) <sup>1)</sup> ("A"-~"G")	-	-	-	4.31	4.31 /A	4.31	5.36	3.51
	Erp <sup>5)</sup>	Pdesign at -10°C	kW	-	-	-	-	10.0	-	-	-
		Tbivalent	°C	-	-	-	-	-10	-	-	-
		SCOP	(W/W)	-	-	-	-	3.8	-	-	-
		Annual consumption	kWh	-	-	-	-	3684	-	-	-
	Class	elbu(-10°C)	kW	-	-	-	-	0.00	-	-	-
				-	-	-	-	A	-	-	-
	Power factor	%	-	-	-	95	95	95	-	-	
	Noise indoor	dB-A (H/M/L)	34×2/30×2/26×2			-			-	-	
Power Level dB		56×2/52×2/48×2			-			-	-		
Noise outdoor	dB-A (H/L)	-			52/-			-	-		
	Power Level dB	-			70/-			-	-		
EXTRA LOW TEMP Total capacity(kW) / Input power(W) / COP		-									
Max Current(A) / Max Input power(W)		1.00×2/125×2	0.96×2/125×2	0.92×2/125×2	25.0/5.25k	25.0/5.50k	25.0/5.70k	-			
Starting current(A) (Cooling/Heating)		-	-	-	12.1/10.1	11.6/9.7	11.1/9.3	-			
Comp output(W)		-			2.50k	2.50k	2.50k	-			
Network Impedance(ΩMAX.)		-			-			-			
Fan motor output (Indoor/Outdoor) W		119			120			-			
Moisture removal volume		L/h(Pt/h)	5.6	(2.8×2)	(11.8)	-			-		
External static pressure		Pa	-			-			-		
Indoor Air flow	Cooling	m³/min (ft³/min)	16.0×2/15.0×2/12.0×2 (565x2)/(530x2)/(424x2)			-			-	-	
	Heating	m³/min (ft³/min)	16.0×2/15.0×2/12.0×2 (565x2)/(530x2)/(424x2)			-			-	-	
Outdoor Air flow	Cooling	m³/min (ft³/min)	-			76.0 (2683)			-	-	
	Heating	m³/min (ft³/min)	-			70.0 (2472)			-	-	
Refrigerant type / amount g(oz)		-			R32	2.60k	(91.7)	-			
Product dimension	Height	mm(inch)	290 (11-13/32)			996 (39-7/32)			-		
	Width	mm(inch)	800 (31-1/2)			980 (38-37/64)			-		
	Depth	mm(inch)	700 (27-9/16)			370 (14-9/16)			-		
Product dimension (Panel)		H×W×D mm, inch	-			-			-		
Packing dimension	Height	mm(inch)	355 (13-31/32)			1134 (44-41/64)			-		
	Width	mm(inch)	1014 (39-15/16)			1095 (43-7/64)			-		
	Depth	mm(inch)	850 (33-15/32)			529 (20-53/64)			-		
Weight	(NET)	kg(lb)	28 (62)			90 (199)			-		
	(GROSS)	kg(lb)	35 (78)			98 (216)			-		
	Panel (NET)	kg(lb)	-			-			-		
Layers limit (actually)		9(10)			2 (3)			-			
Operation condition	Cool (DBT)	18°C ~ 32°C			-10°C ~ 43°C			-			
	Heat (DBT)	16°C ~ 30°C			-15°C ~ 24°C			-			
MAX WORKING PRESSURE HP/LP MPa (bar)		4.15/2.55 (41.5/25.5)									
P I	Pipe diameter mm (inch)	(Liquid)Ø6.35(1/4) (Gas)Ø12.7(1/2)			(Liquid)Ø9.52(3/8) (Gas)Ø15.88(5/8)			-			
	Connecting method, Standard length m(ft)	flared type, 5.0(16.4)			flared type, 5.0(16.4)			-			
P I	Pipe length range m (ft)	5 ~ 50m (16.4 ~ 164.0)									
N G	Indoor unit & Outdoor unit height difference m (ft)	15m(OD located lower)/30m(OD located higher) (49.2/98.4)									
	Add gas amount g/m (oz/ft)	45g/m (0.484)									
N G	Pipe length for additional gas m (ft)	30m (98.4)									

\*1 In case it is necessary to indicate the air flow volume in (l/s), the value in (m³/min.) shall be multiplied by 16.7 and rounded down the decimal point.

\*2 If the EUROVENT Certified models can be operated under the "extra-low" temperature condition, -7°C dry bulb and -8°C wet-bulb temperatures with rated voltage 230V shall be used.

\*3 Network Impedance shall be applicable for EUROPE and CHINA models.

\*4 The annual consumption is calculated by multiplying the input power at 230V(400V) by an average of 500 hours per year in cooling mode.

\*5 EER and COP classification is at 230V(400V) only in accordance with EU directive 2002/31/EC.

\*6 SEER and SCOP classification is at 230V(400V) only in accordance with EN-14825. For heating, SCOP indicates the value of only Average heating season, Other fiche data indicates in an attached sheet



# Simultaneous (Twin) -Type

## 1-1. Unit Specifications

**PZ2**

### 4. Low Silhouette Ducted Type S-60PF1E5Bx2 / U-125PZ2E5

INDOOR		MODEL	S-60PF1E5B x2			-			-				
PANEL		MODEL	-			-			-				
OUTDOOR		MODEL	-			U-125PZ2E5			-				
Branch pipe		MODEL	-			CZ-P155BK1			-				
Performance test condition					ISO13253 / EN14511 / EN12102/ EN14825								
Power supply		Ø, Hz	1Ø 50Hz			1Ø 50Hz							
		V	220V	230V	240V	220V	230V	240V	Min	Max			
C O L I N G	Capacity	kW	12.5	12.5	12.5	-	-	-	3.2	13.5			
		BTU/h	42700	42700	42700	-	-	-	10900	46100			
	Current	A	0.91x2	0.89x2	0.87x2	16.1	15.5	14.8	-	-			
		W	120x2	120x2	120x2	3.335k	3.335k	3.335k	-	-			
	Input power	TOTAL W	-			3.575k	3.575k	3.575k	600	4.820k			
		Annual consumption	TOTAL kWh **	-			-	1787.5	-	-	-		
	EER/EER CLASS	TOTAL (W/W) <sup>1)</sup> ("A"-~"G")	-			3.50	3.50/A	3.50	5.33	2.80			
	Erp *6	Pdesign	kW	-	-	-	-	12.5	-	-	-		
		η <sub>s.c</sub>	%	-	-	-	-	233.8	-	-	-		
		Annual consumption	kWh	-	-	-	-	-	-	-	-		
Class			-	-	-	-	-	-	-	-			
Power factor	%	-	-	-	94	94	94	-	-				
Noise indoor	dB-A (H/M/L)	35x2/32x2/26x2			-			-	-				
	Power Level dB	57x2/54x2/48x2			-			-	-				
Noise outdoor	dB-A (H/L)	-			55/-			-	-				
	Power Level dB	-			73/-			-	-				
H E A T I N G	Capacity	kW	12.5	12.5	12.5	-	-	-	3.3	15.0			
		BTU/h	42700	42700	42700	-	-	-	11300	51200			
	Current	A	0.91x2	0.89x2	0.87x2	14.0	13.4	12.9	-	-			
		W	120x2	120x2	120x2	2.900k	2.900k	2.900k	-	-			
	Input power	TOTAL W	-			3.140k	3.140k	3.140k	600	4.350k			
		COP/COP CLASS	TOTAL (W/W) <sup>1)</sup> ("A"-~"G")	-			3.98	3.98/A	3.98	5.50	3.45		
	Erp *6	Pdesign at -10°C	kW	-	-	-	-	12.5	-	-	-		
		Tbivalent	°C	-	-	-	-	-7	-	-	-		
		η <sub>s.h</sub>	%	-	-	-	-	142.7	-	-	-		
		Annual consumption	kWh	-	-	-	-	-	-	-	-		
elbu(-10°C)		kW	-	-	-	-	2.30	-	-	-			
Class		-	-	-	-	-	-	-	-				
Power factor	%	-	-	-	94	94	94	-	-				
Noise indoor	dB-A (H/M/L)	35x2/32x2/26x2			-			-	-				
	Power Level dB	57x2/54x2/48x2			-			-	-				
Noise outdoor	dB-A (H/L)	-			55/-			-	-				
	Power Level dB	-			73/-			-	-				
EXTRA LOW TEMP   Total capacity(kW) / Input power(W) / COP													
Max Current(A) / Max Input power(W)		1.26x2/160x2		1.20x2/160x2		1.15x2/160x2		29.0/6.00k		29.0/6.30k		29.0/6.60k	
Starting current(A) (Cooling/Heating)		-		-		-		16.1/14.0		15.5/13.4		14.8/12.9	
Comp output(W)		-		-		-		2.80k		2.80k		2.80k	
Network Impedance(ΩMAX.)		-		-		-		-		-		-	
Fan motor output (Indoor/Outdoor) W		-		124		-		120		-		-	
Moisture removal volume		L/h(Pt/h)		6.8		(3.4x2)		(14.3)		-		-	
External static pressure		Pa		-		-		-		-		-	
Indoor	Cooling	m³/min (ft³/min)		21.0x2/19.0x2/15.0x2 (742x2)/(671x2)/(530x2)		-		-		-		-	
	Heating	m³/min (ft³/min)		21.0x2/19.0x2/15.0x2 (742x2)/(671x2)/(530x2)		-		-		-		-	
Outdoor	Cooling	m³/min (ft³/min)		-		-		86.0 (3037)		-		-	
	Heating	m³/min (ft³/min)		-		-		78.0 (2754)		-		-	
Refrigerant type / amount g(oz)		-		-		-		R32		2.98k		(105.1)	
Product dimension	Height	mm(inch)		290 (11-13/32)		-		996 (39-7/32)		-		-	
	Width	mm(inch)		1000 (39-3/8)		-		980 (38-37/64)		-		-	
	Depth	mm(inch)		700 (27-9/16)		-		370 (14-9/16)		-		-	
Product dimension (Panel)		HxWxD mm, inch		-		-		-		-		-	
Packing dimension	Height	mm(inch)		355 (13-31/32)		-		1134 (44-41/64)		-		-	
	Width	mm(inch)		1214 (47-13/16)		-		1095 (43-7/64)		-		-	
	Depth	mm(inch)		850 (33-15/32)		-		529 (20-53/64)		-		-	
Weight	(NET)	kg(lb)		33 (73)		-		94 (207)		-		-	
	(GROSS)	kg(lb)		41 (91)		-		102 (224)		-		-	
	Panel (NET)	kg(lb)		-		-		-		-		-	
Layers limit (actually)				9(10)		-		2 (3)		-		-	
Operation condition	Cool (DBT)			18°C ~ 32°C		-		-10°C ~ 43°C		-		-	
	Heat (DBT)			16°C ~ 30°C		-		-15°C ~ 24°C		-		-	
MAX WORKING PRESSURE HP/LP MPa (bar)					4.15/2.55 (41.5/25.5)								
P	Pipe diameter mm (inch)		(Liquid)Ø9.52(3/8) (Gas)Ø15.88(5/8)			(Liquid)Ø9.52(3/8) (Gas)Ø15.88(5/8)			-				
	Connecting method, Standard length m(ft)		flared type, 5.0(16.4)			flared type, 5.0(16.4)			-				
P	Pipe length range m (ft)		5 ~ 50m (16.4 ~ 164.0)					-					
I	Indoor unit & Outdoor unit height difference m (ft)		15m(OD located lower)/30m(OD located higher) (49.2/98.4)					-					
N	Add gas amount g/m (oz/ft)		45g/m (0.484)					-					
G	Pipe length for additional gas m (ft)		30m (98.4)					-					

\*1 In case it is necessary to indicate the air flow volume in (l/s), the value in (m³/min.) shall be multiplied by 16.7 and rounded down the decimal point.  
 \*2 If the EUROVENT Certified models can be operated under the "extra-low" temperature condition, -7°C dry bulb and -8°C wet-bulb temperatures with rated voltage 230V shall be used.  
 \*3 Network Impedance shall be applicable for EUROPE and CHINA models.  
 \*4 The annual consumption is calculated by multiplying the input power at 230V(400V) by an average of 500 hours per year in cooling mode.  
 \*5 EER and COP classification is at 230V(400V) only in accordance with EU directive 2002/31/EC.  
 \*6 η<sub>s.c</sub> and η<sub>s.h</sub> classification is at 230V(400V) only in accordance with EN-14825. For heating, η<sub>s.h</sub> indicates the value of only Average heating season.

# Simultaneous (Twin) -Type

## 1-1. Unit Specifications

**PZ2**

### 4. Low Silhouette Ducted Type S-71PF1E5Bx2 / U-140PZ2E5

INDOOR		MODEL	S-71PF1E5B x2			-			-		
PANEL		MODEL	-			-			-		
OUTDOOR		MODEL	-			U-140PZ2E5			-		
Branch pipe		MODEL	-			CZ-P155BK1			-		
Performance test condition		ISO13253 / EN14511 / EN12102/ EN14825									
Power supply		Ø, Hz	1Ø 50Hz			1Ø 50Hz			Min	Max	
		V	220V	230V	240V	220V	230V	240V			
C O O L I N G	Capacity	kW	14.0	14.0	14.0	-	-	-	3.3	15.0	
		BTU/h	47800	47800	47800	-	-	-	11300	51200	
	Current	A	0.91×2	0.89×2	0.87×2	20.2	19.3	18.6	-	-	
		W	120×2	120×2	120×2	4.175k	4.175k	4.175k	-	-	
	Input power	TOTAL W	-	-	-	4.415k	4.415k	4.415k	620	5.560k	
		Annual consumption	TOTAL kWh **	-	-	-	-	2207.5	-	-	-
	EER/EER CLASS	TOTAL (W/W) <sup>1)</sup> ("A"-~"G")	-	-	-	3.17	3.17/B	3.17	5.32	2.70	
	Erp <sup>5)</sup>	P <sub>design</sub>	kW	-	-	-	-	14.0	-	-	-
		η <sub>s.c</sub>	%	-	-	-	-	222.3	-	-	-
		Annual consumption	kWh	-	-	-	-	-	-	-	-
Class			-	-	-	-	-	-	-	-	
Power factor	%	-	-	-	94	94	94	-	-		
Noise indoor	dB-A (H/M/L)	35×2/32×2/26×2			-			-	-		
	Power Level dB	57×2/54×2/48×2			-			-	-		
Noise outdoor	dB-A (H/L)	-			56/-			-	-		
	Power Level dB	-			74/-			-	-		
H E A T I N G	Capacity	kW	14.0	14.0	14.0	-	-	-	3.4	16.0	
		BTU/h	47800	47800	47800	-	-	-	11600	54600	
	Current	A	0.91×2	0.89×2	0.87×2	16.8	16.0	15.3	-	-	
		W	120×2	120×2	120×2	3.465k	3.465k	3.465k	-	-	
	Input power	TOTAL W	-	-	-	3.705k	3.705k	3.705k	620	5.120k	
		COP/COP CLASS	TOTAL (W/W) <sup>1)</sup> ("A"-~"G")	-	-	-	3.78	3.78/A	3.78	5.48	3.13
	Erp <sup>5)</sup>	P <sub>design</sub> at -10°C	kW	-	-	-	-	13.6	-	-	-
		T <sub>bivalent</sub>	°C	-	-	-	-	-7	-	-	-
		η <sub>s.h</sub>	%	-	-	-	-	139.4	-	-	-
		Annual consumption	kWh	-	-	-	-	-	-	-	-
elbu(-10°C)		kW	-	-	-	-	2.70	-	-	-	
Class			-	-	-	-	-	-	-	-	
Power factor	%	-	-	-	94	94	94	-	-		
Noise indoor	dB-A (H/M/L)	35×2/32×2/26×2			-			-	-		
	Power Level dB	57×2/54×2/48×2			-			-	-		
Noise outdoor	dB-A (H/L)	-			56/-			-	-		
	Power Level dB	-			74/-			-	-		
EXTRA LOW TEMP Total capacity(kW) / Input power(W) / COP		-									
Max Current(A) / Max Input power(W)		1.26×2/160×2	1.20×2/160×2	1.15×2/160×2	30.0/6.25k	30.0/6.50k	30.0/6.80k	-			
Starting current(A) (Cooling/Heating)		-	-	-	20.2/16.8	19.3/16.0	18.6/15.3	-			
Comp output(W)		-			3.00k	3.00k	3.00k	-			
Network Impedance(ΩMAX.)		-			-			-			
Fan motor output (Indoor/Outdoor) W		124			120			-			
Moisture removal volume		L/h(Pt/h)	8.4	(4.2×2)	(17.6)	-			-		
External static pressure		Pa	-			-			-		
Indoor Air flow	Cooling	m <sup>3</sup> /min (ft <sup>3</sup> /min)	21.0×2/19.0×2/15.0×2 (742×2)/(671×2)/(530×2)			-			-	-	
	Heating	m <sup>3</sup> /min (ft <sup>3</sup> /min)	21.0×2/19.0×2/15.0×2 (742×2)/(671×2)/(530×2)			-			-	-	
Outdoor Air flow	Cooling	m <sup>3</sup> /min (ft <sup>3</sup> /min)	-			89.0 (3143)			-	-	
	Heating	m <sup>3</sup> /min (ft <sup>3</sup> /min)	-			83.0 (2931)			-	-	
Refrigerant type / amount g(oz)		-			R32	2.98k	(105.1)	-			
Product dimension	Height	mm(inch)	290 (11-13/32)			996 (39-7/32)			-		
	Width	mm(inch)	1000 (39-3/8)			980 (38-37/64)			-		
	Depth	mm(inch)	700 (27-9/16)			370 (14-9/16)			-		
Product dimension (Panel)		H×W×D mm, inch	-			-			-		
Packing dimension	Height	mm(inch)	355 (13-31/32)			1134 (44-41/64)			-		
	Width	mm(inch)	1214 (47-13/16)			1095 (43-7/64)			-		
	Depth	mm(inch)	850 (33-15/32)			529 (20-53/64)			-		
Weight	(NET)	kg(lb)	33 (73)			94 (207)			-		
	(GROSS)	kg(lb)	41 (91)			102 (224)			-		
	Panel (NET)	kg(lb)	-			-			-		
Layers limit (actually)		9(10)			2 (3)			-			
Operation condition	Cool (DBT)	18°C ~ 32°C			-10°C ~ 43°C			-			
	Heat (DBT)	16°C ~ 30°C			-15°C ~ 24°C			-			
MAX WORKING PRESSURE HP/LP MPa (bar)		4.15/2.55 (41.5/25.5)									
P I	Pipe diameter mm (inch)	(Liquid)Ø9.52(3/8) (Gas)Ø15.88(5/8)			(Liquid)Ø9.52(3/8) (Gas)Ø15.88(5/8)			-			
	Connecting method, Standard length m(ft)	flared type, 5.0(16.4)			flared type, 5.0(16.4)			-			
P I	Pipe length range m (ft)	5 ~ 50m (16.4 ~ 164.0)									
N I	Indoor unit & Outdoor unit height difference m (ft)	15m(OD located lower)/30m(OD located higher) (49.2/98.4)									
N G	Add gas amount g/m (oz/ft)	45g/m (0.484)									
	Pipe length for additional gas m (ft)	30m (98.4)									

\*1 In case it is necessary to indicate the air flow volume in (l/s), the value in (m<sup>3</sup>/min.) shall be multiplied by 16.7 and rounded down the decimal point.

\*2 If the EUROVENT Certified models can be operated under the "extra-low" temperature condition, -7°C dry bulb and -8°C wet-bulb temperatures with rated voltage 230V shall be used.

\*3 Network Impedance shall be applicable for EUROPE and CHINA models.

\*4 The annual consumption is calculated by multiplying the input power at 230V(400V) by an average of 500 hours per year in cooling mode.

\*5 EER and COP classification is at 230V(400V) only in accordance with EU directive 2002/31/EC.

\*6 η<sub>s.c</sub> and η<sub>s.h</sub> classification is at 230V(400V) only in accordance with EN-14825. For heating, η<sub>s.h</sub> indicates the value of only Average heating season.

# Single -Type

## 1-1. Unit Specifications

**PZ2**

### 4. Low Silhouette Ducted Type S-100PF1E5B / U-100PZ2E5

INDOOR		MODEL	S-100PF1E5B			-			-		
PANEL		MODEL	-			-			-		
OUTDOOR		MODEL	-			U-100PZ2E5			-		
Branch pipe		MODEL	-			-			-		
Performance test condition					ISO13253 / EN14511 / EN12102/ EN14825						
Power supply		Ø, Hz	1Ø 50Hz			1Ø 50Hz			Min	Max	
		V	220V	230V	240V	220V	230V	240V			
C O L I N G	Capacity	kW	10.0	10.0	10.0	-	-	-	3.0	11.5	
		BTU/h	34100	34100	34100	-	-	-	10200	39200	
	Current	A	1.35	1.30	1.27	12.1	11.6	11.1	-	-	
		W	195	195	195	2.535k	2.535k	2.535k	-	-	
	Input power	TOTAL W	-			2.730k	2.730k	2.730k	560	4.090k	
		Annual consumption	TOTAL kWh **	-			-	1365	-	-	-
	EER/EER CLASS	TOTAL (W/W) <sup>1)</sup> ("A"-~"G")	-	-	-	3.66	3.66/A	3.66	5.36	2.81	
	Erp <sup>5)</sup>	Pdesign	kW	-	-	-	-	10.0	-	-	-
		SEER	(W/W)	-	-	-	-	5.6	-	-	-
		Annual consumption	kWh	-	-	-	-	625	-	-	-
		Class		-	-	-	-	A+	-	-	-
	Power factor	%	-	-	-	95	95	95	-	-	
	Noise indoor	dB-A (H/M/L)	38/34/31			-			-	-	
		Power Level dB	60/56/53			-			-	-	
Noise outdoor	dB-A (H/L)	-			52/-			-	-		
	Power Level dB	-			70/-			-	-		
H E A T I N G	Capacity	kW	10.0	10.0	10.0	-	-	-	3.0	14.0	
		BTU/h	34100	34100	34100	-	-	-	10200	47800	
	Current	A	1.37	1.34	1.29	10.1	9.70	9.30	-	-	
		W	200	200	200	2.120k	2.120k	2.120k	-	-	
	Input power	TOTAL W	-			2.320k	2.320k	2.320k	560	3.990k	
		COP/COP CLASS	TOTAL (W/W) <sup>1)</sup> ("A"-~"G")	-	-	-	4.31	4.31 /A	4.31	5.36	3.51
	Erp <sup>5)</sup>	Pdesign at -10°C	kW	-	-	-	-	10.0	-	-	-
		Tbivalent	°C	-	-	-	-	-10	-	-	-
		SCOP	(W/W)	-	-	-	-	3.8	-	-	-
		Annual consumption	kWh	-	-	-	-	3684	-	-	-
	Power factor	elbu(-10°C)	kW	-	-	-	-	0.00	-	-	-
		Class		-	-	-	-	A	-	-	-
	Power factor	%	-	-	-	95	95	95	-	-	
	Noise indoor	dB-A (H/M/L)	38/34/31			-			-	-	
Power Level dB		60/56/53			-			-	-		
Noise outdoor	dB-A (H/L)	-			52/-			-	-		
	Power Level dB	-			70/-			-	-		
EXTRA LOW TEMP   Total capacity(kW) / Input power(W) / COP											
Max Current(A) / Max Input power(W)		1.80/265		1.75/265	1.70/265	25.0/5.25k	25.0/5.50k	25.0/5.70k	-		
Starting current(A) (Cooling/Heating)		-		-	-	12.1/10.1	11.6/9.7	11.1/9.3	-		
Comp output(W)		-		-	-	2.50k	2.50k	2.50k	-		
Network Impedance(ΩMAX.)		-		-	-	-	-	-	-		
Fan motor output (Indoor/Outdoor) W		-		235	-	-	120	-	-		
Moisture removal volume		L/h(Pt/h)	6.0	(12.6)		-		-	-		
External static pressure		Pa	100 (MIN10 - MAX150)			-		-	-		
Indoor Air flow	Cooling	m³/min (ft³/min)	32.0/26.0/21.0 (1130)/(918)/(742)			-		-	-		
	Heating	m³/min (ft³/min)	32.0/26.0/21.0 (1130)/(918)/(742)			-		-	-		
Outdoor Air flow	Cooling	m³/min (ft³/min)	-			76.0 (2683)		-	-		
	Heating	m³/min (ft³/min)	-			70.0 (2472)		-	-		
Refrigerant type / amount g(oz)		-		-	-	R32	2.60k	(91.7)	-		
Product dimension	Height	mm(inch)	290 (11-13/32)			996 (39-7/32)		-			
	Width	mm(inch)	1400 (55-1/8)			980 (38-37/64)		-			
	Depth	mm(inch)	700 (27-9/16)			370 (14-9/16)		-			
Product dimension (Panel)		H×W×D mm, inch	-			-		-			
Packing dimension	Height	mm(inch)	355 (13-31/32)			1134 (44-41/64)		-			
	Width	mm(inch)	1614 (63-9/16)			1095 (43-7/64)		-			
	Depth	mm(inch)	850 (33-15/32)			529 (20-53/64)		-			
Weight	(NET)	kg(lb)	45 (99)			90 (199)		-			
	(GROSS)	kg(lb)	54 (119)			98 (216)		-			
	Panel (NET)	kg(lb)	-			-		-			
Layers limit (actually)		9(10)			2 (3)		-				
Operation condition	Cool (DBT)	18°C ~ 32°C			-10°C ~ 43°C		-				
	Heat (DBT)	16°C ~ 30°C			-15°C ~ 24°C		-				
MAX WORKING PRESSURE HP/LP MPa (bar)		4.15/2.55 (41.5/25.5)			-		-				
P I	Pipe diameter mm (inch)	(Liquid)Ø9.52(3/8) (Gas)Ø15.88(5/8)			(Liquid)Ø9.52(3/8) (Gas)Ø15.88(5/8)		-				
	Connecting method, Standard length m(ft)	flared type, 5.0(16.4)			flared type, 5.0(16.4)		-				
P I	Pipe length range m (ft)	5 ~ 50m (16.4 ~ 164.0)			-		-				
N G	Indoor unit & Outdoor unit height difference m (ft)	15m(OD located lower)/30m(OD located higher) (49.2/98.4)			-		-				
	Add gas amount g/m (oz/ft)	45g/m (0.484)			-		-				
N G	Pipe length for additional gas m (ft)	30m (98.4)			-		-				

\*1 In case it is necessary to indicate the air flow volume in (l/s), the value in (m³/min.) shall be multiplied by 16.7 and rounded down the decimal point.  
 \*2 If the EUROVENT Certified models can be operated under the "extra-low" temperature condition, -7°C dry bulb and -8°C wet-bulb temperatures with rated voltage 230V shall be used.  
 \*3 Network Impedance shall be applicable for EUROPE and CHINA models.  
 \*4 The annual consumption is calculated by multiplying the input power at 230V(400V) by an average of 500 hours per year in cooling mode.  
 \*5 EER and COP classification is at 230V(400V) only in accordance with EU directive 2002/31/EC.  
 \*6 SEER and SCOP classification is at 230V(400V) only in accordance with EN-14825. For heating, SCOP indicates the value of only Average heating season, Other fiche data indicates in an attached sheet

# Single -Type

## 1-1. Unit Specifications

**PZ2**

### 4. Low Silhouette Ducted Type S-125PF1E5B / U-125PZ2E5

INDOOR		MODEL	S-125PF1E5B			-			-		
PANEL		MODEL	-			-			-		
OUTDOOR		MODEL	-			U-125PZ2E5			-		
Branch pipe		MODEL	-			-			-		
Performance test condition		ISO13253 / EN14511 / EN12102/ EN14825									
Power supply		Ø, Hz	1Ø 50Hz			1Ø 50Hz			Min	Max	
		V	220V	230V	240V	220V	230V	240V			
C O L I N G	Capacity	kW	12.5	12.5	12.5	-	-	-	3.2	13.5	
		BTU/h	42700	42700	42700	-	-	-	10900	46100	
	Current	A	1.48	1.44	1.39	16.1	15.5	14.8	-	-	
		W	215	215	215	3.335k	3.335k	3.335k	-	-	
	Input power	TOTAL W	-			3.550k	3.550k	3.550k	600	4.820k	
		Annual consumption	TOTAL kWh **	-			-	1775	-	-	-
	EER/EER CLASS	TOTAL (W/W) <sup>1)</sup> ("A"~"G")	-	-	-	3.52	3.52 /A	3.52	5.33	2.80	
	Erp <sup>6)</sup>	P <sub>design</sub>	kW	-	-	-	-	12.5	-	-	-
		η <sub>s,c</sub>	%	-	-	-	-	219.2	-	-	-
		Annual consumption	kWh	-	-	-	-	-	-	-	-
		Class		-	-	-	-	-	-	-	-
	Power factor	%	-	-	-	94	94	94	-	-	
	Noise indoor	dB-A (H/M/L)	39/35/32			-			-	-	
		Power Level dB	61/57/54			-			-	-	
Noise outdoor	dB-A (H/L)	-			55/-			-	-		
	Power Level dB	-			73/-			-	-		
H E A T I N G	Capacity	kW	12.5	12.5	12.5	-	-	-	3.3	15.0	
		BTU/h	42700	42700	42700	-	-	-	11300	51200	
	Current	A	1.46	1.42	1.38	14.0	13.4	12.9	-	-	
		W	210	210	210	2.900k	2.900k	2.900k	-	-	
	Input power	TOTAL W	-			3.110k	3.110k	3.110k	600	4.350k	
		COP/COP CLASS	TOTAL (W/W) <sup>1)</sup> ("A"~"G")	-	-	-	4.02	4.02 /A	4.02	5.50	3.45
	Erp <sup>6)</sup>	P <sub>design</sub> at -10°C	kW	-	-	-	-	12.5	-	-	-
		T <sub>bivalent</sub>	°C	-	-	-	-	-7	-	-	-
		η <sub>s,h</sub>	%	-	-	-	-	141.5	-	-	-
		Annual consumption	kWh	-	-	-	-	-	-	-	-
		elbu(-10°C)	kW	-	-	-	-	2.30	-	-	-
		Class		-	-	-	-	-	-	-	-
	Power factor	%	-	-	-	94	94	94	-	-	
	Noise indoor	dB-A (H/M/L)	39/35/32			-			-	-	
Power Level dB		61/57/54			-			-	-		
Noise outdoor	dB-A (H/L)	-			55/-			-	-		
	Power Level dB	-			73/-			-	-		
EXTRA LOW TEMP Total capacity(kW) / Input power(W) / COP		-									
Max Current(A) / Max Input power(W)		1.80/265	1.75/265	1.70/265	29.0/6.00k	29.0/6.30k	29.0/6.60k	-			
Starting current(A) (Cooling/Heating)		-	-	-	16.1/14.0	15.5/13.4	14.8/12.9	-			
Comp output(W)		-			2.80k	2.80k	2.80k	-			
Network Impedance(ΩMAX.)		-			-			-			
Fan motor output (Indoor/Outdoor) W		235			120			-			
Moisture removal volume		L/h(Pt/h)	7.9	(16.6)		-			-		
External static pressure		Pa	100 (MIN10 - MAX150)			-			-		
Indoor Air flow	Cooling	m <sup>3</sup> /min (ft <sup>3</sup> /min)	34.0/29.0/23.0 (1201)/(1024)/(812)			-			-		
	Heating	m <sup>3</sup> /min (ft <sup>3</sup> /min)	34.0/29.0/23.0 (1201)/(1024)/(812)			-			-		
Outdoor Air flow	Cooling	m <sup>3</sup> /min (ft <sup>3</sup> /min)	-			86.0 (3037)			-		
	Heating	m <sup>3</sup> /min (ft <sup>3</sup> /min)	-			78.0 (2754)			-		
Refrigerant type / amount (g/oz)		-			R32	2.98k	(105.1)	-			
Product dimension	Height	mm(inch)	290 (11-13/32)			996 (39-7/32)			-		
	Width	mm(inch)	1400 (55-1/8)			980 (38-37/64)			-		
	Depth	mm(inch)	700 (27-9/16)			370 (14-9/16)			-		
Product dimension (Panel)		H×W×D mm, inch	-			-			-		
Packing dimension	Height	mm(inch)	355 (13-31/32)			1134 (44-41/64)			-		
	Width	mm(inch)	1614 (63-9/16)			1095 (43-7/64)			-		
	Depth	mm(inch)	850 (33-15/32)			529 (20-53/64)			-		
Weight	(NET)	kg(lb)	45 (99)			94 (207)			-		
	(GROSS)	kg(lb)	54 (119)			102 (224)			-		
	Panel (NET)	kg(lb)	-			-			-		
Layers limit (actually)		9(10)			2 (3)			-			
Operation condition	Cool (DBT)	18°C ~ 32°C			-10°C ~ 43°C			-			
	Heat (DBT)	16°C ~ 30°C			-15°C ~ 24°C			-			
MAX WORKING PRESSURE HP/LP MPa (bar)		4.15/2.55 (41.5/25.5)									
P I	Pipe diameter mm (inch)	(Liquid)Ø9.52(3/8) (Gas)Ø15.88(5/8)			(Liquid)Ø9.52(3/8) (Gas)Ø15.88(5/8)			-			
	Connecting method, Standard length m(ft)	flared type, 5.0(16.4)			flared type, 5.0(16.4)			-			
P I	Pipe length range m (ft)	5 ~ 50m (16.4 ~ 164.0)									
N I	Indoor unit & Outdoor unit height difference m (ft)	15m(OD located lower)/30m(OD located higher) (49.2/98.4)									
N G	Add gas amount g/m (oz/ft)	45g/m (0.484)									
	Pipe length for additional gas m (ft)	30m (98.4)									

\*1 In case it is necessary to indicate the air flow volume in (l/s), the value in (m<sup>3</sup>/min.) shall be multiplied by 16.7 and rounded down the decimal point.

\*2 If the EUROVENT Certified models can be operated under the "extra-low" temperature condition, -7°C dry bulb and -8°C wet-bulb temperatures with rated voltage 230V shall be used.

\*3 Network Impedance shall be applicable for EUROPE and CHINA models.

\*4 The annual consumption is calculated by multiplying the input power at 230V(400V) by an average of 500 hours per year in cooling mode.

\*5 EER and COP classification is at 230V(400V) only in accordance with EU directive 2002/31/EC.

\*6 η<sub>s,c</sub> and η<sub>s,h</sub> classification is at 230V(400V) only in accordance with EN-14825. For heating, η<sub>s,h</sub> indicates the value of only Average heating season.

# Single -Type

## 1-1. Unit Specifications

**PZ2**

### 4. Low Silhouette Ducted Type S-140PF1E5B / U-140PZ2E5

INDOOR		MODEL	S-140PF1E5B						-	-	
PANEL		MODEL							-	-	
OUTDOOR		MODEL				U-140PZ2E5			-	-	
Branch pipe		MODEL							-	-	
Performance test condition					ISO13253 / EN14511 / EN12102/ EN14825						
Power supply		Ø, Hz	1Ø 50Hz			1Ø 50Hz			Min	Max	
		V	220V	230V	240V	220V	230V	240V			
C O L I N G	Capacity	kW	14.0	14.0	14.0	-	-	-	3.3	15.0	
		BTU/h	47800	47800	47800	-	-	-	11300	51200	
	Current	A	1.55	1.50	1.47	20.2	19.3	18.6	-	-	
		W	225	225	225	4.175k	4.175k	4.175k	-	-	
	Input power	TOTAL W				4.400k	4.400k	4.400k	620	5.560k	
		Annual consumption	TOTAL kWh **				-	2200	-	-	-
	EER/EER CLASS	TOTAL (W/W) <sup>5)</sup> ("A"-~"G")				3.18	3.18/B	3.18	5.32	2.70	
	E r p * 6	Pdesign	kW	-	-	-	-	14.0	-	-	-
		η <sub>s.c</sub>	%	-	-	-	-	212.3	-	-	-
		Annual consumption	kWh	-	-	-	-	-	-	-	-
Class			-	-	-	-	-	-	-	-	
Power factor	%	-	-	-	94	94	94	-	-		
Noise indoor	dB-A (H/M/L)	40/36/33						-	-		
	Power Level dB	62/58/55						-	-		
Noise outdoor	dB-A (H/L)				56/-			-	-		
	Power Level dB				74/-			-	-		
H E A T I N G	Capacity	kW	14.0	14.0	14.0	-	-	-	3.4	16.0	
		BTU/h	47800	47800	47800	-	-	-	11600	54600	
	Current	A	1.55	1.50	1.46	16.8	16.0	15.3	-	-	
		W	225	225	225	3.465k	3.465k	3.465k	-	-	
	Input power	TOTAL W				3.690k	3.690k	3.690k	620	5.120k	
		COP/COP CLASS	TOTAL (W/W) <sup>5)</sup> ("A"-~"G")	-	-	-	3.79	3.79/A	3.79	5.48	3.13
	E r p * 6	Pdesign at -10°C	kW	-	-	-	-	13.6	-	-	-
		Tbivalent	°C	-	-	-	-	-7	-	-	-
		η <sub>s.h</sub>	%	-	-	-	-	138.4	-	-	-
		Annual consumption	kWh	-	-	-	-	-	-	-	-
Class	elbu(-10°C)	kW	-	-	-	-	2.70	-	-	-	
			-	-	-	-	-	-	-	-	
Power factor	%	-	-	-	94	94	94	-	-		
Noise indoor	dB-A (H/M/L)	40/36/33						-	-		
	Power Level dB	62/58/55						-	-		
Noise outdoor	dB-A (H/L)				56/-			-	-		
	Power Level dB				74/-			-	-		
EXTRA LOW TEMP Total capacity(kW) / Input power(W) / COP											
Max Current(A) / Max Input power(W)		1.91/285		1.86/285	1.81/285	30.0/6.25k	30.0/6.50k	30.0/6.80k			
Starting current(A) (Cooling/Heating)						20.2/16.8	19.3/16.0	18.6/15.3			
Comp output(W)						3.00k	3.00k	3.00k			
Network Impedance(ΩMAX.)											
Fan motor output (Indoor/Outdoor) W				235				120			
Moisture removal volume		L/h(Pt/h)	9.0		(18.9)						
External static pressure		Pa	100 (MIN10 - MAX150)								
Indoor Air flow	Cooling	m³/min (ft³/min)	36.0/32.0/25.0 (1271)/(1130)/(883)								
	Heating	m³/min (ft³/min)	36.0/32.0/25.0 (1271)/(1130)/(883)								
Outdoor Air flow	Cooling	m³/min (ft³/min)				89.0 (3143)					
	Heating	m³/min (ft³/min)				83.0 (2931)					
Refrigerant type / amount (g/oz)						R32	2.98k	(105.1)			
Product dimension	Height	mm(inch)	290 (11-13/32)			996 (39-7/32)					
	Width	mm(inch)	1400 (55-1/8)			980 (38-37/64)					
	Depth	mm(inch)	700 (27-9/16)			370 (14-9/16)					
Product dimension (Panel)		H×W×D mm, inch									
Packing dimension	Height	mm(inch)	355 (13-31/32)			1134 (44-41/64)					
	Width	mm(inch)	1614 (63-9/16)			1095 (43-7/64)					
	Depth	mm(inch)	850 (33-15/32)			529 (20-53/64)					
Weight	(NET)	kg(lb)	45 (99)			94 (207)					
	(GROSS)	kg(lb)	54 (119)			102 (224)					
	Panel (NET)	kg(lb)									
Layers limit (actually)				9(10)			2 (3)				
Operation condition	Cool (DBT)	18°C ~ 32°C						-10°C ~ 43°C			
	Heat (DBT)	16°C ~ 30°C						-15°C ~ 24°C			
MAX WORKING PRESSURE HP/LP MPa (bar)					4.15/2.55 (41.5/25.5)						
P I P I N G	Pipe diameter mm (inch)		(Liquid)Ø9.52(3/8) (Gas)Ø15.88(5/8)			(Liquid)Ø9.52(3/8) (Gas)Ø15.88(5/8)					
	Connecting method, Standard length m(ft)		flared type, 5.0(16.4)			flared type, 5.0(16.4)					
Pipe length range		m (ft)		5 ~ 50m (16.4 ~ 164.0)							
Indoor unit & Outdoor unit height difference		m (ft)		15m(OD located lower)/30m(OD located higher) (49.2/98.4)							
Add gas amount		g/m (oz/ft)		45g/m (0.484)							
Pipe length for additional gas		m (ft)		30m (98.4)							

\*1 In case it is necessary to indicate the air flow volume in (l/s), the value in (m³/min.) shall be multiplied by 16.7 and rounded down the decimal point.  
 \*2 If the EUROVENT Certified models can be operated under the "extra-low" temperature condition, -7°C dry bulb and -8°C wet-bulb temperatures with rated voltage 230V shall be used.  
 \*3 Network Impedance shall be applicable for EUROPE and CHINA models.  
 \*4 The annual consumption is calculated by multiplying the input power at 230V(400V) by an average of 500 hours per year in cooling mode.  
 \*5 EER and COP classification is at 230V(400V) only in accordance with EU directive 2002/31/EC.  
 \*6 η<sub>s.c</sub> and η<sub>s.h</sub> classification is at 230V(400V) only in accordance with EN-14825. For heating, η<sub>s.h</sub> indicates the value of only Average heating season.

# Simultaneous (Twin) -Type

## 1-1. Unit Specifications

**PZ2**

### 4. Low Silhouette Ducted Type S-50PF1E5Bx2 / U-100PZ2E8

INDOOR		MODEL	S-50PF1E5B x2			-			-		
PANEL		MODEL	-			-			-		
OUTDOOR		MODEL	-			U-100PZ2E8			-		
Branch pipe		MODEL	-			CZ-P155BK1			-		
Performance test condition			ISO13253 / EN14511 / EN12102/ EN14825								
Power supply		Ø, Hz	1Ø 50Hz			3Ø 50Hz			Min	Max	
		V	220V	230V	240V	380V	400V	415V			
C O L I N G	Capacity	kW	10.0	10.0	10.0	-	-	-	3.0	11.5	
		BTU/h	34100	34100	34100	-	-	-	10200	39200	
	Current	A	0.77×2	0.74×2	0.71×2	4.15	3.95	3.80	-	-	
		W	100×2	100×2	100×2	2.535k	2.535k	2.535k	-	-	
	Input power	TOTAL W	-			2.735k	2.735k	2.735k	560	4.090k	
		Annual consumption	TOTAL kWh **	-			-	1367.5	-	-	-
	EER/EER CLASS	TOTAL (W/W) <sup>1)</sup> ("A"-G)	-	-	-	3.66	3.66/A	3.66	5.36	2.81	
	Erp <sup>5)</sup>	Pdesign	kW	-	-	-	-	10.0	-	-	-
		SEER	(W/W)	-	-	-	-	5.4	-	-	-
		Annual consumption	kWh	-	-	-	-	648	-	-	-
		Class		-	-	-	-	A	-	-	-
	Power factor	%	-	-	-	93	93	93	-	-	
	Noise indoor	dB-A (H/M/L)	34×2/30×2/26×2			-			-	-	
		Power Level dB	56×2/52×2/48×2			-			-	-	
Noise outdoor	dB-A (H/L)	-			52/-			-	-		
	Power Level dB	-			70/-			-	-		
H E A T I N G	Capacity	kW	10.0	10.0	10.0	-	-	-	3.0	14.0	
		BTU/h	34100	34100	34100	-	-	-	10200	47800	
	Current	A	0.77×2	0.74×2	0.71×2	3.45	3.30	3.20	-	-	
		W	100×2	100×2	100×2	2.120k	2.120k	2.120k	-	-	
	Input power	TOTAL W	-			2.320k	2.320k	2.320k	560	3.990k	
		COP/COP CLASS	TOTAL (W/W) <sup>1)</sup> ("A"-G)	-	-	-	4.31	4.31/A	4.31	5.36	3.51
	Erp <sup>5)</sup>	Pdesign at -10°C	kW	-	-	-	-	10.0	-	-	-
		Tbivalent	°C	-	-	-	-	-10	-	-	-
		SCOP	(W/W)	-	-	-	-	3.8	-	-	-
		Annual consumption	kWh	-	-	-	-	3684	-	-	-
	Class	elbu(-10°C)	kW	-	-	-	-	0.00	-	-	-
				-	-	-	-	A	-	-	-
	Power factor	%	-	-	-	93	93	92	-	-	
	Noise indoor	dB-A (H/M/L)	34×2/30×2/26×2			-			-	-	
Power Level dB		56×2/52×2/48×2			-			-	-		
Noise outdoor	dB-A (H/L)	-			52/-			-	-		
	Power Level dB	-			70/-			-	-		
EXTRA LOW TEMP   Total capacity(kW) / Input power(W) / COP											
Max Current(A) / Max Input power(W)		1.00×2/125×2	0.96×2/125×2	0.92×2/125×2	9.00/5.55k	9.00/5.80k	9.00/6.05k	-			
Starting current(A) (Cooling/Heating)		-	-	-	4.15/3.45	3.95/3.30	3.80/3.20	-			
Comp output(W)		-			2.50k	2.50k	2.50k	-			
Network Impedance(ΩMAX.)		-			-			-			
Fan motor output (Indoor/Outdoor) W		119			120			-			
Moisture removal volume		L/h(Pt/h)	5.6	(2.8×2)	(11.8)	-			-		
External static pressure		Pa	70 (MIN10 - MAX150)			-			-		
Indoor Air flow	Cooling	m³/min (ft³/min)	16.0×2/15.0×2/12.0×2 (565x2)/(530x2)/(424x2)			-			-		
	Heating	m³/min (ft³/min)	16.0×2/15.0×2/12.0×2 (565x2)/(530x2)/(424x2)			-			-		
Outdoor Air flow	Cooling	m³/min (ft³/min)	-			76.0 (2683)			-		
	Heating	m³/min (ft³/min)	-			70.0 (2472)			-		
Refrigerant type / amount g(oz)		-			R32	2.60k	(91.7)	-			
Product dimension	Height	mm(inch)	290 (11-13/32)			996 (39-7/32)			-		
	Width	mm(inch)	800 (31-1/2)			980 (38-37/64)			-		
	Depth	mm(inch)	700 (27-9/16)			370 (14-9/16)			-		
Product dimension (Panel)		H×W×D mm, inch	-			-			-		
Packing dimension	Height	mm(inch)	355 (13-31/32)			1134 (44-41/64)			-		
	Width	mm(inch)	1014 (39-15/16)			1095 (43-7/64)			-		
	Depth	mm(inch)	850 (33-15/32)			529 (20-53/64)			-		
Weight	(NET)	kg(lb)	28 (62)			90 (199)			-		
	(GROSS)	kg(lb)	35 (78)			98 (216)			-		
	Panel (NET)	kg(lb)	-			-			-		
Layers limit (actually)		9(10)			2 (3)			-			
Operation condition	Cool (DBT)	18°C ~ 32°C			-10°C ~ 43°C			-			
	Heat (DBT)	16°C ~ 30°C			-15°C ~ 24°C			-			
MAX WORKING PRESSURE HP/LP MPa (bar)		4.15/2.55 (41.5/25.5)			-			-			
P I	Pipe diameter mm (inch)	(Liquid)Ø6.35(1/4) (Gas)Ø12.7(1/2)			(Liquid)Ø9.52(3/8) (Gas)Ø15.88(5/8)			-			
	Connecting method, Standard length m(ft)	flared type, 5.0(16.4)			flared type, 5.0(16.4)			-			
P I	Pipe length range m (ft)	5 ~ 50m (16.4 ~ 164.0)			-			-			
N G	Indoor unit & Outdoor unit height difference m (ft)	15m(OD located lower)/30m(OD located higher) (49.2/98.4)			-			-			
	Add gas amount g/m (oz/ft)	45g/m (0.484)			-			-			
N G	Pipe length for additional gas m (ft)	30m (98.4)			-			-			

\*1 In case it is necessary to indicate the air flow volume in (l/s), the value in (m³/min.) shall be multiplied by 16.7 and rounded down the decimal point.

\*2 If the EUROVENT Certified models can be operated under the "extra-low" temperature condition, -7°C dry bulb and -8°C wet-bulb temperatures with rated voltage 230V shall be used.

\*3 Network Impedance shall be applicable for EUROPE and CHINA models.

\*4 The annual consumption is calculated by multiplying the input power at 230V(400V) by an average of 500 hours per year in cooling mode.

\*5 EER and COP classification is at 230V(400V) only in accordance with EU directive 2002/31/EC.

\*6 SEER and SCOP classification is at 230V(400V) only in accordance with EN-14825. For heating, SCOP indicates the value of only Average heating season, Other fiche data indicates in an attached sheet

# Simultaneous (Twin) -Type

## 1-1. Unit Specifications

**PZ2**

### 4. Low Silhouette Ducted Type S-60PF1E5Bx2 / U-125PZ2E8

INDOOR		MODEL	S-60PF1E5B x2			-			-		
PANEL		MODEL	-			-			-		
OUTDOOR		MODEL	-			U-125PZ2E8			-		
Branch pipe		MODEL	-			CZ-P155BK1			-		
Performance test condition					ISO13253 / EN14511 / EN12102/ EN14825						
Power supply		Ø, Hz	1Ø 50Hz			3Ø 50Hz			Min	Max	
		V	220V	230V	240V	380V	400V	415V			
C O L I N G	Capacity	kW	12.5	12.5	12.5	-	-	-	3.2	13.5	
		BTU/h	42700	42700	42700	-	-	-	10900	46100	
	Current	A	0.91x2	0.89x2	0.87x2	5.40	5.10	4.95	-	-	
		W	120x2	120x2	120x2	3.335k	3.335k	3.335k	-	-	
	Input power	TOTAL W	-	-	-	3.575k	3.575k	3.575k	600	4.820k	
		TOTAL kWh **	-	-	-	-	1787.5	-	-	-	
	Annual consumption	TOTAL kWh **	-	-	-	-	1787.5	-	-	-	
	EER/EER CLASS	TOTAL (W/W) <sup>1)</sup> ("A"-~"G")	-	-	-	3.50	3.50 /A	3.50	5.33	2.80	
	Erp <sup>6)</sup>	P <sub>design</sub>	kW	-	-	-	-	12.5	-	-	-
		η <sub>s.c</sub>	%	-	-	-	-	233	-	-	-
Annual consumption		kWh	-	-	-	-	-	-	-	-	
Class		-	-	-	-	-	-	-	-	-	
Power factor	%	-	-	-	94	94	94	-	-		
Noise indoor	dB-A (H/M/L)	35x2/32x2/26x2			-			-	-		
	Power Level dB	57x2/54x2/48x2			-			-	-		
Noise outdoor	dB-A (H/L)	-			55/-			-	-		
	Power Level dB	-			73/-			-	-		
H E A T I N G	Capacity	kW	12.5	12.5	12.5	-	-	-	3.3	15.0	
		BTU/h	42700	42700	42700	-	-	-	11300	51200	
	Current	A	0.91x2	0.89x2	0.87x2	4.70	4.45	4.30	-	-	
		W	120x2	120x2	120x2	2.900k	2.900k	2.900k	-	-	
	Input power	TOTAL W	-	-	-	3.140k	3.140k	3.140k	600	4.350k	
		TOTAL (W/W) <sup>1)</sup> ("A"-~"G")	-	-	-	3.98	3.98/A	3.98	5.50	3.45	
	Erp <sup>6)</sup>	P <sub>design</sub> at -10°C	kW	-	-	-	-	12.5	-	-	-
		T <sub>bivalent</sub>	°C	-	-	-	-	-7	-	-	-
		η <sub>s.h</sub>	%	-	-	-	-	142.7	-	-	-
		Annual consumption elbu(-10°C)	kWh	-	-	-	-	-	-	-	-
Class	-	-	-	-	-	-	-	-	-		
	-	-	-	-	-	-	-	-	-		
Power factor	%	-	-	-	94	94	94	-	-		
Noise indoor	dB-A (H/M/L)	35x2 / 32x2 / 26x2			-			-	-		
	Power Level dB	57x2 / 54x2 / 48x2			-			-	-		
Noise outdoor	dB-A (H/L)	-			55/-			-	-		
	Power Level dB	-			73/-			-	-		
EXTRA LOW TEMP Total capacity(kW) / Input power(W) / COP		-		-		-		-			
Max Current(A) / Max Input power(W)		1.26x2/160x2	1.20x2/160x2	1.15x2/160x2	10.0/6.20k	10.0/6.50k	10.0/6.75k	-			
Starting current(A) (Cooling/Heating)		-	-	-	5.40/4.70	5.10/4.45	4.95/4.30	-			
Comp output(W)		-		-		2.80k	2.80k	2.80k	-		
Network Impedance(ΩMAX.)		-		-		-		-			
Fan motor output (Indoor/Outdoor) W		-		124		120		-			
Moisture removal volume		L/h(Pt/h)	6.8	(3.4x2)	(14.3)	-		-			
External static pressure		Pa	70 (MIN10 - MAX150)			-		-			
Indoor Air flow	Cooling	m³/min (ft³/min)	21.0x2/19.0x2/15.0x2 (742x2)/(671x2)/(530x2)			-		-			
	Heating	m³/min (ft³/min)	21.0x2/19.0x2/15.0x2 (742x2)/(671x2)/(530x2)			-		-			
Outdoor Air flow	Cooling	m³/min (ft³/min)	-			86.0 (3037)		-			
	Heating	m³/min (ft³/min)	-			78.0 (2754)		-			
Refrigerant type / amount g(oz)		-		-		R32	2.98k	(105.1)	-		
Product dimension	Height	mm(inch)	290 (11-13/32)			996 (39-7/32)			-		
	Width	mm(inch)	1000 (39-3/8)			980 (38-37/64)			-		
	Depth	mm(inch)	700 (27-9/16)			370 (14-9/16)			-		
Product dimension (Panel)		HxWxD mm, inch	-			-			-		
Packing dimension	Height	mm(inch)	355 (13-31/32)			1134 (44-41/64)			-		
	Width	mm(inch)	1214 (47-13/16)			1095 (43-7/64)			-		
	Depth	mm(inch)	850 (33-15/32)			529 (20-53/64)			-		
Weight	(NET)	kg(lb)	33 (73)			94 (207)			-		
	(GROSS)	kg(lb)	41 (91)			102 (224)			-		
	Panel (NET)	kg(lb)	-			-			-		
Layers limit (actually)		9(10)			2 (3)			-			
Operation condition	Cool (DBT)	18°C ~ 32°C			-10°C ~ 43°C			-			
	Heat (DBT)	16°C ~ 30°C			-15°C ~ 24°C			-			
MAX WORKING PRESSURE HP/LP MPa (bar)		-		4.15/2.55 (41.5/25.5)		-		-			
P I	Pipe diameter mm (inch)	(Liquid)Ø9.52(3/8) (Gas)Ø15.88(5/8)			(Liquid)Ø9.52(3/8) (Gas)Ø15.88(5/8)			-			
	Connecting method, Standard length m(ft)	flared type, 5.0(16.4)			flared type, 5.0(16.4)			-			
P I	Pipe length range m (ft)	5 ~ 50m (16.4 ~ 164.0)			-			-			
	Indoor unit & Outdoor unit height difference m (ft)	15m(OD located lower)/30m(OD located higher) (49.2/98.4)			-			-			
N G	Add gas amount g/m (oz/ft)	45g/m (0.484)			-			-			
	Pipe length for additional gas m (ft)	30m (98.4)			-			-			

\*1 In case it is necessary to indicate the air flow volume in (l/s), the value in (m³/min.) shall be multiplied by 16.7 and rounded down the decimal point.  
 \*2 If the EUROVENT Certified models can be operated under the "extra-low" temperature condition, -7°C dry bulb and -8°C wet-bulb temperatures with rated voltage 230V shall be used.  
 \*3 Network Impedance shall be applicable for EUROPE and CHINA models.  
 \*4 The annual consumption is calculated by multiplying the input power at 230V(400V) by an average of 500 hours per year in cooling mode.  
 \*5 EER and COP classification is at 230V(400V) only in accordance with EU directive 2002/31/EC.  
 \*6 η<sub>s.c</sub> and η<sub>s.h</sub> classification is at 230V(400V) only in accordance with EN-14825. For heating, η<sub>s.h</sub> indicates the value of only Average heating season.

# Simultaneous (Twin) -Type

## 1-1. Unit Specifications

**PZ2**

### 4. Low Silhouette Ducted Type S-71PF1E5Bx2 / U-140PZ2E8

INDOOR		MODEL	S-71PF1E5B x2			-			-		
PANEL		MODEL	-			-			-		
OUTDOOR		MODEL	-			U-140PZ2E8			-		
Branch pipe		MODEL	-			CZ-P155BK1			-		
Performance test condition		ISO13253 / EN14511 / EN12102/ EN14825									
Power supply		Ø, Hz	1Ø 50Hz			3Ø 50Hz			Min	Max	
		V	220V	230V	240V	380V	400V	415V			
C O L I N G	Capacity	kW	14.0	14.0	14.0	-	-	-	3.3	15.0	
		BTU/h	47800	47800	47800	-	-	-	11300	51200	
	Current	A	0.91×2	0.89×2	0.87×2	6.75	6.40	6.15	-	-	
		W	120×2	120×2	120×2	4.175k	4.175k	4.175k	-	-	
	Input power	TOTAL W	-	-	-	4.415k	4.415k	4.415k	620	5.560k	
		Annual consumption	TOTAL kWh **	-	-	-	-	2207.5	-	-	-
	EER/EER CLASS	TOTAL (W/W) <sup>1)</sup> ("A"-~"G")	-	-	-	3.17	3.17/B	3.17	5.32	2.70	
	Erp <sup>5)</sup>	P <sub>design</sub>	kW	-	-	-	-	14.0	-	-	-
		η <sub>s,c</sub>	%	-	-	-	-	221.7	-	-	-
		Annual consumption	kWh	-	-	-	-	-	-	-	-
Class			-	-	-	-	-	-	-	-	
Power factor	%	-	-	-	94	94	94	-	-		
Noise indoor	dB-A (H/M/L)	35×2/32×2/26×2			-			-	-		
	Power Level dB	57×2/54×2/48×2			-			-	-		
Noise outdoor	dB-A (H/L)	-			56/-			-	-		
	Power Level dB	-			74/-			-	-		
H E A T I N G	Capacity	kW	14.0	14.0	14.0	-	-	-	3.4	16.0	
		BTU/h	47800	47800	47800	-	-	-	11600	54600	
	Current	A	0.91×2	0.89×2	0.87×2	5.60	5.30	5.15	-	-	
		W	120×2	120×2	120×2	3.465k	3.465k	3.465k	-	-	
	Input power	TOTAL W	-	-	-	3.705k	3.705k	3.705k	620	5.120k	
		COP/COP CLASS	TOTAL (W/W) <sup>1)</sup> ("A"-~"G")	-	-	-	3.78	3.78 /A	3.78	5.48	3.13
	Erp <sup>5)</sup>	P <sub>design</sub> at -10°C	kW	-	-	-	-	13.6	-	-	-
		T <sub>bivalent</sub>	°C	-	-	-	-	-7	-	-	-
		η <sub>s,h</sub>	%	-	-	-	-	139.4	-	-	-
		Annual consumption	kWh	-	-	-	-	-	-	-	-
elbu(-10°C)		kW	-	-	-	-	2.70	-	-	-	
Class			-	-	-	-	-	-	-	-	
Power factor	%	-	-	-	94	94	94	-	-		
Noise indoor	dB-A (H/M/L)	35×2 / 32×2 / 26×2			-			-	-		
	Power Level dB	57×2 / 54×2 / 48×2			-			-	-		
Noise outdoor	dB-A (H/L)	-			56/-			-	-		
	Power Level dB	-			74/-			-	-		
EXTRA LOW TEMP Total capacity(kW) / Input power(W) / COP		-									
Max Current(A) / Max Input power(W)		1.26×2/160×2	1.20×2/160×2	1.15×2/160×2	10.5/6.50k	10.5/6.85k	10.5/7.10k	-			
Starting current(A) (Cooling/Heating)		-	-	-	6.75/5.60	6.40/5.30	6.15/5.15	-			
Comp output(W)		-			3.00k	3.00k	3.00k	-			
Network Impedance(ΩMAX.)		-									
Fan motor output (Indoor/Outdoor) W		124			120			-			
Moisture removal volume		L/h(Pt/h)	8.4	(4.2×2)	(17.6)	-			-		
External static pressure		Pa	70 (MIN10 - MAX150)			-			-		
Indoor	Cooling	m <sup>3</sup> /min (ft <sup>3</sup> /min)	21.0×2/19.0×2/15.0×2 (742×2)/(671×2)/(530×2)			-			-		
	Heating	m <sup>3</sup> /min (ft <sup>3</sup> /min)	21.0×2/19.0×2/15.0×2 (742×2)/(671×2)/(530×2)			-			-		
Outdoor	Cooling	m <sup>3</sup> /min (ft <sup>3</sup> /min)	-			89.0 (3143)			-		
	Heating	m <sup>3</sup> /min (ft <sup>3</sup> /min)	-			83.0 (2931)			-		
Refrigerant type / amount g(oz)		-			R32	2.98k	(105.1)	-			
Product dimension	Height	mm(inch)	290 (11-13/32)			996 (39-7/32)			-		
	Width	mm(inch)	1000 (39-3/8)			980 (38-37/64)			-		
	Depth	mm(inch)	700 (27-9/16)			370 (14-9/16)			-		
Product dimension (Panel)		H×W×D mm, inch	-			-			-		
Packing dimension	Height	mm(inch)	355 (13-31/32)			1134 (44-41/64)			-		
	Width	mm(inch)	1214 (47-13/16)			1095 (43-7/64)			-		
	Depth	mm(inch)	850 (33-15/32)			529 (20-53/64)			-		
Weight	(NET)	kg(lb)	33 (73)			94 (207)			-		
	(GROSS)	kg(lb)	41 (91)			102 (224)			-		
	Panel (NET)	kg(lb)	-			-			-		
Layers limit (actually)		9(10)			2 (3)			-			
Operation condition	Cool (DBT)	18°C ~ 32°C			-10°C ~ 43°C			-			
	Heat (DBT)	16°C ~ 30°C			-15°C ~ 24°C			-			
MAX WORKING PRESSURE HP/LP MPa (bar)		4.15/2.55 (41.5/25.5)									
P I P I N G	Pipe diameter mm (inch)	(Liquid)Ø9.52(3/8) (Gas)Ø15.88(5/8)			(Liquid)Ø9.52(3/8) (Gas)Ø15.88(5/8)			-			
	Connecting method, Standard length m(ft)	flared type, 5.0(16.4)			flared type, 5.0(16.4)			-			
Pipe length range m (ft)		5 ~ 50m (16.4 ~ 164.0)									
Indoor unit & Outdoor unit height difference m (ft)		15m(OD located lower)/30m(OD located higher) (49.2/98.4)									
Add gas amount g/m (oz/ft)		45g/m (0.484)									
Pipe length for additional gas m (ft)		30m (98.4)									

\*1 In case it is necessary to indicate the air flow volume in (l/s), the value in (m<sup>3</sup>/min.) shall be multiplied by 16.7 and rounded down the decimal point.

\*2 If the EUROVENT Certified models can be operated under the "extra-low" temperature condition, -7°C dry bulb and -8°C wet-bulb temperatures with rated voltage 230V shall be used.

\*3 Network Impedance shall be applicable for EUROPE and CHINA models.

\*4 The annual consumption is calculated by multiplying the input power at 230V(400V) by an average of 500 hours per year in cooling mode.

\*5 EER and COP classification is at 230V(400V) only in accordance with EU directive 2002/31/EC.

\*6 η<sub>s,c</sub> and η<sub>s,h</sub> classification is at 230V(400V) only in accordance with EN-14825. For heating, η<sub>s,h</sub> indicates the value of only Average heating season.



# Single -Type

## 1-1. Unit Specifications

**PZ2**

### 4. Low Silhouette Ducted Type S-100PF1E5B / U-100PZ2E8

INDOOR	MODEL	S-100PF1E5B			-			-			
PANEL	MODEL	-			-			-			
OUTDOOR	MODEL	-			U-100PZ2E8			-			
Branch pipe	MODEL	-			-			-			
Performance test condition		ISO13253 / EN14511 / EN12102/ EN14825									
Power supply		Ø, Hz	1Ø 50Hz			3Ø 50Hz			Min	Max	
		V	220V	230V	240V	380V	400V	415V			
C O L I N G	Capacity	kW	10.0	10.0	10.0	-	-	-	3.0	11.5	
		BTU/h	34100	34100	34100	-	-	-	10200	39200	
	Current	A	1.35	1.30	1.27	4.15	3.95	3.80	-	-	
		W	195	195	195	2.535k	2.535k	2.535k	-	-	
	Input power	TOTAL W	-			2.730k	2.730k	2.730k	560	4.090k	
		Annual consumption	TOTAL kWh **	-			-	1365	-	-	-
	EER/EER CLASS	TOTAL (W/W) <sup>1)</sup> ("A"~"G")	-	-	-	3.66	3.66/A	3.66	5.36	2.81	
	E <sub>rp</sub> <sup>*5</sup>	Pdesign	kW	-	-	-	-	10.0	-	-	-
		SEER	(W/W)	-	-	-	-	5.6	-	-	-
		Annual consumption	kWh	-	-	-	-	625	-	-	-
Class			-	-	-	-	A+	-	-	-	
Power factor	%	-	-	-	93	93	93	-	-		
Noise indoor	dB-A (H/M/L)	38/34/31			-			-	-		
	Power Level dB	60/56/53			-			-	-		
Noise outdoor	dB-A (H/L)	-			52/-			-	-		
	Power Level dB	-			70/-			-	-		
H E A T I N G	Capacity	kW	10.0	10.0	10.0	-	-	-	3.0	14.0	
		BTU/h	34100	34100	34100	-	-	-	10200	47800	
	Current	A	1.37	1.34	1.29	3.45	3.30	3.20	-	-	
		W	200	200	200	2.120k	2.120k	2.120k	-	-	
	Input power	TOTAL W	-			2.320k	2.320k	2.320k	560	3.990k	
		COP/COP CLASS	TOTAL (W/W) <sup>1)</sup> ("A"~"G")	-	-	-	4.31	4.31/A	4.31	5.36	3.51
	E <sub>rp</sub> <sup>*5</sup>	Pdesign at -10°C	kW	-	-	-	-	10.0	-	-	-
		Tbivalent	°C	-	-	-	-	-10	-	-	-
		SCOP	(W/W)	-	-	-	-	3.8	-	-	-
		Annual consumption	kWh	-	-	-	-	3684	-	-	-
Class	elbu(-10°C)	kW	-	-	-	-	0.00	-	-	-	
	Class		-	-	-	-	A	-	-	-	
Power factor	%	-	-	-	93	93	92	-	-		
Noise indoor	dB-A (H/M/L)	38/34/31			-			-	-		
	Power Level dB	60/56/53			-			-	-		
Noise outdoor	dB-A (H/L)	-			52/-			-	-		
	Power Level dB	-			70/-			-	-		
EXTRA LOW TEMP   Total capacity(kW) / Input power(W) / COP		-									
Max Current(A) / Max Input power(W)		1.80/265	1.75/265	1.70/265	9.00/5.55k	9.00/5.80k	9.00/6.05k	-			
Starting current(A) (Cooling/Heating)		-	-	-	4.15/3.45	3.95/3.30	3.80/3.20	-			
Comp output(W)		-			2.50k	2.50k	2.50k	-			
Network Impedance(ΩMAX.)		-			-			-			
Fan motor output (Indoor/Outdoor) W		235			120			-			
Moisture removal volume		L/h(Pt/h)	6.0	(12.6)		-			-		
External static pressure		Pa	100 (MIN10 - MAX150)			-			-		
Indoor Air flow	Cooling	m³/min (ft³/min)	32.0/26.0/21.0 (1130)/(918)/(742)			-			-		
	Heating	m³/min (ft³/min)	32.0/26.0/21.0 (1130)/(918)/(742)			-			-		
Outdoor Air flow	Cooling	m³/min (ft³/min)	-			76.0 (2683)			-		
	Heating	m³/min (ft³/min)	-			70.0 (2472)			-		
Refrigerant type / amount g(oz)		-			R32	2.60k	(91.7)	-			
Product dimension	Height	mm(inch)	290 (11-13/32)			996 (39-7/32)			-		
	Width	mm(inch)	1400 (55-1/8)			980 (38-37/64)			-		
	Depth	mm(inch)	700 (27-9/16)			370 (14-9/16)			-		
Product dimension (Panel)		H×W×D mm, inch	-			-			-		
Packing dimension	Height	mm(inch)	355 (13-31/32)			1134 (44-41/64)			-		
	Width	mm(inch)	1614 (63-9/16)			1095 (43-7/64)			-		
	Depth	mm(inch)	850 (33-15/32)			529 (20-53/64)			-		
Weight	(NET)	kg(lb)	45 (99)			90 (199)			-		
	(GROSS)	kg(lb)	54 (119)			98 (216)			-		
	Panel (NET)	kg(lb)	-			-			-		
Layers limit (actually)		9(10)			2 (3)			-			
Operation condition	Cool (DBT)	18°C ~ 32°C			-10°C ~ 43°C			-			
	Heat (DBT)	16°C ~ 30°C			-15°C ~ 24°C			-			
MAX WORKING PRESSURE HP/LP MPa (bar)		4.15/2.55 (41.5/25.5)									
P I P I N G	Pipe diameter mm (inch)	(Liquid)Ø9.52(3/8) (Gas)Ø15.88(5/8)			(Liquid)Ø9.52(3/8) (Gas)Ø15.88(5/8)			-			
	Connecting method, Standard length m(ft)	flared type, 5.0(16.4)			flared type, 5.0(16.4)			-			
Pipe length range m (ft)		5 ~ 50m (16.4 ~ 164.0)									
Indoor unit & Outdoor unit height difference m (ft)		15m(OD located lower)/30m(OD located higher) (49.2/98.4)									
Add gas amount g/m (oz/ft)		45g/m (0.484)									
Pipe length for additional gas m (ft)		30m (98.4)									

\*1 In case it is necessary to indicate the air flow volume in (l/s), the value in (m³/min.) shall be multiplied by 16.7 and rounded down the decimal point.  
 \*2 If the EUROVENT Certified models can be operated under the "extra-low" temperature condition, -7°C dry bulb and -8°C wet-bulb temperatures with rated voltage 230V shall be used.  
 \*3 Network Impedance shall be applicable for EUROPE and CHINA models.  
 \*4 The annual consumption is calculated by multiplying the input power at 230V(400V) by an average of 500 hours per year in cooling mode.  
 \*5 EER and COP classification is at 230V(400V) only in accordance with EU directive 2002/31/EC.  
 \*6 SEER and SCOP classification is at 230V(400V) only in accordance with EN-14825. For heating, SCOP indicates the value of only Average heating season, Other fiche data indicates in an attached sheet

# Single -Type

## 1-1. Unit Specifications

**PZ2**

### 4. Low Silhouette Ducted Type S-125PF1E5B / U-125PZ2E8

INDOOR		MODEL	S-125PF1E5B			-			-	
PANEL		MODEL	-			-			-	
OUTDOOR		MODEL	-			U-125PZ2E8			-	
Branch pipe		MODEL	-			-			-	
Performance test condition		ISO13253 / EN14511 / EN12102/ EN14825								
Power supply		Ø, Hz	1Ø 50Hz			3Ø 50Hz			Min	Max
		V	220V	230V	240V	380V	400V	415V		
C O O L I N G	Capacity	kW	12.5	12.5	12.5	-	-	-	3.2	13.5
		BTU/h	42700	42700	42700	-	-	-	10900	46100
	Current	A	1.48	1.44	1.39	5.40	5.10	4.95	-	-
		W	215	215	215	3.335k	3.335k	3.335k	-	-
	Input power	TOTAL W	-			3.550k	3.550k	3.550k	600	4.820k
		TOTAL kWh **	-			-	1775	-	-	-
	Annual consumption	TOTAL kWh **	-			-	1775	-	-	-
	EER/EER CLASS	TOTAL (W/W) <sup>1)</sup> ("A"~"G")	-	-	-	3.52	3.52/A	3.52	5.33	2.80
	Erp <sup>6)</sup>	P <sub>design</sub>	kW	-	-	-	-	12.5	-	-
		η <sub>s.c</sub>	%	-	-	-	-	218.5	-	-
		Annual consumption	kWh	-	-	-	-	-	-	-
		Class		-	-	-	-	-	-	-
	Power factor	%	-	-	-	94	94	94	-	-
	Noise indoor	dB-A (H/M/L)	39/35/32			-			-	-
Power Level dB		61/57/54			-			-	-	
Noise outdoor	dB-A (H/L)	-			55/-			-	-	
	Power Level dB	-			73/-			-	-	
H E A T I N G	Capacity	kW	12.5	12.5	12.5	-	-	-	3.3	15.0
		BTU/h	42700	42700	42700	-	-	-	11300	51200
	Current	A	1.46	1.42	1.38	4.70	4.45	4.30	-	-
		W	210	210	210	2.900k	2.900k	2.900k	-	-
	Input power	TOTAL W	-			3.110k	3.110k	3.110k	600	4.350k
		TOTAL kWh **	-			-	-	-	-	-
	COP/COP CLASS	TOTAL (W/W) <sup>1)</sup> ("A"~"G")	-	-	-	4.02	4.02 /A	4.02	5.50	3.45
	Erp <sup>6)</sup>	P <sub>design</sub> at -10°C	kW	-	-	-	-	12.5	-	-
		T <sub>bivalent</sub>	°C	-	-	-	-	-7	-	-
		η <sub>s.h</sub>	%	-	-	-	-	141.5	-	-
		Annual consumption	kWh	-	-	-	-	-	-	-
		elbu(-10°C)	kW	-	-	-	-	2.30	-	-
		Class		-	-	-	-	-	-	-
	Power factor	%	-	-	-	94	94	94	-	-
Noise indoor	dB-A (H/M/L)	39/35/32			-			-	-	
	Power Level dB	61/57/54			-			-	-	
Noise outdoor	dB-A (H/L)	-			55/-			-	-	
	Power Level dB	-			73/-			-	-	
EXTRA LOW TEMP Total capacity(kW) / Input power(W) / COP		-								
Max Current(A) / Max Input power(W)		1.80/265	1.75/265	1.70/265	10.0/6.20k	10.0/6.50k	10.0/6.75k	-		
Starting current(A) (Cooling/Heating)		-	-	-	5.40/4.70	5.10/4.45	4.95/4.30	-		
Comp output(W)		-			2.80k	2.80k	2.80k	-		
Network Impedance(ΩMAX.)		-			-			-		
Fan motor output (Indoor/Outdoor) W		235			120			-		
Moisture removal volume		L/h(Pt/h)	7.9	(16.6)		-			-	
External static pressure		Pa	100 (MIN10 - MAX150)			-			-	
Indoor Air flow	Cooling	m <sup>3</sup> /min (ft <sup>3</sup> /min)	34.0/29.0/23.0 (1201)/(1024)/(812)			-			-	
	Heating	m <sup>3</sup> /min (ft <sup>3</sup> /min)	34.0/29.0/23.0 (1201)/(1024)/(812)			-			-	
Outdoor Air flow	Cooling	m <sup>3</sup> /min (ft <sup>3</sup> /min)	-			86.0 (3037)			-	
	Heating	m <sup>3</sup> /min (ft <sup>3</sup> /min)	-			78.0 (2754)			-	
Refrigerant type / amount (g/oz)		-			R32	2.98k	(105.1)	-		
Product dimension	Height	mm(inch)	290 (11-13/32)			996 (39-7/32)			-	
	Width	mm(inch)	1400 (55-1/8)			980 (38-37/64)			-	
	Depth	mm(inch)	700 (27-9/16)			370 (14-9/16)			-	
Product dimension (Panel)		H×W×D mm, inch	-			-			-	
Packing dimension	Height	mm(inch)	355 (13-31/32)			1134 (44-41/64)			-	
	Width	mm(inch)	1614 (63-9/16)			1095 (43-7/64)			-	
	Depth	mm(inch)	850 (33-15/32)			529 (20-53/64)			-	
Weight	(NET)	kg(lb)	45 (99)			94 (207)			-	
	(GROSS)	kg(lb)	54 (119)			102 (224)			-	
	Panel (NET)	kg(lb)	-			-			-	
Layers limit (actually)		9(10)			2 (3)			-		
Operation condition	Cool (DBT)	18°C ~ 32°C			-10°C ~ 43°C			-		
	Heat (DBT)	16°C ~ 30°C			-15°C ~ 24°C			-		
MAX WORKING PRESSURE HP/LP MPa (bar)		4.15/2.55 (41.5/25.5)								
P I	Pipe diameter mm (inch)	(Liquid)Ø9.52(3/8) (Gas)Ø15.88(5/8)			(Liquid)Ø9.52(3/8) (Gas)Ø15.88(5/8)			-		
	Connecting method, Standard length m(ft)	flared type, 5.0(16.4)			flared type, 5.0(16.4)			-		
P I	Pipe length range m (ft)	5 ~ 50m (16.4 ~ 164.0)								
N I	Indoor unit & Outdoor unit height difference m (ft)	15m(OD located lower)/30m(OD located higher) (49.2/98.4)								
N G	Add gas amount g/m (oz/ft)	45g/m (0.484)								
	Pipe length for additional gas m (ft)	30m (98.4)								

\*1 In case it is necessary to indicate the air flow volume in (l/s), the value in (m<sup>3</sup>/min.) shall be multiplied by 16.7 and rounded down the decimal point.

\*2 If the EUROVENT Certified models can be operated under the "extra-low" temperature condition, -7°C dry bulb and -8°C wet-bulb temperatures with rated voltage 230V shall be used.

\*3 Network Impedance shall be applicable for EUROPE and CHINA models.

\*4 The annual consumption is calculated by multiplying the input power at 230V(400V) by an average of 500 hours per year in cooling mode.

\*5 EER and COP classification is at 230V(400V) only in accordance with EU directive 2002/31/EC.

\*6 η<sub>s.c</sub> and η<sub>s.h</sub> classification is at 230V(400V) only in accordance with EN-14825. For heating, η<sub>s.h</sub> indicates the value of only Average heating season.

# Single -Type

## 1-1. Unit Specifications

**PZ2**

### 4. Low Silhouette Ducted Type S-140PF1E5B / U-140PZ2E8

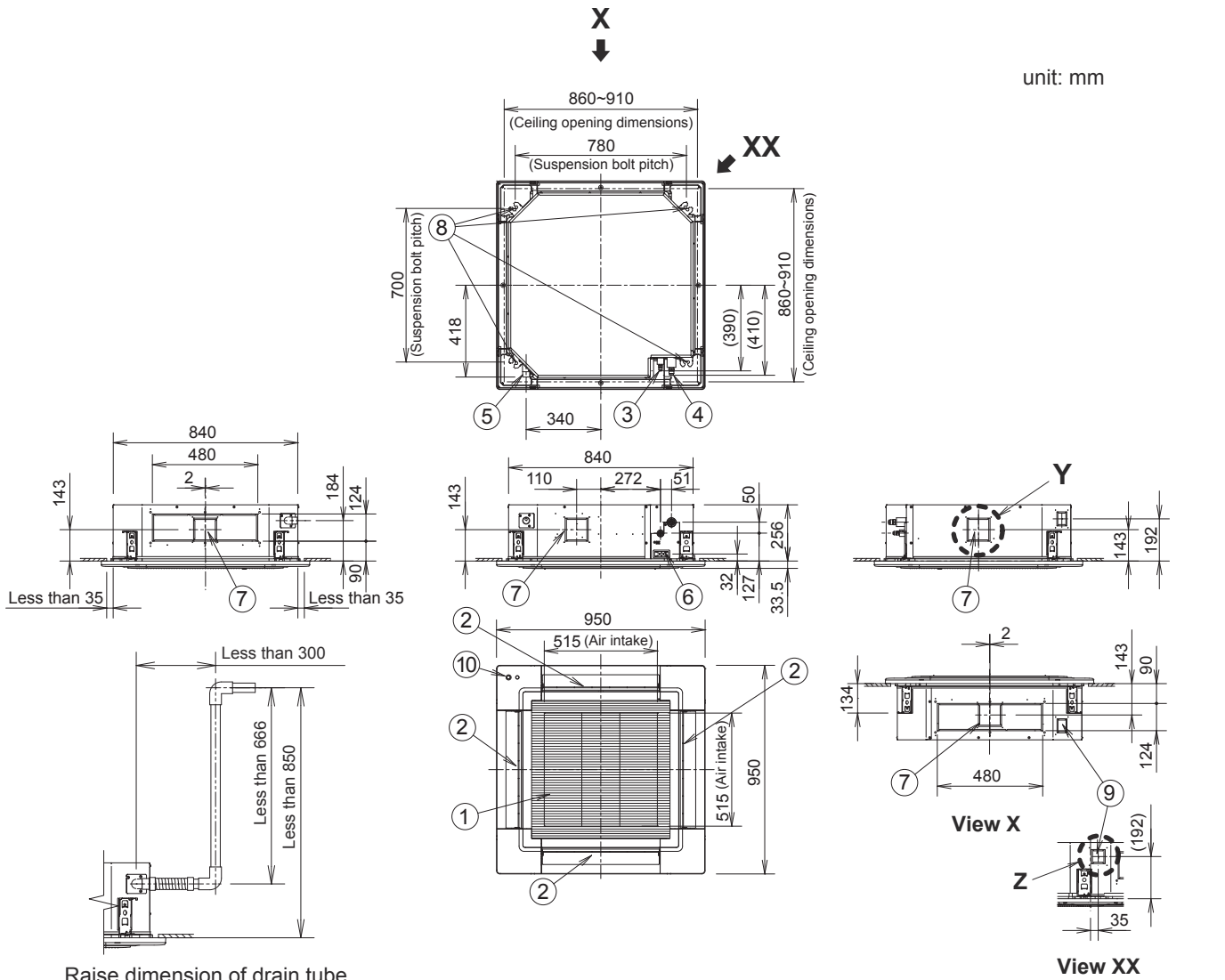
INDOOR		MODEL	S-140PF1E5B			-			-		
PANEL		MODEL	-			-			-		
OUTDOOR		MODEL	-			U-140PZ2E8			-		
Branch pipe		MODEL	-			-			-		
Performance test condition					ISO13253 / EN14511 / EN12102/ EN14825						
Power supply		Ø, Hz	1Ø 50Hz			3Ø 50Hz			Min	Max	
		V	220V	230V	240V	380V	400V	415V			
Capacity		kW	14.0	14.0	14.0	-	-	-	3.3	15.0	
		BTU/h	47800	47800	47800	-	-	-	11300	51200	
Current		A	1.55	1.50	1.47	6.75	6.40	6.15	-	-	
Input power		W	225	225	225	4.175k	4.175k	4.175k	-	-	
		TOTAL W	-			4.400k	4.400k	4.400k	620	5.560k	
Annual consumption		TOTAL kWh **	-			-	2200	-	-	-	
EER/EER CLASS		TOTAL (W/W) <sup>5)</sup> ("A"-~"G")	-	-	-	3.18	3.18 /B	3.18	5.32	2.70	
C O L I N G	Erp *6	Pdesign	kW	-	-	-	14.0	-	-	-	
		η <sub>s.c</sub>	%	-	-	-	211.8	-	-	-	
		Annual consumption	kWh	-	-	-	-	-	-	-	-
		Class		-	-	-	-	-	-	-	-
		Power factor	%	-	-	-	94	94	94	-	-
Noise indoor	dB-A (H/M/L)		40/36/33			-			-	-	
	Power Level dB		62/58/55			-			-	-	
Noise outdoor	dB-A (H/L)		-			56/-			-	-	
	Power Level dB		-			74/-			-	-	
H E A T I N G	Erp *6	Capacity	kW	14.0	14.0	14.0	-	-	-	3.4	16.0
			BTU/h	47800	47800	47800	-	-	-	11600	54600
		Current	A	1.55	1.50	1.46	5.60	5.30	5.15	-	-
		Input power	W	225	225	225	3.465k	3.465k	3.465k	-	-
			TOTAL W	-			3.690k	3.690k	3.690k	620	5.120k
COP/COP CLASS		TOTAL (W/W) <sup>5)</sup> ("A"-~"G")	-	-	-	3.79	3.79 /A	3.79	5.48	3.13	
Erp *6	Pdesign at -10°C	kW	-	-	-	-	13.6	-	-	-	
	Tbivalent	°C	-	-	-	-	-7	-	-	-	
	η <sub>s.h</sub>	%	-	-	-	-	138.4	-	-	-	
	Annual consumption	kWh	-	-	-	-	-	-	-	-	
	elbu(-10°C)	kW	-	-	-	-	2.70	-	-	-	
Class		-	-	-	-	-	-	-	-	-	
Power factor	%	-	-	-	94	94	94	-	-		
Noise indoor	dB-A (H/M/L)		40/36/33			-			-	-	
	Power Level dB		62/58/55			-			-	-	
Noise outdoor	dB-A (H/L)		-			56/-			-	-	
	Power Level dB		-			74/-			-	-	
EXTRA LOW TEMP   Total capacity(kW) / Input power(W) / COP											
Max Current(A) / Max Input power(W)			1.91/285	1.86/285	1.81/285	10.5/6.50k	10.5/6.85k	10.5/7.10k	-		
Starting current(A) (Cooling/Heating)			-	-	-	6.75/5.60	6.40/5.30	6.15/5.15	-		
Comp output(W)			-			3.00k	3.00k	3.00k	-		
Network Impedance(ΩMAX.)			-			-			-		
Fan motor output (Indoor/Outdoor) W			235			120			-		
Moisture removal volume			L/h(Pt/h)	9.0	(18.9)	-			-		
External static pressure			Pa	100 (MIN10 - MAX150)			-			-	
Indoor	Cooling	m³/min (ft³/min)	36.0/32.0 25.0 (1271)/(1130)/(883)			-			-		
	Heating	m³/min (ft³/min)	36.0/32.0 25.0 (1271)/(1130)/(883)			-			-		
Outdoor	Cooling	m³/min (ft³/min)	-			89.0 (3143)			-		
	Heating	m³/min (ft³/min)	-			83.0 (2931)			-		
Refrigerant type / amount g(oz)			-			R32	2.98k	(105.1)	-		
Product dimension	Height	mm(inch)	290 (11-13/32)			996 (39-7/32)			-		
	Width	mm(inch)	1400 (55-1/8)			980 (38-37/64)			-		
	Depth	mm(inch)	700 (27-9/16)			370 (14-9/16)			-		
Product dimension (Panel)		H×W×D mm, inch	-			-			-		
Packing dimension	Height	mm(inch)	355 (13-31/32)			1134 (44-41/64)			-		
	Width	mm(inch)	1614 (63-9/16)			1095 (43-7/64)			-		
	Depth	mm(inch)	850 (33-15/32)			529 (20-53/64)			-		
Weight	(NET)	kg(lb)	45 (99)			94 (207)			-		
	(GROSS)	kg(lb)	54 (119)			102 (224)			-		
	Panel (NET)	kg(lb)	-			-			-		
Layers limit (actually)			9(10)			2 (3)			-		
Operation condition	Cool (DBT)		18°C ~ 32°C			-10°C ~ 43°C			-		
	Heat (DBT)		16°C ~ 30°C			-15°C ~ 24°C			-		
MAX WORKING PRESSURE HP/LP MPa (bar)					4.15/2.55 (41.5/25.5)						
P I P I N G	Pipe diameter mm (inch)		(Liquid)Ø9.52(3/8) (Gas)Ø15.88(5/8)			(Liquid)Ø9.52(3/8) (Gas)Ø15.88(5/8)			-		
	Connecting method, Standard length m(ft)		flared type, 5.0(16.4)			flared type, 5.0(16.4)			-		
Pipe length range		m (ft)	5 ~ 50m (16.4 ~ 164.0)			-			-		
Indoor unit & Outdoor unit height difference		m (ft)	15m(OD located lower)/30m(OD located higher) (49.2/98.4)			-			-		
Add gas amount		g/m (oz/ft)	45g/m (0.484)			-			-		
Pipe length for additional gas		m (ft)	30m (98.4)			-			-		

\*1 In case it is necessary to indicate the air flow volume in (l/s), the value in (m³/min.) shall be multiplied by 16.7 and rounded down the decimal point.  
 \*2 If the EUROVENT Certified models can be operated under the "extra-low" temperature condition, -7°C dry bulb and -8°C wet-bulb temperatures with rated voltage 230V shall be used.  
 \*3 Network Impedance shall be applicable for EUROPE and CHINA models.  
 \*4 The annual consumption is calculated by multiplying the input power at 230V(400V) by an average of 500 hours per year in cooling mode.  
 \*5 EER and COP classification is at 230V(400V) only in accordance with EU directive 2002/31/EC.  
 \*6 η<sub>s.c</sub> and η<sub>s.h</sub> classification is at 230V(400V) only in accordance with EN-14825. For heating, η<sub>s.h</sub> indicates the value of only Average heating season.

1-2. Dimensional Data

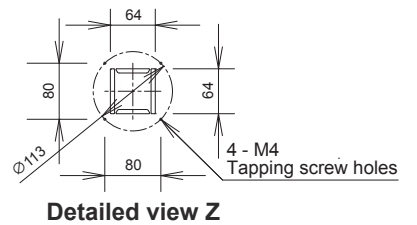
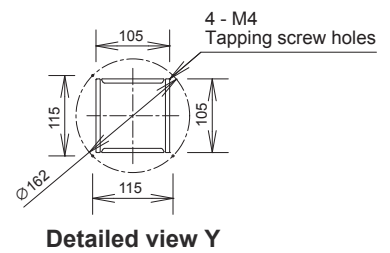
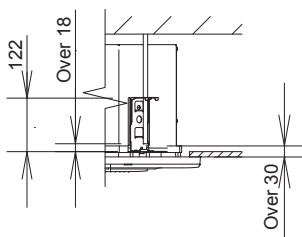
(A) Indoor Units: S-50PU2E5B / S-60PU2E5B / S-71PU2E5B

unit: mm



Raise dimension of drain tube

The length of the suspension bolts should be selected so that there is a gap of 30 mm or more below the lower surface of the ceiling (18 mm or more below the lower surface of the main unit), as shown in the figure at right. If the suspension bolt is too long, it will contact the ceiling panel and the unit cannot be installed.



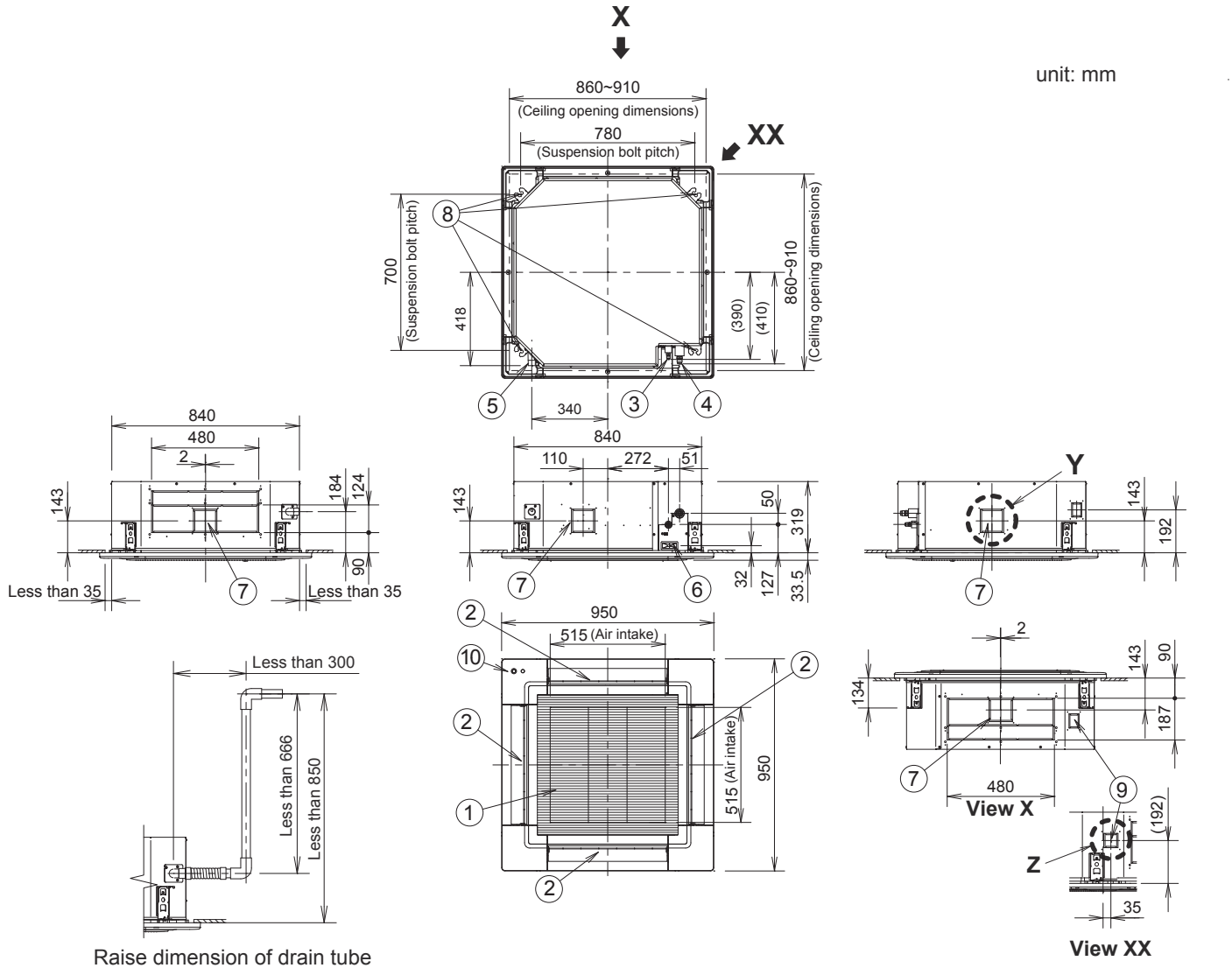
①	Air intake
②	Discharge outlet
③	Refrigerant tubing (liquid tube) 50 type $\varnothing 6.35$ (flared), 60 · 71 type $\varnothing 9.52$ (flared)
④	Refrigerant tubing (gas tube) 50 type $\varnothing 12.7$ (flared), 60 · 71 type $\varnothing 15.88$ (flared)
⑤	Drain tube connection port VP25 (outer dia. $\varnothing 32$ )
⑥	Power supply port
⑦	Discharge duct connection port ( $\varnothing 150$ )
⑧	Suspension bolt hole (4-12×30 elongated hole)
⑨	Fresh air intake duct connection port ( $\varnothing 100$ ) *
⑩	ECONAVI sensor (Only CZ-KPU3A)

\* Necessary to attach duct connecting flange(field supplied).

<Filter dimension>  
520 x 520 x 15

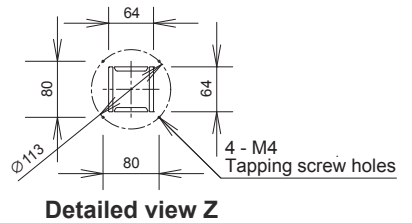
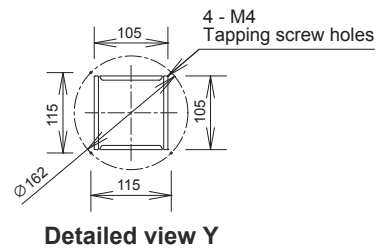
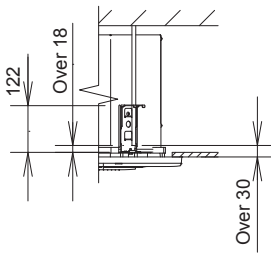
1-2. Dimensional Data

(A) Indoor Units: S-100PU2E5B / S-125PU2E5B / S-140PU2E5B



Raise dimension of drain tube

The length of the suspension bolts should be selected so that there is a gap of 30 mm or more below the lower surface of the ceiling (18 mm or more below the lower surface of the main unit), as shown in the figure at right. If the suspension bolt is too long, it will contact the ceiling panel and the unit cannot be installed.



①	Air intake
②	Discharge outlet
③	Refrigerant tubing (liquid tube) $\varnothing 9.52$ (flared)
④	Refrigerant tubing (gas tube) $\varnothing 15.88$ (flared)
⑤	Drain tube connection port VP25 (outer dia. $\varnothing 32$ )
⑥	Power supply port
⑦	Discharge duct connection port ( $\varnothing 150$ )
⑧	Suspension bolt hole (4-12x30 elongated hole)
⑨	Fresh air intake duct connection port ( $\varnothing 100$ ) *
⑩	ECONAVI sensor (Only CZ-KPU3A)

\* Necessary to attach duct connecting flange(field supplied).

<Filter dimension>

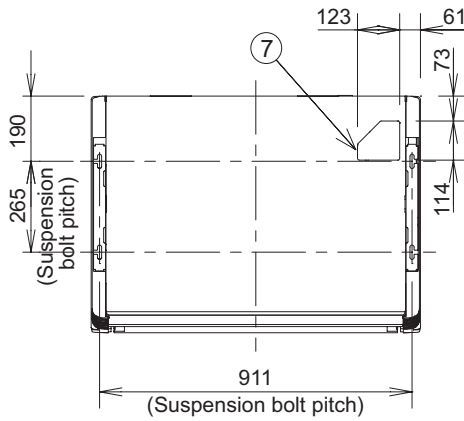
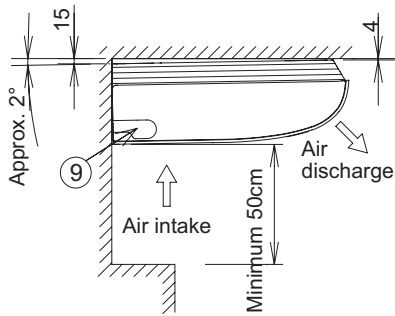
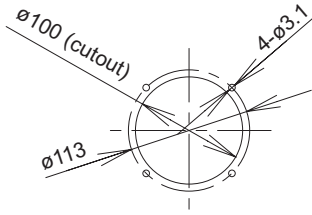
520 x 520 x 15

1-2. Dimensional Data

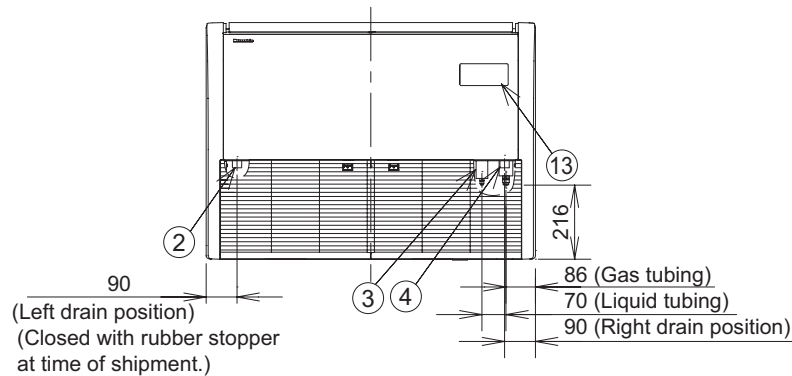
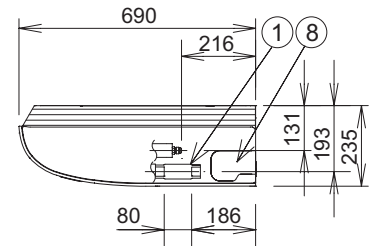
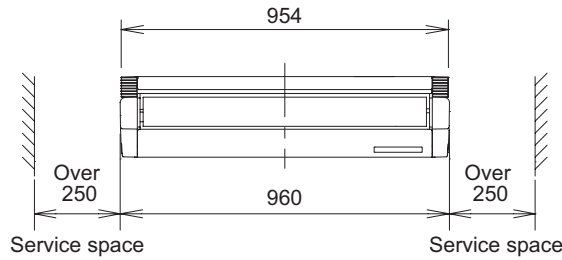
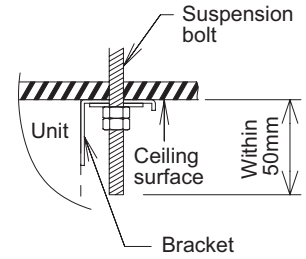
(A) Indoor Units: S-50PT2E5B

unit :mm

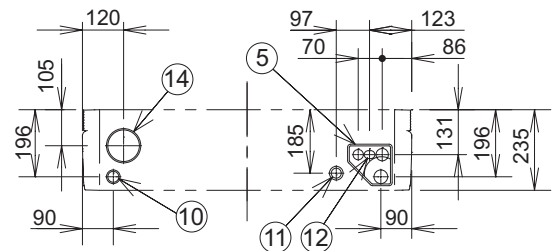
Detailed view of intaking outside air duct connection port



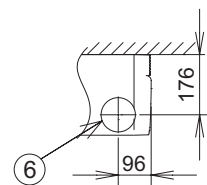
Distance of each exposed bolt must be of equal length within 50mm.



Hole position of indoor unit rear-side  
(Figure shows view from front)



Tubing hole position on wall surface  
(Figure shows view from front)



①	Drain port VP20 (inside diameter $\phi 26\text{mm}$ , drain hose supplied)
②	Left drain position
③	Refrigerant liquid tubing ( $\phi 6.35\text{mm}$ , flare connection)
④	Refrigerant gas tubing ( $\phi 12.7\text{mm}$ , flare connection)
⑤	Cover of rear tubing hole
⑥	Tubing hole on wall surface ( $\phi 100\text{mm}$ )
⑦	Upper side tubing port
⑧	Right side drain hose outlet port (cutout)
⑨	Left side drain hose outlet port (cutout)
⑩	Left-rear side drain hose outlet port (cutout)
⑪	Power inlet port
⑫	Remote control wiring and inter-unit wiring inlet port
⑬	Wireless remote controller receiver installation location
⑭	Outside air intake duct connection port ( $\phi 100\text{mm}$ , cutout)

<Filter size>

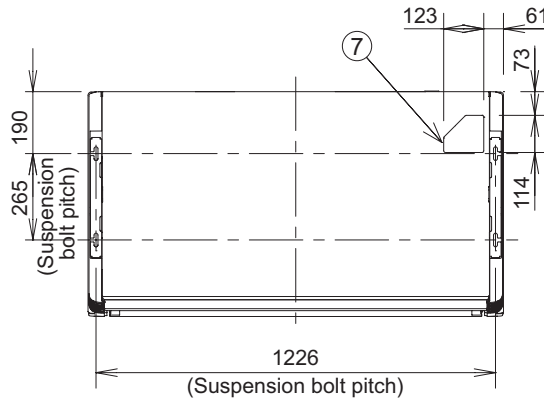
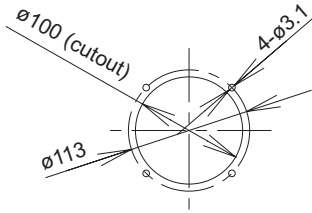
(421 x 250 x 16) x 2 pcs.

1-2. Dimensional Data

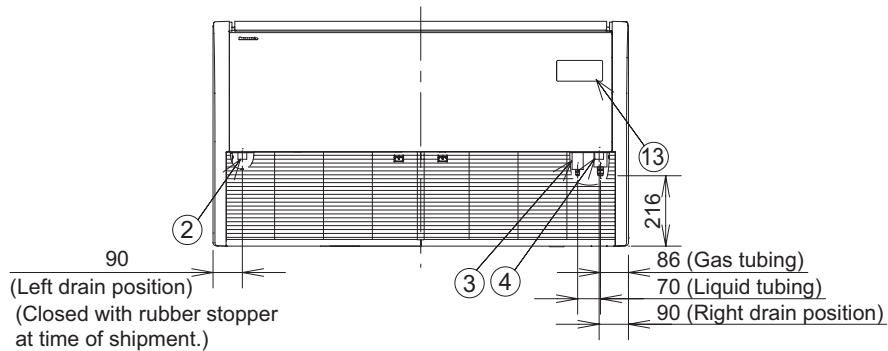
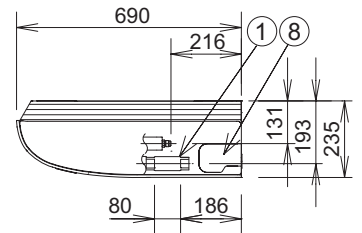
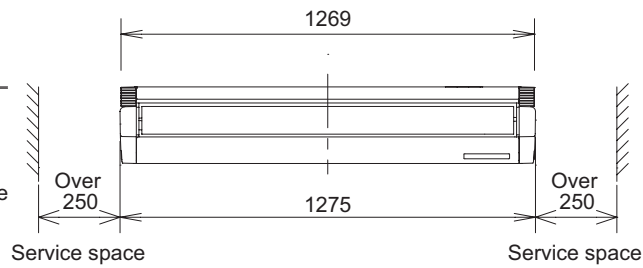
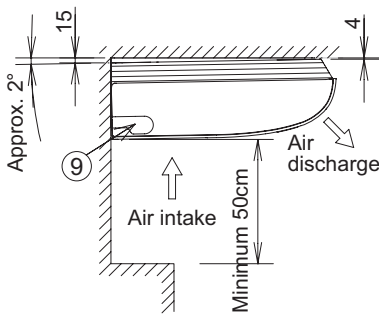
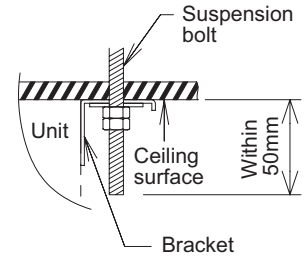
(A) Indoor Units: S-60PT2E5B, S-71PT2E5B

unit :mm

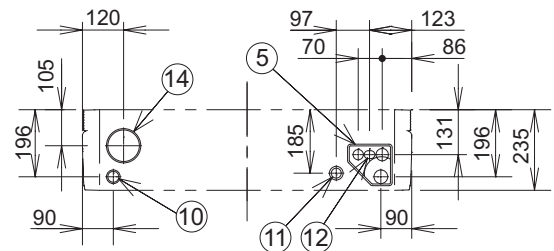
Detailed view of intaking outside air duct connection port



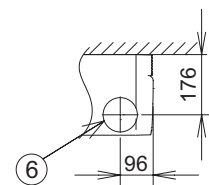
Distance of each exposed bolt must be of equal length within 50mm.



Hole position of indoor unit rear-side (Figure shows view from front)



Tubing hole position on wall surface (Figure shows view from front)



①	Drain port VP20 (inside diameter $\phi 26\text{mm}$ , drain hose supplied)
②	Left drain position
③	Refrigerant liquid tubing ( $\phi 9.52\text{mm}$ , flare connection)
④	Refrigerant gas tubing ( $\phi 15.88\text{mm}$ , flare connection)
⑤	Cover of rear tubing hole
⑥	Tubing hole on wall surface ( $\phi 100\text{mm}$ )
⑦	Upper side tubing port
⑧	Right side drain hose outlet port (cutout)
⑨	Left side drain hose outlet port (cutout)
⑩	Left-rear side drain hose outlet port (cutout)
⑪	Power inlet port
⑫	Remote control wiring and inter-unit wiring inlet port
⑬	Wireless remote controller receiver installation location
⑭	Outside air intake duct connection port ( $\phi 100\text{mm}$ , cutout)

<Filter size>

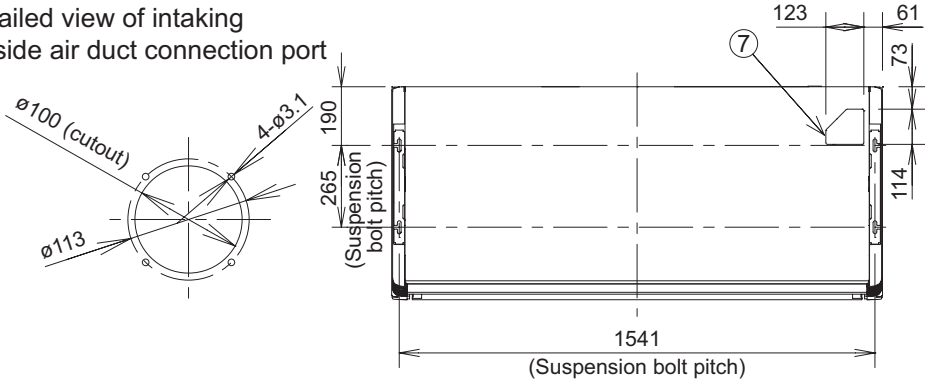
(579 x 250 x 16) x 2 pcs.

1-2. Dimensional Data

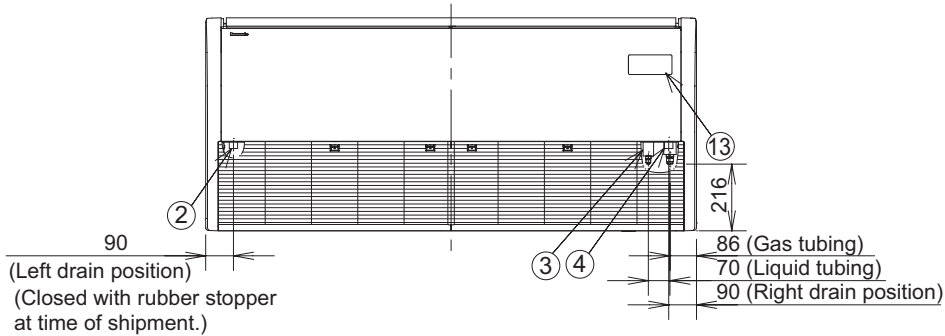
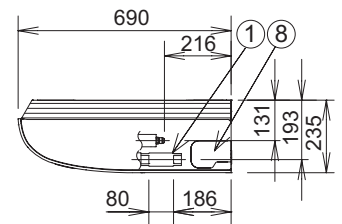
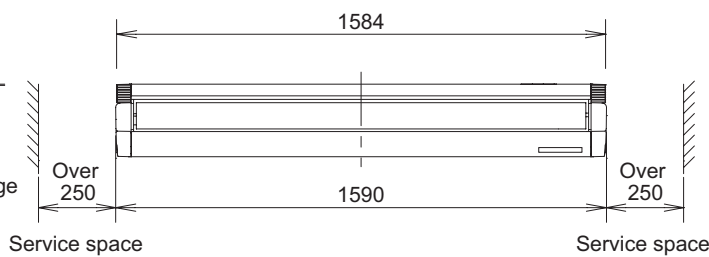
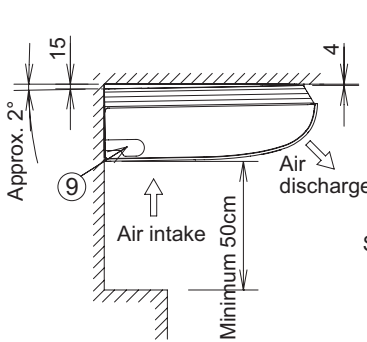
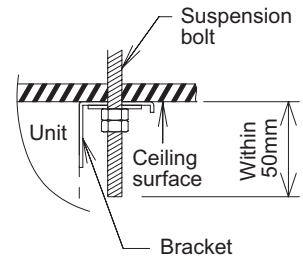
(A) Indoor Units: S-100PT2E5B, S-125PT2E5B, S-140PT2E5B

unit :mm

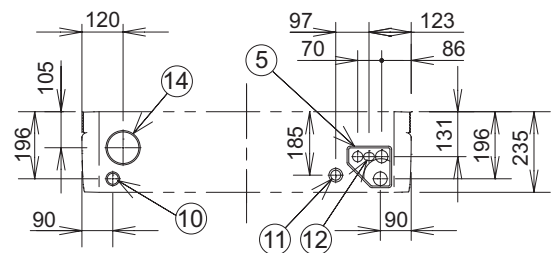
Detailed view of intaking outside air duct connection port



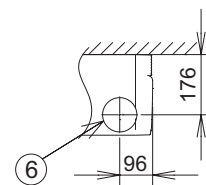
Distance of each exposed bolt must be of equal length within 50mm.



Hole position of indoor unit rear-side (Figure shows view from front)



Tubing hole position on wall surface (Figure shows view from front)



①	Drain port VP20 (inside diameter $\phi$ 26mm, drain hose supplied)
②	Left drain position
③	Refrigerant liquid tubing ( $\phi$ 9.52mm, flare connection)
④	Refrigerant gas tubing ( $\phi$ 15.88mm, flare connection)
⑤	Cover of rear tubing hole
⑥	Tubing hole on wall surface ( $\phi$ 100mm)
⑦	Upper side tubing port
⑧	Right side drain hose outlet port (cutout)
⑨	Left side drain hose outlet port (cutout)
⑩	Left-rear side drain hose outlet port (cutout)
⑪	Power inlet port
⑫	Remote control wiring and inter-unit wiring inlet port
⑬	Wireless remote controller receiver installation location
⑭	Outside air intake duct connection port ( $\phi$ 100mm, cutout)

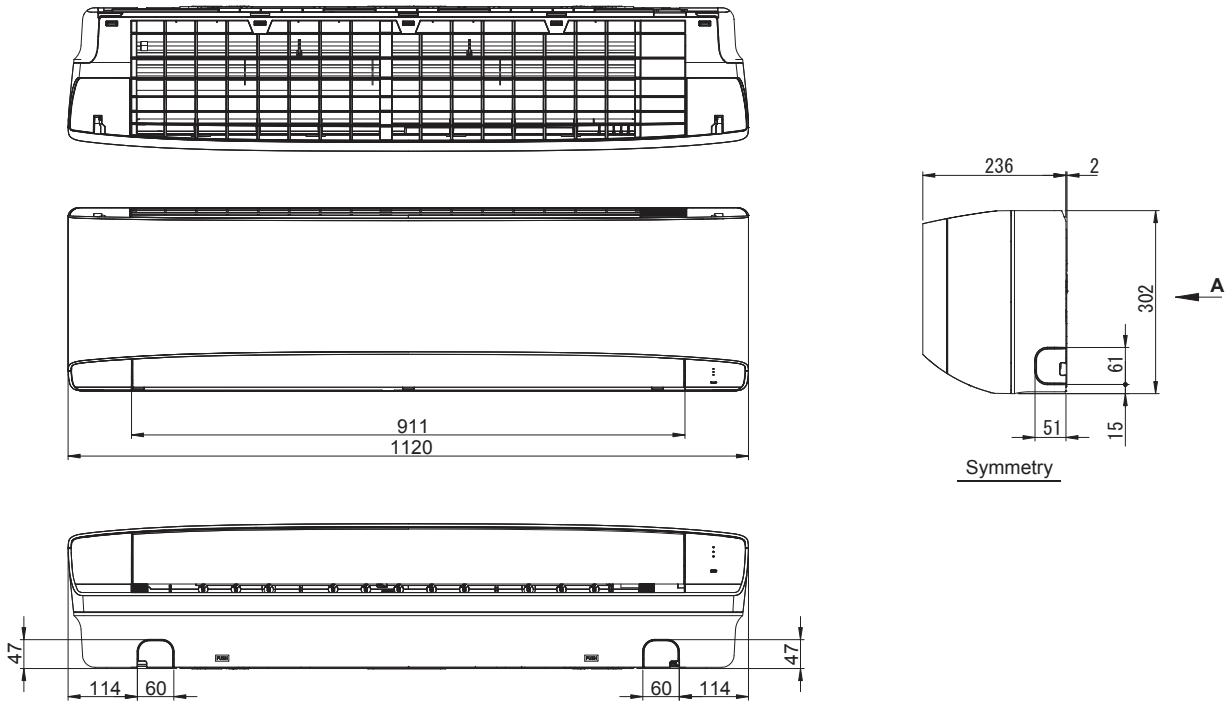
<Filter size>

(736 x 250 x 16) x 2 pcs.



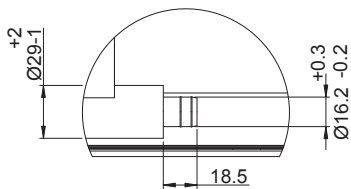
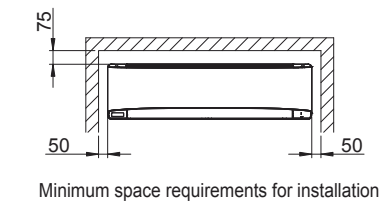
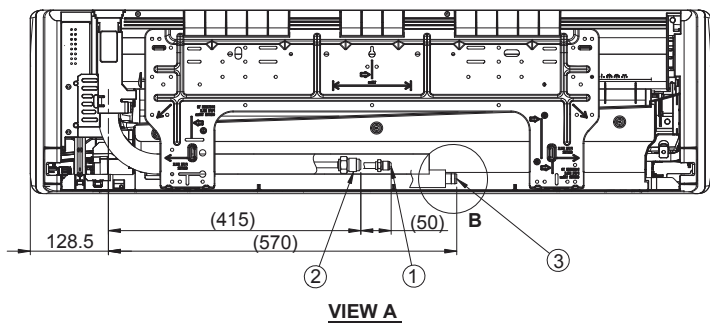
1-2. Dimensional Data

(A) Indoor units: S-50PK2E5B, 60PK2E5B, 71PK2E5B, 100PK2E5B

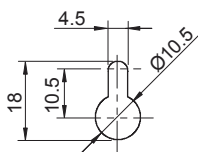


unit: mm

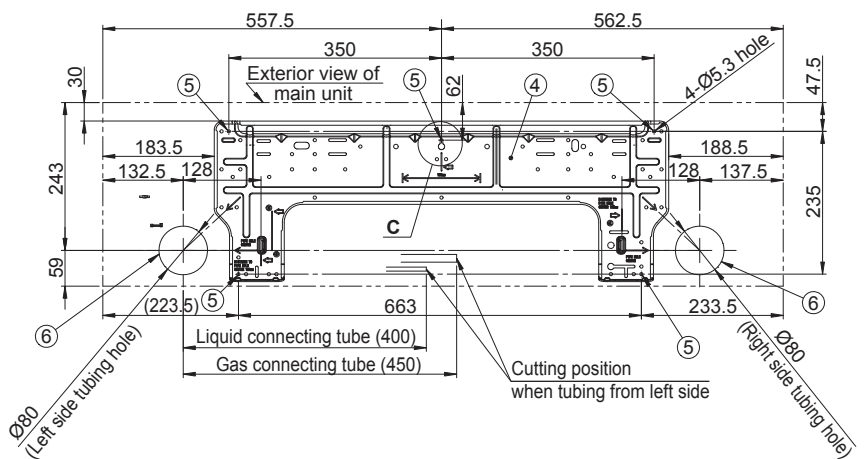
① Refrigerant tubing (liquid tube)	Type 50	Ø6.35 (flared)
	Type 60-100	Ø9.52 (flared)
② Refrigerant tubing (gas tube)	Type 50	Ø12.7 (flared)
	Type 60-100	Ø15.88 (flared)
③ Drain hose		
④ Rear panel		
⑤ Rear panel fixing holes (Ø5.3 holes or as shown in figure "C")		
⑥ Tubing and wiring holes (Ø80)		



Detailed view B



Detailed view C

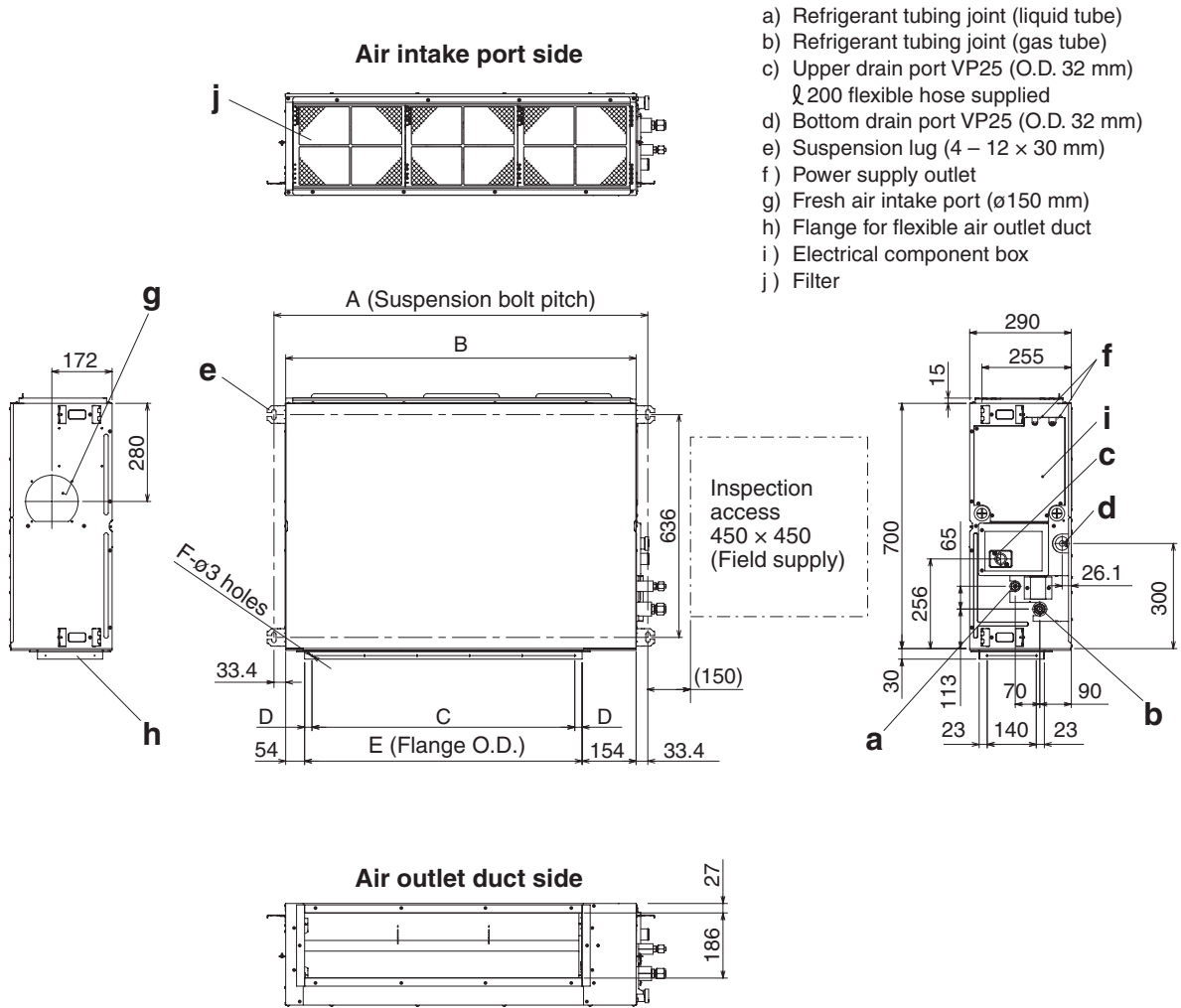


1-2. Dimensional Data

(A) Indoor Units: S-50PF1E5B, S-60PF1E5B, S-71PF1E5B, S-100PF1E5B, S-125PF1E5B, S-140PF1E5B

Unit: mm

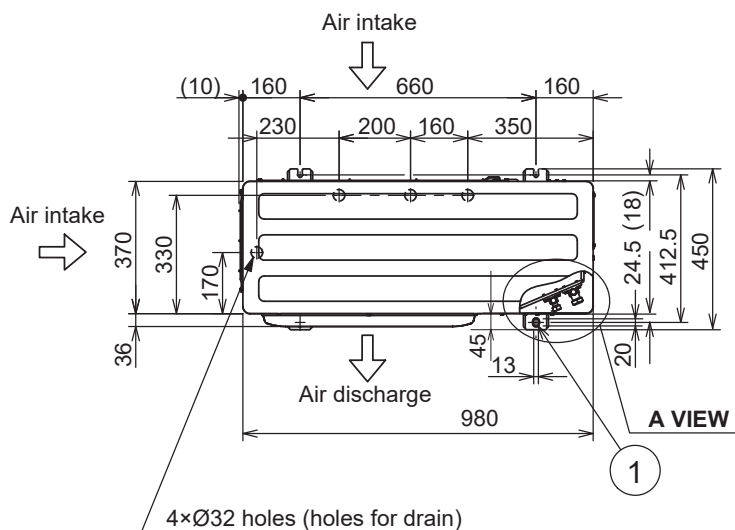
Type	A	B	C	D	E	F
50	867	800	450 (Pitch 150 × 3)	71	592	12
60, 71	1,067	1,000	750 (Pitch 150 × 5)	21	792	16
100, 125, 140	1,467	1,400	1,050 (Pitch 150 × 7)	71	1,192	20



1-2. Dimensional Data

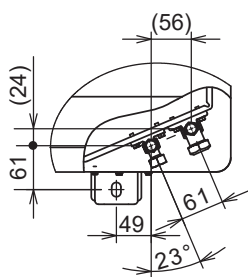
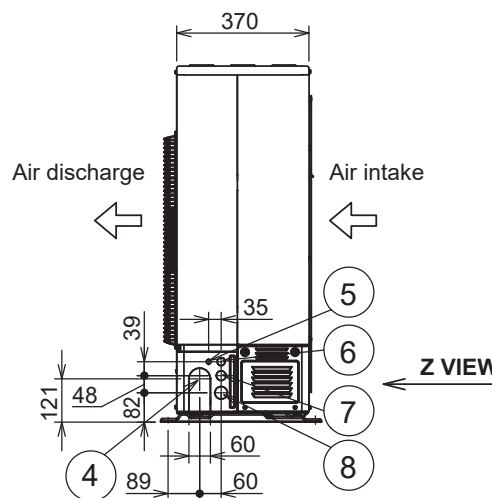
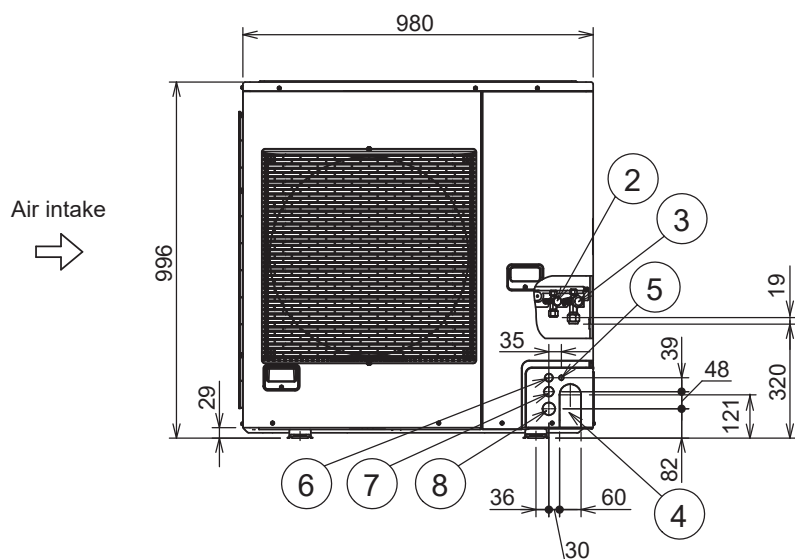
(B) Outdoor Units: U-100PZ2E5 / U-125PZ2E5 / U-140PZ2E5  
 U-100PZ2E8 / U-125PZ2E8 / U-140PZ2E8

Unit: mm

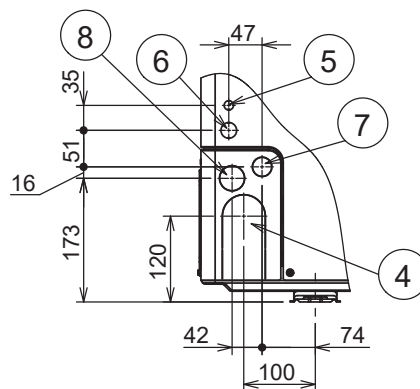


①	Mounting hole (4-R6.5), anchor bolt : M10
②	Refrigerant tubing (liquid tube), flared connection (Ø9.52)
③	Refrigerant tubing (gas tube), flared connection (Ø15.88)
④	Refrigerant tubing port
⑤	Electrical wiring port (Ø13)
⑥	Electrical wiring port (Ø22)
⑦	Electrical wiring port (Ø27)
⑧	Electrical wiring port (Ø35)

When using a drain pipe, install the drain socket (field supply) on to the drain port. Seal the other drain port with the rubber cap.



A VIEW

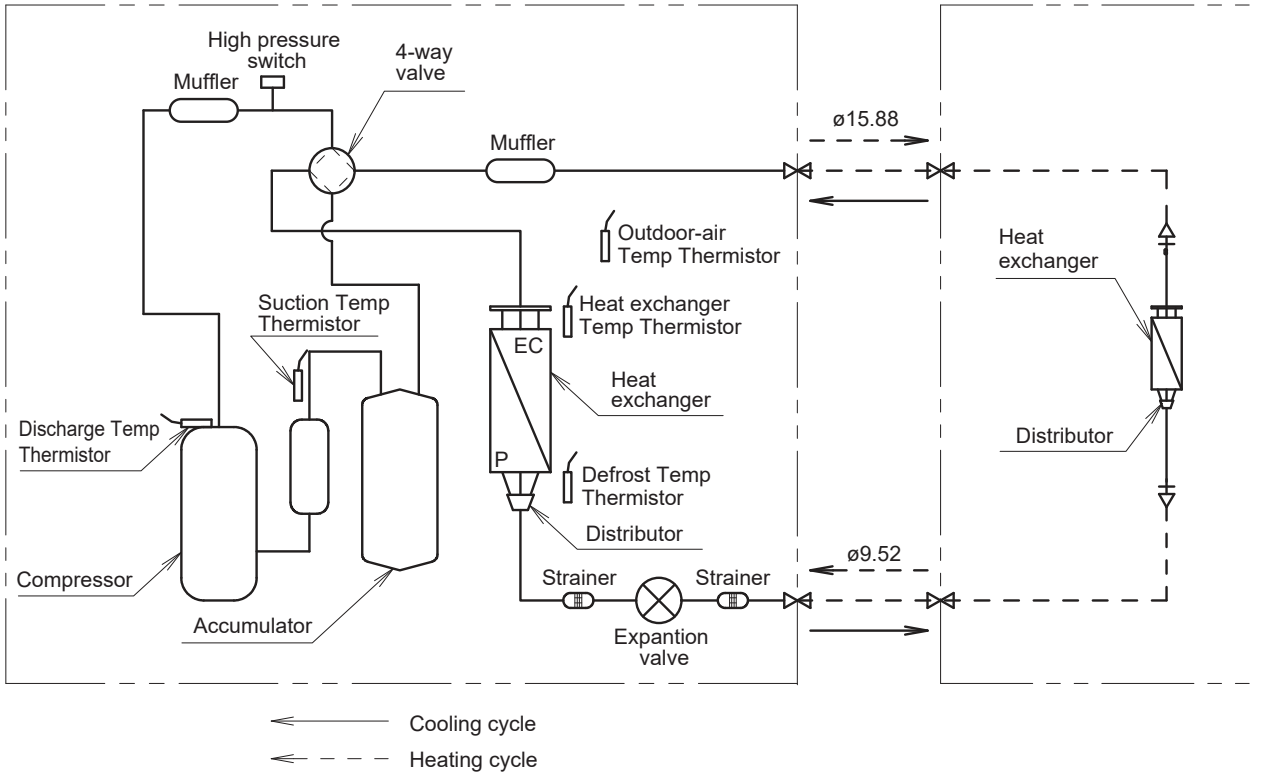


Z VIEW

1-3. Refrigerant Flow Diagram

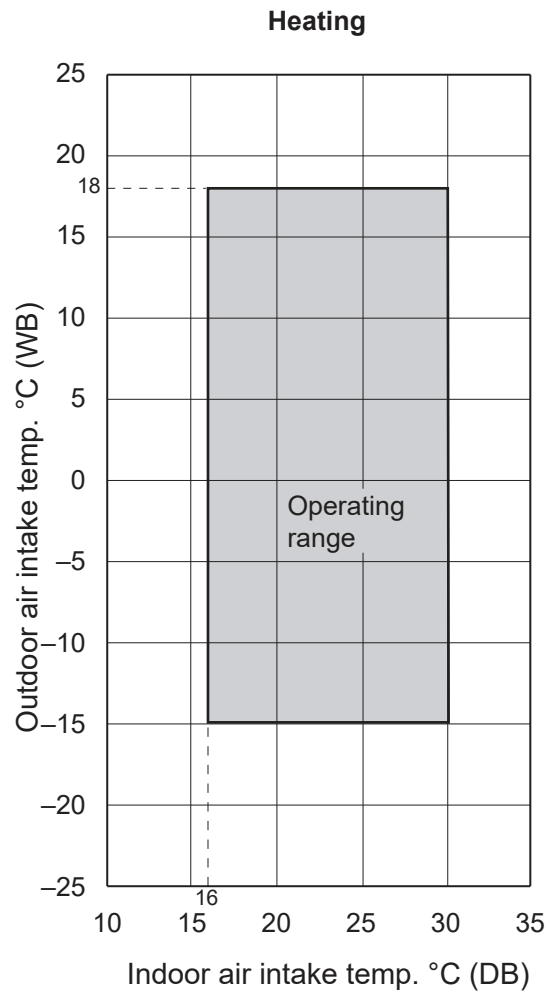
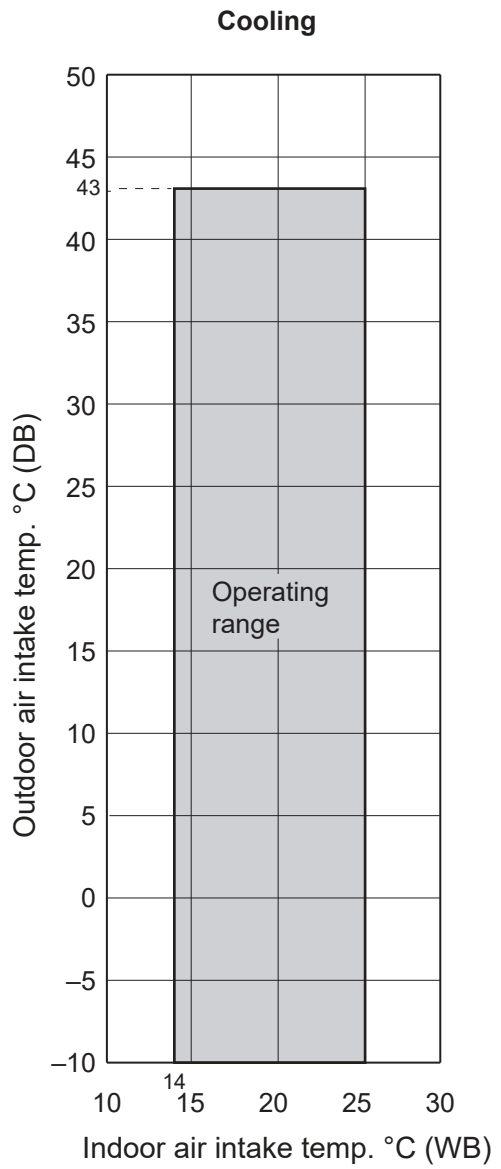
Outdoor Units: U-100PZ2E5 / U-125PZ2E5 / U-140PZ2E5  
 U-100PZ2E8 / U-125PZ2E8 / U-140PZ2E8

Indoor Unit:



1-4. Operating Range

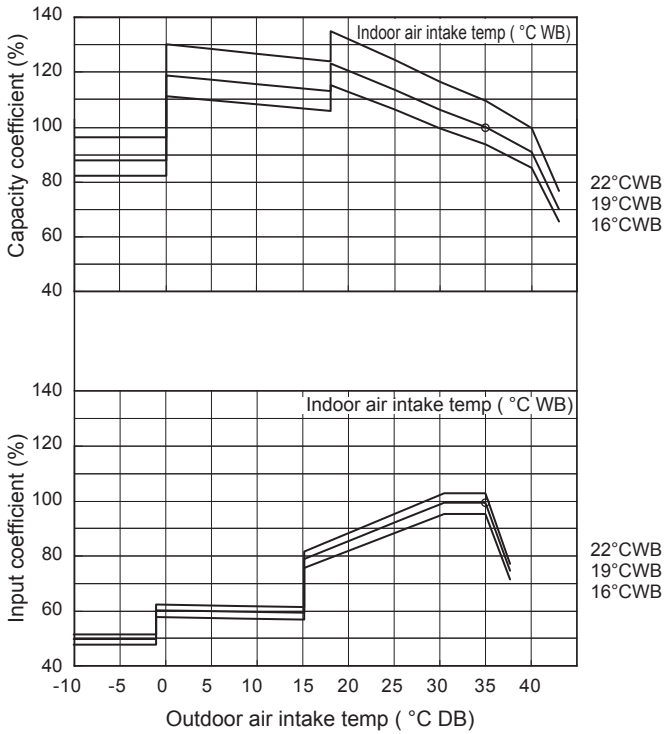
	Temperature	Indoor air intake temp.	Outdoor air intake temp.
Cooling	Maximum	32°C DB / 25°C WB	43°C DB
	Minimum	18°C DB / 14°C WB	-10°C DB
Heating	Maximum	30°C DB / – WB	24°C DB/18°C WB
	Minimum	16°C DB / – WB	-15°C DB / -15°C WB



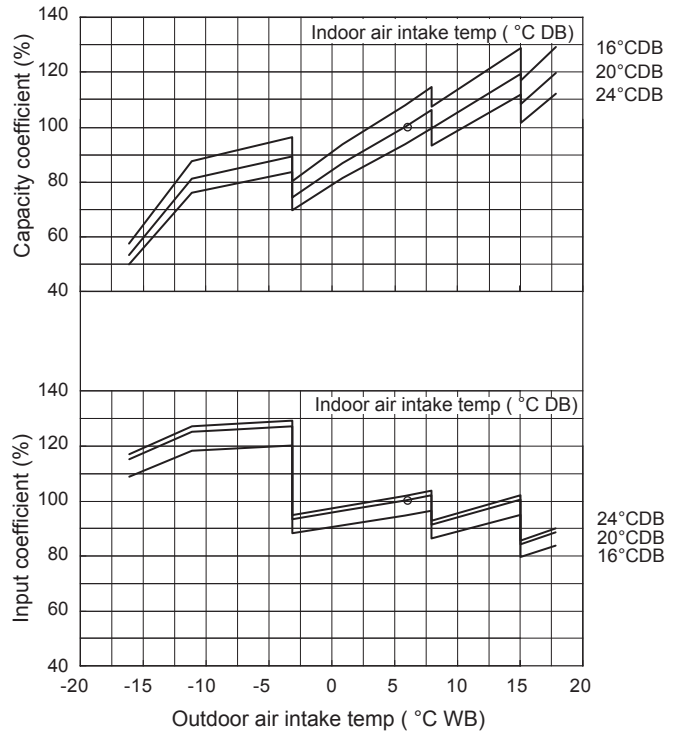
### 1-5. Capacity Correction Graph According to Temperature Condition

U-100PZ2E5 (For 50 Hz), U-100PZ2E8 (For 50 Hz)

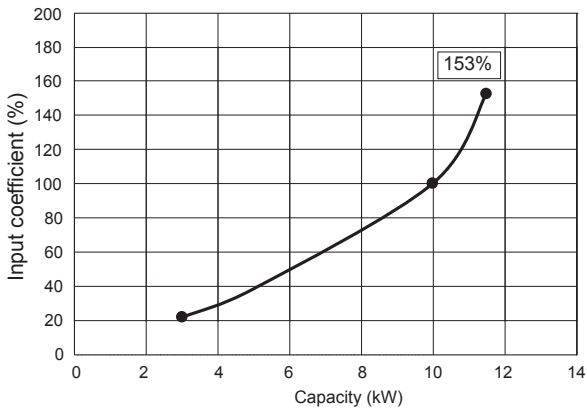
Cooling capacity ratio (maximum capacity)



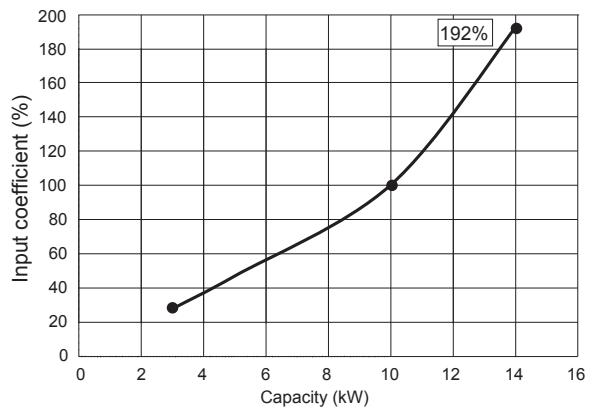
Heating capacity ratio (maximum capacity)



Cooling



Heating



Outdoor unit heating capacity correction coefficient during of frosting/defrosting

(RH approximately 85%)

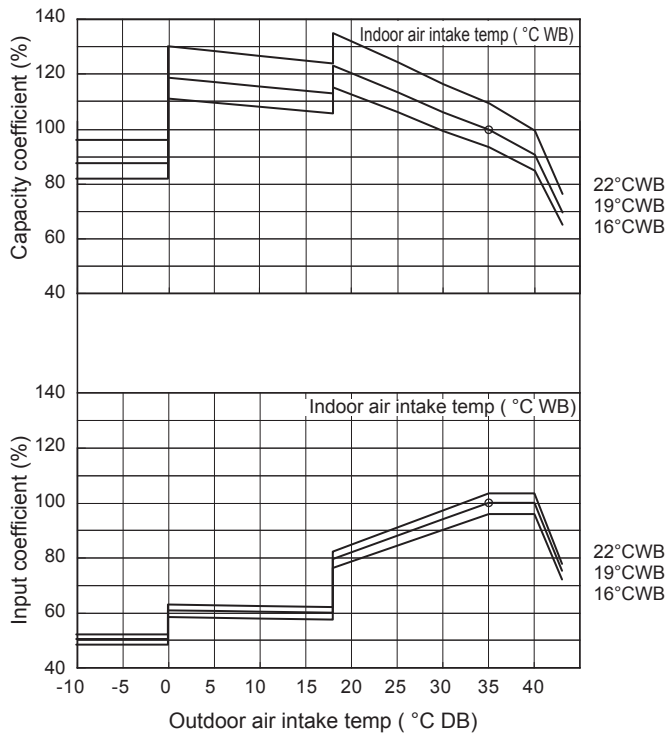
Outdoor intake air temperature °C WB	-15	-14	-13	-12	-11	-10	-9	-8	-7	-6	-5	-4	-3	-2	-1.8	-0.8	0	1	2	3	4	5	6
Correction coefficient	0.88	0.88	0.88	0.88	0.88	0.88	0.88	0.88	0.88	0.88	0.88	0.88	0.87	0.87	0.87	0.85	0.85	0.83	0.85	0.89	0.91	0.95	1.0

To calculate the heating capacity with consideration for frosting/defrosting operation, multiply the heating capacity found from the capacity graph by the correction coefficient from the table above.

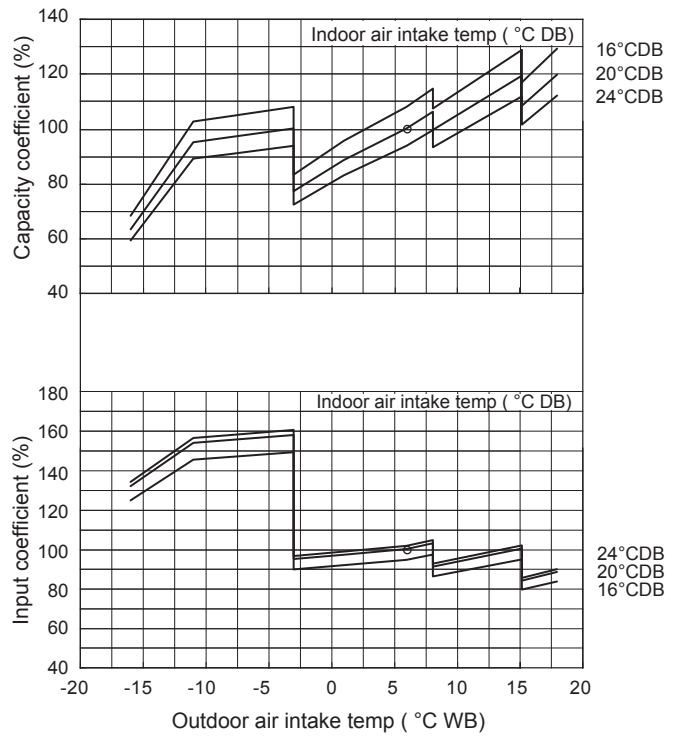
1-5. Capacity Correction Graph According to Temperature Condition

U-125PZ2E5 (For 50 Hz), U-125PZ2E8 (For 50 Hz)

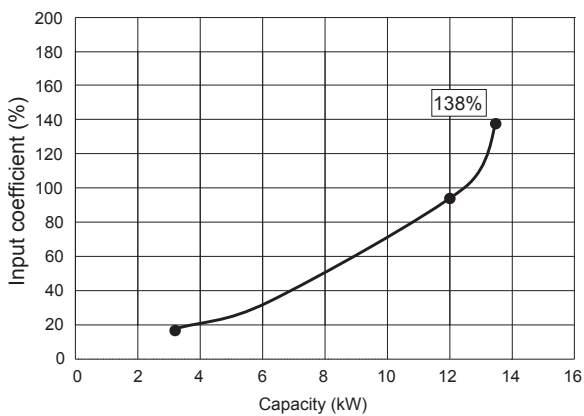
Cooling capacity ratio (maximum capacity)



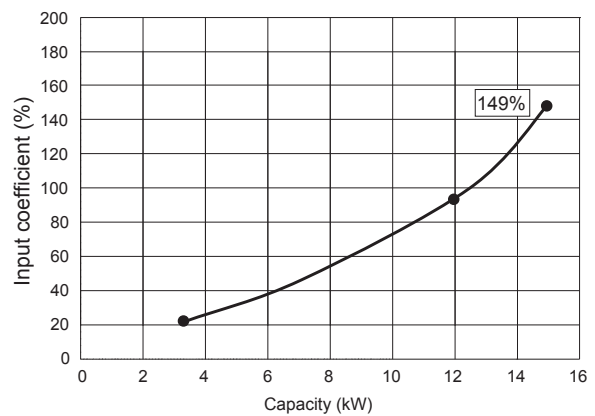
Heating capacity ratio (maximum capacity)



Cooling



Heating



Outdoor unit heating capacity correction coefficient during of frosting/defrosting

(RH approximately 85%)

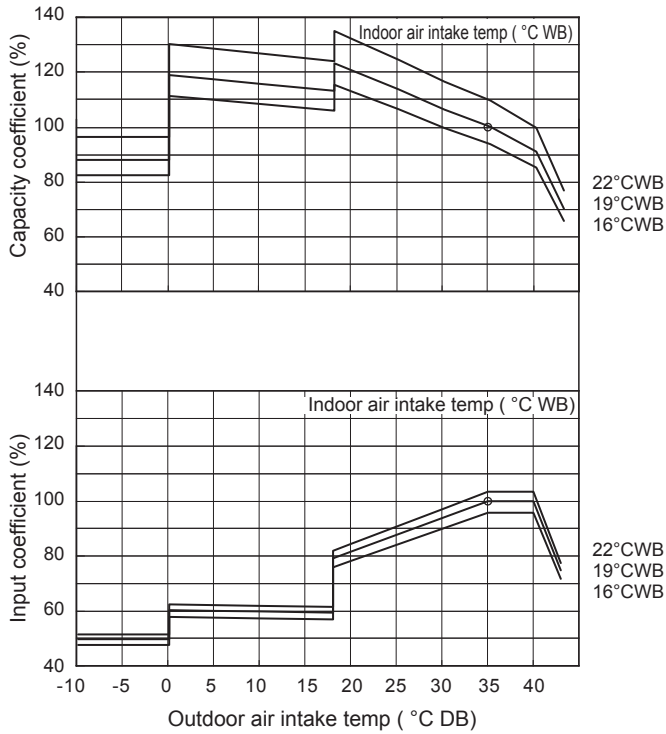
Outdoor intake air temperature °C WB	-15	-14	-13	-12	-11	-10	-9	-8	-7	-6	-5	-4	-3	-2	-1.8	-0.8	0	1	2	3	4	5	6
Correction coefficient	0.88	0.88	0.88	0.88	0.88	0.88	0.88	0.88	0.88	0.88	0.88	0.88	0.87	0.87	0.87	0.85	0.85	0.83	0.85	0.89	0.91	0.95	1.0

To calculate the heating capacity with consideration for frosting/defrosting operation, multiply the heating capacity found from the capacity graph by the correction coefficient from the table above.

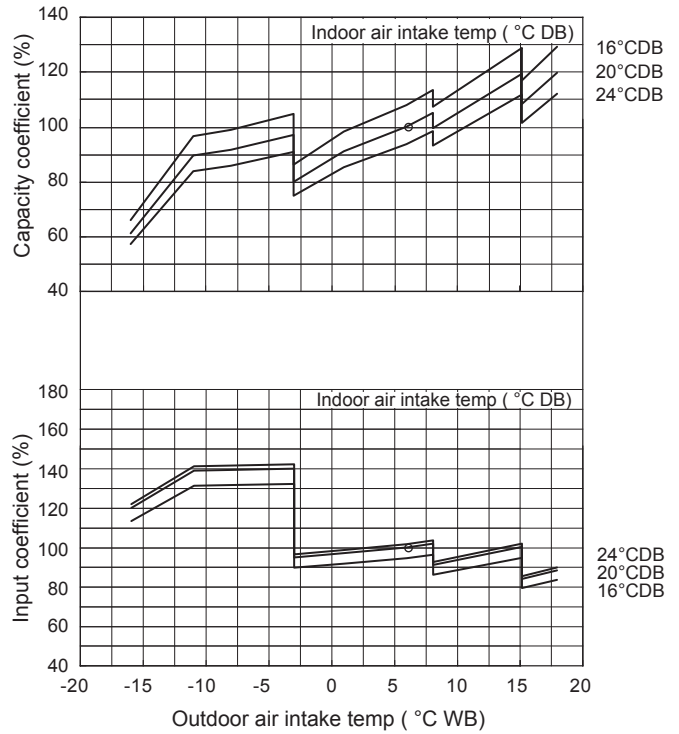
1-5. Capacity Correction Graph According to Temperature Condition

U-140PZ2E5 (For 50 Hz), U-140PZ2E8 (For 50 Hz)

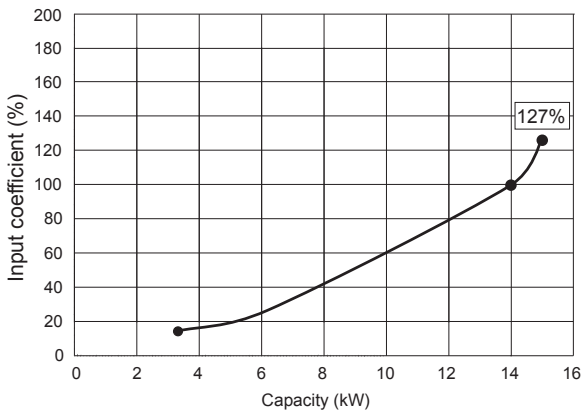
Cooling capacity ratio (maximum capacity)



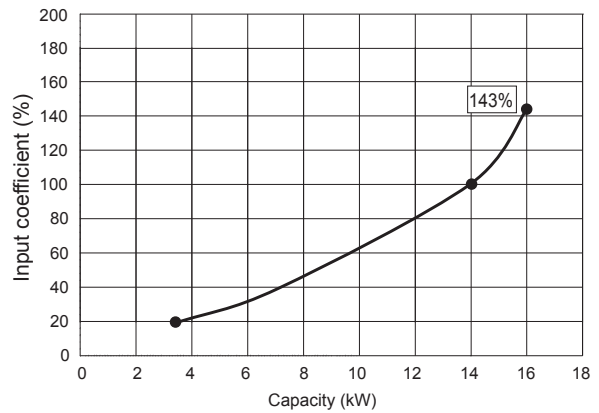
Heating capacity ratio (maximum capacity)



Cooling



Heating



Outdoor unit heating capacity correction coefficient during of frosting/defrosting

(RH approximately 85%)

Outdoor intake air temperature °C WB	-15	-14	-13	-12	-11	-10	-9	-8	-7	-6	-5	-4	-3	-2	-1.8	-0.8	0	1	2	3	4	5	6
Correction coefficient	0.88	0.88	0.88	0.88	0.88	0.88	0.88	0.88	0.88	0.88	0.88	0.88	0.87	0.87	0.87	0.85	0.85	0.83	0.85	0.89	0.91	0.95	1.0

To calculate the heating capacity with consideration for frosting/defrosting operation, multiply the heating capacity found from the capacity graph by the correction coefficient from the table above.



1-6. Noise Criterion Curves

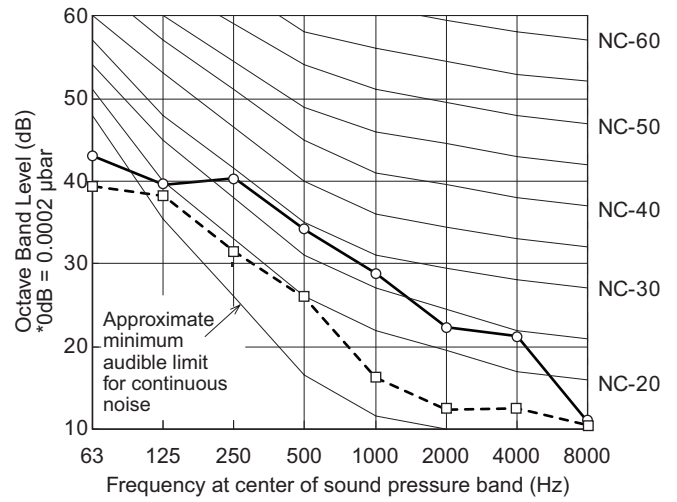
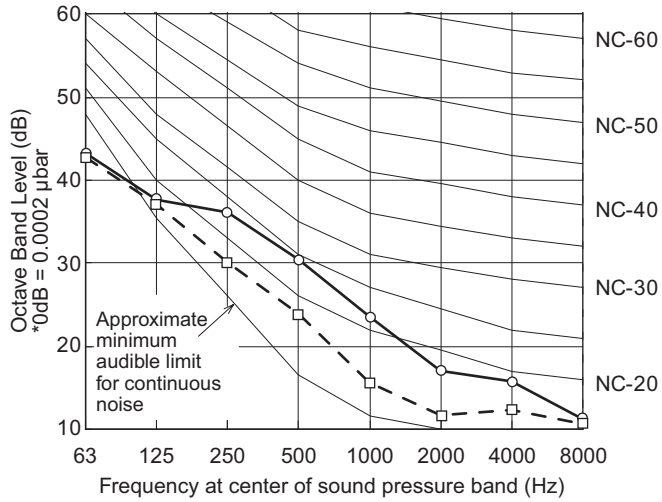
(A) Indoor Units:

4-Way Cassette Type

—○— High  
 - -□- - Low

MODEL	: S-50PU2E5B
SOUND LEVEL	: High 32 dB(A) Low 27 dB(A)
CONDITION	: Under the unit 1.5m
SOURCE	: 230-240V, 1 phase, 50Hz

MODEL	: S-60PU2E5B
SOUND LEVEL	: High 36 dB(A) Low 28 dB(A)
CONDITION	: Under the unit 1.5m
SOURCE	: 230-240V, 1 phase, 50Hz



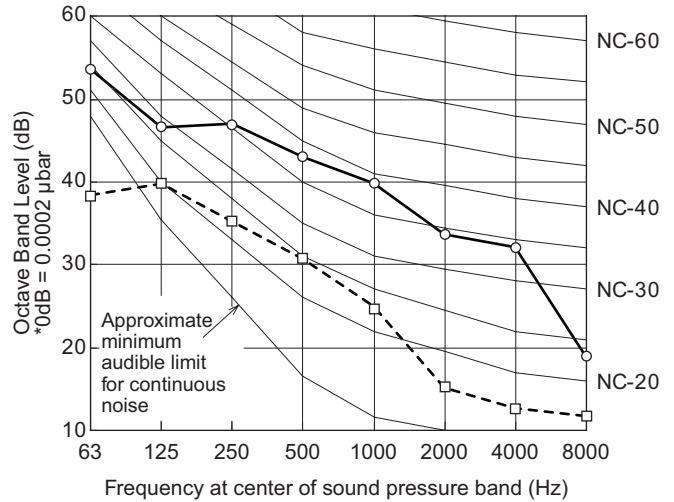
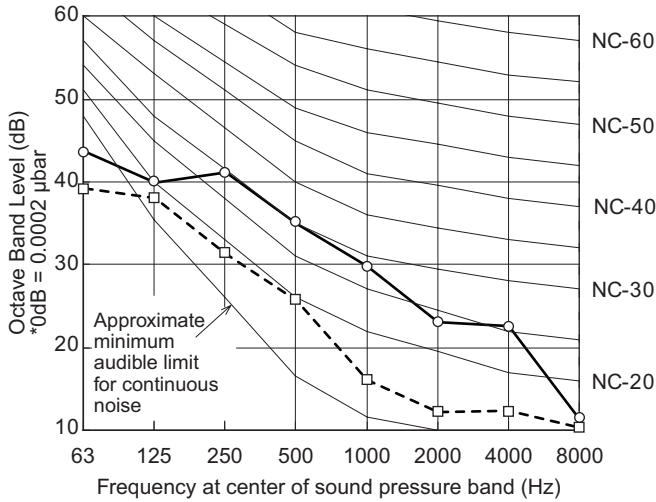
1-6. Noise Criterion Curves

(A) Indoor Units:

4-Way Cassette Type

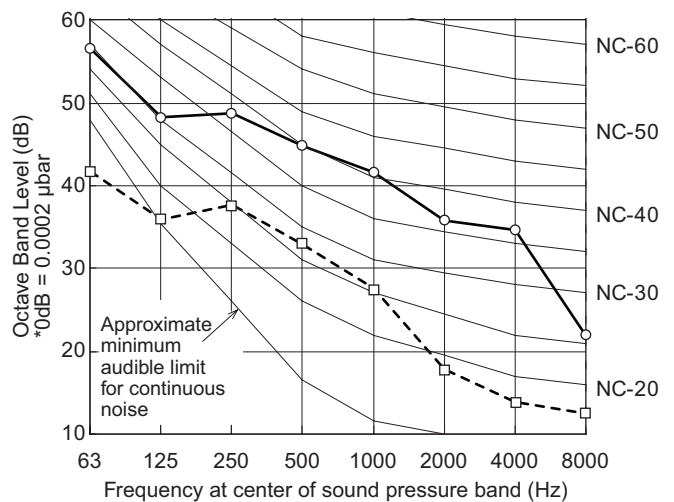
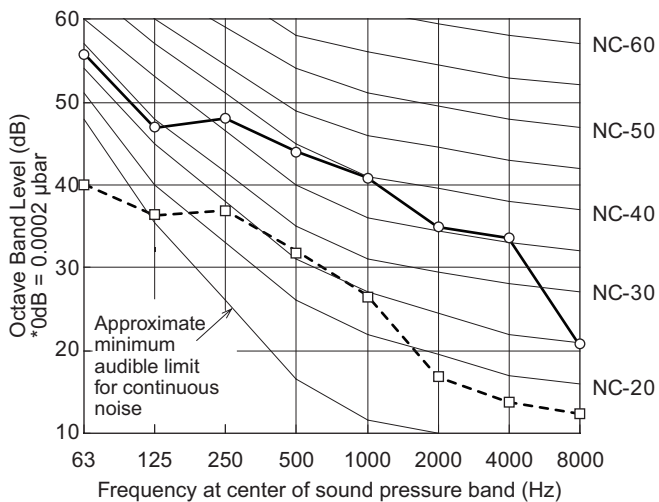
MODEL	: S-71PU2E5B
SOUND LEVEL	High 37 dB(A) Low 28 dB(A)
CONDITION	: Under the unit 1.5m
SOURCE	: 230-240V, 1 phase, 50Hz

MODEL	: S-100PU2E5B
SOUND LEVEL	High 45 dB(A) Low 32 dB(A)
CONDITION	: Under the unit 1.5m
SOURCE	: 230-240V, 1 phase, 50Hz



MODEL	: S-125PU2E5B
SOUND LEVEL	High 46 dB(A) Low 33 dB(A)
CONDITION	: Under the unit 1.5m
SOURCE	: 230-240V, 1 phase, 50Hz

MODEL	: S-140PU2E5B
SOUND LEVEL	High 47 dB(A) Low 34 dB(A)
CONDITION	: Under the unit 1.5m
SOURCE	: 230-240V, 1 phase, 50Hz



REMARKS:

- Value obtained in the actual place where the unit is installed may be slightly higher than the values shown in this graph because of the conditions of operation, the structure of the building, the background noise and other factors.
- The test results were obtained from an anechoic room.

NOTE

To evaluate "Noise level" the maximum number of the measured OCTAVE BAND SOUND PRESSURE LEVEL is used. Read the number on each BAND CENTER FREQUENCIES (horizontal axis) ranging from 63 Hz to 8000 Hz and select the maximum value (vertical axis) among them.

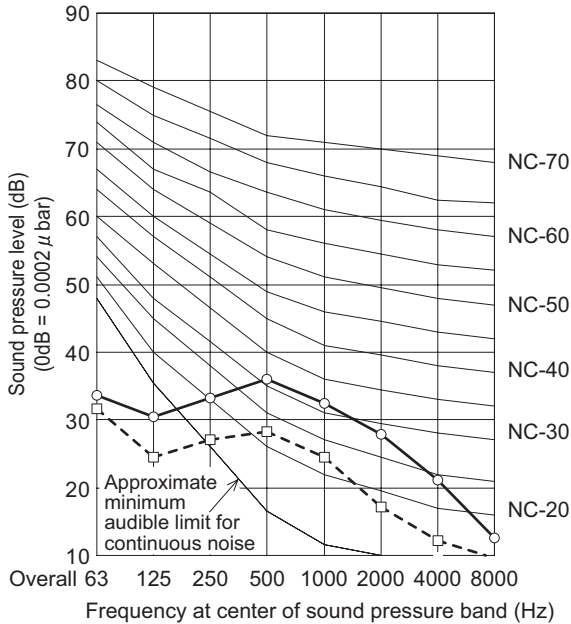
1-6. Noise Criterion Curves

(A) Indoor Units:

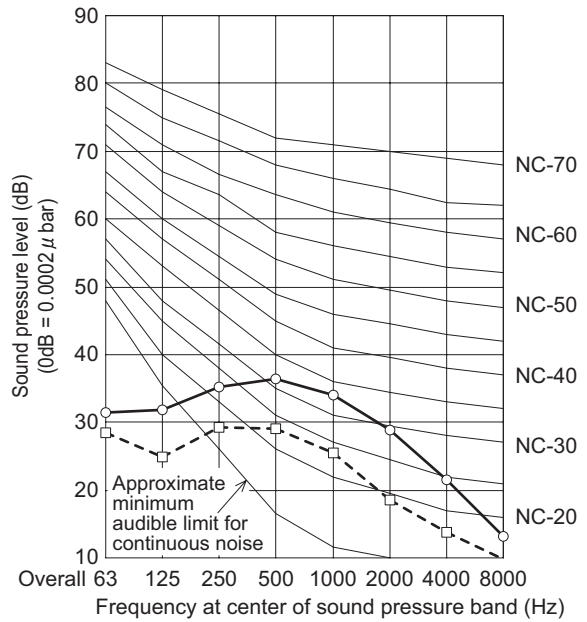
Ceiling Type

—○— High  
-□- Low

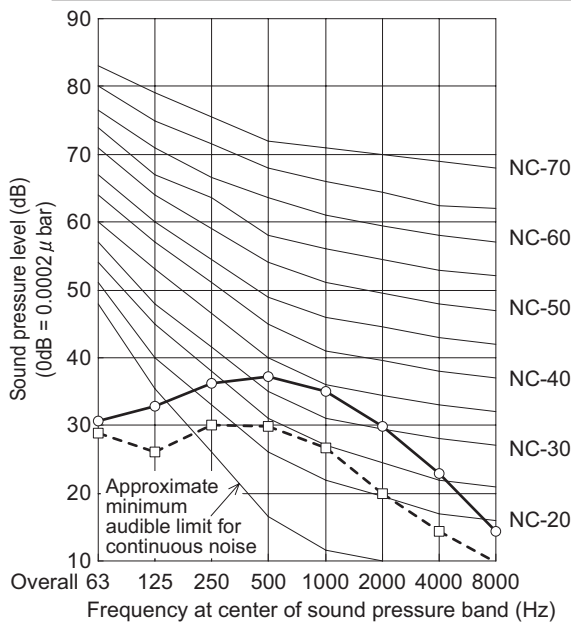
MODEL	: S-50PT2E5B
SOUND LEVEL	: High 37 dB(A) Low 29 dB(A)
CONDITION	: 1 m from front of outlet at height of 1 m
SOURCE	: 220-230-240V, 1 phase, 50Hz



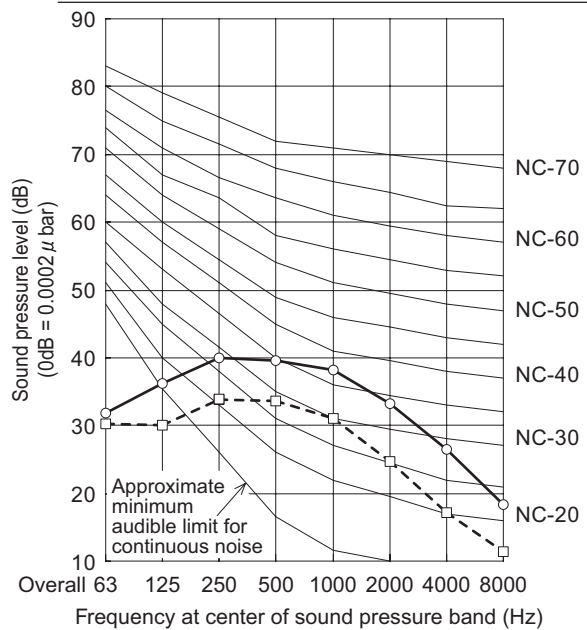
MODEL	: S-60PT2E5B
SOUND LEVEL	: High 38 dB(A) Low 30 dB(A)
CONDITION	: 1 m from front of outlet at height of 1 m
SOURCE	: 220-230-240V, 1 phase, 50Hz



MODEL	: S-71PT2E5B
SOUND LEVEL	: High 39 dB(A) Low 31 dB(A)
CONDITION	: 1 m from front of outlet at height of 1 m
SOURCE	: 220-230-240V, 1 phase, 50Hz



MODEL	: S-100PT2E5B
SOUND LEVEL	: High 42 dB(A) Low 35 dB(A)
CONDITION	: 1 m from front of outlet at height of 1 m
SOURCE	: 220-230-240V, 1 phase, 50Hz



1-6. Noise Criterion Curves

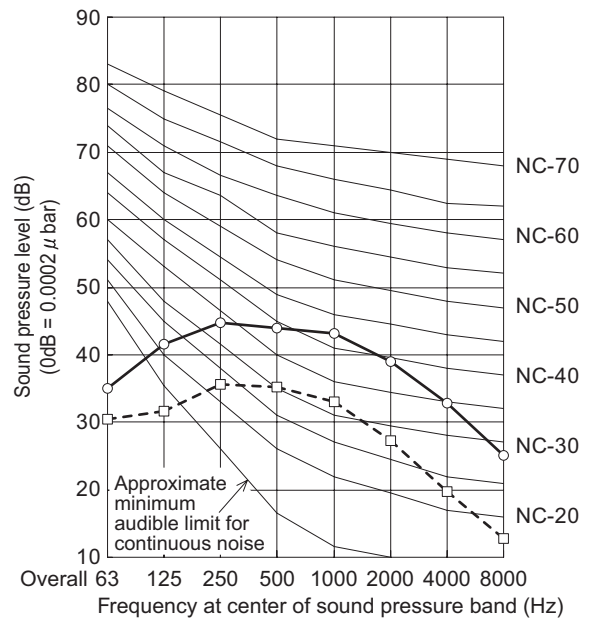
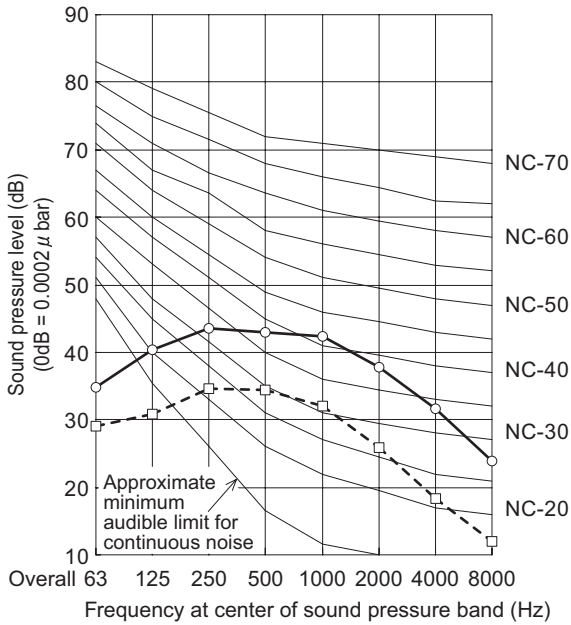
(A) Indoor Units:

Ceiling Type

—○— High  
 -□- Low

MODEL	: S-125PT2E5B
SOUND LEVEL : High	46 dB(A)
Low	36 dB(A)
CONDITION	: 1 m from front of outlet at height of 1 m
SOURCE	: 220-230-240V, 1 phase, 50Hz

MODEL	: S-140PT2E5B
SOUND LEVEL : High	47 dB(A)
Low	37 dB(A)
CONDITION	: 1 m from front of outlet at height of 1 m
SOURCE	: 220-230-240V, 1 phase, 50Hz



1-6. Noise Criterion Curves

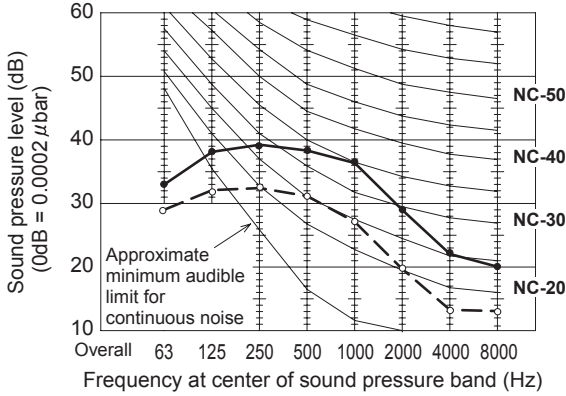
(A) Indoor Units:

Wall Mounted Type

—●— Strong  
 -○- Weak

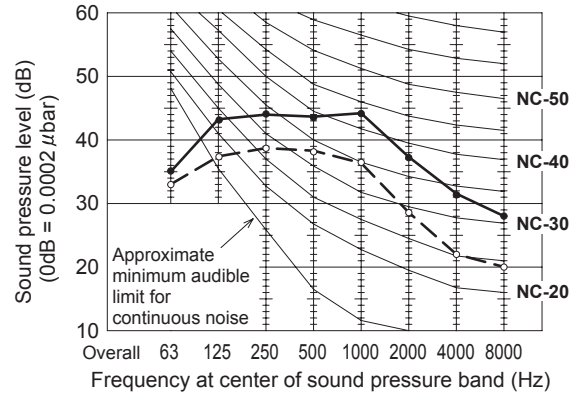
MODEL	: S-50PK2E5B	
SOUND LEVEL	: STRONG	40 dB(A)
	High	36 dB(A)
	Low	32 dB(A)

CONDITION : 1m in front of air discharge and then 1m below



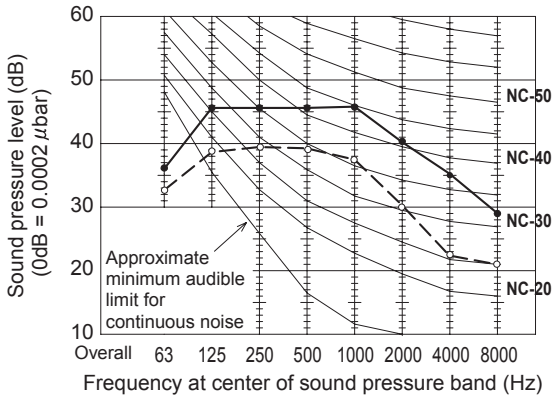
MODEL	: S-60PK2E5B, S-71PK2E5B	
SOUND LEVEL	: STRONG	47 dB(A)
	High	44 dB(A)
	Low	40 dB(A)

CONDITION : 1m in front of air discharge and then 1m below



MODEL	: S-100PK2E5B	
SOUND LEVEL	: STRONG	49 dB(A)
	High	45 dB(A)
	Low	41 dB(A)

CONDITION : 1m in front of air discharge and then 1m below



1-6. Noise Criterion Curves

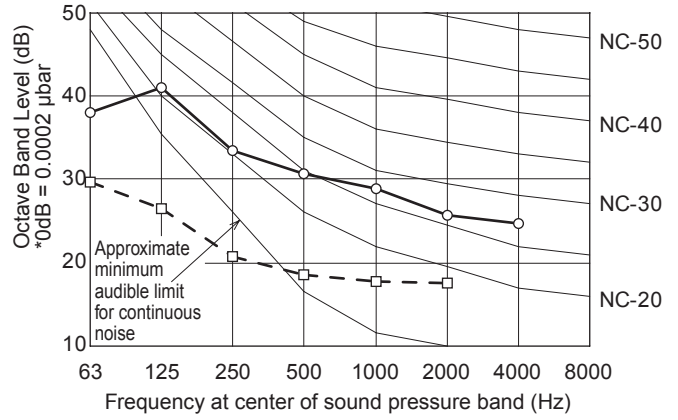
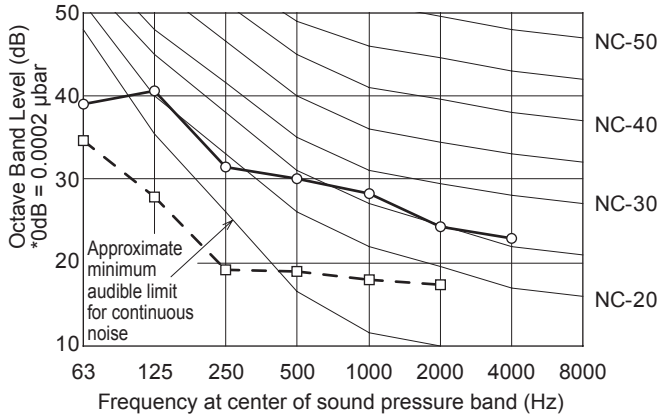
(A) Indoor Units

Low Silhouette Ducted Type

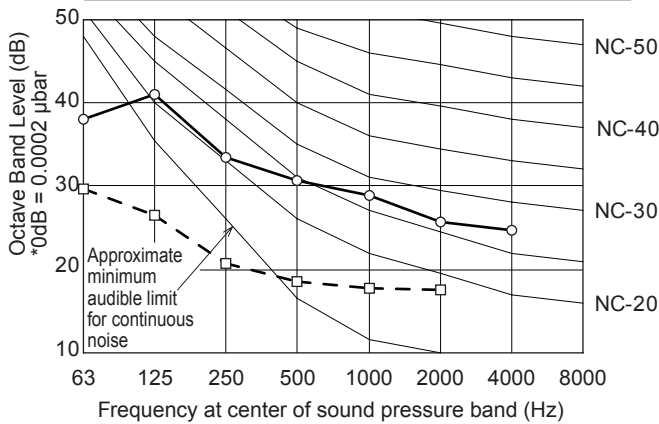
—○— High  
 - -□- - Low

MODEL	: S-50PF1E5B
SOUND LEVEL : High	34 dB(A)
Low	26 dB(A)
CONDITION	: Under the unit 1.5m
SOURCE	: 220-230-240V, 1 phase, 50Hz

MODEL	: S-60PF1E5B
SOUND LEVEL : High	35 dB(A)
Low	26 dB(A)
CONDITION	: Under the unit 1.5m
SOURCE	: 220-230-240V, 1 phase, 50Hz



MODEL	: S-71PF1E5B
SOUND LEVEL : High	35 dB(A)
Low	26 dB(A)
CONDITION	: Under the unit 1.5m
SOURCE	: 220-230-240V, 1 phase, 50Hz

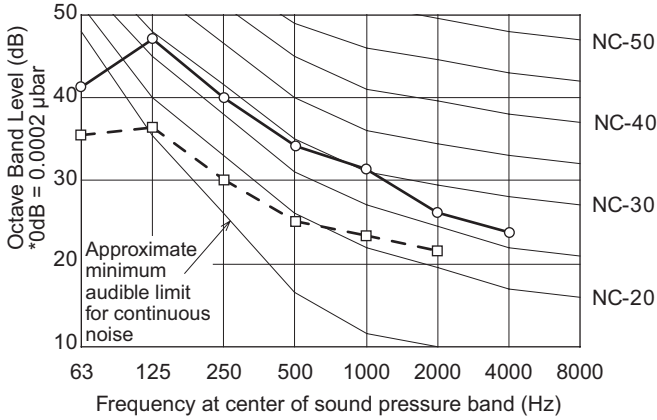


1-6. Noise Criterion Curves

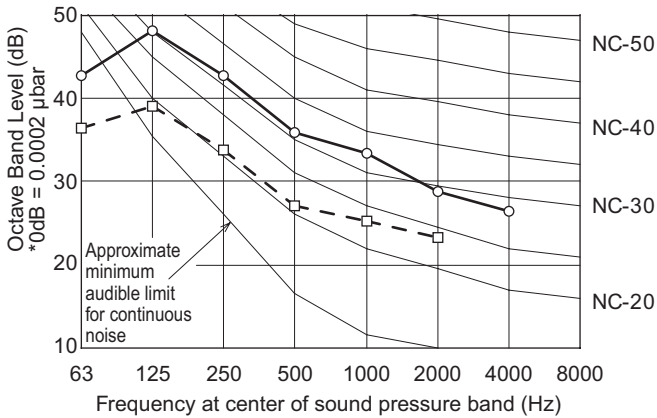
(A) Indoor Units

Low Silhouette Ducted Type

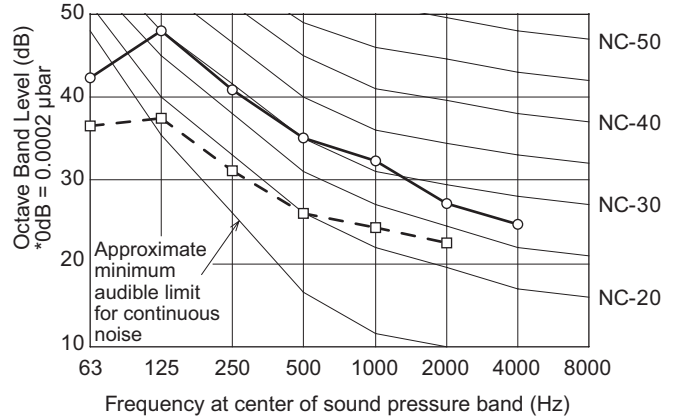
MODEL	: S-100PF1E5B
SOUND LEVEL	: High 38 dB(A) Low 31 dB(A)
CONDITION	: Under the unit 1.5m
SOURCE	: 220-230-240V, 1 phase, 50Hz



MODEL	: S-140PF1E5B
SOUND LEVEL	: High 40 dB(A) Low 33 dB(A)
CONDITION	: Under the unit 1.5m
SOURCE	: 220-230-240V, 1 phase, 50Hz



MODEL	: S-125PF1E5B
SOUND LEVEL	: High 39 dB(A) Low 32 dB(A)
CONDITION	: Under the unit 1.5m
SOURCE	: 220-230-240V, 1 phase, 50Hz

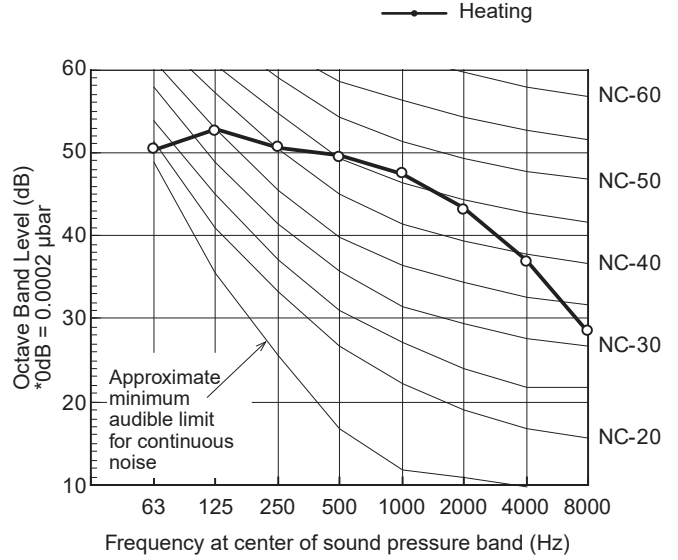
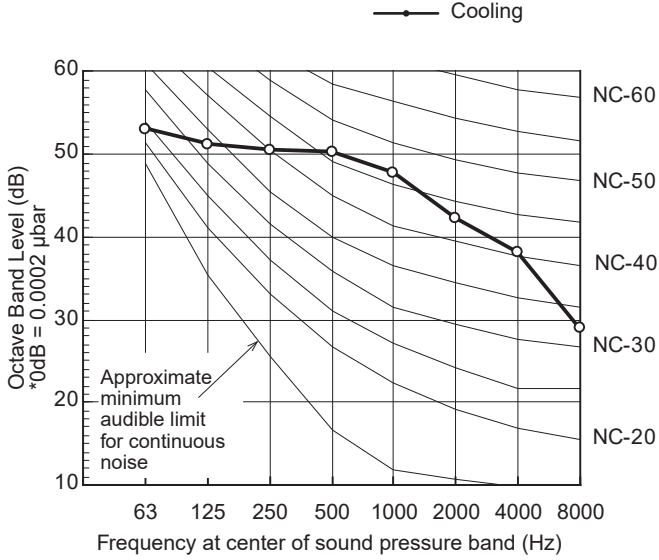


1-6. Noise Criterion Curves

(B) Outdoor Units

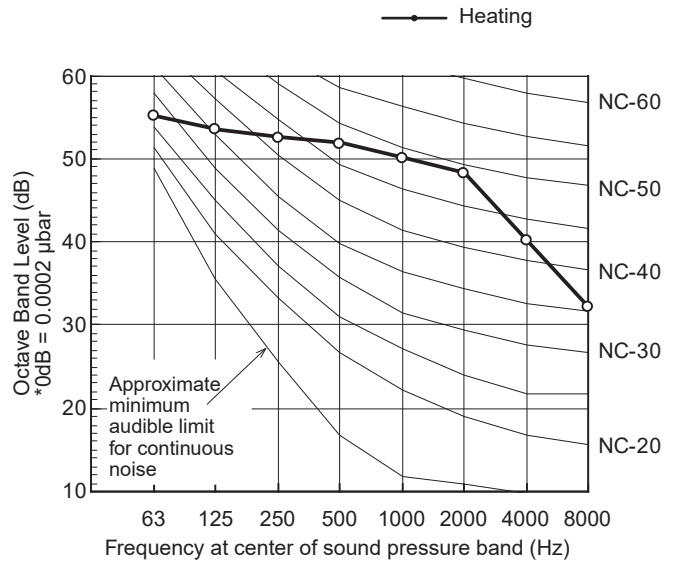
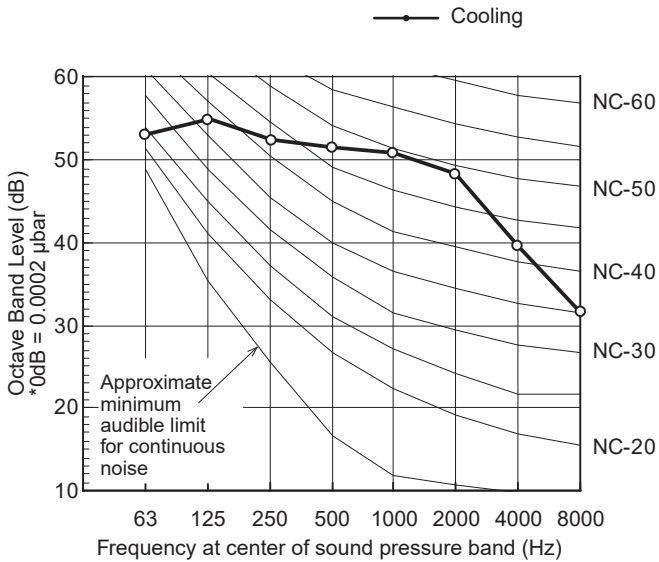
MODEL	: U-100PZ2R5, U-100PZ2R8
SOUND LEVEL	: Cooling 52 dB(A)
CONDITION	: 1 m in front at height of 1.5 m
SOURCE	: 230-240V, 1 phase, 50Hz 400-415V, 3 phase, 50Hz

MODEL	: U-100PZ2R5, U-100PZ2R8
SOUND LEVEL	: Heating 52 dB(A)
CONDITION	: 1 m in front at height of 1.5 m
SOURCE	: 230-240V, 1 phase, 50Hz 400-415V, 3 phase, 50Hz



MODEL	: U-125PZ2R5, U-125PZ2R8
SOUND LEVEL	: Cooling 55 dB(A)
CONDITION	: 1 m in front at height of 1.5 m
SOURCE	: 230-240V, 1 phase, 50Hz 400-415V, 3 phase, 50Hz

MODEL	: U-125PZ2R5, U-125PZ2R8
SOUND LEVEL	: Heating 55 dB(A)
CONDITION	: 1 m in front at height of 1.5 m
SOURCE	: 230-240V, 1 phase, 50Hz 400-415V, 3 phase, 50Hz





1-6. Noise Criterion Curves

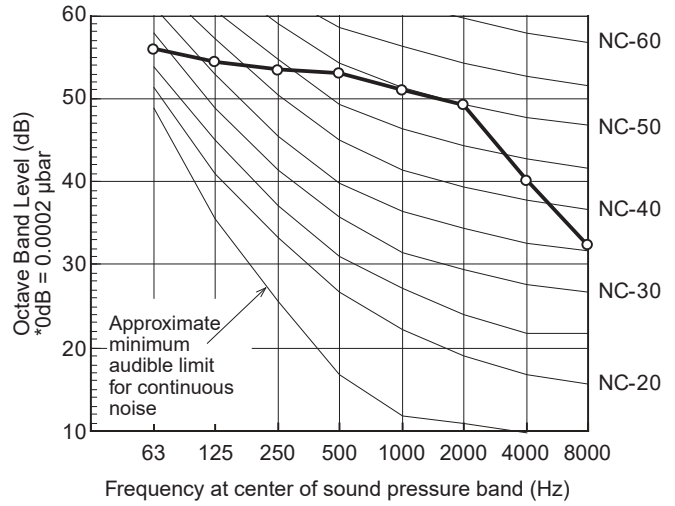
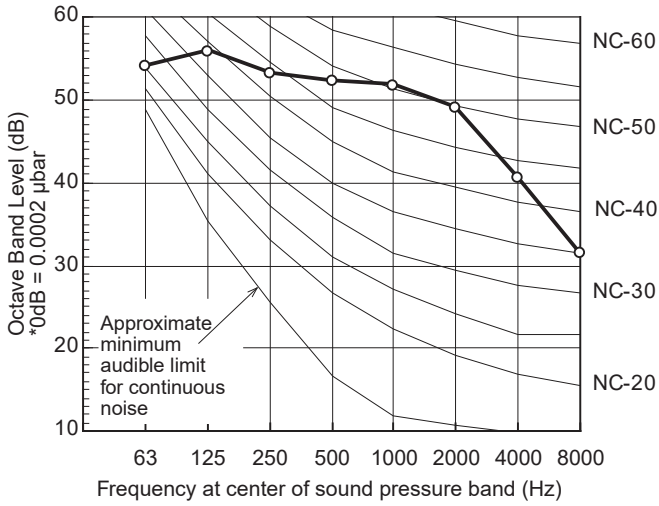
(B) Outdoor Units

MODEL	: U-140PZ2R5, U-140PZ2R8
SOUND LEVEL	: Cooling 56 dB(A)
CONDITION	: 1 m in front at height of 1.5 m
SOURCE	: 230-240V, 1 phase, 50Hz 400-415V, 3 phase, 50Hz

MODEL	: U-140PZ2R5, U-140PZ2R8
SOUND LEVEL	: Heating 56 dB(A)
CONDITION	: 1 m in front at height of 1.5 m
SOURCE	: 230-240V, 1 phase, 50Hz 400-415V, 3 phase, 50Hz

—●— Cooling

—●— Heating

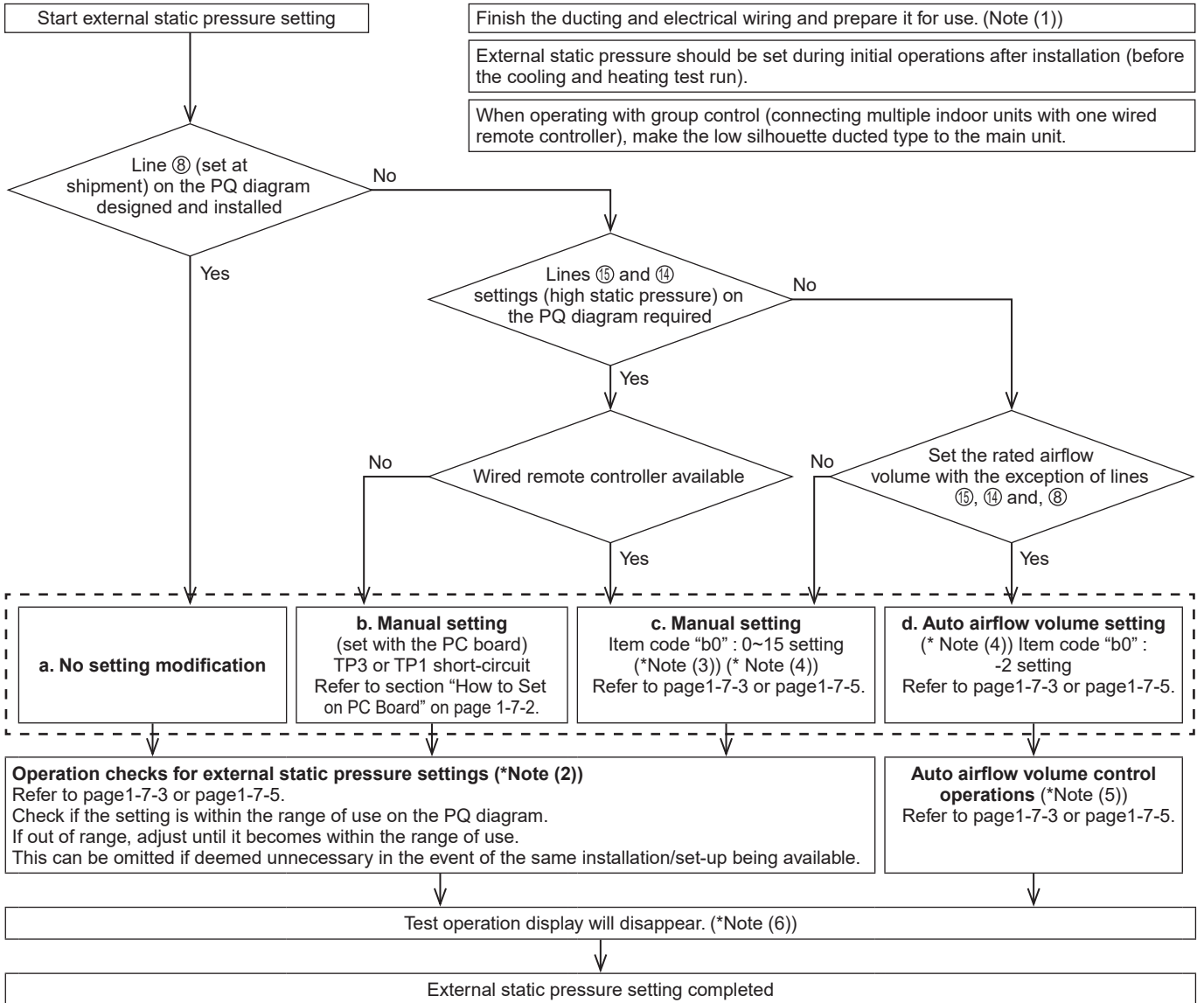


**1-7. Indoor Fan Performance (Type F1)**  
**EXTERNAL STATIC PRESSURE SETTING**

For low silhouette ducted type indoor units, the ventilating resistance so-called "external static pressure" becomes greatly different depending on the connected duct length, shape, number of air outlet ports and types of filters. When installing this unit, be sure to carry out the external static pressure setting in order to operate in the rated airflow volume. Choose one of the following methods from "a", "b", "c" or "d" as shown in the flow chart (within the dotted lines) and then make the setting accordingly.

- a. No setting modification..... : Use-as-is at shipment (there are cases in which the setting may differ from the shipment setting when reset after once setting the external static pressure.)
- b. Manual setting (set with the PC board)..... : For high static pressure. Switching method with the short-circuit connector.
- c. Manual setting (set with the wired remote controller) ..... : Low static pressure ~ high static pressure
- d. Auto airflow volume setting (set on the wired remote controller) .... : Air outlet volume is automatically adjusted to the rated airflow volume with the auto airflow control drive.

**Flow of External Static Pressure**



**NOTE**

- (1) Check the following items before performing the setting-check operations or auto airflow volume operations.
  - 1) Check to make sure that the electrical wiring and ducting have been completed. Activate the stand-by mode. In particular, make sure that the closed damper located in the middle of the duct is open, if installed. Also, make sure that air filters have been installed inside the air inlet duct.  
Check to make sure air is not leaking from the joints.
  - 2) If multiple air outlets and air inlets are included, adjust the airflow volume ratio of all of them until they meet the design airflow ratio.
  - 3) Make sure the address setting has been completed.
- (2) The operation check will be completed in approximately three minutes if the settings have been made correctly. The settings will be modified if they are out of the range of use (maximum 30 minutes.). If this is not completed within 31 minutes, check whether the air speed is set to "H" or not.

- (3) Refer to Table 1-7-2 and Fig. 1-7-2 for details on the relationship between the value of item code “b0” and the external static pressure.
- (4) When set in group control (connecting multiple indoor units with one wired remote controller), set each indoor unit to item code “b0”. When amending the setting after selecting [ b. Manual setting] (due to airflow path changes, etc.), it is necessary to cancel [b. Manual setting] (disconnect short-circuit connector). When [b. Manual setting] has not been cancelled, [c. Manual setting] and [d. Auto airflow volume setting] will be activated if selected, but [b Manual setting] takes precedence when the power is switched back on after power outages, etc.
- (5) If this is not completed within 8 minutes, check the drive mode, air speed and air inlet temperature.
- (6) When set in group control (connecting multiple indoor units with one wired remote controller), the test run operations display will disappear once the external static pressure setting check or auto airflow volume control operation check have been completed for the main unit. Decisions on sub-unit complete are not possible. The test run operation display will disappear after one hour even if the external static pressure setting check or auto airflow volume control operation check have not been completed.



**CAUTION**

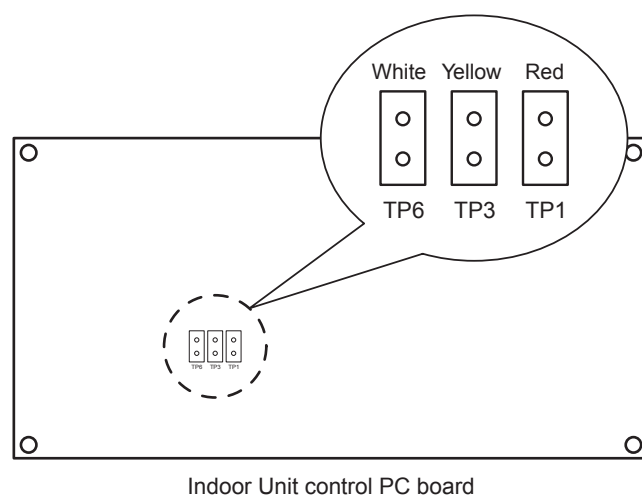
- Be sure to check that the external static pressure is within the range for use and then make the setting. Failure to observe this may result in insufficient airflow or water leakages. Refer to Fig. 1-7-2 for the external static pressure setting range.
- There are cases in which automatic variable dampers and other mounted items may trigger the P12 alarm on systems that modify the external static pressure when the auto airflow volume control operations or setting check operations are carried out if high external static pressure is lowered. In this event, lower the dampers, etc., so that the external static pressure reaches its lowest level, and then carry out the auto airflow volume control operations or setting check operations.
- Be sure to set the [External Static Pressure Setting] once again after amending the airflow path for the duct or air outlet after setting the external static pressure.
- Set the air inlet temperature within the range for use. The auto airflow volume control will not function if the air inlet temperature is over 45°C or not in the fan mode.

**How to Set on PC Board**

1. Turn off the power breaker to halt the supply of electricity to the PC board.
2. Open the lid of electrical component box and check where the short-circuit pin on the indoor unit control PC board is located (Fig. 1-7-1)
3. Short circuit the applicable short-circuit pin in accordance with the selected short-circuit pin connected (Fig. 1-7-2).  
 150 Pa : TP3 (2P: yellow) short-circuit  
 140 Pa : TP1 (2P: red) short-circuit  
 \* Use the short-circuit connector (2P: yellow) supplied.

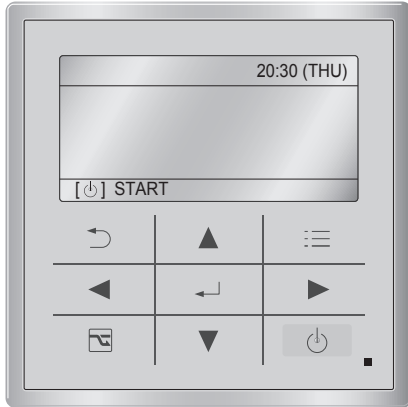
**Table 1-7-1 Selection of connected short-circuit pins**

External static pressure at the time of rated airflow volume	Short-circuit pin
Unusable	TP6 (2P: white)
150 Pa	TP3 (2P: yellow)
140 Pa	TP1 (2P: red)



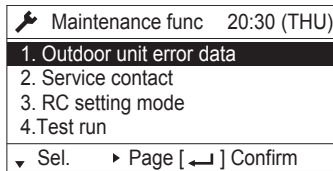
**Fig. 1-7-1**

## Operating the High-spec Wired Remote Controller (CZ-RTC5A, CZ-RTC5B)

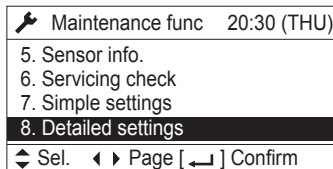


### How to set the external static pressure

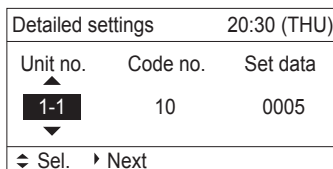
- Keep pressing the , and buttons simultaneously for 4 or more seconds. The "Maintenance func" screen appears on the LCD display.



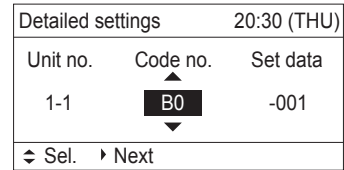
- Press the or button to see each menu. If you wish to see the next screen instantly, press the or button. Select "8. Detailed settings" on the LCD display and press the button.



The "Detailed settings" screen appears on the LCD display. Select the "Unit no." by pressing the or button for changes.



- Select the "Code no." by pressing the or button. Change the "Code no." to "B0" by pressing the or button (or keeping it pressed).



- Select the "Set data" by pressing the or button. Select one of the "Set data" among "0001" – "0015" according to the desired external static pressure setting by pressing the or button. Then press the button. (See the table below.)

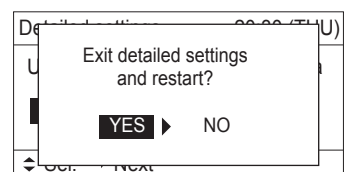
**When setting to auto airflow volume control:**  
Select the setting data to "-002".

Then press the button.

**Table 1-7-2 Setting the external static pressure**

Indoor unit type		Item code
50, 60, 71	100, 125, 140	
External static pressure of the rated airflow volume (Pa)		<b>B0</b>
150	150	<b>0015</b>
140	140	<b>0014</b>
130	130	<b>0013</b>
120	120	<b>0012</b>
100	110	<b>0011</b>
70	100	<b>0008</b>
60	70	<b>0006</b>
50	50	<b>0005</b>
30	30	<b>0003</b>
10	10	<b>0001</b>
No auto airflow volume setting		<b>-001</b>
Auto airflow volume setting		<b>-002</b>

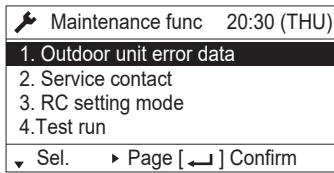
- Select the "Unit no." by pressing the or button and press the button. The "Exit detailed settings and restart?" (Detailed setting-end) screen appears on the LCD display. Select "YES" and press the button. When the setting is completed, perform the test run for the external static pressure setting described in "Auto External Static Pressure Setting Operation".



### Auto External Static Pressure Setting Operation

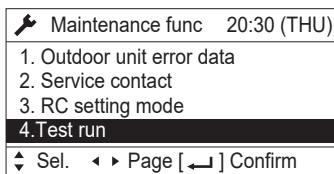
- Keep pressing the , and buttons simultaneously for 4 or more seconds.

The "Maintenance func" screen appears on the LCD display.

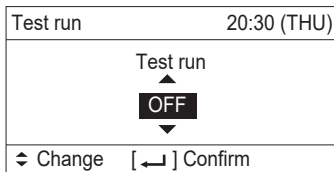


- Press the or button to see each menu. If you wish to see the next screen instantly, press the or button.

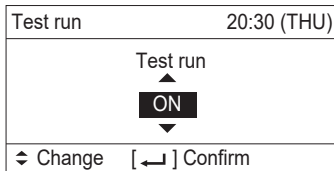
Select "4. Test run" on the LCD display and press the button.



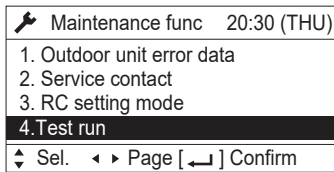
The "Test run" screen appears on the LCD display.



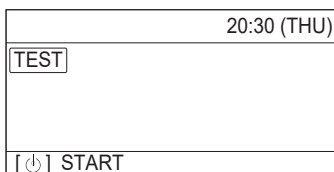
- Change the display from OFF to ON by pressing the or button. Then press the button.



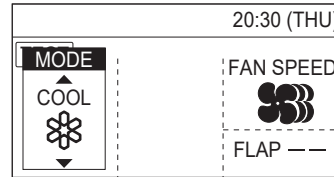
The "Maintenance func" screen appears on the LCD display.



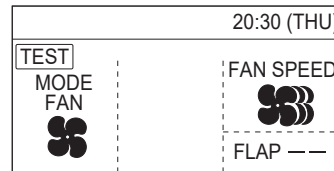
- Press the button. "TEST" will be displayed on the LCD display.



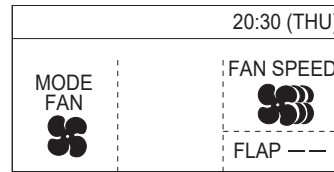
- Press the button. Test run will be started. Test run setting mode screen appears on the LCD display.



- Set the operation mode to " " and fan speed mode to " " by pressing the or button or or button. Then press the button.



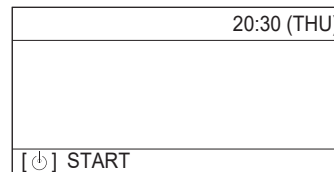
The fan motor will be activated, the auto external static pressure setting operation and setting-check operation will be performed for about 3 to 30 minutes. The fan speed will change automatically while these operations are in progress. When these operations completed, "TEST" will be disappeared from the LCD display.



**NOTE:**

The auto external static pressure setting operation and setting-check operation will not be performed unless " (MODE FAN)" and " (FAN SPEED)" have been selected.

- Press the button. The LCD display will be returned to the initial screen.



**NOTE:**

Failure to set this parameter may result in decreased airflow and condensation.

## Operating the Timer Remote Controller (CZ-RTC4)

### Setting Item Code "60"

- Press and hold down the , and buttons simultaneously for 4 or more seconds.  
(**SETTING**, the Unit No., Item Code and Detailed Data will blink on the LCD display.)
- The indoor unit numbers in the group control will be sequentially displayed whenever the Unit Select button is pressed .  
Only the fan motor for the selected indoor unit will operate during this time.
- Specify the "60" item code by pressing the / buttons for the temperature setting buttons and confirm the values.  
(**"-001"** set at shipment )
- Press the / buttons for the time to amend the values for the set data.  
Refer to Table 1-7-3 and Fig. 1-7-2 and select a value between **"0001"** and **"0015"**.  
Select **"-002"** if the auto airflow volume setting is activated.
- Press the button.  
The display will stop blinking and remain illuminated.
- Press the button. The fan motor will stop operating and the LCD display will return to the normal stop mode.

### Auto Airflow Volume Control Operations and External Static Pressure Setting-Check Operation

- Press and hold down the button for 4 or more seconds.  
"TEST" will be displayed on the LCD display.
- Press the button to start the test run.
- Select the operation mode (Fan) by pressing the .  
(Mode select) button.  
Then select the fan speed by pressing the .  
(Fan speed) button.

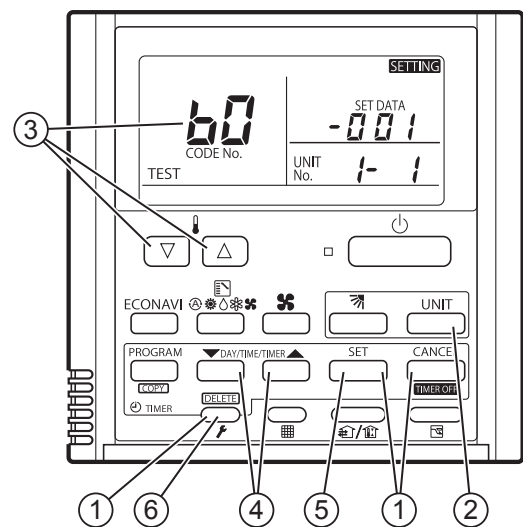
#### NOTE

Auto airflow volume control operations and external static pressure setting-check operations will not be performed unless the above settings are made.

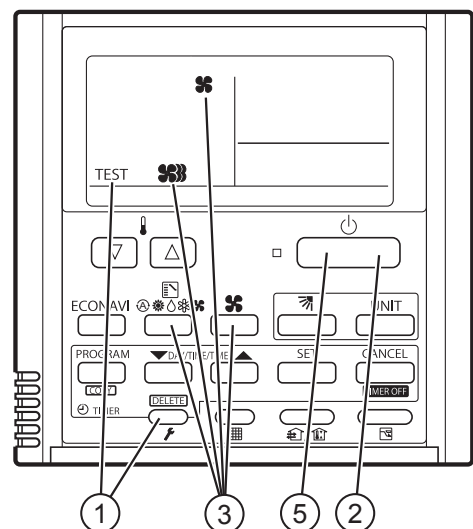
- The fan motor will be activated and auto airflow volume control operations or external static pressure setting-check operations will be started.  
The power of the airflow will change while these operations are in progress.  
The external static pressure setting-check operations and auto airflow volume control operations will be completed in about 3 to 30 minutes.  
"TEST" display will be disappeared from the LCD display.
- Press the button to halt the test run.

Table 1-7-3 Setting the external static pressure

Indoor unit type		Item code
50, 60, 71	100, 125, 140	
External static pressure of the rated airflow volume (Pa)		<b>60</b>
150	150	<b>00 15</b>
140	140	<b>00 14</b>
130	130	<b>00 13</b>
120	120	<b>00 12</b>
100	110	<b>00 11</b>
70	100	<b>00 08</b>
60	70	<b>00 06</b>
50	50	<b>00 05</b>
30	30	<b>00 03</b>
10	10	<b>00 01</b>
No auto airflow volume setting		<b>-001</b>
Auto airflow volume setting		<b>-002</b>



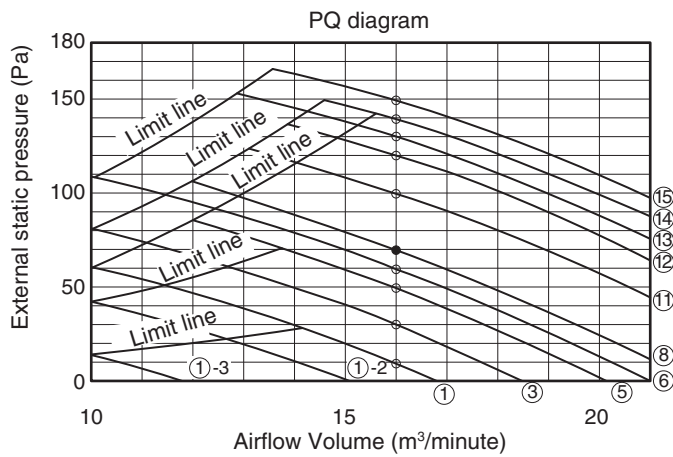
\*Failure to set this parameter may result in decreased airflow and condensation.



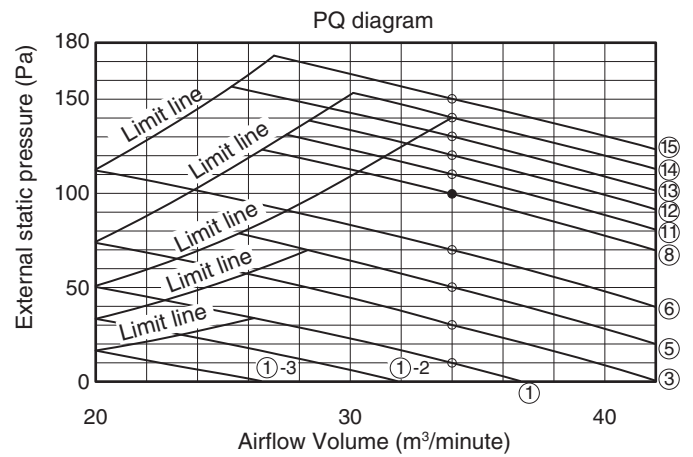
Indoor Fan Performance

		Item code "b0"																			
		0015		0014		0013		0012		0011		0008		0006		0005		0003		0001	
		Cooling	Heating	Cooling	Heating	Cooling	Heating	Cooling	Heating	Cooling	Heating	Cooling	Heating	Cooling	Heating	Cooling	Heating	Cooling	Heating	Cooling	Heating
Tap	⑮	H	H																		
	⑭			H	H																
	⑬	M	M			H	H														
	⑫							H	H												
	⑪			M					H	H											
	⑩		M			M	M	M		H	H										
	⑨	L	L			M			M	M		H	H								
	⑧			L		L	L	L	L	L		M	M	M	M	H	H				
	⑦										M	M	M	M	H	H					
	⑥																				
⑤																					
④																					
③																					
②																					
①																					
①-2																					
①-3																					

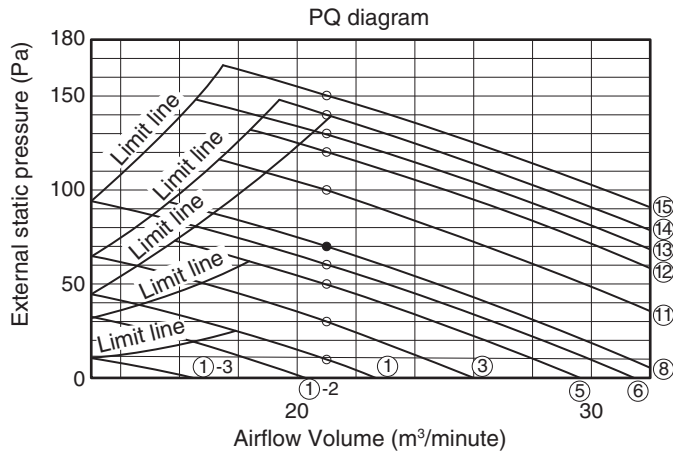
Type 50



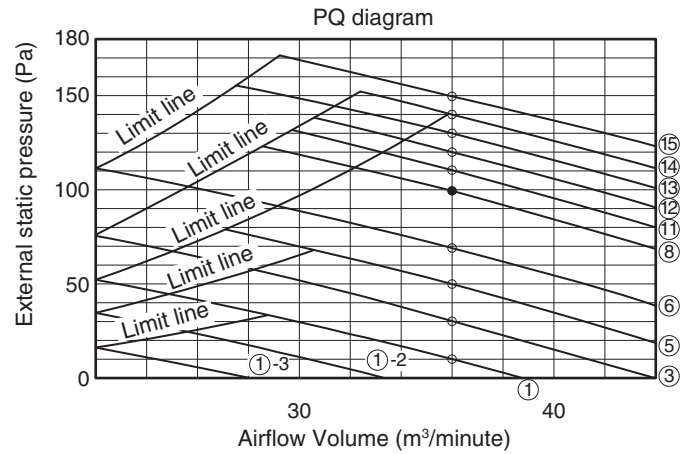
Type 125



Type 60, 71



Type 140



Type 100

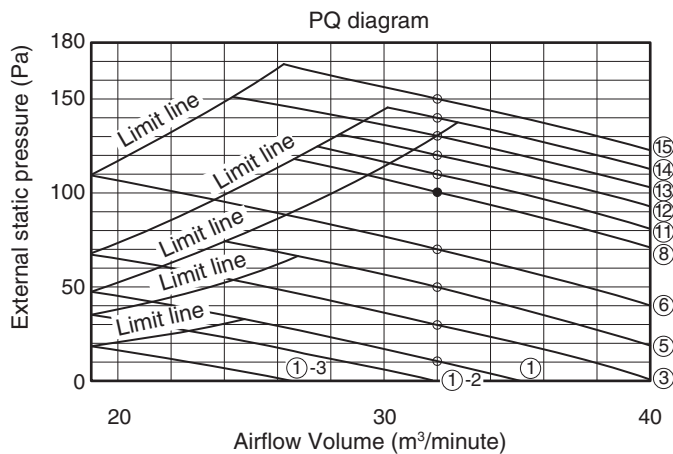


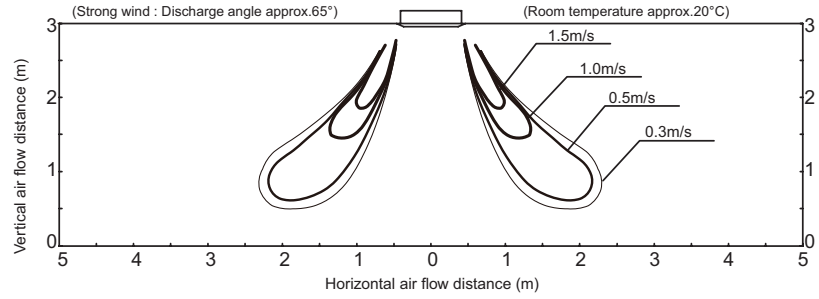
Fig. 1-7-2

1-8. Airflow Distance Chart

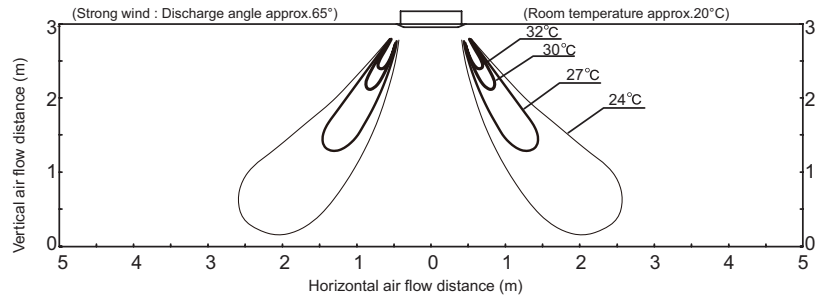
4-Way Cassette (Type U2)

S-50PU2E5B

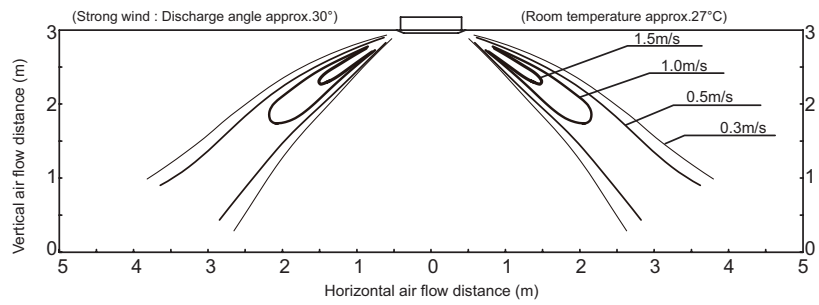
Heating : Distribution of wind velocity



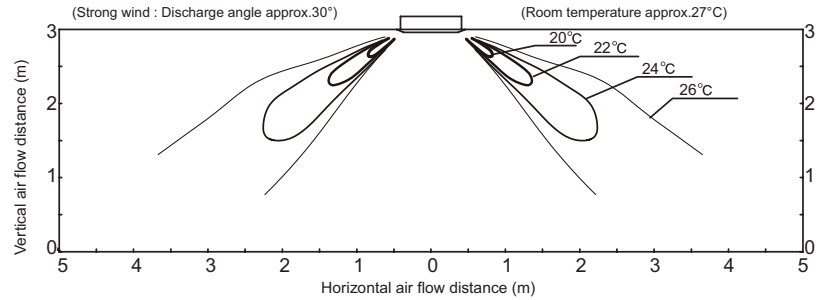
Heating : Distribution of temperature



Cooling : Distribution of wind velocity



Cooling : Distribution of temperature

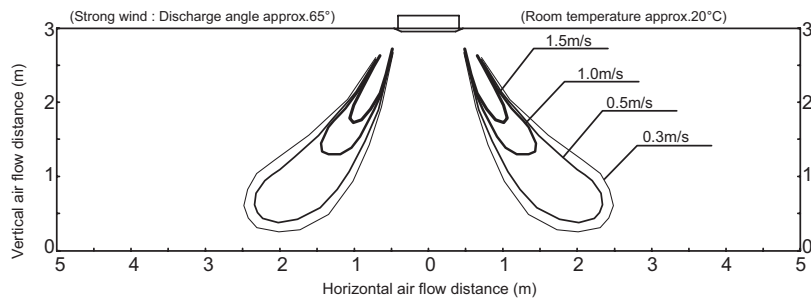




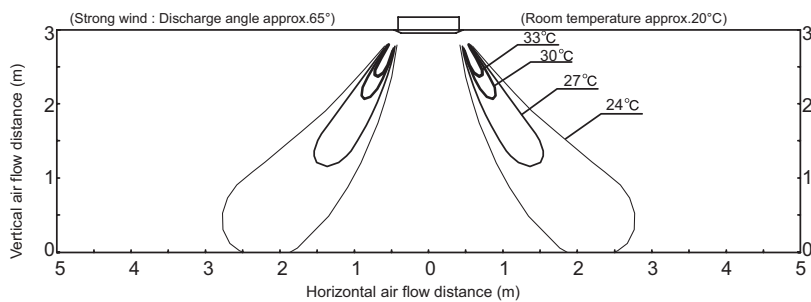
### 4-Way Cassette (Type U2)

#### S-60PU2E5B / 71PU2E5B

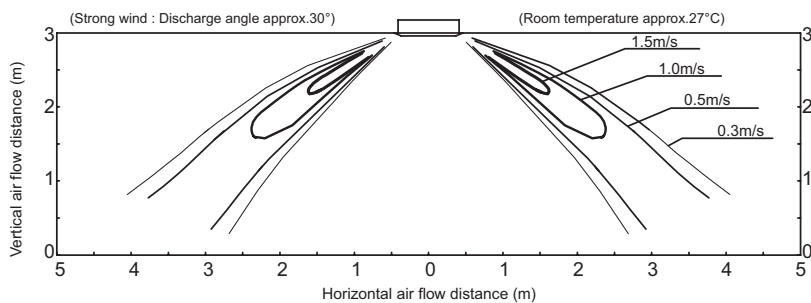
Heating : Distribution of wind velocity



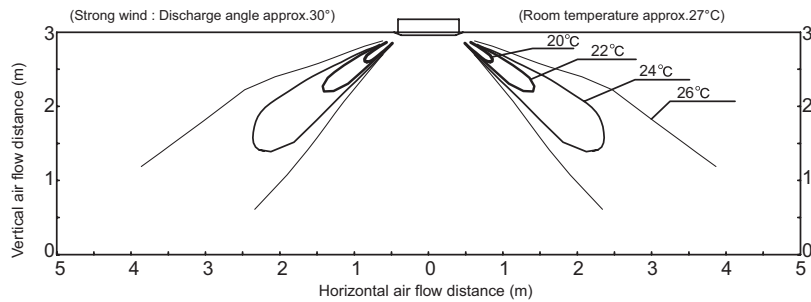
Heating : Distribution of temperature



Cooling : Distribution of wind velocity



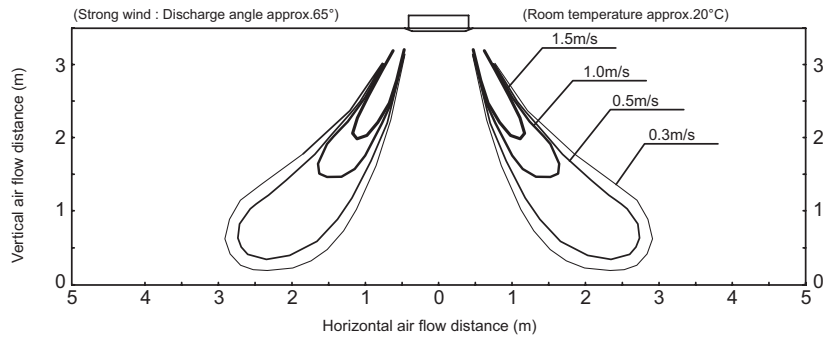
Cooling : Distribution of temperature



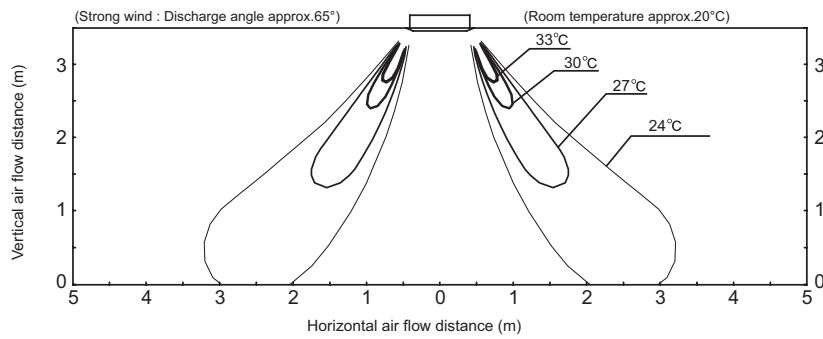
4-Way Cassette (Type U2)

S-100PU2E5B / 125PU2E5B / 140PU2E5B

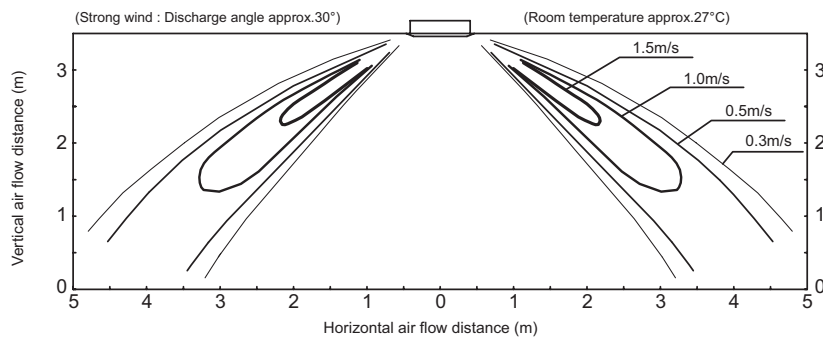
Heating : Distribution of wind velocity



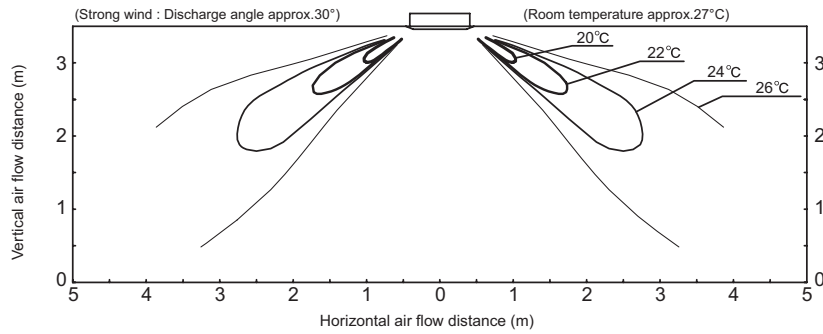
Heating : Distribution of temperature



Cooling : Distribution of wind velocity



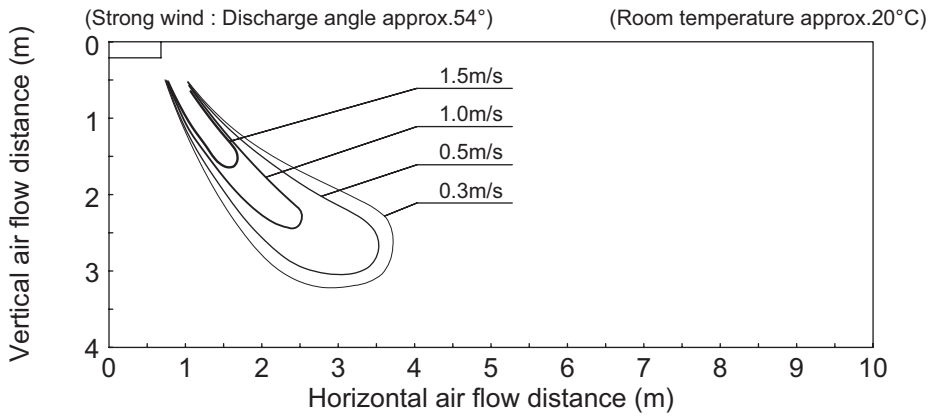
Cooling : Distribution of temperature



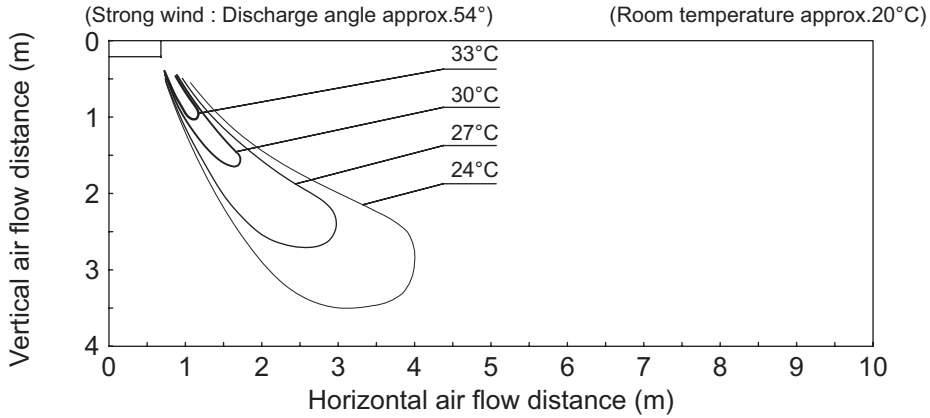
### Ceiling (Type T2)

#### S-50PT2E5B

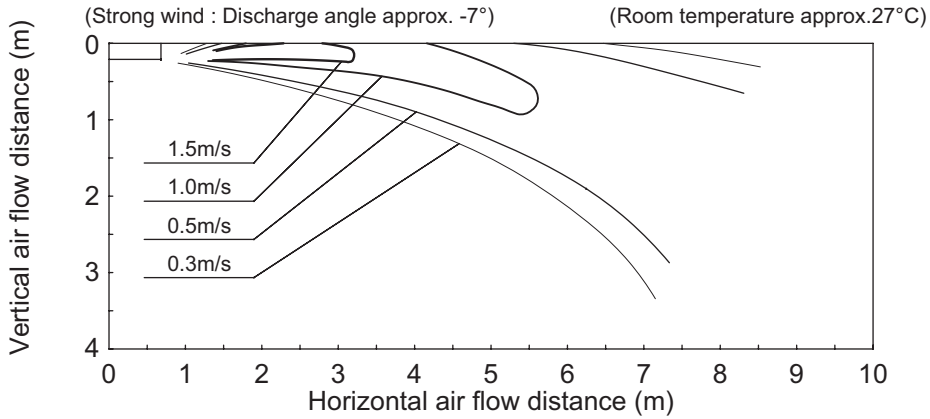
Heating : Distribution of wind velocity



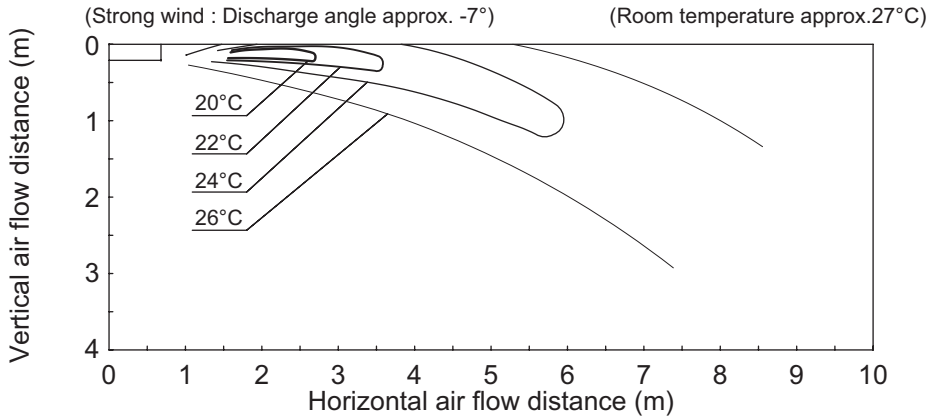
Heating : Distribution of temperature



Cooling : Distribution of wind velocity



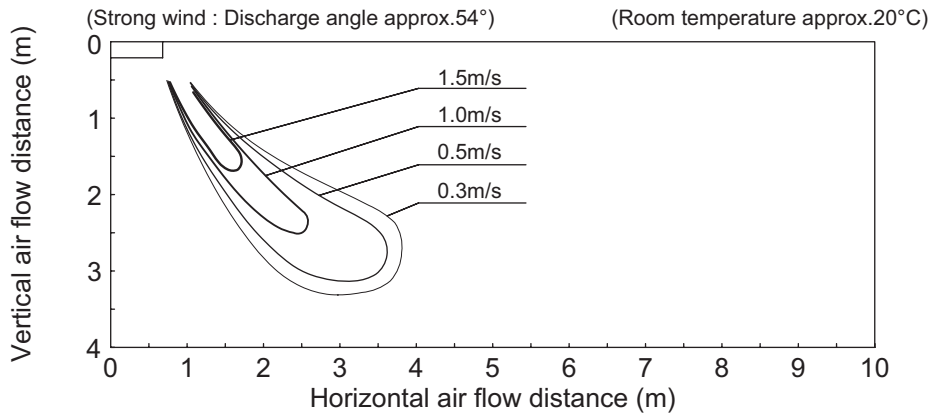
Cooling : Distribution of temperature



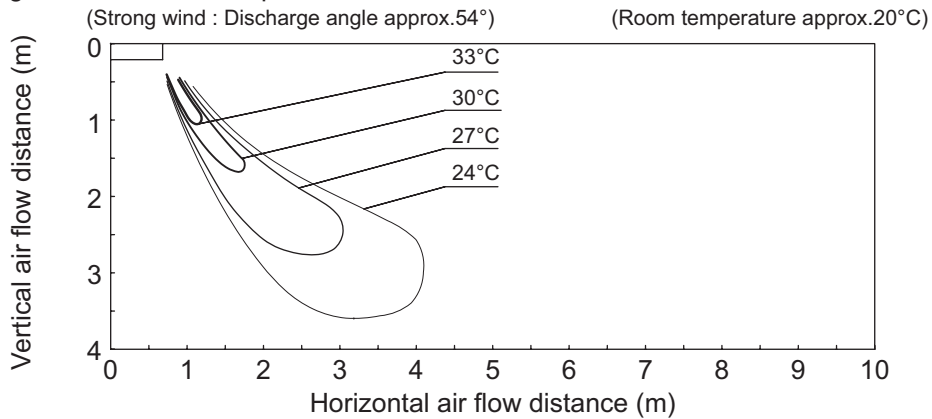
Ceiling (Type T2)

S-60PT2E5B / 71PT2E5B

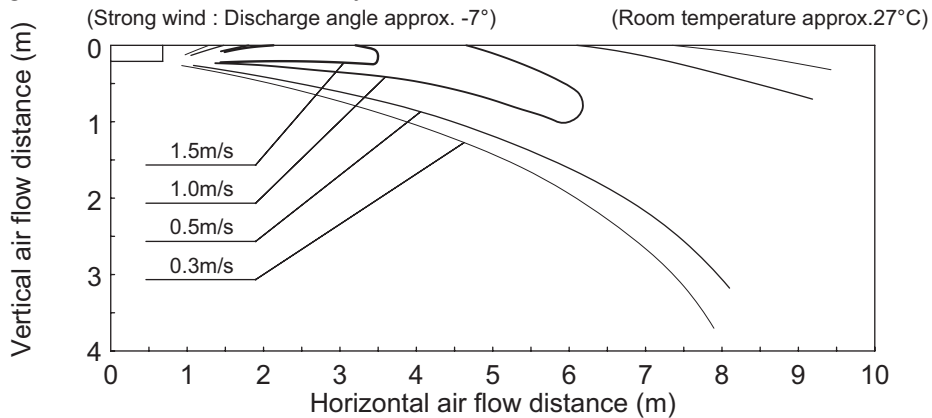
Heating : Distribution of wind velocity



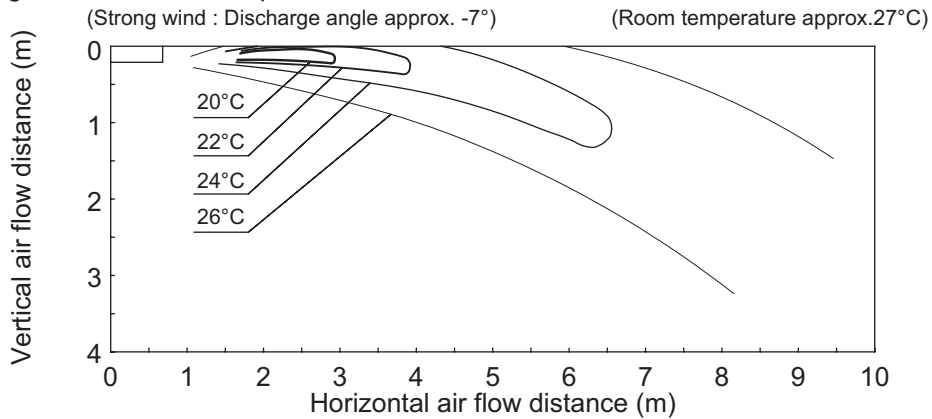
Heating : Distribution of temperature



Cooling : Distribution of wind velocity



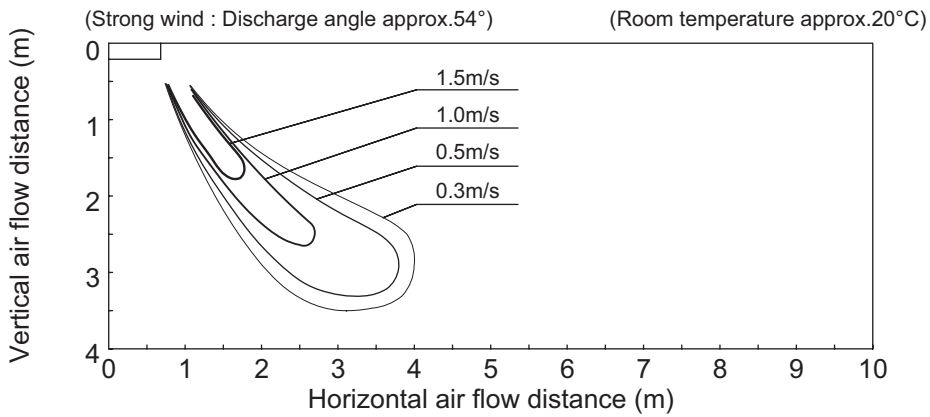
Cooling : Distribution of temperature



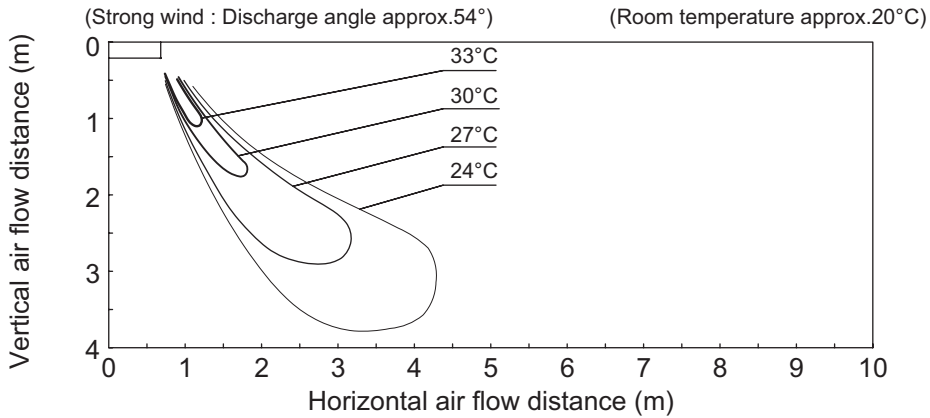
**Ceiling (Type T2)**

**S-100PT2E5B / 125PT2E5B / 140PT2E5B**

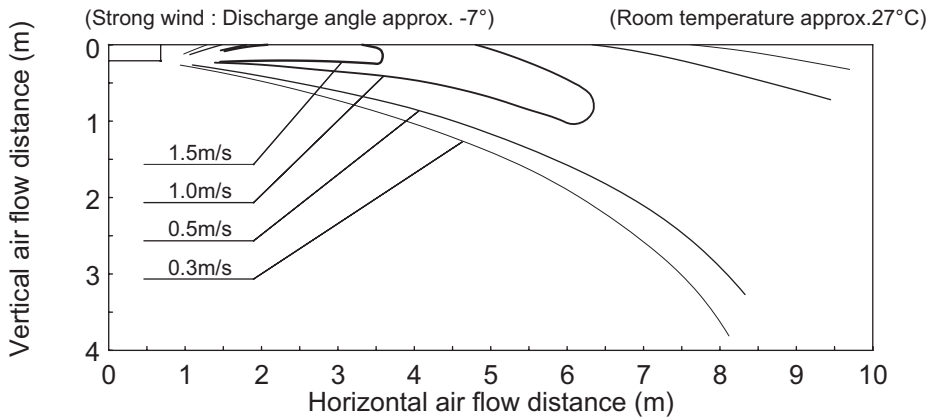
Heating : Distribution of wind velocity



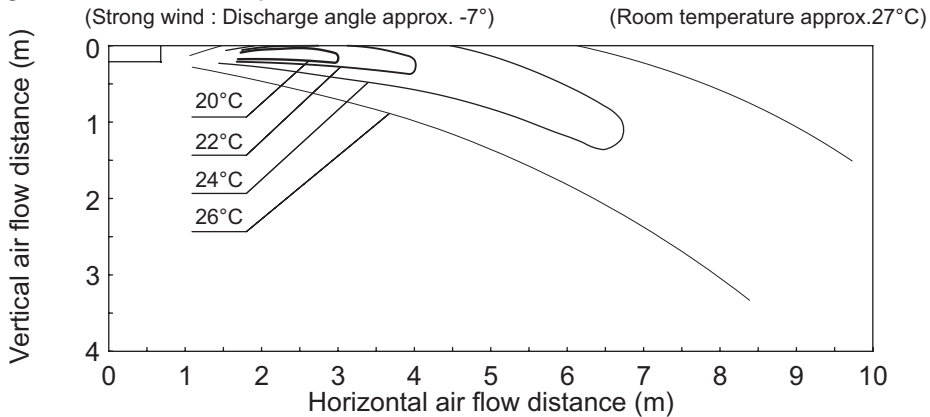
Heating : Distribution of temperature



Cooling : Distribution of wind velocity



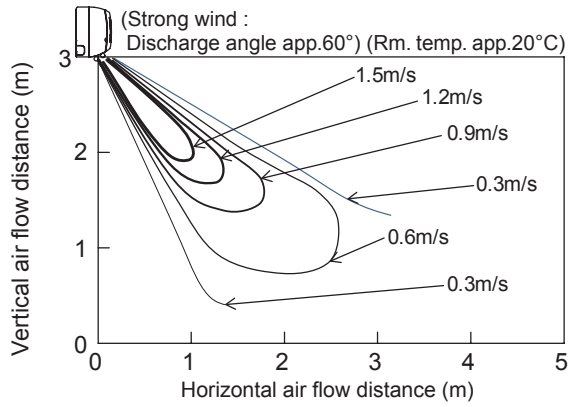
Cooling : Distribution of temperature



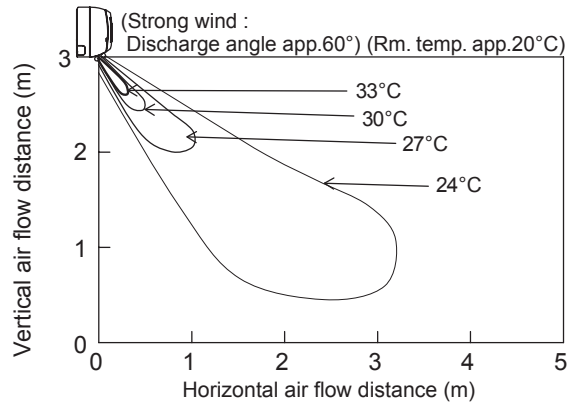
Wall Mounted (Type K2)

S-50PK2E5B

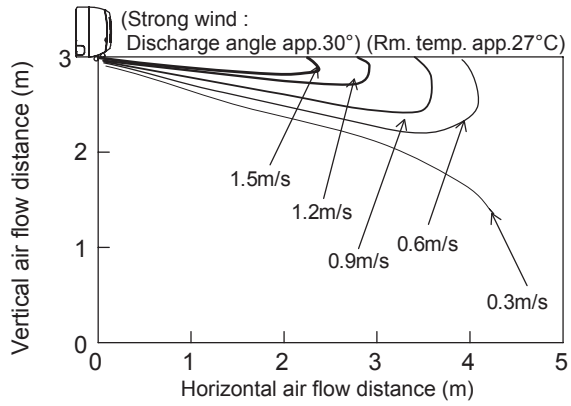
Heating : Distribution of wind velocity



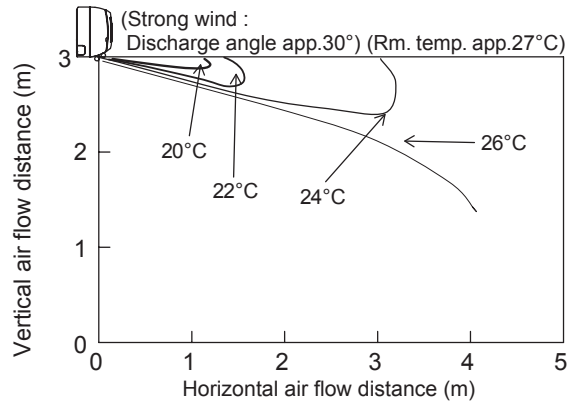
Heating : Distribution of temperature



Cooling : Distribution of wind velocity



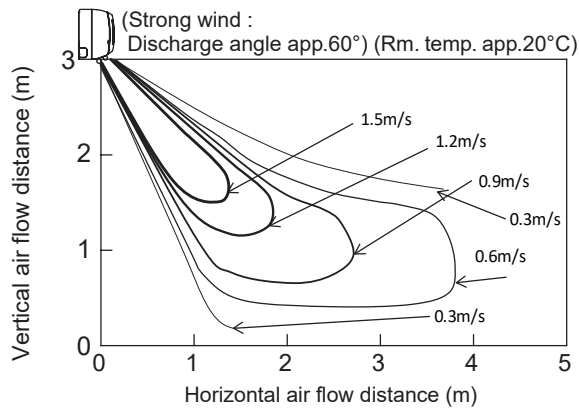
Cooling : Distribution of temperature



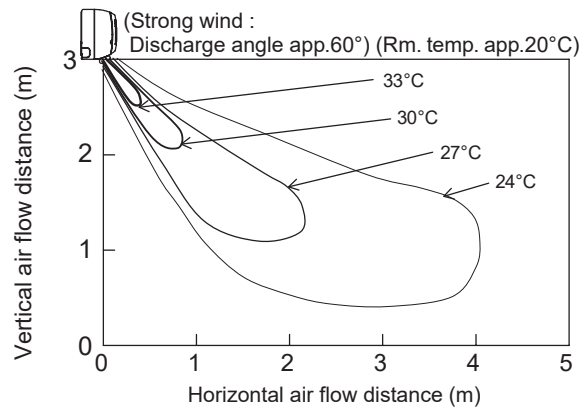
### Wall Mounted (Type K2)

#### S-60PK2E5B / 71PK2E5B

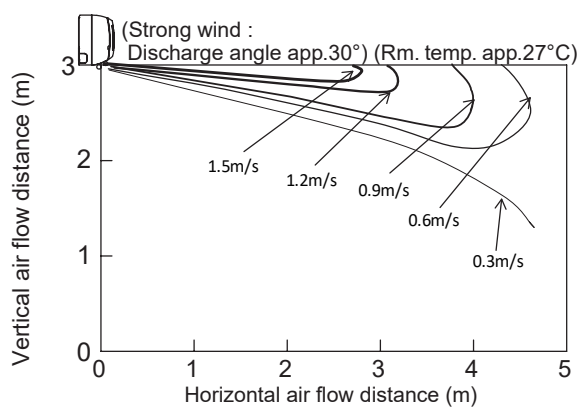
Heating : Distribution of wind velocity



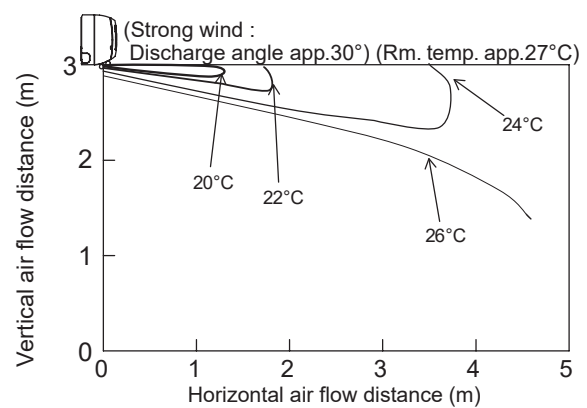
Heating : Distribution of temperature



Cooling : Distribution of wind velocity

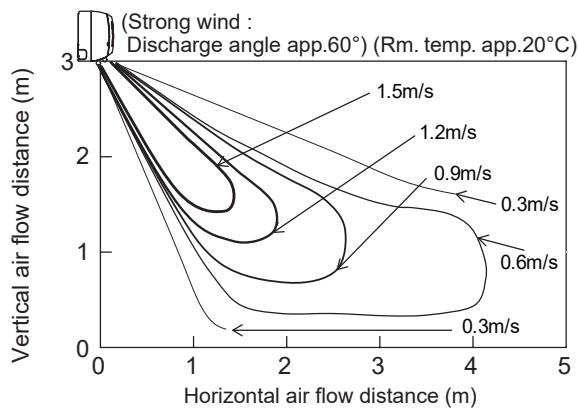


Cooling : Distribution of temperature

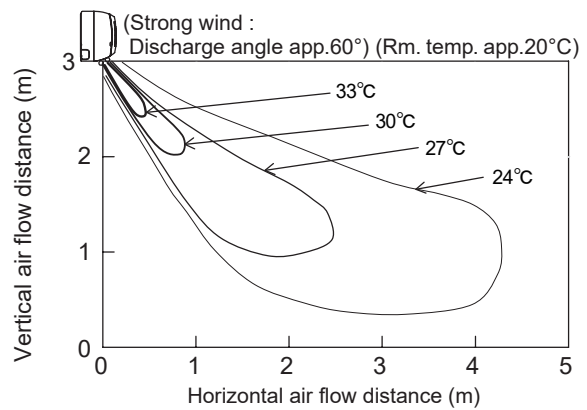


#### S-100PK2E5B

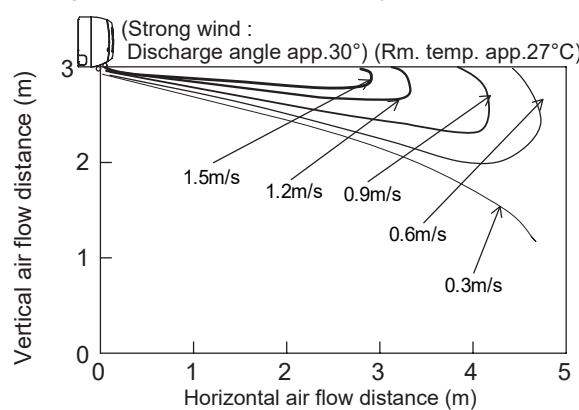
Heating : Distribution of wind velocity



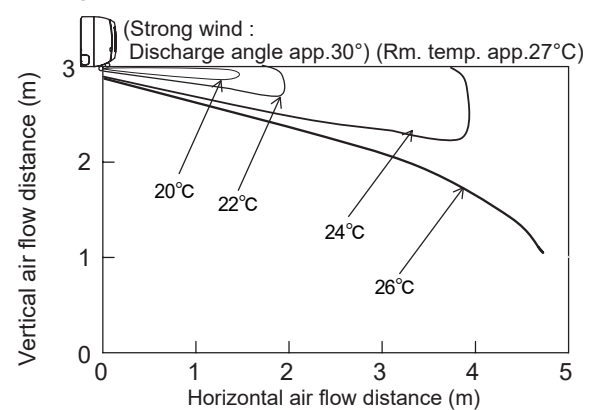
Heating : Distribution of temperature



Cooling : Distribution of wind velocity



Cooling : Distribution of temperature



## 1-9. Fresh Air Intake

### 1-9-1. Precautions Regarding External Air Intake

#### (1) Ventilation Load

Ensure that the design of the air-conditioner takes air-conditioning loads into consideration when external air intake is involved.

#### (2) Restrictions on External Air Intake

Ensure that the design conforms to the restrictions on air intake volume stipulated in accordance with the model of the indoor unit and the intake method. Consideration must also be taken to mixed air content listed in (3) below without fail.

\* If the air intake volume does not satisfy the required ventilation volume, air must be fed into the room separately with the use of a total heat exchanger or a fresh air processing air-conditioner, etc.

#### (3) Mixed Air

The amount of external air intake must be set within the scope of the unit's usage conditions when external air and internal air is mixed together. This is especially important in the following cases, in which it is necessary to either feed external air into the room after it has been processed or reduce the amount of external air that is fed in.

① When the external dew-point temperature is greater than the dry-bulb temperature of the air sucked into the unit  
Ensure that processing is performed so that the external dew-point temperature is lower than the temperature of the air sucked into the unit to prevent the risk of condensation building up.

② In the case of low external temperatures

There are cases in which the temperature of mixed air is lower than the operating range of the unit if excessive amounts of external air intake are used when the external temperature is low.

This problem is to be solved by either feeding external air into the room after it has been processed or reducing the amount of external air that is fed in.

③ When used in combination with humidifiers

External air must always be processed when the external air temperature reaches freezing point to prevent the risk of the humidifier freezing.

#### (4) Arranging Ducts and Filters in the Field

External air intake ducting must be arranged in the field.

External air filters must also be installed without fail in order to prevent the intake of dust and grit.

#### (5) Thermal Insulation for Ducts

Ensure that all external air intake ducting is heat-insulated without fail. Failure to observe this may result in the build-up of condensation.

#### (6) External Air Intake Coupling

Ensure that the design for external air intake is coupled with the fan blower operations of the indoor unit.

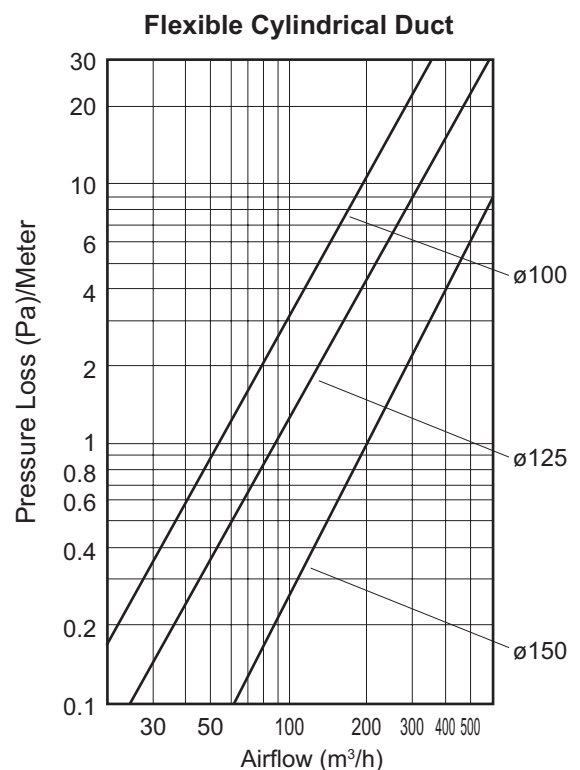
There are cases in which the dust that accumulates in the filter is blown into the room if the external air is fed from the filter. There are also cases in which the noise of external air being fed into the room can be heard from the indoor unit if external air is forcibly fed when the booster fan or other components on the indoor unit are not operating.

#### (7) Booster Fan Selection

Select the booster fan in accordance with the resistance of the external air intake duct (diagram on the pressure loss characteristics of the air flow volume for flexible cylindrical ducts) and the resistance prevalent inside the unit (external air intake volume & resistance within unit / operation noise characteristics).

#### (8) Attaching the External Air Intake Flange

Regarding the installation direction of the external air intake duct, refer to the Installation Instructions provided with the external air intake duct.



Air Flow Volume for Flexible Cylindrical Duct-Pressure Loss

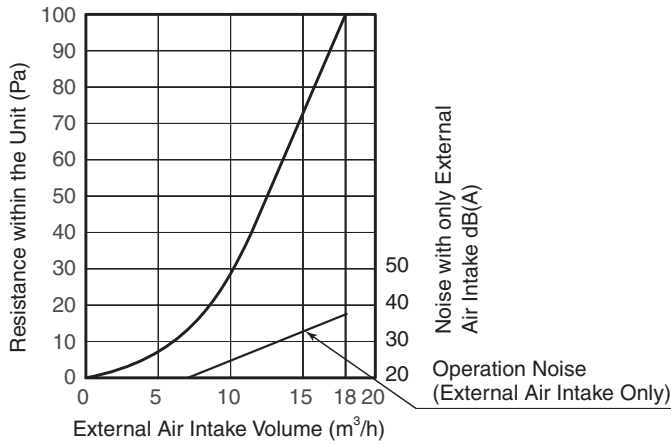


1-9-2. External Air Intake Volume & Resistance Within Unit / Operation Noise Characteristics

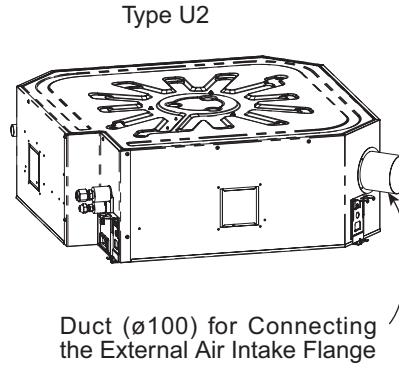
● 4-Way Cassette (Type U2)

When an External Air Intake Flange (ø100) is in Use

External Air Intake Volume and Resistance and Operation Noise Characteristics within the Unit



With the External Air Intake Flange Attached



- Calculate the operation noise when external air is being fed by combining the noise when only external air is being fed as shown in the graph for operation noise characteristics and the operation noise of the unit as stipulated in the catalogue.
- The operation noise conforms to JIS standards and constitute measurements taken in an anechoic chamber 1.5 m directly beneath the indoor unit. Under normal circumstances, the values shown here are greater owing to the effects of surrounding noise and reverberation when the unit is actually installed.

The amount of external air that is possible to feed when it is fed directly into the unit (ø100)

Type	50	60	71	100	125	140
Permissible Air Intake Volume (m³/h)	15	17	18	18	18	18

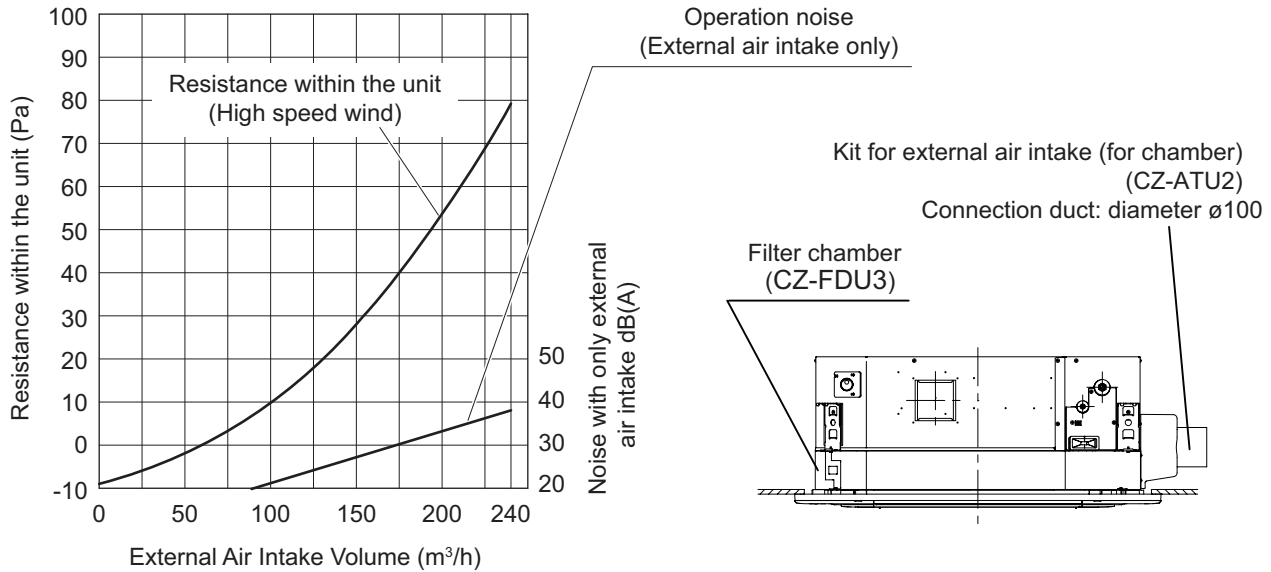
**NOTE**

The operation noise for models that use small units is lower, so use values that are within the range shown in the above table. Using values that exceed these will result in noise when only external air is fed being louder than the noise emitted from the unit.



**CAUTION** Use the following diagram along with the section "1-9-1. Precautions Regarding External Air Intake"

### 1-9-2-1. In a Case of External Air Intake Using Air Intake Chamber (CZ-FDU3+CZ-ATU2)



**External Air Intake Volume & Resistance Within Unit/  
Operation Noise Characteristics**

**With the External Air Intake Chamber Attached**

1. Calculate the operation noise when external air is being fed by combining the noise when only external air is being fed as shown in the diagram for operation noise characteristics and the operation noise of the unit as stipulated in the catalogue.
2. The operation noise conforms to JIS standards and constitute measurements taken in an anechoic chamber 1.5m directly below the indoor unit. Under normal circumstances, the diagram shown above is greater owing to the effects of surrounding noise and reverberation when the unit is actually installed.

### The amount of external air that is possible to feed when external air intake chamber is in use (CZ-FDU3+CZ-ATU2)

Type	50	60	71	100	125	140
Permissible air intake volume (m³/h)	180	190	240	240	240	240

\* The operation noise for models that use small units is lower, so use values that are within the range shown in the above table. Using values that exceed these will result in noise when only external air is fed being louder than the noise emitted from the unit.

#### ● Sample selection of booster fans

In a case of necessity at 200m³/h of external air intake:

1. Resistance within the unit      Diagram from "Resistance within the unit"    55 Pa
2. Duct resistance in case of duct with 4m length

Duct resistance      Diagram from "Air Flow Volume for Flexible Cylindrical Duct-Pressure Loss"      40 Pa    (=10 Pa/m x 4m)

---

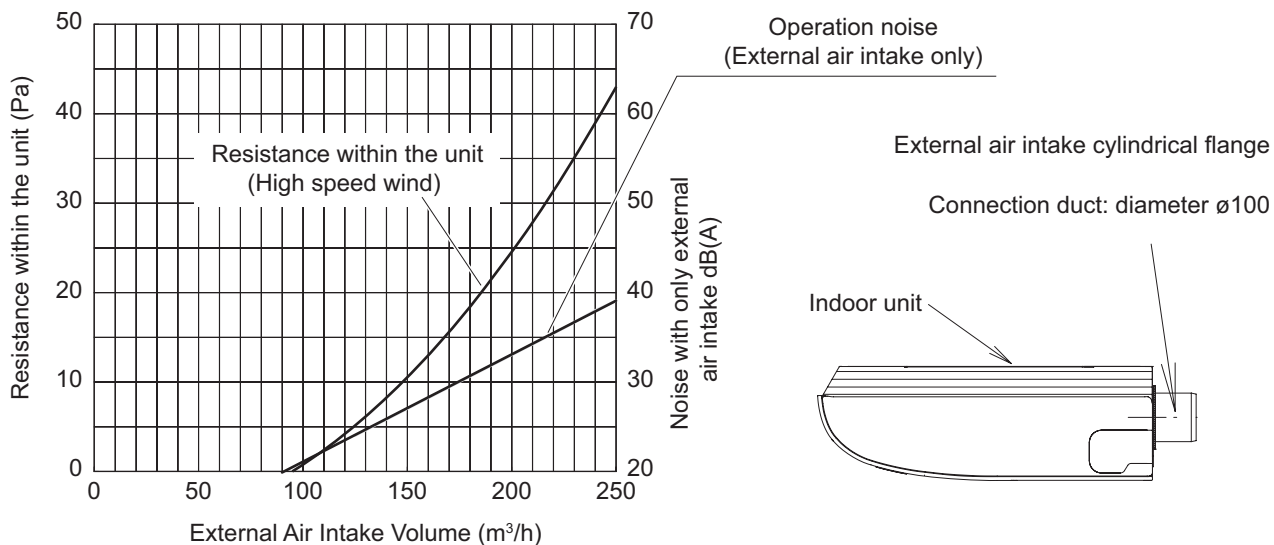
Total 95 Pa

Therefore, a booster is required to save a total 95 Pa of static pressure.

1-9-2. External Air Intake Volume & Resistance Within Unit / Operation Noise Characteristics (continued)

● Ceiling (Type T2)

1-9-2-1. In a Case of External Air Intake to Unit Directly (Using external air intake cylindrical flange)



External Air Intake Volume & Resistance Within Unit/  
Operation Noise Characteristics

With the External Air Intake Flange Attached

1. Calculate the operation noise when external air is being fed by combining the noise when only external air is being fed as shown in the diagram for operation noise characteristics and the operation noise of the unit as stipulated in the catalogue.
2. The operation noise conforms to JIS standards and constitute measurements taken in an anechoic chamber 1m front and 1m below the indoor unit. Under normal circumstances, the diagram shown above is greater owing to the effects of surrounding noise and reverberation when the unit is actually installed.

The amount of external air intake that is possible to feed when it is fed directly into the unit

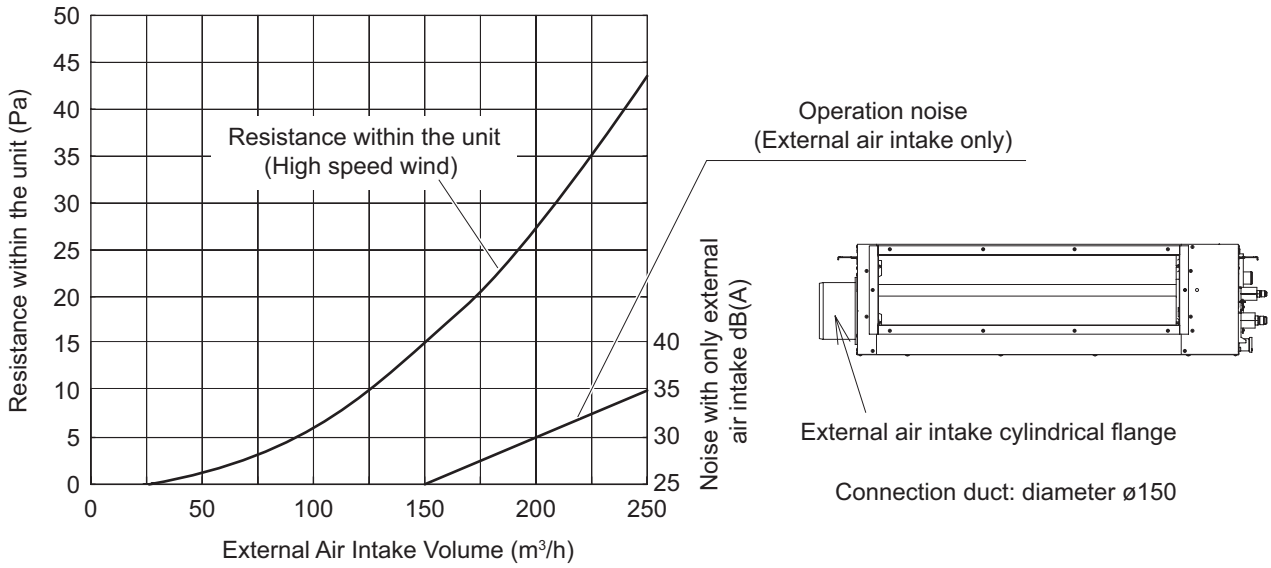
Type	50	60	71	100	125	140
Permissible air intake volume (m³/h)	170	200	210	240	240	240

\* The operation noise for models that use small units is lower, so use values that are within the range shown in the above table. Using values that exceed these will result in noise when only external air is fed being louder than the noise emitted from the unit.

1-9-2. External Air Intake Volume & Resistance Within Unit / Operation Noise Characteristics (continued)

● Low Silhouette Ducted (Type F1)

1-9-2-2. In a Case of External Air Intake to Unit Directly (Using external air intake cylindrical flange)



External Air Intake Volume & Resistance Within Unit/  
Operation Noise Characteristics

With the External Air Intake Flange Attached

1. Calculate the operation noise if external air is being fed by combining the noise when only external air is being fed as shown in the diagram for operation noise characteristics and the operation noise of the unit as stipulated in the catalogue.
2. The operation noise conforms to JIS standards and constitute measurements taken in an anechoic chamber 1.5m directly below the indoor unit. Under normal circumstances, the diagram shown above is greater owing to the effects of surrounding noise and reverberation when the unit is actually installed.

The amount of external air intake that is possible to feed when it is fed directly into the unit



Type	50	60	71	100	125	140
Permissible air intake volume (m³/h)	150	180	180	240	240	240

\* The operation noise for models that use small units is lower, so use values that are within the range shown in the above table. Using values that exceed these will result in noise when only external air is fed being louder than the noise emitted from the unit.

## 1-10. Electrical Wiring

- U-100PZ2E5, U-125PZ2E5, U-140PZ2E5  
U-100PZ2E8, U-125PZ2E8, U-140PZ2E8

### ELECTRICAL WIRING

 <b>Warning</b>	This air conditioner must be installed in accordance with national wiring regulations.
	Cables connected to outdoor unit must be approved polychloroprene sheathed type 60245 IEC 57 or H05RN-F/H07RN-F or heavier.
	The units must be connected to the supply cables for fixed wiring by qualified technician. Circuit breaker must be incorporated in the fixed wiring in accordance with the national wiring regulations. The circuit breaker must be approved, suitable for the voltage and current ratings of equipment and have a contact separation by 3mm in all poles. When the supply cable is damaged, it must be replaced by qualified technician.
	Be sure to install a current leakage breaker, main switch and fuse to the main power supply, otherwise electric shocks may result.
	Be sure to connect the unit to secure earth connection. If the earthing work is not carried out properly, electric shocks may result. 
Wiring shall be connected securely by using specified cables and fix them securely so that external force of the cables may not transfer to the terminal connection section. Imperfect connection and fixing leads to fire, etc.	

- Ensure to connect the electrical cable connections and clamp the wires securely to the terminal connections using cord clamps so that no undue force is placed on the wires (power source cable, indoor/outdoor connection cables, earth lead wire).
- Do not install a phase advance capacitor for power factor improvement. (It does not improve the power factor and will cause abnormal overheating.)
- Do not bind the excess cables together and place them inside this unit.
- Protect the electrical cable with the protective bushing provided so that the cables do not get damaged on the knock hole or etched portions. If there is space between the electrical cables and the protective bushing occurs, seal it accordingly.
- Tie the cables with the provided binding strap so that they do not touch the compressor and the pipes.
- When setting up the cables, inside of unit install properly so that the front panel will not lift up. Make sure that front panel mount correctly.
- Use a round type terminal with an insulation sleeve for connecting to the terminal block.
- Use the appropriate screwdriver for tightening the terminal screws. Small sized screwdriver damages the head of the screw and cannot tighten it properly.
- There is risk of damaging the screw if the terminal screw is over tightened. Tighten with the appropriate torque.

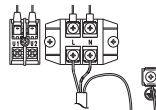
Screw diameter name	Tightening torque N•m(kgf•cm)
M4	1.57~1.96 (16~20)
M5	1.96~2.45 (20~25)

- Direction to pull out wires



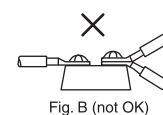
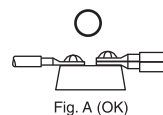
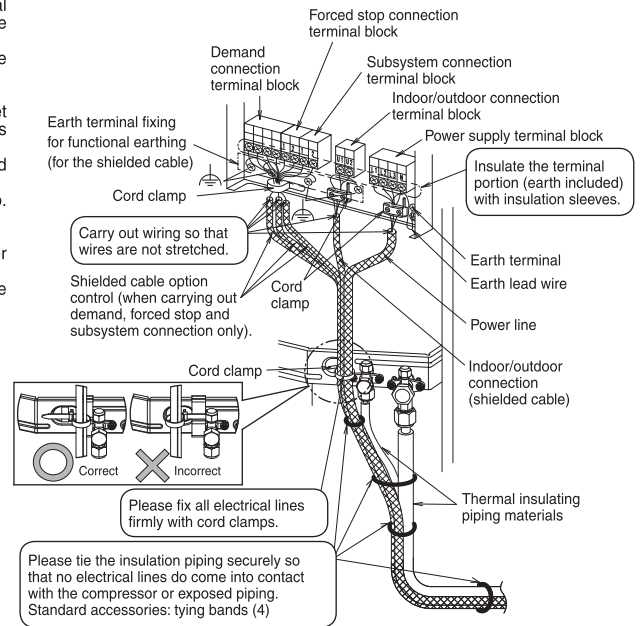
Seal wiring holes after wiring using included protection bush. (other holes are for connecting conduit pipe)

- Earth lead wire set up

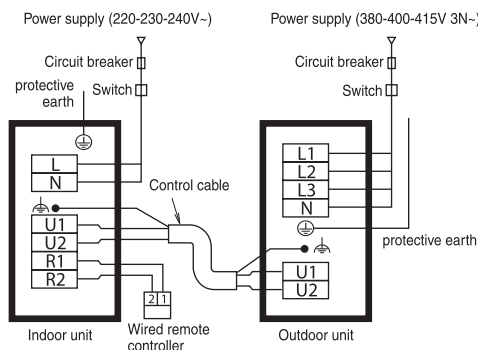


The earth lead wire shall be longer than other lead wires as shown in the figure for electrical safety in case it slips out of the cord from the anchorage.

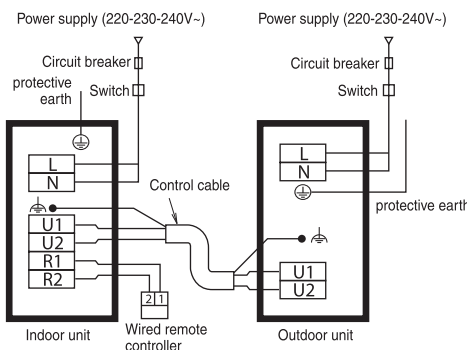
- Be sure to connect the wires correctly to terminal board with connecting the crimp type ring terminal to the wires.
- If connecting two separate wires to a single crimped terminal, place the two crimped terminal wires together as shown in Fig. A. (If the arrangement shown in Fig. B is used, poor contacts or contact damage may result.)



#### OUTDOOR UNIT/3-PHASE MODEL



#### OUTDOOR UNIT/SINGLE-PHASE MODEL



This equipment complies with EN/IEC 61000-3-12 provided that the short-circuit power  $S_{sc}$  is greater than or equals to  $\times 2$  kVA at the interface point between the user's supply and the public system. It is the responsibility of the installer or user of the equipment to ensure; by consultation with the distribution network operator if necessary that the equipment is connected only to supply with a short-circuit power  $S_{sc}$  greater than or equals to  $\times 2$  kVA.

$S_{sc}$  : Short circuit power  : functional earthing  
(for the shielded cable)

Model name	Power supply	Time delay fuse or circuit capacity	$\times 1$ Control cable	$\times 2$ $S_{sc}$
U-100PZ2E5	220-230-240V~	30A	0.75mm <sup>2</sup>	4750kVA
U-125PZ2E5	220-230-240V~	35A	0.75mm <sup>2</sup>	5500kVA
U-140PZ2E5	220-230-240V~	40A	0.75mm <sup>2</sup>	5650kVA
U-100PZ2E8	380-400-415V 3N~	15A	0.75mm <sup>2</sup>	$\times 3$
U-125PZ2E8	380-400-415V 3N~	15A	0.75mm <sup>2</sup>	$\times 3$
U-140PZ2E8	380-400-415V 3N~	15A	0.75mm <sup>2</sup>	$\times 3$

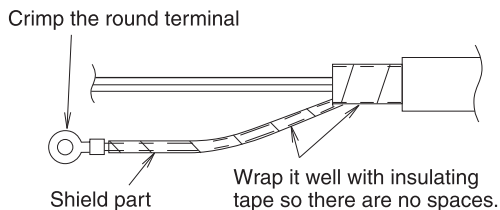
$\times 1$  Use a shielded cable for the control cable. Overall extension less than 500m

$\times 3$  Intended for professional use. Permission from the power supplier is required when installing the U-100PZ2E8, U-125PZ2E8, U-140PZ2E8 outdoor units that are connected to a 16 A distribution network.

- The product meets the technical requirements of EN/IEC 61000-3-3.
- Decide the length and size of the power supply cable based on the maximum ampere tabulated above in accordance with the national wiring regulations.
- Select the fuse(s) and/or circuit breaker(s) from the types and ratings suitable for the maximum ampere tabulated above in accordance with the national wiring regulations.
- If capacity of power supply circuit and enforcement are not enough, it can causes the electric shock and a fire.

For the shield part of the shielded cable, twist the end out, crimp it with a round terminal, and connect it to the functional earthing screw.

After crimping it with a round terminal, wrap it with insulating tape so there are no spaces and adjust it so the shield part does not touch any live parts.



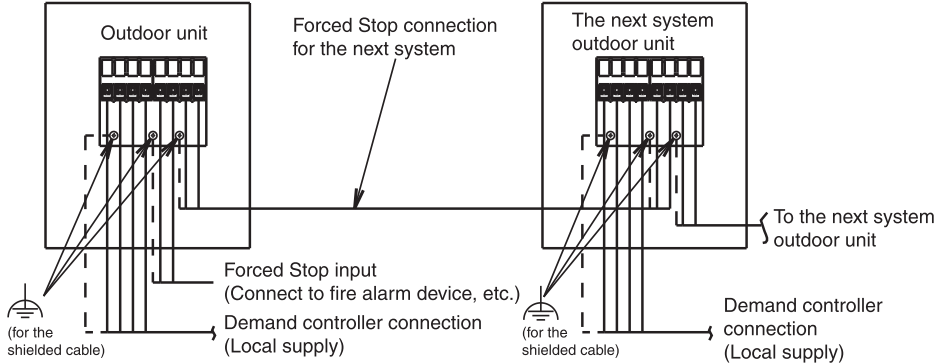
### Caution

Be sure that the shield part of the shielded cable does not touch the terminal block or any live parts. Failure to do so may lead to electric shock or fire.

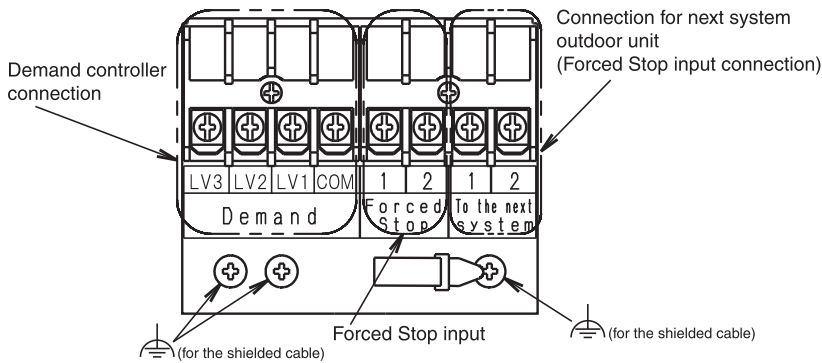
# CONNECTION FOR DEMAND AND FORCED STOP

## 1. CONNECTION PROCEDURE

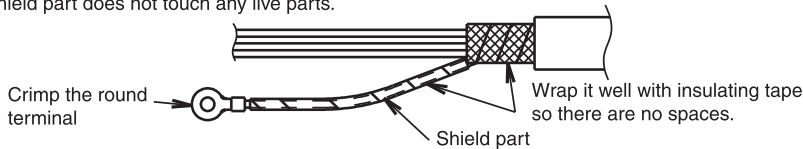
Be sure to always turn the power off first when setting up the wire and cable connections. Failure to do so may lead to electric shock or unit failure.



The demand terminal set up is shown in the following illustration.



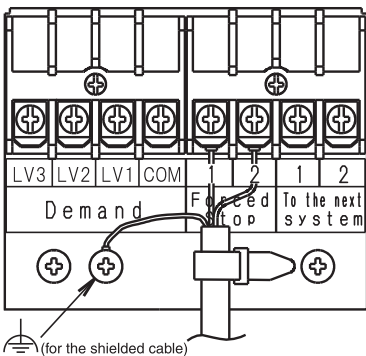
- Use a shielded cable for the cable connection. For the shield part of the shielded cable twist the end out, crimp it with a round terminal, and connect it to the functional earthing screw. After crimping it with a round terminal, wrap it with insulating tape so there are no spaces and adjust it so the shield part does not touch any live parts.



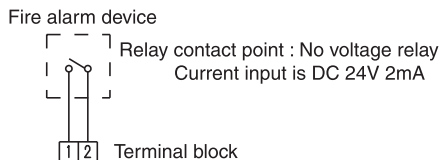
**CAUTION** Be sure that the shield part of the shielded cable does not touch the terminal block or any live parts. Failure to do so may lead to electric shock or fire.

## WHEN CONNECTION TO THE FORCED STOP INPUT

With the Forced Stop input, it is possible to override the air conditioning operation to force a stop if a signal is received from a fire alarm device, etc.

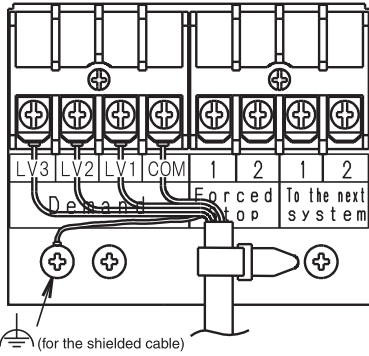


Connect the wiring (2-wire) to points 1 and 2 on the left side of the terminal block. The shield part of the shielded cable is connected with functional earthing under the terminal block. Secure the wiring with the cord clamp located on the lower part of the terminal block.



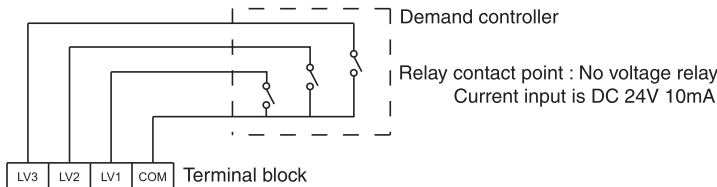
**WHEN CONNECTING THE DEMAND CONTROLLER INPUT**

It is possible to choose various demand levels.  
Refer to the table below.



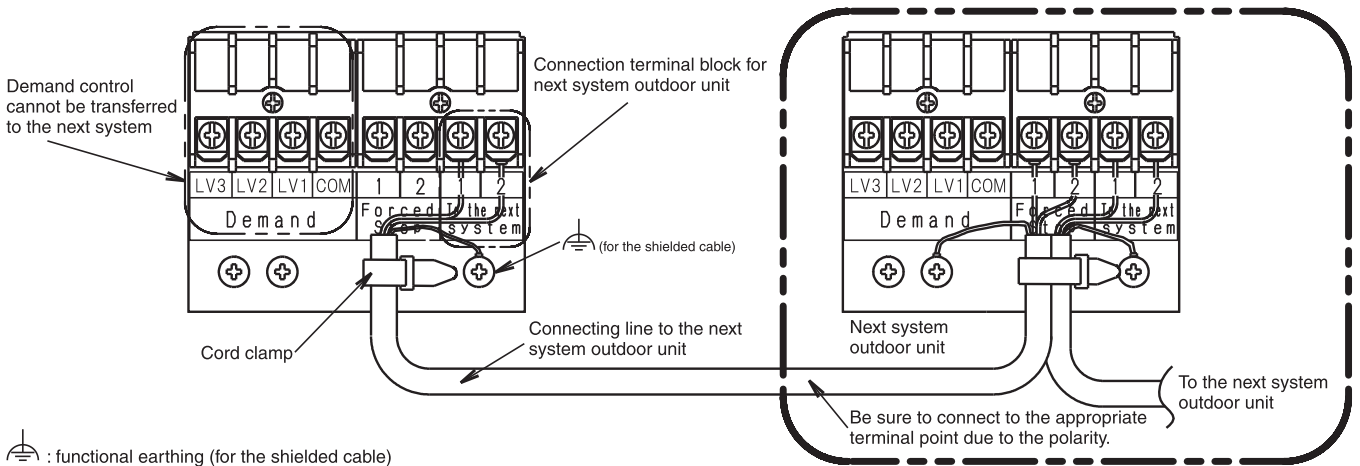
Terminal no. for demand section	Description
LV1	Approx. 75% of rated power input
LV2	Approx. 50% of rated power input
LV3	Compressor off

Connect the wiring (4-wire) to the Demand section (LV1, LV2, LV3, COM) on the terminal block.  
The shield part of the shielded cable is connected with functional earthing under the terminal block.  
Secure the wiring with the cord clamp located on the lower part of the terminal block.



**WHEN CONNECTING TO THE NEXT SYSTEM UNIT**

- Forced Stop input can be transferred to the next system unit.
  - When using the Forced Stop input, connect the wiring to the terminal points 1 and 2 on the right side of the lower part of the terminal block.
  - The maximum wire/cable length is 100 m.
  - The demand control cannot be transferred to the next system unit.
  - When transferring to the next system, the maximum number of connecting units is 30.
1. Connecting the wiring to the lower part of the terminal block.  
When transferring the Forced Stop input to the next system connect the wiring (2-wire) to the terminal points 1 and 2 at the lower right side of the terminal block.  
The shield part of the shielded cable is connected with functional earthing under the terminal block.  
Secure the wiring with the cord clamp located on the lower part of the terminal block.
  2. Connecting the shielded cable to the terminal block for the next system.  
For the Forced Stop input, connect the wiring to the terminal points 1 and 2 at the lower right side of the terminal block.  
When connecting to the next system be sure to connect to the appropriate terminal point due to the polarity.



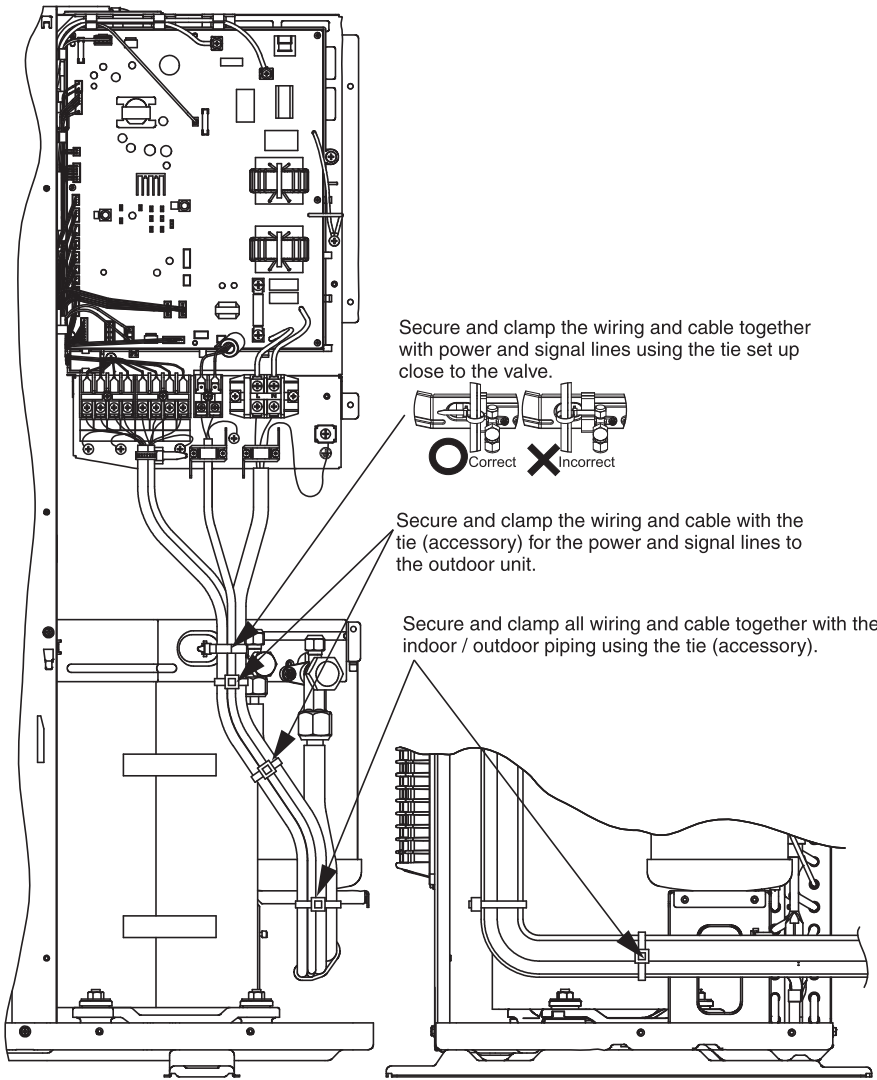
⏏ : functional earthing (for the shielded cable)



## 2. WIRING PROCEDURE

Follow the wiring procedure below for the terminal connection.

1. Secure and clamp the power and signal lines with the tie, set up close to the valve.
2. Set the wiring and cables for the power and signal lines to the outdoor unit together, and secure each wire and cable with the tie.
3. Set up the wiring and cable for the outdoor unit piping and secure with a tie.



## Electrical Wiring

### ■ General Precautions on Wiring

- (1) Before wiring, confirm the rated voltage of the unit as shown on its nameplate, then carry out the wiring closely following the wiring diagram.
- (2) Provide a power outlet to be used exclusively for each unit and a circuit breaker for overcurrent protection should be provided in the exclusive line.
- (3) To prevent possible hazards from insulation failure, the unit must be grounded.
- (4) Each wiring connection must be done in accordance with the wiring system diagram. Wrong wiring may cause the unit to misoperate or become damaged.
- (5) Do not allow wiring to touch the refrigerant tubing, compressor, or any moving parts of the fan.
- (6) Unauthorized changes in the internal wiring can be very dangerous. The manufacturer will accept no responsibility for any damage or misoperation that occurs as a result of such unauthorized changes.
- (7) Regulations on wire diameters differ from locality to locality. For field wiring rules, please refer to your LOCAL ELECTRICAL CODES before beginning.  
You must ensure that installation complies with all relevant rules and regulations.
- (8) To prevent malfunction of the air conditioner caused by electrical noise, care must be taken when wiring as follows:
  - The remote control wiring and the inter-unit control wiring should be wired apart from the inter-unit power wiring.
  - Use shielded wires for inter-unit control wiring between units and ground the shield on both sides.
- (9) If the power supply cord of this appliance is damaged, it must be replaced by a repair shop designated by the manufacturer, because special-purpose tools are required.



**CAUTION** Check local electrical codes and regulations before wiring.  
Also, check any specified instruction or limitations.

### ■ Recommended Wire Length and Wire Diameter for Power Supply System

#### Indoor unit

Type	(B) Power supply	Time delay fuse or circuit capacity
	2.5 mm <sup>2</sup>	
U2	Max. 130 m	10-16 A

#### Indoor unit

Type	(B) Power supply	Time delay fuse or circuit capacity
	2.5 mm <sup>2</sup>	
F1	Max.130 m	10-16A
T2	Max.130 m	10-16A

Type	(B) Power supply	Time delay fuse or circuit capacity
	2 mm <sup>2</sup>	
K2	Max.130 m	10-16A

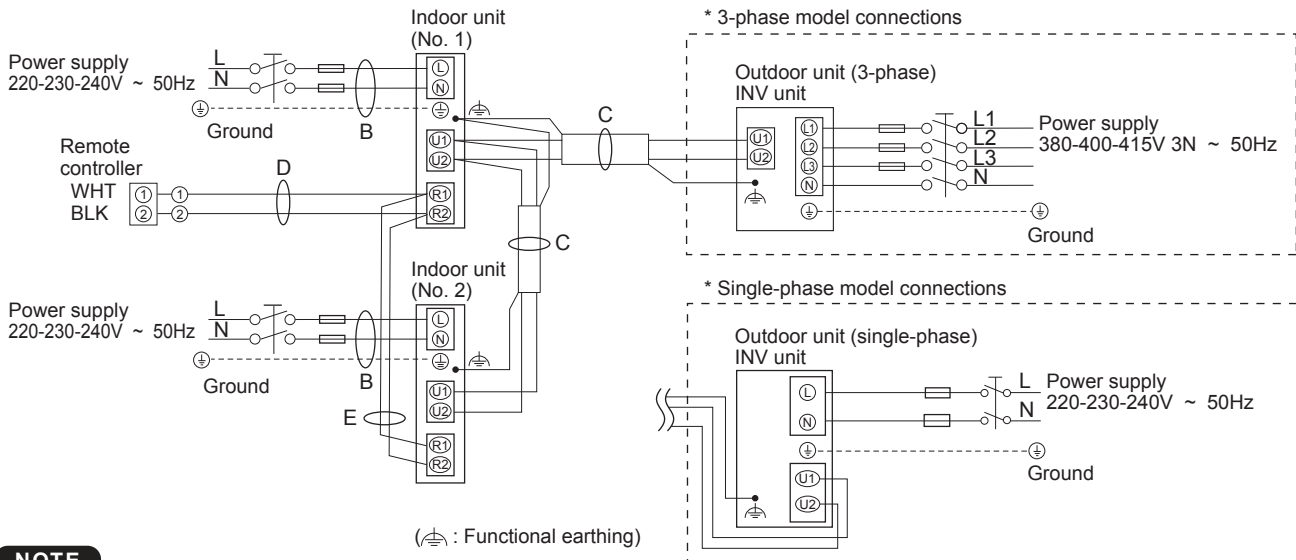
#### Control wiring

(C) Inter-unit (between outdoor and indoor units) control wiring	(D) Remote control wiring	(E) Control wiring for group control
0.75 mm <sup>2</sup> (AWG #18) Use shielded wiring*	0.75 mm <sup>2</sup> (AWG #18)	0.75 mm <sup>2</sup> (AWG #18)
Max. 1,000 m	Max. 500 m	Max. 200 m (Total)

#### NOTE

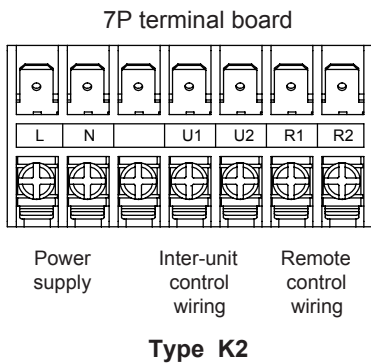
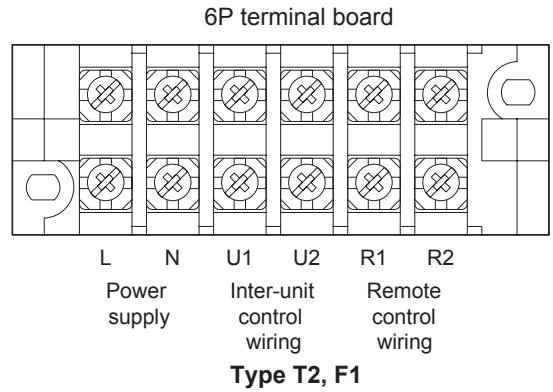
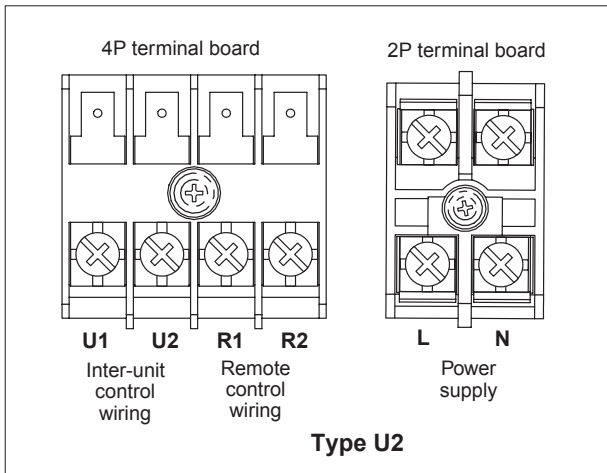
\* With ring-type wire terminal.

■ Wiring System Diagrams



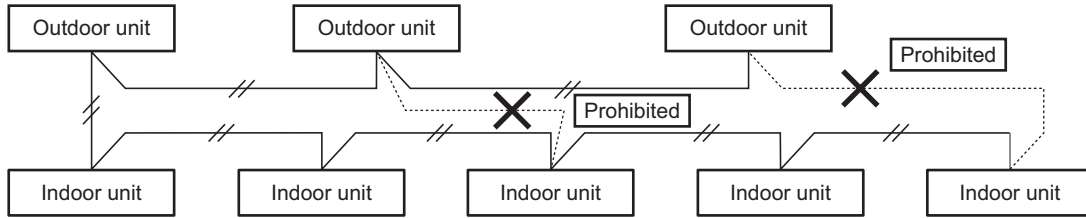
**NOTE**

- (1) Refer to “Recommended Wire Length and Wire Diameter for Power Supply System” for the explanation of “B”, “C”, “D” and “E” in the above diagram.
- (2) The basic connection diagram of the indoor unit shows the terminal boards, so the terminal boards in your equipment may differ from the diagram.
- (3) Refrigerant Circuit (R.C.) address should be set before turning the power on.
- (4) Regarding R.C. address setting, refer to the installation instructions supplied with the remote controller (optional). Auto address setting can be executed by remote controller automatically. Refer to the installation instructions supplied with the remote controller (optional).

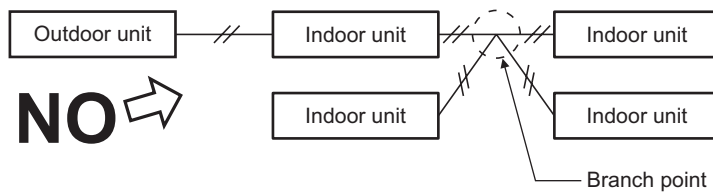


**CAUTION**

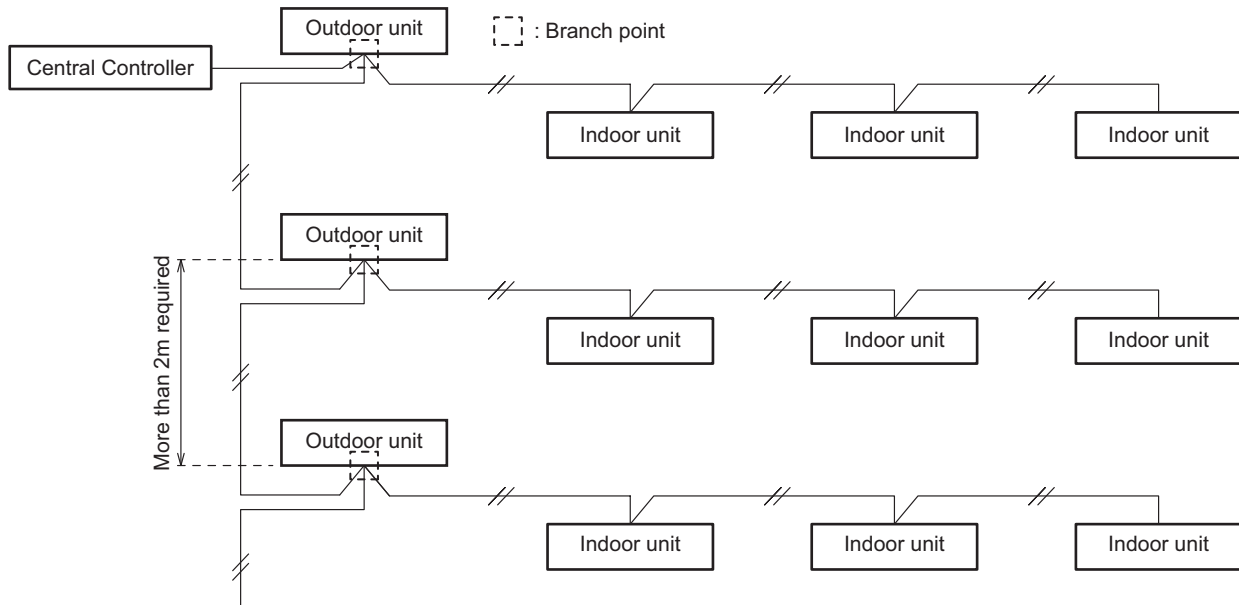
- (1) When linking the outdoor units in a network, disconnect the terminal extended from the short plug from all outdoor units except any one of the outdoor units.  
(When shipping: In shorted condition.)  
For a system without link (no wiring connection between outdoor units), do not remove the short plug.
- (2) Do not install the inter-unit control wiring in a way that forms a loop.



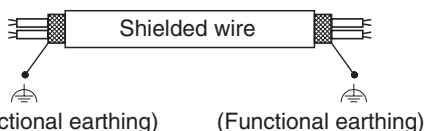
- (3) Do not install inter-unit control wiring such as star branch wiring. Star branch wiring causes mis-address setting.



- (4) If branching the inter-unit control wiring, the number of branch points should be 16 or fewer.



- (5) Use shielded wires for inter-unit control wiring (c) and ground the shield on both sides, otherwise misoperation from noise may occur.  
Connect wiring as shown in Section "■ Wiring System Diagrams".
- (6) Connecting cable between indoor unit and outdoor unit shall be approved polychloroprene sheathed 5 or 3 \* 1.5 mm<sup>2</sup> flexible cord. Type designation 60245 IEC 57 (H05RN-F, GP85PCP etc.) or heavier cord.
- Use the standard power supply cables for Europe (such as H05RN-F or H07RN-F which conform to CENELEC (HAR) rating specifications) or use the cables based on IEC standard. (60245 IEC57, 60245 IEC66)

**WARNING**

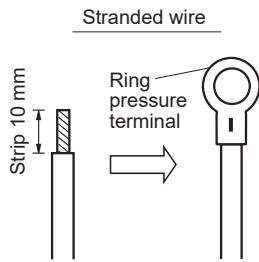
Loose wiring may cause the terminal to overheat or result in unit malfunction. A fire hazard may also occur.  
Therefore, ensure that all wiring is tightly connected.

When connecting each power wire to the terminal, follow the instructions on "How to connect wiring to the terminal" and fasten the wire securely with the terminal screw.

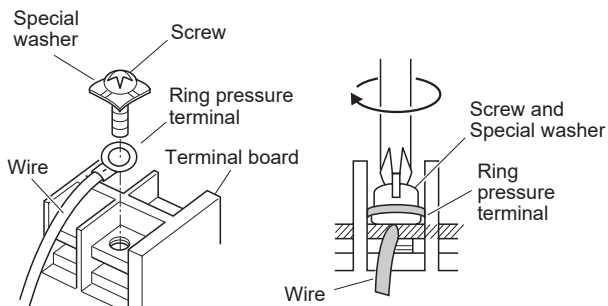
## How to connect wiring to the terminal

### ■ For stranded wiring

- (1) Cut the wire end with cutting pliers, then strip the insulation to expose the stranded wiring about 10 mm and tightly twist the wire ends.



- (2) Using a Phillips head screwdriver, remove the terminal screw(s) on the terminal board.
- (3) Using a ring connector fastener or pliers, securely clamp each stripped wire end with a ring pressure terminal.
- (4) Place the ring pressure terminal, and replace and tighten the removed terminal screw using a screwdriver.

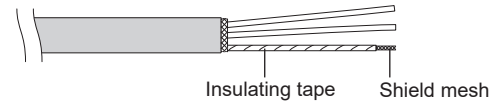


### ■ Examples of shield wires

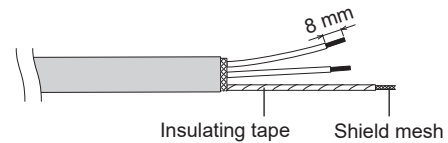
- (1) Remove cable coat not to scratch braided shield.



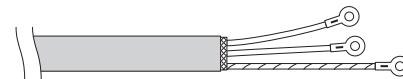
- (2) Unbraid the braided shield carefully and twist the unbraided shield wires tightly together. Insulate the shield wires by covering them with an insulation tube or wrapping insulating tape around them.



- (3) Remove coat of signal wire.

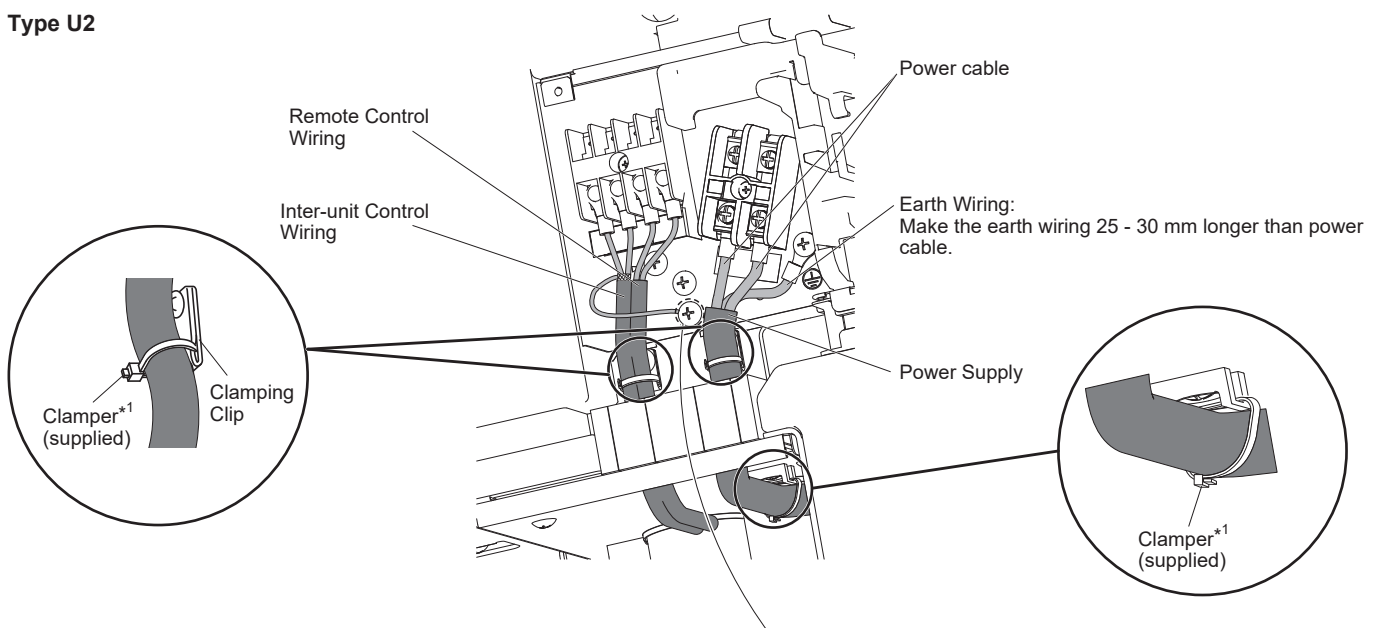


- (4) Attach ring pressure terminals to the signal wires and the shield wires insulated in Step (2).



### ■ Wiring samples

#### Type U2

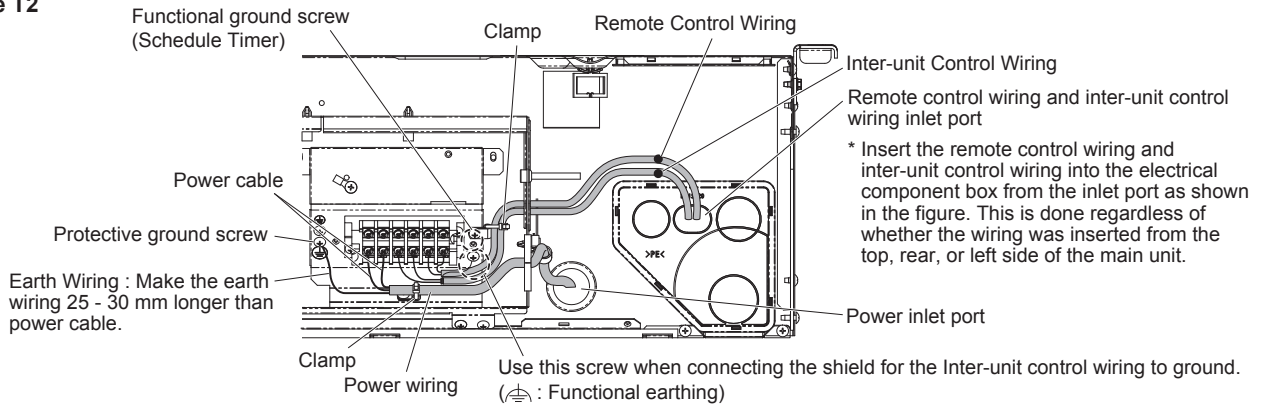


\*1 Fasten tightly.

Use this screw when connecting the shield for the Inter-unit control wiring to ground.

(⏏) : Functional earthing

**Type T2**



**How to carry out power supply wiring**

(1) Wiring connection ports

The power inlet port is located at the rear.  
The remote control wiring inlet port is located at the rear (for use with the wired remote controller). For details, see the figure under the section 3-1 (3).

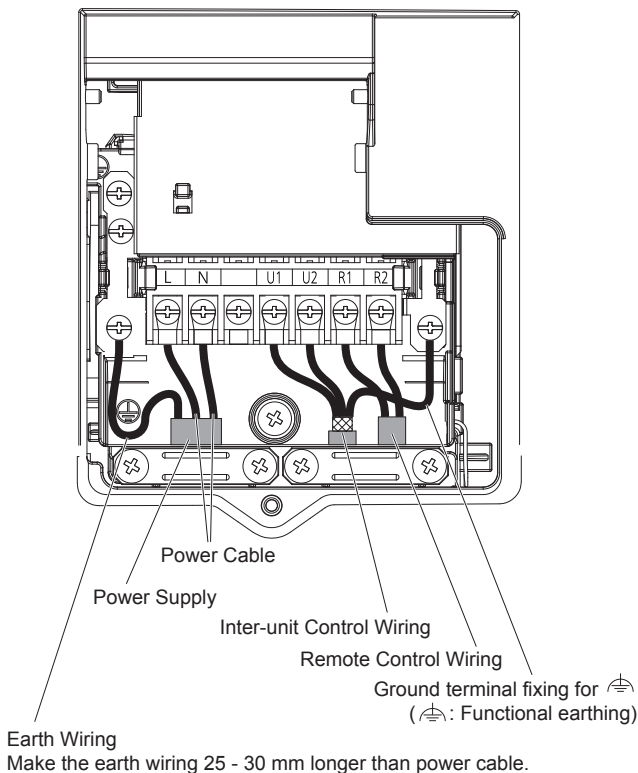
(2) How to carry out wiring

- Insert the power wiring into the indoor unit through the rubber at the side of the electrical component box.
- For wiring connection to the outdoor unit and remote control wiring, open the elongated hole of the piping cover and pass the wires through the hole.

**NOTE**

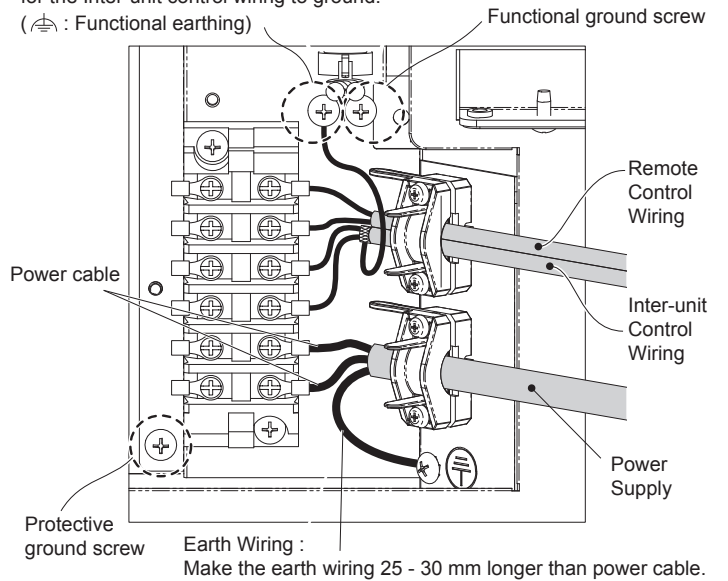
Be sure to use sealing putty to seal off the opening to prevent dust.

**Type K2**



**Type F1**

Use this screw when connecting the shield for the Inter-unit control wiring to ground.  
(⏏: Functional earthing)



If the terminal screws on the terminal board are tightened too hard, the screws might be damaged. See the tightening torque values as shown below.

<b>Tightening torques for terminal screws</b>	1.0 – 1.4 N · m {10 – 14 kgf · cm}
---	---------------------------------------

1-11. Installation Instructions

Outdoor Unit

- 1. U-100PZ2E5, U-125PZ2E5, U-140PZ2E5, U-100PZ2E8, U-125PZ2E8, U-140PZ2E8

**PRECAUTION FOR USING R32 REFRIGERANT**

- The basic installation work procedures are the same as conventional refrigerant (R410A, R22) models.  
However, pay careful attention to the following points:

 **WARNING**

- Since the working pressure is higher than that of refrigerant R22 models, some of the piping and installation and service tools are special.

  - ❗ Especially, when replacing a refrigerant R22 model with a new refrigerant R32 model, always replace the conventional piping and flare nuts with the R32 and R410A piping and flare nuts on the outdoor unit side. For R32 and R410A, the same flare nut on the outdoor unit side and pipe can be used.
- Models that use refrigerant R32 and R410A have a different charging port thread diameter to prevent erroneous charging with refrigerant R22 and for safety. Therefore, check beforehand.

  - ❗
- Be more careful than R22 so that foreign matter (oil, water, etc.) does not enter the piping.

  - ❗ Also, when storing the piping, securely seal the opening by pinching, taping, etc. (Handling of R32 is similar to R410A.)

 **CAUTION**

- 1. Installation (Space)

  - That the installation of pipe-work shall be kept to a minimum.
  - Must ensure that pipe-work shall be protected from physical damage.
  - That compliance with national gas regulations shall be observed.
  - ❗
  - Must ensure mechanical connections be accessible for maintenance purposes.
  - In cases that require mechanical ventilation, ventilation openings shall be kept clear of obstruction.
  - When disposal of the product, do follow to the precautions in “12. Recovery” on page 1-11-1-6 and comply with national regulations. Always contact to local municipal offices for proper handling.
- 2. Servicing

2-1. Service personnel

  - ❗
  - Any qualified person who is involved with working on or breaking into a refrigerant circuit should hold a current valid certificate from an industry-accredited assessment authority, which authorizes their competence to handle refrigerants safely in accordance with an industry recognised assessment specification.

- Servicing shall only be performed as recommended by the equipment manufacturer. Maintenance and repair requiring the assistance of other skilled personnel shall be carried out under the supervision of the person competent in the use of flammable refrigerants.
- Servicing shall be performed only as recommended by the manufacturer.

#### 2-2. Work

- Prior to beginning work on systems containing flammable refrigerants, safety checks are necessary to ensure that the risk of ignition is minimised.  
For repair to the refrigerating system, “2-3. General work area” on page 1-11-1-2 to “2-7. Ventilated area” on page 1-11-1-2 shall be completed prior to conducting work on the system.
- Work shall be undertaken under a controlled procedure so as to minimise the risk of a flammable gas or vapour being present while the work is being performed.

#### 2-3. General work area

- All maintenance staff and others working in the local area shall be instructed on the nature of work being carried out.
- Work in confined spaces shall be avoided.
- The area around the workspace shall be sectioned off.
- Ensure that the conditions within the area have been made safe by control of flammable material.

#### 2-4. Checking for presence of refrigerant

- The area shall be checked with an appropriate refrigerant detector prior to and during work, to ensure the technician is aware of potentially toxic or flammable atmospheres.
- Ensure that the leak detection equipment being used is suitable for use with all applicable refrigerants, i.e. non-sparking, adequately sealed or intrinsically safe.

#### 2-5. Presence of fire extinguisher

- If any hot work is to be conducted on the refrigeration equipment or any associated parts, appropriate fire extinguishing equipment shall be available to hand.
- Have a dry powder or CO<sub>2</sub> fire extinguisher adjacent to the charging area.

#### 2-6. No ignition sources

- No person carrying out work in relation to a refrigeration system which involves exposing any pipe work shall use any sources of ignition in such a manner that it may lead to the risk of fire or explosion.
- All possible ignition sources, including cigarette smoking, should be kept sufficiently far away from the site of installation, repairing, removing and disposal, during which refrigerant can possibly be released to the surrounding space.
- Prior to work taking place, the area around the equipment is to be surveyed to make sure that there are no flammable hazards or ignition risks.
- “No Smoking” signs shall be displayed.

#### 2-7. Ventilated area

- Ensure that the area is in the open or that it is adequately ventilated before breaking into the system or conducting any hot work.
- A degree of ventilation shall continue during the period that the work is carried out.
- The ventilation should safely disperse any released refrigerant and preferably expel it externally into the atmosphere.



### 2-8. Checks to the refrigeration equipment

- Where electrical components are being changed, they shall be fit for the purpose and to the correct specification.
- At all times the manufacturer's maintenance and service guidelines shall be followed.
- If in doubt, consult the manufacturer's technical department for assistance.
  - The charge size is in accordance with the room size within which the refrigerant containing parts are installed;
  - The ventilation machinery and outlets are operating adequately and are not obstructed;
  - Marking to the equipment continues to be visible and legible. Markings and signs that are illegible shall be corrected;
  - Refrigeration pipe or components are installed in a position where they are unlikely to be exposed to any substance which may corrode refrigerant containing components, unless the components are constructed of materials which are inherently resistant to being corroded or are suitably protected against being so corroded.

### 2-9. Checks to electrical devices

- Repair and maintenance to electrical components shall include initial safety checks and component inspection procedures.
- If a fault exists that could compromise safety, then no electrical supply shall be connected to the circuit until it is satisfactorily dealt with.
- If the fault cannot be corrected immediately but it is necessary to continue operation, an adequate temporary solution shall be used.
- This shall be reported to the owner of the equipment so all parties are advised.
- Initial safety checks shall include:
  - That no live electrical components and wiring are exposed while charging, recovering or purging the system;
  - That there is continuity of earth bonding.

### 3. Repairs to sealed components

- During repairs to sealed components, all electrical supplies shall be disconnected from the equipment being worked upon prior to any removal of sealed covers, etc.
- Particular attention shall be paid to the following to ensure that by working on electrical components, the casing is not altered in such a way that the level of protection is affected. This shall include damage to cables, excessive number of connections, terminals not made to original specification, damage to seals, incorrect fitting of glands, etc.
- ❗ • Ensure that apparatus is mounted securely.
- Ensure that seals or sealing materials have not degraded to the point that they no longer serve the purpose of preventing the ingress of flammable atmospheres.
- Replacement parts shall be in accordance with the manufacturer's specifications.

NOTE: The use of silicon sealant can inhibit the effectiveness of some types of leak detection equipment.  
Intrinsically safe components do not have to be isolated prior to working on them.

### 4. Repair to intrinsically safe components

- Do not apply any permanent inductive or capacitance loads to the circuit without ensuring that this will not exceed the permissible voltage and current permitted for the equipment in use.
- ❗ • Intrinsically safe components are the only types that can be worked on while live in the presence of a flammable atmosphere. The test apparatus shall be at the correct rating.
- Replace components only with parts specified by the manufacturer.
- Other parts may result in the ignition of refrigerant in the atmosphere from a leak.

### 5. Cabling

- ❗ • Check that cabling will not be subject to wear, corrosion, excessive pressure, vibration, sharp edges or any other adverse environmental effects.
- The check shall also take into account the effects of aging or continual vibration from sources such as compressors or fans.

<p>6. Detection of flammable refrigerants</p> <p>! Under no circumstances shall potential sources of ignition be used in the searching for or detection of refrigerant leaks.</p> <p>• A halide torch (or any other detector using a naked flame) shall not be used.</p>	
<p>7. Leak detection methods</p> <p>! Electronic leak detectors may be used to detect refrigerant leaks but, in the case of flammable refrigerants, the sensitivity may not be adequate, or may need re-calibration. (Detection equipment shall be calibrated in a refrigerant-free area.)</p> <p>! Ensure that the detector is not a potential source of ignition and is suitable for the refrigerant used.</p> <p>• Leak detection equipment shall be set at a percentage of the LFL of the refrigerant and shall be calibrated to the refrigerant employed, and the appropriate percentage of gas (25 % maximum) is confirmed.</p> <p>• Leak detection fluids are suitable for use with most refrigerants but the use of detergents containing chlorine shall be avoided as the chlorine may react with the refrigerant and corrode the copper pipe-work.</p> <p>• If a leak is suspected, all naked flames shall be removed/extinguished.</p> <p>• If a leakage of refrigerant is found which requires brazing, all of the refrigerant shall be recovered from the system, or isolated (by means of shut off valves) in a part of the system remote from the leak. For appliances containing flammable refrigerants, oxygen free nitrogen (OFN) shall then be purged through the system both before and during the brazing process.</p>	
<p>8. Removal and evacuation</p> <p>! When breaking into the refrigerant circuit to make repairs-or for any other purpose-conventional procedures shall be used. However, it is important that best practice is followed since flammability is a consideration. The following procedure shall be adhered to:</p> <p>• remove refrigerant;</p> <p>• purge the circuit with inert gas;</p> <p>• evacuate;</p> <p>• purge again with inert gas;</p> <p>• open the circuit by cutting or brazing.</p> <p>! The refrigerant charge shall be recovered into the correct recovery cylinders.</p> <p>! The system shall be “flushed” with OFN to render the unit safe. This process may need to be repeated several times.</p> <p>• Compressed air or oxygen shall not be used for purging refrigerant systems.</p> <p>• Flushing shall be achieved by breaking the vacuum in the system with OFN and continuing to fill until the working pressure is achieved, then venting to atmosphere, and finally pulling down to a vacuum.</p> <p>• This process shall be repeated until no refrigerant is within the system.</p> <p>• When the final OFN charge is used, the system shall be vented down to atmospheric pressure to enable work to take place.</p> <p>• This operation is absolutely vital if brazing operations on the pipe-work are to take place.</p> <p>• Ensure that the outlet for the vacuum pump is not close to any ignition sources and that ventilation is available.</p>	

9. Charging procedures

- In addition to conventional charging procedures, the following requirements shall be followed.
  - Ensure that contamination of different refrigerants does not occur when using charging equipment.
  - Hoses or lines shall be as short as possible to minimize the amount of refrigerant contained in them.
  - Cylinders shall be kept upright.
  - Ensure that the refrigeration system is earthed prior to charging the system with refrigerant.
  - Label the system when charging is complete (if not already).
  - Extreme care shall be taken not to over fill the refrigeration system.
- Prior to recharging the system it shall be pressure tested with OFN (refer to “7. Leak detection methods” on page 1-11-1-4).
- The system shall be leak tested on completion of charging but prior to commissioning.
- A follow up leak test shall be carried out prior to leaving the site.
- Electrostatic charge may accumulate and create a hazardous condition when charging and discharging the refrigerant.  
To avoid fire or explosion, dissipate static electricity during transfer by grounding and bonding containers and equipment before charging/discharging.



10. Decommissioning

- Before carrying out this procedure, it is essential that the technician is completely familiar with the equipment and all its detail.
- It is recommended good practice that all refrigerants are recovered safely.
- Prior to the task being carried out, an oil and refrigerant sample shall be taken in case analysis is required prior to re-use of reclaimed refrigerant.
- It is essential that electrical power is available before the task is commenced.
  - a) Become familiar with the equipment and its operation.
  - b) Isolate system electrically.
  - c) Before attempting the procedure ensure that:
 

- mechanical handling equipment is available, if required, for handling refrigerant cylinders;
    - all personal protective equipment is available and being used correctly;
    - the recovery process is supervised at all times by a competent person;
    - recovery equipment and cylinders conform to the appropriate standards.
  - d) Pump down refrigerant system, if possible.
  - e) If a vacuum is not possible, make a manifold so that refrigerant can be removed from various parts of the system.
  - f) Make sure that cylinder is situated on the scales before recovery takes place.
  - g) Start the recovery machine and operate in accordance with manufacturer’s instructions.
  - h) Do not overfill cylinders. (No more than 80 % volume liquid charge).
  - i) Do not exceed the maximum working pressure of the cylinder, even temporarily.
  - j) When the cylinders have been filled correctly and the process completed, make sure that the cylinders and the equipment are removed from site promptly and all isolation valves on the equipment are closed off.
  - k) Recovered refrigerant shall not be charged into another refrigeration system unless it has been cleaned and checked.
- Electrostatic charge may accumulate and create a hazardous condition when charging or discharging the refrigerant. To avoid fire or explosion, dissipate static electricity during transfer by grounding and bonding containers and equipment before charging/discharging.



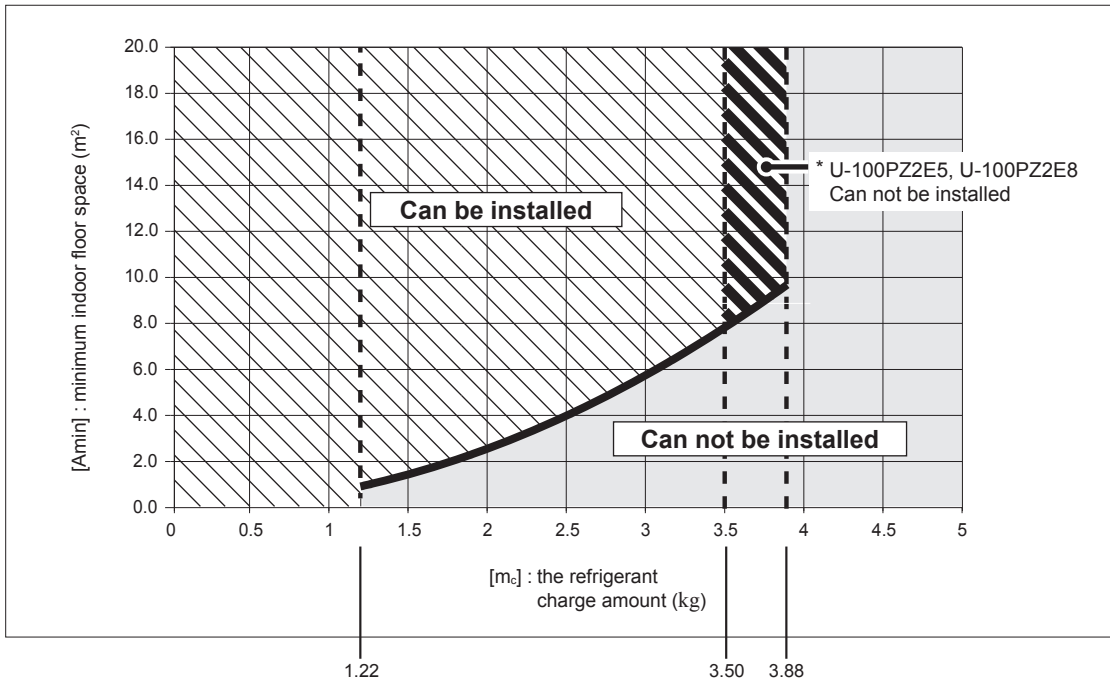
<p>❗</p>	<p>11. Labelling</p> <ul style="list-style-type: none"> <li>• Equipment shall be labelled stating that it has been de-commissioned and emptied of refrigerant.</li> <li>• The label shall be dated and signed.</li> <li>• Ensure that there are labels on the equipment stating the equipment contains flammable refrigerant.</li> </ul>
<p>❗</p>	<p>12. Recovery</p> <ul style="list-style-type: none"> <li>• When removing refrigerant from a system, either for servicing or decommissioning, it is recommended good practice that all refrigerants are removed safely.</li> <li>• When transferring refrigerant into cylinders, ensure that only appropriate refrigerant recovery cylinders are employed.</li> <li>• Ensure that the correct number of cylinders for holding the total system charge are available.</li> <li>• All cylinders to be used are designated for the recovered refrigerant and labelled for that refrigerant (i.e. special cylinders for the recovery of refrigerant).</li> <li>• Cylinders shall be complete with pressure-relief valve and associated shut-off valves in good working order.</li> <li>• Empty recovery cylinders are evacuated and, if possible, cooled before recovery occurs.</li> <li>• The recovery equipment shall be in good working order with a set of instructions concerning the equipment that is at hand and shall be suitable for the recovery of all appropriate refrigerants including, when applicable, flammable refrigerants.</li> <li>• In addition, a set of calibrated weighing scales shall be available and in good working order.</li> <li>• Hoses shall be complete with leak-free disconnect couplings and in good condition.</li> <li>• Before using the recovery machine, check that it is in satisfactory working order, has been properly maintained and that any associated electrical components are sealed to prevent ignition in the event of a refrigerant release. Consult manufacturer if in doubt.</li> <li>• The recovered refrigerant shall be returned to the refrigerant supplier in the correct recovery cylinder, and the relevant waste transfer note arranged.</li> <li>• Do not mix refrigerants in recovery units and especially not in cylinders.</li> <li>• If compressors or compressor oils are to be removed, ensure that they have been evacuated to an acceptable level to make certain that flammable refrigerant does not remain within the lubricant.</li> <li>• The evacuation process shall be carried out prior to returning the compressor to the suppliers.</li> <li>• Only electric heating to the compressor body shall be employed to accelerate this process.</li> <li>• When oil is drained from a system, it shall be carried out safely.</li> </ul>

## CHECK OF DENSITY LIMIT

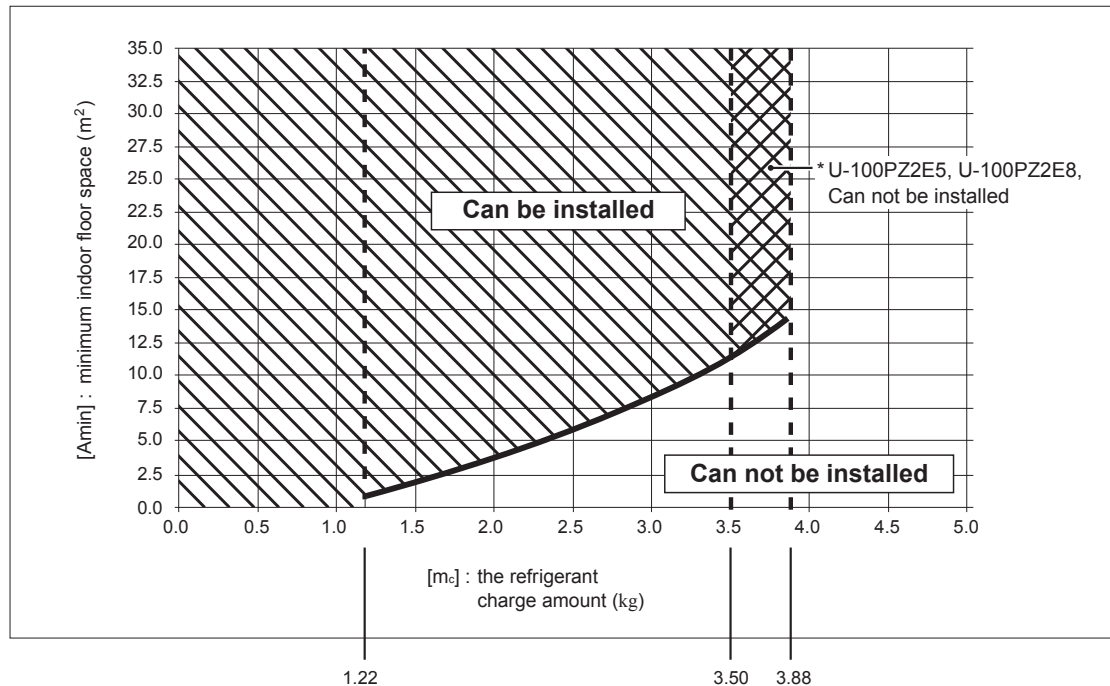
The refrigerant (R32), which is used in the air conditioner, is a flammable refrigerant. So the requirements for installation space of appliance are determined according to the refrigerant charge amount [m<sub>c</sub>] used in the appliance.

The minimum indoor floor space compared with the amount of refrigerant is roughly as follows:

### [ Type U2, T2, F1 ]



### [ Type K2 ]



[m<sub>c</sub>] : The refrigerant charge amount (Total of refrigerant at shipment and refrigerant charge amount in the field).

[m<sub>max</sub>] : Maximum refrigerant charge amount

	U-100PZ2E5 U-100PZ2E8	U-125PZ2E5 U-125PZ2E8	U-140PZ2E5 U-140PZ2E8
[m <sub>max</sub> ]	3.50	3.88	3.88



[m<sub>c</sub>] ≤ 1.22 : Can be installed

1.22 < [m<sub>c</sub>] ≤ [m<sub>max</sub>] : Installation possible with in the range of slanted line part

[m<sub>c</sub>] > [m<sub>max</sub>] : Can not be installed

## 1. ACCESSORIES SUPPLIED WITH OUTDOOR UNIT

The following parts are supplied as accessories with each outdoor unit. Check that all accessory parts are present before installing the outdoor unit.

Part name	Q'ty	Diagram	Application
Protective bushing	2		For protecting electrical wires
Banding strap	4		For tying electrical wires together

Part name	Q'ty	Diagram	Application
Installation Instruction	1	SIZE:A3	CONNECTION FOR DEMAND AND FORCED STOP
Installation Instruction	—	—	This manual

**!** Please install according to Warning and Caution on pages from 1-11-1-1 to 1-11-1-6.

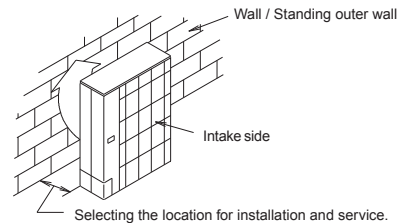
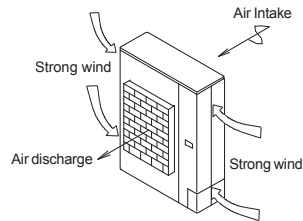
## 2. SELECT THE OUTDOOR UNIT INSTALLATION LOCATION



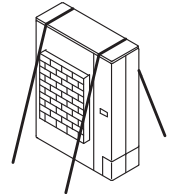
### Warning

Be careful when picking up and moving the indoor and outdoor units. Get a partner to help, and bend your knees when lifting to reduce strain on your back. Sharp edges or thin aluminum fins on the air conditioner can cut your fingers.

- Install the unit once you have checked that the installation location matches the following conditions.
  - A location with sufficient ventilation.
  - Possibly a location that is sheltered from rain or direct sunlight and is well-ventilated so that hot and cool air does not build up.
  - A location where the area around the discharge is not exposed to animals or plants which could adversely affect the release of hot or cool air from the unit.
  - A location where the discharge and operation noise will not be a nuisance to the neighbours.
  - A location that can support the product's weight or vibrations and secured for horizontal installation wherever possible.
  - A location that does not obstruct the air discharge or intake.
  - A location where there is no danger of flammable or corrosive gas leaks.
  - A location that provides space for installation and service.
  - A location that allows the pipe and cable length fixture for internal and external connections.
  - It may need two or more people to carry out the installation work.
- Refer to the diagram below for the installation location which is exposed to strong wind.
  - If a strong wind of more than 5 m/sec blows to the area directly in front of the discharge, the outdoor unit's air flow is reduced and the outflow may re-enter (short circuit) causing the following outcome:  
"Reduced capacity", "Increased frost formation during heating" or "Operation stopped due to increased pressure".  
Should an exceptionally strong wind blow to the area directly in front of the discharge of the outdoor unit; there is the risk of damage due to the fan's high-speed reverse rotation.
  - If the direction of the prevailing wind is known when operating the unit, place the unit at an appropriate angle to the wind's direction so that the discharge faces towards a building or a wall.



- If installing at locations prone to snowfall, install the unit as high as possible with suitable roofing which shelters the unit from snow.
- Avoid installing the unit in locations where there are petroleum products (such as machine oil), saline content (such as coastal areas), sulphurous gas and where high frequency noise is generated.
- Place the indoor and outdoor unit, power cords and indoor/outdoor unit connection cables at a minimum distance of 1 meter or more away from televisions and radios. This is to avoid interference to picture and/or sound.  
(However, depending on the electromagnetic waves, noise interference may still occur even with the 1 meter separation.)
- For restaurants and kitchens, avoid installing at locations which draws oil and steam. Plastic parts can deteriorate from droplets of oil and steam or it can cause falling parts or water leakage.
- Avoid installing at the location where cutting oil mist or iron powder is present.
- If there is an immense voltage fluctuation due to the location's problem, ensure to split the power supply.
- When installing the product in a place where it will be affected by typhoon or strong wind such as wind blowing between buildings, including the rooftop of a building and a place where there is no building in surroundings, fix the product with an overturn prevention wire, etc.
- Ensure to assign several people or use a mechanical lift, etc. to transport the unit.



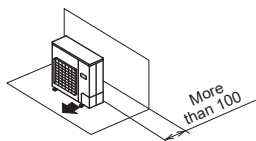
### 3. SELECTING THE LOCATION FOR INSTALLATION SERVICE

Please secure necessary space to guarantee performance and service & maintenance.

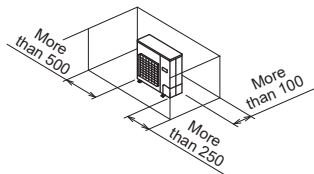
For multiple installations, please secure enough space to enable removal of side face screws between units. (unit:mm)

(A) If there are obstacles at the intake

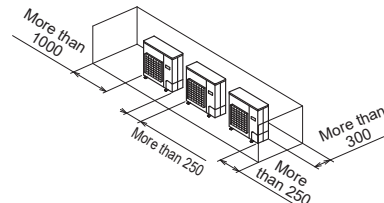
- If the upper part is open
  - 1 For separate installation location
    - Only if there are obstacles at the intake



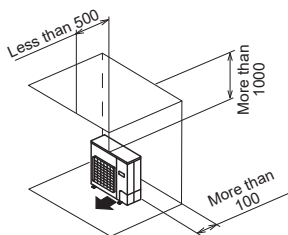
- If there are obstacles on both sides



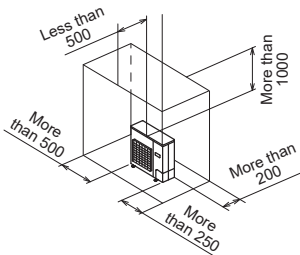
- 2 For multiple units (more than 2 units)
  - If there are obstacles on both sides



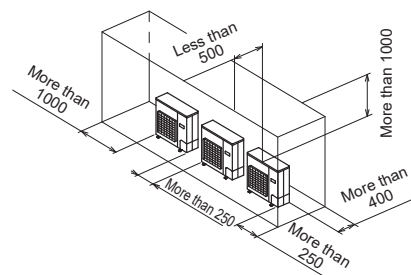
- If there are obstacles above the unit
  - 1 For separate installation location
    - Only if there are obstacles at the intake



- If there are obstacles on the intake and the other side



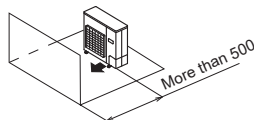
- 2 For multiple units (more than 2 units)
  - If there are obstacles on both sides



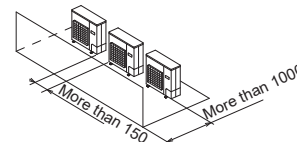
(B) If there are obstacles at the discharge

- If the upper part is open

- 1 For separate installation location

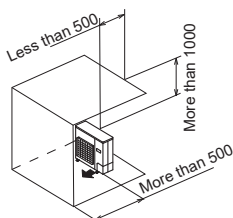


- 2 For multiple units (more than 2 units)

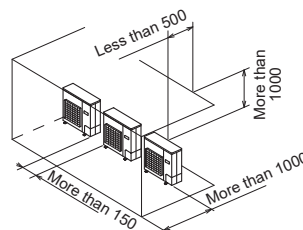


- If there are obstacles above the unit

- 1 For separate installation location



- 2 For multiple units (more than 2 units)

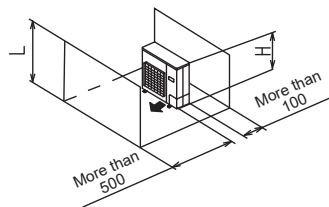


(C) If there are obstacles on both the intake and discharge

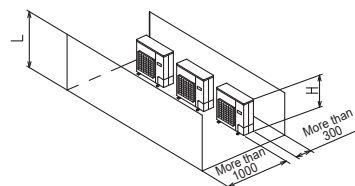
**Pattern 1** If there is an obstacle that is higher than the unit on the intake side. (There is no limit to the height of the obstacle above the discharge.)

- If the upper part is open

- 1 For separate installation location



- 2 For multiple units (more than 2 units)



L > H

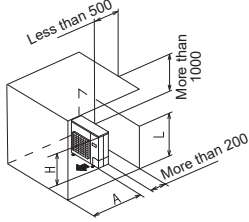
- If there are obstacles above the unit

1 For separate installation location

- The dimensions for H, A and L are shown in the following table.

	L	A
L ≤ H	0 < L ≤ 1/2 H	500
	1/2H < L ≤ H	750
H < L	Install a pedestal or mount so that L ≤ H	

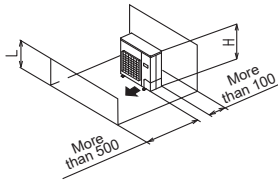
- Cover the bottom part of the pedestal or mount so that air does not go through it.



**Pattern 2** If there is an obstacle that is higher than the unit on the discharge side. (There is no limit to the height of the obstacle above the discharge.)

- If the upper part is open

1 For separate installation location



L ≤ H

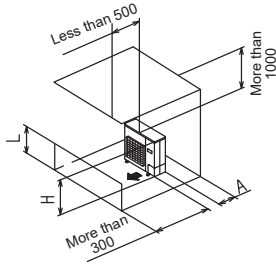
- If there are obstacles above the unit

1 For separate installation location

- The dimensions for H, A and L are shown in the following table.

	A
L ≤ H	100
H < L	Install a pedestal or mount so that L ≤ H

- Cover the bottom part of the pedestal or mount so that air does not go through it.

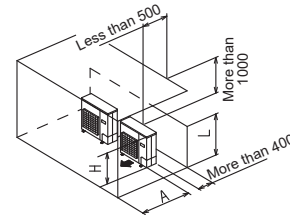


2 For multiple units (up to 2 units)

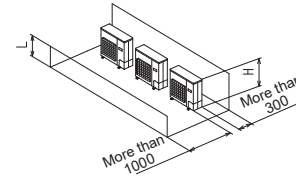
- The dimensions for H, A and L are shown in the following table.

	L	A
L ≤ H	0 < L ≤ 1/2 H	1000
	1/2H < L ≤ H	1250
H < L	Install a pedestal or mount so that L ≤ H	

- Cover the bottom part of the pedestal or mount so that air does not bypass it.
- A limit of only 2 units can be installed.



2 For multiple units (more than 2 units)

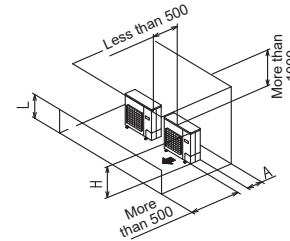


2 For multiple units (up to 2 units)

- The dimensions for H, A and L are shown in the following table.

	A
L ≤ H	400
H < L	Install a pedestal or mount so that L ≤ H

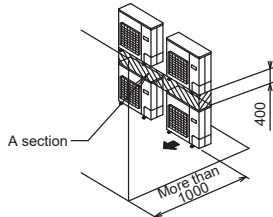
- Cover the bottom part of the pedestal or mount so that air does not bypass it.
- A limit of only 2 units can be installed.



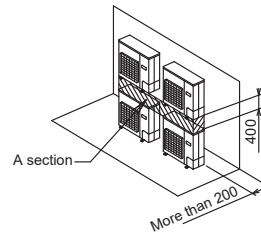
(D) Stacking installation setup

- Stack up to 2 tiers.
- A dimension of approximately 400 mm is required for the second tier outdoor unit's drain pipe and space for maintenance of the first tier outdoor unit.
- Close A section (the space between the upper and lower level outdoor units) so the outtake air does not bypass it.

1 If there are obstacles at the discharge

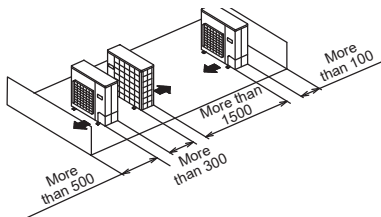


2 If there are obstacles at the intake



(E) For multiple row installation (on the roof, etc.)

1 For one row installation setup

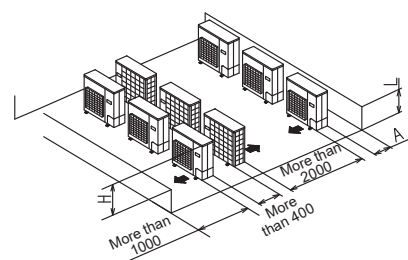


- The dimensions for H, A and L are shown in the following table.

	A
L ≤ H	300
H < L	Installation not possible

- The above mentioned distance is required for optimal unit performance. Allow as much space as possible in order to obtain the best performance from the units.

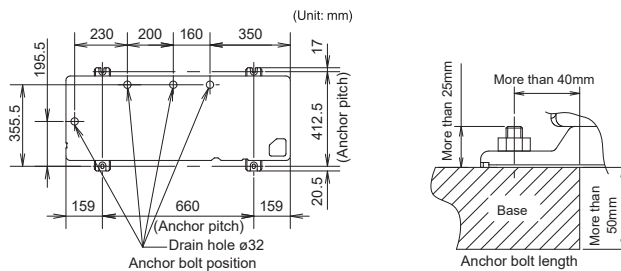
2 For multiple units (more than 2 units)





#### 4. TRANSPORT AND INSTALL THE OUTDOOR UNIT

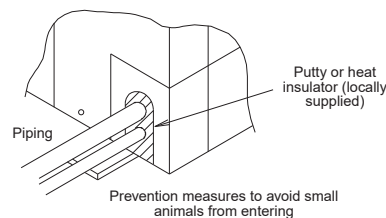
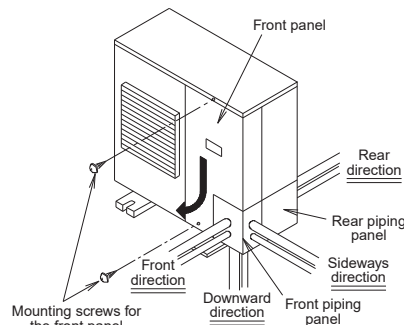
- Transporting
  1. Transport the outdoor unit in its original packaging as close as possible to the installation location.
  2. In the event that the unit needs to be lifted or suspended, use a rope or belt and use cloth or wood as padding to avoid damaging the unit.
  3. Use the side handles to carry the unit and be careful not to touch the fan with your hand or any objects.
- Installation
  1. Read the "Select the outdoor unit installation location" thoroughly before installing the outdoor unit.
  2. When installing to a concrete or solid surface, use M10 or a W 3/8 bolts and nuts to secure the unit. Ensure that it installed upright on a horizontal plane. (Use an anchor bolt for the installation as shown in the diagram below.)
  3. Avoid installing on the slanted roof.
  4. In the even where the roof is at risk of receiving oscillations or vibrations, secure the unit with a seismic isolating mount or vibration absorbing rubber.
  5. The drain water will be discharged from the unit during heating or defrosting operation mode.  
Select an appropriate location with good drainage system. (In the winter, there is risk of slipping due to freezing, and depending on the installation set up there is risk of drain water running overhead.)



#### 5. REFRIGERANT INSTALLATION

For indoor unit refrigerant piping installation, refer to the installation instruction manual that comes with that indoor unit. Do not reuse existing piping, install new piping.

1. Precautions during refrigerant installation.
  - Use clean pipes with no dust inside.  
The pipe may corrode with the presence of fluorine dust which will adversely affect the refrigerant piping system due to deterioration of the refrigerant oil, etc.
  - This unit is specifically for R32. Ensure to adhere to the following items and install accordingly:
    - Use pipe cutters and flaring tools which are specially designed for use with R32.
    - When connecting with flaring tools, coat the flare section with ether-based oil.
    - Ensure to use flare nuts supplied with the unit when connecting this unit.
    - Only for storing or for open pipes.
    - Set the lower limit of the allowable pipe length to 5m.  
If the pipe is shorter than 5m, the refrigerant may become overfilled and a problem such as abnormal high pressure could occur.
    - Carefully handle the liquid refrigerant, as it may cause a frostbite.
    - Do not release refrigerants during the piping works for installing, re-installing and repairing refrigeration parts.
2. The local pipes can protrude from any four directions.
  - Make holes in the pipe panel for the pipes to penetrate it and lay the pipes accordingly.
    - It is recommended to apply additional substance to the cut area for anti-rust protection.
  - Ensure to install pipe panels to prevent rain water from getting into the unit.
  - Close the gap at the pipe connected area with putty or heat insulator (locally supplied).
    - If an insect or small animal enters the outdoor unit, there is the risk of shorting in the product electronic casing.  
[Remove the front panel]
    - (1) Remove the 2 mounting screws.
    - (2) Slide the front panel using your hands downwards to release the pawls.  
Then remove by pulling the panel towards you.

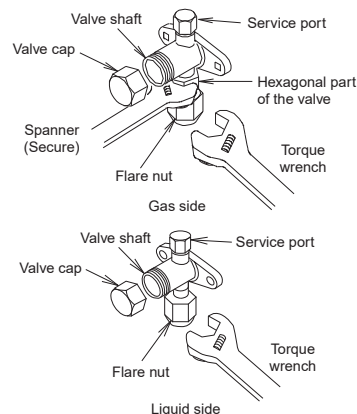


Specification for pipe connecting indoor unit to outdoor unit.

	U-100	U-125/140
Maximum pipe length	50m	
Height difference	Outdoor located higher installation	30m
	Outdoor located lower installation	15m
Charge-less pipe length	5-30m	
Additional charge per 1 m	45g/m	
Refrigerant charged at shipment	2.60kg	2.98kg
Total refrigerant amount	3.50kg	3.88kg

#### Precautions when operating the 3-way valve for piping installation

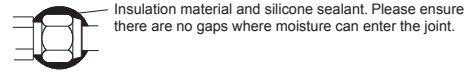
- Do not open the 3-way valve until the piping installation is completed.
  - It is closed during shipment.
  - During installation the side panel may warp if only the flare nut is loosened and tightened with a torque wrench. As a result, always be sure to secure to the hexagonal part of the 3-way valve with a spanner, or other tool.
- Refer to the following table for the tightening torque of the 3-way valve flare nuts.
- If the nuts are over tightened, they may cause the flares to break or leak.
- Do not add additional force to the valve's cover.
  - Using spanners on the cover or valve itself (other than the hexagonal parts) may cause gas leakage.  
Avoid using spanners on the cover or parts other than the hexagonal part of the valve.



(Please use a single, open-end spanner to loosen and tighten the liquid side 3-way valve flare nut.)

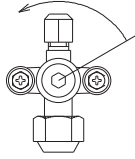
**!** Ensure to do the re-flaring of pipes before connecting to units to avoid leaking.

To prevent the ingress of moisture into the joint which could have the potential to freeze and then cause leakage, the joint must be sealed with suitable silicone and insulation material. The joint should be sealed on both liquid and gas side.



Silicone Sealant must be neutral cure and ammonia free. Use of silicon containing ammonia can lead to stress corrosion on the joint and cause leakage.

[3-way valve operation method] • Use an Allen wrench (Size 4 mm or 6 mm).  
Direction to open



Opening : Open the cover and turn the Allen wrench counter-clockwise until it stops.  
Closing : Open the cover and turn the Allen wrench clockwise until it stops.

**Precautions for handling the valve cap**

- Ensure not to scratch the inner surface of the valve or the end of the valve shaft.
- Once adjustments to the valve are completed, ensure to tighten the valve cap according to the prescribed torque.

**Precautions for handling the service ports**

- Use a push-rod with a charge hose.
- Once adjustments to the valve are completed, ensure to tighten the valve cap according to the prescribed torque.

**Precautions for connecting the pipes**

- For proper connection, align the union and flare straight with each other.
- Ensure that the pipes do not come into contact with the compressor's bolts or exterior panel.
- There is a risk of condensation from the 3-way valve coming out between the insulation material and the indoor unit's piping when you install the outdoor unit above then the indoor unit. Ensure to caulk the connection parts.

**Precautions for insulation installation**

**Maximum temperature limit of gas or liquid piping exceeds 120 °C**

- In high humidity environment, reinforce the insulation material for the refrigerant piping. Failure to do so may result in condensation on the surface of the insulation material.
- Use materials with good heat-resistant properties as the heat insulator for the pipes. Ensure to insulate both the gas side and liquid side pipes.
- If the pipes are not adequately insulated, condensation and water leakages may occur.
- Ensure that the current insulation covers the pipes up to the unit's connecting part.
- If the piping is exposed, it may cause condensation or burn (when touch the pipe).

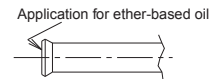
**Precautions for flare nut installation**

- Dimensions when adding flare nuts and the tightening torque

Piping size	Tightening torque (approx.)	Flare section dimensions A	Flare configuration
ø 6.35	14.0 N•m~18.0 N•m (140 kgf•cm~180 kgf•cm)	8.7 ~ 9.1 mm	
ø 9.52	34.0 N•m~42.0 N•m (340 kgf•cm~420 kgf•cm)	12.8 ~ 13.2 mm	
ø 12.7	49.0 N•m~55.0 N•m (490 kgf•cm~550 kgf•cm)	16.2 ~ 16.6 mm	
ø 15.88	68.0 N•m~82.0 N•m (680 kgf•cm~820 kgf•cm)	19.3 ~ 19.7 mm	

After piping connection has completed, ensure there is no gas leakage.

- When tightening the flare nut, coat the flares (inner surface only) with refrigerant oil on the flares. Firstly, screw in 3-4 turns by hand.
- **Refrigerant oil used is ether-based.**
- Once the piping connections are completed, perform leakage inspection using nitrogen gas.
- When flared joints are reused, the flare part shall be re-fabricated.



**6. LEAK TEST AND EVACUATION**

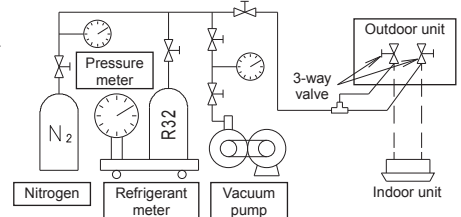
**Leak Tightness Test Method**

- Keep 3-way valve fully closed and pressurize through three-way valve service port.
- Do not pressurize to the default value at once. Pressurize gradually.
  - 1 Pressurize to 0.5MPa (5kgf/cm<sup>2</sup>G) and then leave it for 5 minutes to ensure that the pressure does not drop.
  - 2 Pressurize to 1.5MPa (15kgf/cm<sup>2</sup>G) and leave it for 5 minutes to ensure that the pressure does not drop.
  - 3 For the test, pressurize to 4.15MPa and leave it for about 1 day to ensure that the pressure does not drop.

**EVACUATION**

- Use a vacuum pump (with back-flow prevention device) to vacuum through the 3-way valve service port to achieve the pressure below -101kPa (5 Torr).
- Air and moisture remaining in the refrigerant system due to poor vacuum drying can cause performance decrement and malfunction of the compressor.

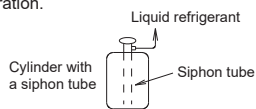
Use nitrogen gas for the leak tightness test. Using flammable gas can cause an explosion.



**7. REGARDING REFRIGERANT FILLING**

**Precautions during refrigerant filling**

- Ensure to fill only with liquid refrigerant when refilling. If gas refrigerant is filled, the refrigerant composition will not be balanced and will cause abnormal operation.



- Use tools that are designed specifically for R32, for pressure resistance and to prevent mixing impurities.
- Fill the refrigerant from the 3-way valve's service port on the liquid-side.

**For filling and replacing all refrigerant** (For refilling due to a leak)

- For refilling refrigerant, first collect all residual refrigerant and after vacuum dehydration using the vacuum pump. Refill the refrigerant according to the prescribed amount stated on the placard affixed to this unit.

**Precautions after the pipes' connection have completed**

- Ensure to open the 3-way valve after completing the piping installation, leak test and vacuuming. If it is closed during operation, it can lead to compressor failure.

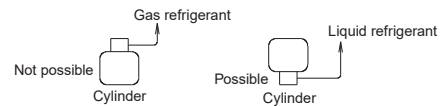
**Charging with refrigerant**

- At the time of shipment from the factory, this unit is charged with enough refrigerant for an equivalent pipe length of 30m. If the equivalent pipe length used will be 30m or less, no additional charging will be necessary.
- If the equivalent pipe length will be between 30 and 50m, charge with additional refrigerant according to the equivalent length given in the table below.
  - For standard type

	Additional charging amount	Equivalent length	Minimum length
U-100/125/140P	45 /m	50m	5m

- Pump down operation  
Please refer to "10. PRECAUTIONS REGARDING TEST RUN (Caution for Pump Down)" of this Installation instruction manual. It is also indicated on the label affixed to the outdoor unit.

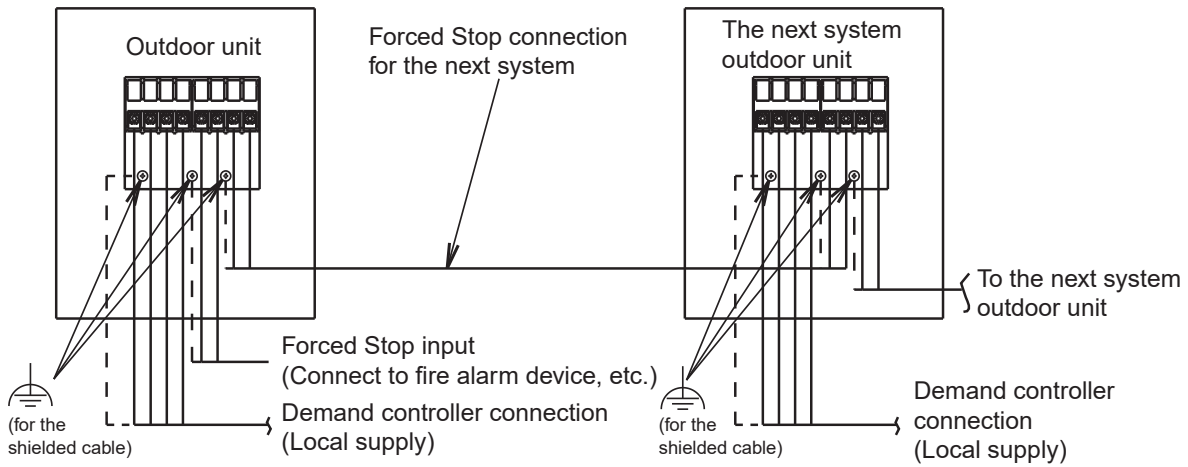
- If using cylinders as shown in the bottom left diagram; without a siphon tube inside, turn it upside down and use it. (It is recommended to use the manifold with the side glass.)



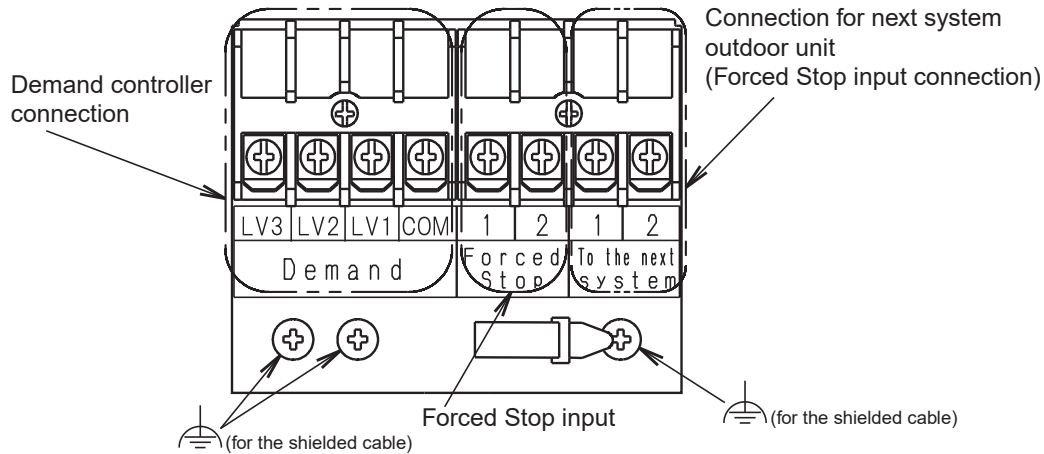
## CONNECTION FOR DEMAND AND FORCED STOP

### ■ CONNECTION PROCEDURE

Be sure to always turn the power off first when setting up the wire and cable connections. Failure to do so may lead to electric shock or unit failure.



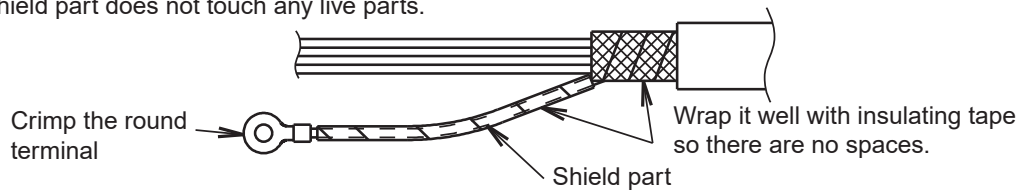
The demand terminal set up is shown in the following illustration.



- Use a shielded cable for the cable connection.

For the shield part of the shielded cable twist the end out, crimp it with a round terminal, and connect it to the functional earthing screw.

After crimping it with a round terminal, wrap it with insulating tape so there are no spaces and adjust it so the shield part does not touch any live parts.

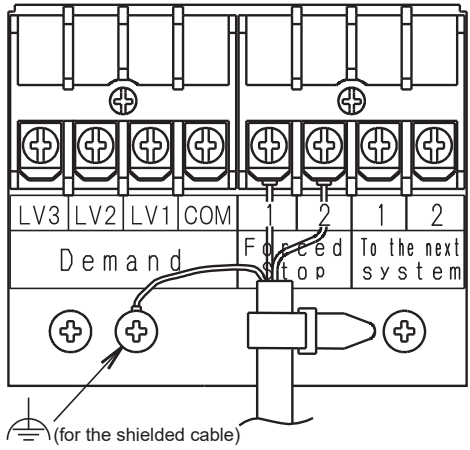


### ⚠ CAUTION

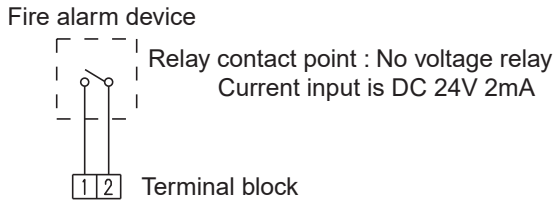
Be sure that the shield part of the shielded cable does not touch the terminal block or any live parts. Failure to do so may lead to electric shock or fire.

### WHEN CONNECTION TO THE FORCED STOP INPUT

With the Forced Stop input, it is possible to override the air conditioning operation to force a stop if a signal is received from a fire alarm device, etc.

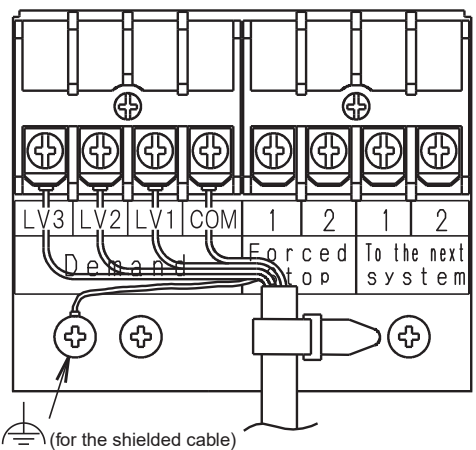


Connect the wiring (2-wire) to points 1 and 2 on the left side of the terminal block.  
The shield part of the shielded cable is connected with functional earthing under the terminal block.  
Secure the wiring with the cord clamp located on the lower part of the terminal block.



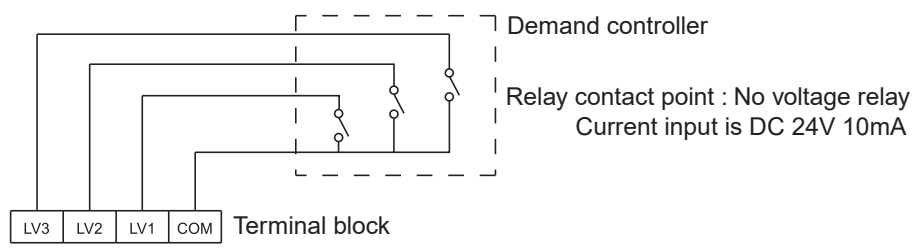
### WHEN CONNECTING THE DEMAND CONTROLLER INPUT

It is possible to choose various demand levels. Refer to the table below.



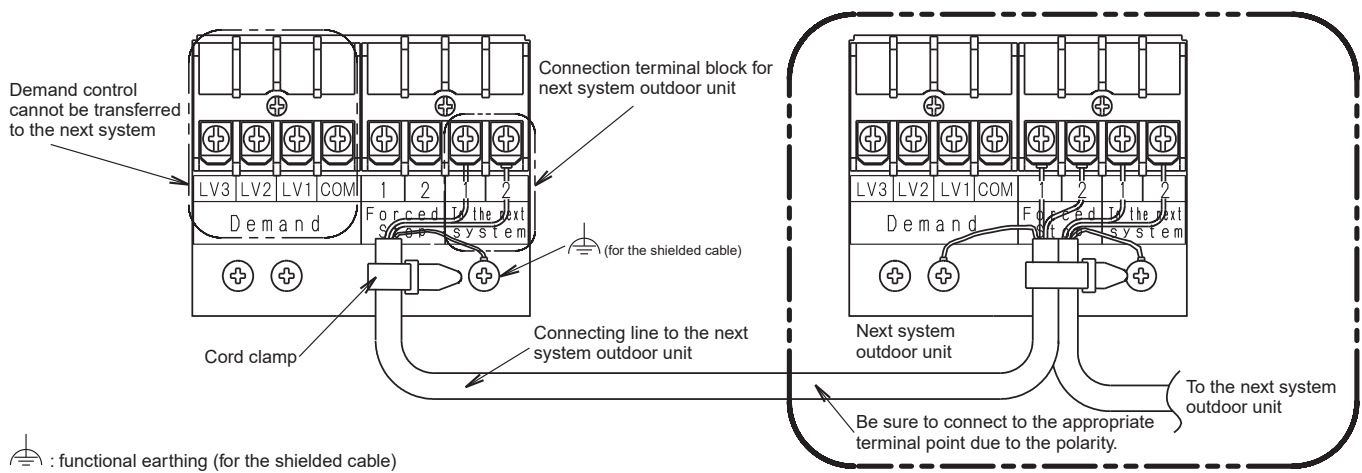
Terminal no. for demand section	Description
LV1	Approx. 75% of rated power input
LV2	Approx. 50% of rated power input
LV3	Compressor off

Connect the wiring (4-wire) to the Demand section (LV1, LV2, LV3, COM) on the terminal block.  
The shield part of the shielded cable is connected with functional earthing under the terminal block.  
Secure the wiring with the cord clamp located on the lower part of the terminal block.



## WHEN CONNECTING TO THE NEXT SYSTEM UNIT

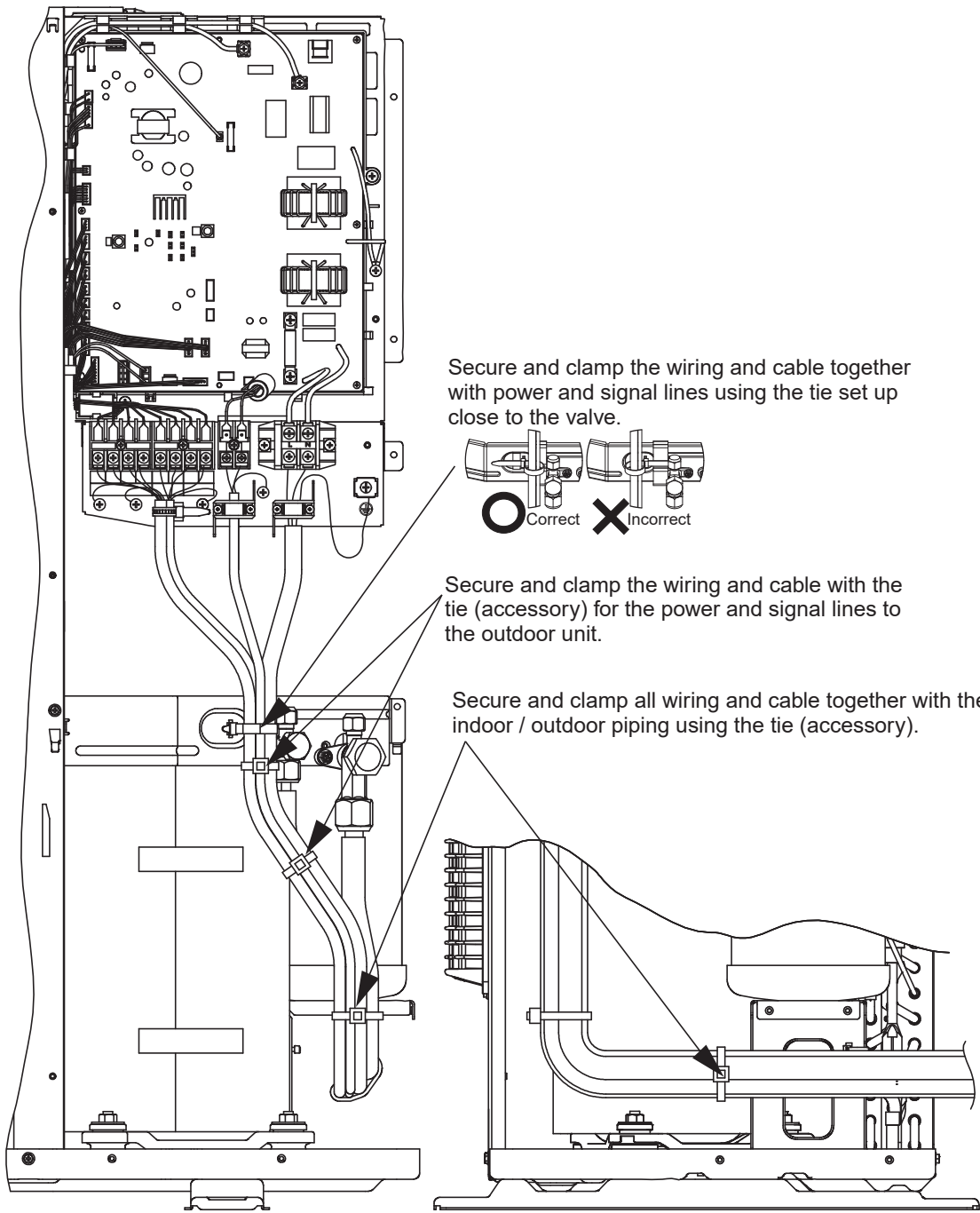
- Forced Stop input can be transferred to the next system unit.
  - When using the Forced Stop input, connect the wiring to the terminal points 1 and 2 on the right side of the lower part of the terminal block.
  - The maximum wire/cable length is 100 m.
  - The demand control cannot be transferred to the next system unit.
  - When transferring to the next system, the maximum number of connecting units is 30.
1. Connecting the wiring to the lower part of the terminal block.  
When transferring the Forced Stop input to the next system connect the wiring (2-wire) to the terminal points 1 and 2 at the lower right side of the terminal block.  
The shield part of the shielded cable is connected with functional earthing under the terminal block.  
Secure the wiring with the cord clamp located on the lower part of the terminal block.
  2. Connecting the shielded cable to the terminal block for the next system.  
For the Forced Stop input, connect the wiring to the terminal points 1 and 2 at the lower right side of the terminal block.  
When connecting to the next system be sure to connect to the appropriate terminal point due to the polarity.



## ■ WIRING PROCEDURE

Follow the wiring procedure below for the terminal connection.

1. Secure and clamp the power and signal lines with the tie, set up close to the valve.
2. Set the wiring and cables for the power and signal lines to the outdoor unit together, and secure each wire and cable with the tie.
3. Set up the wiring and cable for the outdoor unit piping and secure with a tie.



## ■ SELECTING THE INSTALLATION SITE

### 2. 4-Way Cassette Type (U2)

#### Indoor Unit

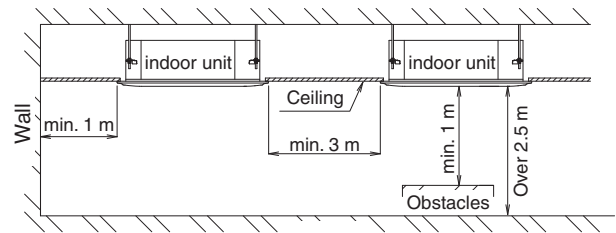
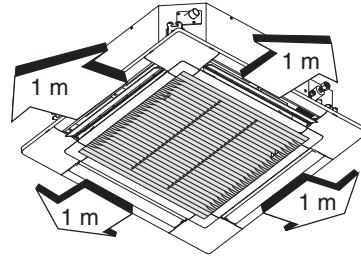
#### AVOID:

- areas where leakage of flammable gas may be expected.
- places where large amounts of oil mist exist.
- direct sunlight.
- locations near heat sources which may affect the performance of the unit.
- locations where external air may enter the room directly. This may cause “condensation” on the air discharge ports, causing them to spray or drip water.
- locations where the remote controller will be splashed with water or affected by dampness or humidity.
- installing the remote controller behind curtains or furniture.
- locations where high-frequency emissions are generated.

#### DO:

- select an appropriate position from which every corner of the room can be uniformly cooled.
- select a location where the ceiling is strong enough to support the weight of the unit.
- select a location where tubing and drain pipe have the shortest run to the outdoor unit.
- allow room for operation and maintenance as well as unrestricted air flow around the unit.
- the limitation of the tubing length between the indoor and the outdoor units should be referred to the Installation Instructions of the outdoor unit.
- allow room for mounting the remote controller about 1 m off the floor, in an area that is not in direct sunlight or in the flow of cool air from the indoor unit.

#### 4-Way Cassette Type





## ■ HOW TO INSTALL THE INDOOR UNIT

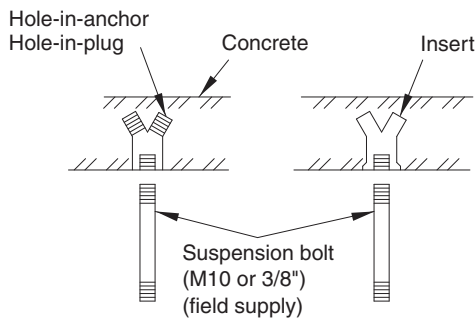
### Preparation for Suspending

This unit uses a drain pump. Use a carpenter's level to check that the unit is level.

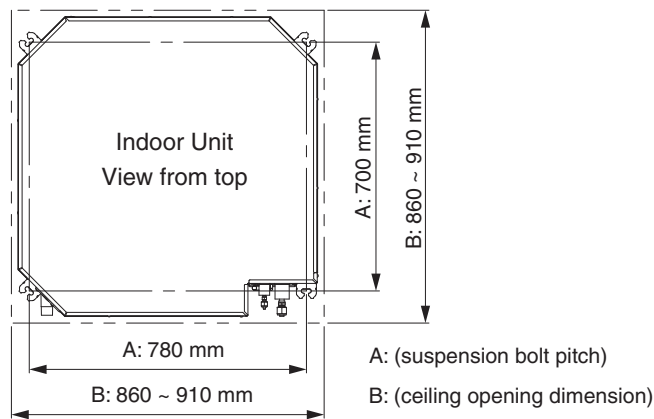
Note: For DC Fan Tap Change Procedure for 4-Way Cassette, see page 1-11-2-13.

### Suspending the Indoor Unit

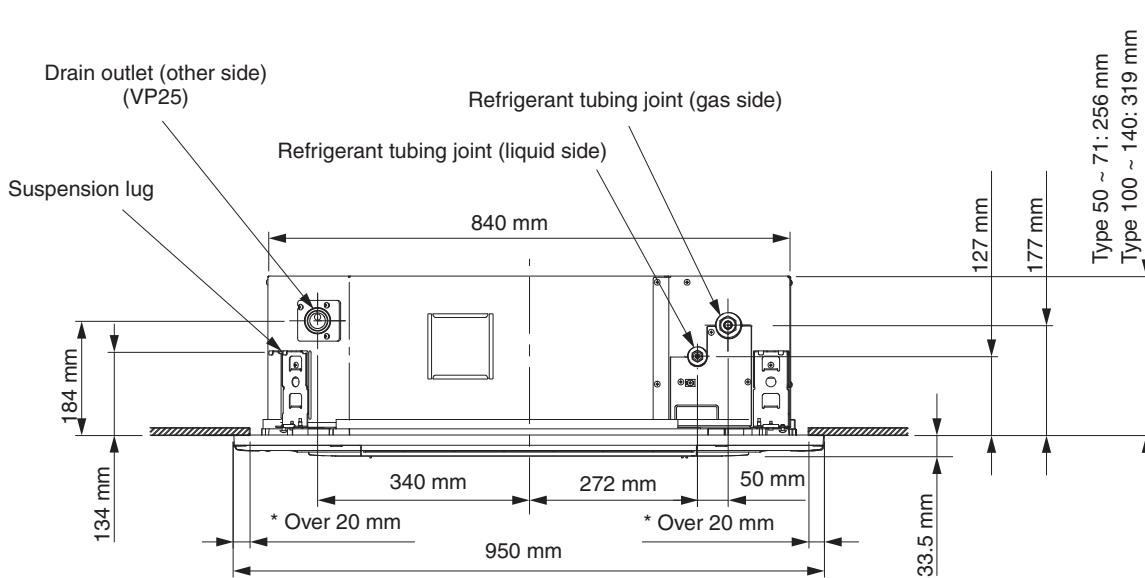
(1) Fix the suspension bolts securely in the ceiling using the method shown in the diagrams, by attaching them to the ceiling support structure, or by any other method that ensures that the unit will be securely and safely suspended.



(2) Follow the diagram to make the holes in the ceiling.



(3) Determine the pitch of the suspension bolts using the supplied full-scale installation diagram (printed on container box). The diagram show the relationship between the positions of the suspension fitting, unit, and panel. Use the nut (field supply) and washer (supplied) for upper and lower position of the suspension lug.



\* The overlapping portion between the ceiling and panel for cassette should be kept over 20 mm.

## Placing the Unit Inside the Ceiling

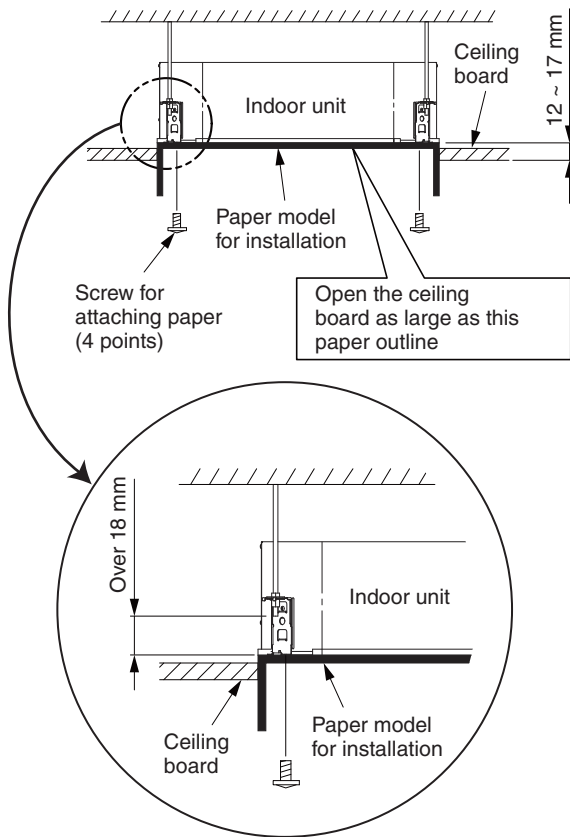
This unit is equipped with the drain pump. Check a tape measure or carpenter's level.

Before installing the panel for cassette, complete the work of drain pipe and refrigerant pipe installation.

- (1) When placing the unit inside the ceiling, determine the pitch of the suspension bolts using the supplied full-scale installation diagram.

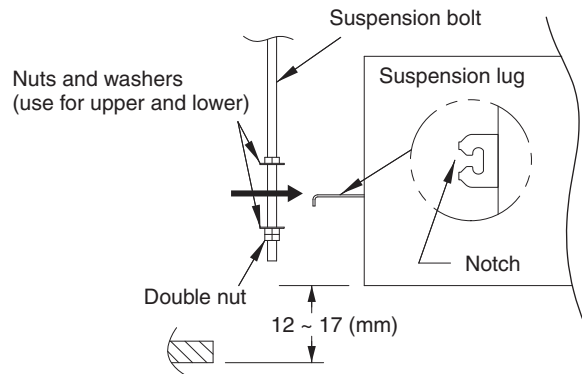
Tubing and wiring must be laid inside the ceiling when suspending the unit. If the ceiling is already constructed, lay the tubing and wiring into position for connection to the unit before placing the unit inside the ceiling.

- (2) The length of suspension bolts must be appropriate for a distance between the bottom of the bolt and the bottom of the unit of more than 18 mm.



Full-scale installation diagram  
(printed on top of container box)

- (3) Thread the 3 hexagonal nuts and 2 washers onto each of the 4 suspension bolts. Use 1 nut and 1 washer for the upper side, and 2 nuts and 1 washer for the lower side, so that the unit will not fall off the suspension lugs.



- (4) Adjust so that the distance between the unit and the ceiling bottom is 12 to 17 mm. Tighten the nuts on the upper side and lower side of the suspension lug.
- (5) Remove the protective polyethylene used to protect the fan parts during transport.
- (6) Check with a tape measure or carpenter's level.

## Installing the Drain Pipe

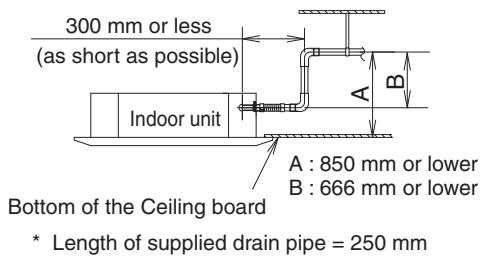
### Before Performing the Installation Drain Piping

#### (1) Limitations of Raising the Drain Pipe Connection



#### CAUTION

- The drain pipe can be raised to a maximum height of 850 mm from the bottom of the ceiling. Do not attempt to raise it higher than 850 mm. Doing so will result in water leakage.

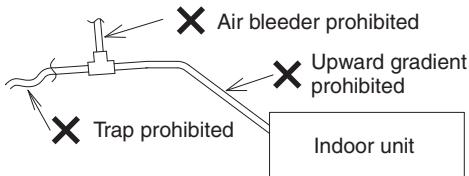


#### (2) Limitations of Drain Pipe Connection

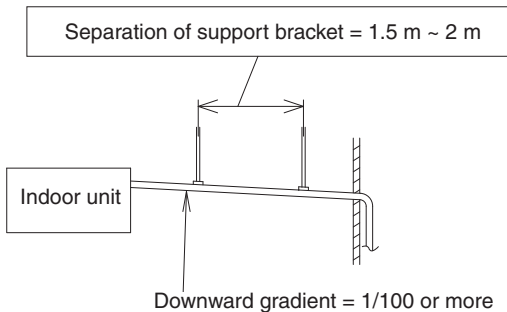


#### CAUTION

- Do not install the drain pipe with an upward gradient from the drain port connection. This will cause the drain water to flow backward and leak when the unit is not operating.
- Do not install an air bleeder as this may cause water to spray from the drain pipe outlet.
- Do not provide U-trap or bell-shaped trap in the middle of the drain pipe. Doing so will cause abnormal sound.



- Make sure the drain pipe has a downward gradient (1/100 or more; downward from drain port connection).

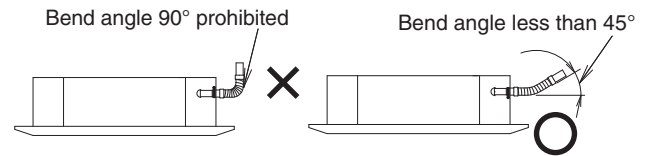


#### (3) Limitations of Drain Hose Connection

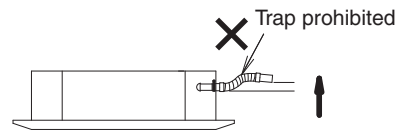


#### CAUTION

- Do not bend the supplied drain hose 90° or more. Bend it less than 45°.



- Do not make a trap in the middle of the supplied drain hose. Doing so will cause abnormal sound.



## Installing the Drain Pipe



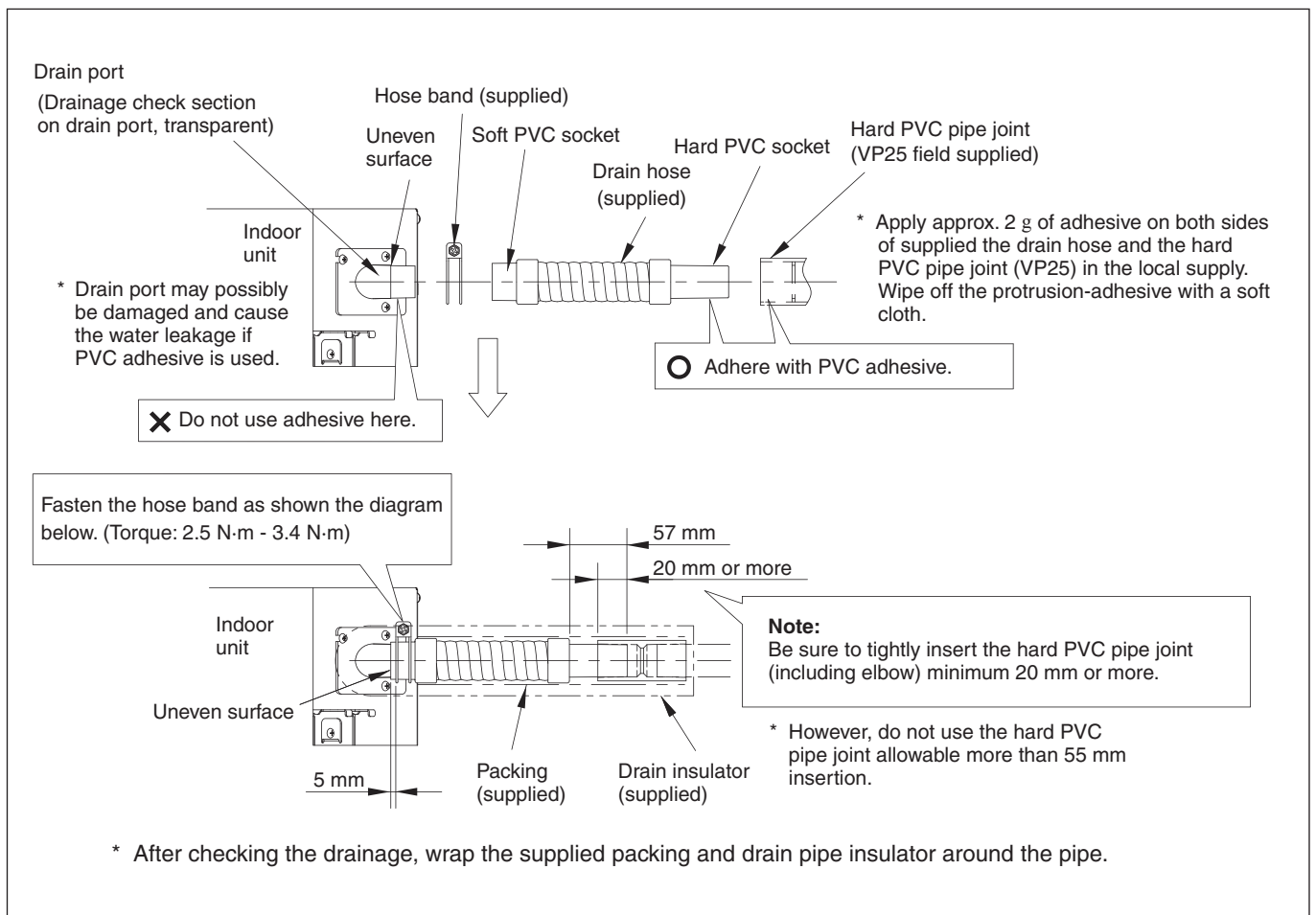
### CAUTION

- Do not apply force to the drain port when connecting the drain pipe. Install and fix it near the indoor unit as close as possible.
- Do not use adhesive when connecting the drain port pipe and the drain hose.

#### (1) How to Install the Drain Pipe

- 1) First insert the supplied hose band into the drain port pipe. Then make sure the head of the screw is facing toward a technical engineer when placing the screw of the hose band at an upward angle.
- 2) Insert the soft PVC socket of the supplied drain hose to the drain port pipe. Do not use adhesive when connecting the drain hose to the drain port pipe. Insert it until the tip of the drain hose contacts the uneven surface of the drain port pipe.

- 3) Move the hose band so that the center position of the hose band can be placed approx. 30 mm away from the external plate of the indoor unit. See diagram below.
- 4) Screw the drain hose tightly facing the screw of the hose band upward. (Torque: 2.5 N·m - 3.4 N·m) (If the screw is tightened beneath the drain hose, the troubles will be generated.)
- 5) Apply approx. 2 g of adhesive on both sides of the drain hose without connection of the hard PVC socket and the hard PVC pipe joint (VP25) in the local supply.
- 6) Connect the drain hose and the hard PVC pipe joint so that the adhesive area of both sides can be overlapped. Wipe off the protrusion-adhesive with a soft cloth.



## Checking the Drainage

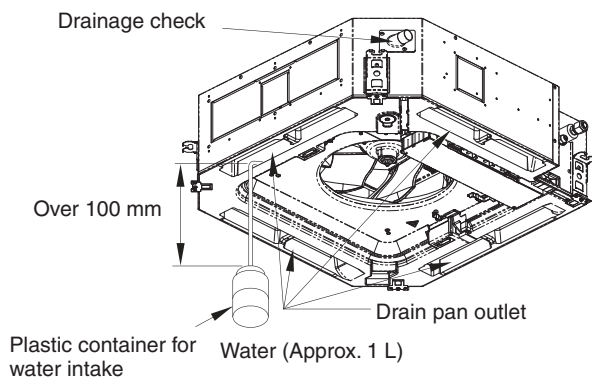


### CAUTION

Be careful since the fan will start when you short the pin on the indoor control board.

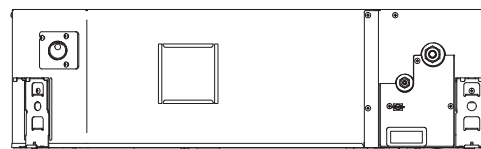
After wiring (refer to 1-10. Electrical Wiring.) and drain piping are completed, use the following procedure to check that the water will drain smoothly. For this, prepare a bucket and wiping cloth to catch and wipe up spilled water.

- (1) Connect power to the power terminal board (L, N terminals) inside the electrical component box.
- (2) Slowly pour about 1 L of water into the drain pan to check drainage.



- (3) Short the check pin (CHK) (6P : 5-6) on the indoor control board and operate the drain pump. Check the water flow through the transparent drain pipe and see if there is any leakage.
  - \* If the check pin (CHK) (6P:5-6) is shorted, the fan starts rotating at high speed and could cause injury.
- (4) When the check of drainage is complete, open the check pin (CHK) (6P : 5-6) and remount the tube cover.
- (5) Checkpoint after installation  
After installation of indoor and outdoor units, panels and electrical wiring, check the following items.

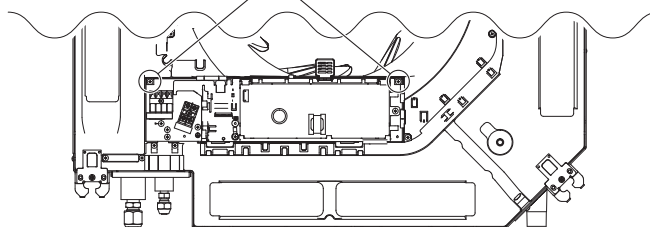
## Important Note for Wiring 4-Way Cassette Type



Power supply inlet

- (1) The power supply inlet is located at the lower area of the refrigerant tubing side of the unit. The electrical component box is located at the air intake of the bottom of the unit.
- (2) Before installing the panel for cassette, be sure to carry out the wiring connection.
- (3) Remove the lid located on the bottom of the indoor unit attaching the electrical component box by unscrewing the Phillips head tapping screws (x2).

Tapping screw position



- (4) Lead the wires from the power supply inlet to the unit. Be sure to lead the wires through the power supply inlet. Make sure that no wire is caught between the indoor unit and panel for cassette. Otherwise, the unit may cause a fire.
- (5) Connect the wires into the terminals through the power supply inlet for the electrical component box. Fix the wires with a clamping clip.
- (6) Reinstall the lid of the electrical component box in its original position with paying attention not to have the wires caught in the lid. Refer to "1-10. Electrical Wiring".

## ■ HOW TO PROCESS TUBING

Must ensure mechanical connections be accessible for maintenance purposes.

### Connecting the Refrigerant Tubing

#### NOTE

When connecting flare at indoor side, make sure that the flare connection is used only once. If torqued up and released, the flare must be remade. Once the flare connection was torqued up correctly and leak test was made, thoroughly clean and dry the surface to remove oil, dirt and grease by following instructions of silicone sealant. Apply neutral cure & ammonia-free silicone sealant that is non-corrosive to copper & brass to the external of the flared connection to prevent the ingress of moisture on both the gas & liquid sides. (Moisture may cause freezing and premature failure of the connection.)

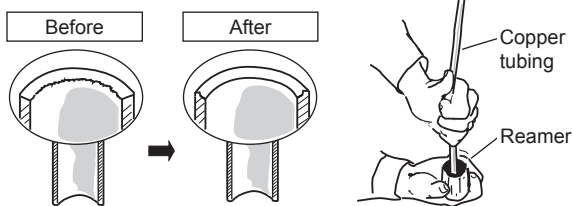
#### Use of the Flaring Method

Many of conventional split system air conditioners employ the flaring method to connect refrigerant tubes that run between indoor and outdoor units. In this method, the copper tubes are flared at each end and connected with flare nuts.

#### Flaring Procedure with a Flare Tool

- (1) Cut the copper tube to the required length with a tube cutter. It is recommended to cut approx. 30 – 50 cm longer than the tubing length you estimate.
- (2) Remove burrs at each end of the copper tubing with a tube reamer or a similar tool. This process is important and should be done carefully to make a good flare. Be sure to keep any contaminants (moisture, dirt, metal filings, etc.) from entering the tubing.

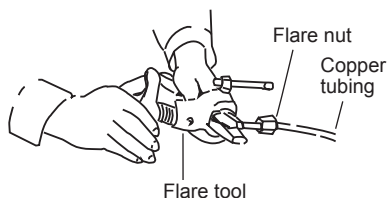
#### Deburring



#### NOTE

When reaming, hold the tube end downward and be sure that no copper scraps fall into the tube.

- (3) Remove the flare nut from the unit and be sure to mount it on the copper tube.
- (4) Make a flare at the end of the copper tube with a flare tool.



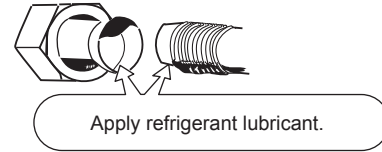
#### NOTE

When flared joints are reused, the flare part shall be re-fabricated. A good flare should have the following characteristics:

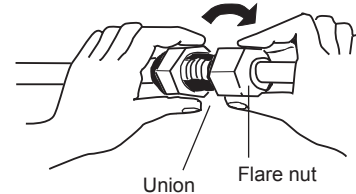
- inside surface is glossy and smooth
- edge is smooth
- tapered sides are of uniform length

#### Caution Before Connecting Tubes Tightly

- (1) Apply a sealing cap or water-proof tape to prevent dust or water from entering the tubes before they are used.
- (2) Be sure to apply refrigerant lubricant (ether oil) to the inside of the flare nut before making piping connections. This is effective for reducing gas leaks.



- (3) For proper connection, align the union tube and flare tube straight with each other, then screw on the flare nut lightly at first to obtain a smooth match.



- Adjust the shape of the liquid tube using a tube bender at the installation site and connect it to the liquid tubing side valve using a flare.

#### Connecting Tubing Between Indoor and Outdoor Units

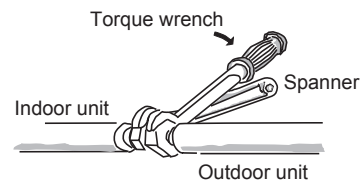
- (1) Tightly connect the indoor-side refrigerant tubing extended from the wall with the outdoor-side tubing.

#### Indoor Unit Tubing Connection ( $l_1, l_2 \dots l_{n-1}$ )

Indoor unit type	50	60	71	100	125	140
Gas tubing (mm)	ø12.7			ø15.88		
Liquid tubing (mm)	ø6.35			ø9.52		

- (2) To fasten the flare nuts, apply specified torque.

- When removing the flare nuts from the tubing connections, or when tightening them after connecting the tubing, be sure to use a torque wrench and a spanner. If the flare nuts are over-tightened, the flare may be damaged, which could result in refrigerant leakage and cause injury or asphyxiation to room occupants.



- For the flare nuts at tubing connections, be sure to use the flare nuts that were supplied with the unit, or else flare nuts for R410A, R32 (type 2). The refrigerant tubing that is used must be of the correct wall thickness as shown in the table below.

Tube diameter	Tightening torque (approximate)	Tube thickness
ø6.35 (1/4")	14 – 18 N · m {140 – 180 kgf · cm}	0.8 mm
ø9.52 (3/8")	34 – 42 N · m {340 – 420 kgf · cm}	0.8 mm
ø12.7 (1/2")	49 – 55 N · m {490 – 550 kgf · cm}	0.8 mm
ø15.88 (5/8")	68 – 82 N · m {680 – 820 kgf · cm}	1.0 mm

Because the pressure is approximately 1.6 times higher than conventional refrigerant R22 pressure, the use of ordinary flare nuts (type 1) or thin-walled tubes may result in tube rupture, injury, or asphyxiation caused by refrigerant leakage.

- In order to prevent damage to the flare caused by over-tightening of the flare nuts, use the table above as a guide when tightening.
- When tightening the flare nut on the liquid tube, use an adjustable wrench with a nominal handle length of 200 mm.

### Insulating the Refrigerant Tubing

#### Tubing Insulation

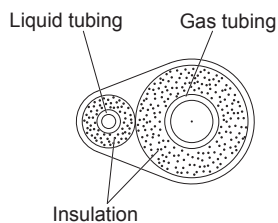
Must ensure that pipe-work shall be protected from physical damage.

- Thermal insulation must be applied to all units tubing, including distribution joint (field supply).
  - \* For gas tubing, the insulation material must be heat resistant to 120°C or above. For other tubing, it must be heat resistant to 80°C or above.

Insulation material thickness must be 10 mm or greater.

If the conditions inside the ceiling exceed DB 30°C and RH 70%, increase the thickness of the gas tubing insulation material by 1 step.

#### Two tubes arranged together

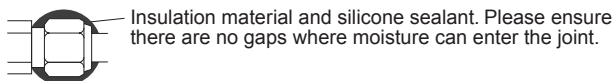


### CAUTION

If the exterior of the outdoor unit valves has been finished with a square duct covering, make sure you allow sufficient space to access the valves and to allow the panels to be attached and removed.

Ensure to do the re-flaring of pipes before connecting to units to avoid leaking.

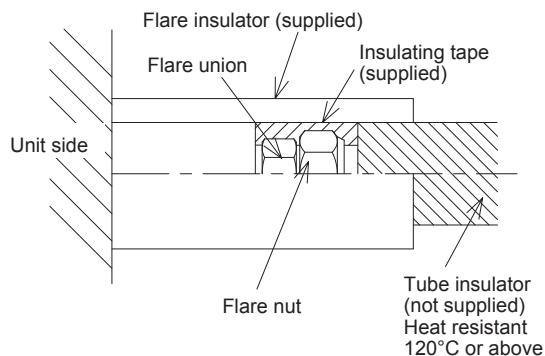
To prevent the ingress of moisture into the joint which could have the potential to freeze and then cause leakage, the joint must be sealed with suitable silicone and insulation material. The joint should be sealed on both liquid and gas side.



Silicone Sealant must be neutral cure and ammonia free. Use of silicon containing ammonia can lead to stress corrosion on the joint and cause leakage.

### Taping the flare nuts

Wind the white insulating tape around the flare nuts at the gas tube connections. Then cover up the tubing connections with the flare insulator, and fill the gap at the union with the supplied black insulating tape. Finally, fasten the insulator at both ends with the supplied vinyl clamps.



### Insulation material

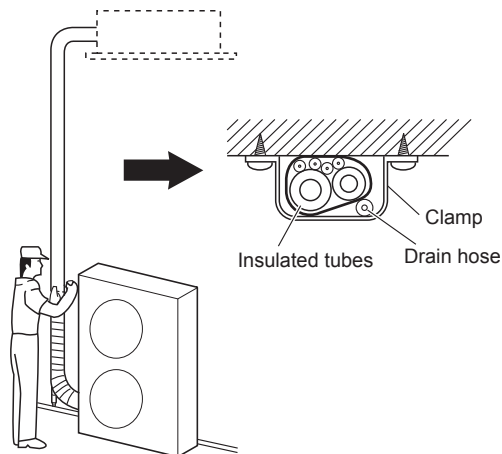
The material used for insulation must have good insulation characteristics, be easy to use, be age resistant, and must not easily absorb moisture.

### CAUTION

After a tube has been insulated, never try to bend it into a narrow curve because it can cause the tube to break or crack. Never grasp the drain or refrigerant connecting outlets when moving the unit.

### Taping the Tubes

- (1) At this time, the refrigerant tubes (and electrical wiring if local codes permit) should be taped together with armoring tape in 1 bundle. To prevent condensation from overflowing the drain pan, keep the drain hose separate from the refrigerant tubing.
- (2) Wrap the armoring tape from the bottom of the outdoor unit to the top of the tubing where it enters the wall. As you wrap the tubing, overlap half of each previous tape turn.
- (3) Clamp the tubing bundle to the wall, using 1 clamp approx. each meter.

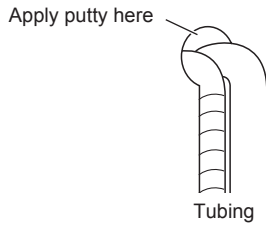


### NOTE

Do not wind the armoring tape too tightly since this will decrease the heat insulation effect. Also ensure that the condensation drain hose splits away from the bundle and drips clear of the unit and the tubing.

## Finishing the Installation

After finishing insulating and taping over the tubing, use sealing putty to seal off the hole in the wall to prevent rain and draft from entering.



### ■ HOW TO INSTALL THE TIMER REMOTE CONTROLLER OR HIGH-SPEC WIRED REMOTE CONTROLLER (OPTIONAL PART)

#### NOTE

See "Section 2. TEST RUN".

#### Accessories Supplied with Unit

##### (4-Way Cassette)

Part Name	Figure	Q'ty	Remarks
Full-scale installation diagram		1	Printed on container box
Washer		8	For suspension bolts
Screw		4	For full-scale installation diagram
Insulating tape		2	For gas and liquid tube flare nuts
Flare insulator		1	For liquid tube
Flare insulator		1	For gas tube
Drain hose		1	
Hose band		1	For securing drain hose

Part Name	Figure	Q'ty	Remarks
Packing		1	
Drain insulator		1	
Clamper		4	For electrical wiring
Operating Instructions		1	
Installation Instructions		1	

- Use M10 for suspension bolts.
- Field supply for suspension bolts and nuts.

#### Type of Copper Tube and Insulation Material

If you wish to purchase these materials separately from a local source, you will need:

1. Deoxidized annealed copper tube for refrigerant tubing.
2. Foamed polyethylene insulation for copper tubes as required to precise length of tubing. Wall thickness of the insulation should be not less than 8 mm.
3. Use insulated copper wire for field wiring. Wire size varies with the total length of wiring. See the section "1-10. Electrical Wiring" for details.



#### CAUTION

**Check local electrical codes and regulations before obtaining wire. Also, check any specified instructions or limitations.**

#### Additional Materials Required for Installation

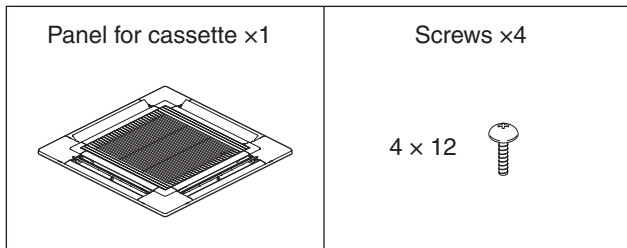
1. Refrigeration (armored) tape
2. Insulated staples or clamps for connecting wire (See your local codes.)
3. Putty
4. Refrigeration tubing lubricant
5. Clamps or saddles to secure refrigerant tubing
6. Scale for weighing



**4-Way Cassette Type (Type U2)**

**CZ-KPU3**

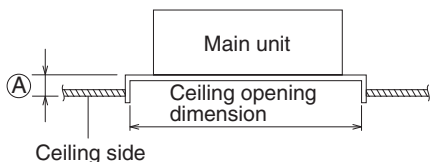
**Accessories**



**Preparation for Panel for Cassette Installation**

(1) Checking the unit position

- 1) Check that the ceiling hole is within this range:  
860 mm × 860 mm to 910 mm × 910 mm
- 2) Confirm that the position of the indoor unit and the ceiling as shown in the diagram. If the positions of the ceiling surface and unit do not match, air leakage, water leakage, flap operation failure, or other problems may occur.



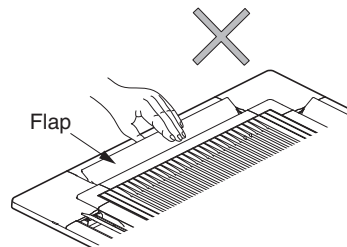
Ⓐ : Be sure to necessarily make a space within the range of 12 mm ~ 17 mm.

If not within this range, malfunction or other trouble may occur.



**CAUTION**

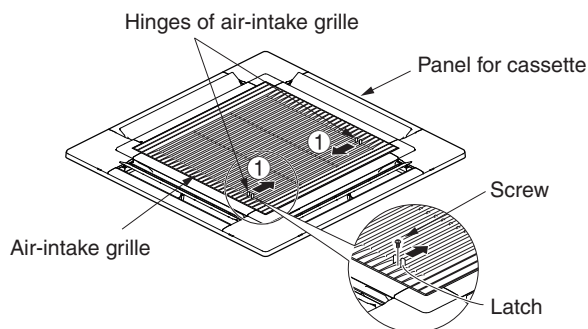
- Never place the panel face-down. Either hang it vertically or place it on top of a projecting object. Placing it face-down will damage the surface.
- Do not touch the flap or apply force to it. (This may cause flap malfunction.)



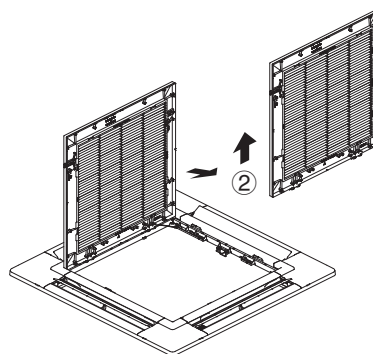
**How to Install the Panel for Cassette**

(1) Removing the air-intake grille

- 1) Remove the 2 screws on the latch of the air-intake grille. (Reattach the air-intake grille after installation of the panel for cassette.)
- 2) Slide the air-intake grille catches in the direction shown by the arrows ① to open the grille.

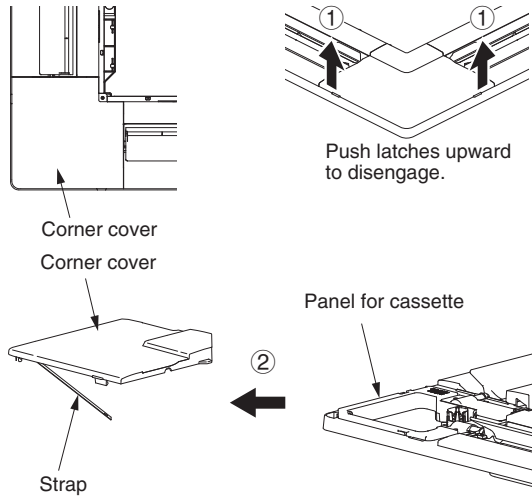


- 3) With the air-intake grille opened, remove the grille hinge from the panel for cassette by sliding it in the direction shown by the arrow ②. (Reattach the air-intake grille after installation of the panel for cassette.)



(2) Removing the corner cover

Push the latches on the corner cover in the direction of the arrow ① and remove them by sliding in the direction of the arrow ②.

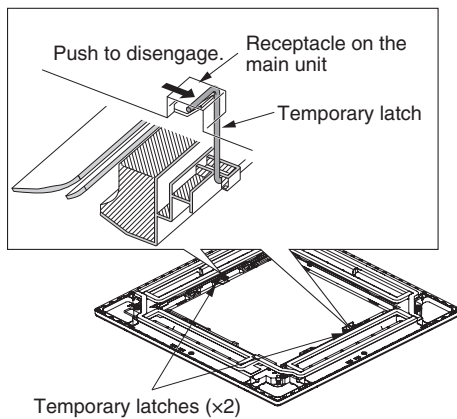


(3) Installing the panel for cassette

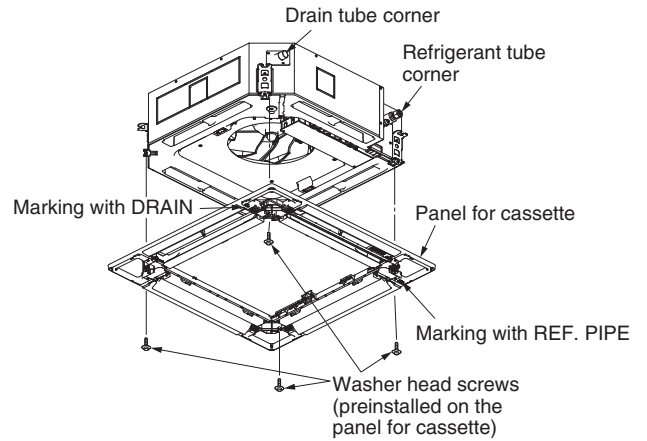
The power must be turned ON in order to change the flap angle. (Do not attempt to move the flap by hand. Doing so may damage the flap.)

- 1) Hang the temporary latches on the inside of the panel for cassette to the receptacle on the unit to temporarily attach the panel for cassette in place.

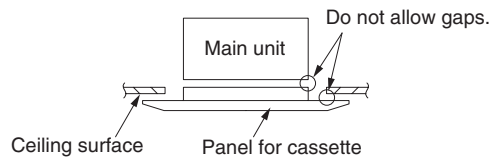
  - The panel for cassette must be installed in the correct direction relative to the unit. Align the REF. PIPE and DRAIN marks on the panel for cassette corner with the correct positions on the unit.
  - When removing the panel for cassette, push the temporary latches outward while holding the panel for cassette.



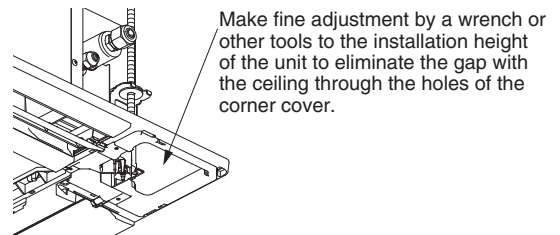
- 2) Align the panel installation holes and the unit screw holes.
- 3) Tighten the provided washer head screws at the 4 panel installation locations so that the panel is attached tightly to the unit.



- 4) Check that the panel is attached tightly to the ceiling.
  - At this time, make sure that there are no gaps between the unit and the panel for cassette, or between the panel for cassette and the ceiling surface.

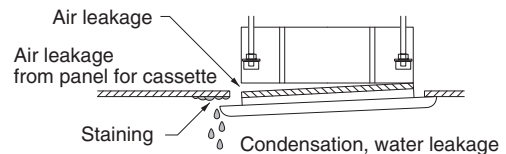


- If there is a gap between the panel and the ceiling, leave the panel for cassette attached and make fine adjustments to the installation height of the unit to eliminate the gap with the ceiling.

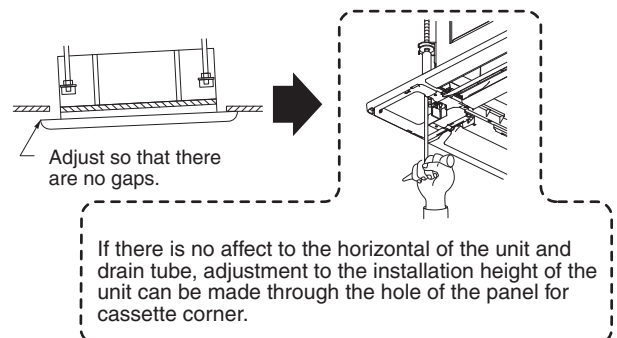


**CAUTION**

- If the screws are not sufficiently tightened, trouble such as that shown in the figure below may occur. Be sure to tighten the screws securely.

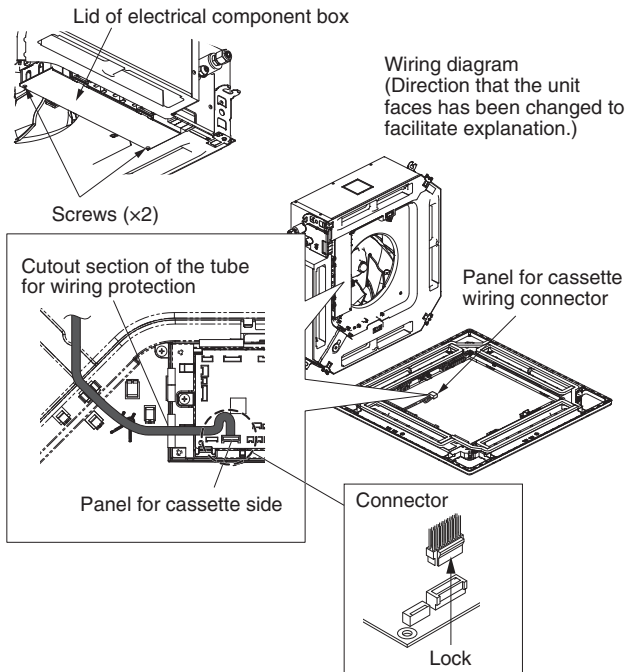


- If a gap remains between the ceiling surface and the panel for cassette even after the screws are tightened, adjust the height of the unit again.



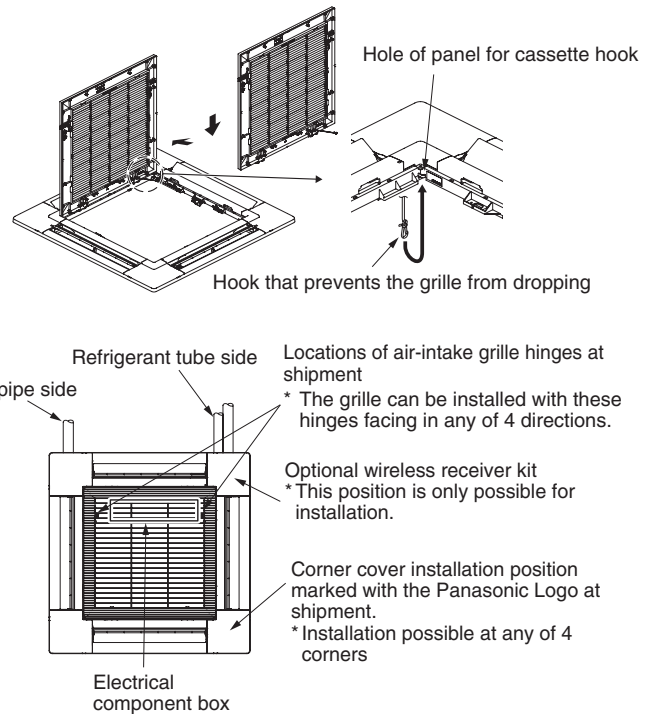
(4) Wiring the Panel for Cassette

- 1) Open the cover of the electrical component box for control PCB.
  - 2) Connect the 22P connector (white) from the panel for cassette to the connector on the control PCB in the unit electrical component box. In this case, expose the cutout section of the tube for the wiring protection to the outside from the electrical component box and fix it with the clumper attached to the electrical component box.
- **Insert connector lock facing PCB edge until it is locked in place. (If not connected completely, the Auto Flap will not operate and “P09” is displayed on the remote controller. When the connector plugged in the wrong direction, parts on the PCB may be damaged.)**
  - **Check that the wiring connector is not caught between the electrical component box and the cover.**
  - **Check that the wiring connector is not caught between the unit and the panel for cassette.**



**B. Attaching the air-intake grille**

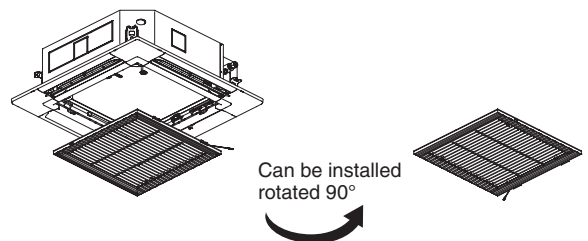
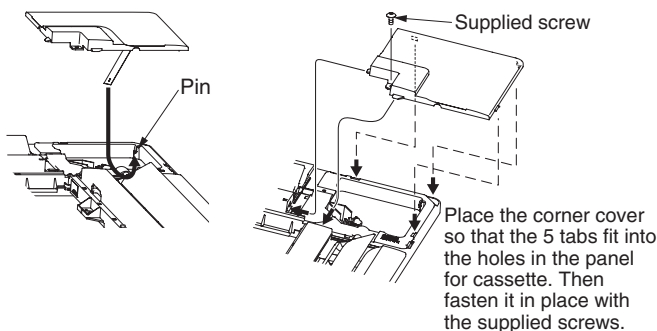
- To install the air-intake grille, follow the steps for “Removing the grille” in the reverse order. By rotating the air-intake grille, it is possible to attach the grille onto the panel for cassette from any of 4 directions. Coordinate the directions of the air-intake grilles when installing multiple units, and change the directions according to customer’s requests.
- When attaching the air-intake grille, be careful that the flap lead wire does not become caught.
- Be sure to attach the safety cord that prevents the air-intake grille from dropping off to the panel for cassette unit as shown in the figure below.
- With this panel for cassette, the directions of the air-intake grille lattices when installing multiple units, and the position of the label showing the company name on the corner panel, can be changed according to customer’s requests, as shown in the figure below. However, the wireless signal receiver can only be installed at the refrigerant-tubing corner of the ceiling unit.



(5) How to Attach the Corner & Air-Intake Grille

**A. Attaching the corner cover**

- 1) Check that the safety cord from the corner cover is fastened to the panel for cassette pin, as shown in the figure below.
- 2) Use the supplied screws to attach the corner cover to the panel for cassette.



**Others**

(1) Checking After Installation

- 1) Check that there are no gaps between the unit and the panel for cassette, or between the panel for cassette and the ceiling surface.

\* Gaps may cause water leakage and condensation.

- 2) Check that the wiring is securely connected.

\* If it is not securely connected, the auto flap will not operate.

("P09" is displayed on the remote controller.)

In addition, the water leakage and condensation may occur.

(2) Operating the Wireless Remote Controller

For details of installation, refer to the section "Wireless Signal Receiver" in the supplied installation instructions.

(3) Selecting DC Fan Motor Tap (4-Way Cassette)

Check the optional parts accordingly in the following table.

**Table for DC Fan Motor Tap Settings**

Setting No.	Remote controller setting data Item code 5d	Contents & optional parts name
(1)	0001	Air-flow blocking kit (for 3-way air flow)*2
		Air-flow blocking kit (when a duct is connected.)
		High-ceiling setting 1*2
(3)	0003	High-ceiling setting 2*2
(6)	0006	Air-flow blocking kit (for 2-way air flow)*2

\*1 When using optional parts in different setting No. in combination with multiple units, conform it to the larger setting No.

\*2 Ceiling height (m)

Indoor unit type	50	60,71	100,125,140
Standard (factory setting)	2.7	3.0	3.6
High-ceiling setting 1	3.2	3.3	4.3
High-ceiling setting 2	3.5	3.6	5.0
Air-flow blocking kit (for 3-way air flow)	3.8	3.8	4.7
Air-flow blocking kit (for 2-way air flow)	4.2	4.2	5.0

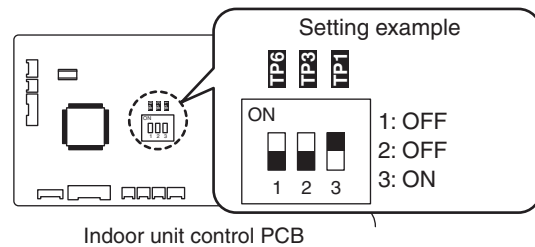
- 1) When setting on the P.C. Board

<Procedure>

**Stop the system before performing these steps.**

- ① Open the electrical component box cover, then check the indoor unit control PCB.
- ② Change the DIP switch on the indoor unit control PCB in accordance with the setting number which was confirmed in Table for DC Fan Motor Tap Settings.

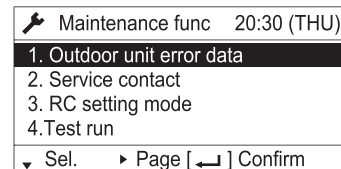
Setting No.	DIP switch	Setting No.	DIP switch
(1)		(6)	
(3)			



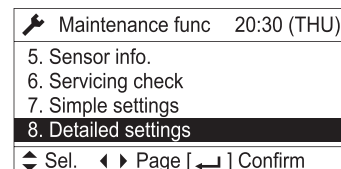
**<Procedure of CZ-RTC5A, CZ-RTC5B>**

**Stop the system before performing these steps.**

- ① Keep pressing the , and buttons simultaneously for 4 or more seconds. The "Maintenance func" screen appears on the LCD display.

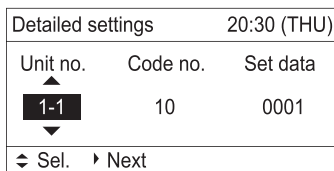


- ② Press the or button to see each menu. If you wish to see the next screen instantly, press the or button. Select "8. Detailed settings" on the LCD display and press the button.

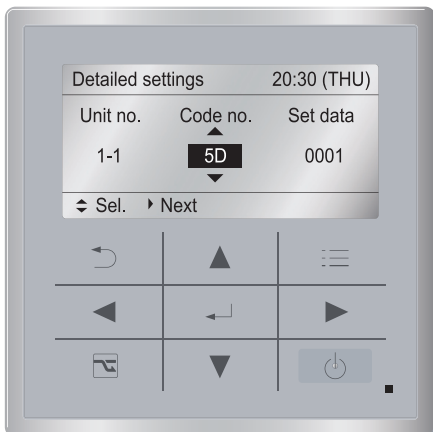


The "Detailed settings" screen appears on the LCD display.

- ③ Select the “Unit no.” by pressing the ▼ or ▲ button for changes.

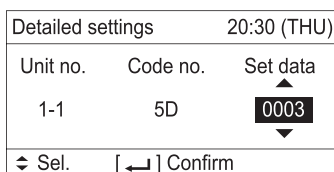


- ④ Select the “Code no.” by pressing the ◀ or ▶ button.  
Change the “Code no.” to “5D” by pressing the ▼ or ▲ button (or keeping it pressed).

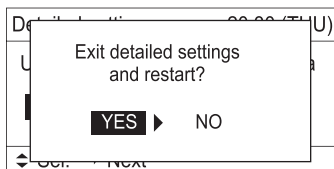


- ⑤ Select the “Set data” by pressing the ◀ or ▶ button.  
Select one of the “Set data” in “Table for DC Fan Motor Tap Settings” by pressing the ▼ or ▲ button.

Then press the ↵ button.



- ⑥ Press the ↶ button.  
The “Exit detailed settings and restart?” (Detailed setting-end) screen appears on the LCD display.  
Select “YES” and press the ↵ button.

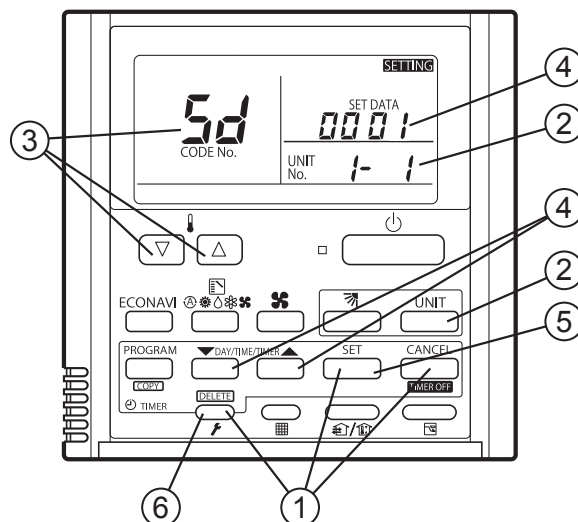


If you wish to change the selected indoor unit, follow the step ②.

<Procedure of CZ-RTC4>

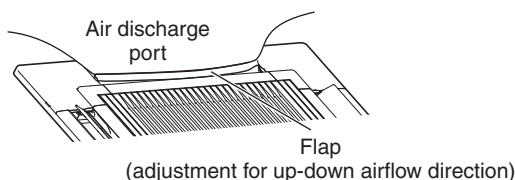
Stop the system before performing these steps.

- ① Press and hold the ⏻, SET and CANCEL buttons simultaneously for 4 seconds or longer.
- ② If group control is in effect, press the UNIT button. At this time, the fan at the indoor unit begins and select the address (unit No.) of the indoor unit operating.
- ③ Designate the item code 5d by adjusting the Temperature Setting (▼/▲) buttons.
- ④ Press the timer time (DAY/TIMER) buttons to select the desired setting data.  
\*For item codes and setting data, refer to “Table for DC Fan Motor Tap Settings”.
- ⑤ Press the SET button.  
(The display stops blinking and remains lit, and setting is completed.)  
If you wish to change the selected indoor unit, follow the step ②.
- ⑥ Press the ⏻ button to return to normal remote controller display.



(4) Setting the Flap Separately

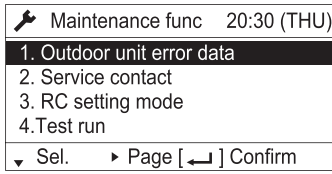
- 1) The 4-air outlet flap can be adjusted separately during operation. When not adjusted separately, all flaps operate in the same manner.



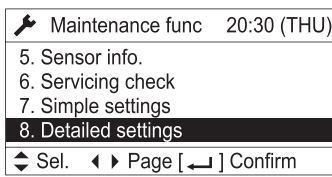
<Procedure of CZ-RTC5A, CZ-RTC5B>

Stop the system before performing these steps.

- (1) Keep pressing the and buttons simultaneously for 4 or more seconds.  
The "Maintenance func" screen appears on the LCD display.

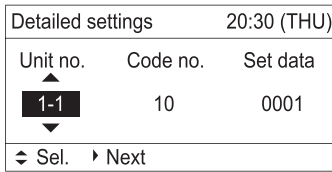


- (2) Press the or button to see each menu. If you wish to see the next screen instantly, press the or button.  
Select "8. Detailed settings" on the LCD display and press the button.

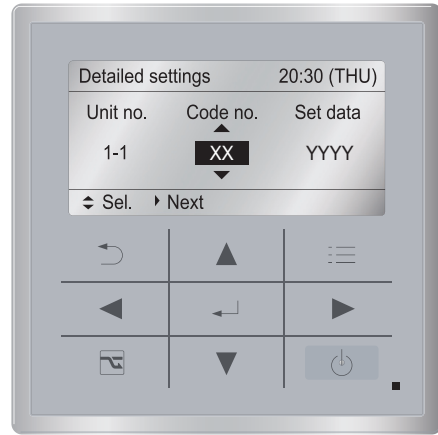
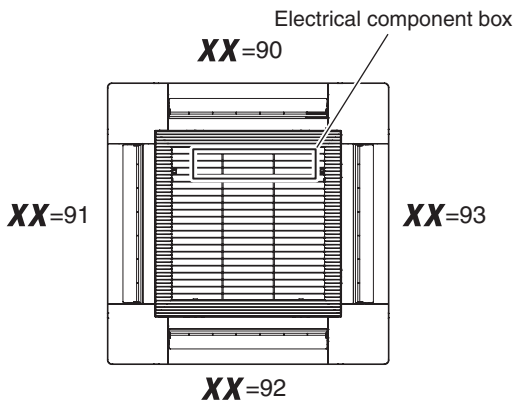


The "Detailed settings" screen appears on the LCD display.

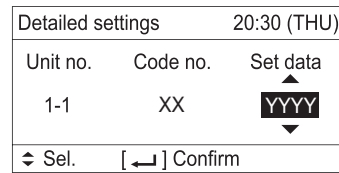
- (3) Select the "Unit no." by pressing the or button for changes.



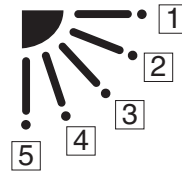
- (4) Select the "Code no." by pressing the or button.  
Change the "Code no." to "XX" by pressing the or button (or keeping it pressed).



- (5) Select the "Set data" by pressing the or button.  
Select one of the Setting Data "YYYY" by pressing the or button.  
Then press the button.



Flap position



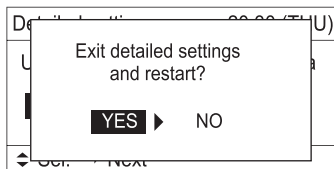
\* Setting data "YYYY"

Setting data	Flap position during operation
0000	Without separate setting
0001	Swing
0002	Move to position 1 and stay
0003	Move to position 2 and stay
0004	Move to position 3 and stay
0005	Move to position 4 and stay
0006	Move to position 5 and stay

**NOTE**

The flap swings during the operation under "Setting the Flap Separately".  
At this time, the unselected flaps are moved to the position 1.

- (6) Press the button.  
The "Exit detailed settings and restart?" (Detailed setting-end) screen appears on the LCD display.  
Select "YES" and press the button.

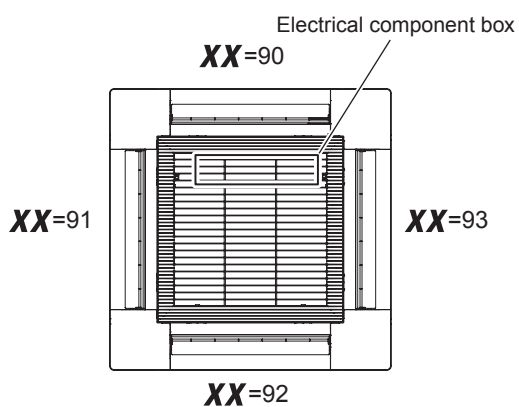


If you wish to change the selected indoor unit, follow the step (2).

**<Procedure of CZ-RTC4>**

**Stop the system before performing these steps.**

- (1) Press and hold the , and buttons simultaneously for 4 seconds or longer.
- (2) If group control is in effect, press the button to set. At this time, the fan at the indoor unit begins and select the address (unit No.) of the indoor unit operating.
- (3) Designate the item code "XX" by adjusting the Temperature Setting / buttons.



- (4) Press the timer time buttons to select the desired setting data.



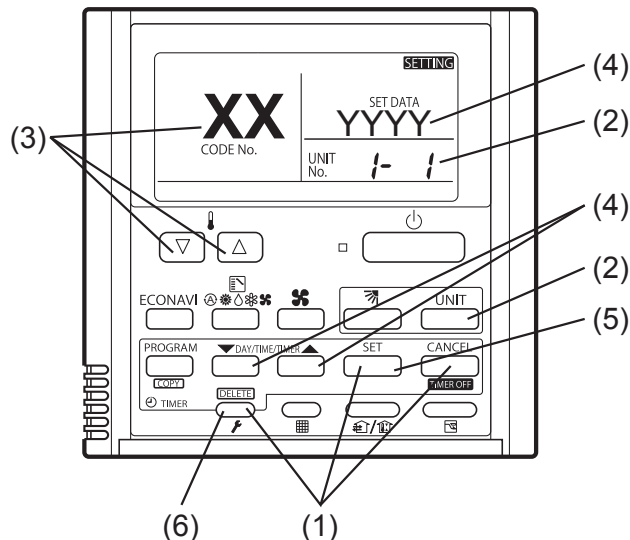
\* Setting data "YYYY"

Setting data	Flap position during operation
0000	Without separate setting
0001	Swing
0002	Move to position  and stay
0003	Move to position  and stay
0004	Move to position  and stay
0005	Move to position  and stay
0006	Move to position  and stay

**NOTE**

The flap swings during the operation under "Setting the Flap Separately".  
At this time, the unselected flaps are moved to the position .

- (5) Press the button.  
(The display stops blinking and remains lit, and setting is completed.)  
If you wish to change the selected indoor unit, follow the step (2).
- (6) Press the button to return to normal remote controller display.



**■ HOW TO INSTALL WIRELESS REMOTE CONTROLLER**

**NOTE**

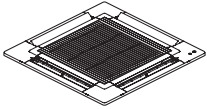



See "Section 8. HOW TO INSTALL THE WIRELESS REMOTE CONTROLLER RECEIVER".

## ■ Panel for Cassette (ECONAVI type)

CZ-KPU3A

Applicable indoor unit : 4-Way Cassette

### Accessories Supplied

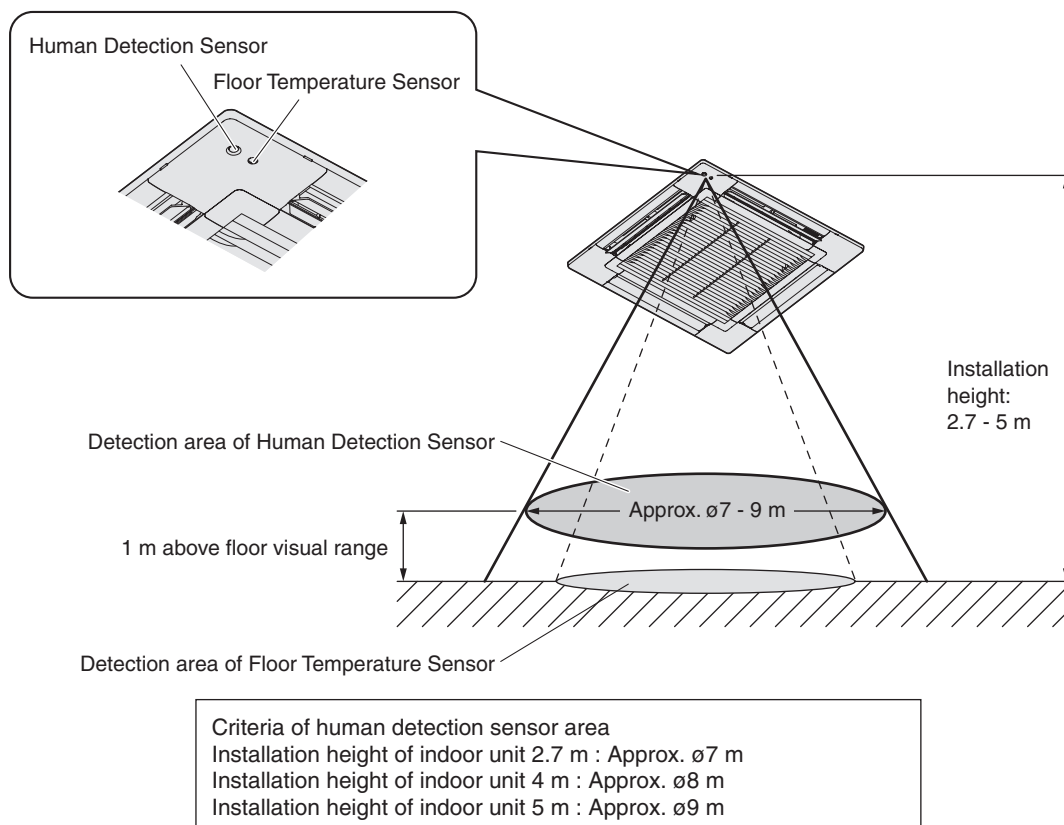
Part Name	Figure	Q'ty	Remarks
ECONAVI panel		1	ECONAVI type
Screw		4	4 x 12
Operating Instructions		1	
Installation Instructions		1	

Since the accessories need for installation work, do not dispose of them until the unit of work is complete.

## ■ CAUTION ON INSTALLATION

### Criteria for Human Detection Area

- A place where the blind angle of the Human Detection Sensor cannot detect human. Install the panel for cassette (ECONAVI type) so that human motion can be detected.
- If there is a heat source or cooling unit in the detection area, the sensor cannot occasionally detect properly.
- The Floor Temperature Sensor detects within the sensor area of Human Detection Sensor.



Do not install at the following locations. (Cause of trouble and malfunction)

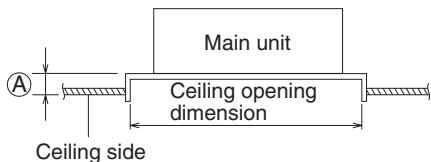
- Humid, oily, frequent vibration
- Direct sunlight and near by heat source
- Frost



### Preparation for Panel for Cassette Installation

(1) Checking the unit position

- 1) Check that the ceiling hole is within this range:  
860 × 860 mm to 910 × 910 mm
- 2) Confirm that the position of the indoor unit and the ceiling as shown in the diagram. If the positions of the ceiling surface and unit do not match, air leakage, water leakage, flap operation failure, or other problems may occur.

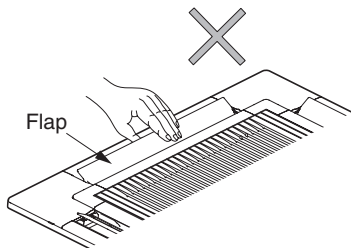


Ⓐ : Be sure to necessarily make a space within the range of 12 ~ 17 mm.

If not within this range, malfunction or other trouble may occur.

**CAUTION**

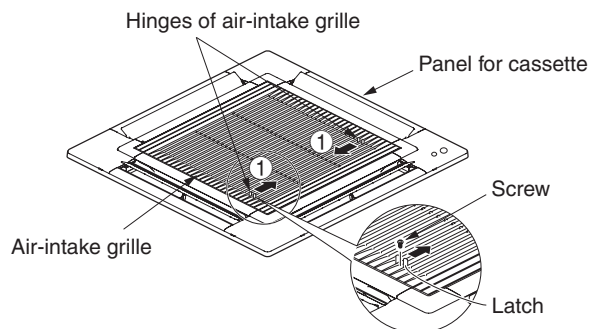
- Never place the panel face-down. Either hang it vertically or place it on top of a projecting object. Placing it face-down will damage the surface.
- Do not touch the flap or apply force to it. (This may cause flap malfunction.)



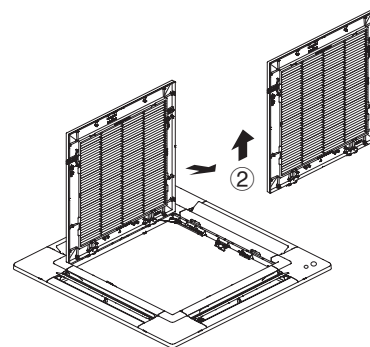
### How to Install the Panel for Cassette

(1) Removing the air-intake grille

- 1) Remove the 2 screws on the latch of the air-intake grille. (Reattach the air-intake grille after installation of the panel for cassette.)
- 2) Slide the air-intake grille catches in the direction shown by the arrows ① to open the grille.

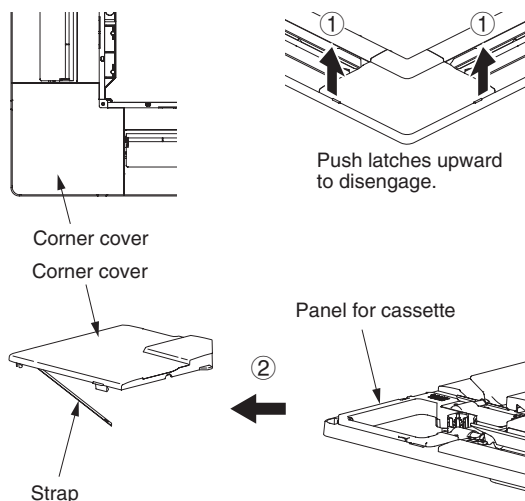


- 3) With the air-intake grille opened, remove the grille hinge from the panel for cassette by sliding it in the direction shown by the arrow ②. (Reattach the air-intake grille after installation of the panel for cassette.)



(2) Removing the corner cover

Push the latches on the corner cover in the direction of the arrow ① and remove them by sliding in the direction of the arrow ②.

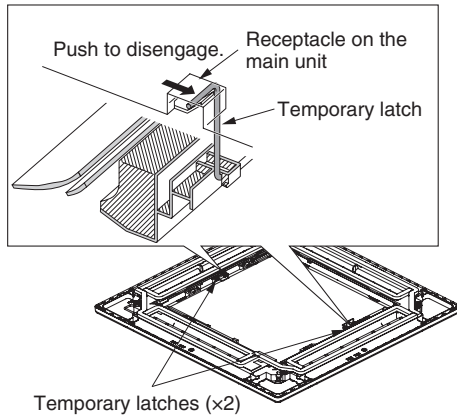


## (3) Installing the panel for cassette

The power must be turned ON in order to change the flap angle. (Do not attempt to move the flap by hand. Doing so may damage the flap.)

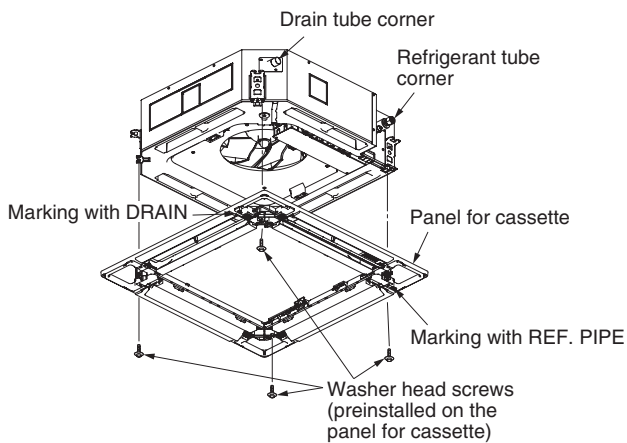
1) Hang the temporary latches on the inside of the panel for cassette to the receptacle on the unit to temporarily attach the panel for cassette in place.

- The panel for cassette must be installed in the correct direction relative to the unit. Align the REF. PIPE and DRAIN marks on the panel for cassette corner with the correct positions on the unit.
- When removing the panel for cassette, push the temporary latches outward while holding the panel for cassette.



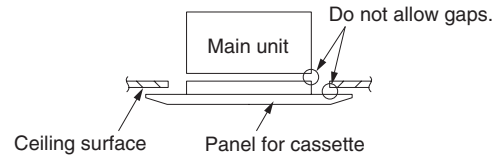
2) Align the panel installation holes and the unit screw holes.

3) Tighten the provided washer head screws at the 4 panel installation locations so that the panel is attached tightly to the unit.

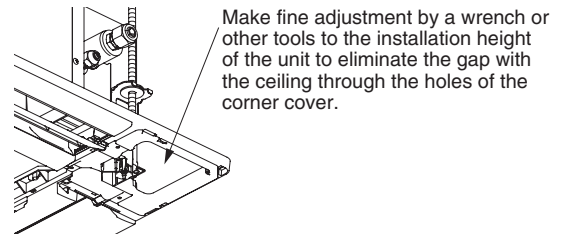


4) Check that the panel is attached tightly to the ceiling.

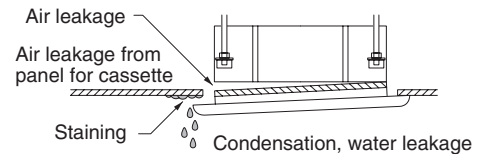
- At this time, make sure that there are no gaps between the unit and the panel for cassette, or between the panel for cassette and the ceiling surface.



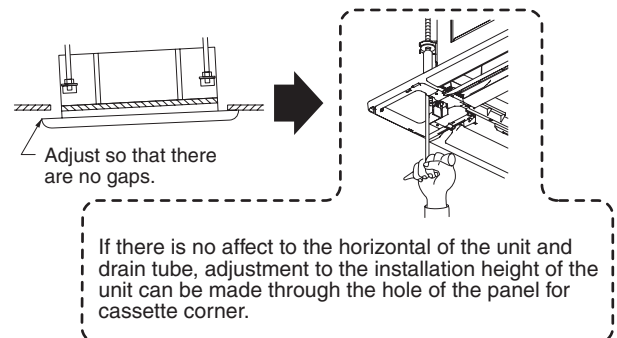
- If there is a gap between the panel and the ceiling, leave the panel for cassette attached and make fine adjustments to the installation height of the unit to eliminate the gap with the ceiling.

**CAUTION**

- If the screws are not sufficiently tightened, trouble such as that shown in the figure below may occur. Be sure to tighten the screws securely.

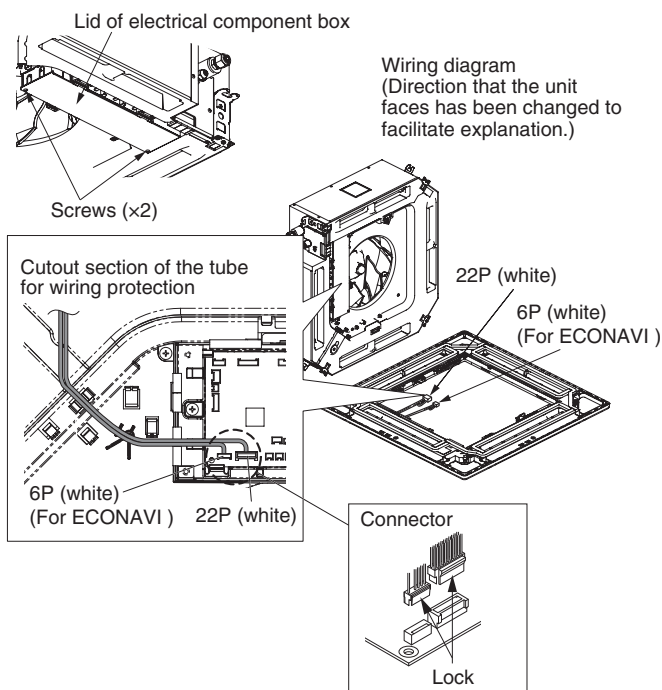


- If a gap remains between the ceiling surface and the panel for cassette even after the screws are tightened, adjust the height of the unit again.



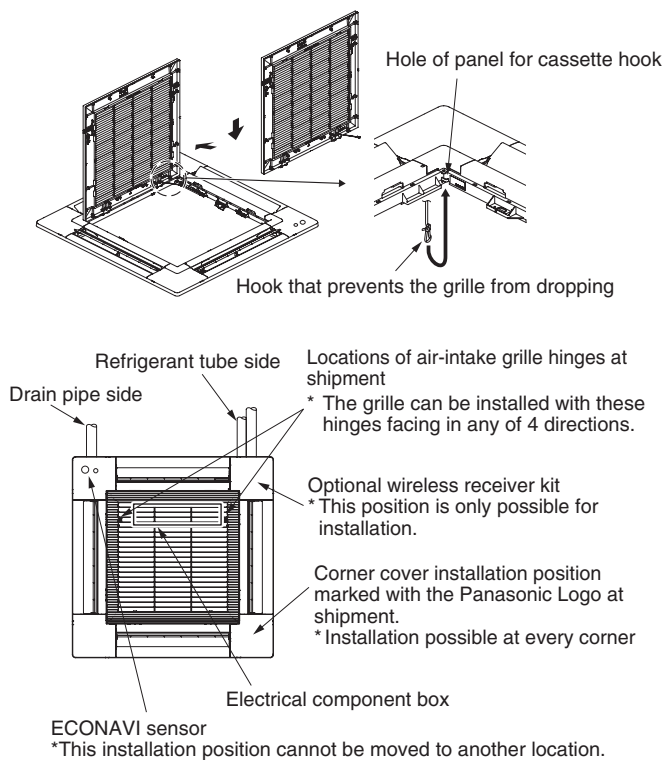
(4) Wiring the Panel for Cassette

- 1) Open the cover of the electrical component box for control PCB.
  - 2) Connect the 22P connector (white) and 6P connector (white) from the panel for cassette to the connector on the control PCB in the unit electrical component box. In this case, expose the cutout section of the tube for the wiring protection to the outside from the electrical component box and fix it with the clumper attached to the electrical component box.
- **Insert connector lock facing PCB edge until it is locked in place. (If not connected completely, the Auto Flap will not operate and “P09” is displayed on the remote controller. When the connector plugged in the wrong direction, parts on the PCB may be damaged.)**
  - **Check that the wiring connector is not caught between the electrical component box and the cover.**
  - **Check that the wiring connector is not caught between the unit and the panel for cassette.**



**B. Attaching the air-intake grille**

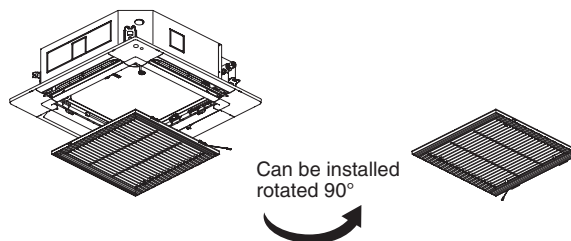
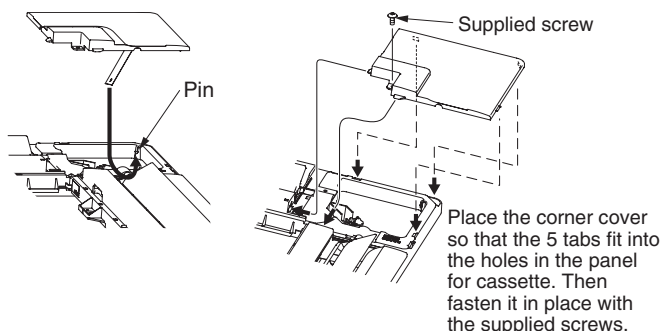
- To install the air-intake grille, follow the steps for “Removing the grille” in the reverse order. By rotating the air-intake grille, it is possible to attach the grille onto the panel for cassette from any of 4 directions. Coordinate the directions of the air-intake grilles when installing multiple units, and change the directions according to customer’s requests.
- When attaching the air-intake grille, be careful that the flap lead wire does not become caught.
- Be sure to attach the safety cord that prevents the air-intake grille from dropping off to the panel for cassette unit as shown in the figure below.
- With this panel for cassette, the directions of the air-intake grille lattices when installing multiple units, and the position of the label showing the company name on the corner panel, can be changed according to customer’s requests, as shown in the figure below. However, the wireless signal receiver can only be installed at the refrigerant-tubing corner of the ceiling unit.



(5) How to Attach the Corner & Air-Intake Grille

**A. Attaching the corner cover**

- 1) Check that the safety cord from the corner cover is fastened to the panel for cassette pin, as shown in the figure below.
- 2) Use the supplied screws to attach the corner cover to the panel for cassette.



Others

(1) Checking After Installation

- 1) Check that there are no gaps between the unit and the panel for cassette, or between the panel for cassette and the ceiling surface.

\* Gaps may cause water leakage and condensation.

- 2) Check that the wiring is securely connected.

\* If it is not securely connected, the auto flap will not operate.

("P09" is displayed on the remote controller.)

In addition, the water leakage and condensation may occur.

(2) Operating the Wireless Remote Controller

For details of installation, refer to the section "Wireless Signal Receiver" in the supplied installation instructions.

(3) Selecting DC Fan Motor Tap (4-Way Cassette)

Check the optional parts accordingly in the following table.

Table for DC Fan Motor Tap Settings

Setting No.	Remote controller setting data Item code 5d	Contents & optional parts name
(1)	0001	Air-flow blocking kit (for 3-way air flow)*2
		Air-flow blocking kit (when a duct is connected.)
		High-ceiling setting 1*2
(3)	0003	High-ceiling setting 2*2
(6)	0006	Air-flow blocking kit (for 2-way air flow)*2

\*1 When using optional parts in different setting No. in combination with multiple units, conform it to the larger setting No.

\*2 Ceiling height (m)

Indoor unit type	50	60,71	100,125,140
Standard (factory setting)	2.7	3.0	3.6
High-ceiling setting 1	3.2	3.3	4.3
High-ceiling setting 2	3.5	3.6	5.0
Air-flow blocking kit (for 3-way air flow)	3.8	3.8	4.7
Air-flow blocking kit (for 2-way air flow)	4.2	4.2	5.0

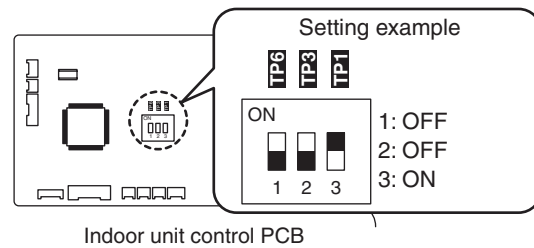
1) When setting on the P.C. Board

<Procedure>

**Stop the system before performing these steps.**

- ① Open the electrical component box cover, then check the indoor unit control PCB.
- ② Change the DIP switch on the indoor unit control PCB in accordance with the setting number which was confirmed in Table for DC Fan Motor Tap Settings.

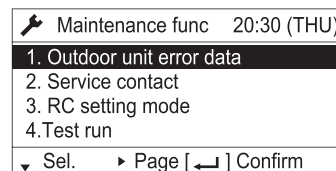
Setting No.	DIP switch	Setting No.	DIP switch
(1)		(6)	
(3)			



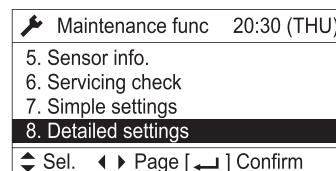
<Procedure of CZ-RTC5A, CZ-RTC5B>

**Stop the system before performing these steps.**

- ① Keep pressing the , and buttons simultaneously for 4 or more seconds. The "Maintenance func" screen appears on the LCD display.

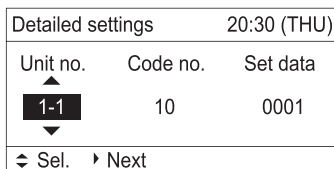


- ② Press the or button to see each menu. If you wish to see the next screen instantly, press the or button. Select "8. Detailed settings" on the LCD display and press the button.



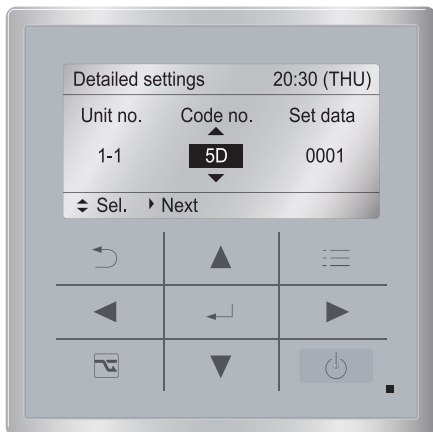
The "Detailed settings" screen appears on the LCD display.

- ③ Select the “Unit no.” by pressing the or button for changes.



- ④ Select the “Code no.” by pressing the or button.

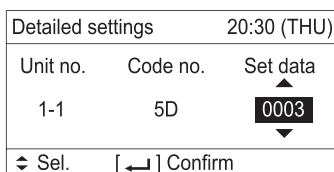
Change the “Code no.” to “5D” by pressing the or button (or keeping it pressed).



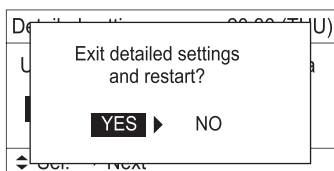
- ⑤ Select the “Set data” by pressing the or button.

Select one of the “Set data” in “Table for DC Fan Motor Tap Settings” by pressing the or button.

Then press the button.



- ⑥ Press the button.  
The “Exit detailed settings and restart?” (Detailed setting-end) screen appears on the LCD display.  
Select “YES” and press the button.

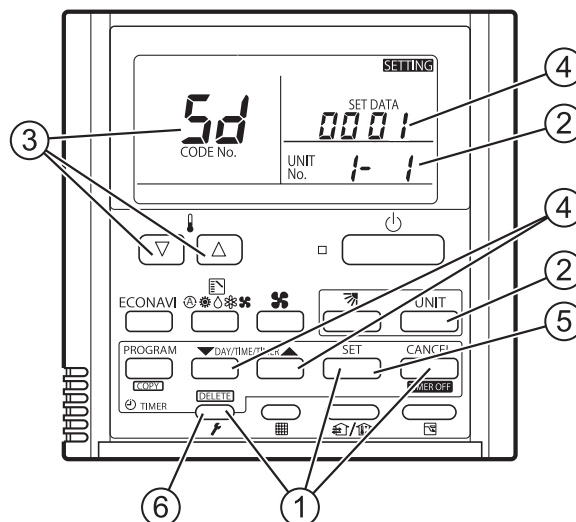


If you wish to change the selected indoor unit, follow the step ②.

**<Procedure of CZ-RTC4>**

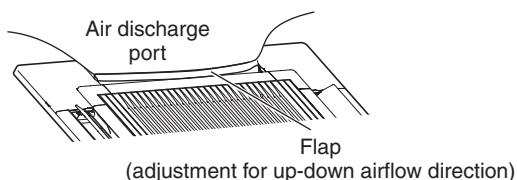
**Stop the system before performing these steps.**

- ① Press and hold the , and buttons simultaneously for 4 seconds or longer.
- ② If group control is in effect, press the button to set. At this time, the fan at the indoor unit begins and select the address (unit No.) of the indoor unit operating.
- ③ Designate the item code **5d** by adjusting the Temperature Setting / buttons.
- ④ Press the timer time buttons to select the desired setting data.  
\*For item codes and setting data, refer to “Table for DC Fan Motor Tap Settings”.
- ⑤ Press the button.  
(The display stops blinking and remains lit, and setting is completed.)  
If you wish to change the selected indoor unit, follow the step ②.
- ⑥ Press the button to return to normal remote controller display.






**(4) Setting the Flap Separately**

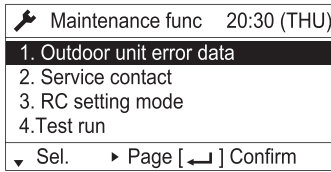
- 1) The 4-air outlet flap can be adjusted separately during operation. When not adjusted separately, all flaps operate in the same manner.








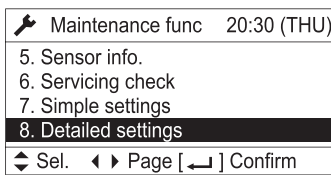
## <Procedure of CZ-RTC5A, CZ-RTC5B>

Stop the system before performing these steps.



- ① Keep pressing the ,  and  buttons simultaneously for 4 or more seconds.  
The "Maintenance func" screen appears on the LCD display.

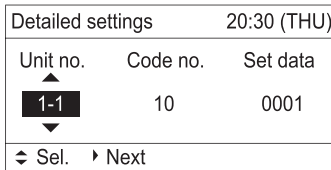






- ② Press the  or  button to see each menu. If you wish to see the next screen instantly, press the  or  button.  
Select "8. Detailed settings" on the LCD display and press the  button.

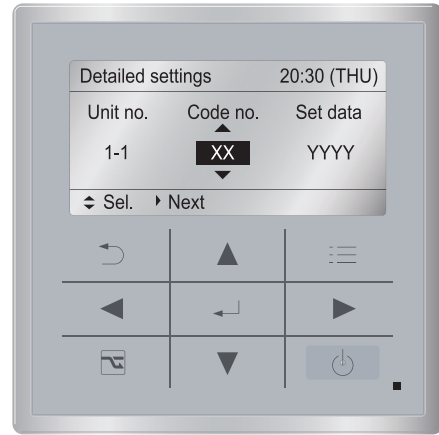
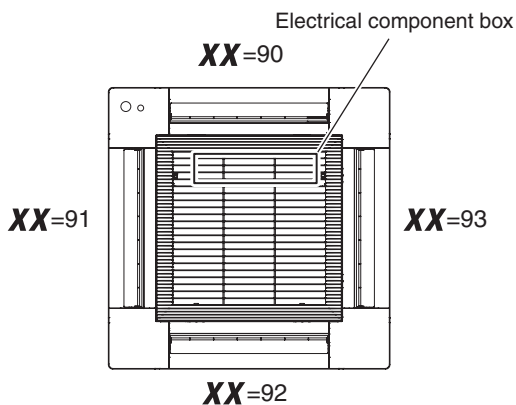







The "Detailed settings" screen appears on the LCD display.

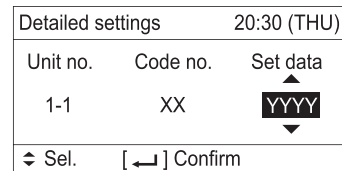
- ③ Select the "Unit no." by pressing the  or  button for changes.



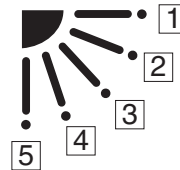
- ④ Select the "Code no." by pressing the  or  button.  
Change the "Code no." to "XX" by pressing the  or  button (or keeping it pressed).



- ⑤ Select the "Set data" by pressing the  or  button.  
Select one of the Setting Data "YYYY" by pressing the  or  button.  
Then press the  button.



Flap position





\* Setting data "YYYY"

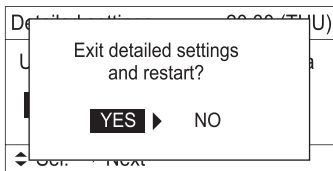
Setting data	Flap position during operation
0000	Without separate setting
0001	Swing
0002	Move to position 1 and stay
0003	Move to position 2 and stay
0004	Move to position 3 and stay
0005	Move to position 4 and stay
0006	Move to position 5 and stay

### NOTE

The flap swings during the operation under "Setting the Flap Separately".

At this time, the unselected flaps are moved to the position 1.

- ⑥ Press the  button.  
The "Exit detailed settings and restart?" (Detailed setting-end) screen appears on the LCD display.  
Select "YES" and press the  button.



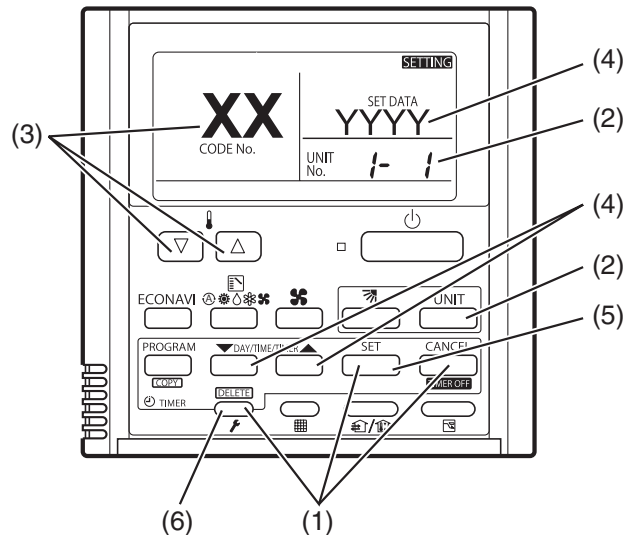
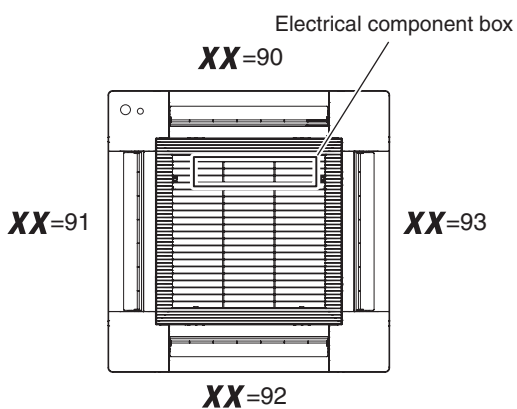
If you wish to change the selected indoor unit, follow the step (2).

- (5) Press the button.  
(The display stops blinking and remains lit, and setting is completed.)  
If you wish to change the selected indoor unit, follow the step (2).
- (6) Press the button to return to normal remote controller display.

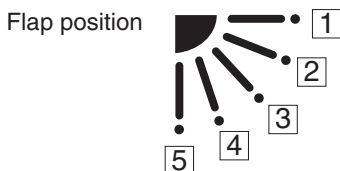
<Procedure of CZ-RTC4>

Stop the system before performing these steps.

- (1) Press and hold the , and buttons simultaneously for 4 seconds or longer.
- (2) If group control is in effect, press the button to set. At this time, the fan at the indoor unit begins and select the address (unit No.) of the indoor unit operating.
- (3) Designate the item code "XX" by adjusting the Temperature Setting / buttons.



- (4) Press the timer time / buttons to select the desired setting data.



\* Setting data "YYYY"

Setting data	Flap position during operation
0000	Without separate setting
0001	Swing
0002	Move to position  and stay
0003	Move to position  and stay
0004	Move to position  and stay
0005	Move to position  and stay
0006	Move to position  and stay




**NOTE**

The flap swings during the operation under "Setting the Flap Separately".  
At this time, the unselected flaps are moved to the position .

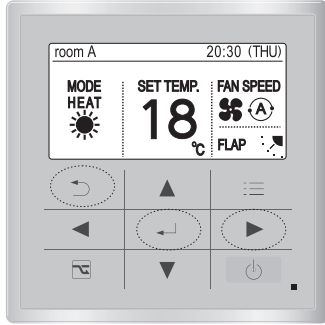
## ■ ECONAVI SYSTEM SETTING

Change the settings of main and sub indoor units to correspond to the ECONAVI system function.  
For the benefit of using the ECONAVI function, the main indoor unit should be provided with the ECONAVI function.




### 1. Press three buttons.

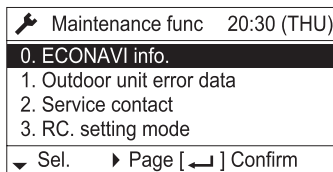
Keep pressing the ,  and  buttons simultaneously for more than 4 seconds.

The “Maintenance func” menu appears on the screen.



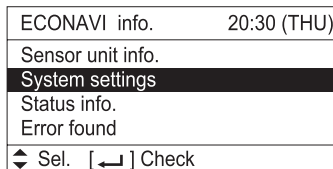
### 2. Select “0. ECONAVI info.” from the menu command.

By pressing the  /  buttons, select “0. ECONAVI info.” and press the  button.



### 3. Select “System settings” from the menu command.

By pressing the  /  buttons, select “System settings” and press the  button.



## NOTE

- After operating Step 2, the following messages may occasionally appear on the screen.

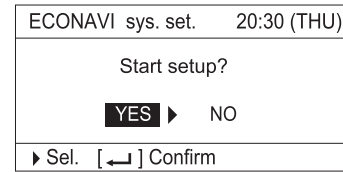
Display message	Contents
Disabled in default mode.	After a while, select “0. ECONAVI info.” again. If no status changes even after 10 minutes, make auto address setting and then select “0. ECONAVI info.”.

- After operating Step 3, the following messages may occasionally appear on the screen.

Display message	Contents
Setup is not required.	The main indoor unit has already been provided with the ECONAVI function. So, it works right out of the box.
Main indoor unit is not found.	The power of indoor unit may possibly shut down. Check the power supply of indoor unit.
Indoor unit with ECONAVI is not found.	Since all indoor units in the group control are not available for the ECONAVI function, the ECONAVI function cannot be used.

### 4. Start settings.


By pressing the  /  buttons, select “YES” and press the  button.



### 5. When finished settings, the system restarts automatically.

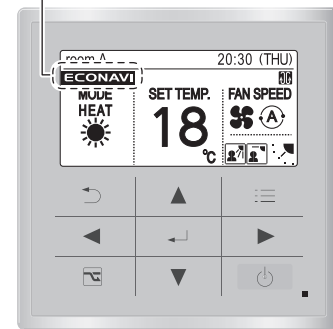
### 6. Check whether the ECONAVI function is set.

**ECONAVI** is displayed on the screen.

If the display is not operated, press the  button and set it in operating mode.

If operation is in fan mode, **ECONAVI** is not displayed. Set in any operating mode other than fan mode.

“**ECONAVI**” is displayed when setting the ECONAVI function.






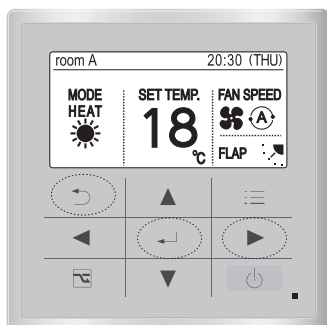


## ■ ECONAVI TEST OPERATION


Preparation: Refer to the manuals of the indoor unit and turn on the main power switch in advance.  
Human detection cannot be made for approx. 90 seconds when switched on the power because the human detection sensor is set in initial setup.



1. Press three buttons.

Keep pressing the ,  and  buttons simultaneously for more than 4 seconds.  
The "Maintenance func" menu appears on the screen.







2. Select "0. ECONAVI info." from the menu command.

By pressing the  /  buttons, select "0. ECONAVI info." and press the  button.



 Maintenance func	20:30 (THU)
<b>0. ECONAVI info.</b>	
1. Outdoor unit error data	
2. Service contact	
3. RC. setting mode	
▼ Sel.	▶ Page [  ] Confirm

3. Select "Error found" from the menu command.

By pressing the  /  buttons, select "Error found" and press the  button.

ECONAVI info.	20:30 (THU)
Sensor unit info.	
System settings	
Status info.	
<b>Error found</b>	
▲ Sel.	[  ] Check

4. Check the sensor status shows "Normal".

(By pressing the  /  buttons, the status of each indoor unit can be scrolled on the screen.)  
The sensor status of all indoor units are displayed.

- "Normal": The sensor on the panel for cassette (ECONAVI type) works normally.
- "Preparing": The sensor on the panel for cassette (ECONAVI type) is set in initial setup.  
Confirm that "Normal" appears within 90 seconds.
- "Unsupported": Indoor units not available for ECONAVI function.

Error found	20:30 (THU)
Unit no.	Status
1 - 1	Normal
1 - 2	Normal
Sensor 1	Not connected
▲ Scroll	

The test run procedure described above is over. If any display appears other than "Normal" or "Preparing" even though the ECONAVI panel is connected, follow the Step 5 below.

\* "1-1", "1-2" mean indoor unit No. If the indoor unit is without ECONAVI panel, "Not connected" appears.

\* "Sensor 1" means optional ECONAVI sensor (CZ-CENSC1). If not connected, "Not connected" appears besides "Sensor 1" on the screen.

5. If the sensor status shows other than "Normal", "Preparing",



If the sensor status shows "Error" or "Not connected" although the panel for cassette (ECONAVI type) is connected, the following symptom may have occurred.  
"Error": The sensor may possibly be damaged.

"Not connected": The wiring between the indoor unit and sensor may possibly be disconnected.


\* The specified indoor unit can be confirmed by the flap operation.

Confirmation method:

- ① Finish the maintenance function.

Press the  button to show the maintenance function display and then press the  button.

- ② Operate the flap.

By pressing the  button, select the applicable "Indoor Unit No." in the list of "2. FLAP" and then make flap setting. The indoor unit which responds to the flap setting becomes available.

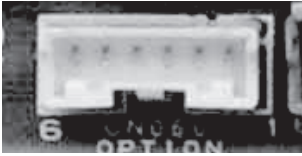
When the indoor unit is specified, turn off the main power switch and disconnect the connector of sensor wiring from the PCB. Then reconnect it. Turn on the main power switch and repeat the Steps 1 to 4 described above. Confirm the display shows "Error found". If the display shows "Error" or "Not connected" on the screen again, it is necessary to replace the panel for cassette (ECONAVI type) with a new one.

## EXTERNAL DEVICE INTERLOCK

Example of wiring:

This is an example of the combination systems which extract optional output signal by the service wire and relay (field supply). When actuating the external device interlock, use the thermostat signal.

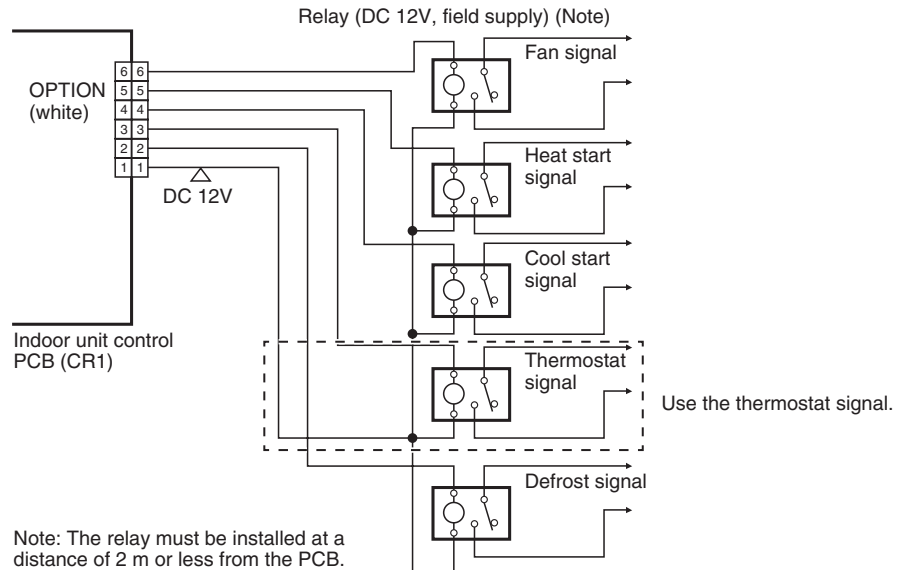
### OPTION Connector (CN060) Output external signals



PAW-OCT: Panasonic has developed an optional accessory (consisting of plug + wires) called PAW-OCT to enable an easy connection to this OPTION Connector (CN060).

With the combination of the T10 and the OPTION Connector (CN060) an external control of the I\_U is possible!

6P (WHITE): OUTPUTS EXTERNAL SIGNALS AS SHOWN IN THE FIGURE BELOW.



### NOTE

- The external output signal from the air conditioner is supplied for the purpose of controlling the external devices. If the air conditioner does not operate, take measures that the movement of external connecting devices can transfer to the safety zone in advance.
- The external output signal from the air conditioner is turned off when the blackout occurs. If any special considerations are needed in case of blackout, provide an external circuit.

## ■ CHECKLIST AFTER INSTALLATION WORK

Work List	No.	Content	Check <input checked="" type="checkbox"/>	Possibility of Failure & Checkpoint
Installation	1	Are the indoor units installed following the content on page 1-11-2-1 "■ SELECTING THE INSTALLATION SITE (Type U2)"?	<input type="checkbox"/>	There is a possibility of light injure or loss of property.
Tubing & Wiring	2	In the case of multiple installation: Is there a wrong tubing connection with another system?	<input type="checkbox"/>	The unit is inoperated or the refrigerant flows into the inoperative unit and the leakage is expected. Check if there is a wrong tubing or wiring connection with another system.
	3	In the case of multiple installation: Is there a wrong wiring connection with another system?	<input type="checkbox"/>	
	4	Is the earth leakage circuit breaker (all-pole switching function provided) installed?	<input type="checkbox"/>	Power failure or short circuit may cause electric shock or fire. Check installation work and ground wire work.
	5	Is there any wrong installation of optional parts or wrong wiring?	<input type="checkbox"/>	
	6	Was the ground wire work performed?	<input type="checkbox"/>	
	7	Are there any wrong power supply wiring, wrong connection wire, wrong signal wire or loose screw?	<input type="checkbox"/>	
	8	Is the thickness of wire in accordance with rule?	<input type="checkbox"/>	
	9	Is the power-supply voltage equal to the nameplate of the unit?	<input type="checkbox"/>	
	10	Was the check of the airtight test, flared tube fitting and gas leakage on the welded portion performed?	<input type="checkbox"/>	If the gas leakage occurs, the unit quality not only becomes inferior but affects environment. Repair it as quickly as possible.
Drain Check	11	Has the adhesive been applied to the drain connecting portion (resin portion) of the indoor unit?	<input type="checkbox"/>	The resin portion cracks after a few months and it may cause water drain.
	12	Is there water leakage?	<input type="checkbox"/>	Since there is a possibility of water drain, repair the drain pipe if the drain failure or water drain occurs.
	13	Indoor unit drain pipe has a downward gradient (1/100 or more) by rule. Is the drain water flowing smoothly?	<input type="checkbox"/>	
Heat Insulation	14	Was the heat insulation work at a suitable location including the flared tube fitting (refrigerant tube & drain pipe) performed properly?	<input type="checkbox"/>	The quality of unit not only becomes inferior but there is a possibility of the water drain. So, perform the heat insulation work properly.
Optional Parts	15	Was the short-circuit connector connected or the fan tap changed when installing the air-blocking material?	<input type="checkbox"/>	The discharge temperature decreases in cooling mode according to the reduction of air volume and there is a possibility of dew drops. Be sure to change settings.
Test Run	16	Did the abnormal sound occur?	<input type="checkbox"/>	Check if there is a fan contact or distortion of the indoor unit.
	17	Did the cool and warm airflow discharge from the indoor unit?	<input type="checkbox"/>	Check if the unit does not operate or there is a wrong tubing or wiring connection with another system.

## ■ APPENDIX

### Care and Cleaning



#### WARNING

- For safety, be sure to turn the air conditioner off and also to disconnect the power before cleaning.
- Do not pour water on the indoor unit to clean it. This will damage the internal components and cause an electric shock hazard.

#### Air intake and outlet side (Indoor unit)

Clean the air intake and outlet side of the indoor unit with a vacuum cleaner brush, or wipe them with a clean, soft cloth.

If these parts are stained, use a clean cloth moistened with water. When cleaning the air outlet side, be careful not to force the vanes out of place.



#### CAUTION

- Never use solvents or harsh chemicals when cleaning the indoor unit. Do not wipe plastic parts using very hot water.
- Some metal edges and the fins are sharp and may cause injury if handled improperly; be especially careful when you clean these parts.
- The internal coil and other components of outdoor unit must be cleaned regularly. Consult your dealer or service center.

#### Air filter

The air filter collects dust and other particles from the air and should be cleaned at regular intervals as indicated in the table below or when the filter indication (■) on the display of the remote controller (wired type) shows that the filter needs cleaning. If the filter gets blocked, the efficiency of the air conditioner drops greatly.

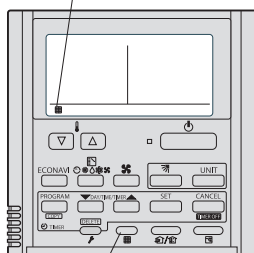
Type	U2
Period	6 months

#### ● After Cleaning

1. After the air filter is cleaned, reinstall it in its original position.  
Be sure to reinstall in reverse order.
2. [In the case of Timer Remote Controller]  
Press the Filter reset button.  
The ■ (Filter) indicator on the display goes out.  
[In the case of High-spec Wired Remote Controller]  
Refer to the Operating Instructions attached to the optional High-spec Wired Remote Controller.

#### Timer Remote Controller

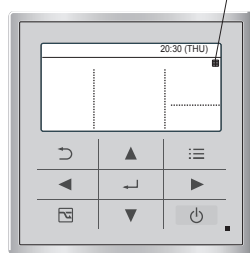
Filter indicator



Filter reset button

#### High-spec Wired Remote Controller

Filter indicator



#### NOTE

The frequency with which the filter should be cleaned depends on the environment in which the unit is used. Clean the filter frequently for best performance in the area of dusty or oil spots regardless of filter status.

#### <How to clean the filter>

1. Remove the air filter from the air-intake grille.
2. Use a vacuum cleaner to remove light dust. If there is sticky dust on the filter, wash the filter in lukewarm, soapy water, rinse it in clean water, and dry it.

#### <How to remove the filter>

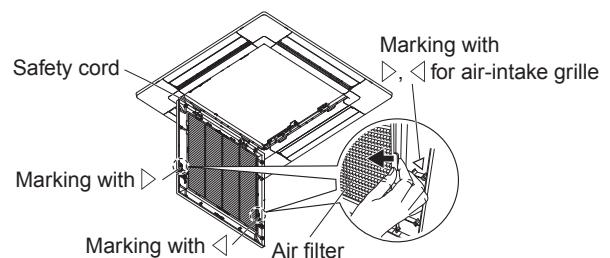
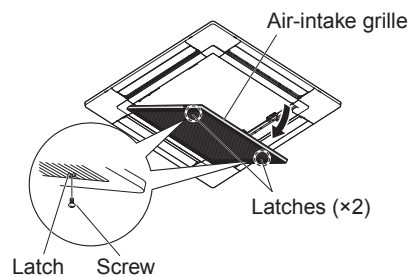
##### 4-Way Cassette Type (U2):

1. Use a screwdriver to remove the bolt screw on each side for the two latches. (Be sure to reattach the two bolt screws after cleaning.)
2. Slide the latches of the air-intake grille in the direction of the inside to open the grille.
3. The air-intake grille opens downward.



#### CAUTION

- When cleaning the air filter, never remove the safety chain. If it is necessary to remove it for servicing and maintenance inside, be sure to reinstall the safety chain securely (hook on the grille side) after the work.
- When the filter has been removed, rotating parts (such as the fan), electrically charged areas, etc. will be exposed in the unit's opening. Bear in mind the dangers that these parts and areas pose, and proceed with the work carefully.
- 4. Push the side of the air filter marked with the indication ▽ and pull it toward you. The air filter will be disengaged.



 **CAUTION**

- **Certain metal edges and the condenser fins are sharp and may cause injury if handled improperly; special care should be taken when you clean these parts.**
- **Periodically check the outdoor unit to see if the air outlet or air intake is clogged with dirt or soot.**
- **The internal coil and other components must also be cleaned periodically. Consult your dealer or service center.**

**Care: After a prolonged idle period**

Check the indoor and outdoor unit air intakes and outlets for blockage; if there is a blockage, remove it.

**Care: Before a prolonged idle period**

- Operate the fan for half a day to dry out the inside.
- Disconnect the power supply and also turn off the circuit breaker.
- Clean the air filter and replace it in its original position.
- Outdoor unit internal components must be checked and cleaned periodically. Contact your local dealer for this service.

**■ Troubleshooting**

If your air conditioner does not work properly, first check the following points before requesting service. If it still does not work properly, contact your dealer or a service center.


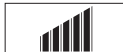




● **Indoor unit**

Symptom		Cause
Noise	Sound like streaming water during operation or after operation	<ul style="list-style-type: none"> <li>● Sound of refrigerant liquid flowing inside unit</li> <li>● Sound of drainage water through drain pipe</li> </ul>
	Cracking noise during operation or when operation stops.	Cracking sound due to temperature changes of parts
Odor	Discharged air is smelled during operation.	Indoor odor components, cigarette odor and cosmetic odor accumulated in the air conditioner and its air is discharged. Unit inside is dusty. Consult your dealer.
Dewdrop	Dewdrop gets accumulated near air discharge during operation	Indoor moisture is cooled by cool wind and accumulated by dewdrop.
Fog	Fog occurs during operation in cooling mode. (Places where large amounts of oil mist exist at restaurants.)	<ul style="list-style-type: none"> <li>● Cleaning is necessary because unit inside (heat exchanger) is dirty. Consult your dealer as technical engineering is required.</li> <li>● During defrost operation</li> </ul>
Fan is rotating for a while even though operation stops.		<ul style="list-style-type: none"> <li>● Fan rotating makes operation smoothly.</li> <li>● Fan may sometimes rotates because of drying heat exchanger due to settings.</li> </ul>
Wind-direction changes while operating. Wind-direction setting cannot be made. Wind-direction cannot be changed.		<ul style="list-style-type: none"> <li>● When air discharge temperature is low or during defrost operation, horizontal wind flow is made automatically.</li> <li>● Flap position is occasionally set up individually.</li> </ul>
When wind-direction is changed, flap operates several times and stops at designated position.		When wind-direction is changed, flap operates after searching for standard position.
Dust		Dust accumulation inside indoor unit is discharged.
Poor cooling or heating performance		<p>The indoor unit is initially designed to control the indoor temperature detected by the built-in room sensor inside the indoor unit.</p> <p>Due to indoor unit installation position, however, the built-in sensor may occasionally sense temperature improperly; for example, temperature difference between the ceiling and floor, lighting apparatus, electric fan, windows or waist-high partition walls, etc.</p> <p>In this case, the unit does not operate properly at the desired temperature.</p> <p>You may change the use of the temperature sensor inside the indoor unit to that of the remote controller.</p> <p>Then the desired room temperature can be controlled properly.</p> <p>For details, consult your dealer.</p>

## ● Check Before Requiring Services

Symptom	Cause	Remedy
Air conditioner does not run at all although power is turned on.	Power failure or after power failure	Press ON/OFF operation button on remote controller again.
	Operation button is turned off.	<ul style="list-style-type: none"> <li>● Switch on power if breaker is turned off.</li> <li>● If breaker has been tripped, consult your dealer without turning it on.</li> </ul>
	Fuse blow out.	If blown out, consult your dealer.
Poor cooling or heating performance	Air intake or air discharge port of indoor and outdoor units is clogged with dust or obstacles.	Remove dust or obstruction.
	Fan speed switch is set to "Low".*	Change to "Medium" or "High".*
	Improper temperature settings	Refer to "■ Tips for Energy Saving" on this page.
	Room is exposed to direct sunlight in cooling mode.	
	Doors and /or windows are open.	
	Air filter is clogged.	Refer to "■ Care and Cleaning" on page 1-11-2-29.
	Too much heat sources in room in cooling mode.	Use minimum heat sources and in a short time.
Too many people in room in cooling mode.	Reduce temperature settings or change to "Medium" or "High".*	

\* Fan speed display on the remote controller

High	:  (CZ-RTC4),  (CZ-RTC5A, CZ-RTC5B)
Medium	:  (CZ-RTC4),  (CZ-RTC5A, CZ-RTC5B)
Low	:  (CZ-RTC4),  (CZ-RTC5A, CZ-RTC5B)

If your air conditioner still does not work properly although you checked the points as described above, first stop the operation and turn off the power switch. Then contact your dealer and report the serial number and symptom. Never repair your air conditioner by yourself since it is very dangerous for you to do so.

## ■ Tips for Energy Saving

### Avoid

- Do not block the air intake and outlet of the unit. If either is obstructed, the unit will not work well, and may be damaged.
- Do not let direct sunlight into the room. Use sunshades, blinds or curtains. If the walls and ceiling of the room are warmed by the sun, it will take longer to cool the room.

### Do

- Always try to keep the air filter clean. (Refer to "■ Care and Cleaning".) A clogged filter will impair the performance of the unit.
- To prevent conditioned air from escaping, keep windows, doors and any other openings closed.

### NOTE

#### Should the power fail while the unit is running

If the power supply for this unit is temporarily cut off, the unit will automatically resume operation once power is restored using the same settings before the power was interrupted.

## IMPORTANT INFORMATION REGARDING THE REFRIGERANT USED

### NOTE

See "Outdoor Unit" under the Section 1-11. Installation Instructions.

### SERVICING



#### CAUTION

- Any qualified person who is involved with working on or breaking into a refrigerant circuit should hold a current valid certificate from an industry-accredited assessment authority, which authorizes their competence to handle refrigerants safely in accordance with an industry recognised assessment specification.
  - Servicing shall only be performed as recommended by the equipment manufacturer. Maintenance and repair requiring the assistance of other skilled personnel shall be carried out under the supervision of the person competent in the use of flammable refrigerants.
  - Servicing shall be performed only as recommended by the manufacturer.
  - Prior to beginning work on systems containing flammable refrigerants, safety checks are necessary to ensure that the risk of ignition is minimised. For repair to the refrigerating system, (2) to (6) shall be completed prior to conducting work on the system.
- (1) Work shall be undertaken under a controlled procedure so as to minimise the risk of a flammable gas or vapour being present while the work is being performed.
  - (2) All maintenance staff and others working in the local area shall be instructed on the nature of work being carried out. Work in confined spaces shall be avoided. The area around the workspace shall be sectioned off. Ensure that the conditions within the area have been made safe by control of flammable material.
  - (3) The area shall be checked with an appropriate refrigerant detector prior to and during work, to ensure the technician is aware of potentially toxic or flammable atmospheres. Ensure that the leak detection equipment being used is suitable for use with all applicable refrigerants, i.e. non-sparking, adequately sealed or intrinsically safe.
  - (4) If any hot work is to be conducted on the refrigeration equipment or any associated parts, appropriate fire extinguishing equipment shall be available to hand. Have a dry powder or CO<sub>2</sub> fire extinguisher adjacent to the charging area.
  - (5) No person carrying out work in relation to a refrigeration system which involves exposing any pipe work shall use any sources of ignition in such a manner that it may lead to the risk of fire or explosion. All possible ignition sources, including cigarette smoking, should be kept sufficiently far away from the site of installation, repairing, removing and disposal, during which refrigerant can possibly be released to the surrounding space. Prior to work taking place, the area around the equipment is to be surveyed to make sure that there are no flammable hazards or ignition risks. "No Smoking" signs shall be displayed.
  - (6) Ensure that the area is in the open or that it is adequately ventilated before breaking into the system or conducting any hot work. A degree of ventilation shall continue during the period that the work is carried out. The ventilation should safely disperse any released refrigerant and preferably expel it externally into the atmosphere.
  - (7) Where electrical components are being changed, they shall be fit for the purpose and to the correct specification. At all times the manufacturer's maintenance and service guidelines shall be followed. If in doubt, consult the manufacturer's technical department for assistance.
    - The charge size is in accordance with the room size within which the refrigerant containing parts are installed.
    - The ventilation machinery and outlets are operating adequately and are not obstructed.
    - Marking to the equipment continues to be visible and legible. Markings and signs that are illegible shall be corrected.
    - Refrigeration pipe or components are installed in a position where they are unlikely to be exposed to any substance which may corrode refrigerant containing components, unless the components are constructed of materials which are inherently resistant to being corroded or are suitably protected against being so corroded.
  - (8) Repair and maintenance to electrical components shall include initial safety checks and component inspection procedures. If a fault exists that could compromise safety, then no electrical supply shall be connected to the circuit until it is satisfactorily dealt with. If the fault cannot be corrected immediately but it is necessary to continue operation, an adequate temporary solution shall be used. This shall be reported to the owner of the equipment so all parties are advised.
 

Initial safety checks shall include:

    - That no live electrical components and wiring are exposed while charging, recovering or purging the system.
    - That there is continuity of earth bonding.
- During repairs to sealed components, all electrical supplies shall be disconnected from the equipment being worked upon prior to any removal of sealed covers, etc.
  - Particular attention shall be paid to the following to ensure that by working on electrical components, the casing is not altered in such a way that the level of protection is affected. This shall include damage to cables, excessive number of connections, terminals not made to original specification, damage to seals, incorrect fitting of glands, etc.
  - Ensure that apparatus is mounted securely.
  - Ensure that seals or sealing materials have not degraded such that they no longer serve the purpose of preventing the ingress of flammable atmospheres.
  - Replacement parts shall be in accordance with the manufacturer's specifications.

#### NOTE:

The use of silicon sealant may inhibit the effectiveness of some types of leak detection equipment. Intrinsically safe components do not have to be isolated prior to working on them.

- Do not apply any permanent inductive or capacitance loads to the circuit without ensuring that this will not exceed the permissible voltage and current permitted for the equipment in use.
- Intrinsically safe components are the only types that can be worked on while live in the presence of a flammable atmosphere.
- The test apparatus shall be at the correct rating.
- Replace components only with parts specified by the manufacturer. Unspecified parts by manufacturer may result ignition of refrigerant in the atmosphere from a leak.

## ■ REMOVAL AND EVACUATION



### CAUTION

- When breaking into the refrigerant circuit to make repairs – or for any other purpose – conventional procedures shall be used. However, it is important that best practice is followed since flammability is a consideration. The following procedure shall be adhered to:
  - Remove refrigerant.
  - Purge the circuit with inert gas.
  - Evacuate.
  - Purge again with inert gas.
  - Open the circuit by cutting or brazing.
- The refrigerant charge shall be recovered into the correct recovery cylinders.
- The system shall be “flushed” with Oxygen free nitrogen (OFN) to render the unit safe.
- This process may need to be repeated several times.
- Compressed air or oxygen shall not be used for this task.
- Flushing shall be achieved by breaking the vacuum in the system with Oxygen free nitrogen (OFN) and continuing to fill until the working pressure is achieved, then venting to atmosphere, and finally pulling down to a vacuum.
- This process shall be repeated until no refrigerant is within the system.
- When the final Oxygen free nitrogen (OFN) charge is used, the system shall be vented down to atmospheric pressure to enable work to take place.
- This operation is absolutely vital if brazing operations on the pipe work are to take place.
- Ensure that the outlet for the vacuum pump is not close to any ignition sources and there is ventilation available.

## ■ CHARGING PROCEDURES

### NOTE

See “■ Outdoor Unit” under the Section 1-11. Installation Instructions.

## ■ DECOMMISSIONING



### CAUTION

- Before carrying out this procedure, it is essential that the technician is completely familiar with the equipment and all its details.
- It is recommended good practice that all refrigerants are recovered safely.
- Prior to the task being carried out, an oil and refrigerant sample shall be taken in case analysis is required prior to re-use of reclaimed refrigerant.
- It is essential that electrical power is available before the task is commenced.
  - a) Become familiar with the equipment and its operation.
  - b) Isolate system electrically.
  - c) Before attempting the procedure ensure that:
    - Mechanical handling equipment is available, if required, for handling refrigerant cylinders.
    - All personal protective equipment is available and being used correctly.
    - The recovery process is supervised at all times by a competent person.
    - Recovery equipment and cylinders conform to the appropriate standards.
  - d) Pump down refrigerant system, if possible.
  - e) If a vacuum is not possible, make a manifold so that refrigerant can be removed from various parts of the system.
  - f) Make sure that cylinder is situated on the scales before recovery takes place.
  - g) Start the recovery machine and operate in accordance with manufacturer’s instructions.
  - h) Do not overfill cylinders. (No more than 80 % volume liquid charge).
  - i) Do not exceed the maximum working pressure of the cylinder, even temporarily.
  - j) When the cylinders have been filled correctly and the process completed, make sure that the cylinders and the equipment are removed from site promptly and all isolation valves on the equipment are closed off.
  - k) Recovered refrigerant shall not be charged into another refrigeration system unless it has been cleaned and checked.
- Electrostatic charge may accumulate and create a hazardous condition when charging or discharging the refrigerant. To avoid fire or explosion, dissipate static electricity during transfer by grounding and bonding containers and equipment before charging / discharging.

## ■ RECOVERY

### NOTE

See “12. Recovery” on page 1-11-1-6.



Option Parts

■ Air Intake Chamber

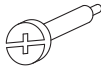


CZ-FDU3

Installation Instructions

Accessory parts

The accessory parts are required for the installation work so they should not be discarded until the work is completed.

- The following parts are provided inside the package so check that they are accounted for.

Part name	No. of parts	Part name	No. of parts	Part name	No. of parts
Screws (5 x 40)  (Used to secure this Air intake chamber)	4	Washers  (Used to secure this Air intake chamber)	4	Installation instructions 	1

Mounting procedure

Before proceeding with the mounting, remove the cushions which have been inserted into the air outlets (in 4 places).

<1> Mounting Air intake chamber (Fig. 1-11-4)

- Place the black sealant side of Air intake chamber toward the indoor unit.  
(Air intake chamber can be mounted correctly in only one way so ensure that the shapes of the indoor unit and chamber are aligned properly.)
- Use the accessory screws (x4) to secure the indoor unit and Air intake chamber.

<2> Installing the indoor unit

- Install the indoor unit with Air intake chamber mounted on it to the ceiling.  
(Now proceed with the installation in accordance with the installation instructions provided with the indoor unit.)

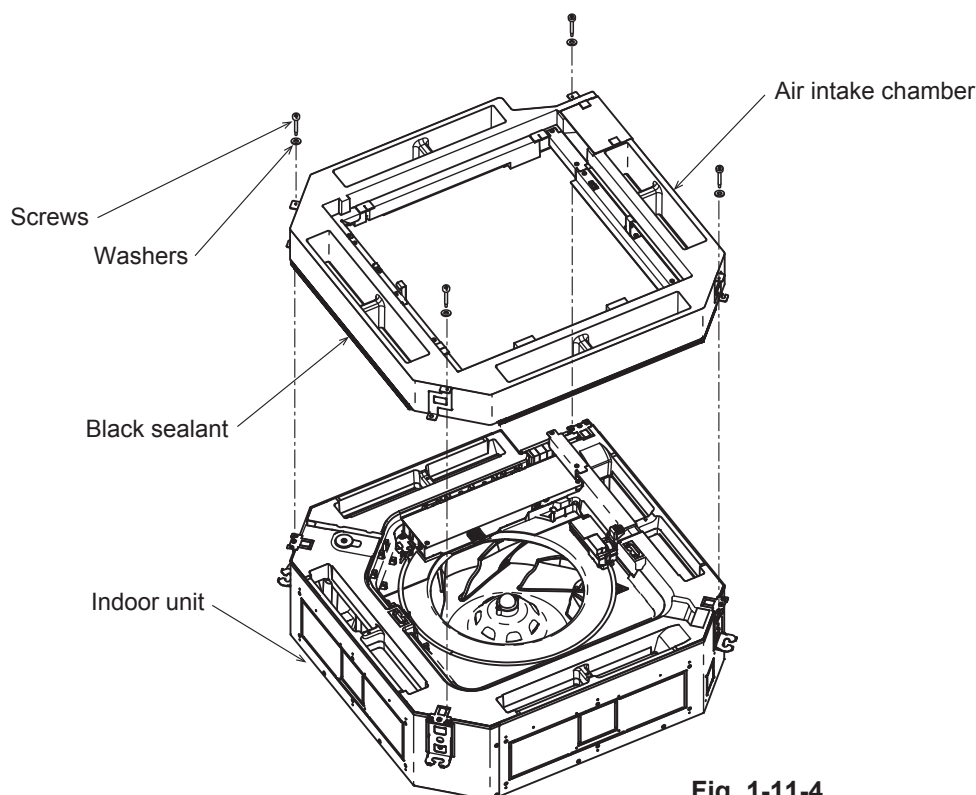


Fig. 1-11-4

<3> Mounting the ceiling panel (Fig. 1-11-5)

- Mount the ceiling panel to the indoor unit (with Air intake chamber).  
(For details on how the ceiling panel is to be mounted, refer to the installation instructions which are provided with the ceiling panel.)

<4> Connecting the panel cables (Fig. 1-11-5)

- Remove the cover of Air intake chamber, and remove the cover of electrical component box.
- Cut the clamp used to bundle the ceiling panel cable, insert the 22P connector (white) of the cable into the through-hole in Air intake chamber, and connect it to the 22P connector inside the electrical component box.
- Return the cover of electrical component box and the cover of Air intake chamber to their original positions.

Mounting procedure (continued)

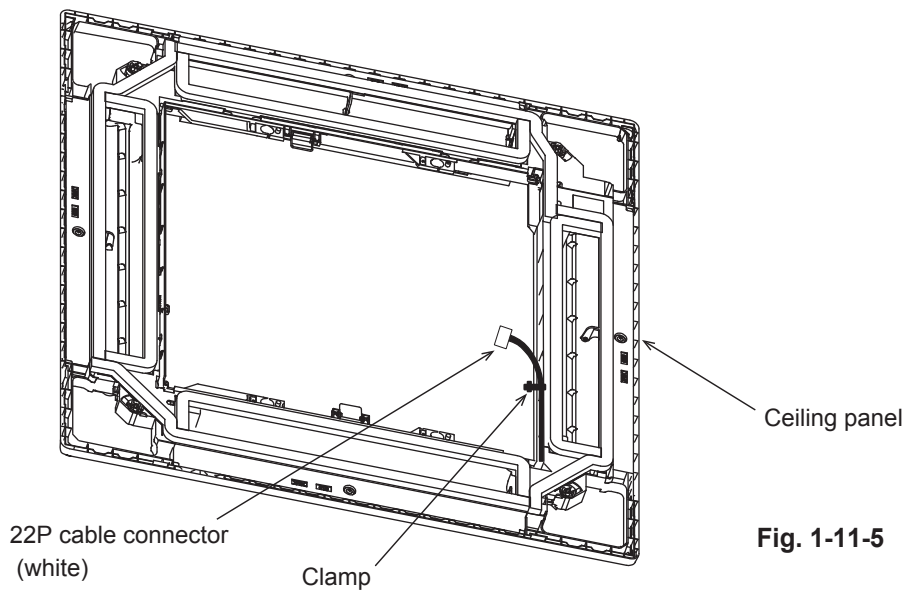
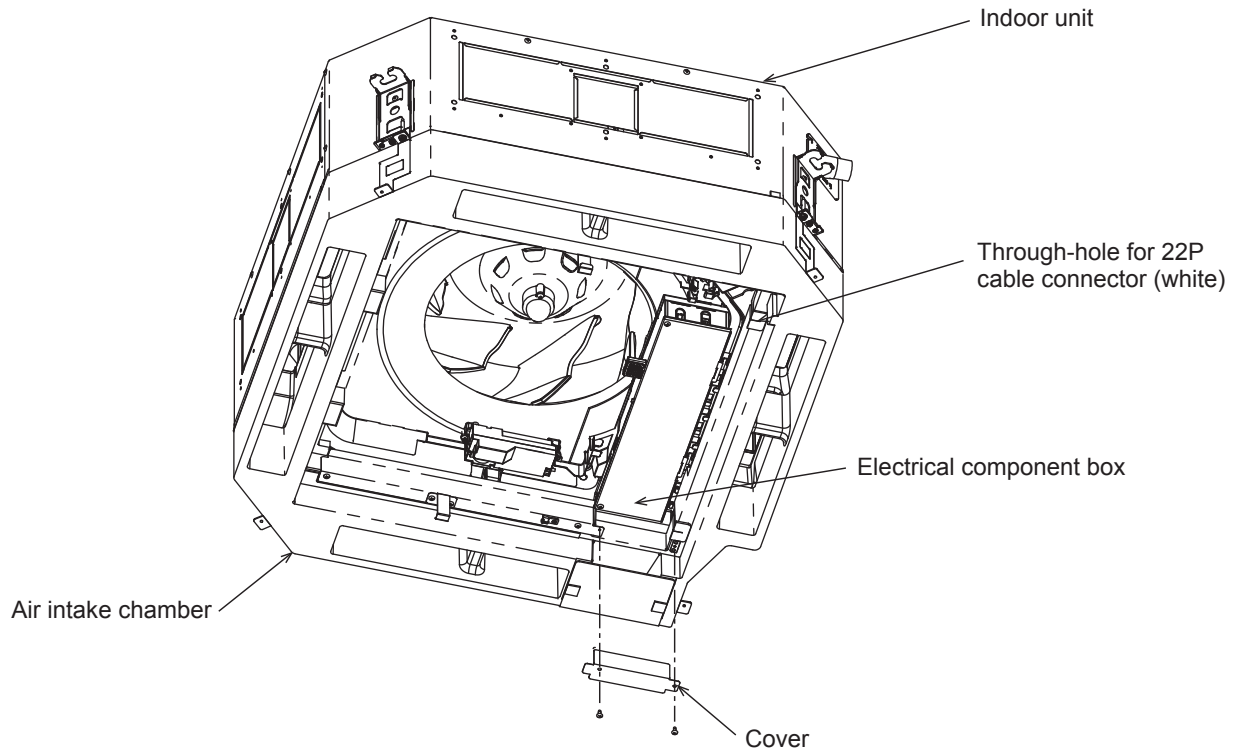


Fig. 1-11-5

## Selecting the DC fan motor taps

It is necessary to set the fan speed in accordance with the intended application and the optional parts to be used if any such part is used. (Table 1-11-1)

If this speed is not changed, a reduction in the air flow may result, causing the air outlet temperature to drop and condensation to form during cooling.

There are two ways to set the fan speed: either (1) change the positions of the DIP switches on the indoor unit control PCB or (2) set the speed using the wired remote controller. Select one of these ways.

\* Priority is given to setting the fan speed by changing the positions of the DIP switches.

**Table 1-11-1** DC fan motor tap setting table

Setting No	Item code 5D/5d setting data	Intended application / name of optional parts	Setting No	Item code 5D/5d setting data	Intended application / name of optional parts
	0000	Standard (factory setting)	(1)	0001	Air-flow blocking kit(for 3-way air flow)
(1)	0001	High-ceiling setting 1 (with standard, ECONAVI panel)	(3)	0003	High-ceiling setting 2 (with standard, ECONAVI panel)
		Air-flow blocking kit (when a duct is connected.)	(6)	0006	Air-flow blocking kit (for 2-way air flow)

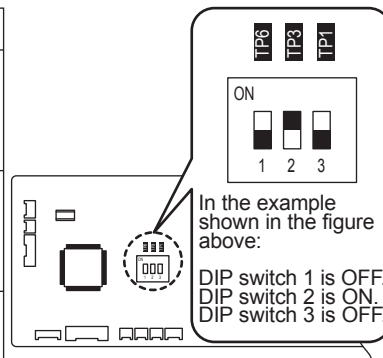
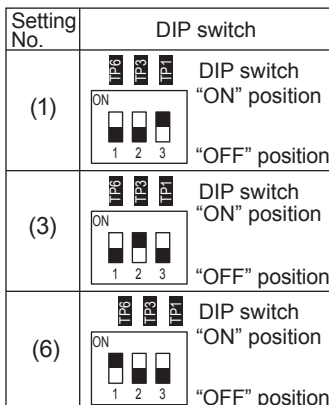
### (1) When setting the fan speed by changing the positions of the DIP switches on the indoor unit control PCB

<Procedure> Be absolutely sure to turn off the power (earth-leakage circuit breaker).

<1> On Table 1-11-1, check out the "Setting No." that corresponds to the intended application and the optional parts to be used.

<2> Open the cover of the electrical component box, and check the indoor unit control PCB. (Fig. 1-11-6)

<3> Select the Setting No. which was checked out on Table 1-11-1, and change the positions of the DIP switches on the indoor unit control PCB.



**Fig. 1-11-6** Indoor unit control PCB

### (2) When setting the fan speed using a wired remote controller (optional parts: CZ-RTC5A, CZ-RTC5B)

On Table 1-11-1, check out the "Item code 5D setting data" that corresponds to the intended application and the optional parts to be used.

<Procedure> Ensure that the unit has stopped operating before changing the fan speed.

<1> Hold down the + + buttons together for at least 4 seconds.

The maintenance function screen is displayed.

<2> Use the / buttons to select the display and the / buttons to select the page.

Select "8. Detailed settings" and press the button.

The [Detailed settings screen] appears.

Using the / buttons, select the unit No.

<3> Using the / buttons, select the item code.

Using the / buttons, change the item code to "5D."

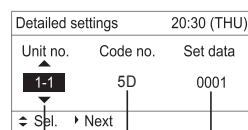
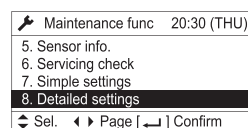
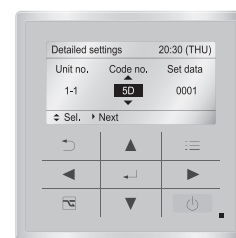
<4> Using the / buttons, select the setting data.

Using the / buttons, change the setting data to the value checked out on Table 1-11-1, and press the button.

<5> After selecting the unit No. using the / buttons, press the button.

The [Detailed settings completion screen] appears.

Select "Yes", and press the .



Unit No.                      Setting data  
Item code

### (3) When setting the fan speed using a wired remote controller (optional parts: CZ-RTC4)

On Table 1-11-1, check out the "Item code 5d setting data" that corresponds to the intended application and the optional parts to be used.

<Procedure> Ensure that the units have stopped operating before changing the fan speed.

<1> Hold down the + + buttons together for at least 4 seconds.

<2> Each time the button is pressed, the numbers of the indoor units under group control are displayed in sequence.

The fan motor of only the indoor unit that has been selected will run.

<3> Specify item code "5d" using the temperature setting () / () buttons.

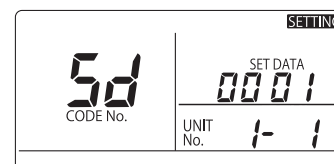
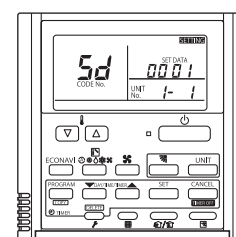
<4> Change the setting data using the hour buttons. The setting data details are as given on Table 1-11-1.

<5> Press the button. (OK if the display changes from flashing to lighted.)

<6> Press the button. The normal stop status is established.

Go to step <2> to change the selected indoor unit.

<7> Press the button. The normal stop status is established.



■ Air-flow Blocking Kit

CZ-CFU3

Installation Instructions

Accessory parts

The accessory parts are required for the installation work so they should not be discarded until the work is completed.

Part name	No. of parts	Part name	No. of parts	Part name	No. of parts
Air-flow blocker (470×65×T10)	3	Sealer (570×90×T2)	2	Installation instructions	1
A:2					
B:1					

Mounting procedure

(1) Checking where the air-flow blocker is to be attached

For Air outlet<1>  
When Air-flow blocker A is to be attached, cut it in parallel with the slit. (Fig. 1-11-7)  
For Air outlet<2>  
Air-flow blocker B can be used as is.  
For Air outlet<3>or<4>  
Air-flow blocker A can be used as is.

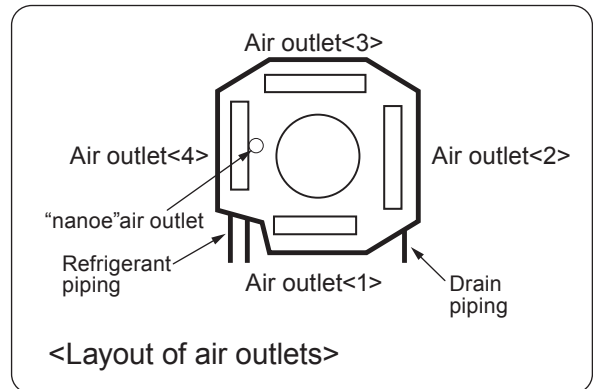
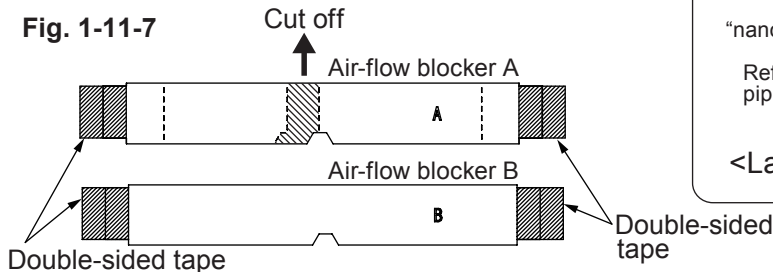
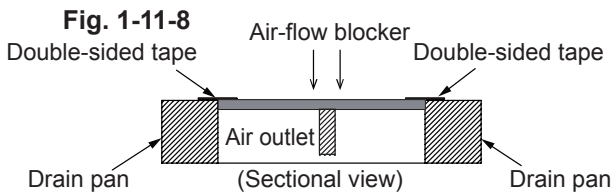


Fig. 1-11-7

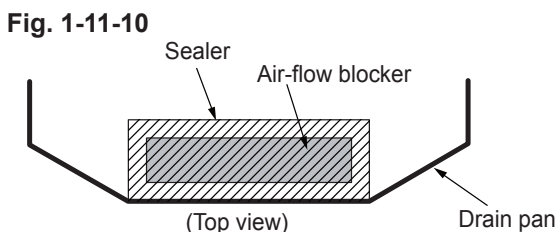
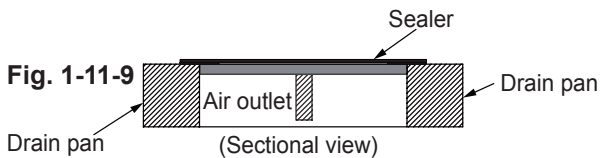


(2) Fit the air-flow blocker into place to match the shape of the air outlet, adhere the tape of the both side of air-flow blocker to the drain pan and adhere the sealer on top to block the passage of air. (Fig. 1-11-8) (Fig. 1-11-9)

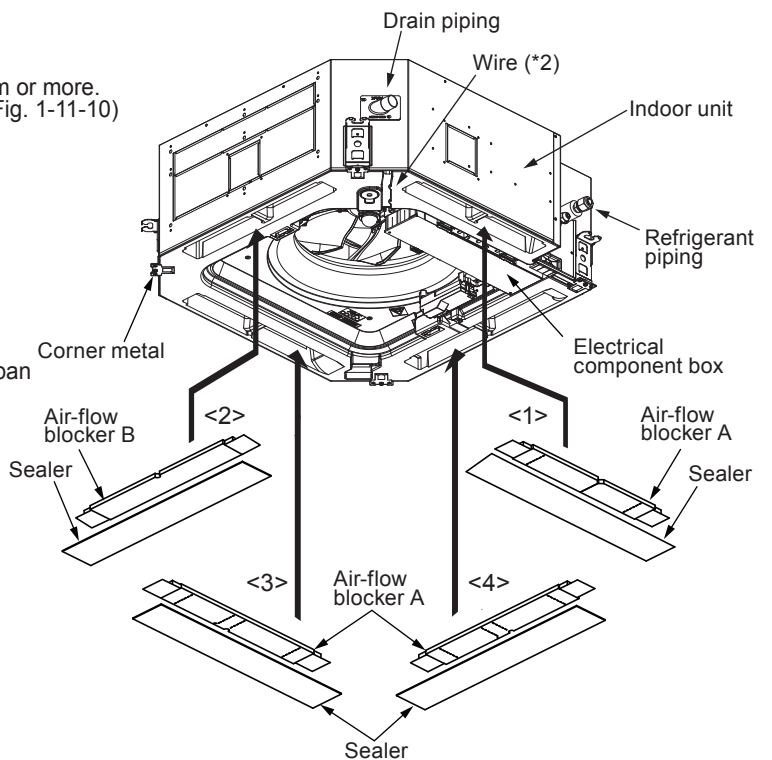


(3) Adhere the sealer to the drain pan with an overlap of 10 mm or more. (Condensation may form if it is adhered with no overlap.) (Fig. 1-11-10)

- \*1 Ensure that the sealer does not come into contact with the corner metal fitting.
  - \*2 Cut the sealer diagonally so that no contact is made with the wire.
- Fold the protruding parts of the sealer over the side panel, and adhere them into place.



Please affix in accordance with the end of the drain pan.



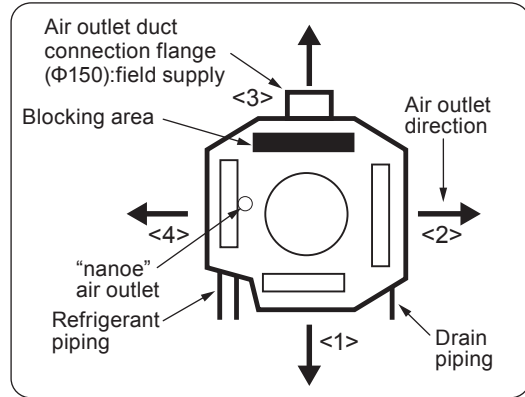
### Air outlet blocking patterns

#### As seen from underneath the indoor unit

- When a 2- or 3-way air outlet configuration is used or when the air outlet duct connection flange (Φ150):field supply is connected, block the air outlets as per the air outlet blocking patterns illustrated below. Also, refer to the table below, and decide on where the pipings are to be positioned. (To better understand what the illustrations show, refer to the figure on the right.)

Note: Take care to prevent cold air leaks and deficient insulation while performing the air outlet duct connection flange (Φ150):field supply work in order to prevent condensation from forming.

- It should be borne in mind that any air outlet blocking pattern with the hatching mark will make it impossible for the “nanoe” nano-technology fine particle function to work.
- Under no circumstances must any air outlet blocking patterns not shown in the table below be used.



3-way air outlet One outlet can be blocked.				
2-way air outlet Two outlets can be blocked.				
Air outlet duct connection flange (Φ150):field supply connection 3-way air outlet One outlet can be blocked and connected to a duct.				
Air outlet duct connection flange (Φ150):field supply connection 2-way air outlet Two outlets can be blocked and connected to a duct.  Note: The duct can be connected only in one of the locations shown.				

#### Changing the DC fan tap settings

While referring to “Selecting the DC fan motor taps,” change the DC fan speed by using the wired remote controller or by setting the DIP switches on the indoor unit control PCB.

## Selecting the DC fan motor taps

It is necessary to set the fan speed in accordance with the intended application and the optional parts to be used if any such part is used. (Table 1-11-2)

If this speed is not changed, a reduction in the air flow may result, causing the air outlet temperature to drop and condensation to form during cooling.

There are two ways to set the fan speed: either (1) change the positions of the DIP switches on the indoor unit control PCB or (2) set the speed using the wired remote controller. Select one of these ways.

\* Priority is given to setting the fan speed by changing the positions of the DIP switches.

**Table 1-11-2** DC fan motor tap setting table

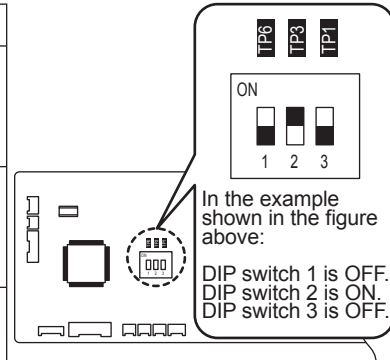
Setting No	Item code 5D/5d setting data	Intended application / name of optional parts	Setting No	Item code 5D/5d setting data	Intended application / name of optional parts
	0000	Standard (factory setting)	(1)	0001	Air-flow blocking kit(for 3-way air flow)
(1)	0001	High-ceiling setting 1 (with standard, ECONAVI panel)	(3)	0003	High-ceiling setting 2 (with standard, ECONAVI panel)
		Air-flow blocking kit (when a duct is connected.)	(6)	0006	Air-flow blocking kit (for 2-way air flow)

### (1) When setting the fan speed by changing the positions of the DIP switches on the indoor unit control PCB

<Procedure> Be absolutely sure to turn off the power (earth-leakage circuit breaker).

- <1> On Table 1-11-2, check out the "Setting No." that corresponds to the intended application and the optional parts to be used.
- <2> Open the cover of the electrical parts box, and check the indoor unit control PCB. (Fig. 1-11-11)
- <3> Select the Setting No. which was checked out on Table 1-11-2, and change the positions of the DIP switches on the indoor unit control PCB.

Setting No.	DIP switch
(1)	<p>DIP switch "ON" position</p> <p>"OFF" position</p>
(3)	<p>DIP switch "ON" position</p> <p>"OFF" position</p>
(6)	<p>DIP switch "ON" position</p> <p>"OFF" position</p>



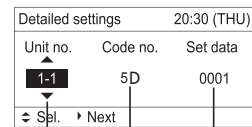
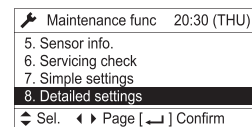
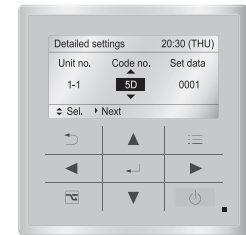
**Fig. 1-11-11**  
Indoor unit control PCB

### (2) When setting the fan speed using a wired remote controller (optional parts: CZ-RTC5A, CZ-RTC5B)

On Table 1-11-2, check out the "Item code 5D setting data" that corresponds to the intended application and the optional parts to be used.

<Procedure> Ensure that the unit has stopped operating before changing the fan speed.

- <1> Hold down the + + buttons together for at least 4 seconds. The maintenance function screen is displayed.
- <2> Use the / buttons to select the display and the / buttons to select the page.  
Select "8. Detailed settings" and press the button. The [Detailed settings screen] appears.  
Using the / buttons, select the unit No.
- <3> Using the / buttons, select the item code.  
Using the / buttons, change the item code to "5D."
- <4> Using the / buttons, select the setting data.  
Using the / buttons, change the setting data to the value checked out on Table 1-11-2, and press the button.
- <5> After selecting the unit No. using the / buttons, press the button. The [Detailed settings completion screen] appears.  
Select "Yes", and press the button.



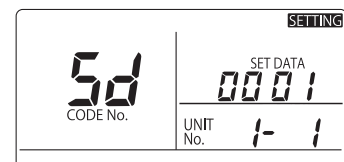
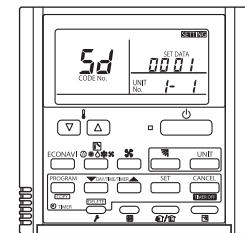
Unit No.      Setting data  
Item code

### (3) When setting the fan speed using a wired remote controller (optional parts: CZ-RTC4)

On Table 1-11-2, check out the "Item code 5d setting data" that corresponds to the intended application and the optional parts to be used.

<Procedure> Ensure that the units have stopped operating before changing the fan speed.

- <1> Hold down the + + buttons together for at least 4 seconds.
- <2> Each time the button is pressed, the numbers of the indoor units under group control are displayed in sequence.  
The fan motor of only the indoor unit that has been selected will run.
- <3> Specify item code "5d" using the temperature setting ( / ) buttons.
- <4> Change the setting data using the hour buttons. The setting data details are as given on Table 1-11-2.
- <5> Press the button. (OK if the display changes from flashing to lighted.)
- <6> Press the button. The normal stop status is established.  
Go to step <2> to change the selected indoor unit.
- <7> Press the button. The normal stop status is established.



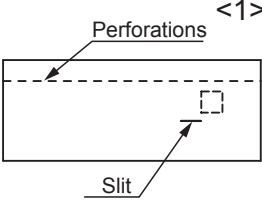
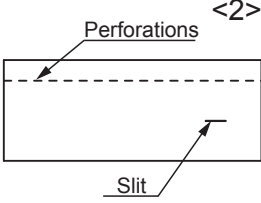
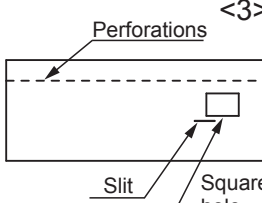
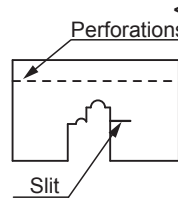
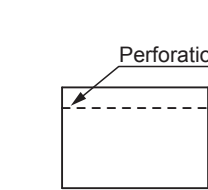

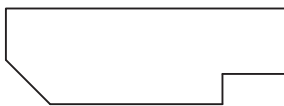
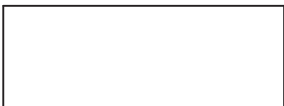



■ Thermal Insulation Kit

CZ-INSU3

Installation Instructions

Parts installed on the indoor unit

● Details of parts

Part name	Side panel insulator	Side panel insulator	Side panel insulator	Side panel insulator
Shape				
No. of parts	1	1	1	1
Part name	Side panel insulator	Side panel insulator	Ceiling insulator	Ceiling insulator
Shape				
No. of parts	1	1	1	1
Part name	Ceiling insulator	Hanger insulator	Installation instructions	
Shape				
No. of parts	1	4	1	

● Procedure for attaching the parts

\* Indoor unit has two kinds of heights.(Large unit=319mm, Small unit=256mm)

When attaching the side panel insulator to the small unit, attach it after cutting along its perforations of the parts<1> to <5>

1. Align the slits of the side panel insulators <1> to <4> with the hanger, and attach the parts to the side panels of the indoor unit. (Fig. 1-11-12)
2. Now attach the side panel insulator <5> to the side panel of the indoor unit. (Fig. 1-11-12)
3. Align the side panel insulator <6> with the piping cover, and attach the part. (Fig. 1-11-12)
4. Attach the ceiling insulators <7> to <9> in such a way that no gaps are left. (Fig. 1-11-13)

Do the following procedures after installing the indoor unit.

5. Attach the hanger insulators <10> to the hangers in the directions shown in the figure. (Fig. 1-11-14)

\* Keep hanger insulator<10> until installing the indoor unit.

Parts installed on the indoor unit (continued)

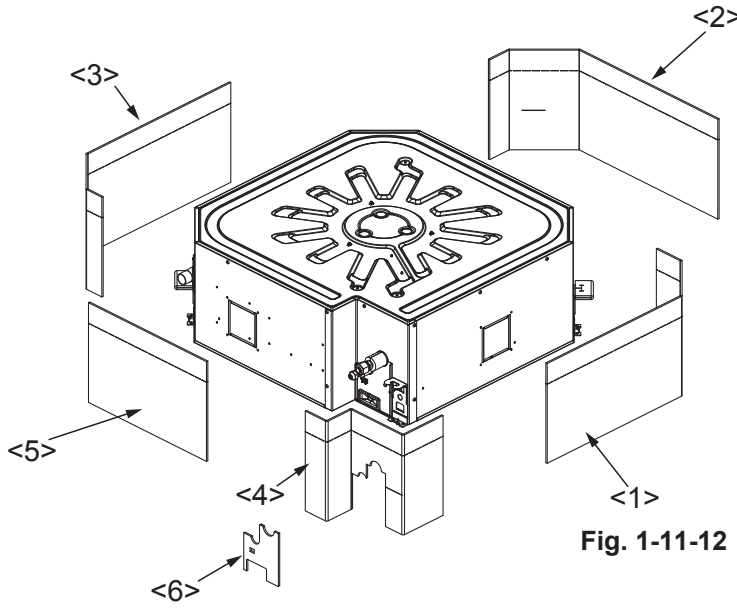


Fig. 1-11-12

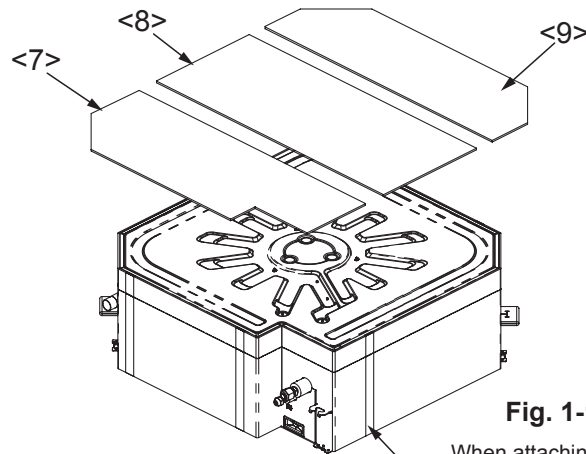


Fig. 1-11-13

When attaching the insulators, ensure that they overlap. (Side insulators <1> to <5>)

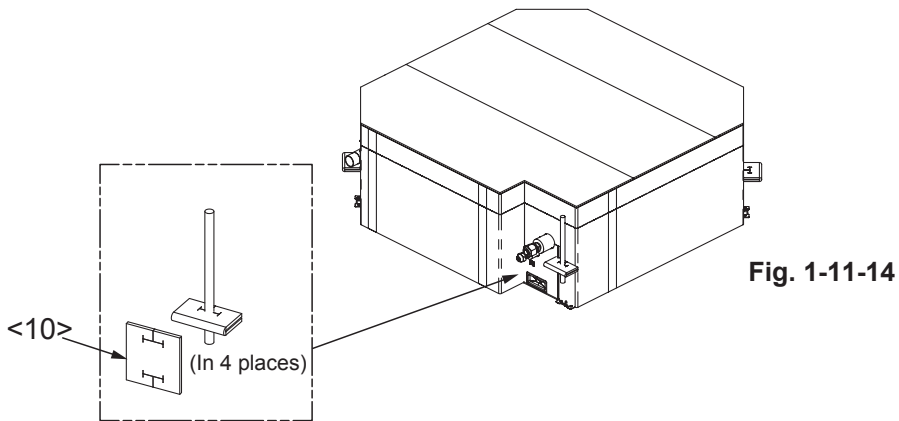


Fig. 1-11-14



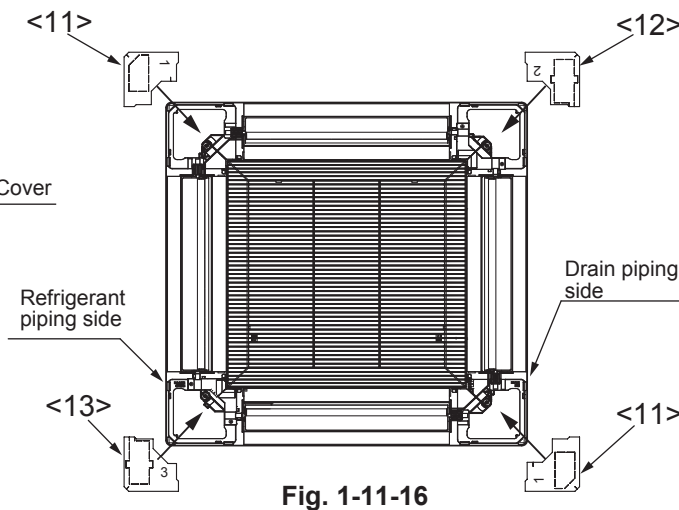
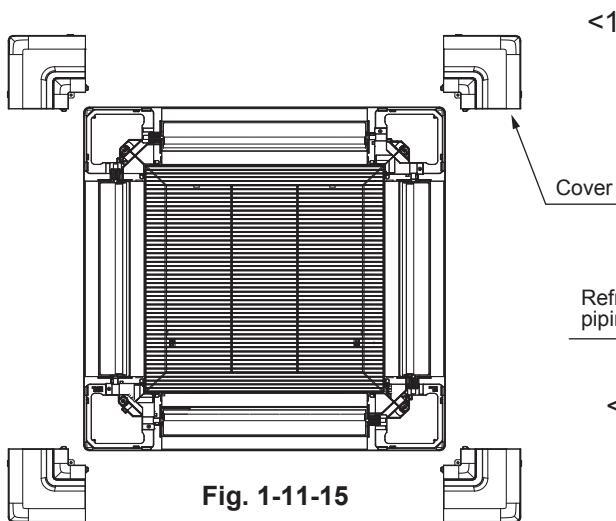
Parts mounted on ceiling panels

● Details of parts

Part name	Insulator	Insulator	Insulator	Insulator	Insulator	Insulator
Shape	<p>&lt;11&gt;</p>	<p>&lt;12&gt;</p>	<p>&lt;13&gt;</p>	<p>&lt;14&gt;</p>	<p>&lt;15&gt;</p>	<p>&lt;16&gt;</p>
No. of parts	2	1	1	2	1	1

● Procedure for attaching the parts

1. Remove the covers in the four corners. (Fig. 1-11-15)
2. Fit the ceiling panel to the indoor unit.  
(For details on how the ceiling panel is to be fitted, refer to the installation instructions which are provided with the ceiling panel.)
3. Fit the insulators <11> to <13> onto the four corners of the ceiling panel exactly as shown in Fig. 1-11-16.
4. Fit the cover in place. The cover can fall off in this state so be absolutely sure to secure it in place using the fixing screws.



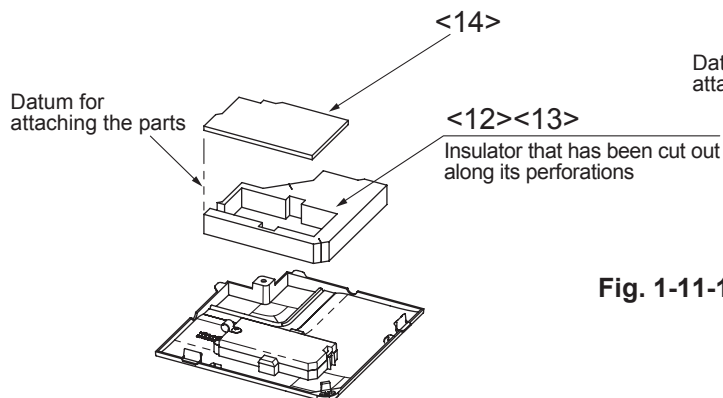
<When mounting the parts onto the receivers (Fig. 1-11-17)>

Cut out along the perforations the insulators <11>, <12> and/or <13> that fit the mounting location, mount them by matching them to the shape of each receiver, and attach the covers to the ceiling panel.

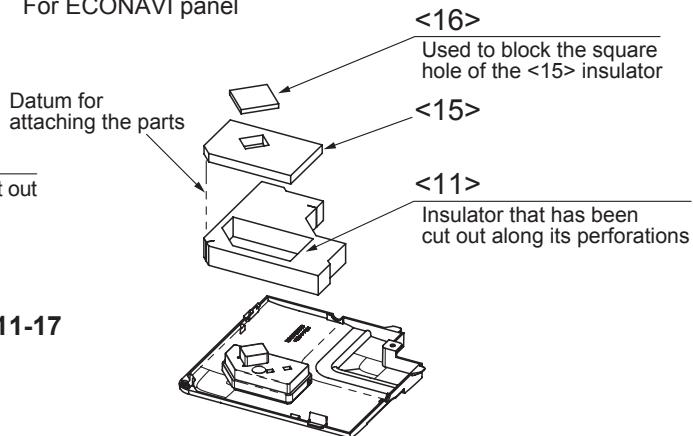
\* Be absolutely sure to use the maximum dimensions of 910 mm x 910 mm for the extent of the ceiling opening so that the ceiling surface and insulators will not absorb any shocks.

(For details on how the ceiling panel is to be fitted, refer to the installation instructions which are provided with the ceiling panel.)

For Wireless remote controller receiver



For ECONAVI panel



## ■ SELECTING THE INSTALLATION SITE

### 3. Ceiling Type (T2)

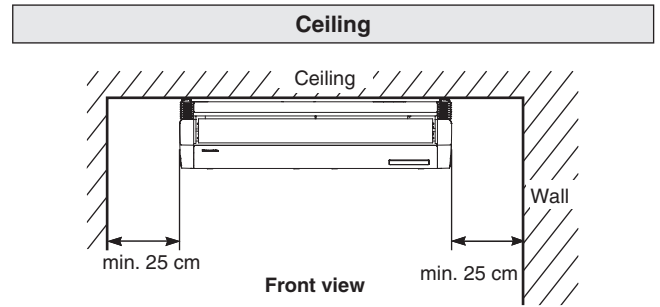
#### Indoor Unit

#### AVOID:

- areas where leakage of flammable gas may be expected.
- places where large amounts of oil mist exist.
- direct sunlight.
- locations near heat sources which may affect the performance of the unit.
- locations where external air may enter the room directly. This may cause “condensation” on the air discharge ports, causing them to spray or drip water.
- locations where the remote controller will be splashed with water or affected by dampness or humidity.
- installing the remote controller behind curtains or furniture.
- locations where high-frequency emissions are generated.

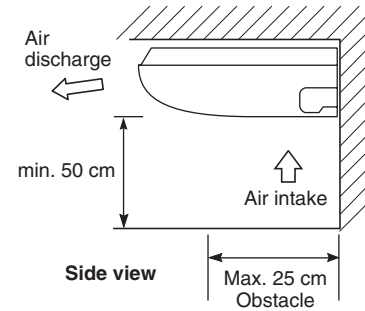
#### DO:

- select an appropriate position from which every corner of the room can be uniformly cooled.
- select a location where the ceiling is strong enough to support the weight of the unit.
- select a location where tubing and drain pipe have the shortest run to the outdoor unit.
- allow room for operation and maintenance as well as unrestricted air flow around the unit.
- the limitation of the tubing length between the indoor and the outdoor units should be referred to the Installation Instructions of the outdoor unit.
- allow room for mounting the remote controller about 1 m off the floor, in an area that is not in direct sunlight or in the flow of cool air from the indoor unit.



#### NOTE

The rear of the indoor unit can be installed flush against the wall.



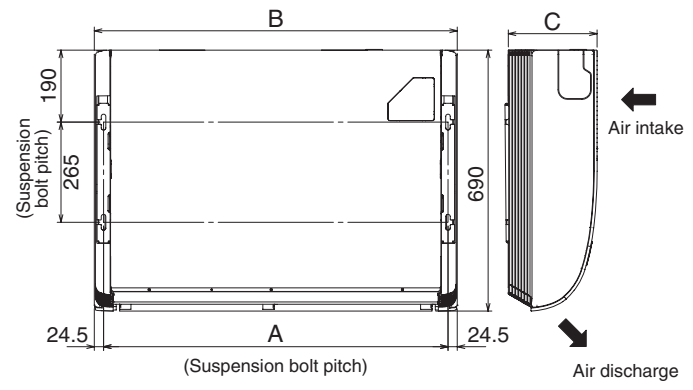
■ HOW TO INSTALL THE INDOOR UNIT

Required Minimum Space for Installation and Service

(1) Dimensions of suspension bolt pitch and unit

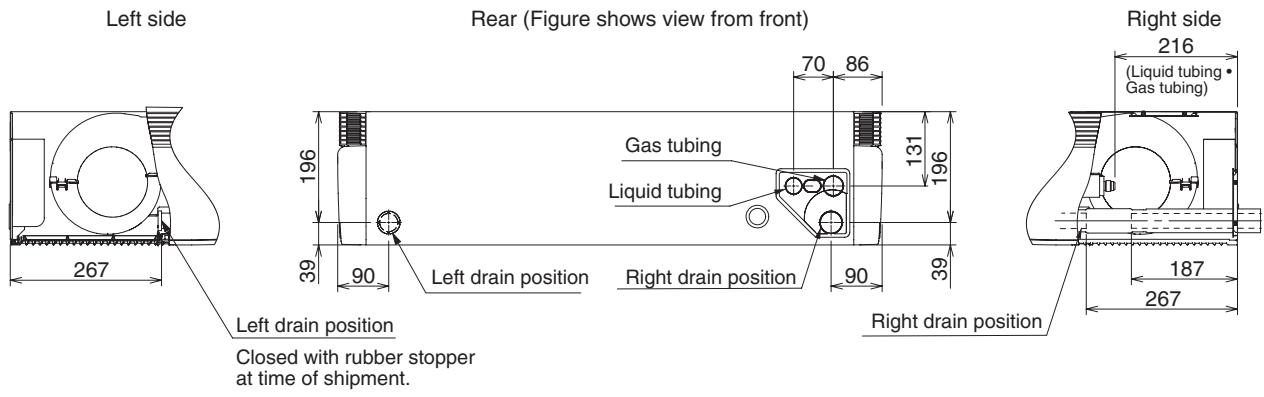
Type	Length	A	B	C
50		911	960	235
60, 71		1226	1275	235
100, 125, 140		1541	1590	235

Unit: mm



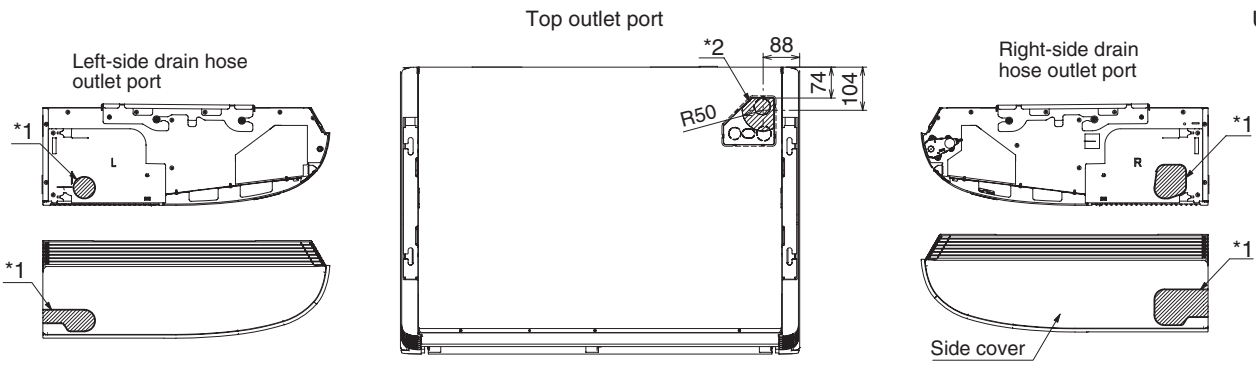
(2) Refrigerant tubing • drain hose position

Unit: mm

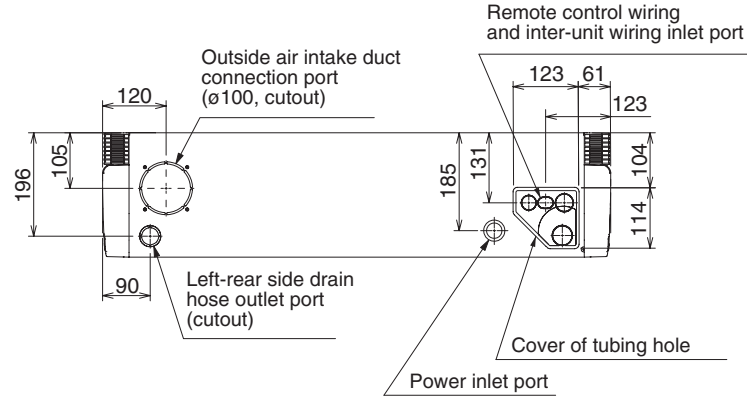


(3) Unit opening position (Refrigerant tubing • drain hose • power inlet port • remote control wiring inlet port)

Unit: mm



Rear outlet port (Figure shows view from front)



\*1 Use a compass saw, jigsaw or similar tool and cut along the indented portion of the side cover and make a hole inside the cover.

\*2 When removing the refrigerant tubing from the upper side, cut along the indented portion and pass the tubing through the hole.

**NOTE**

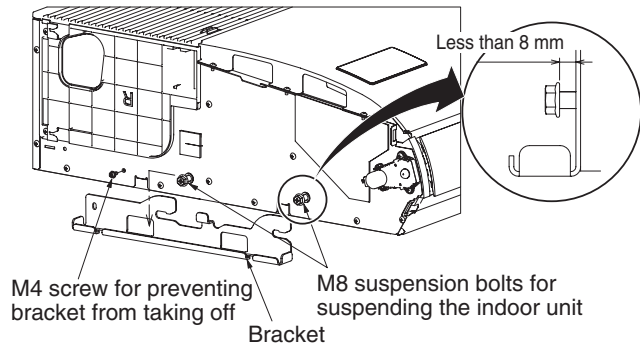
Be sure to use sealing putty to seal off the opening to prevent dust.

## Preparation Before Installation

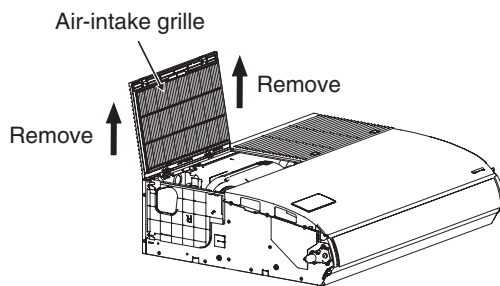
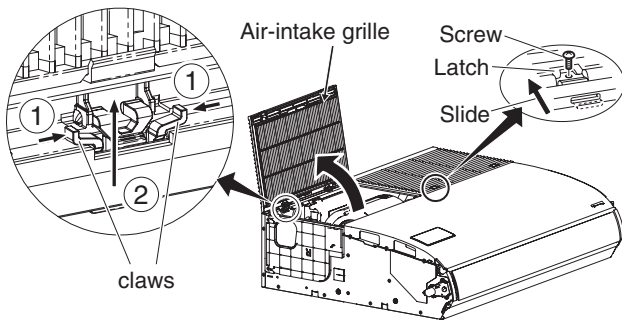
- (1) Remove the bracket (for suspending the indoor unit).  
Loose the M8 suspension bolts.  
Then remove the bracket.

**NOTE**

Loosen the M8 suspension bolts and expose the axis of bolts less than 8 mm.

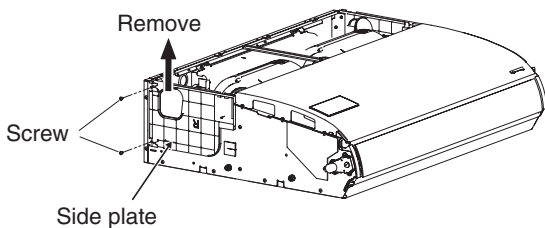


- (2) Remove the air-intake grille before suspending the indoor unit. First, remove 2 attachment screws fixed with the latches. Open the air-intake grille and hold the claws of the hinges on both sides. Then remove the air-intake grille and suspension lug located on the left and right side of the indoor unit.

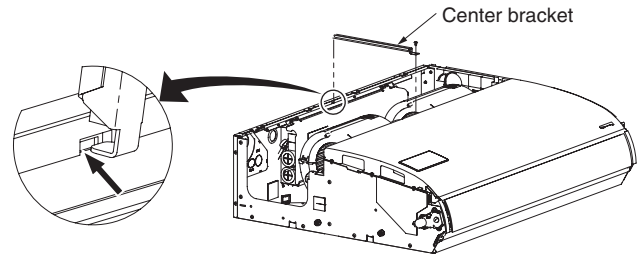


- (3) Remove the side plate to the tubing side.

Rear & upper side tubing connection	Remove 2 screws. Slide the side plate in the direction of the arrow and remove it.
Right side tubing connection	Do not remove the side plate.



- (4) Remove the center bracket.  
When wiring, remove the center bracket if necessary.  
When wiring is completed, reinstall the center bracket in its original position.

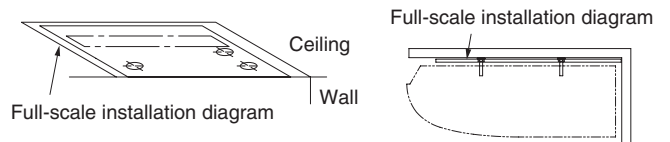


## Suspending the Indoor Unit

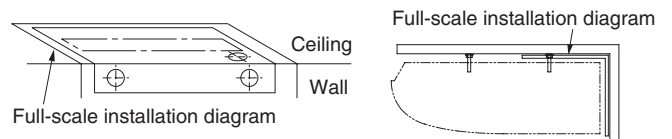
**NOTE**

Since the diagram is made of paper, it may shrink or stretch slightly because of high temperature or humidity. For this reason, before drilling the holes maintain the correct dimensions between the markings.

- (1) If the full-scale installation diagram is placed on the ceiling, the locations of each suspension bolt can be chosen. Take a pencil and mark the drill holes.



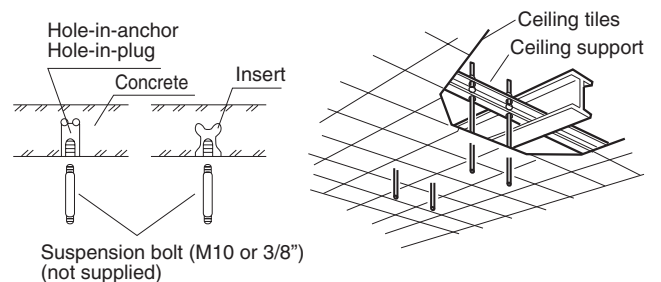
- (2) If the full-scale installation diagram is bent at right angle to the ceiling and wall, the locations of the inlet for indoor tubing and wiring are chosen and the locations of each suspension bolt can also be chosen. Take a pencil and mark the drill holes.



**NOTE**

The dimension when the indoor unit is placed tightly against the wall.  
When installing away from the wall, drainage gradient should be taken into consideration.

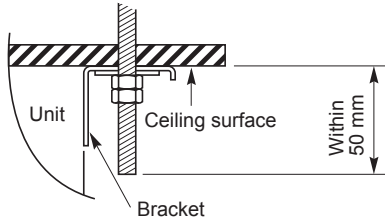
- (3) Drill holes at the 4 points indicated on the full-scale diagram.
- (4) Depending on the ceiling type:
  - a) Insert suspension bolts.
  - or
  - b) Use existing ceiling supports or construct a suitable support.



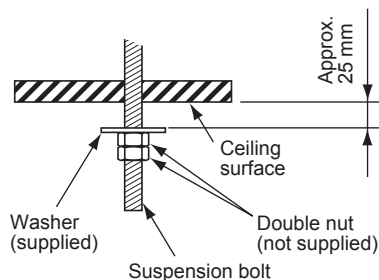
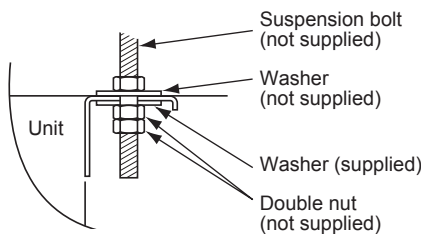
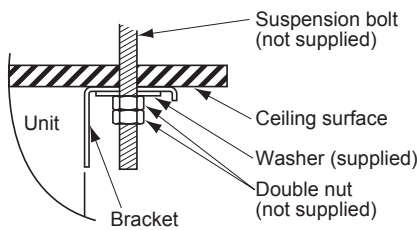
**! WARNING**

It is important that you use extreme care in supporting the indoor unit from the ceiling. Ensure that the ceiling is strong enough to support the weight of the unit. Before hanging the ceiling unit, test the strength of each attached suspension bolt.

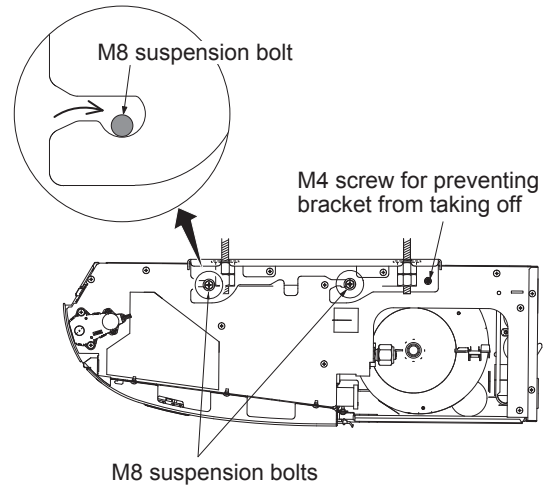
- (5) Screw in the suspension bolts, allowing them to protrude from the ceiling. The distance of each exposed bolt must be of equal length within 50 mm.



- (6) Carry out the preparation for suspending the indoor unit. The suspension method varies depending on whether there is a suspended ceiling or not.
- (7) Suspend the indoor unit as follows:
  - a) Install the bracket to the suspension bolt. Stick it onto the ceiling surface.



- b) Suspend the indoor unit to the bracket. Tighten the M8 suspension bolts and fix the indoor unit in place.



**NOTE**

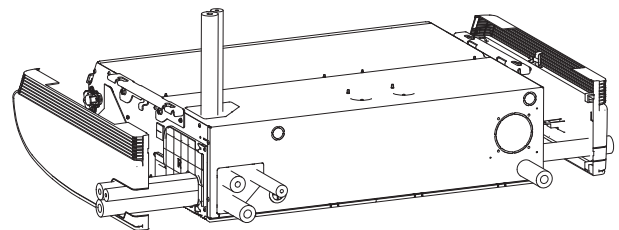
The ceiling surface is not always level. Confirm that the indoor unit is evenly suspended. For the installation to be correct, leave a clearance of about 10 mm between the ceiling panel and the ceiling surface and fill the gap with an appropriate insulation or filler material.

**Duct for Fresh Air (Field supply)**

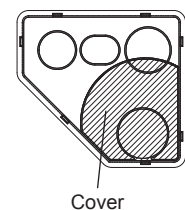
There is a outside air intake duct connection port (cut out hole) at the left-rear of the indoor unit for drawing in fresh air. If it is necessary to draw in fresh air, remove the cover by opening the hole and connecting the duct to the indoor unit through the connection port. See the figure under the section on page 1-11-3-2 (3).

**Shaping the Tubing**

- The positions of the refrigerant tubing connections are shown in the figure below. (The tubing can be routed in 3 directions.)
- \* When routing the tubing out through the top or right sides, cut out the cover of the top panel and cut notches in the side panel. See the figure under the section on page 1-11-3-2 (3).



If the tubing is to be routed together, use a box cutter or similar tool to cut out the part of the cover indicated by the marked area, to match the positions of the tubes. Then draw out the tubing.

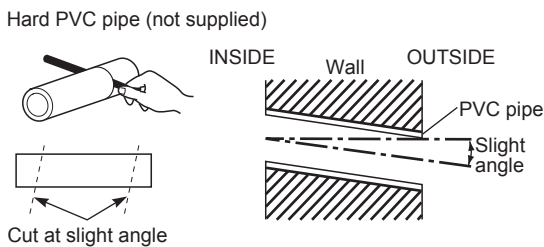
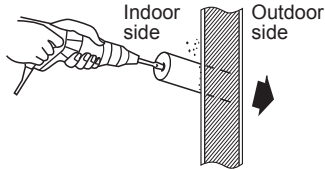


## Installing the Drain Pipe

- Prepare hard PVC pipe for the drain and connect it to the indoor unit drain pipe with the supplied hose band to prevent water leaks.
- Measure the thickness of the wall from the inside to the outside and cut PVC pipe at a slight angle to fit. Insert the PVC pipe in the wall.

### NOTE

The hole should be made at a slight downward slant to the outside.



### (1) Drain hose connection

- The drain hose is connected below the refrigerant tubing.

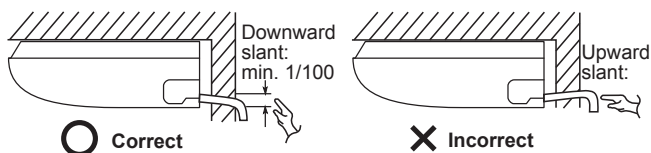
### (2) Installing the drain hose

- First insert the drain hose (supplied) to the hose band (supplied) and then install the drain hose to the unit drain port.
- Insert until the drain hose bumps to the end.
- Attach the hose band to make the fixed portion 45° upper gradient according to a vinyl tape (not supplied) of the drain hose (supplied).
- Hose band screw torque is 30 - 35 N · cm.
- Wind the vinyl tape not to blow up the hose band.
- Connect both the drain hose and PVC pipe (VP20 or similar material, not supplied). Insert until the PVC pipe bumps to the end and adhere with PVC adhesive.



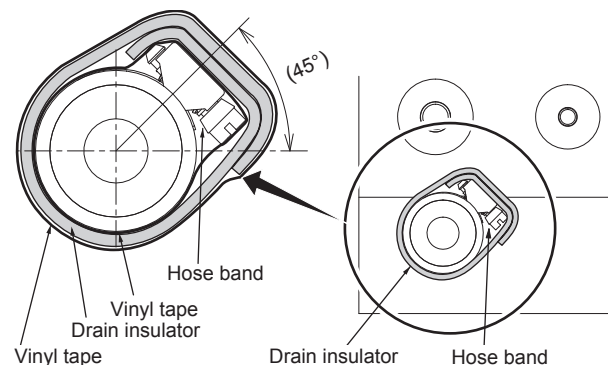
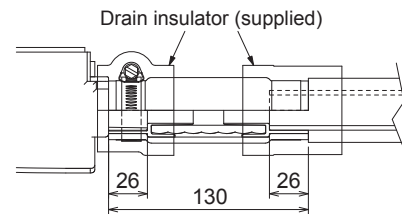
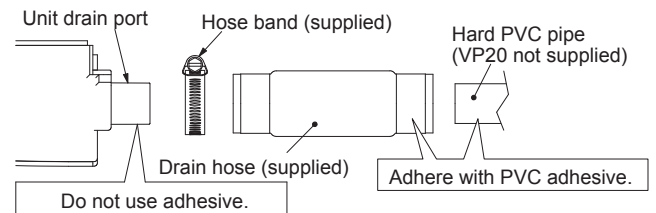
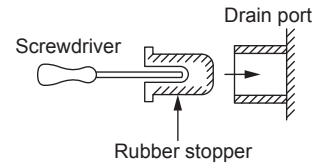
### CAUTION

- Wrap the drain insulator (supplied) between the connection of the drain hose and tubing not to expose the copper tubing. Also, wrap the hose band together. Wrap the hose band with the drain insulator, where the screw is located facing upward. Then, tighten the insulator with a vinyl tape not to cause the detachment. If the tubing parts remain exposed, condensation may occur.
- Be sure to use the supplied drain hose.
- If other commercially available hose bands are used, the drain hose may become pinched or wrinkled and there is danger of water leakage. Therefore be sure to use the supplied hose bands.
- Connect the drain pipe so that it slopes downward from the unit to the outside.



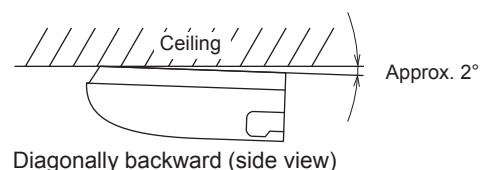
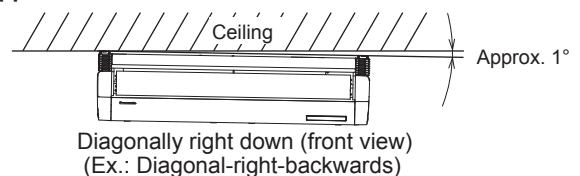
- Never allow water traps to occur in the course of the piping.
- Insulate any piping inside the room to prevent dripping.
- After the drain piping, pour an appropriate amount of water into the drain pan through the opening on the side of the air discharge port. Check the water draining smoothly.
- \* If the drain hose is routed through the left side, see the figure under the section "Shaping the Tubing" on page 1-11-3-4, and follow the procedure above to install the hose. Reattach the rubber stopper removed earlier onto the right side.

The rubber stopper can be inserted easily by using a screwdriver or similar tool to press the stopper into the drain port on the main unit. Press the stopper into the main unit drain port as far as it will go.



### CAUTION

The indoor unit should be slightly tilted downward toward the drain pipe connection side as shown in figure below so that the wastewater can flow smoothly without being trapped in the middle.



## ■ HOW TO PROCESS TUBING

Must ensure mechanical connections be accessible for maintenance purposes.

### Connecting the Refrigerant Tubing

#### NOTE

When connecting flare at indoor side, make sure that the flare connection is used only once. If torqued up and released, the flare must be remade. Once the flare connection was torqued up correctly and leak test was made, thoroughly clean and dry the surface to remove oil, dirt and grease by following instructions of silicone sealant. Apply neutral cure & ammonia-free silicone sealant that is non-corrosive to copper & brass to the external of the flared connection to prevent the ingress of moisture on both the gas & liquid sides. (Moisture may cause freezing and premature failure of the connection.)

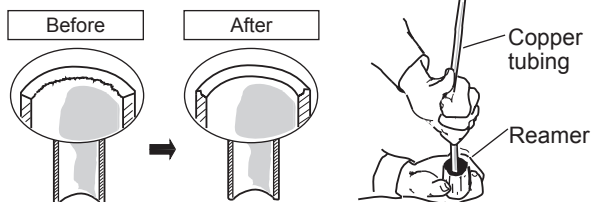
#### Use of the Flaring Method

Many of conventional split system air conditioners employ the flaring method to connect refrigerant tubes that run between indoor and outdoor units. In this method, the copper tubes are flared at each end and connected with flare nuts.

#### Flaring Procedure with a Flare Tool

- (1) Cut the copper tube to the required length with a tube cutter. It is recommended to cut approx. 30 – 50 cm longer than the tubing length you estimate.
- (2) Remove burrs at each end of the copper tubing with a tube reamer or a similar tool. This process is important and should be done carefully to make a good flare. Be sure to keep any contaminants (moisture, dirt, metal filings, etc.) from entering the tubing.

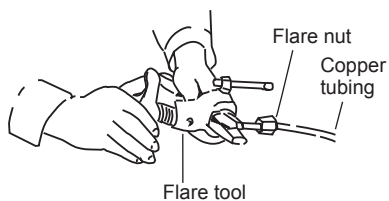
#### Deburring



#### NOTE

When reaming, hold the tube end downward and be sure that no copper scraps fall into the tube.

- (3) Remove the flare nut from the unit and be sure to mount it on the copper tube.
- (4) Make a flare at the end of the copper tube with a flare tool.



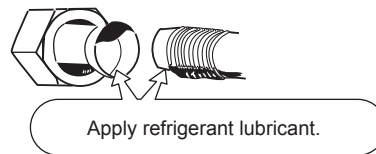
#### NOTE

When flared joints are reused, the flare part shall be re-fabricated. A good flare should have the following characteristics:

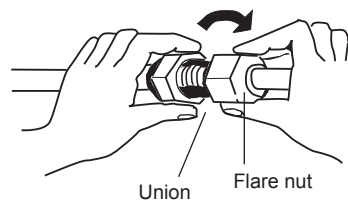
- inside surface is glossy and smooth
- edge is smooth
- tapered sides are of uniform length

### Caution Before Connecting Tubes Tightly

- (1) Apply a sealing cap or water-proof tape to prevent dust or water from entering the tubes before they are used.
- (2) Be sure to apply refrigerant lubricant (ether oil) to the inside of the flare nut before making piping connections. This is effective for reducing gas leaks.



- (3) For proper connection, align the union tube and flare tube straight with each other, then screw on the flare nut lightly at first to obtain a smooth match.



- Adjust the shape of the liquid tube using a tube bender at the installation site and connect it to the liquid tubing side valve using a flare.

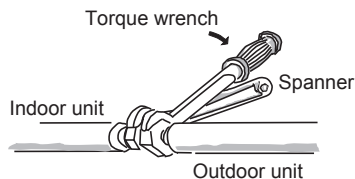
### Connecting Tubing Between Indoor and Outdoor Units

- (1) Tightly connect the indoor-side refrigerant tubing extended from the wall with the outdoor-side tubing.

#### Indoor Unit Tubing Connection

Indoor unit type	50	60	71	100	125	140
Gas tubing (mm)	ø12.7			ø15.88		
Liquid tubing (mm)	ø6.35			ø9.52		

- (2) To fasten the flare nuts, apply specified torque.
- When removing the flare nuts from the tubing connections, or when tightening them after connecting the tubing, be sure to use a torque wrench and a spanner. If the flare nuts are over-tightened, the flare may be damaged, which could result in refrigerant leakage and cause injury or asphyxiation to room occupants.



- For the flare nuts at tubing connections, be sure to use the flare nuts that were supplied with the unit, or else flare nuts for R410A, R32 (type 2). The refrigerant tubing that is used must be of the correct wall thickness as shown in the table below.

Tube diameter	Tightening torque (approximate)	Tube thickness
ø6.35 (1/4")	14 – 18 N · m {140 – 180 kgf · cm}	0.8 mm
ø9.52 (3/8")	34 – 42 N · m {340 – 420 kgf · cm}	0.8 mm
ø12.7 (1/2")	49 – 55 N · m {490 – 550 kgf · cm}	0.8 mm
ø15.88 (5/8")	68 – 82 N · m {680 – 820 kgf · cm}	1.0 mm

Because the pressure is approximately 1.6 times higher than conventional refrigerant R22 pressure, the use of ordinary flare nuts (type 1) or thin-walled tubes may result in tube rupture, injury, or asphyxiation caused by refrigerant leakage.

- In order to prevent damage to the flare caused by over-tightening of the flare nuts, use the table above as a guide when tightening.
- When tightening the flare nut on the liquid tube, use an adjustable wrench with a nominal handle length of 200 mm.

## Insulating the Refrigerant Tubing

### Tubing Insulation

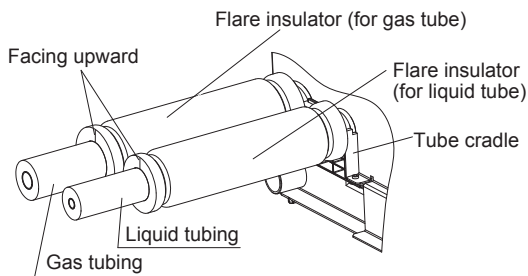
Must ensure that pipe-work shall be protected from physical damage.

- Thermal insulation must be applied to all units tubing, including distribution joint (field supply).
  - \* For gas tubing, the insulation material must be heat resistant to 120°C or above. For other tubing, it must be heat resistant to 80°C or above.

Insulation material thickness must be 10 mm or greater. If the conditions inside the ceiling exceed DB 30°C and RH 70%, increase the thickness of the gas tubing insulation material by 1 step.

### Insulation of the flare nuts

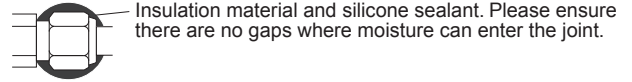
Attach the flare insulator (supplied) just like wrapping around the flare nut (supplied). Match the both slits of flare insulators for gas and liquid tubes facing upward. Tightly attach the end of the flare insulators to the tube cradle without any space. Then clamp the flare insulator with the clampers about 20 mm away from both ends.



! Ensure to do the re-flaring of pipes before connecting to units to avoid leaking.

To prevent the ingress of moisture into the joint which could have the potential to freeze and then cause leakage, the joint must be sealed with suitable silicone and insulation material.

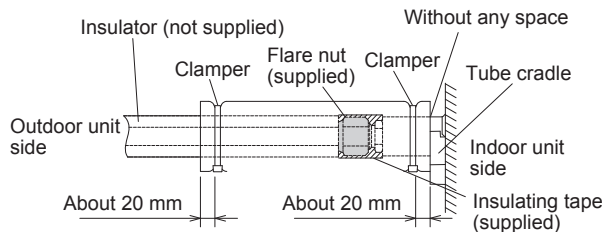
The joint should be sealed on both liquid and gas side.



Silicone Sealant must be neutral cure and ammonia free. Use of silicon containing ammonia can lead to stress corrosion on the joint and cause leakage.

### Taping the flare nuts

Wind the white insulating tape around the flare nuts at the gas tube connections. Then cover up the tubing connections with the flare insulator, and fill the gap at the union with the supplied black insulating tape. Finally, fasten the insulator at both ends with the supplied vinyl clamps.



### NOTE

Tighten the clampers to prevent any condensation that may occur as the copper tubing is exposed.

### Insulation material

The material used for insulation must have good insulation characteristics, be easy to use, be age resistant, and must not easily absorb moisture.



### CAUTION

**After a tube has been insulated, never try to bend it into a narrow curve because it can cause the tube to break or crack.**

**Never grasp the drain or refrigerant connecting outlets when moving the unit.**

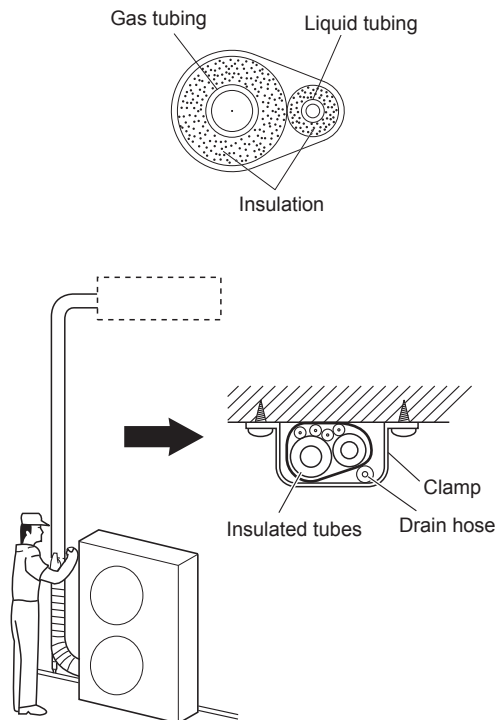
### Taping the Tubes

- (1) At this time, the refrigerant tubes (and electrical wiring if local codes permit) should be taped together with armoring tape in 1 bundle. To prevent condensation from overflowing the drain pan, keep the drain hose separate from the refrigerant tubing.
- (2) Wrap the armoring tape from the bottom of the outdoor unit to the top of the tubing where it enters the wall. As you wrap the tubing, overlap half of each previous tape turn.



- (3) Clamp the tubing bundle to the wall, using 1 clamp approx. each meter.

**Two tubes arranged together**

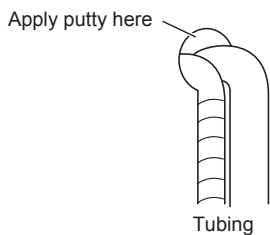


**NOTE**

Do not wind the armoring tape too tightly since this will decrease the heat insulation effect. Also ensure that the condensation drain hose splits away from the bundle and drips clear of the unit and the tubing.

**Finishing the Installation**

After finishing insulating and taping over the tubing, use sealing putty to seal off the hole in the wall to prevent rain and draft from entering.

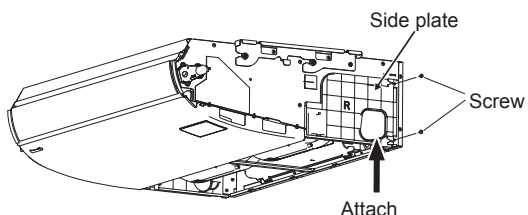


**FINAL PROCEDURE**

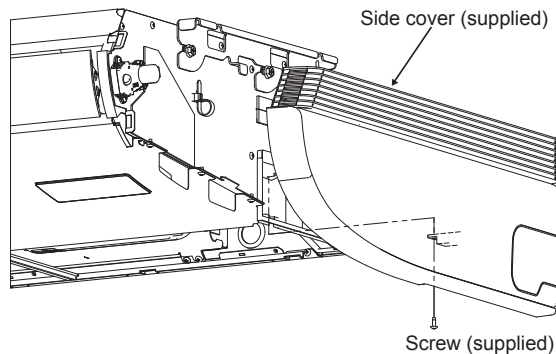
Reinstall the removed part to be placed in its original position. (See the section "Preparation Before Installation" on page 1-11-3-3.)

Then install the supplied side covers (L/R) on both sides of the indoor unit.

- Attach the supplied side plates. Insert the side plates in the direction of the arrow and fix them with 2 screws once you've removed.

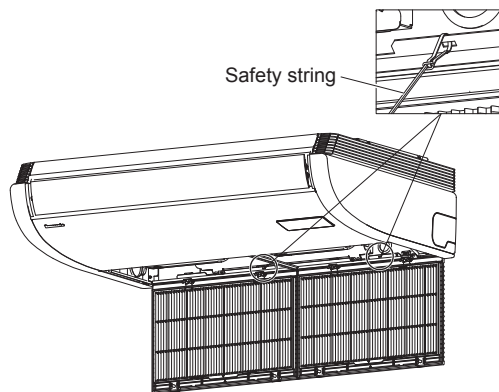


- Attach the supplied side covers. Slide the covers from the front side and attach to the claws of the latches. Tighten the screws (supplied).



- Attach the air-intake grille. When attaching the air-intake grille, perform the reverse procedure to removing the grille. Refer to the section "Preparation Before Installation" on page 1-11-3-3. Be sure to attach the safety string.

Close the air-intake grille and fix the claws of the latches with the screws.



**■ HOW TO INSTALL THE TIMER REMOTE CONTROLLER OR HIGH-SPEC WIRED REMOTE CONTROLLER (OPTIONAL PART)**

**NOTE**

See "Section 2. TEST RUN".

**■ HOW TO INSTALL WIRELESS REMOTE CONTROLLER**

**NOTE**







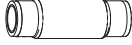


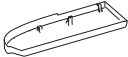




See "Section 8. HOW TO INSTALL THE WIRELESS REMOTE CONTROLLER RECEIVER".

## Accessories Supplied with Unit

The accessory parts are supplied inside the indoor unit. Open the air-intake grille of the indoor unit and take out a package of accessories.

See the section "Preparation Before Installation" on page 1-11-3-3.

**Table 1-11-4 (Ceiling)**

Part Name	Figure	Q'ty	Remarks
Special washer		4	For temporarily suspending indoor unit from ceiling
Drain insulator		2	For drain hose joint
Flare insulator		1	For gas tube joint
		1	For liquid tube joints
Clamper		6	For flare insulator and wiring
Full-scale installation diagram		1	For positioning installation
Drain hose		1	For main unit + PVC pipe joints
Insulating tape		2	For gas and liquid tubes flare nuts
Hose band		1	For drain hose connection
Side cover (R)		1	(Packed in carton box) For right side
Side cover (L)		1	(Packed in carton box) For left side
Screw		2	For side cover (L/R)
Operating Instructions		1	
Installation Instructions		1	

## Type of Copper Tube and Insulation Material

If you wish to purchase these materials separately from a local source, you will need:

1. Deoxidized annealed copper tube for refrigerant tubing.
2. Foamed polyethylene insulation for copper tubes as required to precise length of tubing. Wall thickness of the insulation should be not less than 8 mm.
3. Use insulated copper wire for field wiring. Wire size varies with the total length of wiring. See the section "1-10. Electrical Wiring" for details.



### CAUTION

**Check local electrical codes and regulations before obtaining wire. Also, check any specified instructions or limitations.**

## Additional Materials Required for Installation

1. Refrigeration (armored) tape
2. Insulated staples or clamps for connecting wire (See your local codes.)
3. Putty
4. Refrigeration tubing lubricant
5. Clamps or saddles to secure refrigerant tubing
6. Scale for weighing

## ■ CHECKLIST AFTER INSTALLATION WORK

Work List	No.	Content	Check <input checked="" type="checkbox"/>	Possibility of Failure & Checkpoint
Installation	1	Are the indoor units installed following the content of the section "■ SELECTING THE INSTALLATION SITE"?(on page 1-11-3-1)	<input type="checkbox"/>	There is a possibility of light injure or loss of property.
Tubing & Wiring	2	In the case of multiple installation: Is there a wrong tubing connection with another system?	<input type="checkbox"/>	The unit is inoperated or the refrigerant flows into the inoperative unit and the leakage is expected. Check if there is a wrong tubing or wiring connection with another system.
	3	In the case of multiple installation: Is there a wrong wiring connection with another system?	<input type="checkbox"/>	
	4	Is the earth leakage circuit breaker (all-pole switching function provided) installed?	<input type="checkbox"/>	
	5	Is there any wrong installation of optional parts or wrong wiring?	<input type="checkbox"/>	Power failure or short circuit may cause electric shock or fire. Check installation work and ground wire work.
	6	Was the ground wire work performed?	<input type="checkbox"/>	
	7	Are there any wrong power supply wiring, wrong connection wire, wrong signal wire or loose screw?	<input type="checkbox"/>	
	8	Is the thickness of wire in accordance with rule?	<input type="checkbox"/>	
	9	Is the power-supply voltage equal to the nameplate of the unit?	<input type="checkbox"/>	
	10	Was the check of the airtight test, flared tube fitting and gas leakage on the welded portion performed?	<input type="checkbox"/>	If the gas leakage occurs, the unit quality not only becomes inferior but affects environment. Repair it as quickly as possible.
	Drain Check	11	Has the adhesive been applied to the drain connecting portion (resin portion) of the indoor unit?	<input type="checkbox"/>
12		Is there water leakage?	<input type="checkbox"/>	Since there is a possibility of water drain, repair the drain pipe if the drain failure or water drain occurs.
13		Indoor unit drain pipe has a downward gradient (1/100 or more) by rule. Is the drain water flowing smoothly?	<input type="checkbox"/>	
Heat Insulation	14	Was the heat insulation work at a suitable location including the flared tube fitting (refrigerant tube & drain pipe) performed properly?	<input type="checkbox"/>	The quality of unit not only becomes inferior but there is a possibility of the water drain. So, perform the heat insulation work properly.
Test Run	15	Did the abnormal sound occur?	<input type="checkbox"/>	Check if there is a fan contact or distortion of the indoor unit.
	16	Did the cool and warm airflow discharge from the indoor unit?	<input type="checkbox"/>	Check if the unit does not operate or there is a wrong tubing or wiring connection with another system.

■ APPENDIX

Care and Cleaning



WARNING

- For safety, be sure to turn the air conditioner off and also to disconnect the power before cleaning.
- Do not pour water on the indoor unit to clean it. This will damage the internal components and cause an electric shock hazard.

Air intake and outlet side (Indoor unit)

Clean the air intake and outlet side of the indoor unit with a vacuum cleaner brush, or wipe them with a clean, soft cloth.


If these parts are stained, use a clean cloth moistened with water. When cleaning the air outlet side, be careful not to force the vanes out of place.




CAUTION

- Never use solvents or harsh chemicals when cleaning the indoor unit. Do not wipe plastic parts using very hot water.
- Some metal edges and the fins are sharp and may cause injury if handled improperly; be especially careful when you clean these parts.
- The internal coil and other components of outdoor unit must be cleaned regularly. Consult your dealer or service center.

Air filter

It is recommended that the air filter be cleaned when the  (Filter) appears on the display.

● After Cleaning

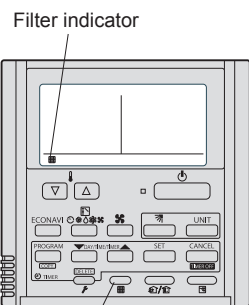
1. After the air filter is cleaned, reinstall it in its original position. Be sure to reinstall in reverse order.
2. [In the case of Timer Remote Controller] Press the Filter reset button. The  (Filter) indicator on the display goes out.

[In the case of High-spec Wired Remote Controller]

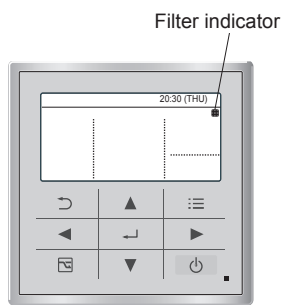
Refer to the Operating Instructions attached to the optional High-spec Wired Remote Controller.

Timer Remote Controller

High-spec Wired Remote Controller



Filter reset button



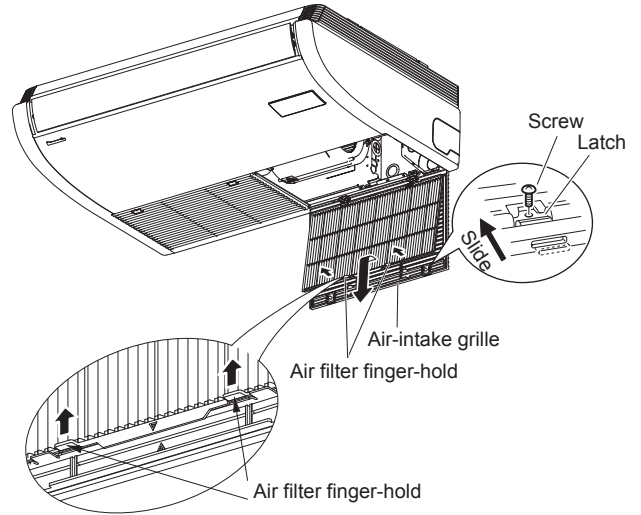
<How to clean the filter>

1. Remove the air filter from the air-intake grille.
2. Use a vacuum cleaner to remove light dust. If there is sticky dust on the filter, wash the filter in lukewarm, soapy water, rinse it in clean water, and dry it.

<How to remove the filter>

Ceiling Type (T2)

1. Remove 2 attachment screws fixed with the latches. Take hold of the finger-hold on the air-intake grille and press it to the rear, and the grille will open downward.
2. Take hold of the finger-hold on the air filter, pull it toward you.



\* Take hold of the finger-hold on the air filter, pull it toward you.



CAUTION

- Certain metal edges and the condenser fins are sharp and may cause injury if handled improperly; special care should be taken when you clean these parts.
- Periodically check the outdoor unit to see if the air outlet or air intake is clogged with dirt or soot.
- The internal coil and other components must also be cleaned periodically. Consult your dealer or service center.

Care: After a prolonged idle period

Check the indoor and outdoor unit air intakes and outlets for blockage; if there is a blockage, remove it.

Care: Before a prolonged idle period

- Operate the fan for half a day to dry out the inside.
- Disconnect the power supply and also turn off the circuit breaker.
- Clean the air filter and replace it in its original position.
- Outdoor unit internal components must be checked and cleaned periodically. Contact your local dealer for this service.

NOTE

The frequency with which the filter should be cleaned depends on the environment in which the unit is used. Clean the filter frequently for best performance in the area of dusty or oil spots regardless of filter status.

## Troubleshooting

If your air conditioner does not work properly, first check the following points before requesting service.

If it still does not work properly, contact your dealer or a service center.

### ● Indoor unit

Symptom		Cause
Noise	Sound like streaming water during operation or after operation	<ul style="list-style-type: none"> <li>● Sound of refrigerant liquid flowing inside unit</li> <li>● Sound of drainage water through drain pipe</li> </ul>
	Cracking noise during operation or when operation stops.	Cracking sound due to temperature changes of parts
Odor	Discharged air is smelled during operation.	Indoor odor components, cigarette odor and cosmetic odor accumulated in the air conditioner and its air is discharged. Unit inside is dusty. Consult your dealer.
Dewdrop	Dewdrop gets accumulated near air discharge during operation	Indoor moisture is cooled by cool wind and accumulated by dewdrop.
Fog	Fog occurs during operation in cooling mode. (Places where large amounts of oil mist exist at restaurants.)	<ul style="list-style-type: none"> <li>● Cleaning is necessary because unit inside (heat exchanger) is dirty. Consult your dealer as technical engineering is required.</li> <li>● During defrost operation</li> </ul>
Fan is rotating for a while even though operation stops.		<ul style="list-style-type: none"> <li>● Fan rotating makes operation smoothly.</li> <li>● Fan may sometimes rotate because of drying heat exchanger due to settings.</li> </ul>
Wind-direction changes while operating. Wind-direction setting cannot be made. Wind-direction cannot be changed.		<ul style="list-style-type: none"> <li>● When air discharge temperature is low or during defrost operation, horizontal wind flow is made automatically.</li> <li>● Flap position is occasionally set up individually.</li> </ul>
When wind-direction is changed, flap operates several times and stops at designated position.		When wind-direction is changed, flap operates after searching for standard position.
Dust		Dust accumulation inside indoor unit is discharged.
Poor cooling or heating performance		<p>The indoor unit is initially designed to control the indoor temperature detected by the built-in room sensor inside the indoor unit.</p> <p>Due to indoor unit installation position, however, the built-in sensor may occasionally sense temperature improperly; for example, temperature difference between the ceiling and floor, lighting apparatus, electric fan, windows or waist-high partition walls, etc.</p> <p>In this case, the unit does not operate properly at the desired temperature.</p> <p>You may change the use of the temperature sensor inside the indoor unit to that of the remote controller.</p> <p>Then the desired room temperature can be controlled properly.</p> <p>For details, consult your dealer.</p>

● **Check Before Requiring Services**

Symptom	Cause	Remedy
Air conditioner does not run at all although power is turned on.	Power failure or after power failure	Press ON/OFF operation button on remote controller again.
	Operation button is turned off.	<ul style="list-style-type: none"> <li>● Switch on power if breaker is turned off.</li> <li>● If breaker has been tripped, consult your dealer without turning it on.</li> </ul>
	Fuse blow out.	If blown out, consult your dealer.
Poor cooling or heating performance	Air intake or air discharge port of indoor and outdoor units is clogged with dust or obstacles.	Remove dust or obstruction.
	Fan speed switch is set to "Low".	Change to "Medium" or "High".
	Improper temperature settings	Refer to "Tips for Energy Saving" on this page.
	Room is exposed to direct sunlight in cooling mode.	
	Doors and /or windows are open.	
	Air filter is clogged.	Refer to "Care and Cleaning" on page 1-11-3-11.
	Too much heat sources in room in cooling mode.	Use minimum heat sources and in a short time.
	Too many people in room in cooling mode.	Reduce temperature settings or change to "Medium" or "High".

If your air conditioner still does not work properly although you checked the points as described above, first stop the operation and turn off the power switch.

Then contact your dealer and report the serial number and symptom.

Never repair your air conditioner by yourself since it is very dangerous for you to do so.

**Tips for Energy Saving**

**Avoid**

- **Do not block the air intake and outlet of the unit. If either is obstructed, the unit will not work well, and may be damaged.**
- Do not let direct sunlight into the room. Use sunshades, blinds or curtains. If the walls and ceiling of the room are warmed by the sun, it will take longer to cool the room.

**Do**

- Always try to keep the air filter clean. (Refer to "Care and Cleaning" on page 1-11-3-11.) A clogged filter will impair the performance of the unit.
- To prevent conditioned air from escaping, keep windows, doors and any other openings closed.

**NOTE**

**Should the power fail while the unit is running**

If the power supply for this unit is temporarily cut off, the unit will automatically resume operation once power is restored using the same settings before the power was interrupted.

## IMPORTANT INFORMATION REGARDING THE REFRIGERANT USED

### NOTE

See "■ Outdoor Unit" under the Section 1-11. Installation Instructions.

### ■ SERVICING



#### CAUTION

- Any qualified person who is involved with working on or breaking into a refrigerant circuit should hold a current valid certificate from an industry-accredited assessment authority, which authorizes their competence to handle refrigerants safely in accordance with an industry recognised assessment specification.
  - Servicing shall only be performed as recommended by the equipment manufacturer. Maintenance and repair requiring the assistance of other skilled personnel shall be carried out under the supervision of the person competent in the use of flammable refrigerants.
  - Servicing shall be performed only as recommended by the manufacturer.
  - Prior to beginning work on systems containing flammable refrigerants, safety checks are necessary to ensure that the risk of ignition is minimised. For repair to the refrigerating system, (2) to (6) shall be completed prior to conducting work on the system.
- (1) Work shall be undertaken under a controlled procedure so as to minimise the risk of a flammable gas or vapour being present while the work is being performed.
  - (2) All maintenance staff and others working in the local area shall be instructed on the nature of work being carried out. Work in confined spaces shall be avoided. The area around the workspace shall be sectioned off. Ensure that the conditions within the area have been made safe by control of flammable material.
  - (3) The area shall be checked with an appropriate refrigerant detector prior to and during work, to ensure the technician is aware of potentially toxic or flammable atmospheres. Ensure that the leak detection equipment being used is suitable for use with all applicable refrigerants, i.e. non-sparking, adequately sealed or intrinsically safe.
  - (4) If any hot work is to be conducted on the refrigeration equipment or any associated parts, appropriate fire extinguishing equipment shall be available to hand. Have a dry powder or CO<sub>2</sub> fire extinguisher adjacent to the charging area.
  - (5) No person carrying out work in relation to a refrigeration system which involves exposing any pipe work shall use any sources of ignition in such a manner that it may lead to the risk of fire or explosion. All possible ignition sources, including cigarette smoking, should be kept sufficiently far away from the site of installation, repairing, removing and disposal, during which refrigerant can possibly be released to the surrounding space. Prior to work taking place, the area around the equipment is to be surveyed to make sure that there are no flammable hazards or ignition risks. "No Smoking" signs shall be displayed.
  - (6) Ensure that the area is in the open or that it is adequately ventilated before breaking into the system or conducting any hot work. A degree of ventilation shall continue during the period that the work is carried out. The ventilation should safely disperse any released refrigerant and preferably expel it externally into the atmosphere.
  - (7) Where electrical components are being changed, they shall be fit for the purpose and to the correct specification. At all times the manufacturer's maintenance and service guidelines shall be followed. If in doubt, consult the manufacturer's technical department for assistance.
    - The charge size is in accordance with the room size within which the refrigerant containing parts are installed.
    - The ventilation machinery and outlets are operating adequately and are not obstructed.
    - Marking to the equipment continues to be visible and legible. Markings and signs that are illegible shall be corrected.
    - Refrigeration pipe or components are installed in a position where they are unlikely to be exposed to any substance which may corrode refrigerant containing components, unless the components are constructed of materials which are inherently resistant to being corroded or are suitably protected against being so corroded.
  - (8) Repair and maintenance to electrical components shall include initial safety checks and component inspection procedures. If a fault exists that could compromise safety, then no electrical supply shall be connected to the circuit until it is satisfactorily dealt with. If the fault cannot be corrected immediately but it is necessary to continue operation, an adequate temporary solution shall be used. This shall be reported to the owner of the equipment so all parties are advised.
 

Initial safety checks shall include:

    - That no live electrical components and wiring are exposed while charging, recovering or purging the system.
    - That there is continuity of earth bonding.
- During repairs to sealed components, all electrical supplies shall be disconnected from the equipment being worked upon prior to any removal of sealed covers, etc.
  - Particular attention shall be paid to the following to ensure that by working on electrical components, the casing is not altered in such a way that the level of protection is affected. This shall include damage to cables, excessive number of connections, terminals not made to original specification, damage to seals, incorrect fitting of glands, etc.
  - Ensure that apparatus is mounted securely.
  - Ensure that seals or sealing materials have not degraded such that they no longer serve the purpose of preventing the ingress of flammable atmospheres.
  - Replacement parts shall be in accordance with the manufacturer's specifications.

#### NOTE:

The use of silicon sealant may inhibit the effectiveness of some types of leak detection equipment. Intrinsically safe components do not have to be isolated prior to working on them.

- Do not apply any permanent inductive or capacitance loads to the circuit without ensuring that this will not exceed the permissible voltage and current permitted for the equipment in use.
- Intrinsically safe components are the only types that can be worked on while live in the presence of a flammable atmosphere.
- The test apparatus shall be at the correct rating.
- Replace components only with parts specified by the manufacturer. Unspecified parts by manufacturer may result ignition of refrigerant in the atmosphere from a leak.

## ■ REMOVAL AND EVACUATION



### CAUTION

- When breaking into the refrigerant circuit to make repairs – or for any other purpose – conventional procedures shall be used. However, it is important that best practice is followed since flammability is a consideration. The following procedure shall be adhered to:
  - Remove refrigerant.
  - Purge the circuit with inert gas.
  - Evacuate.
  - Purge again with inert gas.
  - Open the circuit by cutting or brazing.
- The refrigerant charge shall be recovered into the correct recovery cylinders.
- The system shall be “flushed” with Oxygen free nitrogen (OFN) to render the unit safe.
- This process may need to be repeated several times.
- Compressed air or oxygen shall not be used for this task.
- Flushing shall be achieved by breaking the vacuum in the system with Oxygen free nitrogen (OFN) and continuing to fill until the working pressure is achieved, then venting to atmosphere, and finally pulling down to a vacuum.
- This process shall be repeated until no refrigerant is within the system.
- When the final Oxygen free nitrogen (OFN) charge is used, the system shall be vented down to atmospheric pressure to enable work to take place.
- This operation is absolutely vital if brazing operations on the pipe work are to take place.
- Ensure that the outlet for the vacuum pump is not close to any ignition sources and there is ventilation available.

## ■ CHARGING PROCEDURES

### NOTE

See “■ Outdoor Unit” under the Section 1-11. Installation Instructions.

## ■ DECOMMISSIONING



### CAUTION

- Before carrying out this procedure, it is essential that the technician is completely familiar with the equipment and all its details.
- It is recommended good practice that all refrigerants are recovered safely.
- Prior to the task being carried out, an oil and refrigerant sample shall be taken in case analysis is required prior to re-use of reclaimed refrigerant.
- It is essential that electrical power is available before the task is commenced.
  - a) Become familiar with the equipment and its operation.
  - b) Isolate system electrically.
  - c) Before attempting the procedure ensure that:
    - Mechanical handling equipment is available, if required, for handling refrigerant cylinders.
    - All personal protective equipment is available and being used correctly.
    - The recovery process is supervised at all times by a competent person.
    - Recovery equipment and cylinders conform to the appropriate standards.
  - d) Pump down refrigerant system, if possible.
  - e) If a vacuum is not possible, make a manifold so that refrigerant can be removed from various parts of the system.
  - f) Make sure that cylinder is situated on the scales before recovery takes place.
  - g) Start the recovery machine and operate in accordance with manufacturer’s instructions.
  - h) Do not overfill cylinders. (No more than 80 % volume liquid charge).
  - i) Do not exceed the maximum working pressure of the cylinder, even temporarily.
  - j) When the cylinders have been filled correctly and the process completed, make sure that the cylinders and the equipment are removed from site promptly and all isolation valves on the equipment are closed off.
  - k) Recovered refrigerant shall not be charged into another refrigeration system unless it has been cleaned and checked.
- Electrostatic charge may accumulate and create a hazardous condition when charging or discharging the refrigerant. To avoid fire or explosion, dissipate static electricity during transfer by grounding and bonding containers and equipment before charging / discharging.

## ■ RECOVERY

### NOTE

See “12. Recovery” on page 1-11-1-6.



## ■ SELECTING THE INSTALLATION SITE

### 4. Wall Mounted Type (K2)

#### Indoor Unit

#### AVOID:

- areas where leakage of gas may be expected.
- locations where sulfurous acid gas or corrosive gas occurs.
- places where large amounts of oil mist exist such a kitchen of a Chinese restaurant or near a machinery equipment of the factory. The oil can be adhered to the surface of the heat exchanger or resin parts and this will cause a decrease in performance, spray or drip water and deformation or damages.
- direct sunlight.
- locations near heat sources which may affect the performance of the unit.
- locations where external air may enter the room directly. This may cause "condensation" on the air discharge ports, causing them to spray or drip water.
- locations where the remote controller will be splashed with water or affected by dampness or humidity.
- installing the remote controller behind curtains or furniture.
- locations where high-frequency emissions are generated.
- turning ON the power or operate the unit until work of refrigerant tubing and electrical wiring have been completed. Highly dangerous electrical voltages are used in this system.

#### DO:

- Install the unit to allow cool air (and warm air) to flow smoothly. Never place objects near the air inlet or the air outlet of the unit. This will reduce the efficiency of the unit.
- select an installation location which is rigid and strong enough to support or hold the unit.
- select a location which can support a load that is four times the indoor unit weight.
- select a location for drainage work properly. If it is improperly, this will cause damage to property.
  - Select a location where tubing and drain pipe have the shortest run to the outdoor unit.
  - Insulate the drain pipe running inside the building.
  - Pay attention to the drainage planning not to cause neighbors trouble.
- allow room for operation and maintenance as well as unrestricted air flow around the unit.
- keep the fire alarm and the air outlet at least 1.5 m away from the unit.
- the height of the installed location shall be at least 1.8 m above the floor.
- when installing the unit in the hotel rooms or executive offices with a low-level noise, it is recommended that the external electronic expansion valve kit (optional) be installed.
- the limitation of the tubing length between the indoor and the outdoor units should be referred to the Installation Instructions of the outdoor unit.
- allow room for mounting the remote controller about 1 m off the floor, in an area that is not in direct sunlight or in the flow of cool air from the indoor unit.

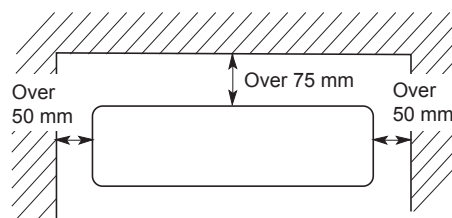
#### NOTE

Air delivery will be degraded if the distance from the floor to the ceiling is greater than 3 m.

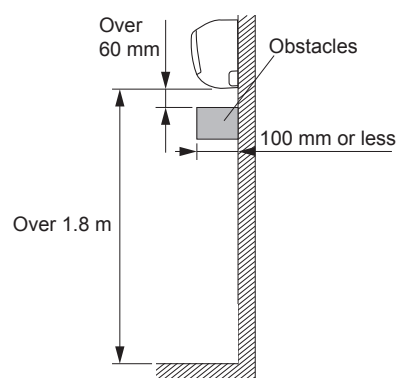
#### Wall Mounted

The air inlet and outlet of the indoor unit must be free of any obstructions to allow air to spread throughout the room.

1. The indoor unit must be within a maintenance space.



Front View



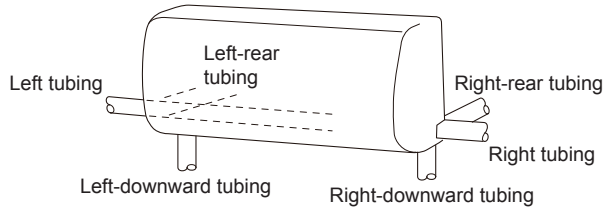
Side View

## ■ HOW TO INSTALL THE INDOOR UNIT

### Remove the Rear Panel from the Unit

#### NOTE

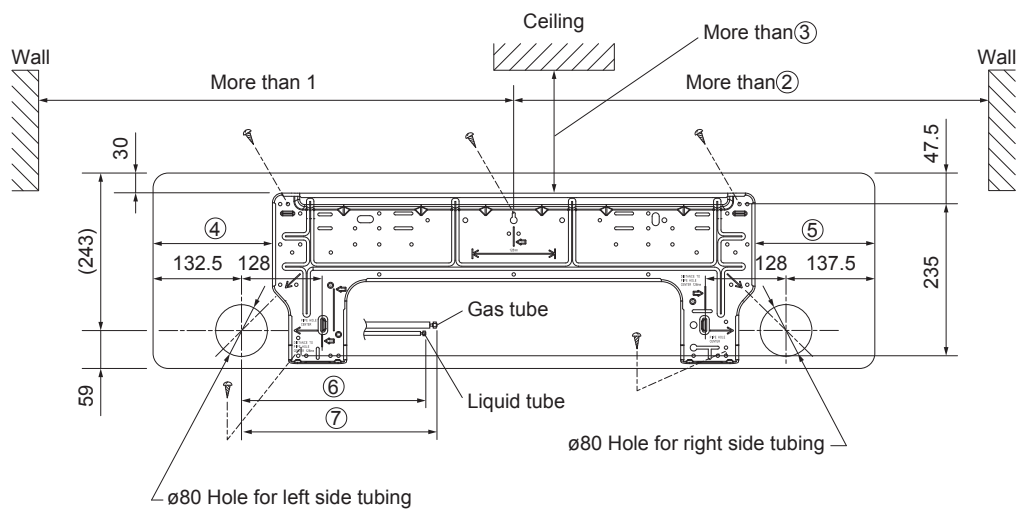
Tubing can be extended in 6 directions as shown below.  
Select the direction you need providing the shortest run to the outside unit.  
Tubing direction



### How to Make a Hole

The mounting wall should be strong and solid enough to withstand the unit's vibration.

(1) Place the installation plate from the indoor unit on the wall at the location selected.



\* Mount the installation plate with 5 screws completely.

unit: mm

Dimension						
①	②	③	④	⑤	⑥	⑦
607.5	612	105	183.5	188.5	400	450

Make sure the installation plate is horizontal, using a carpenter's level or tape measure to measure down from the ceiling. Wait until after cutting the hole before attaching the installation plate to the wall.

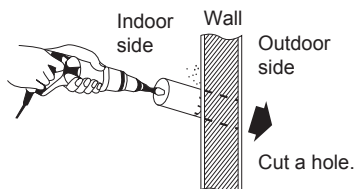
- \* The center of installation plate should be at more than ① at right of the wall.
- \* The center of installation plate should be at more than ② at left of the wall.
- \* The distance from installation plate edge to ceiling should be more than ③.
- \* From installation plate left side to unit's left side is ④.
- \* From installation plate right side to unit's right side is ⑤.
- \* For left side tubing, tubing connection for liquid should be about ⑥ from this line.
- \* For left side tubing, tubing connection for gas should be about ⑦ from this line.

- (2) Before making the hole, check carefully that no studs or pipes are directly run behind the spot to be cut.

**CAUTION** Avoid areas where electrical wiring is located.

The above precautions are also applicable if tubing goes through the wall in any other location.

- (3) Using a sabre saw, keyhole saw or hole-cutting drill attachment, cut a hole of  $\varnothing 80$  mm in the wall. Hole should be made at a slight downward slant to the outdoor side.

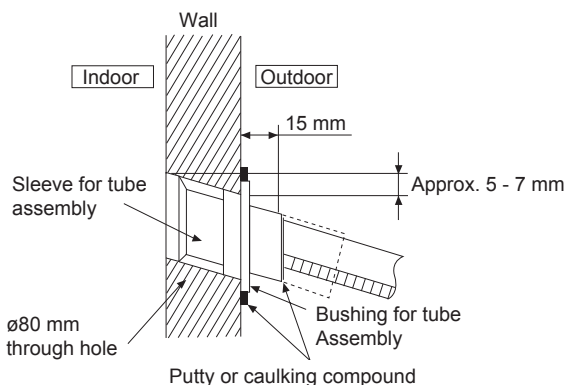


Hole Dia. (mm)
80

- (4) Place a plastic cover over the end of the pipe (for indoor side only) and insert the pipe in the wall. This will protect the tube from contacting the metal lath or wire lath, leakage due to condensation or entering small animals through the hole.

**CAUTION**

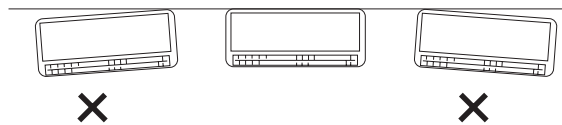
When the wall is hollow, please be sure to use the Piping sleeve assembly to prevent dangers caused by mice biting the connection cable.



### Install the Installation Plate on the Wall

#### If Wooden Wall

- (1) Attach the installation plate to the wall with the 5 screws (4 x 20) provided.
- (2) Double check with a carpenter's level or tape measure that the panel is level. This is important to install the unit properly.



- (3) Make sure the panel is flush against the wall. Any space between the wall and unit will cause noise and vibration.

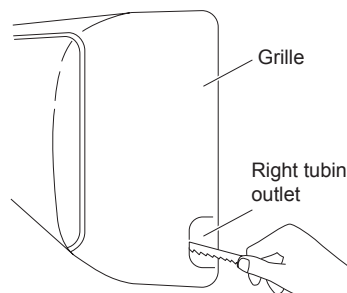
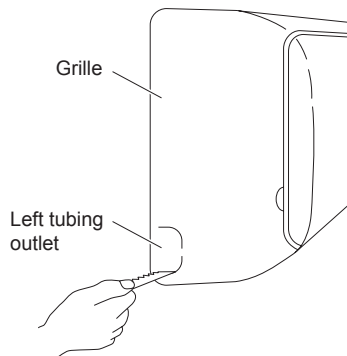
#### If Concrete Wall

- (1) When attaching the installation plate to the concrete wall, use the screws (field supply) for concrete or an optional anchor plug and fix to the hole of  $\varnothing 5$  mm of the installation plate as shown in the figure under the section "How to Make a Hole" on page 1-11-4-2. When fixing with bolt, attach to the hole of  $\varnothing 8$  mm.
- (2) Double check with a carpenter's level or tape measure that the plate is level. This is important to install the unit properly.
- (3) Make sure the installation plate is flush against the wall. Any space between the wall and unit will cause noise and vibration.

#### Indoor Side Tubing

Arrangement of tubing by direction

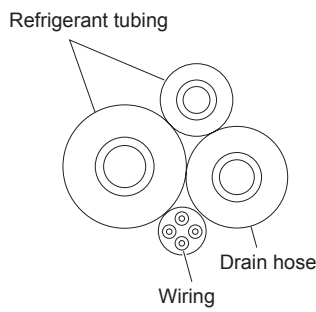
- 1) Left side, left bottom or right side, right bottom tubing  
Cut out the corner of the right/left frame with a hacksaw or the like.



- 2) Right-rear or left-rear tubing  
In this case, the corner of the frame need not be cut.

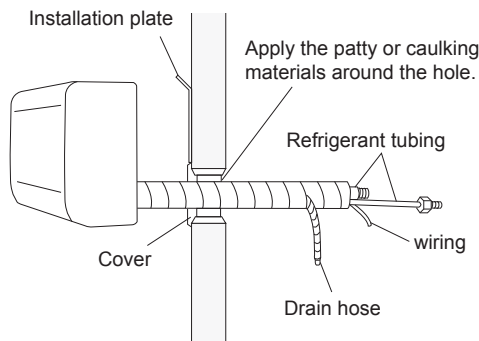
## Right-rear side, right side, right-bottom side tubing

Be sure to insulate the drain hose and refrigerant tubing to run through the rooms.

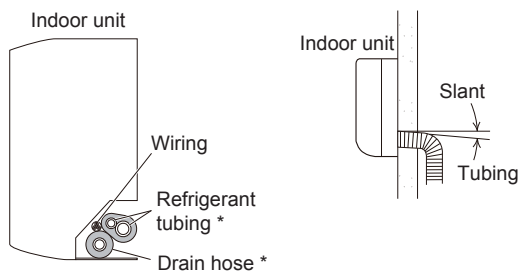


### Mounting the indoor unit

- 1) Assemble the refrigerant tubing, drain hose and wiring together with the armoring tape. Do not wind the tape forcibly more than necessary. The drain hose should be positioned below the tubing not to apply too much tension. (Cross-section view)
- 2) Push the wiring, refrigerant tubing and drain hose through the hole in the wall. Mount the indoor unit to be seated so it is caught on the tabs of the installation plate.



### Cross-section view



\* Drain hose should be positioned below the refrigerant tubing.

## Left-rear side, left side, left-bottom side tubing

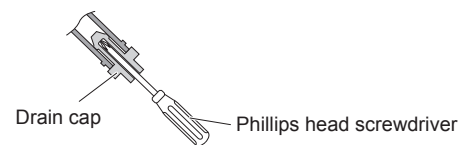
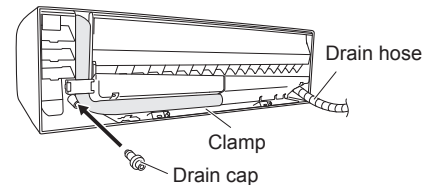
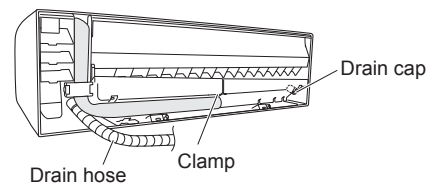
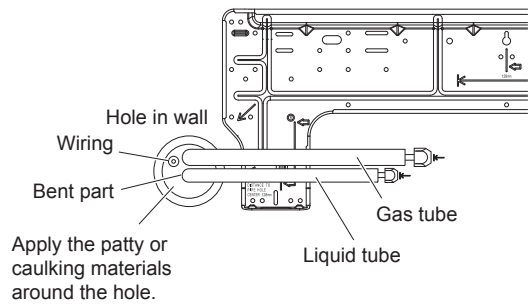
### (1) Pulling tubes into indoors

Adjust the tubing length so as to be placed at the same position of the liquid tube and gas tube.

### (2) Switching drain hose and drain cap

- Switch the drain hose and drain cap. When removing the drain cap, pinch it with the pliers and pull out the drain cap. When inserting the drain cap, use a Phillips head screwdriver to push the drain cap in firmly.

- Pull out the drain hose to remove it. When attaching it, slide the drain hose fully onto the drain pan outlet. (It will be easy to slide when water is added.) After attaching the drain hose, check that it is attached securely.

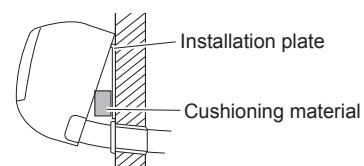


### (3) Mounting the indoor unit

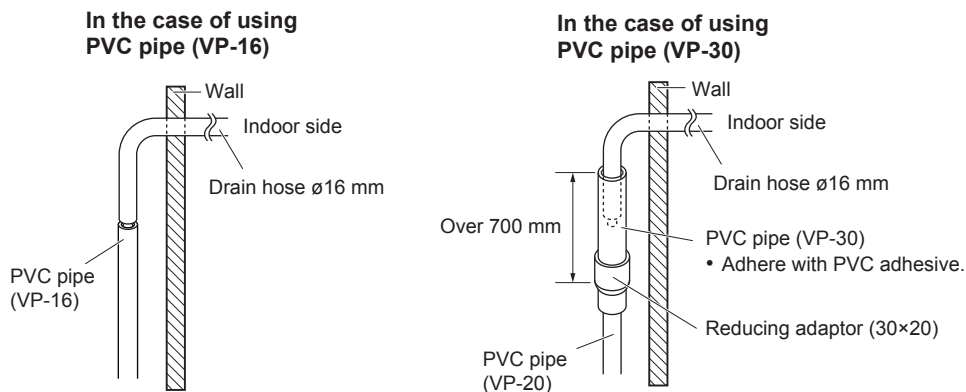
- 1) Mount the indoor unit onto the tabs on the upper part of the installation plate.
- 2) Connect the refrigerant tubing, drain hose and wires led inside from outdoors. (When leading an optional drain hose into the room for expansion, the drain hose inside the room should be insulated. In the case of the right-rear side, right side or right-bottom side tubing, see the section "Right-rear side, right side, right-bottom side tubing" on This page.)
- 3) After completing a leak test, bundle the tubing and wiring together with the armoring tape. Do not wind the tape forcibly more than necessary. Store the tubing and wiring inside the tubing storage area at the back of the indoor unit. Be sure the drain hose is placed underneath the tubing.

## Left-rear side, left side, left-bottom side tubing

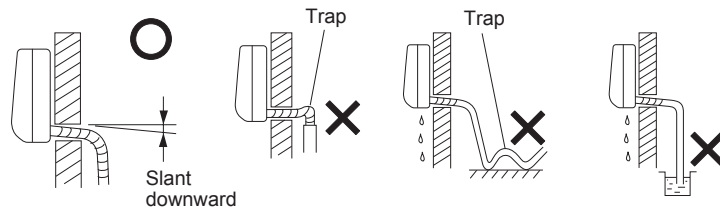
Piping can easily be made by lifting the indoor unit with a cushioning material between the indoor unit and the wall.



- (4) Connect the drain hose.
- Do not enforce the base of the drain hose when making a connection.
- Insert securely the drain hose into the PVC pipe.
  - When installing the drain hose extension, connect with an optional drain hose. After connection, bundle with armoring tape.
  - Make sure not to make the drain hose trapped. Insulate the connected part of the drain hose with the tubing insulation and check whether or not the water drains.



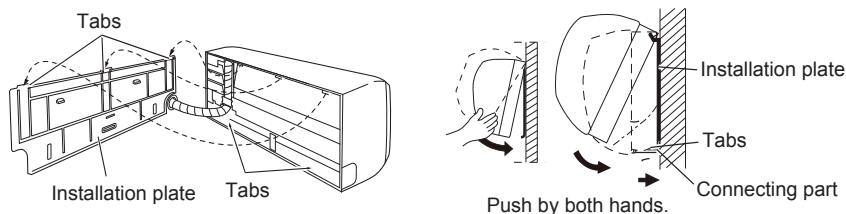
- (5) When there is a long horizontal drain hose runs with very little slope to the run, water is likely to remain inside the hose. Slant the drain hose downward slightly to the outdoors and insulate it with the insulation.
- Slant downward not to remain water inside the drain hose.
  - Make sure tubing does not become trapped.
  - Do not let the tip of the drain hose dip into the drain water.
  - Do not leave the drain hose in the sewerage. This will cause the heat exchanger erosion damage caused by the corrosive gas such as hydrogen sulfide occurred inside the sewerage and lead to a gas leak.



**To mount and unmount indoor unit**

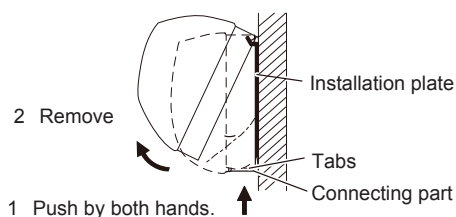
How to mount indoor unit

1. To install the indoor unit, mount the indoor unit onto the tabs on the upper part of the installation plate.
2. Hold down the air discharge outlet and press the lower part of the indoor unit until it clicks to securely fasten to the 2 tabs on the lower part of the installation plate.
3. Close the front panel and ensure that the panel is perfectly stable.



How to unmount indoor unit

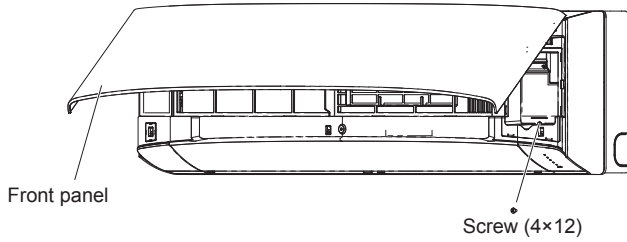
Press the 2 **PUSH** marks on the lower part of the indoor unit and unlatch the tabs. Then lift the indoor unit and unmount.



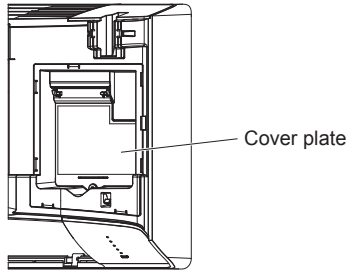
## Wiring Instructions

### <Power supply, Inter-unit control wiring, Remote control wiring>

(1) Open the front panel and remove the screw (×1).

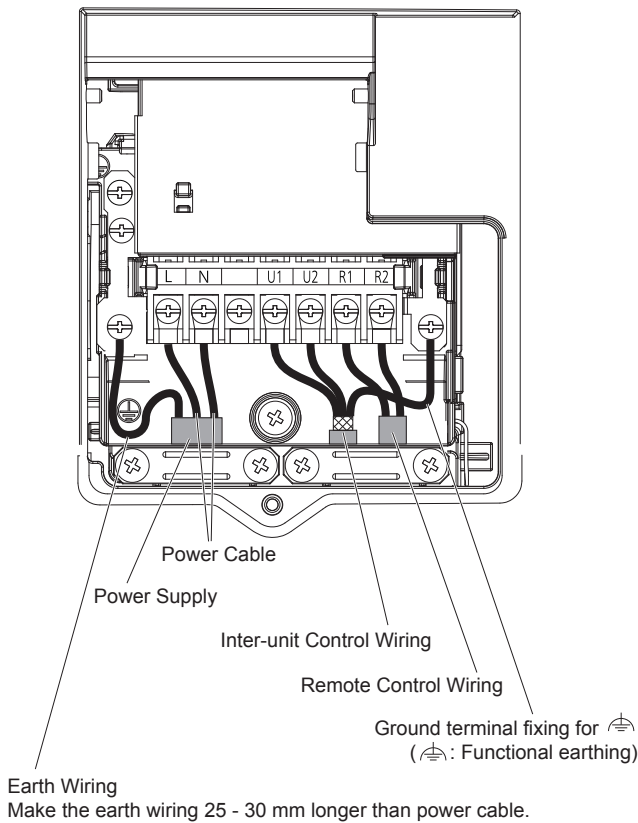


(2) Open the cover plate until it is in locked position.



(3) Make wiring.

### Wiring sample

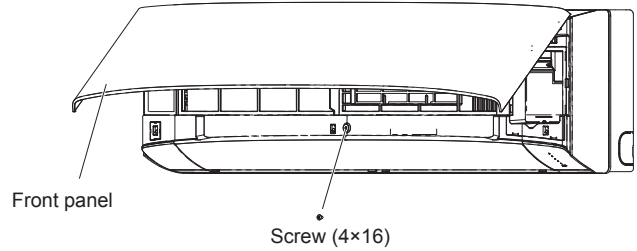


If the terminal screws on the terminal board are tightened too hard, the screws might be damaged. See the tightening torque values as shown below.

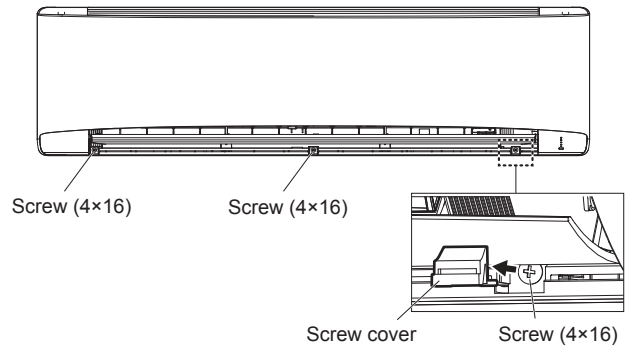
<b>Tightening torques for terminal screws</b>	1.0 – 1.4 N · m {10 – 14 kgf · cm}
---	---------------------------------------

### <Optional parts setting and wiring>

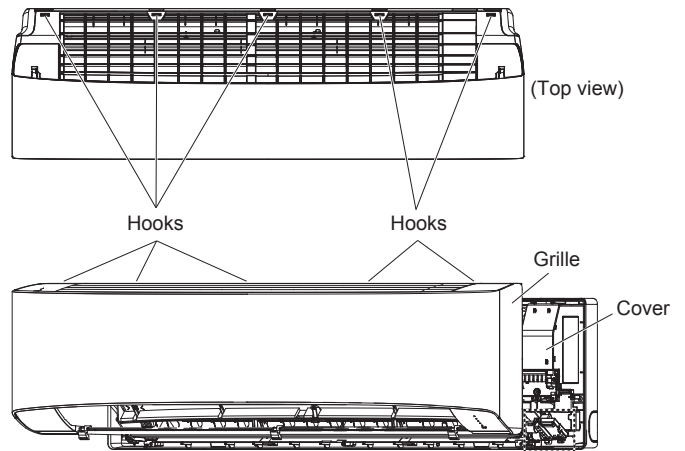
(1) Open the front panel and remove the screw (×1).  
Then close the panel.



(2) Open the flap and disengage the screw covers (×3).  
Then remove the screws (×3).



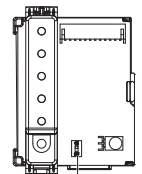
(3) Disengage the hooks holding and lifting both ends of the grille.  
Remove the cover of electrical component box.



### <When Using Wireless Remote Controller Instead of Wired Remote Controller>

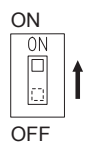
When the wireless remote controller is to be used, slide the switch (SW502) to the ON position.

- If this setting is not made, an alarm will occur. (The operation lamp on the display blinks.)



SW502

<b>Setting status</b>
<b>ON:</b> Wireless: main, Wired: sub
<b>OFF:</b> Wired: main, Wireless: sub (at shipment)



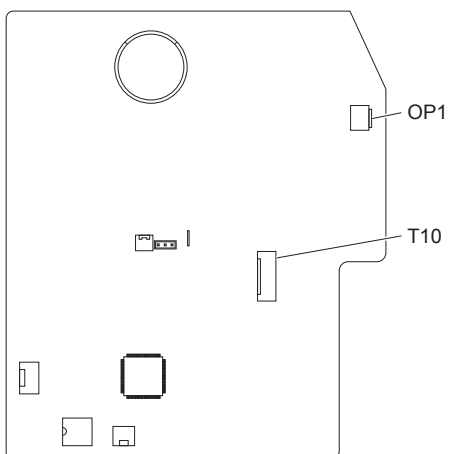
(4) Make wiring.

Refer to the instructions manual of optional parts as well.

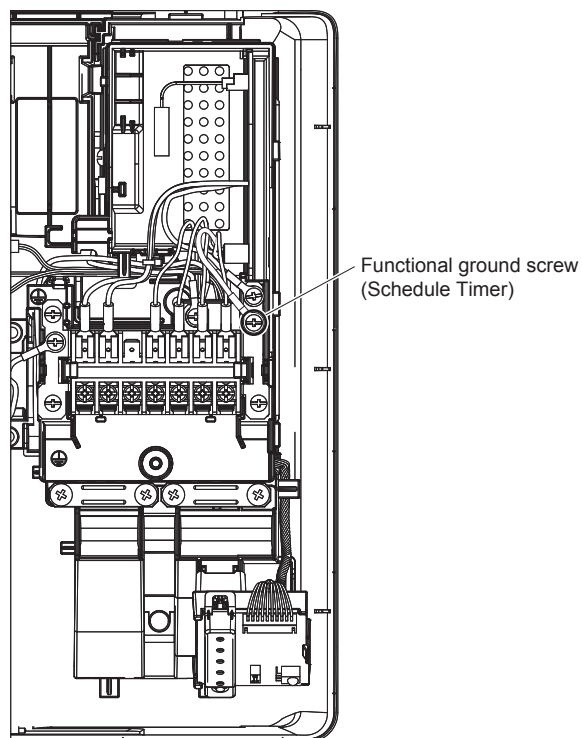
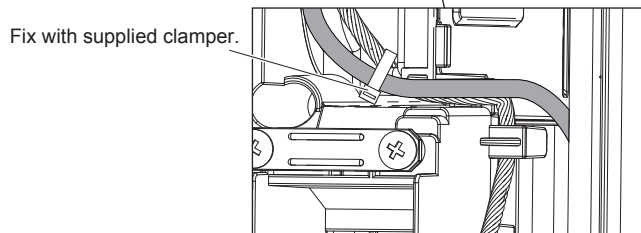
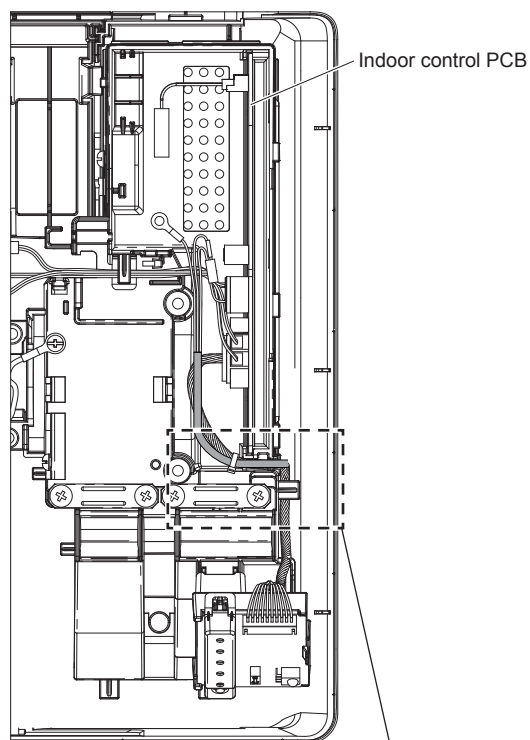
**<When connecting to other optional parts>**

- Connecting to schedule timer  
Connect the wire from the schedule timer to the indoor control PCB T10 (CN061, Yellow) and functional ground screw.
- Connecting to T10 connector  
Connect the wire to the indoor control PCB T10 (CN061, Yellow).

**Indoor control PCB**



**Wiring sample  
(Schedule Timer)**



(5) When finished wiring, attach the grille in the reverse order. Tighten the screws and install the screw covers.

## ■ HOW TO PROCESS TUBING

Must ensure mechanical connections be accessible for maintenance purposes.

### Connecting the Refrigerant Tubing

#### NOTE

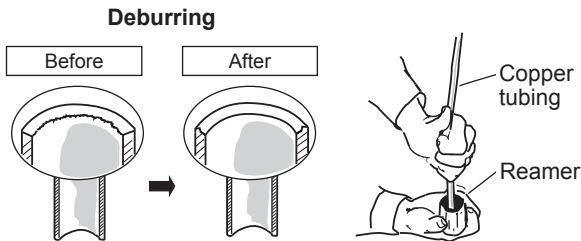
When connecting flare at indoor side, make sure that the flare connection is used only once. If torqued up and released, the flare must be remade. Once the flare connection was torqued up correctly and leak test was made, thoroughly clean and dry the surface to remove oil, dirt and grease by following instructions of silicone sealant. Apply neutral cure & ammonia-free silicone sealant that is non-corrosive to copper & brass to the external of the flared connection to prevent the ingress of moisture on both the gas & liquid sides. (Moisture may cause freezing and premature failure of the connection.)

#### Use of the Flaring Method

Many of conventional split system air conditioners employ the flaring method to connect refrigerant tubes that run between indoor and outdoor units. In this method, the copper tubes are flared at each end and connected with flare nuts.

#### Flaring Procedure with a Flare Tool

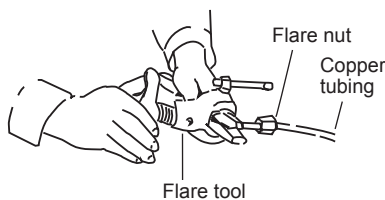
- (1) Cut the copper tube to the required length with a tube cutter. It is recommended to cut approx. 30 – 50 cm longer than the tubing length you estimate.
- (2) Remove burrs at each end of the copper tubing with a tube reamer or a similar tool. This process is important and should be done carefully to make a good flare. Be sure to keep any contaminants (moisture, dirt, metal filings, etc.) from entering the tubing.



#### NOTE

When reaming, hold the tube end downward and be sure that no copper scraps fall into the tube.

- (3) Remove the flare nut from the unit and be sure to mount it on the copper tube.
- (4) Make a flare at the end of the copper tube with a flare tool.



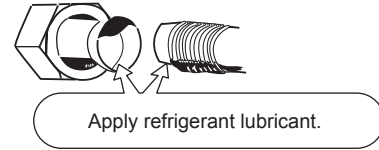
#### NOTE

When flared joints are reused, the flare part shall be re-fabricated. A good flare should have the following characteristics:

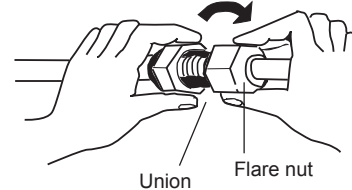
- inside surface is glossy and smooth
- edge is smooth
- tapered sides are of uniform length

#### Caution Before Connecting Tubes Tightly

- (1) Apply a sealing cap or water-proof tape to prevent dust or water from entering the tubes before they are used.
- (2) Be sure to apply refrigerant lubricant (ether oil) to the inside of the flare nut before making piping connections. This is effective for reducing gas leaks.



- (3) For proper connection, align the union tube and flare tube straight with each other, then screw on the flare nut lightly at first to obtain a smooth match.



- Adjust the shape of the liquid tube using a tube bender at the installation site and connect it to the liquid tubing side valve using a flare.

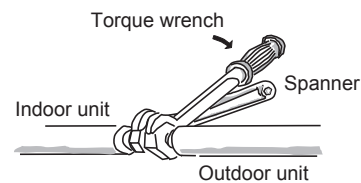
#### Connecting Tubing Between Indoor and Outdoor Units

- (1) Tightly connect the indoor-side refrigerant tubing extended from the wall with the outdoor-side tubing.

##### Indoor Unit Tubing Connection ( $l_1, l_2 \dots l_{n-1}$ )

Indoor unit type	50	60	71	100
Gas tubing (mm)	ø12.7	ø15.88		
Liquid tubing (mm)	ø6.35	ø9.52		

- (2) To fasten the flare nuts, apply specified torque.
- When removing the flare nuts from the tubing connections, or when tightening them after connecting the tubing, be sure to use a torque wrench and a spanner. If the flare nuts are over-tightened, the flare may be damaged, which could result in refrigerant leakage and cause injury or asphyxiation to room occupants.





- For the flare nuts at tubing connections, be sure to use the flare nuts that were supplied with the unit, or else flare nuts for R410A, R32 (type 2). The refrigerant tubing that is used must be of the correct wall thickness as shown in the table below.

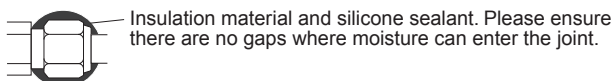
Tube diameter	Tightening torque (approximate)	Tube thickness
ø6.35 (1/4")	14 – 18 N · m {140 – 180 kgf · cm}	0.8 mm
ø9.52 (3/8")	34 – 42 N · m {340 – 420 kgf · cm}	0.8 mm
ø12.7 (1/2")	49 – 55 N · m {490 – 550 kgf · cm}	0.8 mm
ø15.88 (5/8")	68 – 82 N · m {680 – 820 kgf · cm}	1.0 mm

Because the pressure is approximately 1.6 times higher than conventional refrigerant R22 pressure, the use of ordinary flare nuts (type 1) or thin-walled tubes may result in tube rupture, injury, or asphyxiation caused by refrigerant leakage.

- In order to prevent damage to the flare caused by over-tightening of the flare nuts, use the table above as a guide when tightening.
- When tightening the flare nut on the liquid tube, use an adjustable wrench with a nominal handle length of 200 mm.

**!** Ensure to do the re-flaring of pipes before connecting to units to avoid leaking.

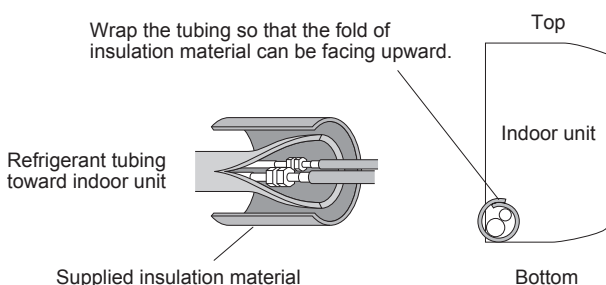
To prevent the ingress of moisture into the joint which could have the potential to freeze and then cause leakage, the joint must be sealed with suitable silicone and insulation material. The joint should be sealed on both liquid and gas side.



Silicone Sealant must be neutral cure and ammonia free. Use of silicon containing ammonia can lead to stress corrosion on the joint and cause leakage.

### Insulating the Refrigerant Tubing

Unless the insulation is made, condensation can cause damage to the interior of a property. Use the supplied insulation material.

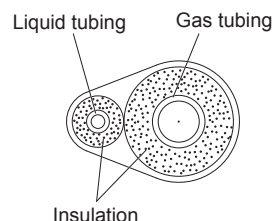


### Tubing Insulation

Must ensure that pipe-work shall be protected from physical damage.

- Thermal insulation must be applied to all units tubing, including distribution joint (field supply).

#### Two tubes arranged together



\* For gas tubing, the insulation material must be heat resistant to 120°C or above. For other tubing, it must be heat resistant to 80°C or above.

Insulation material thickness must be 10 mm or greater.

If the conditions inside the ceiling exceed DB 30°C and RH 70%, increase the thickness of the gas tubing insulation material by 1 step.

**!** CAUTION

If the exterior of the outdoor unit valves has been finished with a square duct covering, make sure you allow sufficient space to access the valves and to allow the panels to be attached and removed.

#### NOTE

#### Gas Leakage Detector

Note that the gas leakage detector should be capable of detecting the refrigerant R410A, R32.

#### Air Purging

Refer to "AIR PURGING" in the separate Installation Instructions for the outdoor unit in regard to air purging with a vacuum pump (for test run) preparation.

#### Taping the flare nuts

Cover up the tubing connections with the supplied flare insulator. Then fasten the insulator at both ends with the vinyl clamps (field supply).

#### Insulation material

The material used for insulation must have good insulation characteristics, be easy to use, be age resistant, and must not easily absorb moisture.

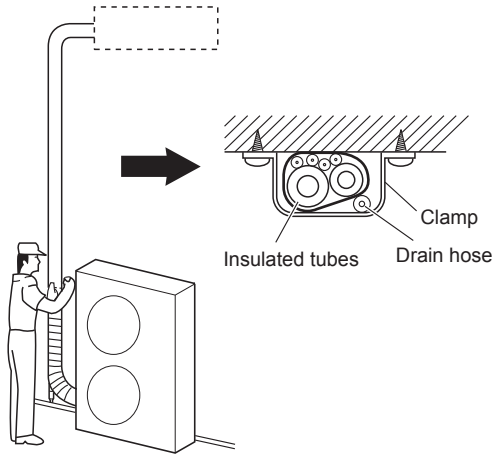
**!** CAUTION

After a tube has been insulated, never try to bend it into a narrow curve because it can cause the tube to break or crack. Never grasp the drain or refrigerant connecting outlets when moving the unit.

### Taping the Tubes

- (1) At this time, the refrigerant tubes (and electrical wiring if local codes permit) should be taped together with armoring tape in 1 bundle. To prevent condensation from overflowing the drain pan, keep the drain hose separate from the refrigerant tubing.
- (2) Wrap the armoring tape from the bottom of the outdoor unit to the top of the tubing where it enters the wall. As you wrap the tubing, overlap half of each previous tape turn.

- (3) Clamp the tubing bundle to the wall, using 1 clamp approx. each meter.

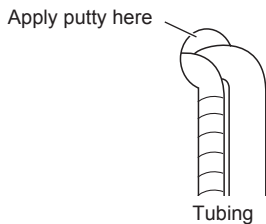


**NOTE**

Do not wind the armoring tape too tightly since this will decrease the heat insulation effect. Also ensure that the condensation drain hose splits away from the bundle and drips clear of the unit and the tubing.

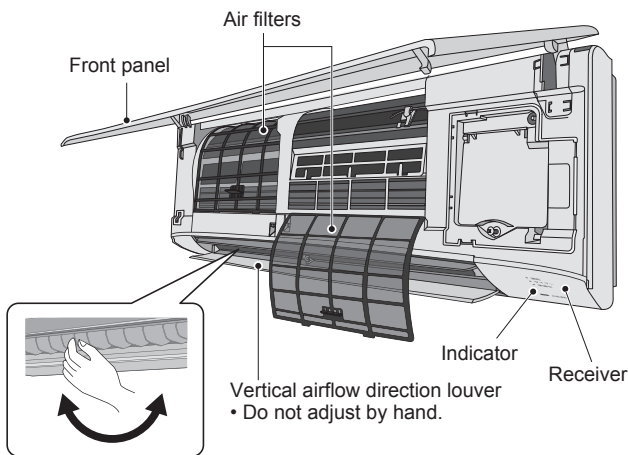
**Finishing the Installation**

After finishing insulating and taping over the tubing, use sealing putty to seal off the hole in the wall to prevent rain and draft from entering.



**BEFORE SWITCHING ON**

- Check if the filter is installed properly.
- Check if the horizontal airflow direction louver works properly.



Horizontal airflow direction louver  
• Manually-operated adjustable louvers

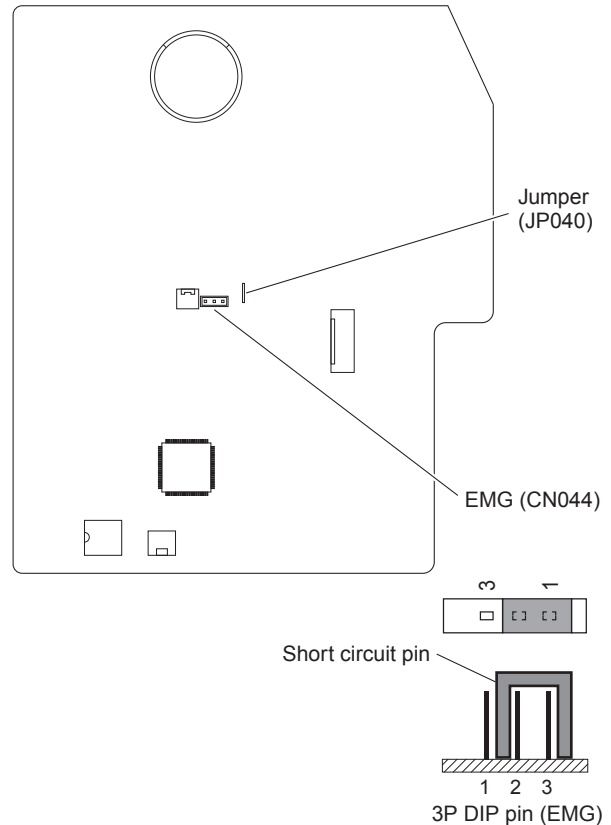
**HOW TO INSTALL THE TIMER REMOTE CONTROLLER OR HIGH-SPEC WIRED REMOTE CONTROLLER (OPTIONAL PART)**

**NOTE**

See "Section 2. TEST RUN".

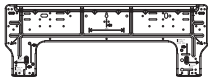



**PRECAUTIONS ON TEST RUN**

- Request that the customer be present when the test run is performed. At this time, explain the operation manual and have the customer perform the actual steps.
- Check that the 220 – 240 V AC power is not connected to the inter-unit control wiring connector terminal.  
\* If 220 – 240 V AC is accidentally applied, the indoor unit control PCB fuse will blow in order to protect the PCB. In this case, make the wiring correctly. Then reconnect the connector to pins 2 and 3 from pins 1 and 2 on the 3P DIP pin (EMG).  
If the operation is not activated even if the short circuit pin is reconnected, cut the jumper on the indoor unit PCB. (Be sure to turn the power OFF before performing this work.)



## Accessories Supplied with Unit

Make sure all accessory parts listed are with the system before beginning.

Part Name	Figure	Q'ty	Remarks
Installation plate		1	
Screw (4×20)		5	For installation plate installation
Flare insulation		1	For flare nut insulation
Clamper		1	For fixing wires (optional)

### Type of Copper Tube and Insulation Material

If you wish to purchase these materials separately from a local source, you will need:

1. Deoxidized annealed copper tube for refrigerant tubing.  
Cut each tube to the appropriate lengths +30 cm to 40 cm to dampen vibration between units.
2. Foamed polyethylene insulation for copper tubes as required to precise length of tubing. Wall thickness of the insulation should be not less than 8 mm.
3. Use insulated copper wire for field wiring. Wire size varies with the total length of wiring. Refer to **1-10. Electrical Wiring** for details.



### CAUTION

**Check local electrical codes and regulations before obtaining wire. Also, check any specified instructions or limitations.**

### Additional Materials Required for Installation

1. Refrigeration (armored) tape
2. Insulated staples or clamps for connecting wire (See your local codes.)
3. Putty
4. Refrigeration tubing lubricant
5. Clamps or saddles to secure refrigerant tubing
6. Scale for weighing

## ■ CHECKLIST AFTER INSTALLATION WORK

Work List	No.	Content	Check <input checked="" type="checkbox"/>	Possibility of Failure & Checkpoint
Installation	1	Are the indoor units installed following the content of the section "■ SELECTING THE INSTALLATION SITE"?(on page 1-11-4-1)	<input type="checkbox"/>	There is a possibility of light injure or loss of property.
Tubing & Wiring	2	Is the earth leakage circuit breaker (all-pole switching function provided) installed?	<input type="checkbox"/>	Power failure or short circuit may cause electric shock or fire. Check installation work and ground wire work.
	3	Is there any wrong installation of optional parts or wrong wiring?	<input type="checkbox"/>	
	4	Was the ground wire work performed?	<input type="checkbox"/>	
	5	Are there any wrong power supply wiring, wrong connection wire, wrong signal wire or loose screw?	<input type="checkbox"/>	
	6	Is the thickness of wire in accordance with rule?	<input type="checkbox"/>	
	7	Is the power-supply voltage range equal to the nameplate of the unit?	<input type="checkbox"/>	
	8	Was the check of the airtight test, flared tube fitting and gas leakage on the welded portion performed?	<input type="checkbox"/>	
Drain Check	9	Has the adhesive been applied to the drain connecting portion (resin portion) of the indoor unit?	<input type="checkbox"/>	The resin portion cracks after a few months and it may cause water drain.
	10	Is there water leakage?	<input type="checkbox"/>	Since there is a possibility of water drain, repair the drain pipe if the drain failure or water drain occurs.
	11	Indoor unit drain pipe has a downward gradient (1/100 or more) by rule. Is the drain water flowing smoothly?	<input type="checkbox"/>	
Heat Insulation	12	Was the heat insulation work at a suitable location including the flared tube fitting (refrigerant tube & drain pipe) performed properly?	<input type="checkbox"/>	The quality of unit not only becomes inferior but there is a possibility of the water drain. So, perform the heat insulation work properly.
Test Run	13	Did the abnormal sound occur?	<input type="checkbox"/>	Check if there is a fan contact or distortion of the indoor unit.
	14	Did the cool and warm airflow discharge from the indoor unit?	<input type="checkbox"/>	Check if the unit does not operate or there is a wrong tubing or wiring connection with another system.

## Important Information Regarding The Refrigerant Used

### NOTE

See "■ Outdoor Unit" under the Section 1-11. Installation Instructions.

### ■ SERVICING



#### CAUTION

- Any qualified person who is involved with working on or breaking into a refrigerant circuit should hold a current valid certificate from an industry-accredited assessment authority, which authorizes their competence to handle refrigerants safely in accordance with an industry recognised assessment specification.
  - Servicing shall only be performed as recommended by the equipment manufacturer. Maintenance and repair requiring the assistance of other skilled personnel shall be carried out under the supervision of the person competent in the use of flammable refrigerants.
  - Servicing shall be performed only as recommended by the manufacturer.
  - Prior to beginning work on systems containing flammable refrigerants, safety checks are necessary to ensure that the risk of ignition is minimised. For repair to the refrigerating system, (2) to (6) shall be completed prior to conducting work on the system.
- (1) Work shall be undertaken under a controlled procedure so as to minimise the risk of a flammable gas or vapour being present while the work is being performed.
  - (2) All maintenance staff and others working in the local area shall be instructed on the nature of work being carried out. Work in confined spaces shall be avoided. The area around the workspace shall be sectioned off. Ensure that the conditions within the area have been made safe by control of flammable material.
  - (3) The area shall be checked with an appropriate refrigerant detector prior to and during work, to ensure the technician is aware of potentially toxic or flammable atmospheres. Ensure that the leak detection equipment being used is suitable for use with all applicable refrigerants, i.e. non-sparking, adequately sealed or intrinsically safe.
  - (4) If any hot work is to be conducted on the refrigeration equipment or any associated parts, appropriate fire extinguishing equipment shall be available to hand. Have a dry powder or CO<sub>2</sub> fire extinguisher adjacent to the charging area.
  - (5) No person carrying out work in relation to a refrigeration system which involves exposing any pipe work shall use any sources of ignition in such a manner that it may lead to the risk of fire or explosion. All possible ignition sources, including cigarette smoking, should be kept sufficiently far away from the site of installation, repairing, removing and disposal, during which refrigerant can possibly be released to the surrounding space. Prior to work taking place, the area around the equipment is to be surveyed to make sure that there are no flammable hazards or ignition risks. "No Smoking" signs shall be displayed.
  - (6) Ensure that the area is in the open or that it is adequately ventilated before breaking into the system or conducting any hot work. A degree of ventilation shall continue during the period that the work is carried out. The ventilation should safely disperse any released refrigerant and preferably expel it externally into the atmosphere.
  - (7) Where electrical components are being changed, they shall be fit for the purpose and to the correct specification. At all times the manufacturer's maintenance and service guidelines shall be followed. If in doubt, consult the manufacturer's technical department for assistance.
    - The charge size is in accordance with the room size within which the refrigerant containing parts are installed.
    - The ventilation machinery and outlets are operating adequately and are not obstructed.
    - Marking to the equipment continues to be visible and legible. Markings and signs that are illegible shall be corrected.
    - Refrigeration pipe or components are installed in a position where they are unlikely to be exposed to any substance which may corrode refrigerant containing components, unless the components are constructed of materials which are inherently resistant to being corroded or are suitably protected against being so corroded.
  - (8) Repair and maintenance to electrical components shall include initial safety checks and component inspection procedures. If a fault exists that could compromise safety, then no electrical supply shall be connected to the circuit until it is satisfactorily dealt with. If the fault cannot be corrected immediately but it is necessary to continue operation, an adequate temporary solution shall be used. This shall be reported to the owner of the equipment so all parties are advised.
 

Initial safety checks shall include:

    - That no live electrical components and wiring are exposed while charging, recovering or purging the system.
    - That there is continuity of earth bonding.
- During repairs to sealed components, all electrical supplies shall be disconnected from the equipment being worked upon prior to any removal of sealed covers, etc.
  - Particular attention shall be paid to the following to ensure that by working on electrical components, the casing is not altered in such a way that the level of protection is affected. This shall include damage to cables, excessive number of connections, terminals not made to original specification, damage to seals, incorrect fitting of glands, etc.
  - Ensure that apparatus is mounted securely.
  - Ensure that seals or sealing materials have not degraded such that they no longer serve the purpose of preventing the ingress of flammable atmospheres.
  - Replacement parts shall be in accordance with the manufacturer's specifications.

#### NOTE:

The use of silicon sealant may inhibit the effectiveness of some types of leak detection equipment. Intrinsically safe components do not have to be isolated prior to working on them.

- Do not apply any permanent inductive or capacitance loads to the circuit without ensuring that this will not exceed the permissible voltage and current permitted for the equipment in use.
- Intrinsically safe components are the only types that can be worked on while live in the presence of a flammable atmosphere.
- The test apparatus shall be at the correct rating.
- Replace components only with parts specified by the manufacturer. Unspecified parts by manufacturer may result ignition of refrigerant in the atmosphere from a leak.

## ■ REMOVAL AND EVACUATION



### CAUTION

- When breaking into the refrigerant circuit to make repairs – or for any other purpose – conventional procedures shall be used. However, it is important that best practice is followed since flammability is a consideration. The following procedure shall be adhered to:
  - Remove refrigerant.
  - Purge the circuit with inert gas.
  - Evacuate.
  - Purge again with inert gas.
  - Open the circuit by cutting or brazing.
- The refrigerant charge shall be recovered into the correct recovery cylinders.
- The system shall be “flushed” with Oxygen free nitrogen (OFN) to render the unit safe.
- This process may need to be repeated several times.
- Compressed air or oxygen shall not be used for this task.
- Flushing shall be achieved by breaking the vacuum in the system with Oxygen free nitrogen (OFN) and continuing to fill until the working pressure is achieved, then venting to atmosphere, and finally pulling down to a vacuum.
- This process shall be repeated until no refrigerant is within the system.
- When the final Oxygen free nitrogen (OFN) charge is used, the system shall be vented down to atmospheric pressure to enable work to take place.
- This operation is absolutely vital if brazing operations on the pipe work are to take place.
- Ensure that the outlet for the vacuum pump is not close to any ignition sources and there is ventilation available.

## ■ CHARGING PROCEDURES

### NOTE

See “■ Outdoor Unit” under teh Section 1-11. Installation Instructions.

## ■ DECOMMISSIONING



### CAUTION

- Before carrying out this procedure, it is essential that the technician is completely familiar with the equipment and all its details.
- It is recommended good practice that all refrigerants are recovered safely.
- Prior to the task being carried out, an oil and refrigerant sample shall be taken in case analysis is required prior to re-use of reclaimed refrigerant.
- It is essential that electrical power is available before the task is commenced.
  - a) Become familiar with the equipment and its operation.
  - b) Isolate system electrically.
  - c) Before attempting the procedure ensure that:
    - Mechanical handling equipment is available, if required, for handling refrigerant cylinders.
    - All personal protective equipment is available and being used correctly.
    - The recovery process is supervised at all times by a competent person.
    - Recovery equipment and cylinders conform to the appropriate standards.
  - d) Pump down refrigerant system, if possible.
  - e) If a vacuum is not possible, make a manifold so that refrigerant can be removed from various parts of the system.
  - f) Make sure that cylinder is situated on the scales before recovery takes place.
  - g) Start the recovery machine and operate in accordance with manufacturer’s instructions.
  - h) Do not overfill cylinders. (No more than 80 % volume liquid charge).
  - i) Do not exceed the maximum working pressure of the cylinder, even temporarily.
  - j) When the cylinders have been filled correctly and the process completed, make sure that the cylinders and the equipment are removed from site promptly and all isolation valves on the equipment are closed off.
  - k) Recovered refrigerant shall not be charged into another refrigeration system unless it has been cleaned and checked.
- Electrostatic charge may accumulate and create a hazardous condition when charging or discharging the refrigerant. To avoid fire or explosion, dissipate static electricity during transfer by grounding and bonding containers and equipment before charging / discharging.

## ■ RECOVERY

### NOTE

See “12. Recovery” on page 1-11-1-6.

## ■ SELECTING THE INSTALLATION SITE

### 5. Low Silhouette Ducted Type (F1)

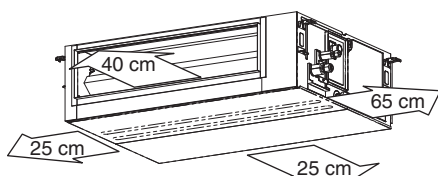
#### Indoor Unit

##### AVOID:

- areas where leakage of flammable gas may be expected.
- places where large amounts of oil mist exist.
- direct sunlight.
- locations near heat sources which may affect the performance of the unit.
- locations where external air may enter the room directly. This may cause “condensation” on the air discharge ports, causing them to spray or drip water.
- locations where the remote controller will be splashed with water or affected by dampness or humidity.
- installing the remote controller behind curtains or furniture.
- locations where high-frequency emissions are generated.

##### DO:

- select an appropriate position from which every corner of the room can be uniformly cooled.
- select a location where the ceiling is strong enough to support the weight of the unit.
- select a location where tubing and drain pipe have the shortest run to the outdoor unit.
- allow room for operation and maintenance as well as unrestricted airflow around the unit.
- the limitation of the tubing length between the indoor and the outdoor units should be referred to the Installation Instructions of the outdoor unit.
- allow room for mounting the remote controller about 1 m off the floor, in an area that is not in direct sunlight or in the flow of cool air from the indoor unit.



**HOW TO INSTALL THE INDOOR UNIT**

**Low Silhouette Ducted Type (Type F1)**

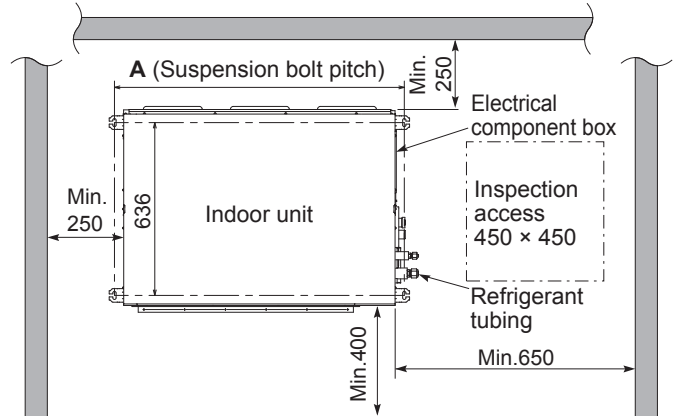
**Required Minimum Space for Installation and Service**

- This air conditioner is usually installed above the ceiling so that the indoor unit and ducts are not visible. Only the air intake and air outlet ports are visible from the unit bottom.

**Minimum space for installation and service**

Unit: mm

Type	50	60, 71	100, 125, 140
A (Length)	867	1,067	1,467



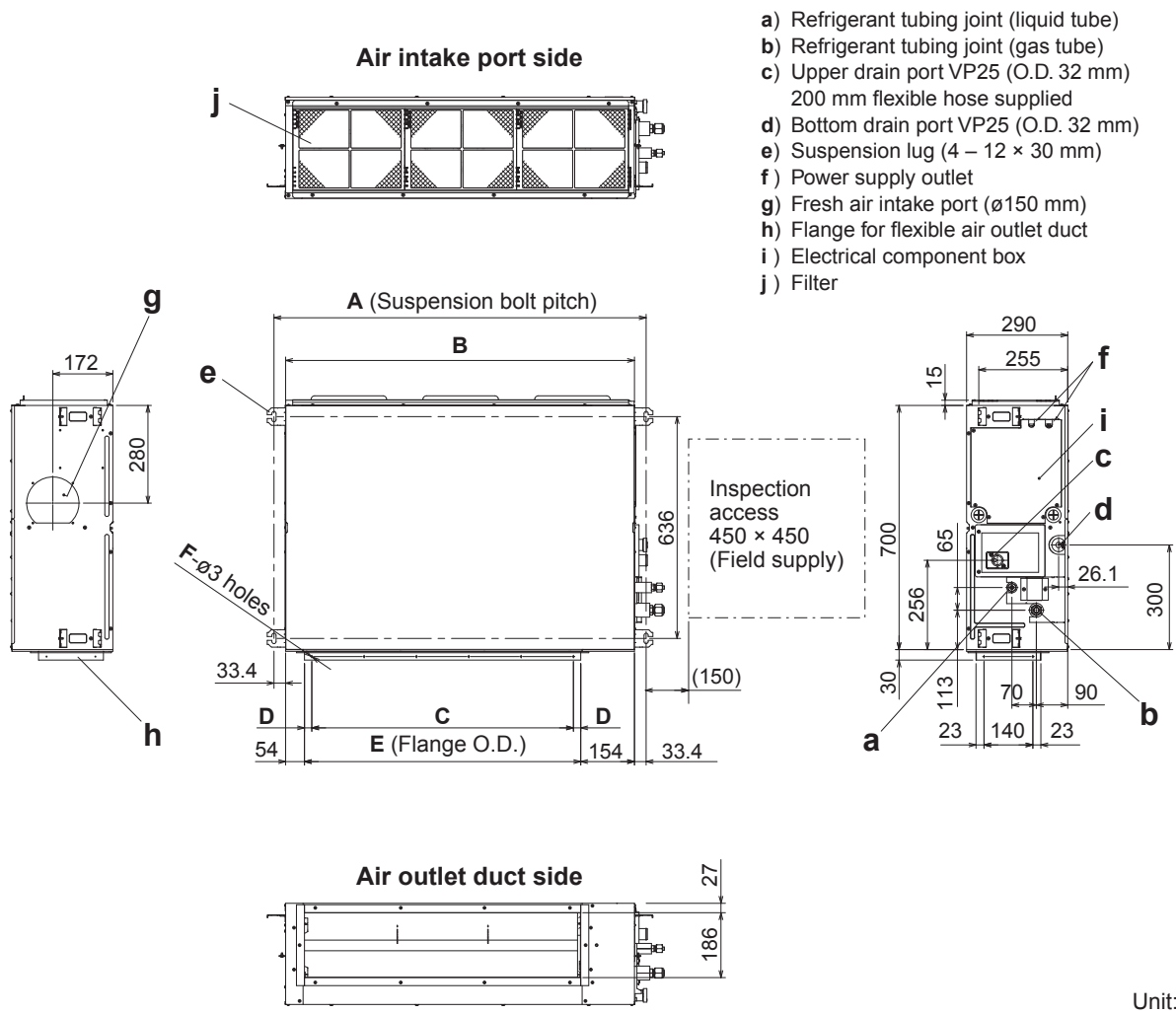
Unit: mm

- It is recommended that space be provided (450 × 450 mm) for checking and servicing the electrical system.

**Detailed dimensions of indoor unit**

Unit: mm

Type	A	B	C	D	E	F
50	867	800	450 (Pitch 150 × 3)	71	592	12
60, 71	1,067	1,000	750 (Pitch 150 × 5)	21	792	16
100, 125, 140	1,467	1,400	1,050 (Pitch 150 × 7)	71	1,192	20



- a) Refrigerant tubing joint (liquid tube)
- b) Refrigerant tubing joint (gas tube)
- c) Upper drain port VP25 (O.D. 32 mm)  
200 mm flexible hose supplied
- d) Bottom drain port VP25 (O.D. 32 mm)
- e) Suspension lug (4 – 12 × 30 mm)
- f) Power supply outlet
- g) Fresh air intake port (ø150 mm)
- h) Flange for flexible air outlet duct
- i) Electrical component box
- j) Filter

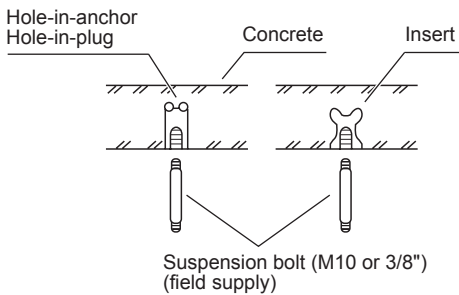
Unit: mm



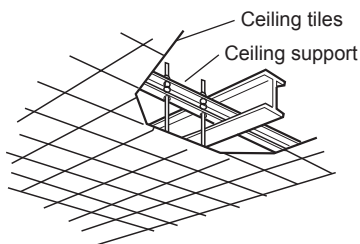
### Suspending the Indoor Unit

Depending on the ceiling type:

- a) Insert suspension bolts  
or
- b) Use existing ceiling supports or construct a suitable support.



a)



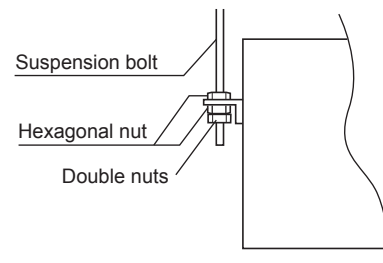
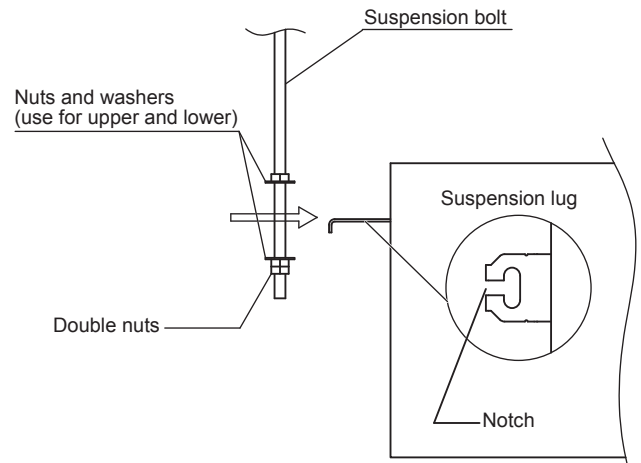
b)

**! WARNING**

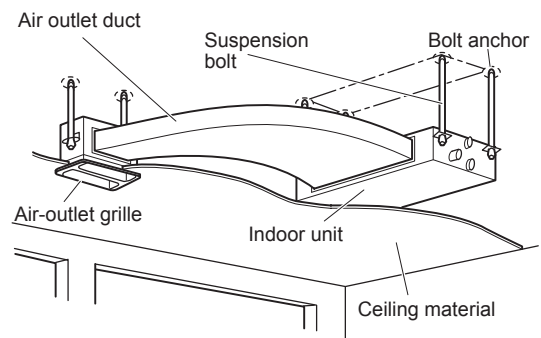
It is important that you use extreme care in supporting the indoor unit inside the ceiling. Ensure that the ceiling is strong enough to support the weight of the unit. Before hanging the unit, test the strength of each attached suspension bolt.

- (1) When placing the unit inside the ceiling, determine the pitch of the suspension bolts referring to the dimensional data as shown in the tables and diagrams under the section "Required Minimum Space for Installation and Service" on page 1-11-5-2. Tubing must be laid and connected inside the ceiling when suspending the unit. If the ceiling is already constructed, lay the tubing into position for connection to the unit before placing the unit inside the ceiling.
- (2) Screw in the suspension bolts allowing them to protrude from the ceiling. (Cut the ceiling material, if necessary.)

- (3) Thread the 3 hexagonal nuts and 2 washers (field supply) onto each of the 4 suspension bolts. Use 1 nut and 1 washer for the upper part, and 2 nuts and 1 washer for the lower part, so that the unit will not fall off the suspension lugs.



● This shows an example of installation.



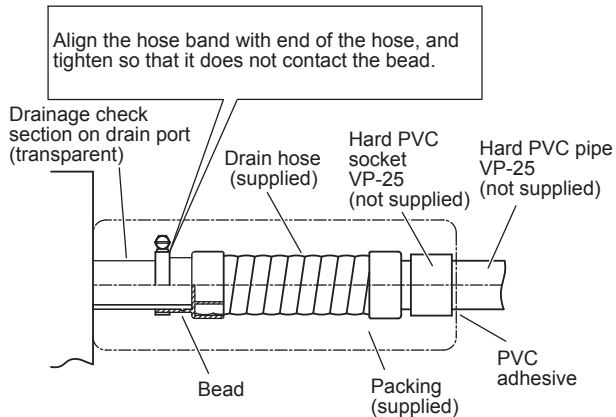
## Installing the Drain Pipe

- Prepare standard hard PVC pipe (O.D. 32 mm) for the drain and use the supplied hose band to prevent water leaks. The PVC pipe must be purchased separately. The transparent drain part on the unit allows you to check drainage.

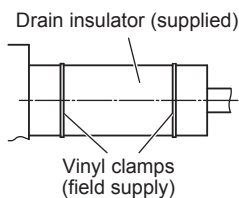


### CAUTION

- Do not use adhesive tape at the drain connection port on the indoor unit.
- Insert the drain pipe until it contacts the socket, and then secure it tightly with the hose band.
- Do not use the supplied drain hose bent at a 90° angle. (The maximum permissible bend is 45°.)
- Tighten the hose clamps so their locking nuts face upward.



- After connecting the drain pipe securely, wrap the supplied packing and drain pipe insulator around the pipe, then secure it with the vinyl clamps.



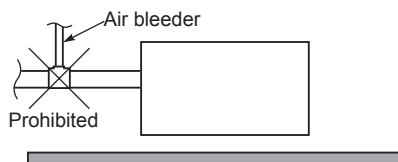
### NOTE

Make sure the drain pipe has a downward gradient (1/100 or more) and that there are no water traps.

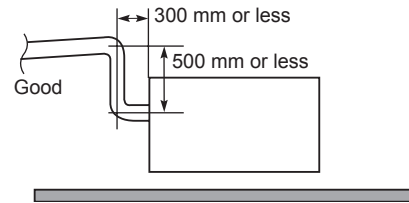


### CAUTION

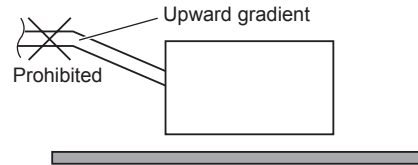
- Do not install an air bleeder as this may cause water to spray from the drain pipe outlet.



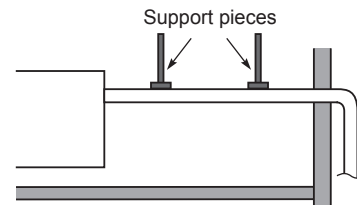
- If it is necessary to increase the height of the drain pipe, the section directly after the connection port can be raised a maximum of 500 mm. Do not raise it any higher than 500 mm, as this could result in water leaks.



- Do not install the pipe with an upward gradient from the connection port. This will cause the drain water to flow backward and leak when the unit is not operating.



- Do not apply force to the piping on the unit side when connecting the drain pipe. The pipe should not be allowed to hang unsupported from its connection to the unit. Fasten the pipe to a wall, frame, or other support as close to the unit as possible.



## Checking the Drainage

After wiring and drain piping are completed, use the following procedure to check that the water will drain smoothly. For this, prepare a bucket and wiping cloth to catch and wipe up spilled water.

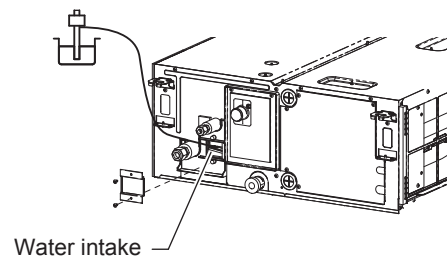
- Connect power to the power terminal board (R, S terminals) inside the electrical component box.
- Remove the tube cover and slowly pour about 1,200 cc of water through the opening into the drain pan to check drainage.
- Short-circuit the check pin (CHK) on the indoor control circuit board and operate the drain pump. Check the water flow through the transparent drain port and see if there is any leakage.



### CAUTION

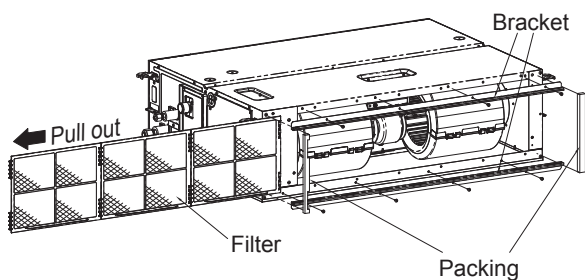
Be careful since the fan will start when you short the pin on the indoor control board.

- When the drainage check is complete, open the check pin (CHK) and remount the insulator and drain cap onto the drain inspection port.



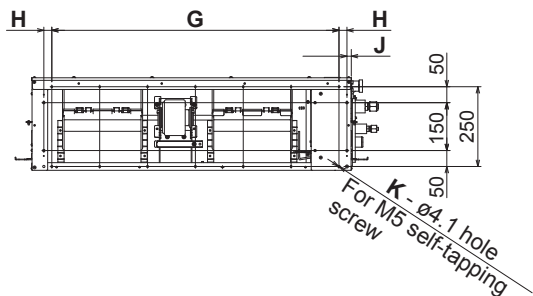
### Connecting Duct to Air Intake Port Side

- (1) First pull out a filter in the direction of the electrical equipment box in the unit.  
The pre-installed filter will not be used any more.



- (2) Then remove the seal packing, bracket and filter attached to the side of the air intake port.
- (3) Install the duct (field supply).  
See the figure for the dimension of the installation hole.  
Use M5 self-tapping screws for installation.

Unit: mm



Type	G	H	J	K
50	600 (Pitch 150 × 4)	25	11.3	14
60, 71	900 (Pitch 150 × 6)	25	13	18
100, 125, 140	1,350 (Pitch 150 × 9)	0	13	24

### NOTE

- Select an air-intake grille with a filter at a local shop.
- To get clean air and to extend the service life of the air conditioner, an air filter must be installed in the air intake. For installation and cleaning the air filter, consult your dealer or service center.

## ■ HOW TO PROCESS TUBING

Must ensure mechanical connections be accessible for maintenance purposes.

### Connecting the Refrigerant Tubing

#### NOTE

When connecting flare at indoor side, make sure that the flare connection is used only once. If torqued up and released, the flare must be remade. Once the flare connection was torqued up correctly and leak test was made, thoroughly clean and dry the surface to remove oil, dirt and grease by following instructions of silicone sealant. Apply neutral cure & ammonia-free silicone sealant that is non-corrosive to copper & brass to the external of the flared connection to prevent the ingress of moisture on both the gas & liquid sides. (Moisture may cause freezing and premature failure of the connection.)

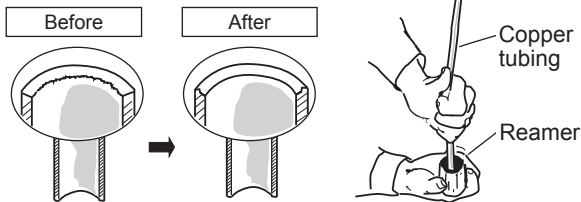
#### Use of the Flaring Method

Many of conventional split system air conditioners employ the flaring method to connect refrigerant tubes that run between indoor and outdoor units. In this method, the copper tubes are flared at each end and connected with flare nuts.

#### Flaring Procedure with a Flare Tool

- (1) Cut the copper tube to the required length with a tube cutter. It is recommended to cut approx. 30 – 50 cm longer than the tubing length you estimate.
- (2) Remove burrs at each end of the copper tubing with a tube reamer or a similar tool. This process is important and should be done carefully to make a good flare. Be sure to keep any contaminants (moisture, dirt, metal filings, etc.) from entering the tubing.

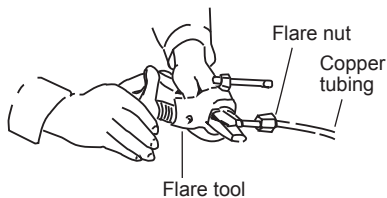
#### Deburring



#### NOTE

When reaming, hold the tube end downward and be sure that no copper scraps fall into the tube.

- (3) Remove the flare nut from the unit and be sure to mount it on the copper tube.
- (4) Make a flare at the end of the copper tube with a flare tool.



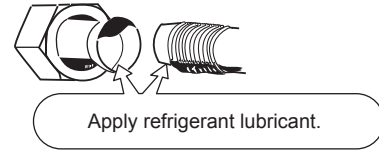
#### NOTE

When flared joints are reused, the flare part shall be re-fabricated. A good flare should have the following characteristics:

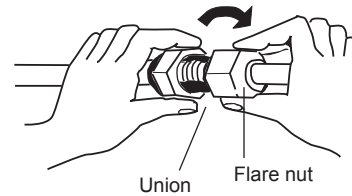
- inside surface is glossy and smooth
- edge is smooth
- tapered sides are of uniform length

#### Caution Before Connecting Tubes Tightly

- (1) Apply a sealing cap or water-proof tape to prevent dust or water from entering the tubes before they are used.
- (2) Be sure to apply refrigerant lubricant (ether oil) to the inside of the flare nut before making piping connections. This is effective for reducing gas leaks.



- (3) For proper connection, align the union tube and flare tube straight with each other, then screw on the flare nut lightly at first to obtain a smooth match.



- Adjust the shape of the liquid tube using a tube bender at the installation site and connect it to the liquid tubing side valve using a flare.

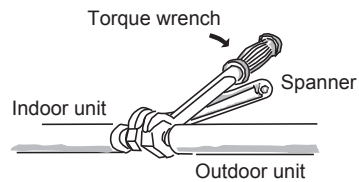
### Connecting Tubing Between Indoor and Outdoor Units

- (1) Tightly connect the indoor-side refrigerant tubing extended from the wall with the outdoor-side tubing.

#### Indoor Unit Tubing Connection ( $l_1, l_2 \dots l_{n-1}$ )

Indoor unit type	50	60	71	100	125	140
Gas tubing (mm)	ø12.7			ø15.88		
Liquid tubing (mm)	ø6.35			ø9.52		

- (2) To fasten the flare nuts, apply specified torque.
- When removing the flare nuts from the tubing connections, or when tightening them after connecting the tubing, be sure to use a torque wrench and a spanner. If the flare nuts are over-tightened, the flare may be damaged, which could result in refrigerant leakage and cause injury or asphyxiation to room occupants.



- For the flare nuts at tubing connections, be sure to use the flare nuts that were supplied with the unit, or else flare nuts for R410A, R32 (type 2). The refrigerant tubing that is used must be of the correct wall thickness as shown in the table below.

Tube diameter	Tightening torque (approximate)	Tube thickness
ø6.35 (1/4")	14 – 18 N · m {140 – 180 kgf · cm}	0.8 mm
ø9.52 (3/8")	34 – 42 N · m {340 – 420 kgf · cm}	0.8 mm
ø12.7 (1/2")	49 – 55 N · m {490 – 550 kgf · cm}	0.8 mm
ø15.88 (5/8")	68 – 82 N · m {680 – 820 kgf · cm}	1.0 mm

Because the pressure is approximately 1.6 times higher than conventional refrigerant R22 pressure, the use of ordinary flare nuts (type 1) or thin-walled tubes may result in tube rupture, injury, or asphyxiation caused by refrigerant leakage.

- In order to prevent damage to the flare caused by over-tightening of the flare nuts, use the table above as a guide when tightening.
- When tightening the flare nut on the liquid tube, use an adjustable wrench with a nominal handle length of 200 mm.

### Insulating the Refrigerant Tubing

#### Tubing Insulation

Must ensure that pipe-work shall be protected from physical damage.

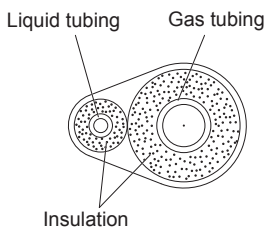
- Thermal insulation must be applied to all units tubing, including distribution joint (field supply).

\* For gas tubing, the insulation material must be heat resistant to 120°C or above. For other tubing, it must be heat resistant to 80°C or above.

Insulation material thickness must be 10 mm or greater.

If the conditions inside the ceiling exceed DB 30°C and RH 70%, increase the thickness of the gas tubing insulation material by 1 step.

#### Two tubes arranged together

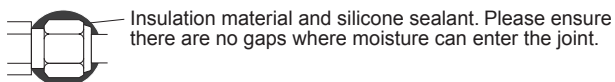


### CAUTION

If the exterior of the outdoor unit valves has been finished with a square duct covering, make sure you allow sufficient space to access the valves and to allow the panels to be attached and removed.

Ensure to do the re-flaring of pipes before connecting to units to avoid leaking.

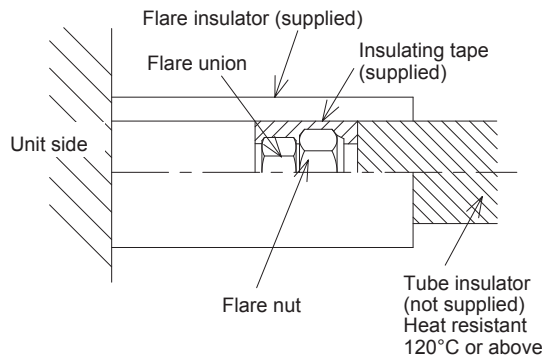
To prevent the ingress of moisture into the joint which could have the potential to freeze and then cause leakage, the joint must be sealed with suitable silicone and insulation material. The joint should be sealed on both liquid and gas side.



Silicone Sealant must be neutral cure and ammonia free. Use of silicon containing ammonia can lead to stress corrosion on the joint and cause leakage.

### Taping the flare nuts

Wind the white insulating tape around the flare nuts at the gas tube connections. Then cover up the tubing connections with the flare insulator, and fill the gap at the union with the supplied black insulating tape. Finally, fasten the insulator at both ends with the supplied vinyl clamps.



### Insulation material

The material used for insulation must have good insulation characteristics, be easy to use, be age resistant, and must not easily absorb moisture.

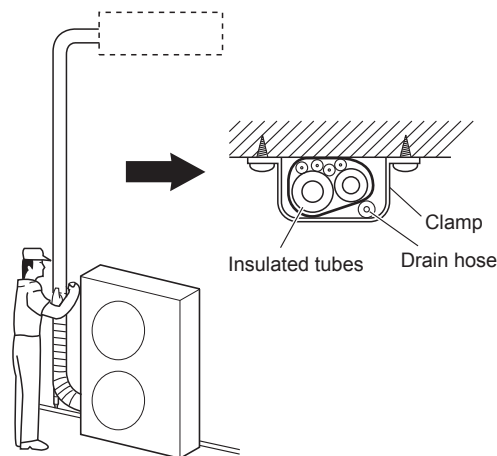
### CAUTION

After a tube has been insulated, never try to bend it into a narrow curve because it can cause the tube to break or crack.

Never grasp the drain or refrigerant connecting outlets when moving the unit.

### Taping the Tubes

- (1) At this time, the refrigerant tubes (and electrical wiring if local codes permit) should be taped together with armoring tape in 1 bundle. To prevent condensation from overflowing the drain pan, keep the drain hose separate from the refrigerant tubing.
- (2) Wrap the armoring tape from the bottom of the outdoor unit to the top of the tubing where it enters the wall. As you wrap the tubing, overlap half of each previous tape turn.
- (3) Clamp the tubing bundle to the wall, using 1 clamp approx. each meter.

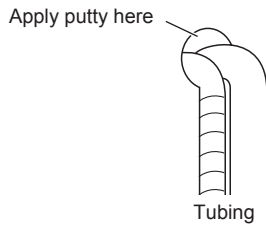


### NOTE

Do not wind the armoring tape too tightly since this will decrease the heat insulation effect. Also ensure that the condensation drain hose splits away from the bundle and drips clear of the unit and the tubing.

## Finishing the Installation

After finishing insulating and taping over the tubing, use sealing putty to seal off the hole in the wall to prevent rain and draft from entering.



### ■ HOW TO INSTALL THE TIMER REMOTE CONTROLLER OR HIGH-SPEC WIRED REMOTE CONTROLLER (OPTIONAL PART)

#### NOTE

See "Section 2. TEST RUN".








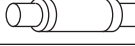



### ■ HOW TO INSTALL WIRELESS REMOTE CONTROLLER (OPTIONAL PART)

#### NOTE

See "Section 8. HOW TO INSTALL THE WIRELESS REMOTE CONTROLLER RECEIVER".

## Accessories Supplied with Unit

Table 1-11-5 (Low Silhouette Ducted)

Part Name	Figure	Q'ty	Remarks
Washer		8	For suspending indoor unit from ceiling
Flare insulator		2	For gas and liquid tubes
Insulating tape		2	For gas and liquid tubes flare nuts
Drain insulator		1	For drain hose joint
Hose band		1	For securing drain hose
Packing		1	For drain hose joint (hard material)
Packing		1	For drain hose joint (soft material)
Drain hose		1	
Operating Instructions		1	
Installation Instructions		1	
Short-circuit connection		1	For high static pressure (Located on the back of the electrical component box lid.)

- Use M10 for suspension bolts.
- Suspension bolts and nuts are field supply.

### Type of Copper Tube and Insulation Material

If you wish to purchase these materials separately from a local source, you will need:

1. Deoxidized annealed copper tube for refrigerant tubing.
2. Foamed polyethylene insulation for copper tubes as required to precise length of tubing. Wall thickness of the insulation should be not less than 8 mm.
3. Use insulated copper wire for field wiring. Wire size varies with the total length of wiring. See the section "1-10. Electrical Wiring" for details.



#### CAUTION

Check local electrical codes and regulations before obtaining wire. Also, check any specified instructions or limitations.

### Additional Materials Required for Installation

1. Refrigeration (armored) tape
2. Insulated staples or clamps for connecting wire (See your local codes.)
3. Putty
4. Refrigeration tubing lubricant
5. Clamps or saddles to secure refrigerant tubing
6. Scale for weighing

## ■ CHECKLIST AFTER INSTALLATION WORK

Work List	No.	Content	Check <input checked="" type="checkbox"/>	Possibility of Failure & Checkpoint
Installation	1	Are the indoor units installed following the content of the section "■ SELECTING THE INSTALLATION SITE"? (on page 1-11-5-1)	<input type="checkbox"/>	There is a possibility of light injure or loss of property.
Tubing & Wiring	2	In the case of multiple installation: Is there a wrong tubing connection with another system?	<input type="checkbox"/>	The unit is inoperated or the refrigerant flows into the inoperative unit and the leakage is expected. Check if there is a wrong tubing or wiring connection with another system.
	3	In the case of multiple installation: Is there a wrong wiring connection with another system?	<input type="checkbox"/>	
	4	Is the earth leakage circuit breaker (all-pole switching function provided) installed?	<input type="checkbox"/>	Power failure or short circuit may cause electric shock or fire. Check installation work and ground wire work.
	5	Is there any wrong installation of optional parts or wrong wiring?	<input type="checkbox"/>	
	6	Was the ground wire work performed?	<input type="checkbox"/>	
	7	Are there any wrong power supply wiring, wrong connection wire, wrong signal wire or loose screw?	<input type="checkbox"/>	
	8	Is the thickness of wire in accordance with rule?	<input type="checkbox"/>	
	9	Is the power-supply voltage equal to the nameplate of the unit?	<input type="checkbox"/>	
	10	Was the check of the airtight test, flared tube fitting and gas leakage on the welded portion performed?	<input type="checkbox"/>	If the gas leakage occurs, the unit quality not only becomes inferior but affects environment. Repair it as quickly as possible.
	Drain Check	11	Has the adhesive been applied to the drain connecting portion (resin portion) of the indoor unit?	<input type="checkbox"/>
12		Is there water leakage?	<input type="checkbox"/>	Since there is a possibility of water drain, repair the drain pipe if the drain failure or water drain occurs.
13		Indoor unit drain pipe has a downward gradient (1/100 or more) by rule. Is the drain water flowing smoothly?	<input type="checkbox"/>	
Heat Insulation	14	Was the heat insulation work at a suitable location including the flared tube fitting (refrigerant tube & drain pipe) performed properly?	<input type="checkbox"/>	The quality of unit not only becomes inferior but there is a possibility of the water drain. So, perform the heat insulation work properly.
Test Run	15	Did the abnormal sound occur?	<input type="checkbox"/>	Check if there is a fan contact or distortion of the indoor unit.
	16	Did the cool and warm airflow discharge from the indoor unit?	<input type="checkbox"/>	Check if the unit does not operate or there is a wrong tubing or wiring connection with another system.

## ■ APPENDIX

### Care and Cleaning

#### ⚠ WARNING

- For safety, be sure to turn the air conditioner off and also to disconnect the power before cleaning.
- Do not pour water on the indoor unit to clean it. This will damage the internal components and cause an electric shock hazard.

#### Air intake and outlet side (Indoor unit)

Clean the air intake and outlet side of the indoor unit with a vacuum cleaner brush, or wipe them with a clean, soft cloth.

If these parts are stained, use a clean cloth moistened with water. When cleaning the air outlet side, be careful not to force the vanes out of place.

#### ⚠ CAUTION

- Never use solvents or harsh chemicals when cleaning the indoor unit. Do not wipe plastic parts using very hot water.
- Some metal edges and the fins are sharp and may cause injury if handled improperly; be especially careful when you clean these parts.

#### Air filter

##### ● In case of Using the Supplied Air Filter

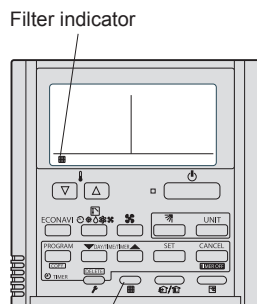
The air filter collects dust and other particles from the air and should be cleaned at regular intervals as indicated in the table below or when the filter indication (■) on the display of the remote controller (wired type) shows that the filter needs cleaning. If the filter gets blocked, the efficiency of the air conditioner drops greatly.

Type	F1
Period	2 weeks

##### ● After Cleaning

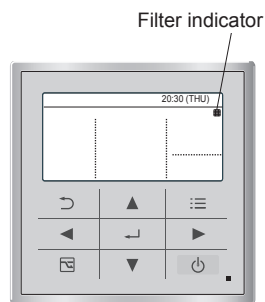
1. After the air filter is cleaned, reinstall it in its original position.  
Be sure to reinstall in reverse order.
2. [In the case of Timer Remote Controller]  
Press the Filter reset button.  
The ■ (Filter) indicator on the display goes out.  
[In the case of High-spec Wired Remote Controller]  
Refer to the Operating Instructions attached to the optional High-spec Wired Remote Controller.

Timer Remote Controller



Filter reset button

High-spec Wired Remote Controller



Filter indicator

#### NOTE

The frequency with which the filter should be cleaned depends on the environment in which the unit is used.

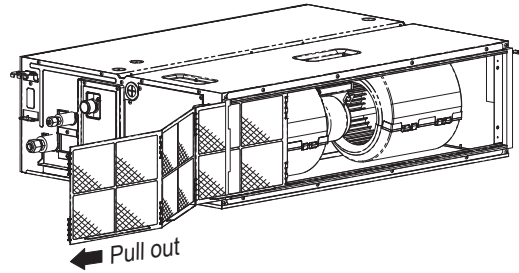
Clean the filter frequently for best performance in the area of dusty or oil spots regardless of filter status.

#### <How to clean the filter>

Use a vacuum cleaner to remove light dust. If there is sticky dust on the filter, wash the filter in lukewarm, soapy water, rinse it in clean water, and dry it.

#### <How to remove the filter>

Pull out a filter in the direction of the electrical equipment box in the unit.



##### ● In case of Installing the Duct (field supply)

Type	F1
Period	(Depends on filter's specifications)

When cleaning the air filter, consult your dealer or service center.

#### ⚠ CAUTION

- Certain metal edges and the condenser fins are sharp and may cause injury if handled improperly; special care should be taken when you clean these parts.
- The internal coil and other components must also be cleaned periodically. Consult your dealer or service center.

#### Care: After a prolonged idle period

Check the indoor and outdoor unit air intakes and outlets for blockage; if there is a blockage, remove it.

#### Care: Before a prolonged idle period

- Operate the fan for half a day to dry out the inside.
- Disconnect the power supply and also turn off the circuit breaker.
- Clean the air filter and replace it in its original position.



## Troubleshooting

If your air conditioner does not work properly, first check the following points before requesting service. If it still does not work properly, contact your dealer or a service center.

### ● Indoor unit

Symptom		Cause
Noise	Sound like streaming water during operation or after operation.	<ul style="list-style-type: none"> <li>● Sound of refrigerant liquid flowing inside unit</li> <li>● Sound of drainage water through drain pipe</li> </ul>
	Cracking noise during operation or when operation stops.	Cracking sound due to temperature changes of parts
Odor	Discharged air is smelled during operation.	Indoor odor components, cigarette odor and cosmetic odor accumulated in the air conditioner and its air is discharged. Unit inside is dusty. Consult your dealer.
Dewdrop	Dewdrop gets accumulated near air discharge during operation.	Indoor moisture is cooled by cool wind and accumulated by dewdrop.
Fog	Fog occurs during operation in cooling mode. (Places where large amounts of oil mist exist at restaurants.)	<ul style="list-style-type: none"> <li>● Cleaning is necessary because unit inside (heat exchanger) is dirty. Consult your dealer as technical engineering is required.</li> <li>● During defrost operation</li> </ul>
Fan is rotating for a while even though operation stops.		<ul style="list-style-type: none"> <li>● Fan rotating makes operation smoothly.</li> <li>● Fan may sometimes rotates because of drying heat exchanger due to settings.</li> </ul>
Wind-direction changes while operating. Wind-direction setting cannot be made. Wind-direction cannot be changed.		<ul style="list-style-type: none"> <li>● When air discharge temperature is low or during defrost operation, horizontal wind flow is made automatically.</li> <li>● Flap position is occasionally set up individually.</li> </ul>
When wind-direction is changed, flap operates several times and stops at designated position.		When wind-direction is changed, flap operates after searching for standard position.
Dust		Dust accumulation inside indoor unit is discharged.
At the initial high-speed operation, the fan may sometimes rotate faster (for 3 to 30 minutes) than the setting speed.		This is for operation check in order to confirm whether the fan motor rotation is within use range.

### ● Check Before Requiring Services

Symptom	Cause	Remedy
Air conditioner does not run at all although power is turned on.	Power failure or after power failure	Press ON/OFF operation button on remote controller again.
	Operation button is turned off.	<ul style="list-style-type: none"> <li>● Switch on power if breaker is turned off.</li> <li>● If breaker has been tripped, consult your dealer without turning it on.</li> </ul>
	Fuse blow out.	If blown out, consult your dealer.
Poor cooling or heating performance.	Air intake or air discharge port of indoor and outdoor units is clogged with dust or obstacles.	Remove dust or obstruction.
	Fan speed switch is set to "Low".	Change to "Medium" or "High".
	Improper temperature settings	Refer to "Tips for Energy Saving" (on page 1-11-5-12).
	Room is exposed to direct sunlight in cooling mode.	
	Doors and /or windows are open.	
	Air filter is clogged.	Refer to "Care and Cleaning" (on page 1-11-5-10).
	Too much heat sources in room in cooling mode.	Use minimum heat sources and in a short time.
Too many people in room in cooling mode.	Reduce temperature settings or change to "Medium" or "High".	

If your air conditioner still does not work properly although you checked the points as described above, first stop the operation and turn off the power switch. Then contact your dealer and report the serial number and symptom. Never repair your air conditioner by yourself since it is very dangerous for you to do so.

## Tips for Energy Saving

### Avoid

- Do not block the air intake and outlet of the unit. If either is obstructed, the unit will not work well, and may be damaged.
- Do not let direct sunlight into the room. Use sunshades, blinds or curtains. If the walls and ceiling of the room are warmed by the sun, it will take longer to cool the room.

### Do

- Always try to keep the air filter clean. (Refer to “Care and Cleaning” on page 1-11-5-10.) A clogged filter will impair the performance of the unit.
- To prevent conditioned air from escaping, keep windows, doors and any other openings closed.

### NOTE

#### Should the power fail while the unit is running

If the power supply for this unit is temporarily cut off, the unit will automatically resume operation once power is restored using the same settings before the power was interrupted.

## IMPORTANT INFORMATION REGARDING THE REFRIGERANT USED

### NOTE

See “■ Outdoor Unit” under the Section 1-11. Installation Instructions.

### ■ SERVICING



#### CAUTION

- Any qualified person who is involved with working on or breaking into a refrigerant circuit should hold a current valid certificate from an industry-accredited assessment authority, which authorizes their competence to handle refrigerants safely in accordance with an industry recognised assessment specification.
  - Servicing shall only be performed as recommended by the equipment manufacturer. Maintenance and repair requiring the assistance of other skilled personnel shall be carried out under the supervision of the person competent in the use of flammable refrigerants.
  - Servicing shall be performed only as recommended by the manufacturer.
  - Prior to beginning work on systems containing flammable refrigerants, safety checks are necessary to ensure that the risk of ignition is minimised. For repair to the refrigerating system, (2) to (6) shall be completed prior to conducting work on the system.
- (1) Work shall be undertaken under a controlled procedure so as to minimise the risk of a flammable gas or vapour being present while the work is being performed.
  - (2) All maintenance staff and others working in the local area shall be instructed on the nature of work being carried out. Work in confined spaces shall be avoided. The area around the workspace shall be sectioned off. Ensure that the conditions within the area have been made safe by control of flammable material.
  - (3) The area shall be checked with an appropriate refrigerant detector prior to and during work, to ensure the technician is aware of potentially toxic or flammable atmospheres. Ensure that the leak detection equipment being used is suitable for use with all applicable refrigerants, i.e. non-sparking, adequately sealed or intrinsically safe.
  - (4) If any hot work is to be conducted on the refrigeration equipment or any associated parts, appropriate fire extinguishing equipment shall be available to hand. Have a dry powder or CO<sub>2</sub> fire extinguisher adjacent to the charging area.
  - (5) No person carrying out work in relation to a refrigeration system which involves exposing any pipe work shall use any sources of ignition in such a manner that it may lead to the risk of fire or explosion. All possible ignition sources, including cigarette smoking, should be kept sufficiently far away from the site of installation, repairing, removing and disposal, during which refrigerant can possibly be released to the surrounding space. Prior to work taking place, the area around the equipment is to be surveyed to make sure that there are no flammable hazards or ignition risks. “No Smoking” signs shall be displayed.
  - (6) Ensure that the area is in the open or that it is adequately ventilated before breaking into the system or conducting any hot work. A degree of ventilation shall continue during the period that the work is carried out. The ventilation should safely disperse any released refrigerant and preferably expel it externally into the atmosphere.
  - (7) Where electrical components are being changed, they shall be fit for the purpose and to the correct specification. At all times the manufacturer’s maintenance and service guidelines shall be followed. If in doubt, consult the manufacturer’s technical department for assistance.
    - The charge size is in accordance with the room size within which the refrigerant containing parts are installed.
    - The ventilation machinery and outlets are operating adequately and are not obstructed.
    - Marking to the equipment continues to be visible and legible. Markings and signs that are illegible shall be corrected.
    - Refrigeration pipe or components are installed in a position where they are unlikely to be exposed to any substance which may corrode refrigerant containing components, unless the components are constructed of materials which are inherently resistant to being corroded or are suitably protected against being so corroded.

(8) Repair and maintenance to electrical components shall include initial safety checks and component inspection procedures. If a fault exists that could compromise safety, then no electrical supply shall be connected to the circuit until it is satisfactorily dealt with. If the fault cannot be corrected immediately but it is necessary to continue operation, an adequate temporary solution shall be used. This shall be reported to the owner of the equipment so all parties are advised.

Initial safety checks shall include:

- That no live electrical components and wiring are exposed while charging, recovering or purging the system.
- That there is continuity of earth bonding.
- During repairs to sealed components, all electrical supplies shall be disconnected from the equipment being worked upon prior to any removal of sealed covers, etc.
- Particular attention shall be paid to the following to ensure that by working on electrical components, the casing is not altered in such a way that the level of protection is affected. This shall include damage to cables, excessive number of connections, terminals not made to original specification, damage to seals, incorrect fitting of glands, etc.
- Ensure that apparatus is mounted securely.
- Ensure that seals or sealing materials have not degraded such that they no longer serve the purpose of preventing the ingress of flammable atmospheres.
- Replacement parts shall be in accordance with the manufacturer's specifications.

NOTE:

The use of silicon sealant may inhibit the effectiveness of some types of leak detection equipment. Intrinsically safe components do not have to be isolated prior to working on them.

- Do not apply any permanent inductive or capacitance loads to the circuit without ensuring that this will not exceed the permissible voltage and current permitted for the equipment in use.
- Intrinsically safe components are the only types that can be worked on while live in the presence of a flammable atmosphere.
- The test apparatus shall be at the correct rating.
- Replace components only with parts specified by the manufacturer. Unspecified parts by manufacturer may result ignition of refrigerant in the atmosphere from a leak.

## ■ REMOVAL AND EVACUATION



### CAUTION

- When breaking into the refrigerant circuit to make repairs – or for any other purpose – conventional procedures shall be used. However, it is important that best practice is followed since flammability is a consideration. The following procedure shall be adhered to:
  - Remove refrigerant.
  - Purge the circuit with inert gas.
  - Evacuate.
  - Purge again with inert gas.
  - Open the circuit by cutting or brazing.
- The refrigerant charge shall be recovered into the correct recovery cylinders.
- The system shall be “flushed” with Oxygen free nitrogen (OFN) to render the unit safe.
- This process may need to be repeated several times.
- Compressed air or oxygen shall not be used for this task.
- Flushing shall be achieved by breaking the vacuum in the system with Oxygen free nitrogen (OFN) and continuing to fill until the working pressure is achieved, then venting to atmosphere, and finally pulling down to a vacuum.
- This process shall be repeated until no refrigerant is within the system.
- When the final Oxygen free nitrogen (OFN) charge is used, the system shall be vented down to atmospheric pressure to enable work to take place.
- This operation is absolutely vital if brazing operations on the pipe work are to take place.
- Ensure that the outlet for the vacuum pump is not close to any ignition sources and there is ventilation available.

## ■ CHARGING PROCEDURES

### NOTE

See “■ Outdoor Unit” under the Section 1-11. Installation Instructions.

## ■ DECOMMISSIONING



### CAUTION

- Before carrying out this procedure, it is essential that the technician is completely familiar with the equipment and all its details.
- It is recommended good practice that all refrigerants are recovered safely.
- Prior to the task being carried out, an oil and refrigerant sample shall be taken in case analysis is required prior to re-use of reclaimed refrigerant.

- It is essential that electrical power is available before the task is commenced.
  - a) Become familiar with the equipment and its operation.
  - b) Isolate system electrically.
  - c) Before attempting the procedure ensure that:
    - Mechanical handling equipment is available, if required, for handling refrigerant cylinders.
    - All personal protective equipment is available and being used correctly.
    - The recovery process is supervised at all times by a competent person.
    - Recovery equipment and cylinders conform to the appropriate standards.
  - d) Pump down refrigerant system, if possible.
  - e) If a vacuum is not possible, make a manifold so that refrigerant can be removed from various parts of the system.
  - f) Make sure that cylinder is situated on the scales before recovery takes place.
  - g) Start the recovery machine and operate in accordance with manufacturer's instructions.
  - h) Do not overfill cylinders. (No more than 80 % volume liquid charge).
  - i) Do not exceed the maximum working pressure of the cylinder, even temporarily.
  - j) When the cylinders have been filled correctly and the process completed, make sure that the cylinders and the equipment are removed from site promptly and all isolation valves on the equipment are closed off.
  - k) Recovered refrigerant shall not be charged into another refrigeration system unless it has been cleaned and checked.
- Electrostatic charge may accumulate and create a hazardous condition when charging or discharging the refrigerant. To avoid fire or explosion, dissipate static electricity during transfer by grounding and bonding containers and equipment before charging / discharging.

## ■ RECOVERY

### NOTE

See "12. Recovery" on page 1-11-1-6.

1-12. Capacity Table

1. Cooling Capacity Performance Data

U-100PZ2E5 (U-100PZ2E8)

TC :Cooling Capacity

SHC :Sensible Heat Capacity

IPT :Cooling Power Consumption

unit : kW

Model	Power Source	Ambient Return Air		Outdoor air intake temp(°C D.B.)																
				25°C			30°C			35°C			40°C			43°C				
		DB	WB	TC	SHC	IPT	TC	SHC	IPT	TC	SHC	IPT	TC	SHC	IPT	TC	SHC	IPT		
S-50PU2E5B x2 U-100PZ2E5 (U-100PZ2E8)	220V-230V-240V 50Hz 1phase (380V-400V-415V 50Hz 3phase)	23	16	11.4	9.0	3.26	10.7	7.4	3.48	10.1	7.1	3.71	9.1	6.7	3.71	7.0	5.7	2.78		
			19	12.2	6.7	3.40	11.4	5.2	3.63	10.7	4.9	3.87	9.8	4.5	3.87	7.5	3.7	2.90		
			22	13.4	4.7	3.52	12.5	3.1	3.76	11.8	2.9	4.00	10.7	2.5	4.00	8.2	1.7	3.00		
		25	16	11.8	10.4	3.31	11.1	10.1	3.54	10.4	9.8	3.77	9.5	9.4	3.77	7.3	7.3	2.83		
			19	12.6	8.2	3.46	11.8	7.9	3.70	11.1	7.6	3.93	10.1	7.2	3.93	7.8	6.3	2.95		
			22	13.9	6.2	3.58	13.0	5.8	3.82	12.2	5.5	4.07	11.1	5.2	4.07	8.5	4.3	3.05		
		27	16	12.2	11.9	3.37	11.4	11.5	3.60	10.8	10.8	3.83	9.8	9.8	3.83	7.5	7.6	2.88		
			19	13.1	9.7	3.51	12.2	9.3	3.76	11.5	9.0	4.00	10.5	8.6	4.00	8.1	7.7	3.00		
			22	14.3	7.6	3.64	13.4	7.3	3.89	12.6	6.9	4.14	11.5	6.6	4.14	8.8	5.7	3.10		
		29	16	12.4	12.5	3.38	11.6	11.7	3.61	10.9	11.0	3.84	9.9	10.0	3.84	7.6	7.7	2.88		
			19	13.3	11.0	3.52	12.4	10.7	3.77	11.7	10.4	4.01	10.6	9.9	4.01	8.2	8.2	3.01		
			22	14.5	8.9	3.64	13.6	8.6	3.90	12.8	8.3	4.15	11.6	7.9	4.15	9.0	6.9	3.11		
		32	16	12.6	12.7	3.39	11.8	11.8	3.62	11.1	11.1	3.85	10.1	10.1	3.85	7.8	7.8	2.89		
			19	13.5	13.0	3.53	12.6	12.6	3.78	11.8	11.9	4.02	10.8	10.8	4.02	8.3	8.3	3.01		
			22	14.7	10.9	3.65	13.8	10.6	3.91	13.0	10.3	4.16	11.8	9.8	4.16	9.1	8.9	3.12		
		S-100PU2E5B U-100PZ2E5 (U-100PZ2E8)	220V-230V-240V 50Hz 1phase (380V-400V-415V 50Hz 3phase)	23	16	11.4	9.3	3.26	10.7	7.6	3.48	10.1	7.3	3.71	9.1	6.9	3.71	7.0	6.0	2.78
					19	12.2	6.9	3.40	11.4	5.2	3.63	10.7	5.0	3.87	9.8	4.6	3.87	7.5	3.8	2.90
					22	13.4	4.7	3.52	12.5	3.0	3.76	11.8	2.8	4.00	10.7	2.4	4.00	8.2	1.6	3.00
25	16			11.8	10.9	3.31	11.1	10.5	3.54	10.4	10.2	3.77	9.5	9.5	3.77	7.3	7.3	2.83		
	19			12.6	8.5	3.46	11.8	8.2	3.70	11.1	7.9	3.93	10.1	7.5	3.93	7.8	6.6	2.95		
	22			13.9	6.3	3.58	13.0	5.9	3.82	12.2	5.7	4.07	11.1	5.3	4.07	8.5	4.4	3.05		
27	16			12.2	12.3	3.37	11.4	11.5	3.60	10.8	10.8	3.83	9.8	9.8	3.83	7.5	7.6	2.88		
	19			13.1	10.1	3.51	12.2	9.7	3.76	11.5	9.4	4.00	10.5	9.0	4.00	8.1	8.1	3.00		
	22			14.3	7.8	3.64	13.4	7.5	3.89	12.6	7.2	4.14	11.5	6.8	4.14	8.8	5.9	3.10		
29	16			12.4	12.5	3.38	11.6	11.7	3.61	10.9	11.0	3.84	9.9	10.0	3.84	7.6	7.7	2.88		
	19			13.3	11.6	3.52	12.4	11.2	3.77	11.7	10.9	4.01	10.6	10.5	4.01	8.2	8.2	3.01		
	22			14.5	9.3	3.64	13.6	8.9	3.90	12.8	8.6	4.15	11.6	8.2	4.15	9.0	7.3	3.11		
32	16			12.6	12.7	3.39	11.8	11.8	3.62	11.1	11.1	3.85	10.1	10.1	3.85	7.8	7.8	2.89		
	19			13.5	13.5	3.53	12.6	12.7	3.78	11.8	11.9	4.02	10.8	10.8	4.02	8.3	8.3	3.01		
	22			14.7	11.4	3.65	13.8	11.0	3.91	13.0	10.8	4.16	11.8	10.3	4.16	9.1	9.1	3.12		
S-50PT2E5B x2 U-100PZ2E5 (U-100PZ2E8)	220V-230V-240V 50Hz 1phase (380V-400V-415V 50Hz 3phase)			23	16	11.4	8.5	3.34	10.7	7.1	3.57	10.1	6.7	3.80	9.1	6.4	3.80	7.0	5.5	2.85
					19	12.2	6.5	3.48	11.4	5.1	3.73	10.7	4.9	3.97	9.8	4.5	3.97	7.5	3.6	2.97
					22	13.4	4.7	3.60	12.5	3.3	3.85	11.8	3.1	4.10	10.7	2.7	4.10	8.2	1.9	3.08
		25	16	11.8	9.9	3.40	11.1	9.5	3.63	10.4	9.2	3.87	9.5	8.8	3.87	7.3	7.3	2.90		
			19	12.6	7.9	3.54	11.8	7.5	3.79	11.1	7.4	4.03	10.1	6.8	4.03	7.8	5.9	3.02		
			22	13.9	6.0	3.67	13.0	5.7	3.92	12.2	5.5	4.17	11.1	5.1	4.17	8.5	4.2	3.13		
		27	16	12.2	11.2	3.45	11.4	10.8	3.69	10.8	10.5	3.93	9.8	9.8	3.93	7.5	7.6	2.95		
			19	13.1	9.2	3.60	12.2	8.9	3.85	11.5	8.5	4.10	10.5	8.1	4.10	8.1	7.2	3.08		
			22	14.3	7.3	3.73	13.4	7.1	3.98	12.6	6.7	4.24	11.5	6.2	4.24	8.8	5.3	3.18		
		29	16	12.4	12.4	3.46	11.6	11.7	3.70	10.9	11.0	3.94	9.9	10.0	3.94	7.6	7.6	2.96		
			19	13.3	10.5	3.61	12.4	10.1	3.86	11.7	9.7	4.11	10.6	9.3	4.11	8.2	8.2	3.08		
			22	14.5	8.5	3.74	13.6	8.3	3.99	12.8	7.9	4.25	11.6	7.5	4.25	9.0	6.4	3.19		
		32	16	12.6	12.7	3.47	11.8	11.8	3.71	11.1	11.1	3.95	10.1	10.1	3.95	7.8	7.8	2.96		
			19	13.5	12.2	3.62	12.6	11.8	3.87	11.8	11.4	4.12	10.8	10.8	4.12	8.3	8.3	3.09		
			22	14.7	10.3	3.74	13.8	9.9	4.00	13.0	9.6	4.26	11.8	9.2	4.26	9.1	8.2	3.20		
		S-100PT2E5B U-100PZ2E5 (U-100PZ2E8)	220V-230V-240V 50Hz 1phase (380V-400V-415V 50Hz 3phase)	23	16	11.4	8.6	3.34	10.7	7.1	3.57	10.1	6.8	3.80	9.1	6.4	3.80	7.0	5.5	2.85
					19	12.2	6.6	3.48	11.4	5.2	3.73	10.7	4.9	3.97	9.8	4.5	3.97	7.5	3.6	2.97
					22	13.4	4.8	3.60	12.5	3.4	3.85	11.8	3.1	4.10	10.7	2.7	4.10	8.2	1.9	3.08
25	16			11.8	10.1	3.40	11.1	9.5	3.63	10.4	9.3	3.87	9.5	8.8	3.87	7.3	7.3	2.90		
	19			12.6	7.9	3.54	11.8	7.6	3.79	11.1	7.4	4.03	10.1	6.8	4.03	7.8	5.9	3.02		
	22			13.9	6.1	3.67	13.0	5.8	3.92	12.2	5.5	4.17	11.1	5.1	4.17	8.5	4.2	3.13		
27	16			12.2	11.3	3.45	11.4	10.9	3.69	10.8	10.6	3.93	9.8	9.8	3.93	7.5	7.6	2.95		
	19			13.1	9.3	3.60	12.2	8.9	3.85	11.5	8.6	4.10	10.5	8.1	4.10	8.1	7.2	3.08		
	22			14.3	7.4	3.73	13.4	7.1	3.98	12.6	6.8	4.24	11.5	6.3	4.24	8.8	5.4	3.18		
29	16			12.4	12.5	3.46	11.6	11.7	3.70	10.9	11.0	3.94	9.9	10.0	3.94	7.6	7.7	2.96		
	19			13.3	10.6	3.61	12.4	10.1	3.86	11.7	9.8	4.11	10.6	9.3	4.11	8.2	8.2	3.08		
	22			14.5	8.5	3.74	13.6	8.3	3.99	12.8	7.9	4.25	11.6	7.5	4.25	9.0	6.4	3.19		
32	16			12.6	12.7	3.47	11.8	11.8	3.71	11.1	11.1	3.95	10.1	10.1	3.95	7.8	7.8	2.96		
	19			13.5	12.3	3.62	12.6	11.9	3.87	11.8	11.7	4.12	10.8	10.8	4.12	8.3	8.3	3.09		
	22			14.7	10.4	3.74	13.8	10.0	4.00	13.0	9.6	4.26	11.8	9.2	4.26	9.1	8.2	3.20		

## 1-12. Capacity Table

1. Cooling Capacity Performance Data  
U-100PZ2E5 (U-100PZ2E8)

TC :Cooling Capacity  
SHC :Sensible Heat Capacity  
IPT :Cooling Power Consumption  
unit : kW

Model	Power Source	Ambient Return Air		Outdoor air intake temp(°C D.B.)														
				25°C			30°C			35°C			40°C			43°C		
		DB	WB	TC	SHC	IPT	TC	SHC	IPT	TC	SHC	IPT	TC	SHC	IPT	TC	SHC	IPT
S-50PK2E5B x2 U-100PZ2E5 (U-100PZ2E8)	220V-230V-240V 50Hz 1phase (380V-400V-415V 50Hz 3phase)	23	16	10.9	8.3	3.26	10.2	6.8	3.48	9.6	6.5	3.71	8.7	6.1	3.71	6.7	5.1	2.78
			19	11.7	6.3	3.40	10.9	4.8	3.63	10.3	4.5	3.87	9.3	4.1	3.87	7.2	3.3	2.90
			22	12.8	4.3	3.52	12.0	2.9	3.76	11.3	2.6	4.00	10.2	2.2	4.00	7.9	1.5	3.00
		25	16	11.3	9.7	3.31	10.6	9.4	3.54	10.0	9.1	3.77	9.1	8.6	3.77	7.0	7.0	2.83
			19	12.1	7.6	3.46	11.3	7.3	3.70	10.6	7.0	3.93	9.7	6.5	3.93	7.4	5.6	2.95
			22	13.2	5.7	3.58	12.4	5.4	3.82	11.7	5.1	4.07	10.6	4.7	4.07	8.2	3.9	3.05
		27	16	11.7	11.1	3.37	10.9	10.7	3.60	10.3	10.3	3.83	9.4	9.4	3.83	7.2	7.2	2.88
			19	12.5	9.0	3.51	11.7	8.6	3.76	11.0	8.3	4.00	10.0	7.9	4.00	7.7	7.0	3.00
			22	13.7	7.0	3.64	12.8	6.7	3.89	12.1	6.4	4.14	11.0	6.0	4.14	8.4	5.0	3.10
		29	16	11.9	11.9	3.38	11.1	11.2	3.61	10.5	10.5	3.84	9.5	9.5	3.84	7.3	7.3	2.88
			19	12.7	10.3	3.52	11.9	9.9	3.77	11.2	9.6	4.01	10.1	9.2	4.01	7.8	7.8	3.01
			22	13.9	8.3	3.64	13.0	7.9	3.90	12.2	7.7	4.15	11.1	7.2	4.15	8.6	6.3	3.11
32	16	12.1	12.1	3.39	11.3	11.3	3.62	10.6	10.7	3.85	9.6	9.7	3.85	7.4	7.5	2.89		
	19	12.9	12.1	3.53	12.0	11.8	3.78	11.3	11.4	4.02	10.3	10.3	4.02	7.9	7.9	3.01		
	22	14.1	10.1	3.65	13.2	9.8	3.91	12.4	9.5	4.16	11.3	9.1	4.16	8.7	8.1	3.12		
S-100PK2E5B U-100PZ2E5 (U-100PZ2E8)	220V-230V-240V 50Hz 1phase (380V-400V-415V 50Hz 3phase)	23	16	9.6	6.8	2.53	9.0	5.6	2.70	8.5	5.3	2.87	7.7	4.9	2.87	5.9	4.2	2.16
			19	10.3	5.2	2.63	9.6	4.1	2.82	9.1	3.9	3.00	8.2	3.5	3.00	6.3	2.8	2.25
			22	11.3	3.9	2.73	10.6	2.8	2.91	9.9	2.5	3.10	9.0	2.2	3.10	7.0	1.8	2.33
		25	16	10.0	7.8	2.57	9.3	7.4	2.75	8.8	7.2	2.92	8.0	6.7	2.92	6.1	5.8	2.19
			19	10.7	6.3	2.68	10.0	5.9	2.86	9.4	5.7	3.05	8.5	5.3	3.05	6.6	4.4	2.29
			22	11.7	4.9	2.77	10.9	4.6	2.96	10.3	4.3	3.15	9.3	3.9	3.15	7.2	3.1	2.37
		27	16	10.3	8.8	2.61	9.7	8.4	2.79	9.1	8.1	2.97	8.3	7.7	2.97	6.4	6.4	2.23
			19	11.0	7.2	2.72	10.3	6.9	2.91	9.7	6.6	3.10	8.8	6.2	3.10	6.8	5.4	2.33
			22	12.1	5.8	2.82	11.3	5.5	3.01	10.6	5.3	3.21	9.7	4.8	3.21	7.4	4.1	2.41
		29	16	10.5	9.6	2.62	9.8	9.4	2.80	9.2	9.1	2.98	8.4	8.4	2.98	6.5	6.5	2.23
			19	11.2	8.2	2.73	10.5	7.8	2.92	9.8	7.5	3.11	8.9	7.1	3.11	6.9	6.3	2.33
			22	12.3	7.1	2.82	11.5	6.4	3.02	10.8	6.1	3.22	9.8	5.8	3.22	7.6	5.0	2.41
32	16	10.6	10.7	2.62	9.9	10.0	2.81	9.4	9.4	2.99	8.5	8.5	2.99	6.5	6.6	2.24		
	19	11.4	9.5	2.74	10.6	9.1	2.93	10.0	8.8	3.12	9.1	8.4	3.12	7.0	7.0	2.34		
	22	12.4	8.1	2.83	11.6	7.7	3.03	10.9	7.4	3.22	10.0	7.1	3.22	7.7	6.1	2.42		
S-50PF1E5B x2 U-100PZ2E5 (U-100PZ2E8)	220V-230V-240V 50Hz 1phase (380V-400V-415V 50Hz 3phase)	23	16	11.4	8.9	3.33	10.7	7.4	3.56	10.1	7.0	3.79	9.1	6.6	3.79	7.0	5.7	2.84
			19	12.2	6.7	3.48	11.4	5.2	3.72	10.7	4.9	3.96	9.8	4.5	3.96	7.5	3.7	2.97
			22	13.4	4.8	3.60	12.5	3.2	3.84	11.8	2.9	4.09	10.7	2.6	4.09	8.2	1.7	3.07
		25	16	11.8	10.3	3.39	11.1	10.0	3.62	10.4	9.7	3.86	9.5	9.2	3.86	7.3	7.3	2.89
			19	12.6	8.1	3.53	11.8	7.8	3.78	11.1	7.6	4.02	10.1	7.1	4.02	7.8	6.2	3.02
			22	13.9	6.2	3.66	13.0	5.8	3.91	12.2	5.5	4.16	11.1	5.1	4.16	8.5	4.3	3.12
		27	16	12.2	11.7	3.44	11.4	11.4	3.68	10.8	10.8	3.92	9.8	9.8	3.92	7.5	7.6	2.94
			19	13.1	9.6	3.59	12.2	9.2	3.84	11.5	8.9	4.09	10.5	8.5	4.09	8.1	7.5	3.07
			22	14.3	7.6	3.72	13.4	7.2	3.97	12.6	6.9	4.23	11.5	6.5	4.23	8.8	5.5	3.17
		29	16	12.4	12.5	3.45	11.6	11.7	3.69	10.9	11.0	3.93	9.9	10.0	3.93	7.6	7.7	2.95
			19	13.3	10.9	3.60	12.4	10.5	3.85	11.7	10.2	4.10	10.6	9.8	4.10	8.2	8.2	3.08
			22	14.5	8.9	3.73	13.6	8.5	3.98	12.8	8.2	4.24	11.6	7.8	4.24	9.0	6.8	3.18
32	16	12.6	12.7	3.46	11.8	11.8	3.70	11.1	11.1	3.94	10.1	10.1	3.94	7.8	7.8	2.96		
	19	13.5	12.9	3.61	12.6	12.5	3.86	11.8	11.9	4.11	10.8	10.8	4.11	8.3	8.3	3.08		
	22	14.7	10.8	3.74	13.8	10.4	3.99	13.0	10.1	4.25	11.8	9.7	4.25	9.1	8.7	3.19		
S-100PF1E5B U-100PZ2E5 (U-100PZ2E8)	220V-230V-240V 50Hz 1phase (380V-400V-415V 50Hz 3phase)	23	16	11.4	8.9	3.33	10.7	7.3	3.56	10.1	7.0	3.79	9.1	6.6	3.79	7.0	5.8	2.84
			19	12.2	6.7	3.48	11.4	5.1	3.72	10.7	4.8	3.96	9.8	4.5	3.96	7.5	3.6	2.97
			22	13.4	4.7	3.60	12.5	3.1	3.84	11.8	2.8	4.09	10.7	2.5	4.09	8.2	1.6	3.07
		25	16	11.8	10.4	3.39	11.1	10.0	3.62	10.4	9.8	3.86	9.5	9.3	3.86	7.3	7.3	2.89
			19	12.6	8.2	3.53	11.8	7.8	3.78	11.1	7.5	4.02	10.1	7.2	4.02	7.8	6.2	3.02
			22	13.9	6.1	3.66	13.0	5.8	3.91	12.2	5.5	4.16	11.1	5.1	4.16	8.5	4.2	3.12
		27	16	12.2	11.9	3.44	11.4	11.4	3.68	10.8	10.8	3.92	9.8	9.8	3.92	7.5	7.5	2.94
			19	13.1	9.6	3.59	12.2	9.3	3.84	11.5	9.0	4.09	10.5	8.5	4.09	8.1	7.7	3.07
			22	14.3	7.6	3.72	13.4	7.2	3.97	12.6	6.9	4.23	11.5	6.5	4.23	8.8	5.6	3.17
		29	16	12.4	12.4	3.45	11.6	11.6	3.69	10.9	10.9	3.93	9.9	9.9	3.93	7.6	7.6	2.95
			19	13.3	11.0	3.60	12.4	10.6	3.85	11.7	10.3	4.10	10.6	9.9	4.10	8.2	8.2	3.08
			22	14.5	8.9	3.73	13.6	8.6	3.98	12.8	8.2	4.24	11.6	7.8	4.24	9.0	7.0	3.18
32	16	12.6	12.6	3.46	11.8	11.8	3.70	11.1	11.1	3.94	10.1	10.1	3.94	7.8	7.8	2.96		
	19	13.5	13.0	3.61	12.6	12.6	3.86	11.8	11.8	4.11	10.8	10.8	4.11	8.3	8.3	3.08		
	22	14.7	10.9	3.74	13.8	10.5	3.99	13.0	10.2	4.25	11.8	9.7	4.25	9.1	8.8	3.19		

1-12. Capacity Table

1. Cooling Capacity Performance Data  
U-125PZ2E5 (U-125PZ2E8)

TC :Cooling Capacity  
SHC :Sensible Heat Capacity  
IPT :Cooling Power Consumption  
unit : kW

Model	Power Source	Ambient Return Air		Outdoor air intake temp(°C D.B.)																
				25°C			30°C			35°C			40°C			43°C				
		DB	WB	TC	SHC	IPT	TC	SHC	IPT	TC	SHC	IPT	TC	SHC	IPT	TC	SHC	IPT		
S-60PU2E5B x2 U-125PZ2E5 (U-125PZ2E8)	220V-230V-240V 50Hz 1phase (380V-400V-415V 50Hz 3phase)	23	16	13.4	10.9	3.91	12.6	8.9	4.18	11.8	8.6	4.45	10.7	8.1	4.45	8.3	7.0	3.34		
			19	14.3	8.1	4.08	13.4	6.2	4.36	12.6	5.8	4.64	11.5	5.4	4.64	8.8	4.4	3.48		
			22	15.7	5.5	4.22	14.7	3.6	4.51	13.8	3.3	4.80	12.6	2.8	4.80	9.7	1.9	3.60		
		25	16	13.9	12.8	3.98	13.0	12.3	4.25	12.2	12.0	4.53	11.1	11.2	4.53	8.6	8.6	3.39		
			19	14.8	10.0	4.15	13.9	9.6	4.43	13.1	9.2	4.72	11.9	8.8	4.72	9.1	7.6	3.54		
			22	16.3	7.3	4.29	15.2	7.0	4.59	14.3	6.6	4.88	13.0	6.2	4.88	10.0	5.2	3.66		
		27	16	14.4	14.4	4.04	13.4	13.5	4.32	12.6	12.7	4.60	11.5	11.5	4.60	8.8	8.9	3.45		
			19	15.3	11.8	4.22	14.4	11.4	4.51	13.5	11.0	4.80	12.3	10.5	4.80	9.5	9.5	3.60		
			22	16.8	9.2	4.36	15.7	8.8	4.66	14.8	8.4	4.97	13.4	7.9	4.97	10.4	6.9	3.72		
		29	16	14.6	14.6	4.05	13.6	13.7	4.33	12.8	12.9	4.61	11.7	11.7	4.61	9.0	9.0	3.46		
			19	15.6	13.5	4.23	14.6	13.1	4.52	13.7	12.8	4.81	12.5	12.3	4.81	9.6	9.6	3.61		
			22	17.1	10.9	4.37	16.0	10.4	4.68	15.0	10.1	4.98	13.6	9.6	4.98	10.5	8.5	3.73		
		32	16	14.8	14.9	4.06	13.8	13.9	4.34	13.0	13.1	4.62	11.8	11.9	4.62	9.1	9.1	3.47		
			19	15.8	15.9	4.24	14.8	14.8	4.53	13.9	14.0	4.82	12.6	12.7	4.82	9.7	9.8	3.62		
			22	17.3	13.4	4.38	16.2	12.9	4.69	15.2	12.6	4.99	13.8	12.1	4.99	10.7	10.7	3.74		
		S-125PU2E5B U-125PZ2E5 (U-125PZ2E8)	220V-230V-240V 50Hz 1phase (380V-400V-415V 50Hz 3phase)	23	16	13.4	10.2	3.91	12.6	8.4	4.18	11.8	8.2	4.45	10.7	7.7	4.45	8.3	6.6	3.34
					19	14.3	7.7	4.08	13.4	5.9	4.36	12.6	5.6	4.64	11.5	5.3	4.64	8.8	4.3	3.48
					22	15.7	5.5	4.22	14.7	3.8	4.51	13.8	3.5	4.80	12.6	2.9	4.80	9.7	2.0	3.60
				25	16	13.9	12.0	3.98	13.0	11.5	4.25	12.2	11.2	4.53	11.1	10.6	4.53	8.6	8.6	3.39
					19	14.8	9.4	4.15	13.9	9.1	4.43	13.1	8.6	4.72	11.9	8.2	4.72	9.1	7.1	3.54
					22	16.3	7.2	4.29	15.2	6.8	4.59	14.3	6.5	4.88	13.0	6.0	4.88	10.0	5.0	3.66
				27	16	14.4	13.6	4.04	13.4	13.3	4.32	12.6	12.7	4.60	11.5	11.5	4.60	8.8	8.9	3.45
					19	15.3	11.2	4.22	14.4	10.6	4.51	13.5	10.4	4.80	12.3	9.8	4.80	9.5	8.8	3.60
					22	16.8	8.8	4.36	15.7	8.4	4.66	14.8	8.1	4.97	13.4	7.6	4.97	10.4	6.5	3.72
29	16			14.6	14.7	4.05	13.6	13.7	4.33	12.8	12.9	4.61	11.7	11.7	4.61	9.0	9.0	3.46		
	19			15.6	12.7	4.23	14.6	12.1	4.52	13.7	11.9	4.81	12.5	11.4	4.81	9.6	9.6	3.61		
	22			17.1	10.2	4.37	16.0	9.9	4.68	15.0	9.6	4.98	13.6	8.9	4.98	10.5	8.0	3.73		
32	16			14.8	14.9	4.06	13.8	13.9	4.34	13.0	13.1	4.62	11.8	11.9	4.62	9.1	9.2	3.47		
	19			15.8	14.9	4.24	14.8	14.5	4.53	13.9	13.9	4.82	12.6	12.7	4.82	9.7	9.8	3.62		
	22			17.3	12.5	4.38	16.2	12.2	4.69	15.2	11.8	4.99	13.8	11.2	4.99	10.7	10.1	3.74		
S-60PT2E5B x2 U-125PZ2E5 (U-125PZ2E8)	220V-230V-240V 50Hz 1phase (380V-400V-415V 50Hz 3phase)			23	16	13.4	10.5	3.98	12.6	8.6	4.25	11.8	8.3	4.53	10.7	7.8	4.53	8.3	6.7	3.39
					19	14.3	7.9	4.15	13.4	6.1	4.43	12.6	5.8	4.72	11.5	5.3	4.72	8.8	4.3	3.54
					22	15.7	5.6	4.29	14.7	3.7	4.59	13.8	3.4	4.88	12.6	2.8	4.88	9.7	2.0	3.66
				25	16	13.9	12.2	4.04	13.0	11.8	4.32	12.2	11.4	4.60	11.1	10.9	4.60	8.6	8.6	3.45
					19	14.8	9.6	4.22	13.9	9.2	4.51	13.1	8.9	4.80	11.9	8.4	4.80	9.1	7.2	3.60
					22	16.3	7.2	4.36	15.2	6.8	4.66	14.3	6.5	4.97	13.0	6.1	4.97	10.0	5.0	3.72
				27	16	14.4	13.9	4.11	13.4	13.5	4.39	12.6	12.7	4.68	11.5	11.5	4.68	8.8	8.9	3.51
					19	15.3	11.3	4.29	14.4	10.9	4.58	13.5	10.5	4.88	12.3	10.1	4.88	9.5	9.0	3.66
					22	16.8	8.9	4.44	15.7	8.5	4.74	14.8	8.1	5.05	13.4	7.6	5.05	10.4	6.6	3.79
		29	16	14.6	14.6	4.12	13.6	13.7	4.40	12.8	12.9	4.69	11.7	11.7	4.69	9.0	9.0	3.52		
			19	15.6	12.9	4.30	14.6	12.5	4.59	13.7	12.1	4.89	12.5	11.6	4.89	9.6	9.6	3.67		
			22	17.1	10.5	4.45	16.0	10.1	4.75	15.0	9.7	5.06	13.6	9.2	5.06	10.5	8.1	3.80		
		32	16	14.8	14.9	4.13	13.8	13.9	4.42	13.0	13.1	4.70	11.8	11.9	4.70	9.1	9.2	3.53		
			19	15.8	15.2	4.31	14.8	14.8	4.61	13.9	14.0	4.90	12.6	12.7	4.90	9.7	9.8	3.68		
			22	17.3	12.8	4.46	16.2	12.3	4.77	15.2	12.0	5.07	13.8	11.4	5.07	10.7	10.3	3.81		
		S-125PT2E5B U-125PZ2E5 (U-125PZ2E8)	220V-230V-240V 50Hz 1phase (380V-400V-415V 50Hz 3phase)	23	16	13.4	9.9	3.98	12.6	8.2	4.25	11.8	7.8	4.53	10.7	7.3	4.53	8.3	6.2	3.39
					19	14.3	7.7	4.15	13.4	6.0	4.43	12.6	5.7	4.72	11.5	5.2	4.72	8.8	4.2	3.54
					22	15.7	5.6	4.29	14.7	4.0	4.59	13.8	3.7	4.88	12.6	3.2	4.88	9.7	2.2	3.66
				25	16	13.9	11.4	4.04	13.0	10.9	4.32	12.2	10.6	4.60	11.1	10.0	4.60	8.6	8.6	3.45
					19	14.8	9.2	4.22	13.9	8.7	4.51	13.1	8.4	4.80	11.9	7.9	4.80	9.1	6.7	3.60
					22	16.3	7.1	4.36	15.2	6.6	4.66	14.3	6.3	4.97	13.0	5.9	4.97	10.0	4.8	3.72
				27	16	14.4	13.0	4.11	13.4	12.4	4.39	12.6	12.0	4.68	11.5	11.5	4.68	8.8	8.9	3.51
					19	15.3	10.5	4.29	14.4	10.2	4.58	13.5	9.8	4.88	12.3	9.3	4.88	9.5	8.2	3.66
					22	16.8	8.5	4.44	15.7	8.1	4.74	14.8	7.8	5.05	13.4	7.3	5.05	10.4	6.1	3.79
29	16			14.6	14.3	4.12	13.6	13.7	4.40	12.8	12.9	4.69	11.7	11.7	4.69	9.0	9.0	3.52		
	19			15.6	12.0	4.30	14.6	11.5	4.59	13.7	11.2	4.89	12.5	10.6	4.89	9.6	9.5	3.67		
	22			17.1	9.9	4.45	16.0	9.5	4.75	15.0	9.1	5.06	13.6	8.6	5.06	10.5	7.4	3.80		
32	16			14.8	14.9	4.13	13.8	13.9	4.42	13.0	13.1	4.70	11.8	11.9	4.70	9.1	9.2	3.53		
	19			15.8	14.0	4.31	14.8	13.6	4.61	13.9	13.1	4.90	12.6	12.6	4.90	9.7	9.8	3.68		
	22			17.3	11.9	4.46	16.2	11.4	4.77	15.2	11.1	5.07	13.8	10.5	5.07	10.7	9.3	3.81		

**1-12. Capacity Table**  
**1. Cooling Capacity Performance Data**  
**U-125PZ2E5 (U-125PZ2E8)**

TC :Cooling Capacity  
 SHC :Sensible Heat Capacity  
 IPT :Cooling Power Consumption  
 unit : kW

Model	Power Source	Ambient Return Air		Outdoor air intake temp(°C D.B.)																
				25°C			30°C			35°C			40°C			43°C				
		DB	WB	TC	SHC	IPT	TC	SHC	IPT	TC	SHC	IPT	TC	SHC	IPT	TC	SHC	IPT		
S-60PK2E5B x2 U-125PZ2E5 (U-125PZ2E8)	220V-230V-240V 50Hz 1phase (380V-400V-415V 50Hz 3phase)	23	16	13.1	10.1	3.91	12.3	8.3	4.18	11.5	7.9	4.45	10.5	7.5	4.45	8.1	6.4	3.34		
			19	14.0	7.4	4.08	13.1	5.7	4.36	12.3	5.4	4.64	11.2	5.0	4.64	8.6	4.0	3.48		
			22	15.4	5.2	4.22	14.4	3.4	4.51	13.5	3.0	4.80	12.3	2.6	4.80	9.5	1.7	3.60		
		25	16	13.6	11.9	3.98	12.7	11.5	4.25	12.0	11.1	4.53	10.9	10.6	4.53	8.4	8.4	3.39		
			19	14.5	9.2	4.15	13.6	8.9	4.43	12.8	8.6	4.72	11.6	8.1	4.72	8.9	7.0	3.54		
			22	15.9	6.9	4.29	14.9	6.5	4.59	14.0	6.2	4.88	12.7	5.7	4.88	9.8	4.7	3.66		
		27	16	14.0	13.6	4.04	13.1	13.1	4.32	12.4	12.4	4.60	11.2	11.3	4.60	8.7	8.7	3.45		
			19	15.0	10.9	4.22	14.0	10.5	4.51	13.2	10.2	4.80	12.0	9.7	4.80	9.2	8.6	3.60		
			22	16.4	8.5	4.36	15.4	8.1	4.66	14.5	7.8	4.97	13.1	7.3	4.97	10.1	6.3	3.72		
		29	16	14.3	14.3	4.05	13.3	13.4	4.33	12.5	12.6	4.61	11.4	11.4	4.61	8.8	8.8	3.46		
			19	15.2	12.5	4.23	14.2	12.0	4.52	13.4	11.7	4.81	12.2	11.2	4.81	9.4	9.4	3.61		
			22	16.7	9.9	4.37	15.6	9.7	4.68	14.7	9.3	4.98	13.3	8.9	4.98	10.3	7.7	3.73		
		32	16	14.5	14.5	4.06	13.5	13.6	4.34	12.7	12.8	4.62	11.6	11.6	4.62	8.9	8.9	3.47		
			19	15.4	14.9	4.24	14.4	14.4	4.53	13.6	13.6	4.82	12.4	12.4	4.82	9.5	9.6	3.62		
			22	16.9	12.4	4.38	15.8	12.0	4.69	14.9	11.6	4.99	13.5	11.1	4.99	10.4	10.0	3.74		
		S-60PF1E5B x2 U-125PZ2E5 (U-125PZ2E8)	220V-230V-240V 50Hz 1phase (380V-400V-415V 50Hz 3phase)	23	16	13.4	10.9	3.93	12.6	8.9	4.20	11.8	8.6	4.47	10.7	8.1	4.47	8.3	7.0	3.35
					19	14.3	8.1	4.10	13.4	6.2	4.38	12.6	5.8	4.66	11.5	5.4	4.66	8.8	4.4	3.50
					22	15.7	5.5	4.24	14.7	3.6	4.53	13.8	3.3	4.82	12.6	2.8	4.82	9.7	1.9	3.62
25	16			13.9	12.8	3.99	13.0	12.3	4.27	12.2	12.0	4.55	11.1	11.2	4.55	8.6	8.6	3.41		
	19			14.8	9.9	4.17	13.9	9.6	4.45	13.1	9.2	4.74	11.9	8.8	4.74	9.1	7.6	3.56		
	22			16.3	7.3	4.31	15.2	7.0	4.61	14.3	6.6	4.91	13.0	6.2	4.91	10.0	5.2	3.68		
27	16			14.4	14.4	4.06	13.4	13.5	4.34	12.6	12.7	4.62	11.5	11.5	4.62	8.8	8.9	3.47		
	19			15.3	11.8	4.23	14.4	11.4	4.53	13.5	11.0	4.82	12.3	10.5	4.82	9.5	9.5	3.62		
	22			16.8	9.2	4.38	15.7	8.8	4.68	14.8	8.4	4.99	13.4	7.9	4.99	10.4	6.9	3.74		
29	16			14.6	14.6	4.07	13.6	13.7	4.35	12.8	12.9	4.63	11.7	11.7	4.63	9.0	9.0	3.47		
	19			15.6	13.5	4.24	14.6	13.1	4.54	13.7	12.8	4.83	12.5	12.3	4.83	9.6	9.6	3.62		
	22			17.1	10.9	4.39	16.0	10.4	4.70	15.0	10.1	5.00	13.6	9.6	5.00	10.5	8.5	3.75		
32	16			14.8	14.9	4.08	13.8	13.9	4.36	13.0	13.1	4.64	11.8	11.9	4.64	9.1	9.1	3.48		
	19			15.8	15.9	4.26	14.8	14.8	4.55	13.9	14.0	4.84	12.6	12.7	4.84	9.7	9.8	3.63		
	22			17.3	13.4	4.40	16.2	12.9	4.71	15.2	12.6	5.01	13.8	12.1	5.01	10.7	10.7	3.76		
S-125PF1E5B x2 U-125PZ2E5 (U-125PZ2E8)	220V-230V-240V 50Hz 1phase (380V-400V-415V 50Hz 3phase)			23	16	13.4	10.1	3.93	12.6	8.3	4.20	11.8	8.0	4.47	10.7	7.4	4.47	8.3	6.3	3.35
					19	14.3	7.7	4.10	13.4	6.0	4.38	12.6	5.7	4.66	11.5	5.2	4.66	8.8	4.2	3.50
					22	15.7	5.6	4.24	14.7	3.8	4.53	13.8	3.5	4.82	12.6	3.0	4.82	9.7	2.0	3.62
		25	16	13.9	11.7	3.99	13.0	11.2	4.27	12.2	10.9	4.55	11.1	10.4	4.55	8.6	8.6	3.41		
			19	14.8	9.3	4.17	13.9	8.9	4.45	13.1	8.5	4.74	11.9	8.0	4.74	9.1	7.0	3.56		
			22	16.3	7.1	4.31	15.2	6.7	4.61	14.3	6.4	4.91	13.0	5.9	4.91	10.0	4.8	3.68		
		27	16	14.4	13.3	4.06	13.4	12.8	4.34	12.6	12.5	4.62	11.5	11.5	4.62	8.8	8.8	3.47		
			19	15.3	10.9	4.23	14.4	10.4	4.53	13.5	10.1	4.82	12.3	9.6	4.82	9.5	8.6	3.62		
			22	16.8	8.7	4.38	15.7	8.2	4.68	14.8	7.9	4.99	13.4	7.3	4.99	10.4	6.3	3.74		
		29	16	14.6	14.6	4.07	13.6	13.7	4.35	12.8	12.8	4.63	11.7	11.7	4.63	9.0	9.0	3.47		
			19	15.6	12.3	4.24	14.6	11.9	4.54	13.7	11.5	4.83	12.5	11.0	4.83	9.6	9.6	3.62		
			22	17.1	10.1	4.39	16.0	9.7	4.70	15.0	9.3	5.00	13.6	8.8	5.00	10.5	7.7	3.75		
		32	16	14.8	14.8	4.08	13.8	13.8	4.36	13.0	13.0	4.64	11.8	11.8	4.64	9.1	9.1	3.48		
			19	15.8	14.5	4.26	14.8	14.0	4.55	13.9	13.7	4.84	12.6	12.6	4.84	9.7	9.7	3.63		
			22	17.3	12.2	4.40	16.2	11.8	4.71	15.2	11.4	5.01	13.8	10.9	5.01	10.7	9.7	3.76		



1-12. Capacity Table

1. Cooling Capacity Performance Data  
U-140PZ2E5 (U-140PZ2E8)

TC :Cooling Capacity  
SHC :Sensible Heat Capacity  
IPT :Cooling Power Consumption  
unit : kW

Model	Power Source	Ambient Return Air		Outdoor air intake temp(°C D.B.)																
				25°C			30°C			35°C			40°C			43°C				
		DB	WB	TC	SHC	IPT	TC	SHC	IPT	TC	SHC	IPT	TC	SHC	IPT	TC	SHC	IPT		
S-71PU2E5B x2 U-140PZ2E5 (U-140PZ2E8)	220V-230V-240V 50Hz 1phase (380V-400V-415V 50Hz 3phase)	23	16	14.9	11.8	4.48	13.9	9.7	4.79	13.1	9.3	5.10	11.9	8.8	5.10	9.2	7.6	3.83		
			19	15.9	8.9	4.67	14.9	6.8	5.00	14.0	6.4	5.32	12.7	5.9	5.32	9.8	4.8	3.99		
			22	17.5	6.2	4.84	16.3	4.1	5.17	15.4	3.7	5.50	14.0	3.3	5.50	10.7	2.2	4.13		
		25	16	15.4	13.8	4.56	14.4	13.3	4.87	13.6	12.9	5.19	12.3	12.4	5.19	9.5	9.6	3.89		
			19	16.5	10.8	4.75	15.4	10.4	5.08	14.5	10.0	5.41	13.2	9.5	5.41	10.2	8.3	4.06		
			22	18.1	8.1	4.92	16.9	7.6	5.26	15.9	7.1	5.60	14.4	6.8	5.60	11.1	5.6	4.20		
		27	16	16.0	15.7	4.63	14.9	15.0	4.95	14.0	14.1	5.27	12.8	12.8	5.27	9.8	9.8	3.95		
			19	17.0	12.7	4.83	15.9	12.3	5.17	15.0	11.9	5.50	13.6	11.4	5.50	10.5	10.0	4.13		
			22	18.7	10.0	5.00	17.5	9.5	5.34	16.4	9.2	5.69	14.9	8.6	5.69	11.5	7.3	4.27		
		29	16	16.2	16.3	4.64	15.2	15.2	4.96	14.3	14.3	5.29	13.0	13.0	5.29	10.0	10.0	3.96		
			19	17.3	14.6	4.84	16.2	14.1	5.18	15.2	13.7	5.51	13.8	13.1	5.51	10.7	10.7	4.14		
			22	19.0	11.8	5.01	17.7	11.4	5.36	16.7	10.9	5.70	15.2	10.2	5.70	11.7	9.2	4.28		
		32	16	16.4	16.5	4.65	15.4	15.4	4.98	14.5	14.5	5.30	13.1	13.2	5.30	10.1	10.1	3.97		
			19	17.6	17.2	4.86	16.4	16.5	5.19	15.4	15.5	5.53	14.0	14.1	5.53	10.8	10.8	4.15		
			22	19.2	14.5	5.02	18.0	14.0	5.37	16.9	13.5	5.72	15.4	13.0	5.72	11.8	11.7	4.29		
		S-140PU2E5B U-140PZ2E5 (U-140PZ2E8)	220V-230V-240V 50Hz 1phase (380V-400V-415V 50Hz 3phase)	23	16	14.9	11.0	4.48	13.9	9.2	4.79	13.1	8.8	5.10	11.9	8.3	5.10	9.2	7.1	3.83
					19	15.9	8.6	4.67	14.9	6.7	5.00	14.0	6.3	5.32	12.7	5.8	5.32	9.8	4.7	3.99
					22	17.5	6.2	4.84	16.3	4.4	5.17	15.4	4.0	5.50	14.0	3.5	5.50	10.7	2.2	4.13
				25	16	15.4	12.8	4.56	14.4	12.4	4.87	13.6	11.9	5.19	12.3	11.5	5.19	9.5	9.5	3.89
					19	16.5	10.2	4.75	15.4	9.7	5.08	14.5	9.3	5.41	13.2	8.9	5.41	10.2	7.7	4.06
					22	18.1	7.8	4.92	16.9	7.5	5.26	15.9	7.1	5.60	14.4	6.4	5.60	11.1	5.4	4.20
				27	16	16.0	14.5	4.63	14.9	14.0	4.95	14.0	13.6	5.27	12.8	12.8	5.27	9.8	9.9	3.95
					19	17.0	11.9	4.83	15.9	11.6	5.17	15.0	11.0	5.50	13.6	10.4	5.50	10.5	9.3	4.13
					22	18.7	9.5	5.00	17.5	9.2	5.34	16.4	8.8	5.69	14.9	8.2	5.69	11.5	7.0	4.27
29	16			16.2	16.2	4.64	15.2	15.2	4.96	14.3	14.3	5.29	13.0	13.0	5.29	10.0	10.0	3.96		
	19			17.3	13.7	4.84	16.2	13.0	5.18	15.2	12.6	5.51	13.8	12.1	5.51	10.7	10.7	4.14		
	22			19.0	11.2	5.01	17.7	10.6	5.36	16.7	10.3	5.70	15.2	9.6	5.70	11.7	8.5	4.28		
32	16			16.4	16.5	4.65	15.4	15.4	4.98	14.5	14.5	5.30	13.1	13.2	5.30	10.1	10.2	3.97		
	19			17.6	15.8	4.86	16.4	15.5	5.19	15.4	15.0	5.53	14.0	14.1	5.53	10.8	10.9	4.15		
	22			19.2	13.4	5.02	18.0	13.0	5.37	16.9	12.6	5.72	15.4	11.9	5.72	11.8	10.6	4.29		
S-71PT2E5B x2 U-140PZ2E5 (U-140PZ2E8)	220V-230V-240V 50Hz 1phase (380V-400V-415V 50Hz 3phase)			23	16	14.9	11.4	4.48	13.9	9.4	4.79	13.1	8.9	5.10	11.9	8.5	5.10	9.2	7.2	3.83
					19	15.9	8.7	4.67	14.9	6.7	5.00	14.0	6.4	5.32	12.7	5.8	5.32	9.8	4.7	3.99
					22	17.5	6.2	4.84	16.3	4.3	5.17	15.4	3.9	5.50	14.0	3.3	5.50	10.7	2.3	4.13
				25	16	15.4	13.2	4.56	14.4	12.6	4.87	13.6	12.2	5.19	12.3	11.8	5.19	9.5	9.5	3.89
					19	16.5	10.3	4.75	15.4	10.0	5.08	14.5	9.7	5.41	13.2	9.0	5.41	10.2	7.8	4.06
					22	18.1	7.8	4.92	16.9	7.6	5.26	15.9	7.1	5.60	14.4	6.6	5.60	11.1	5.5	4.20
				27	16	16.0	14.9	4.63	14.9	14.4	4.95	14.0	14.0	5.27	12.8	12.8	5.27	9.8	9.8	3.95
					19	17.0	12.3	4.83	15.9	11.7	5.17	15.0	11.3	5.50	13.6	10.7	5.50	10.5	9.6	4.13
					22	18.7	9.8	5.00	17.5	9.2	5.34	16.4	8.9	5.69	14.9	8.3	5.69	11.5	7.1	4.27
		29	16	16.2	16.2	4.64	15.2	15.2	4.96	14.3	14.3	5.29	13.0	13.0	5.29	10.0	10.0	3.96		
			19	17.3	14.0	4.84	16.2	13.3	5.18	15.2	13.1	5.51	13.8	12.5	5.51	10.7	10.7	4.14		
			22	19.0	11.4	5.01	17.7	10.8	5.36	16.7	10.6	5.70	15.2	9.8	5.70	11.7	8.7	4.28		
		32	16	16.4	16.5	4.65	15.4	15.4	4.98	14.5	14.5	5.30	13.1	13.2	5.30	10.1	10.1	3.97		
			19	17.6	16.5	4.86	16.4	15.9	5.19	15.4	15.4	5.53	14.0	14.1	5.53	10.8	10.8	4.15		
			22	19.2	13.8	5.02	18.0	13.4	5.37	16.9	13.0	5.72	15.4	12.3	5.72	11.8	11.1	4.29		
		S-140PT2E5B U-140PZ2E5 (U-140PZ2E8)	220V-230V-240V 50Hz 1phase (380V-400V-415V 50Hz 3phase)	23	16	14.9	10.6	4.48	13.9	8.9	4.79	13.1	8.4	5.10	11.9	8.0	5.10	9.2	6.7	3.83
					19	15.9	8.4	4.67	14.9	6.6	5.00	14.0	6.3	5.32	12.7	5.7	5.32	9.8	4.5	3.99
					22	17.5	6.3	4.84	16.3	4.5	5.17	15.4	4.2	5.50	14.0	3.7	5.50	10.7	2.5	4.13
				25	16	15.4	12.2	4.56	14.4	11.7	4.87	13.6	11.4	5.19	12.3	10.8	5.19	9.5	9.5	3.89
					19	16.5	10.0	4.75	15.4	9.5	5.08	14.5	9.0	5.41	13.2	8.4	5.41	10.2	7.2	4.06
					22	18.1	7.8	4.92	16.9	7.4	5.26	15.9	6.9	5.60	14.4	6.4	5.60	11.1	5.2	4.20
				27	16	16.0	13.9	4.63	14.9	13.4	4.95	14.0	12.8	5.27	12.8	12.3	5.27	9.8	9.9	3.95
					19	17.0	11.4	4.83	15.9	10.9	5.17	15.0	10.5	5.50	13.6	10.0	5.50	10.5	8.7	4.13
					22	18.7	9.4	5.00	17.5	8.8	5.34	16.4	8.5	5.69	14.9	7.9	5.69	11.5	6.6	4.27
29	16			16.2	15.4	4.64	15.2	14.7	4.96	14.3	14.2	5.29	13.0	13.0	5.29	10.0	10.0	3.96		
	19			17.3	12.9	4.84	16.2	12.3	5.18	15.2	11.9	5.51	13.8	11.4	5.51	10.7	9.9	4.14		
	22			19.0	10.8	5.01	17.7	10.3	5.36	16.7	9.7	5.70	15.2	9.3	5.70	11.7	7.9	4.28		
32	16			16.4	16.5	4.65	15.4	15.4	4.98	14.5	14.5	5.30	13.1	13.2	5.30	10.1	10.2	3.97		
	19			17.6	14.9	4.86	16.4	14.4	5.19	15.4	14.0	5.53	14.0	13.4	5.53	10.8	10.9	4.15		
	22			19.2	12.7	5.02	18.0	12.3	5.37	16.9	11.8	5.72	15.4	11.2	5.72	11.8	9.9	4.29		

**1-12. Capacity Table**  
**1. Cooling Capacity Performance Data**  
**U-140PZ2E5 (U-140PZ2E8)**

TC :Cooling Capacity  
 SHC :Sensible Heat Capacity  
 IPT :Cooling Power Consumption  
 unit : kW

Model	Power Source	Ambient Return Air		Outdoor air intake temp(°C D.B.)																
				25°C			30°C			35°C			40°C			43°C				
		DB	WB	TC	SHC	IPT	TC	SHC	IPT	TC	SHC	IPT	TC	SHC	IPT	TC	SHC	IPT		
S-71PK2E5B x2 U-140PZ2E5 (U-140PZ2E8)	220V-230V-240V 50Hz 1phase (380V-400V-415V 50Hz 3phase)	23	16	14.9	10.9	4.56	13.9	9.1	4.88	13.1	8.7	5.19	11.9	8.1	5.19	9.2	6.9	3.90		
			19	15.9	8.3	4.76	14.9	6.5	5.09	14.0	6.1	5.42	12.7	5.5	5.42	9.8	4.4	4.06		
			22	17.5	6.0	4.92	16.3	4.1	5.26	15.4	3.6	5.60	14.0	3.2	5.60	10.7	2.1	4.20		
		25	16	15.4	12.6	4.64	14.4	12.3	4.96	13.6	11.7	5.28	12.3	11.3	5.28	9.5	9.5	3.96		
			19	16.5	10.0	4.84	15.4	9.5	5.17	14.5	9.1	5.51	13.2	8.7	5.51	10.2	7.4	4.13		
			22	18.1	7.5	5.01	16.9	7.2	5.35	15.9	6.9	5.70	14.4	6.3	5.70	11.1	5.1	4.27		
		27	16	16.0	14.4	4.72	14.9	13.9	5.04	14.0	13.5	5.37	12.8	12.8	5.37	9.8	9.9	4.03		
			19	17.0	11.9	4.92	15.9	11.4	5.26	15.0	10.9	5.60	13.6	10.2	5.60	10.5	9.0	4.20		
			22	18.7	9.4	5.09	17.5	8.9	5.44	16.4	8.5	5.79	14.9	8.0	5.79	11.5	6.7	4.35		
		29	16	16.2	16.1	4.73	15.2	15.1	5.05	14.3	14.3	5.38	13.0	13.0	5.38	10.0	10.0	4.04		
			19	17.3	13.5	4.93	16.2	12.9	5.27	15.2	12.4	5.61	13.8	11.9	5.61	10.7	10.7	4.21		
			22	19.0	11.0	5.10	17.7	10.4	5.45	16.7	9.9	5.81	15.2	9.4	5.81	11.7	8.2	4.36		
		32	16	16.4	16.5	4.74	15.4	15.4	5.07	14.5	14.5	5.40	13.1	13.2	5.40	10.1	10.1	4.05		
			19	17.6	15.7	4.94	16.4	15.2	5.29	15.4	14.9	5.63	14.0	14.0	5.63	10.8	10.9	4.22		
			22	19.2	13.2	5.11	18.0	12.7	5.47	16.9	12.4	5.82	15.4	11.8	5.82	11.8	10.5	4.37		
		S-71PF1E5B x2 U-140PZ2E5 (U-140PZ2E8)	220V-230V-240V 50Hz 1phase (380V-400V-415V 50Hz 3phase)	23	16	14.9	11.6	4.53	13.9	9.5	4.84	13.1	9.1	5.16	11.9	8.6	5.16	9.2	7.4	3.87
					19	15.9	8.8	4.73	14.9	6.7	5.05	14.0	6.4	5.38	12.7	5.7	5.38	9.8	4.8	4.03
					22	17.5	6.2	4.89	16.3	4.0	5.23	15.4	3.8	5.56	14.0	3.3	5.56	10.7	2.2	4.17
25	16			15.4	13.5	4.61	14.4	13.0	4.92	13.6	12.6	5.24	12.3	12.1	5.24	9.5	9.5	3.93		
	19			16.5	10.6	4.80	15.4	10.1	5.14	14.5	9.7	5.47	13.2	9.3	5.47	10.2	8.1	4.10		
	22			18.1	8.0	4.97	16.9	7.6	5.31	15.9	7.2	5.66	14.4	6.7	5.66	11.1	5.6	4.24		
27	16			16.0	15.2	4.68	14.9	14.8	5.01	14.0	14.0	5.33	12.8	12.8	5.33	9.8	9.8	4.00		
	19			17.0	12.5	4.88	15.9	12.0	5.22	15.0	11.7	5.56	13.6	10.9	5.56	10.5	9.9	4.17		
	22			18.7	9.9	5.05	17.5	9.3	5.40	16.4	9.0	5.75	14.9	8.5	5.75	11.5	7.3	4.31		
29	16			16.2	16.3	4.69	15.2	15.2	5.02	14.3	14.3	5.34	13.0	13.0	5.34	10.0	10.0	4.01		
	19			17.3	14.3	4.90	16.2	13.8	5.24	15.2	13.2	5.57	13.8	12.8	5.57	10.7	10.7	4.18		
	22			19.0	11.5	5.07	17.7	11.0	5.42	16.7	10.8	5.77	15.2	10.0	5.77	11.7	8.9	4.32		
32	16			16.4	16.5	4.71	15.4	15.4	5.03	14.5	14.5	5.36	13.1	13.2	5.36	10.1	10.1	4.02		
	19			17.6	16.7	4.91	16.4	16.2	5.25	15.4	15.4	5.59	14.0	14.1	5.59	10.8	10.8	4.19		
	22			19.2	14.1	5.08	18.0	13.5	5.43	16.9	13.3	5.78	15.4	12.6	5.78	11.8	11.4	4.34		
S-140PF1E5B U-140PZ2E5 (U-140PZ2E8)	220V-230V-240V 50Hz 1phase (380V-400V-415V 50Hz 3phase)			23	16	14.9	10.8	4.53	13.9	8.9	4.84	13.1	8.5	5.16	11.9	7.9	5.16	9.2	6.7	3.87
					19	15.9	8.3	4.73	14.9	6.5	5.05	14.0	6.1	5.38	12.7	5.6	5.38	9.8	4.4	4.03
					22	17.5	6.0	4.89	16.3	4.2	5.23	15.4	3.9	5.56	14.0	3.3	5.56	10.7	2.2	4.17
		25	16	15.4	12.5	4.61	14.4	12.0	4.92	13.6	11.6	5.24	12.3	10.9	5.24	9.5	9.5	3.93		
			19	16.5	10.0	4.80	15.4	9.5	5.14	14.5	9.1	5.47	13.2	8.5	5.47	10.2	7.3	4.10		
			22	18.1	7.7	4.97	16.9	7.2	5.31	15.9	6.8	5.66	14.4	6.3	5.66	11.1	5.1	4.24		
		27	16	16.0	14.1	4.68	14.9	13.6	5.01	14.0	13.2	5.33	12.8	12.5	5.33	9.8	9.8	4.00		
			19	17.0	11.6	4.88	15.9	11.1	5.22	15.0	10.8	5.56	13.6	10.1	5.56	10.5	8.8	4.17		
			22	18.7	9.3	5.05	17.5	8.8	5.40	16.4	8.4	5.75	14.9	7.9	5.75	11.5	6.6	4.31		
		29	16	16.2	15.7	4.69	15.2	15.2	5.02	14.3	14.2	5.34	13.0	12.9	5.34	10.0	10.0	4.01		
			19	17.3	13.2	4.90	16.2	12.6	5.24	15.2	12.2	5.57	13.8	11.6	5.57	10.7	10.3	4.18		
			22	19.0	10.8	5.07	17.7	10.3	5.42	16.7	9.9	5.77	15.2	9.3	5.77	11.7	8.0	4.32		
		32	16	16.4	16.4	4.71	15.4	15.3	5.03	14.5	14.4	5.36	13.1	13.1	5.36	10.1	10.1	4.02		
			19	17.6	15.3	4.91	16.4	14.9	5.25	15.4	14.4	5.59	14.0	13.8	5.59	10.8	10.8	4.19		
			22	19.2	13.0	5.08	18.0	12.5	5.43	16.9	12.1	5.78	15.4	11.5	5.78	11.8	10.1	4.34		

1-12. Capacity Table

2. Heating Capacity Performance Data  
U-100PZ2E5 (U-100PZ2E8)

TC :Heating Capacity  
IPT :Heating Power Consumption  
unit : kW

Model	Power Source	Ambient Return Air DB	Outdoor air intake temp(°C W.B.)									
			-16°C		-8°C		6°C		8°C		15°C	
			TC	IPT	TC	IPT	TC	IPT	TC	IPT	TC	IPT
S-50PU2E5B x2 U-100PZ2E5 (U-100PZ2E8)	220V-230V-240V 50Hz 1phase (380V-400V-415V 50Hz 3phase)	16	8.0	4.24	12.7	4.63	15.1	3.68	16.0	3.75	18.0	3.69
		20	7.4	4.49	11.8	4.90	14.0	3.90	14.9	3.97	16.7	3.91
		24	6.9	4.56	11.0	4.98	13.1	3.96	13.9	4.04	15.6	3.97
S-100PU2E5B U-100PZ2E5 (U-100PZ2E8)	220V-230V-240V 50Hz 1phase (380V-400V-415V 50Hz 3phase)	16	8.0	4.24	12.7	4.63	15.1	3.68	16.0	3.75	18.0	3.69
		20	7.4	4.49	11.8	4.90	14.0	3.90	14.9	3.97	16.7	3.91
		24	6.9	4.56	11.0	4.98	13.1	3.96	13.9	4.04	15.6	3.97
S-50PT2E5B x2 U-100PZ2E5 (U-100PZ2E8)	220V-230V-240V 50Hz 1phase (380V-400V-415V 50Hz 3phase)	16	8.0	4.35	12.7	4.75	15.1	3.78	16.0	3.85	18.0	3.79
		20	7.4	4.60	11.8	5.03	14.0	4.00	14.9	4.08	16.7	4.01
		24	6.9	4.67	11.0	5.11	13.1	4.06	13.9	4.14	15.6	4.08
S-100PT2E5B U-100PZ2E5 (U-100PZ2E8)	220V-230V-240V 50Hz 1phase (380V-400V-415V 50Hz 3phase)	16	8.0	4.35	12.7	4.75	15.1	3.78	16.0	3.85	18.0	3.79
		20	7.4	4.60	11.8	5.03	14.0	4.00	14.9	4.08	16.7	4.01
		24	6.9	4.67	11.0	5.11	13.1	4.06	13.9	4.14	15.6	4.08
S-50PK2E5B x2 U-100PZ2E5 (U-100PZ2E8)	220V-230V-240V 50Hz 1phase (380V-400V-415V 50Hz 3phase)	16	7.1	4.24	11.2	4.63	13.4	3.68	14.2	3.75	16.0	3.69
		20	6.6	4.49	10.4	4.90	12.4	3.90	13.2	3.97	14.8	3.91
		24	6.2	4.56	9.8	4.98	11.6	3.96	12.3	4.04	13.9	3.97
S-100PK2E5B U-100PZ2E5 (U-100PZ2E8)	220V-230V-240V 50Hz 1phase (380V-400V-415V 50Hz 3phase)	16	6.0	3.21	9.5	3.50	11.3	2.79	12.0	2.84	13.5	2.79
		20	5.6	3.39	8.8	3.71	10.5	2.95	11.1	3.01	12.5	2.96
		24	5.2	3.45	8.3	3.77	9.8	3.00	10.4	3.05	11.7	3.01
S-50PF1E5B x2 U-100PZ2E5 (U-100PZ2E8)	220V-230V-240V 50Hz 1phase (380V-400V-415V 50Hz 3phase)	16	8.0	4.34	12.7	4.74	15.1	3.77	16.0	3.84	18.0	3.78
		20	7.4	4.59	11.8	5.02	14.0	3.99	14.9	4.07	16.7	4.00
		24	6.9	4.66	11.0	5.10	13.1	4.05	13.9	4.13	15.6	4.07
S-100PF1E5B U-100PZ2E5 (U-100PZ2E8)	220V-230V-240V 50Hz 1phase (380V-400V-415V 50Hz 3phase)	16	8.0	4.34	12.7	4.74	15.1	3.77	16.0	3.84	18.0	3.78
		20	7.4	4.59	11.8	5.02	14.0	3.99	14.9	4.07	16.7	4.00
		24	6.9	4.66	11.0	5.10	13.1	4.05	13.9	4.13	15.6	4.07

## 1-12. Capacity Table

2. Heating Capacity Performance Data  
U-125PZ2E5 (U-125PZ2E8)

TC :Heating Capacity

IPT :Heating Power Consumption

unit : kW

Model	Power Source	Ambient Return Air	Outdoor air intake temp(°C W.B.)									
			-16°C		-8°C		6°C		8°C		15°C	
			TC	IPT	TC	IPT	TC	IPT	TC	IPT	TC	IPT
S-60PU2E5B x2 U-125PZ2E5 (U-125PZ2E8)	220V-230V-240V 50Hz 1phase (380V-400V-415V 50Hz 3phase)	16	10.2	5.24	15.7	6.17	16.2	3.97	17.2	4.08	19.3	3.98
		20	9.5	5.54	14.5	6.53	15.0	4.20	15.9	4.32	17.9	4.21
		24	8.8	5.63	13.6	6.64	14.0	4.27	14.9	4.39	16.8	4.28
S-125PU2E5B U-125PZ2E5 (U-125PZ2E8)	220V-230V-240V 50Hz 1phase (380V-400V-415V 50Hz 3phase)	16	10.2	5.24	15.7	6.17	16.2	3.97	17.2	4.08	19.3	3.98
		20	9.5	5.54	14.5	6.53	15.0	4.20	15.9	4.32	17.9	4.21
		24	8.8	5.63	13.6	6.64	14.0	4.27	14.9	4.39	16.8	4.28
S-60PT2E5B x2 U-125PZ2E5 (U-125PZ2E8)	220V-230V-240V 50Hz 1phase (380V-400V-415V 50Hz 3phase)	16	10.2	5.49	15.7	6.46	16.2	4.16	17.2	4.28	19.3	4.17
		20	9.5	5.81	14.5	6.84	15.0	4.40	15.9	4.53	17.9	4.41
		24	8.8	5.90	13.6	6.95	14.0	4.47	14.9	4.60	16.8	4.48
S-125PT2E5B U-125PZ2E5 (U-125PZ2E8)	220V-230V-240V 50Hz 1phase (380V-400V-415V 50Hz 3phase)	16	10.2	5.49	15.7	6.46	16.2	4.16	17.2	4.28	19.3	4.17
		20	9.5	5.81	14.5	6.84	15.0	4.40	15.9	4.53	17.9	4.41
		24	8.8	5.90	13.6	6.95	14.0	4.47	14.9	4.60	16.8	4.48
S-60PK2E5B x2 U-125PZ2E5 (U-125PZ2E8)	220V-230V-240V 50Hz 1phase (380V-400V-415V 50Hz 3phase)	16	10.2	5.74	15.7	6.76	16.2	4.35	17.2	4.47	19.3	4.36
		20	9.5	6.07	14.5	7.15	15.0	4.60	15.9	4.73	17.9	4.61
		24	8.8	6.17	13.6	7.27	14.0	4.67	14.9	4.81	16.8	4.69
S-60PF1E5B x2 U-125PZ2E5 (U-125PZ2E8)	220V-230V-240V 50Hz 1phase (380V-400V-415V 50Hz 3phase)	16	10.2	5.43	15.7	6.39	16.2	4.11	17.2	4.23	19.3	4.12
		20	9.5	5.74	14.5	6.76	15.0	4.35	15.9	4.48	17.9	4.36
		24	8.8	5.84	13.6	6.87	14.0	4.42	14.9	4.55	16.8	4.43
S-125PF1E5B U-125PZ2E5 (U-125PZ2E8)	220V-230V-240V 50Hz 1phase (380V-400V-415V 50Hz 3phase)	16	10.2	5.43	15.7	6.39	16.2	4.11	17.2	4.23	19.3	4.12
		20	9.5	5.74	14.5	6.76	15.0	4.35	15.9	4.48	17.9	4.36
		24	8.8	5.84	13.6	6.87	14.0	4.42	14.9	4.55	16.8	4.43

1-12. Capacity Table

2. Heating Capacity Performance Data  
U-140PZ2E5 (U-140PZ2E8)

TC :Heating Capacity  
IPT :Heating Power Consumption  
unit : kW

Model	Power Source	Ambient Return Air	Outdoor air intake temp(°C W.B.)									
			-16°C		-8°C		6°C		8°C		15°C	
			TC	IPT	TC	IPT	TC	IPT	TC	IPT	TC	IPT
S-71PU2E5B x2 U-140PZ2E5 (U-140PZ2E8)	220V-230V-240V 50Hz 1phase (380V-400V-415V 50Hz 3phase)	16	10.5	5.44	15.8	6.32	17.3	4.54	18.2	4.62	20.6	4.55
		20	9.8	5.76	14.7	6.69	16.0	4.80	16.8	4.89	19.1	4.81
		24	9.1	5.85	13.7	6.80	15.0	4.88	15.7	4.97	17.9	4.89
S-140PU2E5B U-140PZ2E5 (U-140PZ2E8)	220V-230V-240V 50Hz 1phase (380V-400V-415V 50Hz 3phase)	16	10.5	5.44	15.8	6.32	17.3	4.54	18.2	4.62	20.6	4.55
		20	9.8	5.76	14.7	6.69	16.0	4.80	16.8	4.89	19.1	4.81
		24	9.1	5.85	13.7	6.80	15.0	4.88	15.7	4.97	17.9	4.89
S-71PT2E5B x2 U-140PZ2E5 (U-140PZ2E8)	220V-230V-240V 50Hz 1phase (380V-400V-415V 50Hz 3phase)	16	10.5	5.90	15.8	6.85	17.3	4.91	18.2	5.01	20.6	4.93
		20	9.8	6.24	14.7	7.25	16.0	5.20	16.8	5.30	19.1	5.21
		24	9.1	6.34	13.7	7.37	15.0	5.28	15.7	5.38	17.9	5.30
S-140PT2E5B U-140PZ2E5 (U-140PZ2E8)	220V-230V-240V 50Hz 1phase (380V-400V-415V 50Hz 3phase)	16	10.5	5.90	15.8	6.85	17.3	4.91	18.2	5.01	20.6	4.93
		20	9.8	6.24	14.7	7.25	16.0	5.20	16.8	5.30	19.1	5.21
		24	9.1	6.34	13.7	7.37	15.0	5.28	15.7	5.38	17.9	5.30
S-71PK2E5B x2 U-140PZ2E5 (U-140PZ2E8)	220V-230V-240V 50Hz 1phase (380V-400V-415V 50Hz 3phase)	16	10.5	5.67	15.8	6.58	17.3	4.72	18.2	4.81	20.6	4.74
		20	9.8	6.00	14.7	6.97	16.0	5.00	16.8	5.09	19.1	5.01
		24	9.1	6.10	13.7	7.08	15.0	5.08	15.7	5.18	17.9	5.09
S-71PF1E5B x2 U-140PZ2E5 (U-140PZ2E8)	220V-230V-240V 50Hz 1phase (380V-400V-415V 50Hz 3phase)	16	10.5	5.80	15.8	6.74	17.3	4.84	18.2	4.93	20.6	4.85
		20	9.8	6.14	14.7	7.14	16.0	5.12	16.8	5.22	19.1	5.13
		24	9.1	6.24	13.7	7.25	15.0	5.20	15.7	5.30	17.9	5.22
S-140PF1E5B U-140PZ2E5 (U-140PZ2E8)	220V-230V-240V 50Hz 1phase (380V-400V-415V 50Hz 3phase)	16	10.5	5.80	15.8	6.74	17.3	4.84	18.2	4.93	20.6	4.85
		20	9.8	6.14	14.7	7.14	16.0	5.12	16.8	5.22	19.1	5.13
		24	9.1	6.24	13.7	7.25	15.0	5.20	15.7	5.30	17.9	5.22

1-13. Product Fiche

U-100PZ2E5



Panasonic

Model name		SEER										SCOP																			
Indoor Unit	Outdoor Unit	A ~ G	kW	SEER	*2 kWh/annum	dB	dB	Warmer					Average					Colder													
								A ~ G	kW	SCOP	*2 kWh/annum	dB	dB	elbu (2°C) kWh	A ~ G	kW	SCOP	*2 kWh/annum	dB	dB	elbu (-10°C) kWh	A ~ G	kW	SCOP	*2 kWh/annum	elbu (-22°C) kWh					
S-100PUZE5B	U-100PZ2E5	A++	10.0	6.8	515	60	70	-	x	x	x	A+	10.0	4.4	3182	60	70	-	x	x	x	A+	10.0	4.4	3182	60	70	-	x	x	x
S-50PUZE5B x2	U-100PZ2E5	A++	10.0	6.8	515	47	70	-	x	x	x	A+	10.0	4.4	3182	47	70	-	x	x	x	A+	10.0	4.4	3182	47	70	-	x	x	x
S-100PFI5B	U-100PZ2E5	A+	10.0	5.6	625	60	70	-	x	x	x	A	10.0	3.8	3884	60	70	-	x	x	x	A	10.0	3.8	3884	60	70	-	x	x	x
S-50PFI5B x2	U-100PZ2E5	A	10.0	5.4	648	56	70	-	x	x	x	A	10.0	3.8	3884	56	70	-	x	x	x	A	10.0	3.8	3884	56	70	-	x	x	x
S-100PKZE5B	U-100PZ2E5	A++	9.0	6.5	485	65	70	-	x	x	x	A	9.0	3.9	3231	65	70	-	x	x	x	A	9.0	3.9	3231	65	70	-	x	x	x
S-50PKZE5B x2	U-100PZ2E5	A++	10.0	6.4	547	56	70	-	x	x	x	A	10.0	3.9	3590	56	70	-	x	x	x	A	10.0	3.9	3590	56	70	-	x	x	x
S-100PTZE5B	U-100PZ2E5	A++	10.0	6.5	535	60	70	-	x	x	x	A+	10.0	4.2	3324	60	70	-	x	x	x	A+	10.0	4.2	3324	60	70	-	x	x	x
S-50PTZE5B x2	U-100PZ2E5	A++	10.0	6.4	551	55	70	-	x	x	x	A+	10.0	4.0	3495	55	70	-	x	x	x	A+	10.0	4.0	3495	55	70	-	x	x	x

ENERGIA - ENERGIJA - ENERTEIA - ENERGIA - ENERGY - ENERGIE - ENERGI

R32 (GWP=675) \*1

\*1 Refrigerant leakage contributes to climate change. Refrigerant with lower global warming potential (GWP) would contribute less to global warming than a refrigerant with higher GWP, if leaked to the atmosphere. This appliance contains a refrigerant fluid with a GWP equal to 675. This means that if 1 kg of this refrigerant fluid would be leaked to the atmosphere, the impact on global warming would be 675 times higher than 1 kg of CO2, over a period of 100 years. Never try to interfere with the refrigerant circuit yourself or disassemble the product yourself and always ask a professional.

\*2 Energy consumption "Xyz" kWh per Year, based on standard test results. Actual energy consumption will depend on how the appliance is used and where it is located.

1-13. Product Fiche

U-100PZ2E8



Panasonic

Model name		SEER						SCOP						Average						Warmer						Colder					
Indoor Unit	Outdoor Unit	A ~ G	kW	SEER	*2 kWh/annu m	dB	dB	A ~ G	kW	SCOP	*2 kWh/annu m	dB	dB	A ~ G	kW	SCOP	*2 kWh/annu m	dB	dB	elbu (-10°C) kW	A ~ G	kW	SCOP	*2 kWh/annu m	elbu (-22°C) kW	A ~ G	kW	SCOP	*2 kWh/annu m	elbu (-22°C) kW	
S-100PU2E5B	U-100PZ2E8	A++	10.0	6.7	521	60	70	-	X	X	4.4	60	70	A+	10.0	4.4	3182	60	70	0.00	-	X	X	X	X	-	X	X	X	X	
S-50PU2E5B x2	U-100PZ2E8	A++	10.0	6.7	521	47	70	-	X	X	4.4	47	70	A+	10.0	4.4	3182	47	70	0.00	-	X	X	X	X	-	X	X	X	X	
S-100PF1E5B	U-100PZ2E8	A+	10.0	5.6	625	60	70	-	X	X	3.8	60	70	A	10.0	3.8	3884	60	70	0.00	-	X	X	X	X	-	X	X	X	X	
S-50PF1E5B x2	U-100PZ2E8	A	10.0	5.4	648	56	70	-	X	X	3.8	56	70	A	10.0	3.8	3884	56	70	0.00	-	X	X	X	X	-	X	X	X	X	
S-100PK2E5B	U-100PZ2E8	A++	9.0	6.5	485	65	70	-	X	X	3.9	65	70	A	9.0	3.9	3231	65	70	1.25	-	X	X	X	X	-	X	X	X	X	
S-50PK2E5B x2	U-100PZ2E8	A++	10.0	6.4	547	56	70	-	X	X	3.9	56	70	A	10.0	3.9	3900	56	70	1.69	-	X	X	X	X	-	X	X	X	X	
S-100PT2E5B	U-100PZ2E8	A++	10.0	6.5	538	60	70	-	X	X	4.2	60	70	A+	10.0	4.2	3324	60	70	2.07	-	X	X	X	X	-	X	X	X	X	
S-50PT2E5B x2	U-100PZ2E8	A++	10.0	6.3	554	55	70	-	X	X	4.0	55	70	A+	10.0	4.0	3495	55	70	2.07	-	X	X	X	X	-	X	X	X	X	

ENERGIA - ΕΠΕΡΤΗΡΙΑ - ENERTEIA - ENERGIA - ENERGY - ENERGIE - ENERGI  
626/2011

R32 (GWP=675) \*1

\*1 Refrigerant leakage contributes to climate change. Refrigerant with lower global warming potential (GWP) would contribute less to global warming than a refrigerant with higher GWP, if leaked to the atmosphere. This appliance contains a refrigerant fluid with a GWP equal to 675. This means that if 1 kg of this refrigerant fluid would be leaked to the atmosphere, the impact on global warming would be 675 times higher than 1 kg of CO2, over a period of 100 years. Never try to interfere with the refrigerant circuit yourself or disassemble the product yourself and always ask a professional.

\*2 Energy consumption "XYZ" kWh per year, based on standard test results. Actual energy consumption will depend on how the appliance is used and where it is located.

1-14. Information Table

Information requirements for air-to-air air conditioners

Model(s): U-125PZ2E5 Outdoor Unit x2  
S-60PU2E5B Indoor Unit air

Outdoor side heat exchanger of air conditioner:  
Indoor side heat exchanger of air conditioner:  
Type: compressor driven vapour compression or sorption process  
if applicable: driver of compressor: [electric motor or fuel driven,  
gaseous or liquid fuel, internal or external combustion engine]  
electric motor

Item	Symbol	Value	Unit	Item	Symbol	Value	Unit
Rated cooling capacity	$P_{elec,c}$	12.5	kW	Seasonal space cooling energy efficiency	$\eta_{s,c}$	270.8	%
Refrigeration load	$P_{design,c}$	12.5	kW	Declared energy efficiency ratio or gas utilization efficiency / auxiliary energy factor for part load at given outdoor temperatures Tj and indoor 27°/19°C (dry/wet bulb)			
Declared cooling capacity for part load at given outdoor temperatures Tj and indoor 27°/19°C (dry/wet bulb)	Tj = +35 °C	12.5	kW	Tj = +35 °C	EER <sub>d</sub> or GUE <sub>c,bin</sub> / AEF <sub>c,bin</sub>	3.5	%
	Tj = +30 °C	9.2	kW	Tj = +30 °C		4.8	%
	Tj = +25 °C	5.9	kW	Tj = +25 °C		8.2	%
	Tj = +20 °C	4.4	kW	Tj = +20 °C		12.3	%
Degradation co-efficient for air conditioners**	$C_{ac}$	0.25	-	Power consumption in modes other than 'active mode'			
				Off mode			
				Thermostat-off mode			
				Crankcase heater mode			
				Standby mode			
				Other items			
Capacity control		variable		For air-to-air air conditioner: air flow rate, outdoor		5160	m³/h
Sound power level, outdoor	$L_{WA}$	73.0	dB				
Sound power level, indoor	$L_{WA}$	51.0	dB	if engine driven: Emissions of nitrogen oxides	NO <sub>x</sub> ***	-	mg/kWh fuel input GCV
				GWP of the refrigerant		675	kg CO <sub>2</sub> eq (100 years)
Contact details	Panasonic Testing Centre, Panasonic Marketing Europe GmbH Winsbergring 15, 22525 Hamburg, Germany						

\*\* If  $C_{ac}$  is not determined by measurement then the default degradation coefficient air conditioners shall be 0.25.  
\*\*\* from 26 September 2018.  
Where information relates to multi-split air conditioners, the test result and performance data may be obtained on the basis of the performance of the outdoor unit, with a combination of indoor unit(s) recommended by the manufacturer or importer.

Information requirements for heat pumps

Model(s): U-125PZ2E5 Outdoor Unit x2  
S-60PU2E5B Indoor Unit air

Outdoor side heat exchanger of heat pump:  
Indoor side heat exchanger of heat pump:  
Indication if the heater is equipped with a supplementary heater:  
if applicable: driver of compressor: [electric motor or fuel driven,  
gaseous or liquid fuel, internal or external combustion engine]  
electric motor

Parameters shall be declared for the average heating season, parameters for the warmer and colder heating seasons are optional.

Item	Symbol	Value	Unit	Item	Symbol	Value	Unit
Rated heating capacity	$P_{rated,h}$	12.5	kW	Seasonal space heating energy efficiency	$\eta_{p,h}$	157.4	%
Refrigeration load	$P_{design,h}$	12.5	kW	Declared coefficient of performance or gas utilization efficiency / auxiliary energy factor for part load at given outdoor temperatures Tj			
Declared heating capacity for part load at indoor temperature 20 °C and outdoor temperature Tj	Tj = -7 °C	11.0	kW	Tj = -7 °C	COP <sub>d</sub> or GUE <sub>h,bin</sub> / AEF <sub>h,bin</sub>	2.5	%
	Tj = +2 °C	6.7	kW	Tj = +2 °C		3.7	%
	Tj = +7 °C	4.3	kW	Tj = +7 °C		5.9	%
	Tj = +12 °C	3.7	kW	Tj = +12 °C		7.0	%
$T_{hw}$ = bivalent temperature	$P_{bh}$	12.5	kW	$T_{hw}$ = bivalent temperature		2.2	%
$T_{ca}$ = operation limit		7.9	kW	$T_{ca}$ = operation limit		1.7	%
For air-to-water heat pumps: Tj = -15 °C (if $T_{OIL} < -20$ °C)		-	kW	For water-to-air heat pumps: Tj = -15 °C (if $T_{OIL} < -20$ °C)		-	%
Bivalent temperature	$T_{bw}$	-10	°C	For water-to-air heat pumps: Operation limit temperature	$T_{OL}$	-15	°C
Degradation co-efficient heat pumps**	$C_{hp}$	0.25	-	Supplementary heater			
				Power consumption in modes other than 'active mode'			
				Off mode			
				Thermostat-off mode			
				Crankcase heater mode			
				Other items			
Capacity control		variable		For air-to-air heat pumps: air flow rate, outdoor		4680	m³/h
Sound power level, outdoor	$L_{WA}$	73.0	dB	For water-/brine-to-air heat pumps: Rated brine or water flow rate, outdoor side heat exchanger		-	m³/h
Sound power level, indoor	$L_{WA}$	51.0	dB	Emissions of nitrogen oxides (if applicable)	NO <sub>x</sub> ***	-	mg/kWh fuel input GCV
				GWP of the refrigerant		675	kg CO <sub>2</sub> eq (100 years)
Contact details	Panasonic Testing Centre, Panasonic Marketing Europe GmbH Winsbergring 15, 22525 Hamburg, Germany						

\*\* If  $C_{hp}$  is not determined by measurement then the default degradation coefficient of heat pumps shall be 0.25.  
\*\*\* from 26 September 2018.  
Where information relates to multi-split heat pumps, the test result and performance data may be obtained on the basis of the performance of the outdoor unit, with a combination of indoor unit(s) recommended by the manufacturer or importer.



## Information requirements for air-to-air air conditioners

Model(s):	Outdoor Unit Indoor Unit	U-140PZ2E5 S-71PU2E5B	x 2
Outdoor side heat exchanger of air conditioner:	air		
Indoor side heat exchanger of air conditioner:	air		
Type: compressor driven vapour compression or sorption process	vapour compression		
if applicable: driver of compressor: [electric motor or fuel driven, gaseous or liquid fuel, internal or external combustion engine]	electric motor		

## Information requirements for heat pumps

Model(s):	Outdoor Unit Indoor Unit	U-140PZ2E5 S-71PU2E5B	x 2
Outdoor side heat exchanger of heat pump:	air		
Indoor side heat exchanger of heat pump:	air		
Indication if the heater is equipped with a supplementary heater:	no		
if applicable: driver of compressor: [electric motor or fuel driven, gaseous or liquid fuel, internal or external combustion engine]	electric motor		

Parameters shall be declared for the average heating season, parameters for the warmer and colder heating seasons are optional.

Item	Symbol	Value	Unit	Item	Symbol	Value	Unit
Rated cooling capacity	$P_{rated,c}$	14.0	kW	Seasonal space cooling energy efficiency	$\eta_{s,c}$	260.3	%
Refrigeration load	$P_{design,c}$	14.0	kW	Declared energy efficiency ratio or gas utilization efficiency / auxiliary energy factor for part load at given outdoor temperatures T <sub>J</sub> and indoor 27°/19°C (dry/wet bulb)			
Declared cooling capacity for part load at given outdoor temperatures T <sub>J</sub> and indoor 27°/19°C (dry/wet bulb)				Declared energy efficiency ratio or gas utilization efficiency / auxiliary energy factor for part load at given outdoor temperatures T <sub>J</sub>			
T <sub>J</sub> = + 35 °C		14.0	kW	T <sub>J</sub> = + 35 °C		3.2	%
T <sub>J</sub> = + 30 °C		10.3	kW	T <sub>J</sub> = + 30 °C		4.6	%
T <sub>J</sub> = + 25 °C	$P_{dc}$	6.6	kW	T <sub>J</sub> = + 25 °C		7.8	%
T <sub>J</sub> = + 20 °C		4.4	kW	T <sub>J</sub> = + 20 °C		12.2	%
Degradation co-efficient for air conditioners**	$C_{dc}$	0.25	-				
Power consumption in modes other than 'active mode'							
Off mode	$P_{off}$	0.012	kW	Crankcase heater mode	$P_{ck}$	0.000	kW
Thermostat-off mode	$P_{to}$	0.000	kW	Standby mode	$P_{sb}$	0.012	kW
Other items							
Capacity control		variable		For air-to-air air conditioner: air flow rate, outdoor		5340	m <sup>3</sup> /h
Sound power level, outdoor	$L_{WA}$	74.0	dB				
Sound power level, indoor	$L_{WA}$	52.0	dB	If engine driven: Emissions of nitrogen oxides	$NO_x^{***}$	-	mg/kWh fuel input GCV
				GWP of the refrigerant		675	kg CO <sub>2</sub> eq (100 years)
Contact details	Panasonic Testing Centre, Panasonic Marketing Europe GmbH Winsbergweg 15, 22525 Hamburg, Germany						

\*\* If  $C_{dc}$  is not determined by measurement then the default degradation coefficient air conditioners shall be 0.25.

\*\*\* from 26 September 2018.

Where information relates to multi-split air conditioners, the test result and performance data may be obtained on the basis of the performance of the outdoor unit, with a combination of indoor unit(s) recommended by the manufacturer or importer.

Item	Symbol	Value	Unit	Item	Symbol	Value	Unit
Rated heating capacity	$P_{rated,h}$	14.0	kW	Seasonal space heating energy efficiency	$\eta_{s,h}$	152.5	%
Refrigeration load	$P_{design,h}$	14.0	kW	Declared coefficient of performance or gas utilization efficiency / auxiliary energy factor for part load at given outdoor temperatures T <sub>J</sub>			
Declared heating capacity for part load at indoor temperature 20 °C and outdoor temperature T <sub>J</sub>				Declared coefficient of performance or gas utilization efficiency / auxiliary energy factor for part load at given outdoor temperatures T <sub>J</sub>			
T <sub>J</sub> = - 7 °C		12.3	kW	T <sub>J</sub> = - 7 °C		2.4	%
T <sub>J</sub> = + 2 °C		7.5	kW	T <sub>J</sub> = + 2 °C		3.6	%
T <sub>J</sub> = + 7 °C		4.8	kW	T <sub>J</sub> = + 7 °C		5.8	%
T <sub>J</sub> = + 12 °C		3.7	kW	T <sub>J</sub> = + 12 °C		7.0	%
$T_{bv}$ = bivalent temperature	$P_{bh}$	12.3	kW	$T_{bv}$ = bivalent temperature	$COP_h$ or $GUE_{h,bn}$ / $AEF_{h,bn}$	2.4	%
$T_{ol}$ = operation limit		8.2	kW	$T_{ol}$ = operation limit		1.7	%
For air-to-water heat pumps: T <sub>J</sub> = - 15 °C (if T <sub>ol</sub> < - 20 °C)		-	kW	For water-to-air heat pumps: T <sub>J</sub> = - 15 °C (if T <sub>ol</sub> < - 20 °C)		-	%
Bivalent temperature	$T_{bv}$	-7	°C	For water-to-air heat pumps: Operation limit temperature	$T_{ol}$	-15	°C
Degradation co-efficient heat pumps**	$C_{dh}$	0.25	-				
Power consumption in modes other than 'active mode'							
Off mode	$P_{off}$	0.012	kW	back-up heating capacity *	$elbu$	3.3	kW
Thermostat-off mode	$P_{to}$	0.000	kW	Type of energy input			
Crankcase heater mode	$P_{ck}$	0.000	kW	Standby mode	$P_{sb}$	0.012	kW
Other items							
Capacity control		variable		For air-to-air heat pumps: air flow rate, outdoor		4980	m <sup>3</sup> /h
Sound power level, outdoor	$L_{WA}$	74.0	dB	For water-/brine-to-air heat pumps: Rated brine or water flow rate, outdoor side heat exchanger		-	m <sup>3</sup> /h
Sound power level, indoor	$L_{WA}$	52.0	dB	Emissions of nitrogen oxides (if applicable)	$NO_x^{***}$	-	mg/kWh fuel input GCV
				GWP of the refrigerant		675	kg CO <sub>2</sub> eq (100 years)
Contact details	Panasonic Testing Centre, Panasonic Marketing Europe GmbH Winsbergweg 15, 22525 Hamburg, Germany						

\*\* If  $C_{dh}$  is not determined by measurement then the default degradation coefficient of heat pumps shall be 0.25.

\*\*\* from 26 September 2018.

Where information relates to multi-split heat pumps, the test result and performance data may be obtained on the basis of the performance of the outdoor unit, with a combination of indoor unit(s) recommended by the manufacturer or importer.

### Information requirements for air-to-air air conditioners

Model(s):	Outdoor Unit U-125PZ2E5 Indoor Unit S-125PUZE5B
Outdoor side heat exchanger of air conditioner:	air
Indoor side heat exchanger of air conditioner:	air
Type: compressor driven vapour compression or sorption process	vapour compression
if applicable: driver of compressor: [electric motor or fuel driven, gaseous or liquid fuel, internal or external combustion engine]	electric motor

### Information requirements for heat pumps

Model(s):	Outdoor Unit U-125PZ2E5 Indoor Unit S-125PUZE5B
Outdoor side heat exchanger of heat pump:	air
Indoor side heat exchanger of heat pump:	air
Indication if the heater is equipped with a supplementary heater:	no
if applicable: driver of compressor: [electric motor or fuel driven, gaseous or liquid fuel, internal or external combustion engine]	electric motor

Parameters shall be declared for the average heating season, parameters for the warmer and colder heating seasons are optional.

Item	Symbol	Value	Unit	Item	Symbol	Value	Unit
Rated cooling capacity	$P_{rated,c}$	12.5	kW	Seasonal space cooling energy efficiency	$\eta_{s,c}$	267.1	%
Refrigeration load	$P_{design,c}$	12.5	kW	Declared energy efficiency ratio or gas utilization efficiency / auxiliary energy factor for part load at given outdoor temperatures Tj and indoor 27/19°C (dry/wet bulb)			
Declared cooling capacity for part load at given outdoor temperatures Tj and indoor 27/19°C (dry/wet bulb)				Declared energy efficiency ratio or gas utilization efficiency / auxiliary energy factor for part load at given outdoor temperatures Tj			
Tj = +35 °C		12.5	kW	Tj = +35 °C		3.5	%
Tj = +30 °C		9.2	kW	Tj = +30 °C		4.8	%
Tj = +25 °C	$P_{dc}$	5.9	kW	Tj = +25 °C		8.2	%
Tj = +20 °C		4.2	kW	Tj = +20 °C		12.3	%
Degradation co-efficient for air conditioners**	$C_{dc}$	0.25	-	Power consumption in modes other than 'active mode'			
Off mode				Power consumption in modes other than 'active mode'			
Thermostat-off mode				Power consumption in modes other than 'active mode'			
Crankcase heater mode				Power consumption in modes other than 'active mode'			
Standby mode				Power consumption in modes other than 'active mode'			
Other items				Power consumption in modes other than 'active mode'			
Capacity control		variable		For air-to-air conditioner: air flow rate, outdoor		5160	m³/h
Sound power level, outdoor	$L_{WA}$	73.0	dB				
Sound power level, indoor	$L_{WA}$	61.0	dB	if engine driven: Emissions of nitrogen oxides	$NO_x^{***}$	-	mg/kWh fuel input GCV
				GWP of the refrigerant		675	kg CO <sub>2</sub> eq (100 years)
Contact details	Panasonic Testing Centre, Panasonic Marketing Europe GmbH Winsbergiring 15, 22525 Hamburg, Germany						

\*\* If  $C_{dc}$  is not determined by measurement then the default degradation coefficient air conditioners shall be 0.25.

\*\*\* from 26 September 2018.

Where information relates to multi-split air conditioners, the test result and performance data may be obtained on the basis of the performance of the outdoor unit, with a combination of indoor unit(s) recommended by the manufacturer or importer.

Item	Symbol	Value	Unit	Item	Symbol	Value	Unit
Rated heating capacity	$P_{rated,h}$	12.5	kW	Seasonal space heating energy efficiency	$\eta_{s,h}$	157.3	%
Refrigeration load	$P_{design,h}$	12.5	kW	Declared coefficient of performance or gas utilization efficiency / auxiliary energy factor for part load at given outdoor temperatures Tj			
Declared heating capacity for part load at indoor temperature 20 °C and outdoor temperature Tj				Declared coefficient of performance or gas utilization efficiency / auxiliary energy factor for part load at given outdoor temperatures Tj			
Tj = -7 °C		11.0	kW	Tj = -7 °C		2.5	%
Tj = +2 °C		6.7	kW	Tj = +2 °C		3.7	%
Tj = +7 °C		4.3	kW	Tj = +7 °C		5.9	%
Tj = +12 °C		3.9	kW	Tj = +12 °C		7.0	%
$T_{bw}$ = bivalent temperature	$P_{bh}$	12.5	kW	$T_{bw}$ = bivalent temperature	$COP_h$ or $GUE_{h,bn}$ / $AEF_{h,bn}$	2.2	%
$T_{ol}$ = operation limit		8.3	kW	$T_{ol}$ = operation limit		1.7	%
For air-to-water heat pumps: Tj = -15 °C (if $T_{ol} < -20$ °C)		-	kW	For water-to-air heat pumps: Tj = -15 °C (if $T_{ol} < -20$ °C)		-	%
Bivalent temperature	$T_{bw}$	-10	°C	For water-to-air heat pumps: Operation limit temperature	$T_{ol}$	-15	°C
Degradation co-efficient heat pumps**	$C_{dh}$	0.25	-	Supplementary heater			
Off mode				back-up heating capacity *			
Thermostat-off mode				Type of energy input			
Crankcase heater mode				Standby mode			
Other items				Other items			
Capacity control		variable		For air-to-air heat pumps: air flow rate, outdoor		4680	m³/h
Sound power level, outdoor	$L_{WA}$	73.0	dB	For water-/brine-to-air heat pumps: Rated brine or water flow rate, outdoor side heat exchanger		-	m³/h
Sound power level, indoor	$L_{WA}$	61.0	dB	Emissions of nitrogen oxides (if applicable)	$NO_x^{***}$	-	mg/kWh fuel input GCV
				GWP of the refrigerant		675	kg CO <sub>2</sub> eq (100 years)
Contact details	Panasonic Testing Centre, Panasonic Marketing Europe GmbH Winsbergiring 15, 22525 Hamburg, Germany						

\*\* If  $C_{dh}$  is not determined by measurement then the default degradation coefficient of heat pumps shall be 0.25.

\*\*\* from 26 September 2018.

Where information relates to multi-split heat pumps, the test result and performance data may be obtained on the basis of the performance of the outdoor unit, with a combination of indoor unit(s) recommended by the manufacturer or importer.

### Information requirements for air-to-air air conditioners

Model(s):	Outdoor Unit Indoor Unit	U-140PZ2E5 S-140PUZE5B
Outdoor side heat exchanger of air conditioner:	air	
Indoor side heat exchanger of air conditioner:	air	
Type: compressor driven vapour compression or sorption process	vapour compression	
if applicable: driver of compressor: [electric motor or fuel driven, gaseous or liquid fuel, internal or external combustion engine]	electric motor	

### Information requirements for heat pumps

Model(s):	Outdoor Unit Indoor Unit	U-140PZ2E5 S-140PUZE5B
Outdoor side heat exchanger of heat pump:	air	
Indoor side heat exchanger of heat pump:	air	
Indication if the heater is equipped with a supplementary heater:	no	
if applicable: driver of compressor: [electric motor or fuel driven, gaseous or liquid fuel, internal or external combustion engine]	electric motor	
Parameters shall be declared for the average heating season, parameters for the warmer and colder heating seasons are optional.		

Item	Symbol	Value	Unit	Item	Symbol	Value	Unit
Rated cooling capacity	$P_{rated,c}$	14.0	kW	Seasonal space cooling energy efficiency	$\eta_{sc}$	257.3	%
Refrigeration load	$P_{design,z}$	14.0	kW	Declared energy efficiency ratio or gas utilization efficiency / auxiliary energy factor for part load at given outdoor temperatures Tj and indoor 27°/19°C (dry/wet bulb)			
Declared cooling capacity for part load at given outdoor temperatures Tj and indoor 27°/19°C (dry/wet bulb)				Declared energy efficiency ratio or gas utilization efficiency / auxiliary energy factor for part load at given outdoor temperatures Tj			
Tj = +35 °C		14.0	kW	Tj = +35 °C		3.2	%
Tj = +30 °C		10.3	kW	Tj = +30 °C	EER <sub>d</sub> or GUE <sub>ch,br</sub> /	4.6	%
Tj = +25 °C	P <sub>dc</sub>	6.6	kW	Tj = +25 °C	AEF <sub>ch,br</sub>	7.8	%
Tj = +20 °C		4.2	kW	Tj = +20 °C		12.2	%
Degradation co- efficient for air conditioners**	C <sub>dc</sub>	0.25	-				
Power consumption in modes other than 'active mode'							
Off mode	P <sub>off</sub>	0.017	kW	Crankcase heater mode	P <sub>ck</sub>	0.000	kW
Thermostat-off mode	P <sub>to</sub>	0.015	kW	Standby mode	P <sub>sb</sub>	0.017	kW
Other items							
Capacity control		variable		For air-to-air air conditioner: air flow rate, outdoor		5340	m³/h
Sound power level, outdoor	L <sub>WA</sub>	74.0	dB				
Sound power level, indoor	L <sub>WA</sub>	62.0	dB	if engine driven: Emissions of nitrogen oxides	NO <sub>x</sub> ***	-	mg/KWh fuel input GCV
				GWP of the refrigerant		675	kg CO <sub>2</sub> eq (100 years)
Contact details	Panasonic Testing Centre, Panasonic Marketing Europe GmbH Winsberg 15, 22525 Hamburg, Germany						

\*\* If C<sub>dc</sub> is not determined by measurement then the default degradation coefficient air conditioners shall be 0.25.  
\*\*\* from 26 September 2018.  
Where information relates to multi-split air conditioners, the test result and performance data may be obtained on the basis of the performance of the outdoor unit, with a combination of indoor unit(s) recommended by the manufacturer or importer.

Item	Symbol	Value	Unit	Item	Symbol	Value	Unit
Rated heating capacity	$P_{rated,h}$	14.0	kW	Seasonal space heating energy efficiency	$\eta_{ph}$	152.4	%
Refrigeration load	$P_{design,h}$	14.0	kW	Declared coefficient of performance or gas utilization efficiency / auxiliary energy factor for part load at given outdoor temperatures Tj			
Declared heating capacity for part load at indoor temperature 20 °C and outdoor temperature Tj				Declared coefficient of performance or gas utilization efficiency / auxiliary energy factor for part load at given outdoor temperatures Tj			
Tj = -7 °C		12.3	kW	Tj = -7 °C		2.4	%
Tj = +2 °C		7.5	kW	Tj = +2 °C		3.6	%
Tj = +7 °C		4.8	kW	Tj = +7 °C		5.8	%
Tj = +12 °C		3.9	kW	Tj = +12 °C		7.0	%
T <sub>bw</sub> = bivalent temperature	P <sub>ah</sub>	12.3	kW	T <sub>bw</sub> = bivalent temperature	GUE <sub>h,br</sub> / AEF <sub>h,br</sub>	2.4	%
T <sub>ol</sub> = operation limit		8.6	kW	T <sub>ol</sub> = operation limit		1.7	%
For air-to-water heat pumps:		-	kW	For water-to-air heat pumps:		-	%
Tj = -15 °C (if T <sub>ol</sub> < -20 °C)		-	kW	Tj = -15 °C (if T <sub>ol</sub> < -20 °C)		-	%
Bivalent temperature	T <sub>bw</sub>	-7	°C	Operation limit temperature	T <sub>ol</sub>	-15	°C
Degradation co- efficient heat pumps**	C <sub>th</sub>	0.25	-				
Power consumption in modes other than 'active mode'							
Off mode	P <sub>off</sub>	0.017	kW	Supplementary heater back-up heating capacity*	elbu	3.1	kW
Thermostat-off mode	P <sub>to</sub>	0.015	kW	Type of energy input			
Crankcase heater mode	P <sub>ck</sub>	0.000	kW	Standby mode	P <sub>sb</sub>	0.017	kW
Other items							
Capacity control		variable		For air-to-air heat pumps: air flow rate, outdoor		4980	m³/h
Sound power level, outdoor	L <sub>WA</sub>	74.0	dB	For water-/brine-to-air heat pumps: Rated brine or water flow rate, outdoor side heat exchanger		-	m³/h
Sound power level, indoor	L <sub>WA</sub>	62.0	dB	Emissions of nitrogen oxides (if applicable)	NO <sub>x</sub> ***	-	mg/KWh fuel input GCV
				GWP of the refrigerant		675	kg CO <sub>2</sub> eq (100 years)
Contact details	Panasonic Testing Centre, Panasonic Marketing Europe GmbH Winsberg 15, 22525 Hamburg, Germany						

\*\* If C<sub>th</sub> is not determined by measurement then the default degradation coefficient of heat pumps shall be 0.25.  
\*\*\* from 26 September 2018.  
Where information relates to multi-split heat pumps, the test result and performance data may be obtained on the basis of the performance of the outdoor unit, with a combination of indoor unit(s) recommended by the manufacturer or importer.

### Information requirements for air-to-air air conditioners

Model(s):	Outdoor Unit Indoor Unit	UJ-125PZZE8 S-60PUZE5B	x 2
Outdoor side heat exchanger of air conditioner:	air		
Indoor side heat exchanger of air conditioner:	air		
Type: compressor driven vapour compression or sorption process	vapour compression		
if applicable: driver of compressor: [electric motor or fuel driven, gaseous or liquid fuel, internal or external combustion engine]	electric motor		

### Information requirements for heat pumps

Model(s):	Outdoor Unit Indoor Unit	UJ-125PZZE8 S-60PUZE5B	x 2
Outdoor side heat exchanger of heat pump:	air		
Indoor side heat exchanger of heat pump:	air		
Indication if the heater is equipped with a supplementary heater:	no		
if applicable: driver of compressor: [electric motor or fuel driven, gaseous or liquid fuel, internal or external combustion engine]	electric motor		

Parameters shall be declared for the average heating season, parameters for the warmer and colder heating seasons are optional.

Item	Symbol	Value	Unit	Item	Symbol	Value	Unit
Rated cooling capacity	$P_{\text{elec,c}}$	12.5	kW	Seasonal space cooling energy efficiency	$\eta_{\text{sc}}$	269.8	%
Refrigeration load	$P_{\text{design,c}}$	12.5	kW	Declared energy efficiency ratio or gas utilization efficiency / auxiliary energy factor for part load at given outdoor temperatures Tj and indoor 27°/19°C (dry/wet bulb)			
Declared cooling capacity for part load at given outdoor temperatures Tj and indoor 27°/19°C (dry/wet bulb)				Declared energy efficiency ratio or gas utilization efficiency / auxiliary energy factor for part load at given outdoor temperatures Tj			
Tj = +35 °C		12.5	kW	Tj = +35 °C		3.5	%
Tj = +30 °C		9.2	kW	Tj = +30 °C		4.8	%
Tj = +25 °C	$P_{\text{dc}}$	5.9	kW	Tj = +25 °C		8.2	%
Tj = +20 °C		4.4	kW	Tj = +20 °C		12.3	%
Degradation co-efficient for air conditioners**	$C_{\text{dc}}$	0.25	-	EER <sub>d</sub> or GUE <sub>h,ah</sub> / AEF <sub>h,ah</sub>			
Power consumption in modes other than 'active mode'				Power consumption in modes other than 'active mode'			
Off mode	$P_{\text{off}}$	0.015	kW	Crankcase heater mode	$P_{\text{ck}}$	0.000	kW
Thermostat-off mode	$P_{\text{to}}$	0.000	kW	Standby mode	$P_{\text{sb}}$	0.015	kW
Other items				Other items			
Capacity control		variable		For air-to-air conditioner: air flow rate, outdoor		5160	m³/h
Sound power level, outdoor	$L_{\text{WA}}$	73.0	dB				
Sound power level, indoor	$L_{\text{WA}}$	51.0	dB	if engine driven: Emissions of nitrogen oxides	$\text{NO}_x^{***}$	-	mg/kWh fuel input GCV
				GWP of the refrigerant		675	kg CO <sub>2</sub> eq (100 years)
Contact details	Panasonic Testing Centre, Panasonic Marketing Europe GmbH Winsberg 15, 22525 Hamburg, Germany						

\*\* If  $C_{\text{dc}}$  is not determined by measurement then the default degradation coefficient air conditioners shall be 0.25.

\*\*\* From 26 September 2018.

Where information relates to multi-split air conditioners, the test result and performance data may be obtained on the basis of the performance of the outdoor unit, with a combination of indoor unit(s) recommended by the manufacturer or importer.

Item	Symbol	Value	Unit	Item	Symbol	Value	Unit
Rated heating capacity	$P_{\text{elec,h}}$	12.5	kW	Seasonal space heating energy efficiency	$\eta_{\text{h}}$	157.4	%
Refrigeration load	$P_{\text{design,h}}$	12.5	kW	Declared coefficient of performance or gas utilization efficiency / auxiliary energy factor for part load at given outdoor temperatures Tj			
Declared heating capacity for part load at indoor temperature 20 °C and outdoor temperature Tj				Declared coefficient of performance or gas utilization efficiency / auxiliary energy factor for part load at given outdoor temperatures Tj			
Tj = -7 °C		11.0	kW	Tj = -7 °C		2.5	%
Tj = +2 °C		6.7	kW	Tj = +2 °C		3.7	%
Tj = +7 °C		4.3	kW	Tj = +7 °C		5.9	%
Tj = +12 °C		3.7	kW	Tj = +12 °C		7.0	%
$T_{\text{bw}}$ = bivalent temperature	$P_{\text{bh}}$	12.5	kW	$T_{\text{bw}}$ = bivalent temperature		2.2	%
$T_{\text{ol}}$ = operation limit		7.9	°C	$T_{\text{ol}}$ = operation limit		1.7	%
For air-to-water heat pumps: Tj = -15 °C (if $T_{\text{ol}} < -20$ °C)		-	°C	For water-to-air heat pumps: Tj = -15 °C (if $T_{\text{ol}} < -20$ °C)		-	°C
Bivalent temperature	$T_{\text{bw}}$	-10	°C	For water-to-air heat pumps: Operation limit temperature	$T_{\text{ol}}$	-15	°C
Degradation co-efficient heat pumps**	$C_{\text{h}}$	0.25	-	Supplementary heater			
Power consumption in modes other than 'active mode'				Supplementary heater			
Off mode	$P_{\text{off}}$	0.015	kW	back-up heating capacity *	$e_{\text{bu}}$	0.0	kW
Thermostat-off mode	$P_{\text{to}}$	0.000	kW	Type of energy input			
Crankcase heater mode	$P_{\text{ck}}$	0.000	kW	Standby mode	$P_{\text{sb}}$	0.015	kW
Other items				Other items			
Capacity control		variable		For air-to-air heat pumps: air flow rate, outdoor		4680	m³/h
Sound power level, outdoor	$L_{\text{WA}}$	73.0	dB	For water-/brine-to-air heat pumps: Rated brine or water flow rate, outdoor side heat exchanger		-	m³/h
Sound power level, indoor	$L_{\text{WA}}$	51.0	dB	Emissions of nitrogen oxides (if applicable)	$\text{NO}_x^{***}$	-	mg/kWh fuel input GCV
				GWP of the refrigerant		675	kg CO <sub>2</sub> eq (100 years)
Contact details	Panasonic Testing Centre, Panasonic Marketing Europe GmbH Winsberg 15, 22525 Hamburg, Germany						

\*\* If  $C_{\text{h}}$  is not determined by measurement then the default degradation coefficient of heat pumps shall be 0.25.

\*\*\* From 26 September 2018.

Where information relates to multi-split heat pumps, the test result and performance data may be obtained on the basis of the performance of the outdoor unit, with a combination of indoor unit(s) recommended by the manufacturer or importer.

### Information requirements for air-to-air air conditioners

Model(s):	Outdoor Unit Indoor Unit	U-140PZ2E8 S-71PU2ESB	x 2
Outdoor side heat exchanger of air conditioner:	air		
Indoor side heat exchanger of air conditioner:	air		
Type: compressor driven vapour compression or sorption process	vapour compression		
if applicable: driver of compressor: [electric motor or fuel driven, gaseous or liquid fuel, internal or external combustion engine]	electric motor		

### Information requirements for heat pumps

Model(s):	Outdoor Unit Indoor Unit	U-140PZ2E8 S-71PU2ESB	x 2
Outdoor side heat exchanger of heat pump:	air		
Indoor side heat exchanger of heat pump:	air		
Indication if the heater is equipped with a supplementary heater:	no		
if applicable: driver of compressor: [electric motor or fuel driven, gaseous or liquid fuel, internal or external combustion engine]	electric motor		

Parameters shall be declared for the average heating season, parameters for the warmer and colder heating seasons are optional.

Item	Symbol	Value	Unit	Item	Symbol	Value	Unit
Rated cooling capacity	$P_{\text{ref,c}}$	14.0	kW	Seasonal space cooling energy efficiency	$\eta_{\text{sc}}$	259.4	%
Refrigeration load	$P_{\text{ref,r,c}}$	14.0	kW	Declared energy efficiency ratio or gas utilization efficiency / auxiliary energy factor for part load at given outdoor temperatures Tj			
Declared cooling capacity for part load at given outdoor temperatures Tj and indoor 27°/19°C (dry/wet bulb)				Declared coefficient of performance or gas utilization efficiency / auxiliary energy factor for part load at given outdoor temperatures Tj			
Tj = +35 °C		14.0	kW	Tj = +35 °C		3.2	%
Tj = +30 °C		10.3	kW	Tj = +30 °C		4.6	%
Tj = +25 °C	$P_{\text{dc}}$	6.6	kW	Tj = +25 °C	EER <sub>o</sub> of GUE <sub>h,brn</sub> / AEF <sub>h,brn</sub>	7.8	%
Tj = +20 °C		4.4	kW	Tj = +20 °C		12.2	%
Degradation co-efficient for air conditioners**	$C_{\text{dc}}$	0.25	-	$T_{\text{low}}$ = bivalent temperature	$P_{\text{th}}$	12.3	kW
				$T_{\text{col}}$ = operation limit		8.2	kW
				For air-to-water heat pumps: Tj = -15 °C (if T <sub>col</sub> < -20 °C)		-	kW
				Bivalent temperature	$T_{\text{bw}}$	-7	°C
				Degradation co-efficient heat pumps**	$C_{\text{dh}}$	0.25	-
Power consumption in modes other than 'active mode'							
Off mode	$P_{\text{off}}$	0.015	kW	Supplementary heater			
Thermostat-off mode	$P_{\text{to}}$	0.000	kW	back-up heating capacity*	eibu	3.3	kW
				Type of energy input			
				Standby mode	$P_{\text{sb}}$	0.015	kW
Other items							
Capacity control		variable		For air-to-air heat pumps: air flow rate, outdoor		4980	m³/h
Sound power level, outdoor	$L_{\text{WA}}$	74.0	dB	For water-/brine-to-air heat pumps: Rated brine or water flow rate, outdoor side heat exchanger		-	m³/h
Sound power level, indoor	$L_{\text{WA}}$	52.0	dB	Emissions of nitrogen oxides (if applicable)	$\text{NO}_{\text{x}}$ **	-	mg/kWh fuel input GCV
				GWP of the refrigerant		675	kg CO <sub>2</sub> eq (100 years)
Contact details	Panasonic Testing Centre, Panasonic Marketing Europe GmbH Winsbergstr 15, 22525 Hamburg, Germany						

\*\* If  $C_{\text{dc}}$  is not determined by measurement then the default degradation coefficient air conditioners shall be 0.25.

\*\*\* Where information relates to multi-split air conditioners, the test result and performance data may be obtained on the basis of the performance of the outdoor unit, with a combination of indoor unit(s) recommended by the manufacturer or importer.

Item	Symbol	Value	Unit	Item	Symbol	Value	Unit
Rated heating capacity	$P_{\text{ref,h}}$	14.0	kW	Seasonal space heating energy efficiency	$\eta_{\text{sh}}$	152.5	%
Refrigeration load	$P_{\text{ref,r,h}}$	14.0	kW	Declared coefficient of performance or gas utilization efficiency / auxiliary energy factor for part load at given outdoor temperatures Tj			
Declared heating capacity for part load at indoor temperature 20 °C and outdoor temperature Tj				Declared coefficient of performance or gas utilization efficiency / auxiliary energy factor for part load at given outdoor temperatures Tj			
Tj = -7 °C		12.3	kW	Tj = -7 °C		2.4	%
Tj = +2 °C		7.5	kW	Tj = +2 °C		3.6	%
Tj = +7 °C		4.8	kW	Tj = +7 °C		5.8	%
Tj = +12 °C		3.7	kW	Tj = +12 °C		7.0	%
$T_{\text{low}}$ = bivalent temperature		12.3	kW	$T_{\text{low}}$ = bivalent temperature	COP <sub>o</sub> of GUE <sub>h,brn</sub> / AEF <sub>h,brn</sub>	2.4	%
$T_{\text{col}}$ = operation limit		8.2	kW	$T_{\text{col}}$ = operation limit		1.7	%
For air-to-water heat pumps: Tj = -15 °C (if T <sub>col</sub> < -20 °C)		-	kW	For water-to-air heat pumps: Tj = -15 °C (if T <sub>col</sub> < -20 °C)		-	%
Bivalent temperature	$T_{\text{bw}}$	-7	°C	For water-to-air heat pumps: Operation limit temperature	$T_{\text{ol}}$	-15	°C
Degradation co-efficient heat pumps**	$C_{\text{dh}}$	0.25	-	Power consumption in modes other than 'active mode'			
Power consumption in modes other than 'active mode'							
Off mode	$P_{\text{off}}$	0.015	kW	Supplementary heater			
Thermostat-off mode	$P_{\text{to}}$	0.000	kW	back-up heating capacity*	eibu	3.3	kW
Crankcase heater mode	$P_{\text{ck}}$	0.000	kW	Type of energy input			
				Standby mode	$P_{\text{sb}}$	0.015	kW
Other items							
Capacity control		variable		For air-to-air heat pumps: air flow rate, outdoor		4980	m³/h
Sound power level, outdoor	$L_{\text{WA}}$	74.0	dB	For water-/brine-to-air heat pumps: Rated brine or water flow rate, outdoor side heat exchanger		-	m³/h
Sound power level, indoor	$L_{\text{WA}}$	52.0	dB	Emissions of nitrogen oxides (if applicable)	$\text{NO}_{\text{x}}$ **	-	mg/kWh fuel input GCV
				GWP of the refrigerant		675	kg CO <sub>2</sub> eq (100 years)
Contact details	Panasonic Testing Centre, Panasonic Marketing Europe GmbH Winsbergstr 15, 22525 Hamburg, Germany						

\*\* If  $C_{\text{dc}}$  is not determined by measurement then the default degradation coefficient of heat pumps shall be 0.25.

\*\*\* Where information relates to multi-split heat pumps, the test result and performance data may be obtained on the basis of the performance of the outdoor unit, with a combination of indoor unit(s) recommended by the manufacturer or importer.

## Information requirements for air-to-air air conditioners

Model(s):	Outdoor Unit Indoor Unit		
	U-125PZ2E8 S-125PU2E5B		
Outdoor side heat exchanger of air conditioner:	air		
Indoor side heat exchanger of air conditioner:	air		
Type: compressor driven vapour compression or sorption process	vapour compression		
if applicable: driver of compressor: [electric motor or fuel driven, gaseous or liquid fuel, internal or external combustion engine]	electric motor		

## Information requirements for heat pumps

Model(s):	Outdoor Unit Indoor Unit		
	U-125PZ2E8 S-125PU2E5B		
Outdoor side heat exchanger of heat pump:	air		
Indoor side heat exchanger of heat pump:	air		
Indication if the heater is equipped with a supplementary heater:	no		
if applicable: driver of compressor: [electric motor or fuel driven, gaseous or liquid fuel, internal or external combustion engine]	electric motor		
Parameters shall be declared for the average heating season, parameters for the warmer and colder heating seasons are optional.			

Item	Symbol	Value	Unit	Item	Symbol	Value	Unit
Rated cooling capacity	$P_{rated,c}$	12.5	kW	Seasonal space cooling energy efficiency	$\eta_{p,c}$	266.1	%
Refrigeration load	$P_{design,r,c}$	12.5	kW	Declared energy efficiency ratio or gas utilization efficiency / auxiliary energy factor for part load at given outdoor temperatures Tj and indoor 27/19°C (dry/wet bulb)			
Declared cooling capacity for part load at given outdoor temperatures Tj and indoor 27/19°C (dry/wet bulb)				Declared energy efficiency ratio or gas utilization efficiency / auxiliary energy factor for part load at given outdoor temperatures Tj			
Tj = +35 °C		12.5	kW	Tj = +35 °C		3.5	%
Tj = +30 °C		9.2	kW	Tj = +30 °C		4.8	%
Tj = +25 °C	$P_{dc}$	5.9	kW	Tj = +25 °C		8.2	%
Tj = +20 °C		4.2	kW	Tj = +20 °C		12.3	%
Degradation co-efficient for air conditioners**	$C_{dc}$	0.25	-	EER <sub>cl</sub> or GUE <sub>cl,dbn</sub> / AEF <sub>cl,dbn</sub>			
Power consumption in modes other than 'active mode'				Power consumption in modes other than 'active mode'			
Off mode	$P_{off}$	0.020	kW	Crankcase heater mode	$P_{ck}$	0.000	kW
Thermostat-off mode	$P_{to}$	0.015	kW	Standby mode	$P_{sb}$	0.020	kW
Other items				Other items			
Capacity control		variable		For air-to-air air conditioner: air flow rate, outdoor		5160	m³/h
Sound power level, outdoor	$L_{WA}$	73.0	dB				
Sound power level, indoor	$L_{WA}$	61.0	dB	if engine driven: Emissions of nitrogen oxides	$NO_x^{***}$	-	mg/kWh fuel input GCV
				GWP of the refrigerant		675	kg CO <sub>2</sub> eq (100 years)
Contact details	Panasonic Testing Centre, Panasonic Marketing Europe GmbH Winsbergweg 15, 22525 Hamburg, Germany						

\*\* If  $C_{dc}$  is not determined by measurement then the default degradation coefficient air conditioners shall be 0.25.  
\*\*\* Where information relates to multi-split air conditioners, the test result and performance data may be obtained on the basis of the performance of the outdoor unit, with a combination of indoor unit(s) recommended by the manufacturer or importer.

Item	Symbol	Value	Unit	Item	Symbol	Value	Unit
Rated heating capacity	$P_{rated,h}$	12.5	kW	Seasonal space heating energy efficiency	$\eta_{p,h}$	157.3	%
Refrigeration load	$P_{design,r,h}$	12.5	kW	Declared coefficient of performance or gas utilization efficiency / auxiliary energy factor for part load at given outdoor temperatures Tj			
Declared heating capacity for part load at indoor temperature 20 °C and outdoor temperature Tj				Declared coefficient of performance or gas utilization efficiency / auxiliary energy factor for part load at given outdoor temperatures Tj			
Tj = -7 °C		11.0	kW	Tj = -7 °C		2.5	%
Tj = +2 °C		6.7	kW	Tj = +2 °C		3.7	%
Tj = +7 °C		4.3	kW	Tj = +7 °C		5.9	%
Tj = +12 °C		3.9	kW	Tj = +12 °C		7.0	%
$T_{biv}$ = bivalent temperature	$P_{bh}$	12.5	kW	$T_{biv}$ = bivalent temperature		2.2	%
$T_{co}$ = operation limit		8.3	kW	$T_{co}$ = operation limit		1.7	%
For air-to-water heat pumps: Tj = -15 °C (if $T_{co} < -20$ °C)		-	kW	For water-to-air heat pumps: Tj = -15 °C (if $T_{co} < -20$ °C)		-	%
Bivalent temperature	$T_{biv}$	-10	°C	For water-to-air heat pumps: Operation limit temperature	$T_{ol}$	-15	°C
Degradation co-efficient heat pumps**	$C_{ch}$	0.25	-	GUE <sub>h,dbn</sub> / AEF <sub>h,dbn</sub>			
Power consumption in modes other than 'active mode'				Power consumption in modes other than 'active mode'			
Off mode	$P_{off}$	0.020	kW	Supplementary heater back-up heating capacity*	$elbu$	0.0	kW
Thermostat-off mode	$P_{to}$	0.015	kW	Type of energy input			
Crankcase heater mode	$P_{ck}$	0.000	kW	Standby mode	$P_{sb}$	0.020	kW
Other items				Other items			
Capacity control		variable		For air-to-air heat pumps: air flow rate, outdoor		4680	m³/h
Sound power level, outdoor	$L_{WA}$	73.0	dB	For water-/brine-to-air heat pumps: Rated brine or water flow rate, outdoor side heat exchanger		-	m³/h
Sound power level, indoor	$L_{WA}$	61.0	dB	Emissions of nitrogen oxides (if applicable)	$NO_x^{***}$	-	mg/kWh fuel input GCV
				GWP of the refrigerant		675	kg CO <sub>2</sub> eq (100 years)
Contact details	Panasonic Testing Centre, Panasonic Marketing Europe GmbH Winsbergweg 15, 22525 Hamburg, Germany						

\*\* If  $C_{ch}$  is not determined by measurement then the default degradation coefficient of heat pumps shall be 0.25.  
\*\*\* Where information relates to multi-split heat pumps, the test result and performance data may be obtained on the basis of the performance of the outdoor unit, with a combination of indoor unit(s) recommended by the manufacturer or importer.

### Information requirements for air-to-air air conditioners

Model(s):	Outdoor Unit Indoor Unit
	U-140PZ2E8 S-140P-U2E5B
Outdoor side heat exchanger of air conditioner:	air
Indoor side heat exchanger of air conditioner:	air
Type: compressor driven vapour compression or sorption process	vapour compression
if applicable: driver of compressor: [electric motor or fuel driven, gaseous or liquid fuel, internal or external combustion engine]	electric motor

Item	Symbol	Value	Unit	Item	Symbol	Value	Unit
Rated cooling capacity	$P_{rated,c}$	14.0	kW	Seasonal space cooling energy efficiency	$\eta_{s,c}$	256.5	%
Refrigeration load	$P_{design,c}$	14.0	kW	Declared energy efficiency ratio or gas utilization efficiency / auxiliary energy factor for part load at given outdoor temperatures Tj and indoor 27/19°C (dry/wet bulb)			
Declared cooling capacity for part load at given outdoor temperatures Tj and indoor 27/19°C (dry/wet bulb)				Declared energy efficiency ratio or gas utilization efficiency / auxiliary energy factor for part load at given outdoor temperatures Tj			
Tj = +35 °C		14.0	kW	Tj = +35 °C		3.2	%
Tj = +30 °C		10.3	kW	Tj = +30 °C	EER <sub>o</sub> or GUE <sub>o,part</sub> /	4.6	%
Tj = +25 °C	P <sub>dc</sub>	6.6	kW	Tj = +25 °C	AEF <sub>o,part</sub>	7.8	%
Tj = +20 °C		4.2	kW	Tj = +20 °C		12.2	%
Degradation co- efficient for air conditioners**	C <sub>dc</sub>	0.25	-	Power consumption in modes other than 'active mode'			
				Off mode			
				P <sub>off</sub>			
				P <sub>to</sub>			
				P <sub>ck</sub>			
				Other items			
Capacity control		variable		For air-to-air air conditioner: air flow rate, outdoor		5340	m³/h
Sound power level, outdoor	L <sub>WA</sub>	74.0	dB				
Sound power level, indoor	L <sub>WA</sub>	62.0	dB	if engine driven: Emissions of nitrogen oxides	NO <sub>x</sub> ***	-	mg/kWh fuel input GCV
				GWP of the refrigerant		675	kg CO <sub>2</sub> eq (100 years)
Contact details	Panasonic Testing Centre, Panasonic Marketing Europe GmbH Winsberggring 15, 22525 Hamburg, Germany						

\*\* If C<sub>dc</sub> is not determined by measurement then the default degradation coefficient air conditioners shall be 0.25.

\*\*\* From 26 September 2018.

Where information relates to multi-split air conditioners, the test result and performance data may be obtained on the basis of the performance of the outdoor unit, with a combination of indoor unit(s) recommended by the manufacturer or importer.

### Information requirements for heat pumps

Model(s):	Outdoor Unit Indoor Unit
	U-140PZ2E8 S-140PU2E5B
Outdoor side heat exchanger of heat pump:	air
Indoor side heat exchanger of heat pump:	air
Indication if the heater is equipped with a supplementary heater:	no
if applicable: driver of compressor: [electric motor or fuel driven, gaseous or liquid fuel, internal or external combustion engine]	electric motor
Parameters shall be declared for the average heating season, parameters for the warmer and colder heating seasons are optional.	

Item	Symbol	Value	Unit	Item	Symbol	Value	Unit
Rated heating capacity	$P_{rated,h}$	14.0	kW	Seasonal space heating energy efficiency	$\eta_{s,h}$	152.4	%
Refrigeration load	$P_{design,h}$	14.0	kW	Declared coefficient of performance or gas utilization efficiency / auxiliary energy factor for part load at given outdoor temperatures Tj			
Declared heating capacity for part load at indoor temperature 20 °C and outdoor temperature Tj				Declared coefficient of performance or gas utilization efficiency / auxiliary energy factor for part load at given outdoor temperatures Tj			
Tj = -7 °C		12.3	kW	Tj = -7 °C		2.4	%
Tj = +2 °C		7.5	kW	Tj = +2 °C		3.6	%
Tj = +7 °C		4.8	kW	Tj = +7 °C		5.8	%
Tj = +12 °C		3.9	kW	Tj = +12 °C		7.0	%
T <sub>bw</sub> = bivalent temperature	P <sub>ch</sub>	12.3	kW	T <sub>bw</sub> = bivalent temperature	COP <sub>o</sub> or GUE <sub>o,part</sub> / AEF <sub>o,part</sub>	2.4	%
T <sub>col</sub> = operation limit		8.6	kW	T <sub>col</sub> = operation limit		1.7	%
For air-to-water heat pumps: Tj = -15 °C (if T <sub>col</sub> < -20 °C)		-	kW	For water-to-air heat pumps: Tj = -15 °C (if T <sub>col</sub> < -20 °C)		-	%
Bivalent temperature	T <sub>bw</sub>	-7	°C	For water-to-air heat pumps: Operation limit temperature	T <sub>col</sub>	-15	°C
Degradation co- efficient heat pumps**	C <sub>ch</sub>	0.25	-	Power consumption in modes other than 'active mode'			
				Off mode			
				P <sub>off</sub>			
				P <sub>to</sub>			
				P <sub>ck</sub>			
				Other items			
Capacity control		variable		For air-to-air heat pumps: air flow rate, outdoor		4980	m³/h
Sound power level, outdoor	L <sub>WA</sub>	74.0	dB	For water-/brine-to-air heat pumps: Rated brine or water flow rate, outdoor side heat exchanger		-	m³/h
Sound power level, indoor	L <sub>WA</sub>	62.0	dB	Emissions of nitrogen oxides (if applicable)	NO <sub>x</sub> ***	-	mg/kWh fuel input GCV
				GWP of the refrigerant		675	kg CO <sub>2</sub> eq (100 years)
Contact details	Panasonic Testing Centre, Panasonic Marketing Europe GmbH Winsberggring 15, 22525 Hamburg, Germany						

\*\* If C<sub>ch</sub> is not determined by measurement then the default degradation coefficient of heat pumps shall be 0.25.

\*\*\* From 26 September 2018.

Where information relates to multi-split heat pumps, the test result and performance data may be obtained on the basis of the performance of the outdoor unit, with a combination of indoor unit(s) recommended by the manufacturer or importer.

Information requirements for air-to-air air conditioners

Model(s):	Outdoor Unit Indoor Unit	U-125P2ZE5 S-60PT2E5B x2
Outdoor side heat exchanger of air conditioner:	air	
Indoor side heat exchanger of air conditioner:	air	
Type: compressor driven vapour compression or sorption process	vapour compression	
If applicable: driver of compressor: (electric motor or fuel driven, gaseous or liquid fuel, internal or external combustion engine)	electric motor	

Item	Symbol	Value	Unit	Item	Symbol	Value	Unit
Rated cooling capacity	$P_{ref,c}$	12.5	kW	Seasonal space cooling energy efficiency	$\eta_{h,c}$	241.4	%
Refrigeration load	$P_{design,c}$	12.5	kW	Declared energy efficiency ratio or gas utilization efficiency / auxiliary energy factor for part load at given outdoor temperatures $T_j$ and indoor 27°/19°C (dry/wet bulb)			
Declared cooling capacity for part load at given outdoor temperatures $T_j$ and indoor 27°/19°C (dry/wet bulb)	$T_j = +35^\circ\text{C}$	12.5	kW	$T_j = +35^\circ\text{C}$	EER <sub>d</sub> or GUE <sub>E,dbn</sub> / AEF <sub>E,dbn</sub>	3.3	%
	$T_j = +30^\circ\text{C}$	9.2	kW	$T_j = +30^\circ\text{C}$		4.5	%
	$T_j = +25^\circ\text{C}$	5.9	kW	$T_j = +25^\circ\text{C}$		7.0	%
	$T_j = +20^\circ\text{C}$	4.1	kW	$T_j = +20^\circ\text{C}$		10.5	%
Degradation co-efficient for air conditioners**	$C_{dc}$	0.25	-	Power consumption in modes other than 'active mode'			
				Off mode			
				Thermostat-off mode			
				Crankcase heater mode			
				Standby mode			
				Other items			
Capacity control		variable		For air-to-air conditioner: air flow rate, outdoor		5160	m³/h
Sound power level, outdoor	$L_{WA}$	73.0	dB				
Sound power level, indoor	$L_{WA}$	56.0	dB	if engine driven: Emissions of nitrogen oxides	NO <sub>x</sub> ***	-	mg/KWh fuel input GCV
				GWP of the refrigerant		675	kg CO <sub>2</sub> eq (100 years)
Contact details				Panasonic Testing Centre, Panasonic Marketing Europe GmbH Winsbergring 15, 22525 Hamburg, Germany			
** If $C_{dc}$ is not determined by measurement then the default degradation coefficient air conditioners shall be 0.25.							
*** from 26 September 2018.							
Where information relates to multi-split air conditioners, the test result and performance data may be obtained on the basis of the performance of the outdoor unit, with a combination of indoor unit(s) recommended by the manufacturer or importer.							
**** Refer to information requirements for UnitList.							

Information requirements for heat pumps

Model(s):	Outdoor Unit Indoor Unit	U-125P2ZE5 S-60PT2E5B x2
Outdoor side heat exchanger of heat pump:	air	
Indoor side heat exchanger of heat pump:	air	
Indication if the heater is equipped with a supplementary heater:	no	
If applicable: driver of compressor: (electric motor or fuel driven, gaseous or liquid fuel, internal or external combustion engine)	electric motor	
Parameters shall be declared for the average heating season, parameters for the warmer and colder heating seasons are optional.		

Item	Symbol	Value	Unit	Item	Symbol	Value	Unit
Rated heating capacity	$P_{ref,h}$	12.5	kW	Seasonal space heating energy efficiency	$\eta_{h,h}$	147.6	%
Refrigeration load	$P_{design,h}$	12.5	kW	Declared coefficient of performance or gas utilization efficiency / auxiliary energy factor for part load at given outdoor temperatures $T_j$			
Declared heating capacity for part load at indoor temperature 20 °C and outdoor temperature $T_j$	$T_j = -7^\circ\text{C}$	11.0	kW	$T_j = -7^\circ\text{C}$		2.2	%
	$T_j = +2^\circ\text{C}$	6.7	kW	$T_j = +2^\circ\text{C}$		3.5	%
	$T_j = +7^\circ\text{C}$	4.3	kW	$T_j = +7^\circ\text{C}$		5.8	%
	$T_j = +12^\circ\text{C}$	3.8	kW	$T_j = +12^\circ\text{C}$		7.1	%
$T_{hw}$ = bivalent temperature	$P_{bh}$	11.0	kW	$T_{hw}$ = bivalent temperature	COP <sub>d</sub> or GUE <sub>E,dbn</sub> / AEF <sub>E,dbn</sub>	2.2	%
$T_{ca}$ = operation limit		7.5	kW	$T_{ca}$ = operation limit		1.5	%
For air-to-water heat pumps: $T_j = -15^\circ\text{C}$ (if $T_{ca} < -20^\circ\text{C}$ )		-	kW	For water-to-air heat pumps: $T_j = -15^\circ\text{C}$ (if $T_{ca} < -20^\circ\text{C}$ )		-	%
Bivalent temperature	$T_{bw}$	-7	°C	For water-to-air heat pumps: Operation limit temperature	$T_{ol}$	-15	°C
Degradation co-efficient heat pumps**	$C_{dh}$	0.25	-	Supplementary heater			
				Power consumption in modes other than 'active mode'			
				Off mode			
				Thermostat-off mode			
				Crankcase heater mode			
				Other items			
Capacity control		variable		For air-to-air heat pumps: air flow rate, outdoor		4680	m³/h
Sound power level, outdoor	$L_{WA}$	73.0	dB	For water-/brine-to-air heat pumps: Rated brine or water flow rate, outdoor side heat exchanger		-	m³/h
Sound power level, indoor	$L_{WA}$	56.0	dB	Emissions of nitrogen oxides (if applicable)	NO <sub>x</sub> ***	-	mg/KWh fuel input GCV
				GWP of the refrigerant		675	kg CO <sub>2</sub> eq (100 years)
Contact details				Panasonic Testing Centre, Panasonic Marketing Europe GmbH Winsbergring 15, 22525 Hamburg, Germany			
** If $C_{dh}$ is not determined by measurement then the default degradation coefficient of heat pumps shall be 0.25.							
*** from 26 September 2018.							
Where information relates to multi-split heat pumps, the test result and performance data may be obtained on the basis of the performance of the outdoor unit, with a combination of indoor unit(s) recommended by the manufacturer or importer.							
**** Refer to information requirements for UnitList.							



## Information requirements for air-to-air air conditioners

Model(s):	U-140PZ2E5 S-71PTZ2E5B x2		
	Outdoor Unit	air	
	Indoor Unit	air	
	Outdoor side heat exchanger of air conditioner:	vapour compression	
	Indoor side heat exchanger of air conditioner:	electric motor	
	Type: compressor driven vapour compression or sorption process		
	If applicable: driver of compressor: [electric motor or fuel driven, gaseous or liquid fuel, internal or external combustion engine]		

Item	Symbol	Value	Unit	Item	Symbol	Value	Unit
Rated cooling capacity	$P_{rated,c}$	14.0	kW	Seasonal space cooling energy efficiency	$\eta_{s,c}$	227.5	%
Refrigeration load	$P_{design,c}$	14.0	kW	Declared energy efficiency ratio or gas utilization efficiency / auxiliary energy factor for part load at given outdoor temperatures $T_j$ and indoor 27°/19°C (dry/wet bulb)			
Declared cooling capacity for part load at given outdoor temperatures $T_j$ and indoor 27°/19°C (dry/wet bulb)	$T_j = +35\text{ °C}$	14.0	kW	$T_j = +35\text{ °C}$	EER <sub>out</sub>	2.9	%
	$T_j = +30\text{ °C}$	10.3	kW	$T_j = +30\text{ °C}$	GUE <sub>in,bin</sub> / AEF <sub>in,bin</sub>	4.3	%
	$T_j = +25\text{ °C}$	6.6	kW	$T_j = +25\text{ °C}$		6.5	%
	$T_j = +20\text{ °C}$	3.8	kW	$T_j = +20\text{ °C}$		10.0	%
Degradation co-efficient for air conditioners**	$C_{dc}$	0.25	-				
Power consumption in modes other than 'active mode'							
Off mode	$P_{off}$	0.012	kW	Crankcase heater mode	$P_{ck}$	0.000	kW
Thermostat-off mode	$P_{to}$	0.000	kW	Standby mode	$P_{sb}$	0.012	kW
Other items							
Capacity control		variable		For air-to-air air conditioner: air flow rate, outdoor		5340	m³/h
Sound power level, outdoor	$L_{WA}$	74.0	dB				
Sound power level, indoor	$L_{WA}$	57.0	dB	if engine driven: Emissions of nitrogen oxides	NO <sub>x</sub> ***	-	mg/kWh fuel input GCV
				GWP of the refrigerant		675	kg CO <sub>2</sub> eq (100 years)
Contact details				Panasonic Testing Centre, Panasonic Marketing Europe GmbH Winsbergiring 15, 22525 Hamburg, Germany			
** If $C_{dc}$ is not determined by measurement then the default degradation coefficient air conditioners shall be 0.25. *** from 26 September 2018. Where information relates to multi-split air conditioners, the test result and performance data may be obtained on the basis of the performance of the outdoor unit, with a combination of indoor unit(s) recommended by the manufacturer or importer. **** Refer to information requirements for UnitILst							

## Information requirements for heat pumps

Model(s):	U-140PZ2E5 S-71PTZ2E5B x2		
	Outdoor Unit	air	
	Indoor Unit	air	
	Outdoor side heat exchanger of heat pump:	air	
	Indoor side heat exchanger of heat pump:	no	
	Indication if the heater is equipped with a supplementary heater:	electric motor	
	If applicable: driver of compressor: [electric motor or fuel driven, gaseous or liquid fuel, internal or external combustion engine]		
	Parameters shall be declared for the average heating season, parameters for the warmer and colder heating seasons are optional.		

Item	Symbol	Value	Unit	Item	Symbol	Value	Unit
Rated heating capacity	$P_{rated,h}$	14.0	kW	Seasonal space heating energy efficiency	$\eta_{s,h}$	145.4	%
Refrigeration load	$P_{design,h}$	13.6	kW	Declared coefficient of performance or gas utilization efficiency / auxiliary energy factor for part load at given outdoor temperatures °C and outdoor temperature $T_j$			
Declared heating capacity for part load at indoor temperature 20 °C and outdoor temperature $T_j$	$T_j = -7\text{ °C}$	12.0	kW	$T_j = -7\text{ °C}$		2.2	%
	$T_j = +2\text{ °C}$	7.3	kW	$T_j = +2\text{ °C}$		3.4	%
	$T_j = +7\text{ °C}$	4.7	kW	$T_j = +7\text{ °C}$		5.8	%
	$T_j = +12\text{ °C}$	3.9	kW	$T_j = +12\text{ °C}$		7.1	%
$T_{bv} =$ bivalent temperature	$P_{bh}$	12.0	kW	$T_{bv} =$ bivalent temperature	COP <sub>h</sub> or GUE <sub>in,bin</sub> / AEF <sub>in,bin</sub>	2.2	%
$T_{ol} =$ operation limit		7.9	kW	$T_{ol} =$ operation limit		1.5	%
For air-to-water heat pumps: $T_j = -15\text{ °C}$ (if $T_{ol} < -20\text{ °C}$ )		-	kW	For water-to-air heat pumps: $T_j = -15\text{ °C}$ (if $T_{ol} < -20\text{ °C}$ )		-	%
Bivalent temperature	$T_{bv}$	-7	°C	For water-to-air heat pumps: Operation limit temperature	$T_{ol}$	-15	°C
Degradation co-efficient heat pumps**	$C_{dh}$	0.25	-				
Power consumption in modes other than 'active mode'							
Off mode	$P_{off}$	0.012	kW	Supplementary heater back-up heating capacity*	elbu	3.2	kW
Thermostat-off mode	$P_{to}$	0.000	kW	Type of energy input			
Crankcase heater mode	$P_{ck}$	0.000	kW	Standby mode	$P_{sb}$	0.015	kW
Other items							
Capacity control		variable		For air-to-air heat pumps: air flow rate outdoor		4980	m³/h
Sound power level, outdoor	$L_{WA}$	74.0	dB	For water-/brine-to-air heat pumps: Rated brine or water flow rate, outdoor side heat exchanger		-	m³/h
Sound power level, indoor	$L_{WA}$	57.0	dB	Emissions of nitrogen oxides (if applicable)	NO <sub>x</sub> ***	-	mg/kWh fuel input GCV
				GWP of the refrigerant		675	kg CO <sub>2</sub> eq (100 years)
Contact details				Panasonic Testing Centre, Panasonic Marketing Europe GmbH Winsbergiring 15, 22525 Hamburg, Germany			
** If $C_{dh}$ is not determined by measurement then the default degradation coefficient of heat pumps shall be 0.25. *** from 26 September 2018. Where information relates to multi-split heat pumps, the test result and performance data may be obtained on the basis of the performance of the outdoor unit, with a combination of indoor unit(s) recommended by the manufacturer or importer. **** Refer to information requirements for UnitILst							

Information requirements for air-to-air air conditioners

Model(s): Outdoor Unit U-125P2ZE5  
Indoor Unit S-125PT2E5B

Outdoor side heat exchanger of air conditioner:  
Indoor side heat exchanger of air conditioner:  
Type: compressor driven vapour compression or sorption process  
if applicable: driver of compressor: (electric motor or fuel driven, gaseous or liquid fuel, internal or external combustion engine)  
electric motor

Item	Symbol	Value	Unit	Item	Symbol	Value	Unit
Rated cooling capacity	$P_{rated,c}$	12.5	kW	Seasonal space cooling energy efficiency	$\eta_{h,c}$	227.8	%
Refrigeration load	$P_{design,c}$	12.5	kW	Declared energy efficiency ratio or gas utilization efficiency / auxiliary energy factor for part load at given outdoor temperatures $T_j$ and indoor 27°/19°C (dry/wet bulb)			
Declared cooling capacity for part load at given outdoor temperatures $T_j$ and indoor 27°/19°C (dry/wet bulb)							
$T_j = +35\text{ °C}$		12.5	kW	$T_j = +35\text{ °C}$		3.3	%
$T_j = +30\text{ °C}$		9.2	kW	$T_j = +30\text{ °C}$	$EER_{p,cl}$ or $GUE_{cl,bln}$	4.5	%
$T_j = +25\text{ °C}$	$P_{dc}$	5.9	kW	$T_j = +25\text{ °C}$	$GUE_{cl,bln}$ / $AEF_{cl,bln}$	7.0	%
$T_j = +20\text{ °C}$		4.1	kW	$T_j = +20\text{ °C}$		11.3	%
Degradation co-efficient for air conditioners**	$C_{dc}$	0.25	-				
Power consumption in modes other than 'active mode'							
Off mode	$P_{off}$	0.017	kW	Crankcase heater mode	$P_{ck}$	0.000	kW
Thermostat-off mode	$P_{to}$	0.125	kW	Standby mode	$P_{sb}$	0.017	kW
Other items							
Capacity control		variable		For air-to-air air conditioner: air flow rate, outdoor		5160	m³/h
Sound power level, outdoor	$L_{WA}$	73.0	dB				
Sound power level, indoor	$L_{WA}$	64.0	dB	if engine driven: Emissions of nitrogen oxides	$NO_x^{***}$	-	mg/kWh fuel input GCV
				GWP of the refrigerant		675	kg CO <sub>2</sub> eq (100 years)
Contact details Panasonic Testing Centre, Panasonic Marketing Europe GmbH Winsbergring 15, 22525 Hamburg, Germany							
*** If $C_{dc}$ is not determined by measurement then the default degradation coefficient air conditioners shall be 0.25. *** from 26 September 2018. Where information relates to multi-split air conditioners, the test result and performance data may be obtained on the basis of the performance of the outdoor unit, with a combination of indoor unit(s) recommended by the manufacturer or importer. **** Refer to information requirements for UnitList.							

Information requirements for heat pumps

Model(s): Outdoor Unit U-125P2ZE5  
Indoor Unit S-125PT2E5B

Outdoor side heat exchanger of heat pump:  
Indoor side heat exchanger of heat pump:  
Indication if the heater is equipped with a supplementary heater:  
if applicable: driver of compressor: (electric motor or fuel driven, gaseous or liquid fuel, internal or external combustion engine)  
electric motor

Parameters shall be declared for the average heating season, parameters for the warmer and colder heating seasons are optional.

Item	Symbol	Value	Unit	Item	Symbol	Value	Unit
Rated heating capacity	$P_{rated,h}$	12.5	kW	Seasonal space heating energy efficiency	$\eta_{h,h}$	146.9	%
Refrigeration load	$P_{design,h}$	12.5	kW	Declared coefficient of performance or gas utilization efficiency / auxiliary energy factor for part load at given outdoor temperatures $T_j$			
Declared heating capacity for part load at indoor temperature 20 °C and outdoor temperature $T_j$							
$T_j = -7\text{ °C}$		11.0	kW	$T_j = -7\text{ °C}$		2.2	%
$T_j = +2\text{ °C}$		6.7	kW	$T_j = +2\text{ °C}$		3.5	%
$T_j = +7\text{ °C}$		4.3	kW	$T_j = +7\text{ °C}$		5.8	%
$T_j = +12\text{ °C}$		3.8	kW	$T_j = +12\text{ °C}$		7.1	%
$T_{bv}$ = bivalent temperature	$P_{bh}$	11.0	kW	$T_{bv}$ = bivalent temperature	$GUE_{h,bln}$ / $AEF_{h,bln}$	2.2	%
$T_{ol}$ = operation limit		8.0	kW	$T_{ol}$ = operation limit		1.5	%
For air-to-water heat pumps: $T_j = -15\text{ °C}$ (if $T_{Ox} < -20\text{ °C}$ )		-	kW	For water-to-air heat pumps: $T_j = -15\text{ °C}$ (if $T_{Ox} < -20\text{ °C}$ )		-	%
Bivalent temperature	$T_{bw}$	-7	°C	For water-to-air heat pumps: Operation limit temperature	$T_{ol}$	-15	°C
Degradation co-efficient heat pumps**	$C_{dh}$	0.25	-				
Power consumption in modes other than 'active mode'							
Off mode	$P_{off}$	0.017	kW	Supplementary heater back-up heating capacity*	$e_{bu}$	2.7	kW
Thermostat-off mode	$P_{to}$	0.125	kW	Type of energy input			
Crankcase heater mode	$P_{ck}$	0.000	kW	Standby mode	$P_{sb}$	0.017	kW
Other items							
Capacity control		variable		For air-to-air heat pumps: air flow rate, outdoor		4680	m³/h
Sound power level, outdoor	$L_{WA}$	73.0	dB	For water-/brine-to-air heat pumps: Rated brine or water flow rate, outdoor side heat exchanger		-	m³/h
Sound power level, indoor	$L_{WA}$	64.0	dB	Emissions of nitrogen oxides (if applicable)	$NO_x^{***}$	-	mg/kWh fuel input GCV
				GWP of the refrigerant		675	kg CO <sub>2</sub> eq (100 years)
Contact details Panasonic Testing Centre, Panasonic Marketing Europe GmbH Winsbergring 15, 22525 Hamburg, Germany							
** If $C_{dh}$ is not determined by measurement then the default degradation coefficient of heat pumps shall be 0.25. *** from 26 September 2018. Where information relates to multi-split heat pumps, the test result and performance data may be obtained on the basis of the performance of the outdoor unit, with a combination of indoor unit(s) recommended by the manufacturer or importer. **** Refer to information requirements for UnitList.							

## Information requirements for air-to-air air conditioners

Model(s):	U-140PZ2E5 S-140PT2E5B		
	Outdoor Unit	Indoor Unit	
Outdoor side heat exchanger of air conditioner:	air		
Indoor side heat exchanger of air conditioner:	air		
Type: compressor driven vapour compression or sorption process	vapour compression		
If applicable: driver of compressor: [electric motor or fuel driven, gaseous or liquid fuel, internal or external combustion engine]	electric motor		

Item	Symbol	Value	Unit	Item	Symbol	Value	Unit
Rated cooling capacity	$P_{rated,c}$	14.0	kW	Seasonal space cooling energy efficiency	$\eta_{s,c}$	216.6	%
Refrigeration load	$P_{design,c}$	14.0	kW	Declared energy efficiency ratio or gas utilization efficiency / auxiliary energy factor for part load at given outdoor temperatures $T_j$ and indoor 27°/19°C (dry/wet bulb)			
Declared cooling capacity for part load at given outdoor temperatures $T_j$ and indoor 27°/19°C (dry/wet bulb)	$T_j = +35\text{ °C}$	14.0	kW	$T_j = +35\text{ °C}$		2.9	%
	$T_j = +30\text{ °C}$	10.3	kW	$T_j = +30\text{ °C}$	$EER_{v,of}$	4.3	%
	$T_j = +25\text{ °C}$	6.6	kW	$T_j = +25\text{ °C}$	$GUE_{v,ban}$	6.5	%
	$T_j = +20\text{ °C}$	3.8	kW	$T_j = +20\text{ °C}$	$AEF_{v,ban}$	10.9	%
Degradation co-efficient for air conditioners**	$C_{dc}$	0.25	-	$T_{sw} = \text{bivalent temperature}$			
				$T_{ca} = \text{operation limit}$			
				For air-to-water heat pumps: $T_j = -15\text{ °C}$ (if $T_{Ox} < -20\text{ °C}$ )			
				Bivalent temperature	$T_{bv}$	-7	°C
				Degradation co-efficient heat pumps**	$C_{dh}$	0.25	-
				Power consumption in modes other than 'active mode'			
Off mode	$P_{off}$	0.017	kW	Crankcase heater mode	$P_{ck}$	0.000	kW
Thermostat-off mode	$P_{ro}$	0.135	kW	Standby mode	$P_{sb}$	0.017	kW
				Other items			
Capacity control		variable		For air-to-air air conditioner: air flow rate, outdoor		5340	m³/h
Sound power level, outdoor	$L_{WA}$	74.0	dB				
Sound power level, indoor	$L_{WA}$	65.0	dB	if engine driven: Emissions of nitrogen oxides	$NO_x^{***}$	-	mg/kWh fuel input GCV
				GWP of the refrigerant		675	kg CO <sub>2</sub> eq (100 years)
Contact details	Panasonic Testing Centre, Panasonic Marketing Europe GmbH Winsberg 15, 22525 Hamburg, Germany						
** If $C_{dc}$ is not determined by measurement then the default degradation coefficient air conditioners shall be 0.25. *** from 26 September 2018. Where information relates to multi-split air conditioners, the test result and performance data may be obtained on the basis of the performance of the outdoor unit, with a combination of indoor unit(s) recommended by the manufacturer or importer. **** Refer to information requirements for UnitLit.							

## Information requirements for heat pumps

Model(s):	U-140PZ2E5 S-140PT2E5B		
	Outdoor Unit	Indoor Unit	
Outdoor side heat exchanger of heat pump:	air		
Indoor side heat exchanger of heat pump:	air		
Indication if the heater is equipped with a supplementary heater:	no		
If applicable: driver of compressor: [electric motor or fuel driven, gaseous or liquid fuel, internal or external combustion engine]	electric motor		

Parameters shall be declared for the average heating season, parameters for the warmer and colder heating seasons are optional.

Item	Symbol	Value	Unit	Item	Symbol	Value	Unit
Rated heating capacity	$P_{rated,h}$	14.0	kW	Seasonal space heating energy efficiency	$\eta_{s,h}$	144.8	%
Refrigeration load	$P_{design,h}$	13.6	kW	Declared coefficient of performance or gas utilization efficiency / auxiliary energy factor for part load at given outdoor temperatures °C and outdoor temperature $T_j$			
Declared heating capacity for part load at indoor temperature 20 °C and outdoor temperature $T_j$	$T_j = -7\text{ °C}$	12.0	kW	$T_j = -7\text{ °C}$		2.2	%
	$T_j = +2\text{ °C}$	7.3	kW	$T_j = +2\text{ °C}$		3.4	%
	$T_j = +7\text{ °C}$	4.7	kW	$T_j = +7\text{ °C}$		5.8	%
	$T_j = +12\text{ °C}$	3.9	kW	$T_j = +12\text{ °C}$		7.1	%
$T_{sw} = \text{bivalent temperature}$	$P_{bh}$	12.0	kW	$T_{sw} = \text{bivalent temperature}$	$GUE_{h,ban}$	2.2	%
$T_{ca} = \text{operation limit}$		8.4	kW	$T_{ca} = \text{operation limit}$	$AEF_{h,ban}$	1.5	%
For air-to-water heat pumps: $T_j = -15\text{ °C}$ (if $T_{Ox} < -20\text{ °C}$ )		-	kW	For water-to-air heat pumps: $T_j = -15\text{ °C}$ (if $T_{Ox} < -20\text{ °C}$ )		-	%
Bivalent temperature	$T_{bv}$	-7	°C	For water-to-air heat pumps: Operation limit temperature	$T_{ol}$	-15	°C
Degradation co-efficient heat pumps**	$C_{dh}$	0.25	-	Supplementary heater			
Power consumption in modes other than 'active mode'				back-up heating capacity*	$e_{bu}$	3.0	kW
Off mode	$P_{off}$	0.017	kW	Type of energy input			
Thermostat-off mode	$P_{ro}$	0.135	kW	Standby mode	$P_{sb}$	0.017	kW
Crankcase heater mode	$P_{ck}$	0.000	kW	Other items			
Capacity control		variable		For air-to-air heat pumps: air flow rate outdoor		4980	m³/h
Sound power level, outdoor	$L_{WA}$	74.0	dB	For water-/brine-to-air heat pumps: Rated brine or water flow rate, outdoor side heat exchanger		-	m³/h
Sound power level, indoor	$L_{WA}$	65.0	dB	Emissions of nitrogen oxides (if applicable)	$NO_x^{***}$	-	mg/kWh fuel input GCV
				GWP of the refrigerant		675	kg CO <sub>2</sub> eq (100 years)
Contact details	Panasonic Testing Centre, Panasonic Marketing Europe GmbH Winsberg 15, 22525 Hamburg, Germany						
** If $C_{dh}$ is not determined by measurement then the default degradation coefficient of heat pumps shall be 0.25. *** from 26 September 2018. Where information relates to multi-split heat pumps, the test result and performance data may be obtained on the basis of the performance of the outdoor unit, with a combination of indoor unit(s) recommended by the manufacturer or importer. **** Refer to information requirements for UnitLit.							

Information requirements for air-to-air air conditioners

Model(s): U-125PZ2E8  
S-60PT2E5B x2

Outdoor Unit  
Indoor Unit

Outdoor side heat exchanger of air conditioner:  
Indoor side heat exchanger of air conditioner:  
Type: compressor driven vapour compression or sorption process  
if applicable: driver of compressor: (electric motor or fuel driven, gaseous or liquid fuel, internal or external combustion engine)  
electric motor

Item	Symbol	Value	Unit	Item	Symbol	Value	Unit
Rated cooling capacity	$P_{rated,c}$	12.5	kW	Seasonal space cooling energy efficiency	$\eta_{s,c}$	240.5	%
Refrigeration load	$P_{design,c}$	12.5	kW	Declared energy efficiency ratio or gas utilization efficiency / auxiliary energy factor for part load at given outdoor temperatures $T_j$ and indoor 27°/19°C (dry/wet bulb)			
Declared cooling capacity for part load at given outdoor temperatures $T_j$ and indoor 27°/19°C (dry/wet bulb)							
$T_j = +35\text{ °C}$		12.5	kW	$T_j = +35\text{ °C}$		3.3	%
$T_j = +30\text{ °C}$		9.2	kW	$T_j = +30\text{ °C}$	EER <sub>cl</sub> or GUE <sub>cl,bin</sub> / AEF <sub>cl,bin</sub>	4.5	%
$T_j = +25\text{ °C}$	$P_{dc}$	5.9	kW	$T_j = +25\text{ °C}$		7.0	%
$T_j = +20\text{ °C}$		4.1	kW	$T_j = +20\text{ °C}$		10.5	%
Degradation co-efficient for air conditioners**	$C_{dc}$	0.25	-				
Power consumption in modes other than 'active mode'							
Off mode	$P_{off}$	0.015	kW	Crankcase heater mode	$P_{ck}$	0.000	kW
Thermostat-off mode	$P_{to}$	0.000	kW	Standby mode	$P_{sb}$	0.015	kW
Other items							
Capacity control		variable		For air-to-air air conditioner: air flow rate, outdoor		5160	m³/h
Sound power level, outdoor	$L_{WA}$	73.0	dB				
Sound power level, indoor	$L_{WA}$	56.0	dB	if engine driven: Emissions of nitrogen oxides	NO <sub>x</sub> ***	-	mg/kWh fuel input GCV
				GWP of the refrigerant		675	kg CO <sub>2</sub> eq (100 years)
Contact details Panasonic Testing Centre, Panasonic Marketing Europe GmbH Winsbergring 15, 22525 Hamburg, Germany							
*** If $C_{dc}$ is not determined by measurement then the default degradation coefficient air conditioners shall be 0.25. *** from 26 September 2018. Where information relates to multi-split air conditioners, the test result and performance data may be obtained on the basis of the performance of the outdoor unit, with a combination of indoor unit(s) recommended by the manufacturer or importer. **** Refer to information requirements for UnitList							

Information requirements for heat pumps

Model(s): U-125PZ2E8  
S-60PT2E5B x2

Outdoor Unit  
Indoor Unit

Outdoor side heat exchanger of heat pump:  
Indoor side heat exchanger of heat pump:  
Indication if the heater is equipped with a supplementary heater:  
if applicable: driver of compressor: (electric motor or fuel driven, gaseous or liquid fuel, internal or external combustion engine)  
electric motor

Parameters shall be declared for the average heating season, parameters for the warmer and colder heating seasons are optional.

Item	Symbol	Value	Unit	Item	Symbol	Value	Unit
Rated heating capacity	$P_{rated,h}$	12.5	kW	Seasonal space heating energy efficiency	$\eta_{s,h}$	147.6	%
Refrigeration load	$P_{design,h}$	12.5	kW	Declared coefficient of performance or gas utilization efficiency / auxiliary energy factor for part load at given outdoor temperatures $T_j$			
Declared heating capacity for part load at indoor temperature 20 °C and outdoor temperature $T_j$							
$T_j = -7\text{ °C}$		11.0	kW	$T_j = -7\text{ °C}$		2.2	%
$T_j = +2\text{ °C}$		6.7	kW	$T_j = +2\text{ °C}$		3.5	%
$T_j = +7\text{ °C}$		4.3	kW	$T_j = +7\text{ °C}$		5.8	%
$T_j = +12\text{ °C}$		3.8	kW	$T_j = +12\text{ °C}$		7.1	%
$T_{bw}$ = bivalent temperature	$P_{bh}$	11.0	kW	$T_{bw}$ = bivalent temperature	COP <sub>d</sub> or GUE <sub>cl,bin</sub> / AEF <sub>cl,bin</sub>	2.2	%
$T_{oa}$ = operation limit		7.5	kW	$T_{oa}$ = operation limit		1.5	%
For air-to-water heat pumps: $T_j = -15\text{ °C}$ (if $T_{oa} < -20\text{ °C}$ )		-	kW	For water-to-air heat pumps: $T_j = -15\text{ °C}$ (if $T_{oa} < -20\text{ °C}$ )		-	%
Bivalent temperature	$T_{bw}$	-7	°C	For water-to-air heat pumps: Operation limit temperature	$T_{oa}$	-15	°C
Degradation co-efficient heat pumps**	$C_{bh}$	0.25	-				
Power consumption in modes other than 'active mode'							
Off mode	$P_{off}$	0.015	kW	Supplementary heater back-up heating capacity *	eibu	2.9	kW
Thermostat-off mode	$P_{to}$	0.000	kW	Type of energy input			
Crankcase heater mode	$P_{ck}$	0.000	kW	Standby mode	$P_{sb}$	0.015	kW
Other items							
Capacity control		variable		For air-to-air heat pumps: air flow rate, outdoor		4680	m³/h
Sound power level, outdoor	$L_{WA}$	73.0	dB	For water-/brine-to-air heat pumps: Rated brine or water flow rate, outdoor side heat exchanger		-	m³/h
Sound power level, indoor	$L_{WA}$	56.0	dB	Emissions of nitrogen oxides (if applicable)	NO <sub>x</sub> ***	-	mg/kWh fuel input GCV
				GWP of the refrigerant		675	kg CO <sub>2</sub> eq (100 years)
Contact details Panasonic Testing Centre, Panasonic Marketing Europe GmbH Winsbergring 15, 22525 Hamburg, Germany							
** If $C_{bh}$ is not determined by measurement then the default degradation coefficient of heat pumps shall be 0.25. *** from 26 September 2018. Where information relates to multi-split heat pumps, the test result and performance data may be obtained on the basis of the performance of the outdoor unit, with a combination of indoor unit(s) recommended by the manufacturer or importer. **** Refer to information requirements for UnitList							

## Information requirements for air-to-air air conditioners

Model(s):	Outdoor Unit Indoor Unit	U-140PZ2E8 S-71PT2E5B x2
Outdoor side heat exchanger of air conditioner:	air	
Indoor side heat exchanger of air conditioner:	air	
Type: compressor driven vapour compression or sorption process	vapour compression	
If applicable: driver of compressor: [electric motor or fuel driven, gaseous or liquid fuel, internal or external combustion engine]	electric motor	

Item	Symbol	Value	Unit	Item	Symbol	Value	Unit
Rated cooling capacity	$P_{rated,c}$	14.0	kW	Seasonal space cooling energy efficiency	$\eta_{h,c}$	226.9	%
Refrigeration load	$P_{design,c}$	14.0	kW	Declared energy efficiency ratio or gas utilization efficiency / auxiliary energy factor for part load at given outdoor temperatures $T_j$ and indoor 27°/19°C (dry/wet bulb)			
Declared cooling capacity for part load at given outdoor temperatures $T_j$ and indoor 27°/19°C (dry/wet bulb)	$T_j = +35\text{ °C}$	14.0	kW	$T_j = +35\text{ °C}$	EER <sub>o,of</sub>	2.9	%
	$T_j = +30\text{ °C}$	10.3	kW	$T_j = +30\text{ °C}$	GUE <sub>h,an</sub> / AEF <sub>h,an</sub>	4.3	%
	$T_j = +25\text{ °C}$	6.6	kW	$T_j = +25\text{ °C}$		6.5	%
	$T_j = +20\text{ °C}$	3.8	kW	$T_j = +20\text{ °C}$		10.0	%
Degradation co-efficient for air conditioners**	$C_{dc}$	0.25	-				
Power consumption in modes other than 'active mode'							
Off mode	$P_{off}$	0.015	kW	Crankcase heater mode	$P_{ck}$	0.000	kW
Thermostat-off mode	$P_{to}$	0.000	kW	Standby mode	$P_{sb}$	0.015	kW
Other items							
Capacity control		variable		For air-to-air air conditioner: air flow rate, outdoor		5340	m³/h
Sound power level, outdoor	$L_{WA}$	74.0	dB				
Sound power level, indoor	$L_{WA}$	57.0	dB	if engine driven: Emissions of nitrogen oxides	$NO_x^{***}$	-	mg/kWh fuel input GCV
				GWP of the refrigerant		675	kg CO <sub>2</sub> eq (100 years)
Contact details				Panasonic Testing Centre, Panasonic Marketing Europe GmbH Winsbergring 15, 22525 Hamburg, Germany			
** If $C_{dc}$ is not determined by measurement then the default degradation coefficient air conditioners shall be 0.25. *** from 26 September 2018. Where information relates to multi-split air conditioners, the test result and performance data may be obtained on the basis of the performance of the outdoor unit, with a combination of indoor unit(s) recommended by the manufacturer or importer. **** Refer to information requirements for UnitList							

## Information requirements for heat pumps

Model(s):	Outdoor Unit Indoor Unit	U-140PZ2E8 S-71PT2E5B x2
Outdoor side heat exchanger of heat pump:	air	
Indoor side heat exchanger of heat pump:	air	
Indication if the heater is equipped with a supplementary heater:	no	
If applicable: driver of compressor: [electric motor or fuel driven, gaseous or liquid fuel, internal or external combustion engine]	electric motor	

Parameters shall be declared for the average heating season, parameters for the warmer and colder heating seasons are optional.

Item	Symbol	Value	Unit	Item	Symbol	Value	Unit
Rated heating capacity	$P_{rated,h}$	14.0	kW	Seasonal space heating energy efficiency	$\eta_{h,h}$	145.4	%
Refrigeration load	$P_{design,h}$	13.6	kW	Declared coefficient of performance or gas utilization efficiency / auxiliary energy factor for part load at given outdoor temperatures °C and outdoor temperature $T_j$			
Declared heating capacity for part load at indoor temperature 20 °C and outdoor temperature $T_j$	$T_j = -7\text{ °C}$	12.0	kW	$T_j = -7\text{ °C}$		2.2	%
	$T_j = +2\text{ °C}$	7.3	kW	$T_j = +2\text{ °C}$		3.4	%
	$T_j = +7\text{ °C}$	4.7	kW	$T_j = +7\text{ °C}$		5.8	%
	$T_j = +12\text{ °C}$	3.9	kW	$T_j = +12\text{ °C}$		7.1	%
$T_{bw}$ = bivalent temperature	$P_{bh}$	12.0	kW	$T_{bw}$ = bivalent temperature	COP <sub>o,of</sub> or GUE <sub>h,an</sub> / AEF <sub>h,an</sub>	2.2	%
$T_{oa}$ = operation limit		7.9	kW	$T_{oa}$ = operation limit		1.5	%
For air-to-water heat pumps: $T_j = -15\text{ °C}$ (if $T_{oa} < -20\text{ °C}$ )		-	kW	For water-to-air heat pumps: $T_j = -15\text{ °C}$ (if $T_{oa} < -20\text{ °C}$ )		-	%
Bivalent temperature	$T_{bw}$	-7	°C	For water-to-air heat pumps: Operation limit temperature	$T_{ol}$	-15	°C
Degradation co-efficient heat pumps**	$C_{dh}$	0.25	-				
Power consumption in modes other than 'active mode'							
Off mode	$P_{off}$	0.015	kW	Supplementary heater back-up heating capacity *	elbu	3.2	kW
Thermostat-off mode	$P_{to}$	0.000	kW	Type of energy input			
Crankcase heater mode	$P_{ck}$	0.000	kW	Standby mode	$P_{sb}$	0.015	kW
Other items							
Capacity control		variable		For air-to-air heat pumps: air flow rate, outdoor		4980	m³/h
Sound power level, outdoor	$L_{WA}$	74.0	dB	For water-/brine-to-air heat pumps: Rated brine or water flow rate, outdoor side heat exchanger		-	m³/h
Sound power level, indoor	$L_{WA}$	57.0	dB	Emissions of nitrogen oxides (if applicable)	$NO_x^{***}$	-	mg/kWh fuel input GCV
				GWP of the refrigerant		675	kg CO <sub>2</sub> eq (100 years)
Contact details				Panasonic Testing Centre, Panasonic Marketing Europe GmbH Winsbergring 15, 22525 Hamburg, Germany			
** If $C_{dh}$ is not determined by measurement then the default degradation coefficient of heat pumps shall be 0.25. *** from 26 September 2018. Where information relates to multi-split heat pumps, the test result and performance data may be obtained on the basis of the performance of the outdoor unit, with a combination of indoor unit(s) recommended by the manufacturer or importer. **** Refer to information requirements for UnitList							

Information requirements for air-to-air air conditioners

Model(s):		Outdoor Unit Indoor Unit	
		U-125PZ2E8 S-125PT2E5B	
Outdoor side heat exchanger of air conditioner:			
Indoor side heat exchanger of air conditioner:			
Type: compressor driven vapour compression or sorption process			
if applicable: driver of compressor: [electric motor or fuel driven, gaseous or liquid fuel, internal or external combustion engine]			
electric motor			

Information requirements for heat pumps

Model(s):		Outdoor Unit Indoor Unit	
		U-125PZ2E8 S-125PT2E5B	
Outdoor side heat exchanger of heat pump:			
Indoor side heat exchanger of heat pump:			
Indication if the heater is equipped with a supplementary heater:			
if applicable: driver of compressor: [electric motor or fuel driven, gaseous or liquid fuel, internal or external combustion engine]			
Parameters shall be declared for the average heating season, parameters for the warmer and colder heating seasons are optional.			
electric motor			

Item	Symbol	Value	Unit	Item	Symbol	Value	Unit
Rated cooling capacity	$P_{rated,c}$	12.5	kW	Seasonal space cooling energy efficiency	$\eta_{s,c}$	227.1	%
Refrigeration load	$P_{design,c}$	12.5	kW	Declared energy efficiency ratio or gas utilization efficiency / auxiliary energy factor for part load at given outdoor temperatures $T_J$ and indoor 27°/19°C (dry/wet bulb)			
Declared cooling capacity for part load at given outdoor temperatures $T_J$ and indoor 27°/19°C (dry/wet bulb)							
$T_J = +35\text{ °C}$		12.5	kW	$T_J = +35\text{ °C}$		3.3	%
$T_J = +30\text{ °C}$		9.2	kW	$T_J = +30\text{ °C}$	$EER_{p,or}$	4.5	%
$T_J = +25\text{ °C}$	$P_{dc}$	5.9	kW	$T_J = +25\text{ °C}$	$GUE_{E,dbn} / AEF_{E,dbn}$	7.0	%
$T_J = +20\text{ °C}$		4.1	kW	$T_J = +20\text{ °C}$		11.3	%
Degradation co-efficient for air conditioners**	$C_{dc}$	0.25	-				
Power consumption in modes other than 'active mode'							
Off mode	$P_{off}$	0.020	kW	Crankcase heater mode	$P_{ck}$	0.000	kW
Thermostat-off mode	$P_{ro}$	0.125	kW	Standby mode	$P_{sb}$	0.020	kW
Other items							
Capacity control		variable		For air-to-air air conditioner: air flow rate, outdoor		5160	m³/h
Sound power level, outdoor	$L_{WA}$	73.0	dB				
Sound power level, indoor	$L_{WA}$	64.0	dB	if engine driven: Emissions of nitrogen oxides	$NO_x^{***}$	-	mg/kWh fuel input GCV
				GWP of the refrigerant		675	kg CO <sub>2</sub> eq (100 years)
Contact details				Panasonic Testing Centre, Panasonic Marketing Europe GmbH Winsbergring 15, 22525 Hamburg, Germany			
*** If $C_{dc}$ is not determined by measurement then the default degradation coefficient air conditioners shall be 0.25.							
*** from 26 September 2018.							
Where information relates to multi-split air conditioners, the test result and performance data may be obtained on the basis of the performance of the outdoor unit, with a combination of indoor unit(s) recommended by the manufacturer or importer.							
**** Refer to information requirements for UnitList							

Item	Symbol	Value	Unit	Item	Symbol	Value	Unit
Rated heating capacity	$P_{rated,h}$	12.5	kW	Seasonal space heating energy efficiency	$\eta_{s,h}$	146.9	%
Refrigeration load	$P_{design,h}$	12.5	kW	Declared coefficient of performance or gas utilization efficiency / auxiliary energy factor for part load at given outdoor temperatures $T_J$			
Declared heating capacity for part load at indoor temperature 20 °C and outdoor temperature $T_J$							
$T_J = -7\text{ °C}$		11.0	kW	$T_J = -7\text{ °C}$		2.2	%
$T_J = +2\text{ °C}$		6.7	kW	$T_J = +2\text{ °C}$		3.5	%
$T_J = +7\text{ °C}$		4.3	kW	$T_J = +7\text{ °C}$		5.8	%
$T_J = +12\text{ °C}$		3.8	kW	$T_J = +12\text{ °C}$		7.1	%
$T_{bv} = \text{bivalent temperature}$	$P_{bh}$	11.0	kW	$T_{bv} = \text{bivalent temperature}$	$COP_{p,or} / GUE_{E,dbn} / AEF_{E,dbn}$	2.2	%
$T_{ol} = \text{operation limit}$		8.0	kW	$T_{ol} = \text{operation limit}$		1.5	%
For air-to-water heat pumps: $T_J = -15\text{ °C}$ (if $T_{ol} < -20\text{ °C}$ )		-	kW	For water-to-air heat pumps: $T_J = -15\text{ °C}$ (if $T_{ol} < -20\text{ °C}$ )		-	%
Bivalent temperature	$T_{bv}$	-7	°C	For water-to-air heat pumps: Operation limit temperature	$T_{ol}$	-15	°C
Degradation co-efficient heat pumps**	$C_{dh}$	0.25	-				
Power consumption in modes other than 'active mode'							
Off mode	$P_{off}$	0.020	kW	back-up heating capacity *	$e_{ibu}$	2.7	kW
Thermostat-off mode	$P_{ro}$	0.125	kW	Type of energy input			
Crankcase heater mode	$P_{ck}$	0.000	kW	Standby mode	$P_{sb}$	0.020	kW
Other items							
Capacity control		variable		For air-to-air heat pumps: air flow rate, outdoor		4680	m³/h
Sound power level, outdoor	$L_{WA}$	73.0	dB	For water-/brine-to-air heat pumps: Rated brine or water flow rate, outdoor side heat exchanger		-	m³/h
Sound power level, indoor	$L_{WA}$	64.0	dB	Emissions of nitrogen oxides (if applicable)	$NO_x^{***}$	-	mg/kWh fuel input GCV
				GWP of the refrigerant		675	kg CO <sub>2</sub> eq (100 years)
Contact details				Panasonic Testing Centre, Panasonic Marketing Europe GmbH Winsbergring 15, 22525 Hamburg, Germany			
** If $C_{dh}$ is not determined by measurement then the default degradation coefficient of heat pumps shall be 0.25.							
*** from 26 September 2018.							
Where information relates to multi-split heat pumps, the test result and performance data may be obtained on the basis of the performance of the outdoor unit, with a combination of indoor unit(s) recommended by the manufacturer or importer.							
**** Refer to information requirements for UnitList							

## Information requirements for air-to-air air conditioners

Model(s):	Outdoor Unit Indoor Unit	U-140PZ2E8 S-140PT2E5B
Outdoor side heat exchanger of air conditioner:	air	
Indoor side heat exchanger of air conditioner:	air	
Type: compressor driven vapour compression or sorption process	vapour compression	
if applicable: driver of compressor: [electric motor or fuel driven, gaseous or liquid fuel, internal or external combustion engine]	electric motor	

Item	Symbol	Value	Unit	Item	Symbol	Value	Unit
Rated cooling capacity	$P_{rated,c}$	14.0	kW	Seasonal space cooling energy efficiency	$\eta_{s,c}$	216.0	%
Refrigeration load	$P_{design,c}$	14.0	kW	Declared energy efficiency ratio or gas utilization efficiency / auxiliary energy factor for part load at given outdoor temperatures $T_J$ and indoor 27°/19°C (dry/wet bulb)			
Declared cooling capacity for part load at given outdoor temperatures $T_J$ and indoor 27°/19°C (dry/wet bulb)	$T_J = +35\text{ °C}$	14.0	kW	$T_J = +35\text{ °C}$	EER <sub>of</sub>	2.9	%
	$T_J = +30\text{ °C}$	10.3	kW	$T_J = +30\text{ °C}$	$GUE_{r,bin} / AEF_{r,bin}$	4.3	%
	$T_J = +25\text{ °C}$	6.6	kW	$T_J = +25\text{ °C}$		6.5	%
	$T_J = +20\text{ °C}$	3.8	kW	$T_J = +20\text{ °C}$		10.9	%
Degradation co-efficient for air conditioners**	$C_{dc}$	0.25	-				
Power consumption in modes other than 'active mode'							
Off mode	$P_{off}$	0.020	kW	Crankcase heater mode	$P_{ck}$	0.000	kW
Thermostat-off mode	$P_{to}$	0.135	kW	Standby mode	$P_{sb}$	0.020	kW
Other items							
Capacity control		variable		For air-to-air air conditioner: air flow rate, outdoor		5340	m³/h
Sound power level, outdoor	$L_{WA}$	74.0	dB				
Sound power level, indoor	$L_{WA}$	65.0	dB	if engine driven: Emissions of nitrogen oxides	$NO_x^{***}$	-	mg/kWh fuel input GCV
				GWP of the refrigerant		675	kg CO <sub>2</sub> eq (100 years)
Contact details				Panasonic Testing Centre, Panasonic Marketing Europe GmbH Winsberg 15, 22525 Hamburg, Germany			

\*\* If  $C_{dc}$  is not determined by measurement then the default degradation coefficient air conditioners shall be 0.25.

\*\*\* from 26 September 2018.

Where information relates to multi-split air conditioners, the test result and performance data may be obtained on the basis of the performance of the outdoor unit, with a combination of indoor unit(s) recommended by the manufacturer or importer.

\*\*\*\* Refer to information requirements for Unit/L Unit

## Information requirements for heat pumps

Model(s):	Outdoor Unit Indoor Unit	U-140PZ2E8 S-140PT2E5B
Outdoor side heat exchanger of heat pump:	air	
Indoor side heat exchanger of heat pump:	air	
Indication if the heater is equipped with a supplementary heater:	no	
if applicable: driver of compressor: [electric motor or fuel driven, gaseous or liquid fuel, internal or external combustion engine]	electric motor	

Parameters shall be declared for the average heating season, parameters for the warmer and colder heating seasons are optional.

Item	Symbol	Value	Unit	Item	Symbol	Value	Unit
Rated heating capacity	$P_{rated,h}$	14.0	kW	Seasonal space heating energy efficiency	$\eta_{s,h}$	144.8	%
Refrigeration load	$P_{design,h}$	13.6	kW	Declared coefficient of performance or gas utilization efficiency / auxiliary energy factor for part load at given outdoor temperatures °C and outdoor temperature $T_J$			
Declared heating capacity for part load at indoor temperature 20 °C and outdoor temperature $T_J$	$T_J = -7\text{ °C}$	12.0	kW	$T_J = -7\text{ °C}$		2.2	%
	$T_J = +2\text{ °C}$	7.3	kW	$T_J = +2\text{ °C}$		3.4	%
	$T_J = +7\text{ °C}$	4.7	kW	$T_J = +7\text{ °C}$		5.8	%
	$T_J = +12\text{ °C}$	3.9	kW	$T_J = +12\text{ °C}$		7.1	%
$T_{bv}$ = bivalent temperature	$P_{bh}$	12.0	kW	$T_{bv}$ = bivalent temperature	$GUE_{r,bin} / AEF_{r,bin}$	2.2	%
$T_{ol}$ = operation limit		8.4	kW	$T_{ol}$ = operation limit		1.5	%
For air-to-water heat pumps: $T_J = -15\text{ °C}$ (if $T_{ol} < -20\text{ °C}$ )		-	kW	For water-to-air heat pumps: $T_J = -15\text{ °C}$ (if $T_{ol} < -20\text{ °C}$ )		-	%
Bivalent temperature	$T_{bv}$	-7	°C	For water-to-air heat pumps: Operation limit temperature	$T_{ol}$	-15	°C
Degradation co-efficient heat pumps**	$C_{dh}$	0.25	-				
Power consumption in modes other than 'active mode'							
Off mode	$P_{off}$	0.020	kW	Supplementary heater back-up heating capacity*	elbu	3.0	kW
Thermostat-off mode	$P_{to}$	0.135	kW	Type of energy input			
Crankcase heater mode	$P_{ck}$	0.000	kW	Standby mode	$P_{sb}$	0.020	kW
Other items							
Capacity control		variable		For air-to-air heat pumps: air flow rate, outdoor		4980	m³/h
Sound power level, outdoor	$L_{WA}$	74.0	dB	For water/brine-to-air heat pumps: Rated brine or water flow rate, outdoor side heat exchanger		-	m³/h
Sound power level, indoor	$L_{WA}$	65.0	dB	Emissions of nitrogen oxides (if applicable)	$NO_x^{***}$	-	mg/kWh fuel input GCV
				GWP of the refrigerant		675	kg CO <sub>2</sub> eq (100 years)
Contact details				Panasonic Testing Centre, Panasonic Marketing Europe GmbH Winsberg 15, 22525 Hamburg, Germany			

\*\* If  $C_{dh}$  is not determined by measurement then the default degradation coefficient of heat pumps shall be 0.25.

\*\*\* from 26 September 2018.

Where information relates to multi-split heat pumps, the test result and performance data may be obtained on the basis of the performance of the outdoor unit, with a combination of indoor unit(s) recommended by the manufacturer or importer.

\*\*\*\* Refer to information requirements for Unit/L Unit

Information requirements for air-to-air air conditioners

Model(s): Outdoor Unit U-125P2ZE5  
Indoor Unit S-60PK2E5Bx2

Outdoor side heat exchanger of air conditioner:  
Indoor side heat exchanger of air conditioner:  
Type: compressor driven vapour compression or sorption process  
if applicable: driver of compressor: (electric motor or fuel driven, gaseous or liquid fuel, internal or external combustion engine)  
electric motor

Item	Symbol	Value	Unit	Item	Symbol	Value	Unit
Rated cooling capacity	P <sub>rated,c</sub>	12.5	kW	Seasonal space cooling energy efficiency	η <sub>s,c</sub>	237.0	%
Refrigeration load	P <sub>design,c</sub>	12.5	kW	Declared energy efficiency ratio or gas utilization efficiency / auxiliary energy factor for part load at given outdoor temperatures T <sub>J</sub> and indoor 27°/19°C (dry/wet bulb)			
Declared cooling capacity for part load at given outdoor temperatures T <sub>J</sub> and indoor 27°/19°C (dry/wet bulb)	T <sub>J</sub> = + 35 °C	12.5	kW	T <sub>J</sub> = + 35 °C	EER <sub>J</sub> or GUE <sub>J,dbn</sub> / AEF <sub>J,dbn</sub>	3.2	%
	T <sub>J</sub> = + 30 °C	9.2	kW	T <sub>J</sub> = + 30 °C		4.4	%
	T <sub>J</sub> = + 25 °C	5.9	kW	T <sub>J</sub> = + 25 °C		7.1	%
	T <sub>J</sub> = + 20 °C	4.5	kW	T <sub>J</sub> = + 20 °C		10.1	%
Degradation co-efficient for air conditioners**	C <sub>dc</sub>	0.25	-	Power consumption in modes other than 'active mode'			
Off mode							
Thermostat-off mode	P <sub>off</sub>	0.014	kW	Crankcase heater mode	P <sub>ck</sub>	0.000	kW
	P <sub>ro</sub>	0.000	kW	Standby mode	P <sub>sb</sub>	0.014	kW
Other items							
Capacity control		variable		For air-to-air air conditioner: air flow rate, outdoor		5160	m³/h
Sound power level, outdoor	L <sub>WA</sub>	73.0	dB				
Sound power level, indoor	L <sub>WA</sub>	63.0	dB	if engine driven: Emissions of nitrogen oxides	NO <sub>x</sub> ***	-	mg/kWh fuel input GCV
				GWP of the refrigerant		675	kg CO <sub>2</sub> eq (100 years)
Contact details Panasonic Testing Centre, Panasonic Marketing Europe GmbH Winsbergring 15, 22525 Hamburg, Germany							
** If C <sub>dc</sub> is not determined by measurement then the default degradation coefficient air conditioners shall be 0.25. *** from 26 September 2018. Where information relates to multi-split air conditioners, the test result and performance data may be obtained on the basis of the performance of the outdoor unit, with a combination of indoor unit(s) recommended by the manufacturer or importer. **** Refer to information requirements for UnitList							

Information requirements for heat pumps

Model(s): Outdoor Unit U-125P2ZE5  
Indoor Unit S-60PK2E5Bx2

Outdoor side heat exchanger of heat pump:  
Indoor side heat exchanger of heat pump:  
Indication if the heater is equipped with a supplementary heater:  
if applicable: driver of compressor: (electric motor or fuel driven, gaseous or liquid fuel, internal or external combustion engine)  
electric motor

Parameters shall be declared for the average heating season, parameters for the warmer and colder heating seasons are optional.

Item	Symbol	Value	Unit	Item	Symbol	Value	Unit
Rated heating capacity	P <sub>rated,h</sub>	12.5	kW	Seasonal space heating energy efficiency	η <sub>s,h</sub>	139.7	%
Refrigeration load	P <sub>design,h</sub>	12.5	kW	Declared coefficient of performance or gas utilization efficiency / auxiliary energy factor for part load at given outdoor temperatures °C and outdoor temperature T <sub>J</sub>			
Declared heating capacity for part load at indoor temperature 20 °C and outdoor temperature T <sub>J</sub>	T <sub>J</sub> = - 7 °C	11.0	kW	T <sub>J</sub> = - 7 °C		2	%
	T <sub>J</sub> = + 2 °C	6.7	kW	T <sub>J</sub> = + 2 °C		3.4	%
	T <sub>J</sub> = + 7 °C	4.3	kW	T <sub>J</sub> = + 7 °C		5.4	%
	T <sub>J</sub> = + 12 °C	4.2	kW	T <sub>J</sub> = + 12 °C		6.5	%
T <sub>bw</sub> = bivalent temperature	P <sub>bh</sub>	11.0	kW	T <sub>bw</sub> = bivalent temperature	GUE <sub>J,dbn</sub> / AEF <sub>J,dbn</sub>	2.0	%
T <sub>co</sub> = operation limit		8.6	kW	T <sub>co</sub> = operation limit		1.6	%
For air-to-water heat pumps: T <sub>J</sub> = - 15 °C (if T <sub>co</sub> < - 20 °C)		-	kW	For water-to-air heat pumps: T <sub>J</sub> = - 15 °C (if T <sub>co</sub> < - 20 °C)		-	%
Bivalent temperature	T <sub>bw</sub>	- 7	°C	For water-to-air heat pumps: Operation limit temperature	T <sub>co</sub>	- 15	°C
Degradation co-efficient heat pumps**	C <sub>dh</sub>	0.25	-	Supplementary heater			
Power consumption in modes other than 'active mode'							
Off mode	P <sub>off</sub>	0.014	kW	back-up heating capacity *	eibu	2.4	kW
Thermostat-off mode	P <sub>ro</sub>	0.000	kW	Type of energy input			
Crankcase heater mode	P <sub>ck</sub>	0.000	kW	Standby mode	P <sub>sb</sub>	0.014	kW
Other items							
Capacity control		variable		For air-to-air heat pumps: air flow rates, outdoor		4680	m³/h
Sound power level, outdoor	L <sub>WA</sub>	73.0	dB	For water-/brine-to-air heat pumps: Rated brine or water flow rate, outdoor side heat exchanger		-	m³/h
Sound power level, indoor	L <sub>WA</sub>	63.0	dB	Emissions of nitrogen oxides (if applicable)	NO <sub>x</sub> ***	-	mg/kWh fuel input GCV
				GWP of the refrigerant		675	kg CO <sub>2</sub> eq (100 years)
Contact details Panasonic Testing Centre, Panasonic Marketing Europe GmbH Winsbergring 15, 22525 Hamburg, Germany							
** If C <sub>dh</sub> is not determined by measurement then the default degradation coefficient of heat pumps shall be 0.25. *** from 26 September 2018. Where information relates to multi-split heat pumps, the test result and performance data may be obtained on the basis of the performance of the outdoor unit, with a combination of indoor unit(s) recommended by the manufacturer or importer. **** Refer to information requirements for UnitList							



## Information requirements for air-to-air air conditioners

Model(s):	Outdoor Unit Indoor Unit	U-140PZ2E5 S-71PK2E5B*x2
Outdoor side heat exchanger of air conditioner:	air	
Indoor side heat exchanger of air conditioner:	air	
Type: compressor driven vapour compression or sorption process	vapour compression	
If applicable: driver of compressor: [electric motor or fuel driven, gaseous or liquid fuel, internal or external combustion engine]	electric motor	

Item	Symbol	Value	Unit	Item	Symbol	Value	Unit
Rated cooling capacity	$P_{rated,c}$	14.0	kW	Seasonal space cooling energy efficiency	$\eta_{s,c}$	228.6	%
Refrigeration load	$P_{design,c}$	14.0	kW	Declared energy efficiency ratio or gas utilization efficiency / auxiliary energy factor for part load at given outdoor temperatures $T_j$ and indoor 27°/19°C (dry/wet bulb)			
Declared cooling capacity for part load at given outdoor temperatures $T_j$ and indoor 27°/19°C (dry/wet bulb)	$T_j = +35\text{ °C}$	14.0	kW	$T_j = +35\text{ °C}$	EER <sub>out</sub>	2.8	%
	$T_j = +30\text{ °C}$	10.3	kW	$T_j = +30\text{ °C}$	GUE <sub>in,dbn</sub> /	4.1	%
	$T_j = +25\text{ °C}$	6.6	kW	$T_j = +25\text{ °C}$	AEF <sub>in,dbn</sub>	7.0	%
	$T_j = +20\text{ °C}$	4.5	kW	$T_j = +20\text{ °C}$		10.2	%
Degradation co-efficient for air conditioners**	$C_{dc}$	0.25	-	Power consumption in modes other than 'active mode'			
				Off mode			
				Thermostat-off mode			
				Crankcase heater mode			
				Standby mode			
				Other items			
Capacity control		variable		For air-to-air air conditioner: air flow rate, outdoor		5340	m³/h
Sound power level, outdoor	$L_{WA}$	74.0	dB				
Sound power level, indoor	$L_{WA}$	63.0	dB	if engine driven: Emissions of nitrogen oxides	NO <sub>x</sub> **	-	mg/kWh fuel input GCV
				GWP of the refrigerant		675	kg CO <sub>2</sub> eq (100 years)
Contact details				Panasonic Testing Centre, Panasonic Marketing Europe GmbH Winsbergring 15, 22525 Hamburg, Germany			
** If $C_{dc}$ is not determined by measurement then the default degradation coefficient air conditioners shall be 0.25.							
*** from 26 September 2018.							
Where information relates to multi-split air conditioners, the test result and performance data may be obtained on the basis of the performance of the outdoor unit, with a combination of indoor unit(s) recommended by the manufacturer or importer.							
**** Refer to information requirements for UnitList							

## Information requirements for heat pumps

Model(s):	Outdoor Unit Indoor Unit	U-140PZ2E5 S-71PK2E5B*x2
Outdoor side heat exchanger of heat pump:	air	
Indoor side heat exchanger of heat pump:	air	
Indication if the heater is equipped with a supplementary heater:	no	
If applicable: driver of compressor: [electric motor or fuel driven, gaseous or liquid fuel, internal or external combustion engine]	electric motor	

Parameters shall be declared for the average heating season, parameters for the warmer and colder heating seasons are optional.

Item	Symbol	Value	Unit	Item	Symbol	Value	Unit
Rated heating capacity	$P_{rated,h}$	14.0	kW	Seasonal space heating energy efficiency	$\eta_{s,h}$	137.7	%
Refrigeration load	$P_{design,h}$	13.6	kW	Declared coefficient of performance or gas utilization efficiency / auxiliary energy factor for part load at given outdoor temperatures °C and outdoor temperature $T_j$			
Declared heating capacity for part load at indoor temperature 20 °C and outdoor temperature $T_j$	$T_j = -7\text{ °C}$	12.0	kW	$T_j = -7\text{ °C}$		1.9	%
	$T_j = +2\text{ °C}$	7.5	kW	$T_j = +2\text{ °C}$		3.3	%
	$T_j = +7\text{ °C}$	4.8	kW	$T_j = +7\text{ °C}$		5.8	%
	$T_j = +12\text{ °C}$	4.3	kW	$T_j = +12\text{ °C}$		6.1	%
$T_{biv} = \text{bivalent temperature}$	$P_{biv}$	12.0	kW	$T_{biv} = \text{bivalent temperature}$	GUE <sub>in,dbn</sub> /	1.9	%
$T_{col} = \text{operation limit}$		8.9	kW	$T_{col} = \text{operation limit}$	AEF <sub>in,dbn</sub>	1.4	%
For air-to-water heat pumps: $T_j = -15\text{ °C}$ (if $T_{col} < -20\text{ °C}$ )		-	kW	For water-to-air heat pumps: $T_j = -15\text{ °C}$ (if $T_{col} < -20\text{ °C}$ )		-	%
Bivalent temperature	$T_{biv}$	-7	°C	For water-to-air heat pumps: Operation limit temperature	$T_{col}$	-15	°C
Degradation co-efficient heat pumps**	$C_{dh}$	0.25	-	Supplementary heater			
				Power consumption in modes other than 'active mode'			
				Off mode			
				Thermostat-off mode			
				Crankcase heater mode			
				Standby mode			
				Other items			
Capacity control		variable		For air-to-air heat pumps: air flow rate, outdoor		4980	m³/h
Sound power level, outdoor	$L_{WA}$	74.0	dB	For water-/brine-to-air heat pumps: Rated brine or water flow rate, outdoor side heat exchanger		-	m³/h
Sound power level, indoor	$L_{WA}$	63.0	dB	Emissions of nitrogen oxides (if applicable)	NO <sub>x</sub> **	-	mg/kWh fuel input GCV
				GWP of the refrigerant		675	kg CO <sub>2</sub> eq (100 years)
Contact details				Panasonic Testing Centre, Panasonic Marketing Europe GmbH Winsbergring 15, 22525 Hamburg, Germany			
** If $C_{dh}$ is not determined by measurement then the default degradation coefficient of heat pumps shall be 0.25.							
*** from 26 September 2018.							
Where information relates to multi-split heat pumps, the test result and performance data may be obtained on the basis of the performance of the outdoor unit, with a combination of indoor unit(s) recommended by the manufacturer or importer.							
**** Refer to information requirements for UnitList							

### Information requirements for air-to-air air conditioners

Model(s):	Outdoor Unit Indoor Unit	U-125PZ2E8 S-60PK2E5Bx2
Outdoor side heat exchanger of air conditioner:	air	
Indoor side heat exchanger of air conditioner:	air	
Type: compressor driven vapour compression or sorption process	vapour compression	
if applicable: driver of compressor: [electric motor or fuel driven, gaseous or liquid fuel, internal or external combustion engine]	electric motor	

Item	Symbol	Value	Unit	Item	Symbol	Value	Unit
Rated cooling capacity	$P_{rated,c}$	12.5	kW	Seasonal space cooling energy efficiency	$\eta_{s,c}$	236.3	%
Refrigeration load	$P_{design,c}$	12.5	kW	Declared energy efficiency ratio or gas utilization efficiency / auxiliary energy factor for part load at given outdoor temperatures $T_j$ and indoor 27°/19°C (dry/wet bulb)			
Declared cooling capacity for part load at given outdoor temperatures $T_j$ and indoor 27°/19°C (dry/wet bulb)	$T_j = +35\text{ °C}$	12.5	kW	$T_j = +35\text{ °C}$		3.2	%
	$T_j = +30\text{ °C}$	9.2	kW	$T_j = +30\text{ °C}$	$EER_{d,or}$	4.4	%
	$T_j = +25\text{ °C}$	5.9	kW	$T_j = +25\text{ °C}$	$GUE_{E,bln} / AEF_{E,bln}$	7.1	%
	$T_j = +20\text{ °C}$	4.5	kW	$T_j = +20\text{ °C}$		10.1	%
Degradation co-efficient for air conditioners**	$C_{dc}$	0.25	-				
Power consumption in modes other than 'active mode'							
Off mode	$P_{off}$	0.017	kW	Crankcase heater mode	$P_{ck}$	0.000	kW
Thermostat-off mode	$P_{to}$	0.000	kW	Standby mode	$P_{sb}$	0.017	kW
Other items							
Capacity control		variable		For air-to-air air conditioner: air flow rate, outdoor		5160	m³/h
Sound power level, outdoor	$L_{WA}$	73.0	dB				
Sound power level, indoor	$L_{WA}$	63.0	dB	if engine driven: Emissions of nitrogen oxides	$NO_x^{***}$	-	mg/kWh fuel input GCV
				GWP of the refrigerant		675	kg CO <sub>2</sub> eq (100 years)
Contact details				Panasonic Testing Centre, Panasonic Marketing Europe GmbH Winsbergring 15, 22525 Hamburg, Germany			
** If $C_{dc}$ is not determined by measurement then the default degradation coefficient air conditioners shall be 0.25. *** from 26 September 2018. Where information relates to multi-split air conditioners, the test result and performance data may be obtained on the basis of the performance of the outdoor unit, with a combination of indoor unit(s) recommended by the manufacturer or importer. **** Refer to information requirements for UnitList							

### Information requirements for heat pumps

Model(s):	Outdoor Unit Indoor Unit	U-125PZ2E8 S-60PK2E5Bx2
Outdoor side heat exchanger of heat pump:	air	
Indoor side heat exchanger of heat pump:	air	
Indication if the heater is equipped with a supplementary heater:	no	
if applicable: driver of compressor: [electric motor or fuel driven, gaseous or liquid fuel, internal or external combustion engine]	electric motor	

Parameters shall be declared for the average heating season, parameters for the warmer and colder heating seasons are optional.

Item	Symbol	Value	Unit	Item	Symbol	Value	Unit
Rated heating capacity	$P_{rated,h}$	12.5	kW	Seasonal space heating energy efficiency	$\eta_{s,h}$	139.7	%
Refrigeration load	$P_{design,h}$	12.5	kW	Declared coefficient of performance or gas utilization efficiency / auxiliary energy factor for part load at given outdoor temperatures $T_j$			
Declared heating capacity for part load at indoor temperature 20 °C and outdoor temperature $T_j$	$T_j = -7\text{ °C}$	11.0	kW	$T_j = -7\text{ °C}$		2	%
	$T_j = +2\text{ °C}$	6.7	kW	$T_j = +2\text{ °C}$		3.4	%
	$T_j = +7\text{ °C}$	4.3	kW	$T_j = +7\text{ °C}$		5.4	%
	$T_j = +12\text{ °C}$	4.2	kW	$T_j = +12\text{ °C}$	$COP_d$ or $GUE_{E,bln} / AEF_{E,bln}$	6.5	%
$T_{bw}$ = bivalent temperature		11.0	kW	$T_{bw}$ = bivalent temperature		2.0	%
$T_{ca}$ = operation limit		8.6	kW	$T_{ca}$ = operation limit		1.6	%
For air-to-water heat pumps: $T_j = -15\text{ °C}$ (if $T_{ca} < -20\text{ °C}$ )		-	kW	For water-to-air heat pumps: $T_j = -15\text{ °C}$ (if $T_{ca} < -20\text{ °C}$ )		-	%
Bivalent temperature	$T_{bw}$	-7	°C	For water-to-air heat pumps: Operation limit temperature	$T_{ca}$	-15	°C
Degradation co-efficient heat pumps**	$C_{dh}$	0.25	-				
Power consumption in modes other than 'active mode'							
Off mode	$P_{off}$	0.017	kW	Supplementary heater back-up heating capacity *	$e_{bu}$	2.4	kW
Thermostat-off mode	$P_{to}$	0.000	kW	Type of energy input			
Crankcase heater mode	$P_{ck}$	0.000	kW	Standby mode	$P_{sb}$	0.017	kW
Other items							
Capacity control		variable		For air-to-air heat pumps: air flow rate, outdoor		4680	m³/h
Sound power level, outdoor	$L_{WA}$	73.0	dB	For water-/brine-to-air heat pumps: Rated brine or water flow rate, outdoor side heat exchanger		-	m³/h
Sound power level, indoor	$L_{WA}$	63.0	dB	Emissions of nitrogen oxides (if applicable)	$NO_x^{***}$	-	mg/kWh fuel input GCV
				GWP of the refrigerant		675	kg CO <sub>2</sub> eq (100 years)
Contact details				Panasonic Testing Centre, Panasonic Marketing Europe GmbH Winsbergring 15, 22525 Hamburg, Germany			
** If $C_{dh}$ is not determined by measurement then the default degradation coefficient of heat pumps shall be 0.25. *** from 26 September 2018. Where information relates to multi-split heat pumps, the test result and performance data may be obtained on the basis of the performance of the outdoor unit, with a combination of indoor unit(s) recommended by the manufacturer or importer. **** Refer to information requirements for UnitList							

## Information requirements for air-to-air air conditioners

Model(s):		U-140PZ2E8 S-71PK2E5B*2	
Outdoor side heat exchanger of air conditioner:		air	
Indoor side heat exchanger of air conditioner:		air	
Type: compressor driven vapour compression or sorption process		vapour compression	
if applicable: driver of compressor: [electric motor or fuel driven, gaseous or liquid fuel, internal or external combustion engine]		electric motor	

Item	Symbol	Value	Unit	Item	Symbol	Value	Unit
Rated cooling capacity	$P_{rated,c}$	14.0	kW	Seasonal space cooling energy efficiency	$\eta_{s,c}$	228.0	%
Refrigeration load	$P_{design,c}$	14.0	kW	Declared energy efficiency ratio or gas utilization efficiency / auxiliary energy factor for part load at given outdoor temperatures $T_j$ and indoor 27°/19°C (dry/wet bulb)			
Declared cooling capacity for part load at given outdoor temperatures $T_j$ and indoor 27°/19°C (dry/wet bulb)				Declared energy efficiency ratio or gas utilization efficiency / auxiliary energy factor for part load at given outdoor temperatures $T_j$			
$T_j = +35\text{ °C}$		14.0	kW	$T_j = +35\text{ °C}$		2.8	%
$T_j = +30\text{ °C}$		10.3	kW	$T_j = +30\text{ °C}$	$EER_{out}$	4.1	%
$T_j = +25\text{ °C}$	$P_{dc}$	6.6	kW	$T_j = +25\text{ °C}$	$GUE_{E,bin}$ / $AEF_{E,bin}$	7.0	%
$T_j = +20\text{ °C}$		4.5	kW	$T_j = +20\text{ °C}$		10.2	%
Degradation co-efficient for air conditioners**	$C_{dc}$	0.25	-				
Power consumption in modes other than 'active mode'							
Off mode	$P_{off}$	0.017	kW	Crankcase heater mode	$P_{ck}$	0.000	kW
Thermostat-off mode	$P_{to}$	0.000	kW	Standby mode	$P_{sb}$	0.017	kW
Other items							
Capacity control		variable		For air-to-air air conditioner: air flow rate, outdoor		5340	m³/h
Sound power level, outdoor	$L_{WA}$	74.0	dB				
Sound power level, indoor	$L_{WA}$	63.0	dB	if engine driven: Emissions of nitrogen oxides	$NO_x^{***}$	-	mg/kWh fuel input GCV
				GWP of the refrigerant		675	kg CO <sub>2</sub> eq (100 years)
Contact details				Panasonic Testing Centre, Panasonic Marketing Europe GmbH Winsbergring 15, 22525 Hamburg, Germany			
** If $C_{dc}$ is not determined by measurement then the default degradation coefficient air conditioners shall be 0.25. *** from 26 September 2018. Where information relates to multi-split air conditioners, the test result and performance data may be obtained on the basis of the performance of the outdoor unit, with a combination of indoor unit(s) recommended by the manufacturer or importer. **** Refer to information requirements for UnitIList							

## Information requirements for heat pumps

Model(s):		U-140PZ2E8 S-71PK2E5B*2	
Outdoor side heat exchanger of heat pump:		air	
Indoor side heat exchanger of heat pump:		air	
Indication if the heater is equipped with a supplementary heater:		no	
if applicable: driver of compressor: [electric motor or fuel driven, gaseous or liquid fuel, internal or external combustion engine]		electric motor	

Parameters shall be declared for the average heating season, parameters for the warmer and colder heating seasons are optional.

Item	Symbol	Value	Unit	Item	Symbol	Value	Unit
Rated heating capacity	$P_{rated,h}$	14.0	kW	Seasonal space heating energy efficiency	$\eta_{s,h}$	137.7	%
Refrigeration load	$P_{design,h}$	13.6	kW	Declared coefficient of performance or gas utilization efficiency / auxiliary energy factor for part load at given outdoor temperatures °C and outdoor temperature $T_j$			
Declared heating capacity for part load at indoor temperature 20 °C and outdoor temperature $T_j$				Declared coefficient of performance or gas utilization efficiency / auxiliary energy factor for part load at given outdoor temperatures °C and outdoor temperature $T_j$			
$T_j = -7\text{ °C}$		12.0	kW	$T_j = -7\text{ °C}$		1.9	%
$T_j = +2\text{ °C}$		7.5	kW	$T_j = +2\text{ °C}$		3.3	%
$T_j = +7\text{ °C}$		4.8	kW	$T_j = +7\text{ °C}$		5.8	%
$T_j = +12\text{ °C}$		4.3	kW	$T_j = +12\text{ °C}$		6.1	%
$T_{bw} = \text{bivalent temperature}$	$P_{bin}$	12.0	kW	$T_{bw} = \text{bivalent temperature}$	$COP_d$ or $GUE_{E,bin}$ / $AEF_{E,bin}$	1.9	%
$T_{col} = \text{operation limit}$		8.9	kW	$T_{col} = \text{operation limit}$		1.4	%
For air-to-water heat pumps: $T_j = -15\text{ °C}$ (if $T_{col} < -20\text{ °C}$ )		-	kW	For water-to-air heat pumps: $T_j = -15\text{ °C}$ (if $T_{col} < -20\text{ °C}$ )		-	%
Bivalent temperature	$T_{bw}$	-7	°C	For water-to-air heat pumps: Operation limit temperature	$T_{col}$	-15	°C
Degradation co-efficient heat pumps**	$C_{dh}$	0.25	-				
Power consumption in modes other than 'active mode'							
Off mode	$P_{off}$	0.017	kW	Supplementary heater back-up heating capacity *	elbu	2.8	kW
Thermostat-off mode	$P_{to}$	0.000	kW	Type of energy input			
Crankcase heater mode	$P_{ck}$	0.000	kW	Standby mode	$P_{sb}$	0.017	kW
Other items							
Capacity control		variable		For air-to-air heat pumps: air flow rate, outdoor		4980	m³/h
Sound power level, outdoor	$L_{WA}$	74.0	dB	For water/brine-to-air heat pumps: Rated brine or water flow rate, outdoor side heat exchanger		-	m³/h
Sound power level, indoor	$L_{WA}$	63.0	dB	Emissions of nitrogen oxides (if applicable)	$NO_x^{***}$	-	mg/kWh fuel input GCV
				GWP of the refrigerant		675	kg CO <sub>2</sub> eq (100 years)
Contact details				Panasonic Testing Centre, Panasonic Marketing Europe GmbH Winsbergring 15, 22525 Hamburg, Germany			
** If $C_{dh}$ is not determined by measurement then the default degradation coefficient of heat pumps shall be 0.25. *** from 26 September 2018. Where information relates to multi-split heat pumps, the test result and performance data may be obtained on the basis of the performance of the outdoor unit, with a combination of indoor unit(s) recommended by the manufacturer or importer. **** Refer to information requirements for UnitIList							

Information requirements for air-to-air air conditioners

Model(s):	Outdoor Unit Indoor Unit U-125P2ZE5 S-60PF1E5B x2		
Outdoor side heat exchanger of air conditioner:	air		
Indoor side heat exchanger of air conditioner:	air		
Type: compressor driven vapour compression or sorption process	vapour compression		
if applicable: driver of compressor: [electric motor or fuel driven, gaseous or liquid fuel, internal or external combustion engine]	electric motor		

Item	Symbol	Value	Unit	Item	Symbol	Value	Unit
Rated cooling capacity	$P_{rated,c}$	12.5	kW	Seasonal space cooling energy efficiency	$\eta_{h,c}$	233.8	%
Refrigeration load	$P_{design,c}$	12.5	kW	Declared energy efficiency ratio or gas utilization efficiency / auxiliary energy factor for part load at given outdoor temperatures $T_j$ and indoor 27°/19°C (dry/wet bulb)			
Declared cooling capacity for part load at given outdoor temperatures $T_j$ and indoor 27°/19°C (dry/wet bulb)	$T_j = +35\text{ °C}$	12.5	kW	$T_j = +35\text{ °C}$		3.5	%
	$T_j = +30\text{ °C}$	9.2	kW	$T_j = +30\text{ °C}$	$EER_{x,or}$	4.9	%
	$T_j = +25\text{ °C}$	5.9	kW	$T_j = +25\text{ °C}$	$GUE_{c,bin} / AEF_{c,bin}$	6.7	%
	$T_j = +20\text{ °C}$	3.8	kW	$T_j = +20\text{ °C}$		8.3	%
Degradation co-efficient for air conditioners**	$C_{dc}$	0.25	-	Power consumption in modes other than 'active mode'			
Off mode							
Thermostat-off mode	$P_{off}$	0.012	kW	Crankcase heater mode	$P_{ck}$	0.000	kW
	$P_{pro}$	0.000	kW	Standby mode	$P_{sb}$	0.012	kW
Other items							
Capacity control		variable		For air-to-air air conditioner: air flow rate, outdoor		5160	m³/h
Sound power level, outdoor	$L_{WA}$	73.0	dB				
Sound power level, indoor	$L_{WA}$	57.0	dB	if engine driven: Emissions of nitrogen oxides	$NO_x^{***}$	-	mg/kWh fuel input GCV
				GWP of the refrigerant		675	kg CO <sub>2</sub> eq (100 years)
Contact details				Panasonic Testing Centre, Panasonic Marketing Europe GmbH Winsbergring 15, 22525 Hamburg, Germany			
** If $C_{dc}$ is not determined by measurement then the default degradation coefficient air conditioners shall be 0.25. *** from 26 September 2018. Where information relates to multi-split air conditioners, the test result and performance data may be obtained on the basis of the performance of the outdoor unit, with a combination of indoor unit(s) recommended by the manufacturer or importer. **** Refer to information requirements for UnitList							

Information requirements for heat pumps

Model(s):	Outdoor Unit Indoor Unit U-125P2ZE5 S-60PF1E5B x2		
Outdoor side heat exchanger of heat pump:	air		
Indoor side heat exchanger of heat pump:	air		
Indication if the heater is equipped with a supplementary heater:	no		
if applicable: driver of compressor: [electric motor or fuel driven, gaseous or liquid fuel, internal or external combustion engine]	electric motor		

Parameters shall be declared for the average heating season, parameters for the warmer and colder heating seasons are optional.

Item	Symbol	Value	Unit	Item	Symbol	Value	Unit
Rated heating capacity	$P_{rated,h}$	12.5	kW	Seasonal space heating energy efficiency	$\eta_{h,h}$	142.7	%
Refrigeration load	$P_{design,h}$	12.5	kW	Declared coefficient of performance or gas utilization efficiency / auxiliary energy factor for part load at given outdoor temperatures $T_j$			
Declared heating capacity for part load at indoor temperature 20 °C and outdoor temperature $T_j$	$T_j = -7\text{ °C}$	11.0	kW	$T_j = -7\text{ °C}$		2.3	%
	$T_j = +2\text{ °C}$	6.7	kW	$T_j = +2\text{ °C}$		3.4	%
	$T_j = +7\text{ °C}$	4.3	kW	$T_j = +7\text{ °C}$		5.3	%
	$T_j = +12\text{ °C}$	3.9	kW	$T_j = +12\text{ °C}$		6.2	%
$T_{hw}$ = bivalent temperature	$P_{bh}$	11.0	kW	$T_{hw}$ = bivalent temperature	$GUE_{h,bin} / AEF_{h,bin}$	2.3	%
$T_{oh}$ = operation limit		9.1	kW	$T_{oh}$ = operation limit		1.6	%
For air-to-water heat pumps: $T_j = -15\text{ °C}$ (if $T_{oh} < -20\text{ °C}$ )		-	kW	For water-to-air heat pumps: $T_j = -15\text{ °C}$ (if $T_{oh} < -20\text{ °C}$ )		-	%
Bivalent temperature	$T_{bw}$	-7	°C	For water-to-air heat pumps: Operation limit temperature	$T_{ol}$	-15	°C
Degradation co-efficient heat pumps**	$C_{dh}$	0.25	-	Supplementary heater			
Power consumption in modes other than 'active mode'							
Off mode	$P_{off}$	0.012	kW	back-up heating capacity*	$e_{bu}$	2.3	kW
Thermostat-off mode	$P_{pro}$	0.000	kW	Type of energy input			
Crankcase heater mode	$P_{ck}$	0.000	kW	Standby mode	$P_{sb}$	0.012	kW
Other items							
Capacity control		variable		For air-to-air heat pumps: air flow rate, outdoor		4680	m³/h
Sound power level, outdoor	$L_{WA}$	73.0	dB	For water-/brine-to-air heat pumps: Rated brine or water flow rate, outdoor side heat exchanger		-	m³/h
Sound power level, indoor	$L_{WA}$	57.0	dB	Emissions of nitrogen oxides (if applicable)	$NO_x^{***}$	-	mg/kWh fuel input GCV
				GWP of the refrigerant		675	kg CO <sub>2</sub> eq (100 years)
Contact details				Panasonic Testing Centre, Panasonic Marketing Europe GmbH Winsbergring 15, 22525 Hamburg, Germany			
** If $C_{dh}$ is not determined by measurement then the default degradation coefficient of heat pumps shall be 0.25. *** from 26 September 2018. Where information relates to multi-split heat pumps, the test result and performance data may be obtained on the basis of the performance of the outdoor unit, with a combination of indoor unit(s) recommended by the manufacturer or importer. **** Refer to information requirements for UnitList							

## Information requirements for air-to-air air conditioners

Model(s):		Outdoor Unit Indoor Unit	
		U-140PZZE5 S-71PF1E5B x2	
Outdoor side heat exchanger of air conditioner:		air	
Indoor side heat exchanger of air conditioner:		air	
Type: compressor driven vapour compression or sorption process		vapour compression	
if applicable: driver of compressor: [electric motor or fuel driven, gaseous or liquid fuel, internal or external combustion engine]		electric motor	

Item	Symbol	Value	Unit	Item	Symbol	Value	Unit
Rated cooling capacity	$P_{rated,c}$	14.0	kW	Seasonal space cooling energy efficiency	$\eta_{h,c}$	222.3	%
Refrigeration load	$P_{design,c}$	14.0	kW	Declared energy efficiency ratio or gas utilization efficiency / auxiliary energy factor for part load at given outdoor temperatures $T_j$ and indoor 27°/19°C (dry/wet bulb)			
Declared cooling capacity for part load at given outdoor temperatures $T_j$ and indoor 27°/19°C (dry/wet bulb)							
$T_j = +35\text{ °C}$		14.0	kW	$T_j = +35\text{ °C}$		3.1	%
$T_j = +30\text{ °C}$		10.3	kW	$T_j = +30\text{ °C}$	$EER_{o,of}$	4.7	%
$T_j = +25\text{ °C}$	$P_{dc}$	6.6	kW	$T_j = +25\text{ °C}$	$GUE_{c,bin}$ /	6.5	%
$T_j = +20\text{ °C}$		3.8	kW	$T_j = +20\text{ °C}$	$AEF_{c,bin}$	7.6	%
Degradation co-efficient for air conditioners**	$C_{dc}$	0.25	-	Power consumption in modes other than 'active mode'			
Off mode		$P_{off}$	0.012	kW	Crankcase heater mode	$P_{ck}$	0.000
Thermostat-off mode		$P_{to}$	0.000	kW	Standby mode	$P_{sb}$	0.012
Capacity control		variable		Other items			
Sound power level, outdoor		$L_{WA}$	74.0	dB	For air-to-air air conditioner: air flow rate, outdoor		5340
Sound power level, indoor		$L_{WA}$	57.0	dB	if engine driven: Emissions of nitrogen oxides	$NO_x^{***}$	-
				GWP of the refrigerant		675	kg CO <sub>2</sub> eq (100 years)
Contact details		Panasonic Testing Centre, Panasonic Marketing Europe GmbH Winsbergring 15, 22525 Hamburg, Germany					

\*\* If  $C_{dc}$  is not determined by measurement then the default degradation coefficient air conditioners shall be 0.25.

\*\*\* from 26 September 2018.

Where information relates to multi-split air conditioners, the test result and performance data may be obtained on the basis of the performance of the outdoor unit, with a combination of indoor unit(s) recommended by the manufacturer or importer.

\*\*\*\* Refer to information requirements for UnitIList

## Information requirements for heat pumps

Model(s):		Outdoor Unit Indoor Unit	
		U-140PZZE5 S-71PF1E5B x2	
Outdoor side heat exchanger of heat pump:		air	
Indoor side heat exchanger of heat pump:		air	
Indication if the heater is equipped with a supplementary heater:		no	
if applicable: driver of compressor: [electric motor or fuel driven, gaseous or liquid fuel, internal or external combustion engine]		electric motor	

Parameters shall be declared for the average heating season, parameters for the warmer and colder heating seasons are optional.

Item	Symbol	Value	Unit	Item	Symbol	Value	Unit
Rated heating capacity	$P_{rated,h}$	14.0	kW	Seasonal space heating energy efficiency	$\eta_{h,h}$	139.4	%
Refrigeration load	$P_{design,h}$	13.6	kW	Declared coefficient of performance or gas utilization efficiency / auxiliary energy factor for part load at given outdoor temperatures °C and outdoor temperature $T_j$			
Declared heating capacity for part load at indoor temperature 20 °C and outdoor temperature $T_j$							
$T_j = -7\text{ °C}$		12.0	kW	$T_j = -7\text{ °C}$		2.1	%
$T_j = +2\text{ °C}$		7.3	kW	$T_j = +2\text{ °C}$		3.4	%
$T_j = +7\text{ °C}$		4.7	kW	$T_j = +7\text{ °C}$	$COP_d$ or	5.2	%
$T_j = +12\text{ °C}$		3.9	kW	$T_j = +12\text{ °C}$	$GUE_{h,bin}$ /	6.1	%
$T_{b,w}$ = bivalent temperature	$P_{b,h}$	12.0	kW	$T_{b,w}$ = bivalent temperature	$AEF_{h,bin}$	2.1	%
$T_{o,l}$ = operation limit		9.1	kW	$T_{o,l}$ = operation limit		1.6	%
For air-to-water heat pumps: $T_j = -15\text{ °C}$ (if $T_{o,l} < -20\text{ °C}$ )		-	kW	For water-to-air heat pumps: $T_j = -15\text{ °C}$ (if $T_{o,l} < -20\text{ °C}$ )		-	%
Bivalent temperature	$T_{b,w}$	-7	°C	For water-to-air heat pumps: Operation limit temperature	$T_{o,l}$	-15	°C
Degradation co-efficient heat pumps**	$C_{dh}$	0.25	-	Supplementary heater			
Power consumption in modes other than 'active mode'				back-up heating capacity*	$e_{bu}$	2.7	kW
Off mode		$P_{off}$	0.012	kW	Type of energy input		
Thermostat-off mode		$P_{to}$	0.000	kW	Standby mode	$P_{sb}$	0.012
Crankcase heater mode		$P_{ck}$	0.000	kW	Other items		
Capacity control		variable		For air-to-air heat pumps: air flow rate, outdoor		4980	m <sup>3</sup> /h
Sound power level, outdoor		$L_{WA}$	74.0	dB	For water/brine-to-air heat pumps: Rated brine or water flow rate, outdoor side heat exchanger		m <sup>3</sup> /h
Sound power level, indoor		$L_{WA}$	57.0	dB	Emissions of nitrogen oxides (if applicable)	$NO_x^{***}$	-
				GWP of the refrigerant		675	kg CO <sub>2</sub> eq (100 years)
Contact details		Panasonic Testing Centre, Panasonic Marketing Europe GmbH Winsbergring 15, 22525 Hamburg, Germany					

\*\* If  $C_{dh}$  is not determined by measurement then the default degradation coefficient of heat pumps shall be 0.25.

\*\*\* from 26 September 2018.

Where information relates to multi-split heat pumps, the test result and performance data may be obtained on the basis of the performance of the outdoor unit, with a combination of indoor unit(s) recommended by the manufacturer or importer.

\*\*\*\* Refer to information requirements for UnitIList

### Information requirements for air-to-air air conditioners

Model(s): Outdoor Unit U-125PZ2E5  
Indoor Unit S-125PF1E5B

Outdoor side heat exchanger of air conditioner:  
Indoor side heat exchanger of air conditioner:  
Type: compressor driven vapour compression or sorption process  
if applicable: driver of compressor: [electric motor or fuel driven, gaseous or liquid fuel, internal or external combustion engine]  
electric motor

Item	Symbol	Value	Unit	Item	Symbol	Value	Unit
Rated cooling capacity	$P_{rated,c}$	12.5	kW	Seasonal space cooling energy efficiency	$\eta_{h,c}$	219.2	%
Refrigeration load	$P_{design,c}$	12.5	kW	Declared energy efficiency ratio or gas utilization efficiency / auxiliary energy factor for part load at given outdoor temperatures $T_j$ and indoor 27°/19°C (dry/wet bulb)			
Declared cooling capacity for part load at given outdoor temperatures $T_j$ and indoor 27°/19°C (dry/wet bulb)							
$T_j = +35\text{ °C}$		12.5	kW	$T_j = +35\text{ °C}$		3.5	%
$T_j = +30\text{ °C}$		9.2	kW	$T_j = +30\text{ °C}$	$EER_x$ or $GUE_{E,bin}$	4.9	%
$T_j = +25\text{ °C}$	$P_{dc}$	5.9	kW	$T_j = +25\text{ °C}$		7.2	%
$T_j = +20\text{ °C}$		3.8	kW	$T_j = +20\text{ °C}$	$AEF_{E,bin}$	9.5	%
Degradation co-efficient for air conditioners**	$C_{dc}$	0.25	-				
Power consumption in modes other than 'active mode'							
Off mode	$P_{off}$	0.020	kW	Crankcase heater mode	$P_{ck}$	0.000	kW
Thermostat-off mode	$P_{to}$	0.215	kW	Standby mode	$P_{sb}$	0.020	kW
Other items							
Capacity control		variable		For air-to-air air conditioner: air flow rate, outdoor		5160	m³/h
Sound power level, outdoor	$L_{WA}$	73.0	dB				
Sound power level, indoor	$L_{WA}$	61.0	dB	if engine driven: Emissions of nitrogen oxides	$NO_x^{***}$	-	mg/kWh fuel input GCV
				GWP of the refrigerant		675	kg CO <sub>2</sub> eq (100 years)
Contact details				Panasonic Testing Centre, Panasonic Marketing Europe GmbH Winsbeigring 15, 22525 Hamburg, Germany			
** If $C_{dc}$ is not determined by measurement then the default degradation coefficient air conditioners shall be 0.25. *** from 26 September 2018. Where information relates to multi-split air conditioners, the test result and performance data may be obtained on the basis of the performance of the outdoor unit, with a combination of indoor unit(s) recommended by the manufacturer or importer. **** Refer to information requirements for UnitList							

### Information requirements for heat pumps

Model(s): Outdoor Unit U-125PZ2E5  
Indoor Unit S-125PF1E5B

Outdoor side heat exchanger of heat pump:  
Indoor side heat exchanger of heat pump:  
Indication if the heater is equipped with a supplementary heater:  
if applicable: driver of compressor: [electric motor or fuel driven, gaseous or liquid fuel, internal or external combustion engine]  
electric motor

Parameters shall be declared for the average heating season, parameters for the warmer and colder heating seasons are optional.

Item	Symbol	Value	Unit	Item	Symbol	Value	Unit
Rated heating capacity	$P_{rated,h}$	12.5	kW	Seasonal space heating energy efficiency	$\eta_{h,h}$	141.5	%
Refrigeration load	$P_{design,h}$	12.5	kW	Declared coefficient of performance or gas utilization efficiency / auxiliary energy factor for part load at given outdoor temperatures $T_j$			
Declared heating capacity for part load at indoor temperature 20 °C and outdoor temperature $T_j$							
$T_j = -7\text{ °C}$		11.0	kW	$T_j = -7\text{ °C}$		2.3	%
$T_j = +2\text{ °C}$		6.7	kW	$T_j = +2\text{ °C}$		3.4	%
$T_j = +7\text{ °C}$		4.3	kW	$T_j = +7\text{ °C}$		5.3	%
$T_j = +12\text{ °C}$		3.9	kW	$T_j = +12\text{ °C}$		6.2	%
$T_{low}$ = bivalent temperature	$P_{bh}$	11.0	kW	$T_{low}$ = bivalent temperature	$COP_d$ or $GUE_{E,bin}$ / $AEF_{E,bin}$	2.3	%
$T_{col}$ = operation limit		9.1	kW	$T_{col}$ = operation limit		1.6	%
For air-to-water heat pumps: $T_j = -15\text{ °C}$ (if $T_{col} < -20\text{ °C}$ )		-	kW	For water-to-air heat pumps: $T_j = -15\text{ °C}$ (if $T_{col} < -20\text{ °C}$ )		-	%
Bivalent temperature	$T_{bw}$	-7	°C	For water-to-air heat pumps: Operation limit temperature	$T_{ol}$	-15	°C
Degradation co-efficient heat pumps**	$C_{bh}$	0.25	-				
Power consumption in modes other than 'active mode'							
Off mode	$P_{off}$	0.020	kW	back-up heating capacity*	$e_{bu}$	2.3	kW
Thermostat-off mode	$P_{to}$	0.215	kW	Type of energy input			
Crankcase heater mode	$P_{ck}$	0.000	kW	Standby mode	$P_{sb}$	0.020	kW
Other items							
Capacity control		variable		For air-to-air heat pumps: air flow rate, outdoor		4680	m³/h
Sound power level, outdoor	$L_{WA}$	73.0	dB	For water-/brine-to-air heat pumps: Rated brine or water flow rate, outdoor side heat exchanger		-	m³/h
Sound power level, indoor	$L_{WA}$	61.0	dB	Emissions of nitrogen oxides (if applicable)	$NO_x^{***}$	-	mg/kWh fuel input GCV
				GWP of the refrigerant		675	kg CO <sub>2</sub> eq (100 years)
Contact details				Panasonic Testing Centre, Panasonic Marketing Europe GmbH Winsbeigring 15, 22525 Hamburg, Germany			
** If $C_{bh}$ is not determined by measurement then the default degradation coefficient of heat pumps shall be 0.25. *** from 26 September 2018. Where information relates to multi-split heat pumps, the test result and performance data may be obtained on the basis of the performance of the outdoor unit, with a combination of indoor unit(s) recommended by the manufacturer or importer. **** Refer to information requirements for UnitList							

## Information requirements for air-to-air air conditioners

Model(s):		Outdoor Unit Indoor Unit	
		U-140PZ2E5 S-140PF1E5B	
Outdoor side heat exchanger of air conditioner:			
Indoor side heat exchanger of air conditioner:			
Type: compressor driven vapour compression or sorption process			
if applicable: driver of compressor: [electric motor or fuel driven, gaseous or liquid fuel, internal or external combustion engine]			
electric motor			

Item	Symbol	Value	Unit	Item	Symbol	Value	Unit
Rated cooling capacity	$P_{rated,c}$	14.0	kW	Seasonal space cooling energy efficiency	$\eta_{h,c}$	212.3	%
Refrigeration load	$P_{design,h,c}$	14.0	kW	Declared energy efficiency ratio or gas utilization efficiency / auxiliary energy factor for part load at given outdoor temperatures $T_j$ and indoor 27°/19°C (dry/wet bulb)			
Declared cooling capacity for part load at given outdoor temperatures $T_j$ and indoor 27°/19°C (dry/wet bulb)				Declared energy efficiency ratio or gas utilization efficiency / auxiliary energy factor for part load at given outdoor temperatures $T_j$			
$T_j = +35\text{ °C}$		14.0	kW	$T_j = +35\text{ °C}$		3.1	%
$T_j = +30\text{ °C}$		10.3	kW	$T_j = +30\text{ °C}$	EER <sub>o</sub> or GUE <sub>o,bin</sub> / AEF <sub>o,bin</sub>	4.7	%
$T_j = +25\text{ °C}$	$P_{dc}$	6.6	kW	$T_j = +25\text{ °C}$		7.0	%
$T_j = +20\text{ °C}$		3.8	kW	$T_j = +20\text{ °C}$		8.9	%
Degradation co-efficient for air conditioners**	$C_{dc}$	0.25	-	Degradation co-efficient for air conditioners**			
Power consumption in modes other than 'active mode'				Power consumption in modes other than 'active mode'			
Off mode	$P_{off}$	0.020	kW	Crankcase heater mode	$P_{ck}$	0.000	kW
Thermostat-off mode	$P_{to}$	0.223	kW	Standby mode	$P_{sb}$	0.020	kW
Other items				Other items			
Capacity control		variable		For air-to-air air conditioner: air flow rate, outdoor		5340	m³/h
Sound power level, outdoor	$L_{WA}$	74.0	dB				
Sound power level, indoor	$L_{WA}$	62.0	dB	if engine driven: Emissions of nitrogen oxides	$NO_x^{***}$	-	mg/kWh fuel input GCV
				GWP of the refrigerant		675	kg CO <sub>2</sub> eq (100 years)
Contact details				Panasonic Testing Centre, Panasonic Marketing Europe GmbH Winsbergiring 15, 22525 Hamburg, Germany			
** If $C_{dc}$ is not determined by measurement then the default degradation coefficient air conditioners shall be 0.25.							
*** from 26 September 2018.							
Where information relates to multi-split air conditioners, the test result and performance data may be obtained on the basis of the performance of the outdoor unit, with a combination of indoor unit(s) recommended by the manufacturer or importer.							
**** Refer to information requirements for UnitIList							

## Information requirements for heat pumps

Model(s):		Outdoor Unit Indoor Unit	
		U-140PZ2E5 S-140PF1E5B	
Outdoor side heat exchanger of heat pump:			
Indoor side heat exchanger of heat pump:			
Indication if the heater is equipped with a supplementary heater:			
if applicable: driver of compressor: [electric motor or fuel driven, gaseous or liquid fuel, internal or external combustion engine]			
electric motor			

Item	Symbol	Value	Unit	Item	Symbol	Value	Unit
Rated heating capacity	$P_{rated,h}$	14.0	kW	Seasonal space heating energy efficiency	$\eta_{h,h}$	138.4	%
Refrigeration load	$P_{design,h}$	13.6	kW	Declared coefficient of performance or gas utilization efficiency / auxiliary energy factor for part load at given outdoor temperatures $T_j$			
Declared heating capacity for part load at indoor temperature 20 °C and outdoor temperature $T_j$				Declared coefficient of performance or gas utilization efficiency / auxiliary energy factor for part load at given outdoor temperatures $T_j$			
$T_j = -7\text{ °C}$		12.0	kW	$T_j = -7\text{ °C}$		2.1	%
$T_j = +2\text{ °C}$		7.3	kW	$T_j = +2\text{ °C}$		3.4	%
$T_j = +7\text{ °C}$		4.7	kW	$T_j = +7\text{ °C}$		5.2	%
$T_j = +12\text{ °C}$		3.9	kW	$T_j = +12\text{ °C}$		6.1	%
$T_{bw} = \text{bivalent temperature}$	$P_{bh}$	12.0	kW	$T_{bw} = \text{bivalent temperature}$	COP <sub>d</sub> or GUE <sub>h,bin</sub> / AEF <sub>h,bin</sub>	2.1	%
$T_{ol} = \text{operation limit}$		9.1	kW	$T_{ol} = \text{operation limit}$		1.6	%
For air-to-water heat pumps: $T_j = -15\text{ °C}$ (if $T_{ol} < -20\text{ °C}$ )		-	kW	For water-to-air heat pumps: $T_j = -15\text{ °C}$ (if $T_{ol} < -20\text{ °C}$ )		-	%
Bivalent temperature	$T_{bw}$	-7	°C	For water-to-air heat pumps: Operation limit temperature	$T_{ol}$	-15	°C
Degradation co-efficient heat pumps**	$C_{bh}$	0.25	-	Supplementary heater			
Power consumption in modes other than 'active mode'				Supplementary heater			
Off mode	$P_{off}$	0.020	kW	back-up heating capacity*	$e_{bu}$	2.7	kW
Thermostat-off mode	$P_{to}$	0.223	kW	Type of energy input			
Crankcase heater mode	$P_{ck}$	0.000	kW	Standby mode	$P_{sb}$	0.020	kW
Other items				Other items			
Capacity control		variable		For air-to-air heat pumps: air flow rate, outdoor		4980	m³/h
Sound power level, outdoor	$L_{WA}$	74.0	dB	For water-/brine-to-air heat pumps: Rated brine or water flow rate, outdoor side heat exchanger		-	m³/h
Sound power level, indoor	$L_{WA}$	62.0	dB	Emissions of nitrogen oxides (if applicable)	$NO_x^{***}$	-	mg/kWh fuel input GCV
				GWP of the refrigerant		675	kg CO <sub>2</sub> eq (100 years)
Contact details				Panasonic Testing Centre, Panasonic Marketing Europe GmbH Winsbergiring 15, 22525 Hamburg, Germany			
** If $C_{bh}$ is not determined by measurement then the default degradation coefficient of heat pumps shall be 0.25.							
*** from 26 September 2018.							
Where information relates to multi-split heat pumps, the test result and performance data may be obtained on the basis of the performance of the outdoor unit, with a combination of indoor unit(s) recommended by the manufacturer or importer.							
**** Refer to information requirements for UnitIList							

Information requirements for air-to-air air conditioners

Model(s):		U-125PZ2E8 S-60PF1E5B x2	
Outdoor side heat exchanger of air conditioner:		air	
Indoor side heat exchanger of air conditioner:		air	
Type: compressor driven vapour compression or sorption process		vapour compression	
if applicable: driver of compressor: [electric motor or fuel driven, gaseous or liquid fuel, internal or external combustion engine]		electric motor	

Item	Symbol	Value	Unit	Item	Symbol	Value	Unit
Rated cooling capacity	$P_{rated,c}$	12.5	kW	Seasonal space cooling energy efficiency	$\eta_{s,c}$	233.0	%
Refrigeration load	$P_{design,c}$	12.5	kW	Declared energy efficiency ratio or gas utilization efficiency / auxiliary energy factor for part load at given outdoor temperatures $T_j$ and indoor 27°/19°C (dry/wet bulb)			
Declared cooling capacity for part load at given outdoor temperatures $T_j$ and indoor 27°/19°C (dry/wet bulb)							
$T_j = +35\text{ °C}$		12.5	kW	$T_j = +35\text{ °C}$		3.5	%
$T_j = +30\text{ °C}$		9.2	kW	$T_j = +30\text{ °C}$	$EER_{p,or}$	4.9	%
$T_j = +25\text{ °C}$	$P_{dc}$	5.9	kW	$T_j = +25\text{ °C}$	$GUE_{E,ind}$ / $AEF_{E,ind}$	6.7	%
$T_j = +20\text{ °C}$		3.8	kW	$T_j = +20\text{ °C}$		8.3	%
Degradation co-efficient for air conditioners**	$C_{dc}$	0.25	-				
Power consumption in modes other than 'active mode'							
Off mode	$P_{off}$	0.015	kW	Crankcase heater mode	$P_{ck}$	0.000	kW
Thermostat-off mode	$P_{to}$	0.000	kW	Standby mode	$P_{sb}$	0.015	kW
Other items							
Capacity control		variable		For air-to-air air conditioner: air flow rate, outdoor		5160	m³/h
Sound power level, outdoor	$L_{WA}$	73.0	dB				
Sound power level, indoor	$L_{WA}$	57.0	dB	if engine driven: Emissions of nitrogen oxides	$NO_x^{***}$	-	mg/kWh fuel input GCV
				GWP of the refrigerant		675	kg CO <sub>2</sub> eq (100 years)
Contact details				Panasonic Testing Centre, Panasonic Marketing Europe GmbH Winsbergring 15, 22525 Hamburg, Germany			
** If $C_{dc}$ is not determined by measurement then the default degradation coefficient air conditioners shall be 0.25.							
*** from 26 September 2018.							
Where information relates to multi-split air conditioners, the test result and performance data may be obtained on the basis of the performance of the outdoor unit, with a combination of indoor unit(s) recommended by the manufacturer or importer.							
**** Refer to information requirements for UnitList.							

Information requirements for heat pumps

Model(s):		U-125PZ2E8 S-60PF1E5B x2	
Outdoor side heat exchanger of heat pump:		air	
Indoor side heat exchanger of heat pump:		air	
Indication if the heater is equipped with a supplementary heater:		no	
if applicable: driver of compressor: [electric motor or fuel driven, gaseous or liquid fuel, internal or external combustion engine]		electric motor	

Parameters shall be declared for the average heating season, parameters for the warmer and colder heating seasons are optional.

Item	Symbol	Value	Unit	Item	Symbol	Value	Unit
Rated heating capacity	$P_{rated,h}$	12.5	kW	Seasonal space heating energy efficiency	$\eta_{h,h}$	142.7	%
Refrigeration load	$P_{design,h}$	12.5	kW	Declared coefficient of performance or gas utilization efficiency / auxiliary energy factor for part load at given outdoor temperatures $T_j$			
Declared heating capacity for part load at indoor temperature 20 °C and outdoor temperature $T_j$							
$T_j = -7\text{ °C}$		11.0	kW	$T_j = -7\text{ °C}$		2.3	%
$T_j = +2\text{ °C}$		6.7	kW	$T_j = +2\text{ °C}$		3.4	%
$T_j = +7\text{ °C}$		4.3	kW	$T_j = +7\text{ °C}$		5.3	%
$T_j = +12\text{ °C}$		3.9	kW	$T_j = +12\text{ °C}$		6.2	%
$T_{bw}$ = bivalent temperature	$P_{bh}$	11.0	kW	$T_{bw}$ = bivalent temperature	$COP_d$ or $GUE_{E,ind}$ / $AEF_{E,ind}$	2.3	%
$T_{ol}$ = operation limit		9.1	kW	$T_{ol}$ = operation limit		1.6	%
For air-to-water heat pumps: $T_j = -15\text{ °C}$ (if $T_{ok} < -20\text{ °C}$ )		-	kW	For water-to-air heat pumps: $T_j = -15\text{ °C}$ (if $T_{ok} < -20\text{ °C}$ )		-	%
Bivalent temperature	$T_{bw}$	-7	°C	For water-to-air heat pumps: Operation limit temperature	$T_{ok}$	-15	°C
Degradation co-efficient heat pumps**	$C_{bh}$	0.25	-				
Power consumption in modes other than 'active mode'							
Off mode	$P_{off}$	0.015	kW	Supplementary heater back-up heating capacity*	$e_{bu}$	2.3	kW
Thermostat-off mode	$P_{to}$	0.000	kW	Type of energy input			
Crankcase heater mode	$P_{ck}$	0.000	kW	Standby mode	$P_{sb}$	0.015	kW
Other items							
Capacity control		variable		For air-to-air heat pumps: air flow rate, outdoor		4680	m³/h
Sound power level, outdoor	$L_{WA}$	73.0	dB	For water-/brine-to-air heat pumps: Rated brine or water flow rate, outdoor side heat exchanger		-	m³/h
Sound power level, indoor	$L_{WA}$	57.0	dB	Emissions of nitrogen oxides (if applicable)	$NO_x^{***}$	-	mg/kWh fuel input GCV
				GWP of the refrigerant		675	kg CO <sub>2</sub> eq (100 years)
Contact details				Panasonic Testing Centre, Panasonic Marketing Europe GmbH Winsbergring 15, 22525 Hamburg, Germany			
** If $C_{bh}$ is not determined by measurement then the default degradation coefficient of heat pumps shall be 0.25.							
*** from 26 September 2018.							
Where information relates to multi-split heat pumps, the test result and performance data may be obtained on the basis of the performance of the outdoor unit, with a combination of indoor unit(s) recommended by the manufacturer or importer.							
**** Refer to information requirements for UnitList.							



## Information requirements for air-to-air air conditioners

Model(s):	U-140PZ2E8 S-71PF1E5B x2		
	Outdoor Unit	Indoor Unit	
Outdoor side heat exchanger of air conditioner:	air		
Indoor side heat exchanger of air conditioner:	air		
Type: compressor driven vapour compression or sorption process	vapour compression		
If applicable: driver of compressor: [electric motor or fuel driven, gaseous or liquid fuel, internal or external combustion engine]	electric motor		

Item	Symbol	Value	Unit	Item	Symbol	Value	Unit
Rated cooling capacity	$P_{rated,c}$	14.0	kW	Seasonal space cooling energy efficiency	$\eta_{s,c}$	221.7	%
Refrigeration load	$P_{design,c}$	14.0	kW	Declared energy efficiency ratio or gas utilization efficiency / auxiliary energy factor for part load at given outdoor temperatures $T_j$ and indoor 27°/19°C (dry/wet bulb)			
Declared cooling capacity for part load at given outdoor temperatures $T_j$ and indoor 27°/19°C (dry/wet bulb)	$T_j = +35\text{ °C}$	14.0	kW	$T_j = +35\text{ °C}$	EER <sub>o,or</sub> or GUE <sub>E,bin</sub> / AEF <sub>bin</sub>	3.1	%
	$T_j = +30\text{ °C}$	10.3	kW	$T_j = +30\text{ °C}$		4.7	%
	$T_j = +25\text{ °C}$	6.6	kW	$T_j = +25\text{ °C}$		6.5	%
	$T_j = +20\text{ °C}$	3.8	kW	$T_j = +20\text{ °C}$		7.6	%
Degradation co-efficient for air conditioners**	$C_{dc}$	0.25	-				
Power consumption in modes other than 'active mode'							
Off mode	$P_{off}$	0.015	kW	Crankcase heater mode	$P_{ck}$	0.000	kW
Thermostat-off mode	$P_{to}$	0.000	kW	Standby mode	$P_{sb}$	0.015	kW
Other items							
Capacity control		variable		For air-to-air air conditioner: air flow rate, outdoor		5340	m³/h
Sound power level, outdoor	$L_{WA}$	74.0	dB				
Sound power level, indoor	$L_{WA}$	57.0	dB	if engine driven: Emissions of nitrogen oxides	$NO_x^{***}$	-	mg/kWh fuel input GCV
				GWP of the refrigerant		675	kg CO <sub>2</sub> eq (100 years)
Contact details				Panasonic Testing Centre, Panasonic Marketing Europe GmbH Winsbergring 15, 22525 Hamburg, Germany			
** If $C_{dc}$ is not determined by measurement then the default degradation coefficient air conditioners shall be 0.25. *** from 26 September 2018. Where information relates to multi-split air conditioners, the test result and performance data may be obtained on the basis of the performance of the outdoor unit, with a combination of indoor unit(s) recommended by the manufacturer or importer. **** Refer to information requirements for UnitList							

## Information requirements for heat pumps

Model(s):	U-140PZ2E8 S-71PF1E5B x2		
	Outdoor Unit	Indoor Unit	
Outdoor side heat exchanger of heat pump:	air		
Indoor side heat exchanger of heat pump:	air		
Indication if the heater is equipped with a supplementary heater:	no		
If applicable: driver of compressor: [electric motor or fuel driven, gaseous or liquid fuel, internal or external combustion engine]	electric motor		

Parameters shall be declared for the average heating season, parameters for the warmer and colder heating seasons are optional.

Item	Symbol	Value	Unit	Item	Symbol	Value	Unit
Rated heating capacity	$P_{rated,h}$	14.0	kW	Seasonal space heating energy efficiency	$\eta_{h,h}$	139.4	%
Refrigeration load	$P_{design,h}$	13.6	kW	Declared coefficient of performance or gas utilization efficiency / auxiliary energy factor for part load at given outdoor temperatures °C and outdoor temperature $T_j$			
Declared heating capacity for part load at indoor temperature 20 °C and outdoor temperature $T_j$	$T_j = -7\text{ °C}$	12.0	kW	$T_j = -7\text{ °C}$		2.1	%
	$T_j = +2\text{ °C}$	7.3	kW	$T_j = +2\text{ °C}$		3.4	%
	$T_j = +7\text{ °C}$	4.7	kW	$T_j = +7\text{ °C}$		5.2	%
	$T_j = +12\text{ °C}$	3.9	kW	$T_j = +12\text{ °C}$		6.1	%
$T_{bw}$ = bivalent temperature	$P_{bh}$	12.0	kW	$T_{bw}$ = bivalent temperature	$COP_d$ or GUE <sub>E,bin</sub> / AEF <sub>bin</sub>	2.1	%
$T_{ol}$ = operation limit		9.1	kW	$T_{ol}$ = operation limit		1.6	%
For air-to-water heat pumps: $T_j = -15\text{ °C}$ (if $T_{ol} < -20\text{ °C}$ )		-	kW	For water-to-air heat pumps: $T_j = -15\text{ °C}$ (if $T_{ol} < -20\text{ °C}$ )		-	%
Bivalent temperature	$T_{bw}$	-7	°C	For water-to-air heat pumps: Operation limit temperature	$T_{ol}$	-15	°C
Degradation co-efficient heat pumps**	$C_{bh}$	0.25	-				
Power consumption in modes other than 'active mode'							
Off mode	$P_{off}$	0.015	kW	Supplementary heater back-up heating capacity*	$elbu$	2.7	kW
Thermostat-off mode	$P_{to}$	0.000	kW	Type of energy input			
Crankcase heater mode	$P_{ck}$	0.000	kW	Standby mode	$P_{sb}$	0.015	kW
Other items							
Capacity control		variable		For air-to-air heat pumps: air flow rate, outdoor		4980	m³/h
Sound power level, outdoor	$L_{WA}$	74.0	dB	For water-/brine-to-air heat pumps: Rated brine or water flow rate, outdoor side heat exchanger		-	m³/h
Sound power level, indoor	$L_{WA}$	57.0	dB	Emissions of nitrogen oxides (if applicable)	$NO_x^{***}$	-	mg/kWh fuel input GCV
				GWP of the refrigerant		675	kg CO <sub>2</sub> eq (100 years)
Contact details				Panasonic Testing Centre, Panasonic Marketing Europe GmbH Winsbergring 15, 22525 Hamburg, Germany			
** If $C_{bh}$ is not determined by measurement then the default degradation coefficient of heat pumps shall be 0.25. *** from 26 September 2018. Where information relates to multi-split heat pumps, the test result and performance data may be obtained on the basis of the performance of the outdoor unit, with a combination of indoor unit(s) recommended by the manufacturer or importer. **** Refer to information requirements for UnitList							

Information requirements for air-to-air air conditioners

Model(s):	Outdoor Unit Indoor Unit	U-125PZ2E8 S-125PF1E5B
Outdoor side heat exchanger of air conditioner:	air	
Indoor side heat exchanger of air conditioner:	air	
Type: compressor driven vapour compression or sorption process	vapour compression	
if applicable: driver of compressor: [electric motor or fuel driven, gaseous or liquid fuel, internal or external combustion engine]	electric motor	

Item	Symbol	Value	Unit	Item	Symbol	Value	Unit
Rated cooling capacity	$P_{rated,c}$	12.5	kW	Seasonal space cooling energy efficiency	$\eta_{s,c}$	218.5	%
Refrigeration load	$P_{design,c}$	12.5	kW	Declared energy efficiency ratio or gas utilization efficiency / auxiliary energy factor for part load at given outdoor temperatures $T_j$ and indoor 27°/19°C (dry/wet bulb)			
Declared cooling capacity for part load at given outdoor temperatures $T_j$ and indoor 27°/19°C (dry/wet bulb)	$T_j = +35\text{ °C}$	12.5	kW	$T_j = +35\text{ °C}$	$EER_x$ or $GUE_{E,bin}$	3.5	%
	$T_j = +30\text{ °C}$	9.2	kW	$T_j = +30\text{ °C}$	$GUE_{E,bin}$ / $AEF_{E,bin}$	4.9	%
	$T_j = +25\text{ °C}$	5.9	kW	$T_j = +25\text{ °C}$		7.2	%
	$T_j = +20\text{ °C}$	3.8	kW	$T_j = +20\text{ °C}$		9.5	%
Degradation co-efficient for air conditioners**	$C_{dc}$	0.25	-				
Power consumption in modes other than 'active mode'							
Off mode	$P_{off}$	0.023	kW	Crankcase heater mode	$P_{ck}$	0.000	kW
Thermostat-off mode	$P_{to}$	0.215	kW	Standby mode	$P_{sb}$	0.023	kW
Other items							
Capacity control		variable		For air-to-air air conditioner: air flow rate, outdoor		5160	m³/h
Sound power level, outdoor	$L_{WA}$	73.0	dB				
Sound power level, indoor	$L_{WA}$	61.0	dB	if engine driven: Emissions of nitrogen oxides	$NO_x^{***}$	-	mg/kWh fuel input GCV
				GWP of the refrigerant		675	kg CO <sub>2</sub> eq (100 years)
Contact details				Panasonic Testing Centre, Panasonic Marketing Europe GmbH Winsbergring 15, 22525 Hamburg, Germany			
** If $C_{dc}$ is not determined by measurement then the default degradation coefficient air conditioners shall be 0.25.							
*** from 26 September 2018.							
Where information relates to multi-split air conditioners, the test result and performance data may be obtained on the basis of the performance of the outdoor unit, with a combination of indoor unit(s) recommended by the manufacturer or importer.							
**** Refer to information requirements for UnitList							

Information requirements for heat pumps

Model(s):	Outdoor Unit Indoor Unit	U-125PZ2E8 S-125PF1E5B
Outdoor side heat exchanger of heat pump:	air	
Indoor side heat exchanger of heat pump:	air	
Indication if the heater is equipped with a supplementary heater:	no	
if applicable: driver of compressor: [electric motor or fuel driven, gaseous or liquid fuel, internal or external combustion engine]	electric motor	

Parameters shall be declared for the average heating season, parameters for the warmer and colder heating seasons are optional.

Item	Symbol	Value	Unit	Item	Symbol	Value	Unit
Rated heating capacity	$P_{rated,h}$	12.5	kW	Seasonal space heating energy efficiency	$\eta_{h,h}$	141.5	%
Refrigeration load	$P_{design,h}$	12.5	kW	Declared coefficient of performance or gas utilization efficiency / auxiliary energy factor for part load at given outdoor temperatures °C and outdoor temperature $T_j$			
Declared heating capacity for part load at indoor temperature 20 °C and outdoor temperature $T_j$	$T_j = -7\text{ °C}$	11.0	kW	$T_j = -7\text{ °C}$		2.3	%
	$T_j = +2\text{ °C}$	6.7	kW	$T_j = +2\text{ °C}$		3.4	%
	$T_j = +7\text{ °C}$	4.3	kW	$T_j = +7\text{ °C}$		5.3	%
	$T_j = +12\text{ °C}$	3.9	kW	$T_j = +12\text{ °C}$		6.2	%
$T_{bw}$ = bivalent temperature		11.0	kW	$T_{bw}$ = bivalent temperature	$COP_d$ or $GUE_{E,bin}$ / $AEF_{E,bin}$	2.3	%
$T_{ol}$ = operation limit		9.1	kW	$T_{ol}$ = operation limit		1.6	%
For air-to-water heat pumps: $T_j = -15\text{ °C}$ (if $T_{ok} < -20\text{ °C}$ )		-	kW	For water-to-air heat pumps: $T_j = -15\text{ °C}$ (if $T_{ok} < -20\text{ °C}$ )		-	%
Bivalent temperature	$T_{bw}$	-7	°C	For water-to-air heat pumps: Operation limit temperature	$T_{ok}$	-15	°C
Degradation co-efficient heat pumps**	$C_{dh}$	0.25	-				
Power consumption in modes other than 'active mode'							
Off mode	$P_{off}$	0.023	kW	back-up heating capacity*	$e_{bu}$	2.3	kW
Thermostat-off mode	$P_{to}$	0.215	kW	Type of energy input			
Crankcase heater mode	$P_{ck}$	0.000	kW	Standby mode	$P_{sb}$	0.023	kW
Other items							
Capacity control		variable		For air-to-air heat pumps: air flow rate, outdoor		4680	m³/h
Sound power level, outdoor	$L_{WA}$	73.0	dB	For water-/brine-to-air heat pumps: Rated brine or water flow rate, outdoor side heat exchanger		-	m³/h
Sound power level, indoor	$L_{WA}$	61.0	dB	Emissions of nitrogen oxides (if applicable)	$NO_x^{***}$	-	mg/kWh fuel input GCV
				GWP of the refrigerant		675	kg CO <sub>2</sub> eq (100 years)
Contact details				Panasonic Testing Centre, Panasonic Marketing Europe GmbH Winsbergring 15, 22525 Hamburg, Germany			
** If $C_{dh}$ is not determined by measurement then the default degradation coefficient of heat pumps shall be 0.25.							
*** from 26 September 2018.							
Where information relates to multi-split heat pumps, the test result and performance data may be obtained on the basis of the performance of the outdoor unit, with a combination of indoor unit(s) recommended by the manufacturer or importer.							
**** Refer to information requirements for UnitList							

### Information requirements for air-to-air air conditioners

Model(s):	Outdoor Unit Indoor Unit	U-140PZ2E8 S-140PF1E5B
Outdoor side heat exchanger of air conditioner:	air	
Indoor side heat exchanger of air conditioner:	air	
Type: compressor driven vapour compression or sorption process	vapour compression	
if applicable: driver of compressor: [electric motor or fuel driven, gaseous or liquid fuel, internal or external combustion engine]	electric motor	

Item	Symbol	Value	Unit	Item	Symbol	Value	Unit
Rated cooling capacity	$P_{rated,c}$	14.0	kW	Seasonal space cooling energy efficiency	$\eta_{s,c}$	211.8	%
Refrigeration load	$P_{design,c}$	14.0	kW	Declared energy efficiency ratio or gas utilization efficiency / auxiliary energy factor for part load at given outdoor temperatures $T_j$ and indoor 27°/19°C (dry/wet bulb)			
Declared cooling capacity for part load at given outdoor temperatures $T_j$ and indoor 27°/19°C (dry/wet bulb)	$T_j = +35\text{ °C}$	14.0	kW	$T_j = +35\text{ °C}$		3.1	%
	$T_j = +30\text{ °C}$	10.3	kW	$T_j = +30\text{ °C}$	EER <sub>o,of</sub> or GUE <sub>E,dbn</sub> / AEF <sub>o,dbn</sub>	4.7	%
	$T_j = +25\text{ °C}$	6.6	kW	$T_j = +25\text{ °C}$		7.0	%
	$T_j = +20\text{ °C}$	3.8	kW	$T_j = +20\text{ °C}$		8.9	%
Degradation co-efficient for air conditioners**	$C_{dc}$	0.25	-				
Power consumption in modes other than 'active mode'							
Off mode	$P_{off}$	0.023	kW	Crankcase heater mode	$P_{ck}$	0.000	kW
Thermostat-off mode	$P_{ro}$	0.223	kW	Standby mode	$P_{sb}$	0.023	kW
Other items							
Capacity control		variable		For air-to-air air conditioner: air flow rate, outdoor		5340	m³/h
Sound power level, outdoor	$L_{WA}$	74.0	dB				
Sound power level, indoor	$L_{WA}$	62.0	dB	if engine driven: Emissions of nitrogen oxides	$NO_x^{***}$	-	mg/kWh fuel input GCV
				GWP of the refrigerant		675	kg CO <sub>2</sub> eq (100 years)
Contact details				Panasonic Testing Centre, Panasonic Marketing Europe GmbH Winsbergweg 15, 22525 Hamburg, Germany			
** If $C_{dc}$ is not determined by measurement then the default degradation coefficient air conditioners shall be 0.25. *** from 26 September 2018. Where information relates to multi-split air conditioners, the test result and performance data may be obtained on the basis of the performance of the outdoor unit, with a combination of indoor unit(s) recommended by the manufacturer or importer. **** Refer to information requirements for UnitList							

### Information requirements for heat pumps

Model(s):	Outdoor Unit Indoor Unit	U-140PZ2E8 S-140PF1E5B
Outdoor side heat exchanger of heat pump:	air	
Indoor side heat exchanger of heat pump:	air	
Indication if the heater is equipped with a supplementary heater:	no	
if applicable: driver of compressor: [electric motor or fuel driven, gaseous or liquid fuel, internal or external combustion engine]	electric motor	

Parameters shall be declared for the average heating season, parameters for the warmer and colder heating seasons are optional.

Item	Symbol	Value	Unit	Item	Symbol	Value	Unit
Rated heating capacity	$P_{rated,h}$	14.0	kW	Seasonal space heating energy efficiency	$\eta_{s,h}$	138.4	%
Refrigeration load	$P_{design,h}$	13.6	kW	Declared coefficient of performance or gas utilization efficiency / auxiliary energy factor for part load at given outdoor temperatures °C and outdoor temperature $T_j$			
Declared heating capacity for part load at indoor temperature 20 °C and outdoor temperature $T_j$	$T_j = -7\text{ °C}$	12.0	kW	$T_j = -7\text{ °C}$		2.1	%
	$T_j = +2\text{ °C}$	7.3	kW	$T_j = +2\text{ °C}$		3.4	%
	$T_j = +7\text{ °C}$	4.7	kW	$T_j = +7\text{ °C}$		5.2	%
	$T_j = +12\text{ °C}$	3.9	kW	$T_j = +12\text{ °C}$		6.1	%
$T_{bv}$ = bivalent temperature	$P_{bh}$	12.0	kW	$T_{bv}$ = bivalent temperature	COP <sub>d</sub> or GUE <sub>E,dbn</sub> / AEF <sub>h,dbn</sub>	2.1	%
$T_{ol}$ = operation limit		9.1	kW	$T_{ol}$ = operation limit		1.6	%
For air-to-water heat pumps: $T_j = -15\text{ °C}$ (if $T_{ol} < -20\text{ °C}$ )		-	kW	For water-to-air heat pumps: $T_j = -15\text{ °C}$ (if $T_{ol} < -20\text{ °C}$ )		-	%
Bivalent temperature	$T_{bv}$	-7	°C	For water-to-air heat pumps: Operation limit temperature	$T_{ol}$	-15	°C
Degradation co-efficient heat pumps**	$C_{dh}$	0.25	-				
Power consumption in modes other than 'active mode'							
Off mode	$P_{off}$	0.023	kW	Supplementary heater back-up heating capacity*	$e_{bu}$	2.7	kW
Thermostat-off mode	$P_{ro}$	0.223	kW	Type of energy input			
Crankcase heater mode	$P_{ck}$	0.000	kW	Standby mode	$P_{sb}$	0.023	kW
Other items							
Capacity control		variable		For air-to-air heat pumps: air flow rate, outdoor		4980	m³/h
Sound power level, outdoor	$L_{WA}$	74.0	dB	For water/brine-to-air heat pumps: Rated brine or water flow rate, outdoor side heat exchanger		-	m³/h
Sound power level, indoor	$L_{WA}$	62.0	dB	Emissions of nitrogen oxides (if applicable)	$NO_x^{***}$	-	mg/kWh fuel input GCV
				GWP of the refrigerant		675	kg CO <sub>2</sub> eq (100 years)
Contact details				Panasonic Testing Centre, Panasonic Marketing Europe GmbH Winsbergweg 15, 22525 Hamburg, Germany			
** If $C_{dh}$ is not determined by measurement then the default degradation coefficient of heat pumps shall be 0.25. *** from 26 September 2018. Where information relates to multi-split heat pumps, the test result and performance data may be obtained on the basis of the performance of the outdoor unit, with a combination of indoor unit(s) recommended by the manufacturer or importer. **** Refer to information requirements for UnitList							

– MEMO –

## 2. TEST RUN

- U-100PZ2E5, U-125PZ2E5, U-140PZ2E5,  
U-100PZ2E8, U-125PZ2E8, U-140PZ2E8

2-1. PRECAUTIONS REGARDING TEST RUN .....	2-2
2-2. CHECKS AFTER INSTALLATION HAVE COMPLETED .....	2-3
2-3. REGARDING DELIVERY TO THE CUSTOMER .....	2-3

■ U-100PZ2E5, U-125PZ2E5, U-140PZ2E5,  
U-100PZ2E8, U-125PZ2E8, U-140PZ2E8

2-1. PRECAUTIONS REGARDING TEST RUN

Check Before Test Run

	Content check
Power supply cable Indoor/outdoor connection wire Earth wire	<ul style="list-style-type: none"> <li>Is the wire set up and connected as described in the instructions? Check for any phase sequence.</li> <li>Are the wire connection's screws loose?</li> <li>Is the open and close device / leakage breaker installed?</li> <li>Is the power supply cable's thickness and length appropriately measured as described in the instructions?</li> <li>Is it earthed (grounded)?</li> <li>Check that the insulation resistant value is more than 100MΩ. Use the 500 V mega-testers to measure the insulation. Do not use the mega-tester for any other circuit except for voltage of 220-230-240V~ or 380-400-415V 3N~.</li> <li>Are the wire connections for the indoor/outdoor units connected as described in the instructions? Are there any looped wires?</li> <li>Was the "N-phase" surely connected when connecting the power supply wire on the three-phase model? If N-phase is not connected, only the fan may repeat turning ON/OFF without the compressor operating. In that case, check if there is any problem with N-phase connection.</li> </ul>
Refrigerant pipe	<ul style="list-style-type: none"> <li>Is the piping installed as described in the instructions?</li> <li>Are the pipes sizes appropriate?</li> <li>Does the pipe's length adhere to the specifications?</li> <li>Is the branch pipe slant being appropriately done as described in the instructions?</li> <li>Was vacuum removal sufficiently carried out?</li> <li>Was the leak tightness test carried out with nitrogen gas? Use the testing pressure of 4.15 MPa.</li> <li>Is the piping insulation material appropriately installed? (Insulation material is necessary for both gas and liquid piping.)</li> <li>Is the 3-way valve for the liquid side and gas side open?</li> </ul>

- Always be sure to use a properly insulated tool to operate the short-circuit pin on the circuit board. (Do not use your finger.)
- Never switch the power supply ON until the installation has completed.
- Supply electrical current through all indoor units and check the voltage.
- Supply electrical current through all the outdoor units and check each inter-phase voltage.
- Before the test run, ensure to check that the 3-way valve is open. Operating while the valve is closed causes the compressor to fail.

Test Run Procedure

- If there are duplicated system addresses, or if the settings for the Nos. of the indoor units are not consistent, an alarm will occur and the system will not start.
- Switch the power supply ON both indoor and outdoor unit.
- Short-circuit CHK pin on the outdoor main PCB.  
Do not remove CHK pin until test run is completed.  
Removing CHK pin stops test run.
- Short-circuit RUN pin on the outdoor main PCB for one second or longer.  
Factory setting is cooling operation mode and cooling operation test run starts.  
If heating operation starts, short-circuit both right side and centre of the MODE pin (centre and COOL) continuously.
- Ensure to conduct a test run. In addition, be sure to run the cooling operation test run for at least 20 minutes before starting the heating operation test run.
- To conduct heating operation test run, short-circuit left side and centre of the MODE pin (centre and HEAT) continuously.
- Removing CHK pin's and MODE pin's short-circuit stops test run.
- For the test run using remote control unit, please see installation instructions included with the remote control unit.

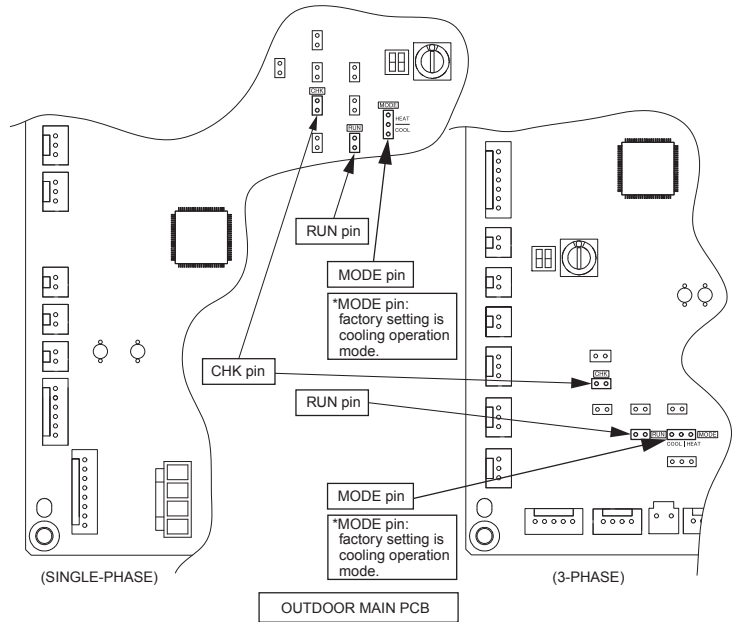
Caution for Pump Down

Pump down means refrigerant gas in the system is returned to the outdoor unit. Pump down is used when the unit is to be moved, or before servicing the refrigerant circuit.

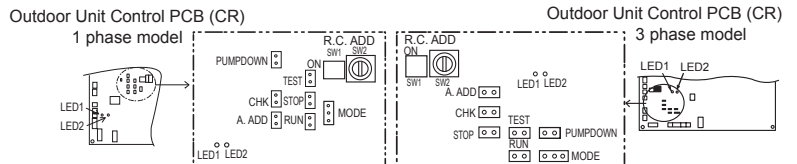
How to perform Pump-Down (Refrigerant recovery) properly

- Stop operation of the unit (cooling, heating etc.).
- Connect the pressure gauge to the service port of the gas wiring valve.
- Short-circuit the 「PUMPDOWN」 pin on an outdoor unit control PCB (CR) for more than 1 second to release.
  - Pump-Down begins and the unit starts operating.
  - During Pump-Down, LED1 blinks and LED2 is lit on an outdoor unit control PCB (CR).
  - 「CHK」 blinks on the remote controller.
- Fully close the liquid wiring valve 2-3 minutes later.  
The Pump-Down will begin.
- When the pressure gauge drops to 0.1-0.2MPa, close the gas wiring valve tightly and short-circuit the 「PUMPDOWN」 pin for more than 1 second to release. That is the end of Pump-Down.
  - When running for more than 10 minutes, it stops even if the Pump-Down is not completed. Check the blocked state of the liquid side valve.
  - It also stops when the 「PUMPDOWN」 pin is short-circuited during the operation.

※ For compressor protection, do not operate to the point where the unit wiring side reaches negative pressure.



Note : In the case that inter-unit wiring is 30m or longer, you cannot pump-down. (It may trigger the operation of the overload protection device.) In this case, perform pump-down with pump-down device.



## 2-2. CHECKS AFTER INSTALLATION HAVE COMPLETED

- Check the following items after completing installation.
  - Is there a short circuit with the intake air flow?
  - Is the insulation secure? (Refrigerant piping)
  - Are there any errors with the wiring?
  - Are the terminal screws loose? Tightening torque (Unit: N•m {kgf•cm})  
M4...1.57~1.96{16~20}, M5...1.96~2.45{20~25}
  - Is the drain water flowing smoothly?
  - Is the insulation material properly installed?
  - Is the earth wire securely connected?
  - Is the front panel and the indoor unit air conditioner firmly fixed and was the installation completed without any leakage from the refrigerant?
  - Are the indoor and outdoor units secured firmly installed with bolts at secured locations?

## 2-3. REGARDING DELIVERY TO THE CUSTOMER

- Request the customer to review the operating instructions and explain the operating method for the product.
- In addition, it is also recommended that regular inspection checks are agreed upon for maintenance.

User inspection places	<ul style="list-style-type: none"><li>• Filter and grill cleaning</li><li>• Exterior cleaning</li></ul>
Serviceman inspection places	<ul style="list-style-type: none"><li>• Check the operating status</li><li>• Clean the drain pan or things related to the water discharge</li><li>• Heat exchanger cleaning</li></ul>

Refer to the installation instruction manual provided with the indoor unit for the specifications on the indoor unit installation.

– MEMO –



## 3. ELECTRICAL DATA

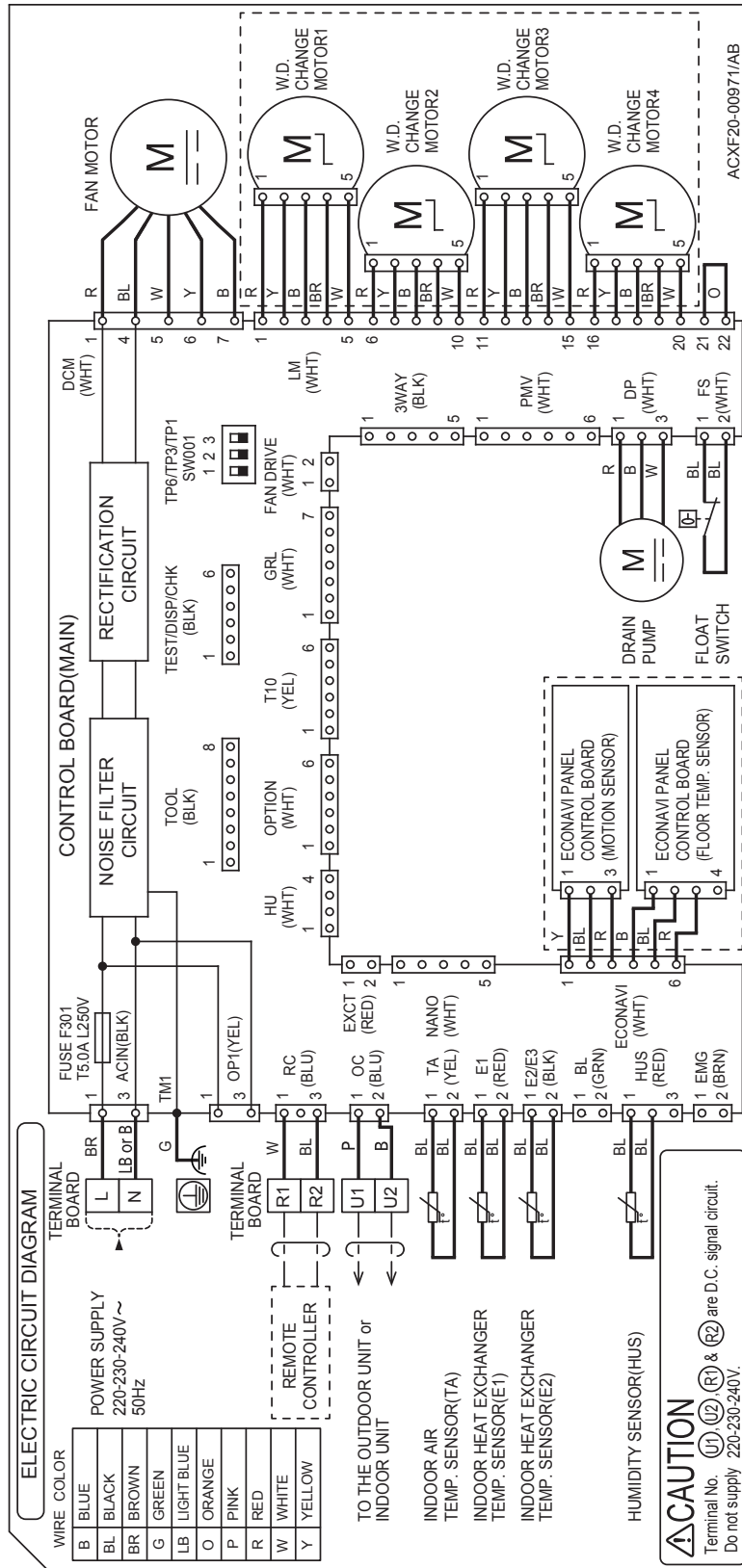
<b>3-1. Indoor Units (Electric Wiring Diagram) .....</b>	<b>3-2</b>
4-Way Cassette Type .....	3-2
Ceiling Type .....	3-3
Low Silhouette Ducted Type .....	3-4
Wall Mounted Type .....	3-5
<b>3-2. Outdoor Units (Electric Wiring Diagram) .....</b>	<b>3-6</b>

### 3-1. Indoor Units

#### 4-Way Cassette Type

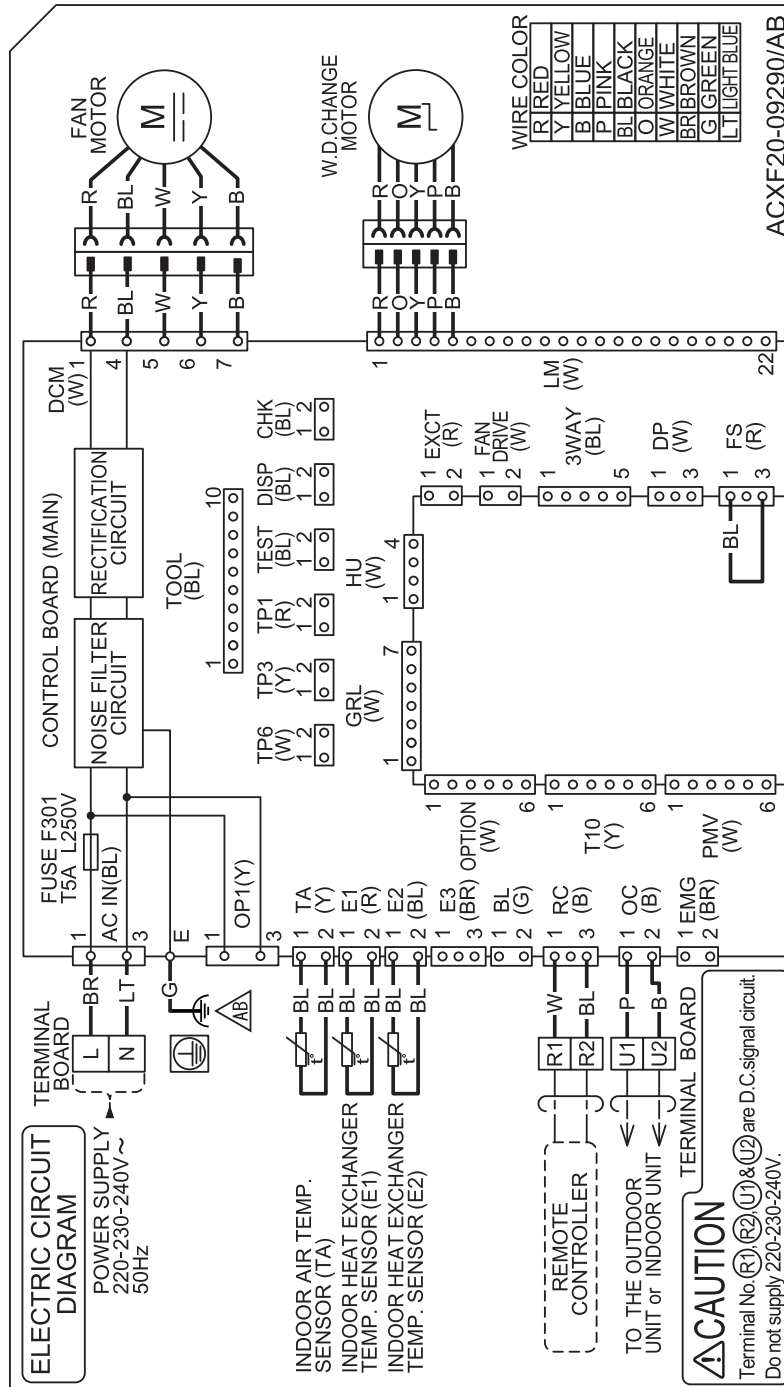
S-50PU2E5B / S-60PU2E5B / S-71PU2E5B / S-100PU2E5B / S-125PU2E5B / S-140PU2E5B

#### Electric Wiring Diagram



### 3-1. Indoor Units

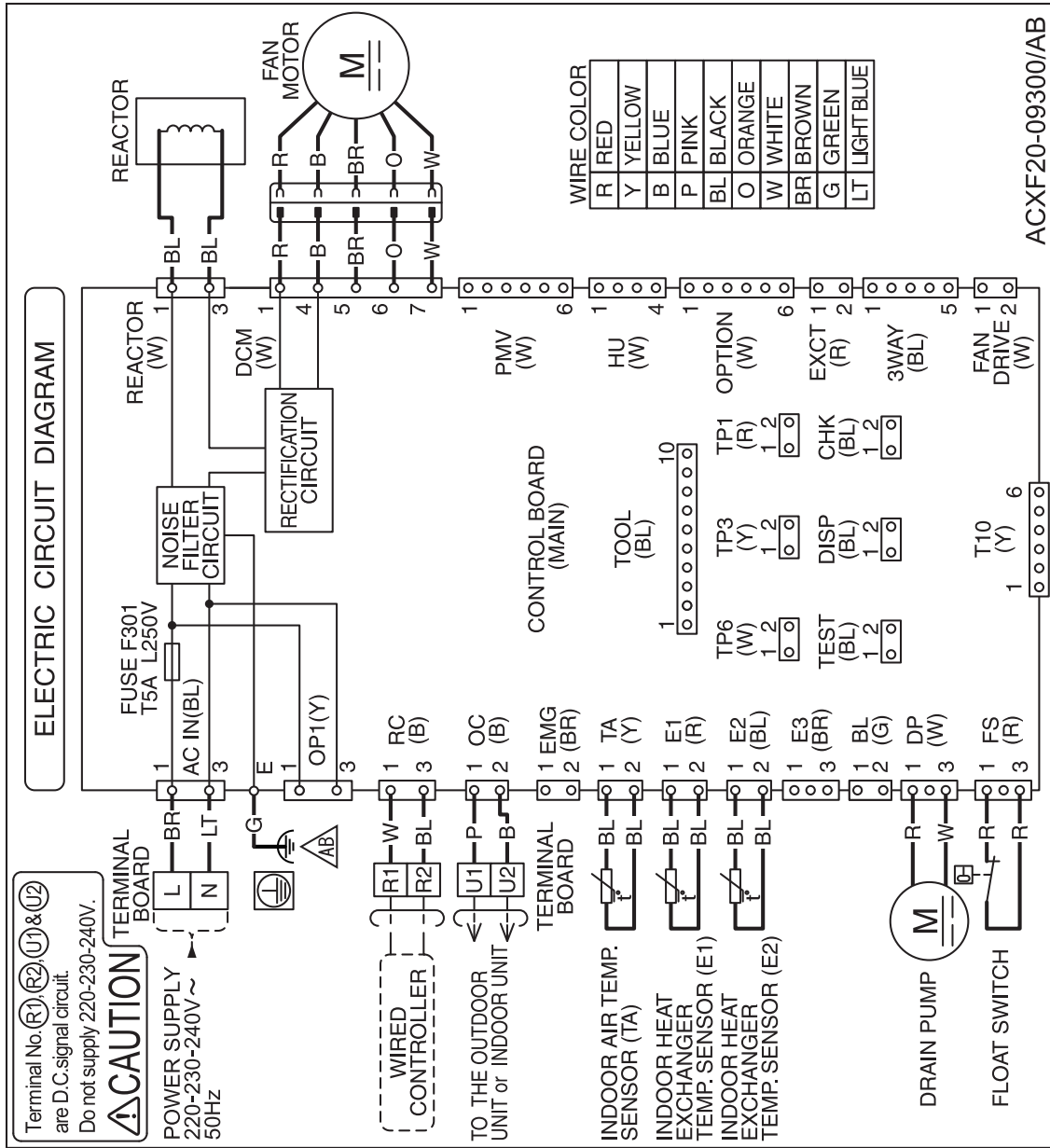
- Ceiling Type S-50PT2E5B / S-60PT2E5B / S-71PT2E5B / S-100PT2E5B / S-125PT2E5B / S-140PT2E5B
- Electric Wiring Diagram



### 3-1. Indoor Units

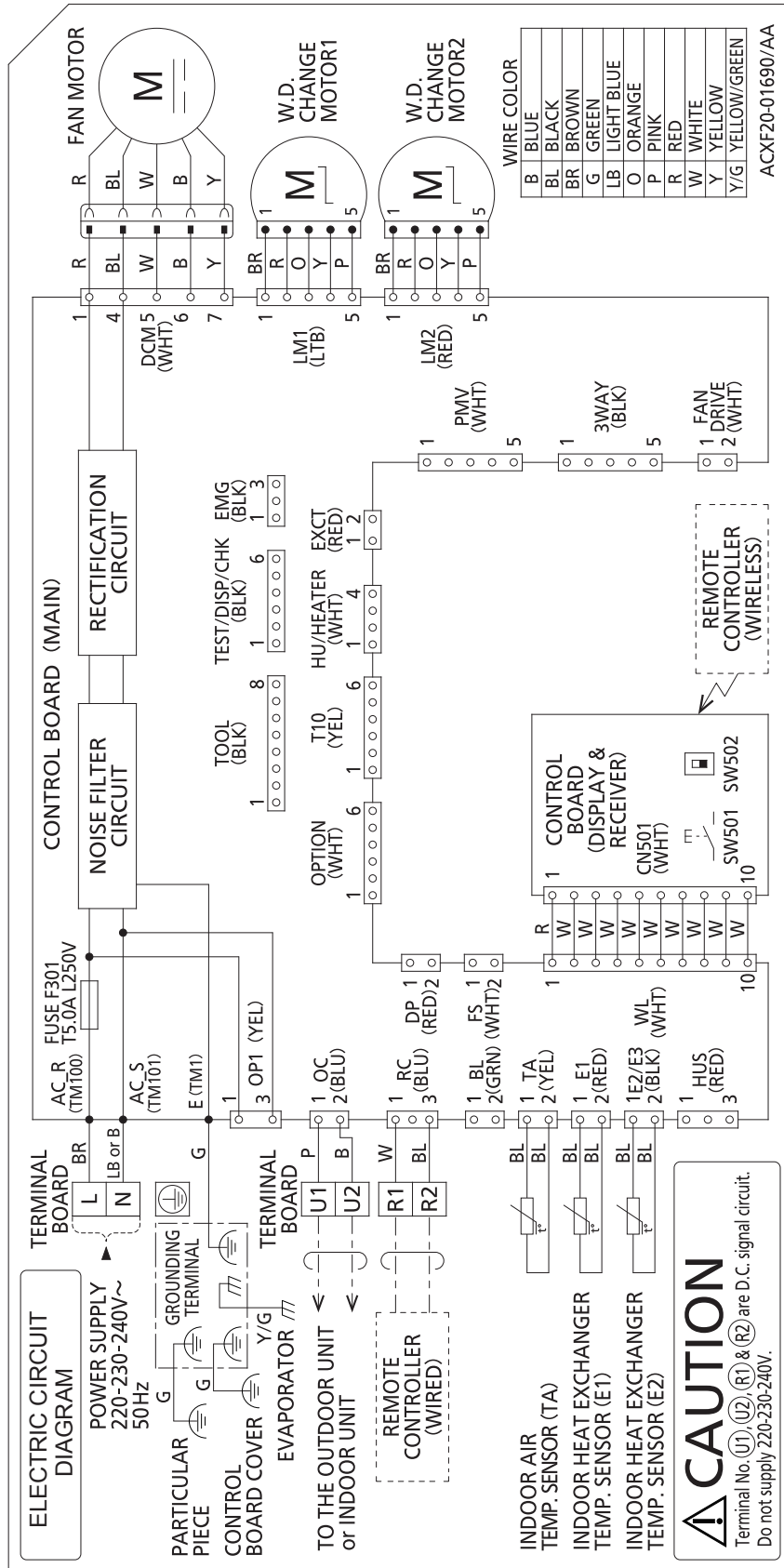
■ Low Silhouette Ducted Type S-50PF1E5B / S-60PF1E5B / S-71PF1E5B / S-100PF1E5B / S-125PF1E5B / S-140PF1E5B

#### Electric Wiring Diagram



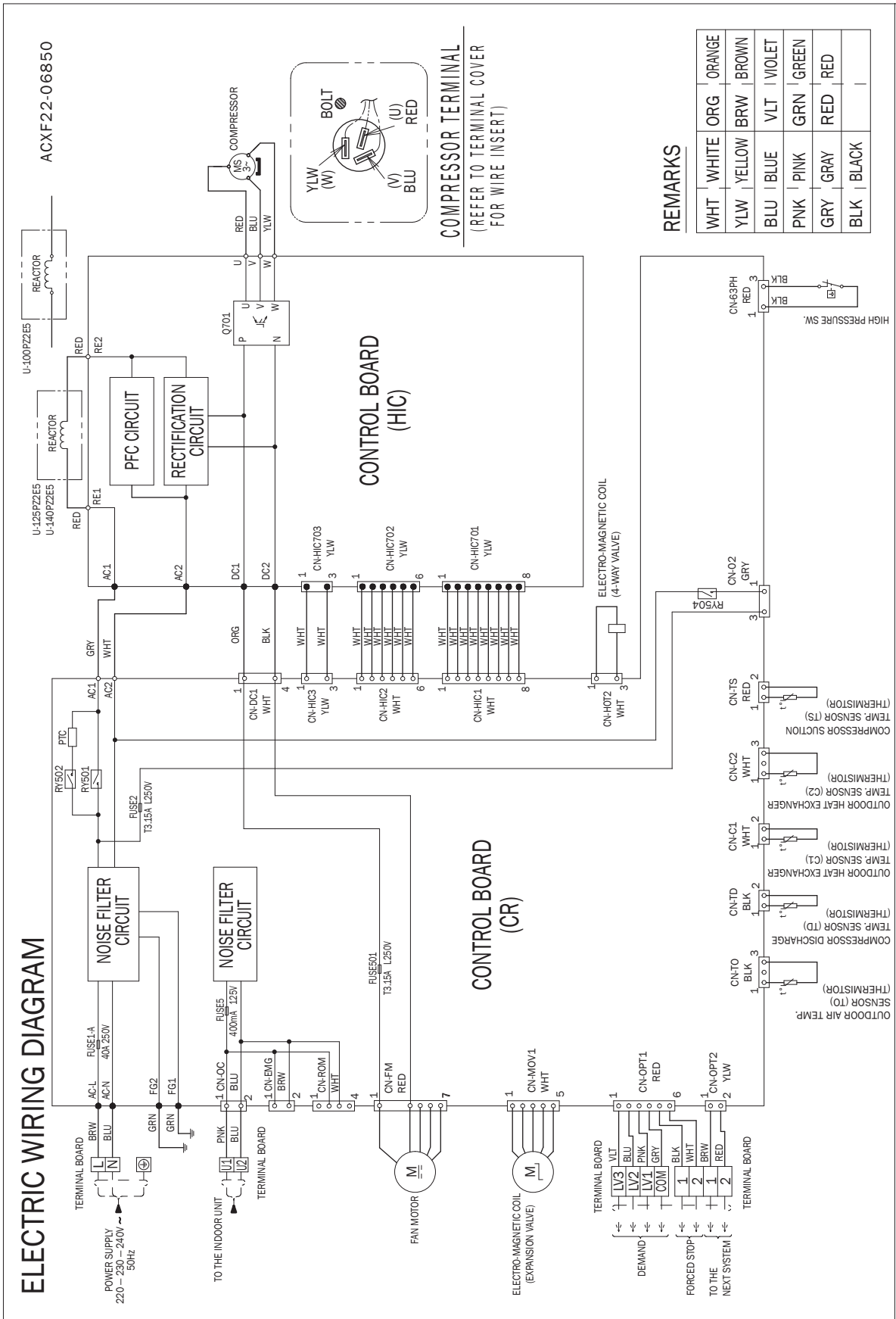
### 3-1. Indoor Units

#### Wall Mounted Type S-50PK2E5B / S-60PK2E5B / S-71PK2E5B / S-100PK2E5B Electric Wiring Diagram



### 3-2. Outdoor Units

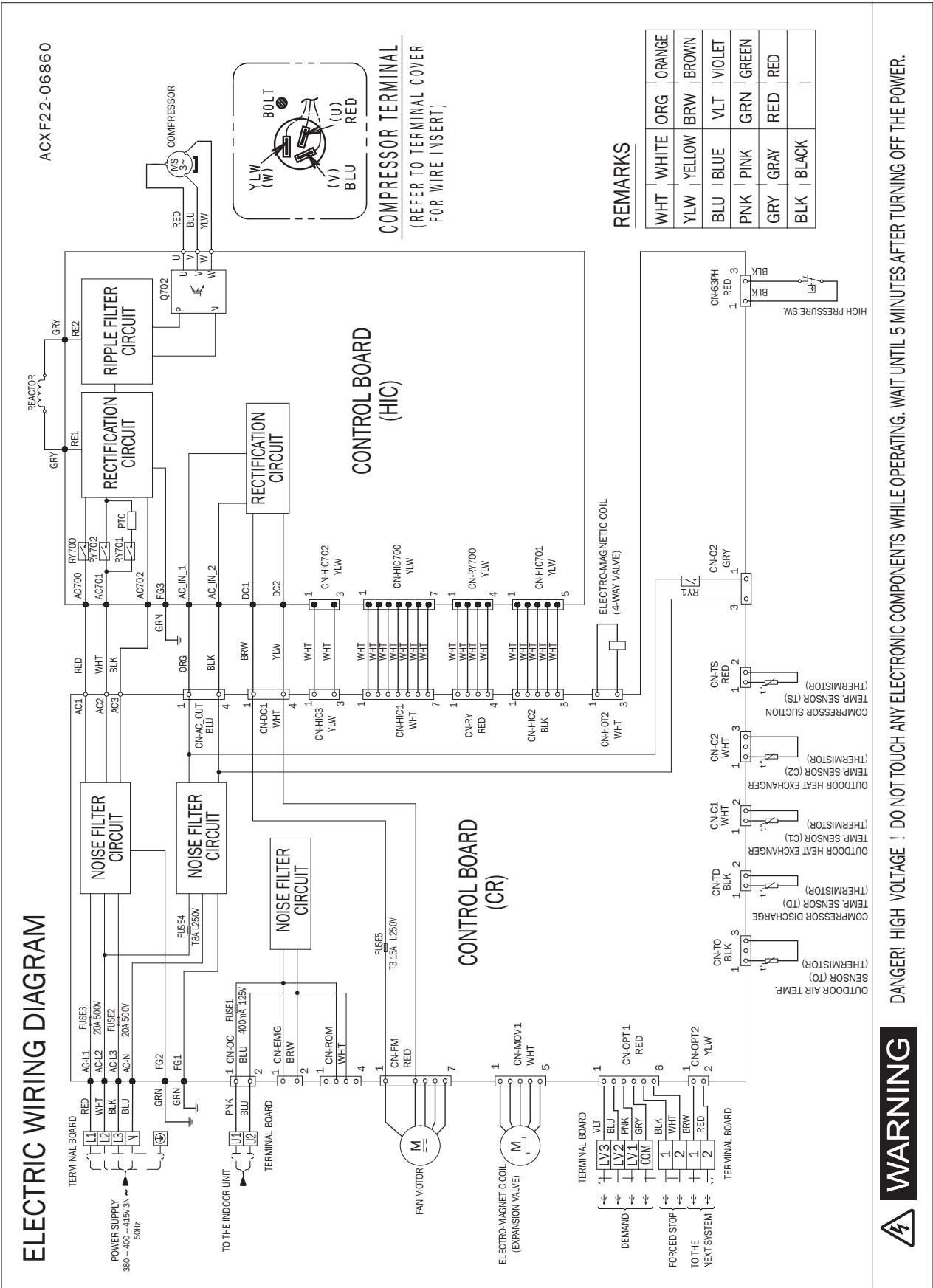
#### Electric Wiring Diagram U-100PZ2E5 / U-125PZ2E5 / U-140PZ2E5



**WARNING** DANGER! HIGH VOLTAGE ! DO NOT TOUCH ANY ELECTRONIC COMPONENTS WHILE OPERATING. WAIT UNTIL 5 MINUTES AFTER TURNING OFF THE POWER.

### 3-2. Outdoor Units

#### Electric Wiring Diagram U-100PZ2E8 / U-125PZ2E8 / U-140PZ2E8



– MEMO –



## 4. CONTROL FUNCTIONS

4-1.	Room Temperature Control.....	4-2
4-2.	Heating Standby.....	4-4
4-3.	Automatic Fan Speed Control.....	4-5
4-4.	Drain Pump Control .....	4-6
4-5.	Automatic Heating/Cooling Control .....	4-7
4-6.	Automatic Flap Control .....	4-8
4-7.	Filter Sign .....	4-8
4-8.	Fan Control during Dry Mode .....	4-9
4-9.	Ventilation Fan Output.....	4-9
4-10.	T10 Terminal .....	4-9
4-11.	Parameter .....	4-10
4-12.	Control Functions .....	4-11
4-13.	Outdoor Units Control PCB (CR-PCB, HIC-PCB) .....	4-17
4-14.	Functions of Outdoor Unit PCB.....	4-23
4-15.	Self-Diagnostics Function Table.....	4-26

**4-1. Room Temperature Control**

- The body sensor or remote controller sensor detects temperature in the room. The detected temperature is called the room temperature. The body sensor is the one contained in the indoor unit.

	Body sensor is enabled	Remote controller sensor is enabled
Set temp.	Set temp. in remote controller	Set temp. in remote controller
Detected temp. by sensor	Detected temp. by body sensor	Detected temp. by remote controller sensor
Room temp.	Detected temp. by body sensor - *correction temp.	Detected temp. by remote controller sensor

- The thermostat is turned ON or OFF according to the following  $\Delta T$ .

$\Delta T$ (Cooling)	$\Delta T = \text{room temp.} - \text{set temp. (set temp. in remote controller)}$
$\Delta T$ (Heating)	$\Delta T = \text{set temp.} - \text{room temp.}$

※ Correction temperature (only during heating)

If the indoor unit is installed on the ceiling, temperature near the ceiling is higher than near the floor. When the body sensor is enabled, lower temperature near the floor must be considered. To correct this difference in temperature, the correction temperature is used.

The factory setting for the correction temperature is different depending on the model. Refer to “4-11. Parameter”.

Example: Cooling temperature correction  
 4-Way Cassette (correction temperature: 0 degrees)  
 Body sensor is enabled

Example: Heating temperature correction  
 4-Way Cassette (correction temperature: 4 degrees)  
 Body sensor is enabled

Set temp. in remote controller	28°C	28°C	28°C
Detected temp. by sensor	30.0°C	27.5°C	27.0°C
Detected temp. by body sensor	30.0°C	27.5°C	27.0°C
Detected temp. by remote controller sensor	30.0°C	27.5°C	27.0°C
Room temp. = temp. detected by body sensor	30.0°C =30.0	27.5°C =27.5	27.0°C =27.0
$\Delta T$	+2.0deg	-0.5deg	-1.0deg
	Thermostat ON	Thermostat ON	Thermostat OFF

Set temp. in remote controller	20°C	20°C	20°C
Detected temp. by sensor	17.0°C	22.0°C	25.0°C
Detected temp. by body sensor	17.0°C	22.0°C	25.0°C
Detected temp. by remote controller sensor	13.0°C	18.0°C	21.0°C
Room temp. = temp. detected by body sensor – 4 deg	13.0°C =17.0-4 deg	18.0°C =22.0-4 deg	21.0°C =25.0-4 deg
$\Delta T$	+7.0deg	+2.0deg	-1.0deg
	Thermostat ON	Thermostat ON	Thermostat OFF

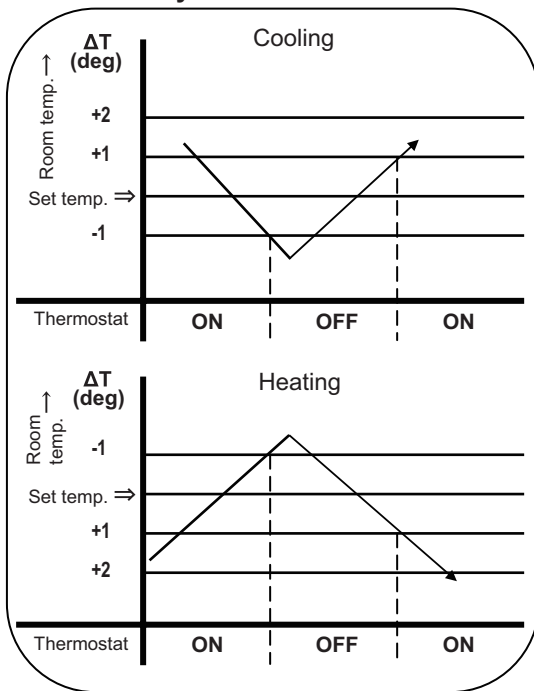
Remote controller sensor is enabled

Set temp. in remote controller	28°C	28°C	28°C
Detected temp. by sensor	30.0°C	27.5°C	27.0°C
Detected temp. by body sensor	30.0°C	27.5°C	27.0°C
Detected temp. by remote controller sensor	30.0°C	27.5°C	27.0°C
Room temp. = temp. detected by remote controller sensor	30.0°C =30.0	27.5°C =27.5	27.0°C =27.0
$\Delta T$	+2.0deg	-0.5deg	-1.0deg
	Thermostat ON	Thermostat OFF	Thermostat OFF

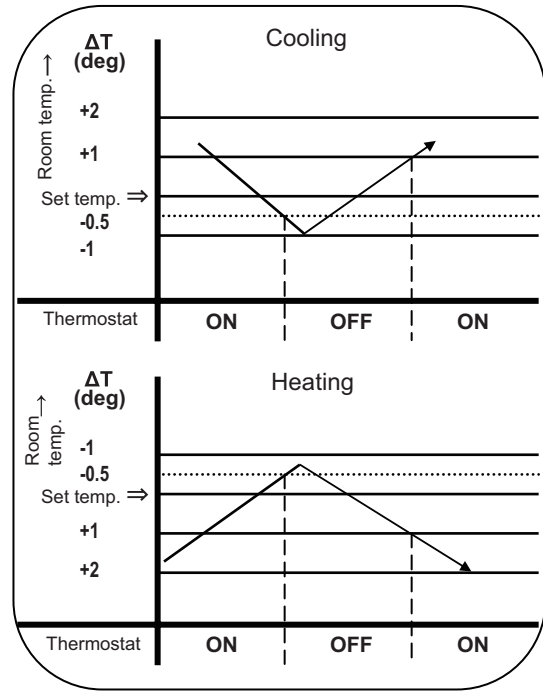
Remote controller sensor is enabled

Set temp. in remote controller	20°C	20°C	20°C
Detected temp. by sensor	17.0°C	20.5°C	21.0°C
Detected temp. by body sensor	21.0°C	24.5°C	25.0°C
Detected temp. by remote controller sensor	17.0°C	20.5°C	21.0°C
Room temp. = temp. detected by remote controller sensor	17.0°C =17.0	20.5°C =20.5	21.0°C =21.0
$\Delta T$	+3.0deg	-0.5deg	-1.0deg
	Thermostat ON	Thermostat OFF	Thermostat OFF

Body sensor is enabled




Remote controller sensor is enabled



- ① The thermostat does not turn OFF for 3 minutes after it turns ON.
- ② The thermostat does not turn ON 1 to 3 minutes after it turns OFF.
- ③ The thermostat does not turn OFF for 60 minutes during the test run mode. (Forced thermostat ON)  
\*However, the thermostat turns OFF if an alarm occurs.

## 4-2. Heating Standby

● In heating mode, the indoor fan speed decreases to prevent cold air discharge from the indoor unit. During this time,  (heating standby) is displayed on the remote controller.

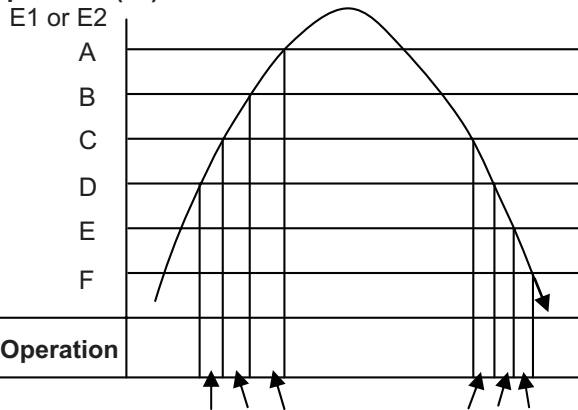
① This condition occurs in the following cases.

- Thermostat OFF
- Defrosting operation
- Indoor heat exchanger liquid temperature (E1 or E2) < 28°C just after heating operation started  
The fan speed may sometimes increase when this condition continues for 6 minutes.

② The fan mode increases when the heat exchanger liquid temperature (E1 or E2) or discharge air temperature increases.

※ The fan mode is selected based on E1 temperature and E2 temperature as shown in the below figure. If the E1 temperature and E2 temperature are different, the higher temperature is used.

Temperature (°C)



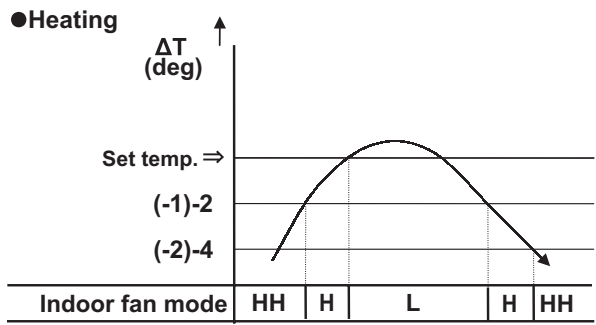
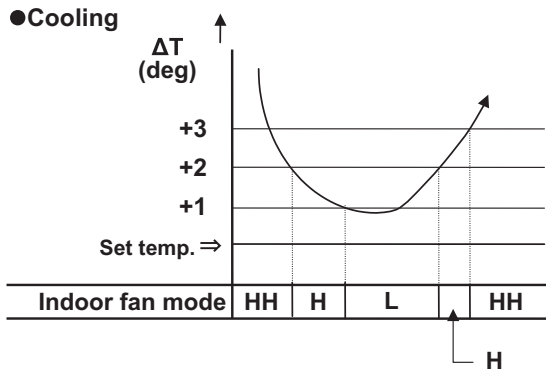
Indoor unit type	U2	T2	F1	K2
A	24	26	26	27
B	22	24	24	25
C	20	22	22	23
D	18	20	20	21
E	12	14	14	15
F	8	10	10	11

Set	*HH	STOP	LL	L	H	HH	H	L	LL	STOP
fan	H	STOP	LL	L	H	H	H	L	LL	STOP
speed	L	STOP	LL	L	L	L	L	L	LL	STOP

※ The function of “HH” is identical to the automatic fan speed mode.

### 4-3. Automatic Fan Speed Control

- ① The indoor fan mode is controlled as shown below during the automatic fan mode.
- ② The fan mode does not change for 3 minutes during cooling operation and 1 minute during heating operation once it is changed.
- ③ The values in the parenthesis are when the remote controller sensor is enabled.



#### 4-4. Drain Pump Control

The drain pump operates in the following conditions.

- ① Cooling thermostat ON
- ② The float switch worked.
- ③ The drain pump may often operate for a while when the cooling thermostat turns OFF or the indoor unit is stopped.
- ④ The drain pump can be turned on when the cooling thermostat is OFF if the setting is made to prevent water collected in the drain pan for a long time. For details, refer to the section “7-3. Detailed Settings Function.”
- ⑤ The indoor unit heat exchanger liquid temperature (E1 or E2) is less than 2°C.

※ The drain pump operates for 20 minutes once it starts operating.

#### 4-5. Automatic Heating/Cooling Control

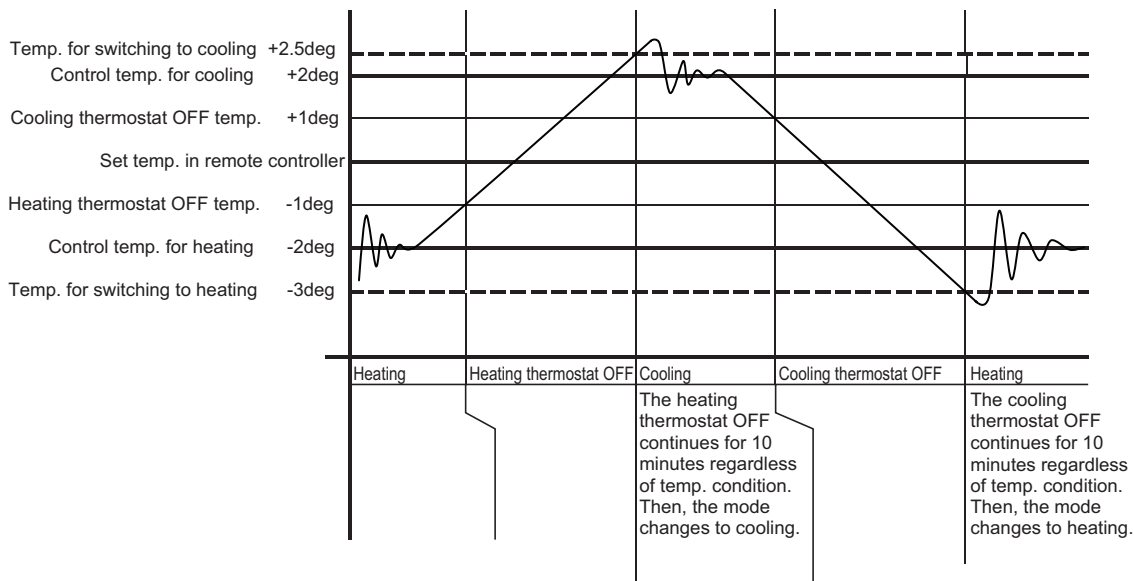
- ① The operating mode is selected according to the set temperature and room temperature when the operation is started.  
 Room temperature  $\geq$  set temperature in remote controller - 1°C → Cooling mode  
 Room temperature < set temperature in remote controller - 1°C → Heating mode
- ② The set temperature is corrected according to the operating mode. The correction temperature is +2 degrees in cooling mode and -2 degrees in heating mode at the time of factory shipment.  
 ※ The correction value is different depending on the model. Refer to "4-11. Parameter" for details.  
 Corrected cooling temperature – control temperature for cooling  
 Corrected heating temperature – control temperature for heating

When setting temperature in remote controller is 20°C in the cooling mode (at shipment) :

Control temp. for cooling	22°C
Set temp. in remote controller	20°C
Control temp. for heating	18°C

- ③ Condition for mode change  
 Heating → Cooling: Room temperature  $\geq$  Control temperature for cooling + 0.5 degree  
 Cooling → Heating: Room temperature  $\leq$  Control temperature for heating - 1.0 degree

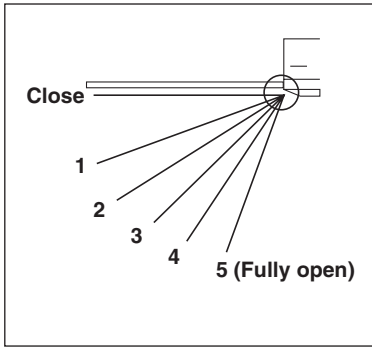
When setting temperature in remote controller is 20°C in the cooling mode :



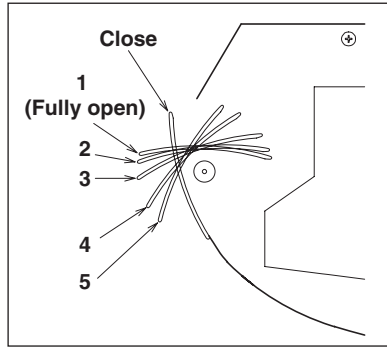
For settings at the time of factory shipment, refer to the section "4-11. Parameter".

#### 4-6. Automatic Flap Control

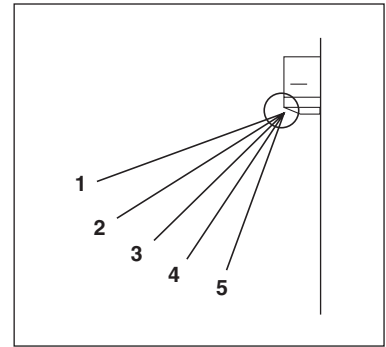
- The flap position can be selected from 5 positions.



Type U2



Type T2



Type K2

Operating mode	Flap position
Cooling/Dry	1 · 2 · 3 · 4* · 5*
Fan	1 · 2 · 3 · 4 · 5
Heating	1 · 2 · 3 · 4 · 5

\*Only U2

- ① The flap will be closed automatically when the indoor unit is stopped.  
Close: Type K2, T2, U2
- ② For 4-Way cassette type (U2), the flap closes once and moves to the set position when the operating mode is changed.

**NOTE**

Do not change the flap position manually.

- ※ Only the swing operation can be used.
- ※ The swing operation can be set for the flap.

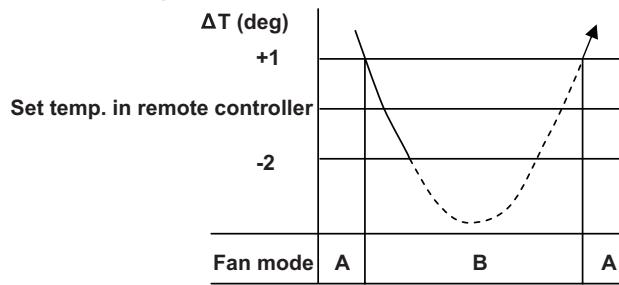
#### 4-7. Filter Sign

- ① When accumulated operating time of the indoor unit reaches the set time, the filter sign appears on the remote controller. Clean the filter.  
Refer to the section “7-2. List of Simple Setting Items, 7-5. Simple Setting Items and Filter sign ON times for each model”.
- ② After cleaning the filter, press the filter button on the remote controller once. The filter sign turns off.



#### 4-8. Fan Control during Dry Mode

The fan control during dry mode is as follows.



A: Fan mode set in the remote controller

B: Fan mode is L during thermostat ON, LL during thermostat OFF

※ For details on  $\Delta T$ , refer to “4-1. Room Temperature Control”.

#### 4-9. Ventilation Fan Output

- The output of ventilation turns ON when the indoor unit turns ON. Also, when the indoor unit turns OFF, the output of the ventilation turns OFF.
- The ventilation fan can also be turned ON and OFF using the ventilation button on the remote controller.

Refer to the operating instructions supplied with the remote controller.

To enable this function, set the indoor EEPROM DN31 to “0001” in advance.

#### 4-10. T10 Terminal

Using the T10 terminal, each indoor unit can be operated or stopped separately. Also, operating condition can be checked.

4-11. Parameter

Type	Model	Correction temp. (heating)	Heat/cool switching correction temp. (automatic heat/cool)
		Setting at time of factory shipment	Setting at time of factory shipment
U2	4-Way Cassette	4 deg	2 deg
T2	Ceiling	4 deg	2 deg
F1	Low Silhouette Ducted	4 deg	2 deg
K2	Wall Mounted	2 deg	2 deg

## 4-12. Control Functions

- **PZ** Single-phase : U-100PZ2E5, 125PZ2E5, 140PZ2E5
- **PZ** 3-phase : U-100PZ2E8, 125PZ2E8, 140PZ2E8

### 4-12-1. Indoor Air Temperature Control

The thermostat is switched on and off in accordance with  $\Delta T$  shown below.

$\Delta T = (\text{Indoor air temperature}) - (\text{Temperature set with the remote controller})$	
In the body thermostat mode (setting at factory shipment)	Indoor air temperature = (Body sensor) - (Shift temperature *)
In the remote controller thermostat mode	Indoor air temperature = (Remote controller sensor)

#### \* Shift Temperature

Only valid during heating operation. Set at 0 °C during cooling operation.

The settings at factory shipment during heating operation are as follows:

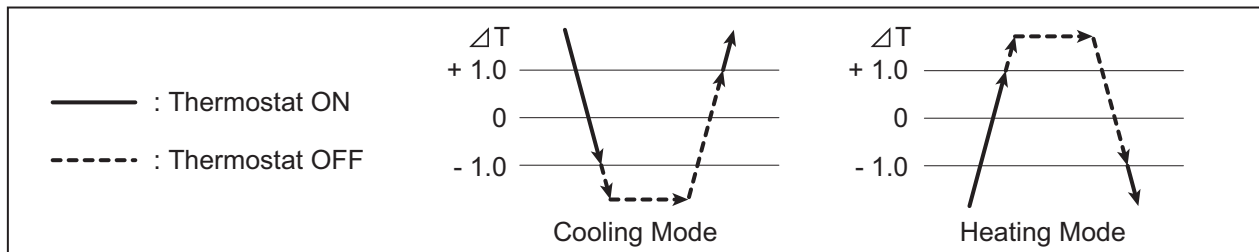
Wall Mounted type : 2°C

Floor Standing type : 0°C

All other types (4-way types, Concealed types, etc.) : 4°C

This function acts as the coefficient for adjusting differences in temperature caused by the height of the living space from the floor to the ceiling (the temperature at ceiling height is higher) during heating operation.

The setting can be modified between 0°C and 6°C with mode [06] (Simple Settings Function) on the remote controller.



- (1) Once the thermostat has been switched on, it cannot be switched off again by indoor air temperature control for a period of 10 minutes.
- (2) Once the thermostat has been switched off, it cannot be switched on again for a period of 3 minutes.
- (3) When in the test run operation mode, the thermostat will not be switched off by indoor air temperature control and the operation will continue.

### 4-12-2. Compressor Frequency Control

The frequency of the compressor's inverter is limited by either of the following controls depending on whether the cooling or heating mode is in operation.

#### Cooling Mode :

- Indoor air temperature control
- Maximum and minimum frequency control
- Current release control
- Cooling high-load prevention control
- Cooling freeze prevention control
- Discharge temperature control

#### Heating Mode :

- Indoor air temperature control
- Maximum and minimum frequency control
- Current release control
- Heating high-load prevention control
- Discharge temperature control

### 1) Indoor Air Temperature Control

By the control method, not only the thermostat is switched on and off, as explained section “4-12-1. Indoor Air Temperature Control”, but also the frequency of the compressor's inverter is controlled in accordance with  $\Delta T$  and fluctuations in indoor air temperature. Inverter frequency is controlled as follows:

When $\Delta T$ is high (not yet reached the temperature set with the remote controller).	Controlled so that the inverter frequency is increased.
When $\Delta T$ is low (approximately +1.0 or less in the cooling mode or approximately -1.0 or more in the heating mode).	Controlled so that the inverter frequency is decreased or kept.

### 2) Maximum and Minimum Frequency Control

The compressor's inverter frequency is controlled in accordance with the model and operation mode. The maximum and minimum frequencies for each model are shown in the table below.

\* There are cases in which frequency is limited with other control functions depending on operational conditions, so operations are not always carried out in accordance with the maximum frequencies listed below.

· Maximum and Minimum Frequency

Type		PZ		
Model name (U-)		100PZ2E5 100PZ2E8	125PZ2E5 125PZ2E8	140PZ2E5 140PZ2E8
Maximum Frequency (Hz)	Cooling	70	65	69
	Heating	99	95	99
Minimum Frequency (Hz)	Cooling	12	10.5	11
	Heating	15	12	12

\* There is a case in which the frequency set at maximum and minimum may sometimes decrease in accordance with ambient temperature and indoor loads.

### 3) Current Release Control

The inverter frequency is controlled so that the current value for the inverter compressor is less than the figure listed in the table below in order to prevent abnormal increases in the inverter circuit located within the outdoor unit's electrical box.

Current release control with primary current : The limited values are modified in accordance with ambient temperature.

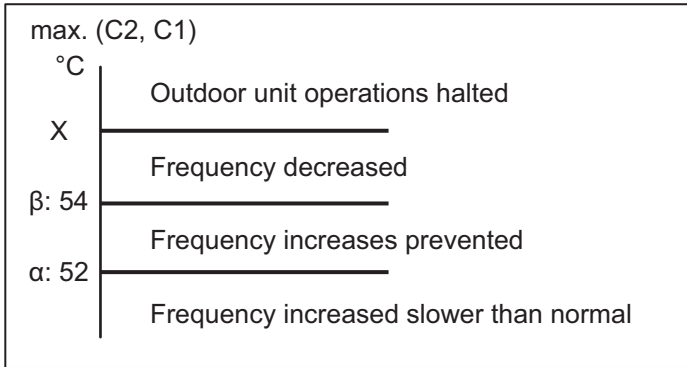
Type		PZ		
Model name (U-)		100PZ2E5	125PZ2E5	140PZ2E5
Is (A)	Cooling	23.0	27.0	27.5
	Heating	23.5	28.0	29.0
Model name (U-)		100PZ2E8	125PZ2E8	140PZ2E8
Is (A)	Cooling	8.2	9.2	9.5
	Heating	8.5	9.5	10.0

#### 4) Condensation Temperature Control (cooling)

This system control is performed to limit the inverter frequency in order to restrict high pressure's abnormal increase and high-load operating prevention in the cooling mode.

In accordance with the temperature of the outdoor heat exchanger temperature sensors (C1, C2), such controls are performed as to halting the operations of the indoor unit, decreasing the inverter frequency and restricting its increase, etc.

- (a) The threshold value is decreased in accordance with the compressor frequency or indoor load (differences of temperature).
- (b) When "X" values are lowered, the results basically become  $\beta=X-2$ ,  $\alpha=X-3$ .



Outdoor EEPROM : Amendment of X values can be made due to 4B.

EEPROM setting in outdoor unit  
CODE: 4B

Setting No.	-2	-1	0	1 *1
X (°C)	52	56.5	58.5	60

\*1 Setting at factory shipment

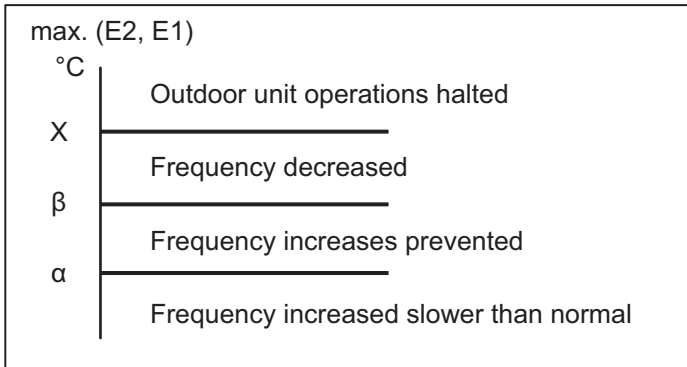


#### 5) Condensation Temperature Control (heating)

This system control is performed to limit the inverter frequency in order to restrict high pressure's abnormal increase and high-load operating prevention in the heating mode.

In accordance with the temperature of the indoor heat exchanger temperatures sensor (E1, E2), such controls are performed as to halting the operations of the indoor unit, decreasing the inverter frequency and restricting its increase, etc.

- (a) The threshold value is decreased in accordance with the compressor frequency or indoor load (differences of temperature).
- (b) When "X" values are lowered, the results basically become  $\beta=X-2$ ,  $\alpha=X-3$ .



Outdoor EEPROM : Amendment of X values can be made due to 4B.

EEPROM setting in outdoor unit  
CODE: 4B

Setting No.	-2	-1	0	1 *1
X (°C)	52	56.5	58.5	60

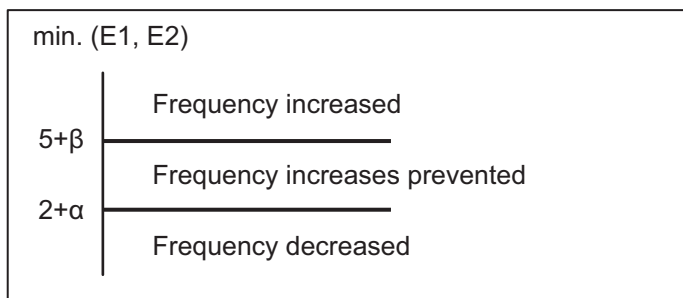
\*1 Setting at factory shipment

Model name (U-)	100PZ2E5	125PZ2E5	140PZ2E5
	100PZ2E8	125PZ2E8	140PZ2E8
α	47	47	47
β	51	51	51

## 6) Cooling Freeze Prevention Control

The following control is performed during cooling operations (including dry mode operation), in accordance with whichever of the indoor heat exchanger temperatures (E1 or E2) is lower. (See the chart below.)

- (a) Frequency will not be decreased less than 6 minutes after thermostat ON.
- (b) The threshold value is increased in accordance with the indoor load (differences of temperature).



Outdoor EEPROM : Amendment of  $\alpha$  and  $\beta$  values can be made due to 3F or 40.

EEPROM setting in outdoor unit

CODE: 3F (for  $\alpha$  setting)

Setting No.	-15	.....	0 *	.....	9
$\alpha$	-15		0		9

CODE: 40 (for  $\beta$  setting)

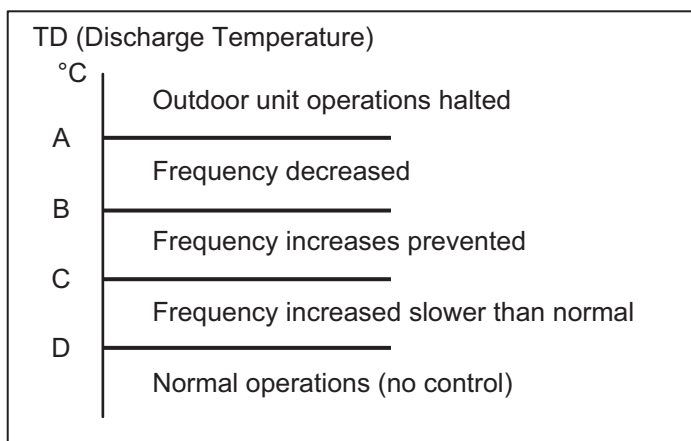
Setting No.	-15	.....	0 *	.....	9
$\beta$	-15		0		9

\* Setting at factory shipment

## 7) Discharge Temperature Control

The following control is performed to prevent the discharge temperature from rising abnormally in order to protect the inverter compressor.

In accordance with the temperature of the discharge sensor TD, such controls are performed as to limiting the increase of inverter frequency, decreasing it or halting operation of the compressor.



Model name (U-)	100PZ2E5 100PZ2E8	125PZ2E5 125PZ2E8	140PZ2E5 140PZ2E8
A	103	103	103
B	92	92	92
C	88	88	88
D	86	86	86

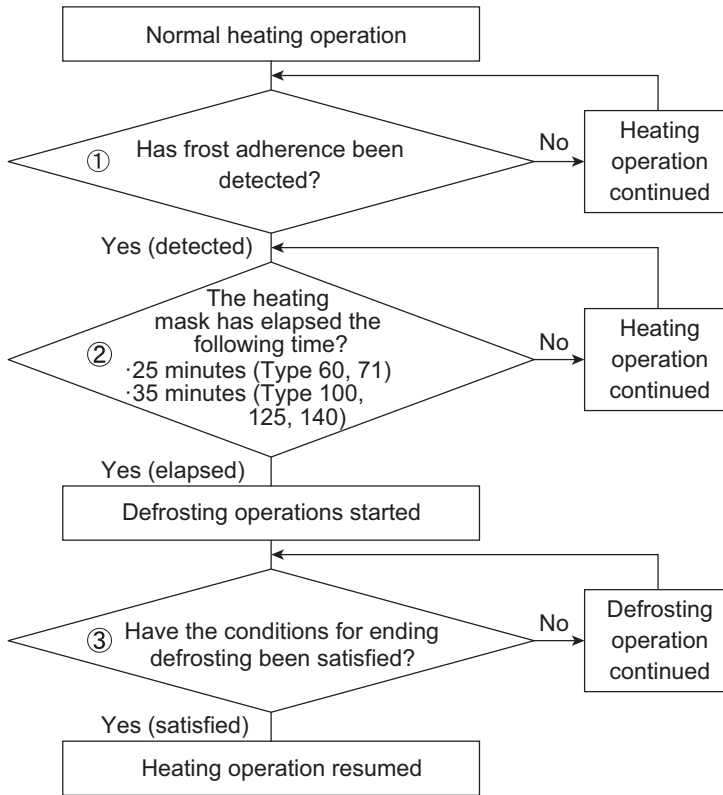
\* If the discharge temperature exceeds A°C, operations of the compressor are halted and restarted after 3 minutes.

If this start/stop activity is repeated 5 times, the alarm "P03" (abnormal discharge temperature) occurs.

### 8) Defrosting Control

This control function removes frost that has adhered to the outdoor heat exchanger during the heating operation. The control is performed to prevent the deterioration of the heating capabilities attributed to the adherence of frost, and to prevent the crack or crush of pipes attributed to the accretion of ice. The following control is performed in accordance with the ambient temperature and the outdoor heat exchanger temperature sensor (C1).

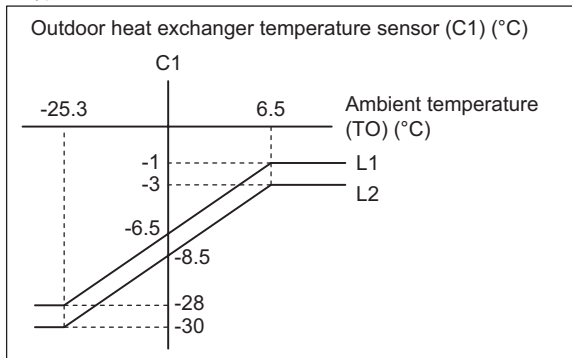
#### Overall Flow Chart of Defrosting Control



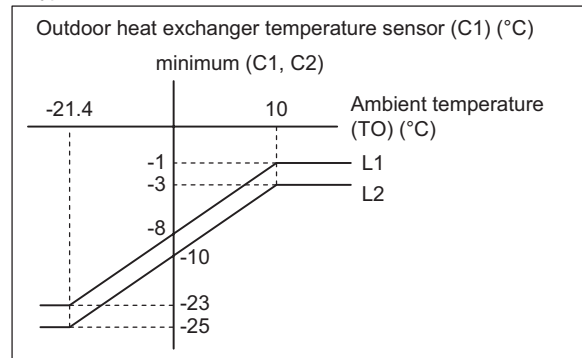
① Frost adherence detection

- If the following conditions are satisfied during heating operations, it is regarded as "frost adherence is detected".
- Frost adherence detection is performed in accordance with the ambient temperature (TO) and the outdoor heat exchanger temperature sensor (C1, C2).
- Frost adherence detection conditions
  - (a) Outdoor heat exchanger temperature sensor (minimum [C1, C2]) ≤ L1 elapsed 60 minutes (accumulated time).
  - (b) Outdoor heat exchanger temperature sensor (minimum [C1, C2]) ≤ L2 elapsed consecutive 4 × 2 min (Type 100, 125, 140).

<Type 60, 71>



<Type 100, 125, 140>



(c) Outdoor heat exchanger temperature (C1) < -3 °C is detected over 90 minutes (accumulated time) for Type 100, 125, 140.

② Heating Mask Time

This refers to the shortest time that heating operations must be performed without defrosting operations being executed. The mask time for this model is 35 minutes for Type 100, 125, 140.

\* Defrosting operations will not be started until the defrosting mask time has elapsed, even if frost adherence has been detected.

### ③ Ending Defrosting

Defrosting operations are ended when the following conditions are satisfied.

- Ending defrosting conditions
  - (a) When the temperature of the outdoor heat exchanger temperature sensor (C1) is over 10°C for Type 100, 125, 140.
  - (b) When the temperature of the outdoor heat exchanger temperature sensor (C1) is 6°C or higher for consecutive 60 seconds.
  - (c) When a maximum of 15 minutes defrosting time has elapsed.

## 9) Outdoor Unit Fan Control

The appropriate rotations per minute for the outdoor unit fan are determined in accordance with the ambient temperature and the frequency of the compressor inverter.

The outdoor unit fan step is controlled between a range of W1 (Step 1) and WF (Step 15).

## 10) Outdoor Unit's Electrical Expansion Valve Control

The electrical expansion valve controls the amount of refrigerant that is allowed to flow in accordance with the operation status.

The valve is adjusted in accordance with the discharge temperature (TD), the outdoor heat exchanger temperature sensor (C1), the suction temperature sensor (TS), and the indoor unit's heat exchanger temperature sensors (E1 and E2).

### (1) Cooling Mode

Controlled so that the suction temperature (TS) - indoor heat exchanger temperature minimum (E1 and E2) is between 0 degree and 2 degrees under normal conditions.

There are cases where the aperture opens wider than normal operation if the discharge temperature increases.

### (2) Heating Mode

Controlled so that the suction temperature (TS) - outdoor heat exchanger temperature (C1) is between 0 degree and 2 degrees under normal conditions.

There are cases where the aperture opens wider than normal operation if the discharge temperature increases.

## 11) Demand Control

There are two styles of demand operations available in methods of restraining power consumption.

There is a demand terminal as normal equipment in the outdoor unit.

Demand control can be selected as the following table.

Input current should be DC24V, 10mA

Connecting wiring must be used "shield wiring".

Short-circuit			Control (range of operations)
LV3-COM	LV2-COM	LV1-COM	
0	0	0	No restricted
0	0	1	Rated current restricted to A% (A% = 75% at factory shipment)
0	1	0	Rated current restricted to B% (B% = 50% at factory shipment)
1	0	0	Control OFF

\* The operational current is restricted to either A% or B% as a general indicator during demand input.

- A% and B% can be amended in calibrations of 5% between 40% and 130% with the outdoor unit's maintenance remote controller.

For details on how to amend the parameters, see the chapter on the outdoor maintenance remote controller, (refer to the section "6-6. Settings Modes : Setting the Outdoor Unit EEPROM").

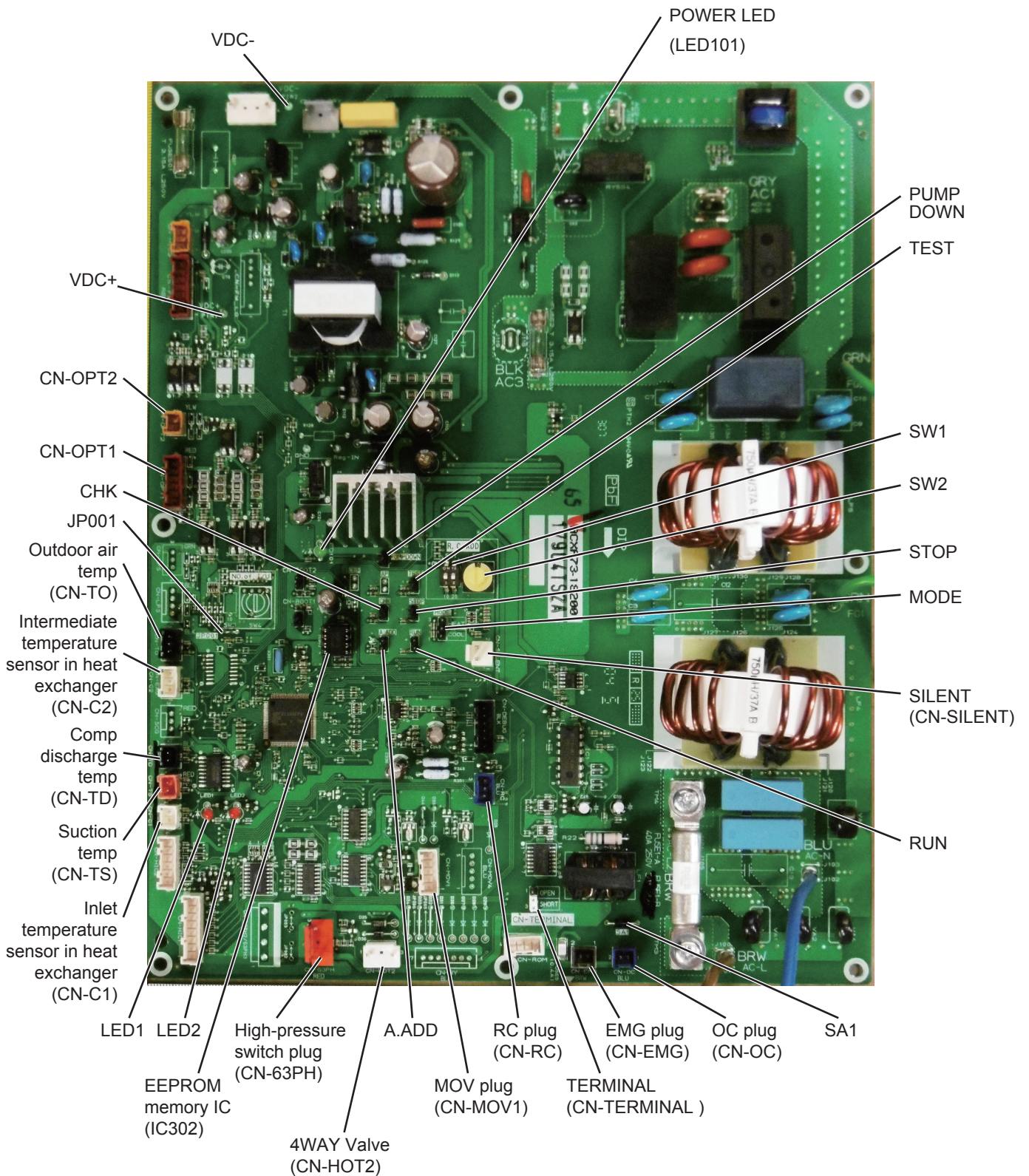
- A% value amendments: Parameters are amended with item code "1A" (demand 1).
- B% value amendments: Parameters are amended with item code "1B" (demand 2).



4-13. Outdoor Units Control PCB

4-13-1. Single-Phase Unit

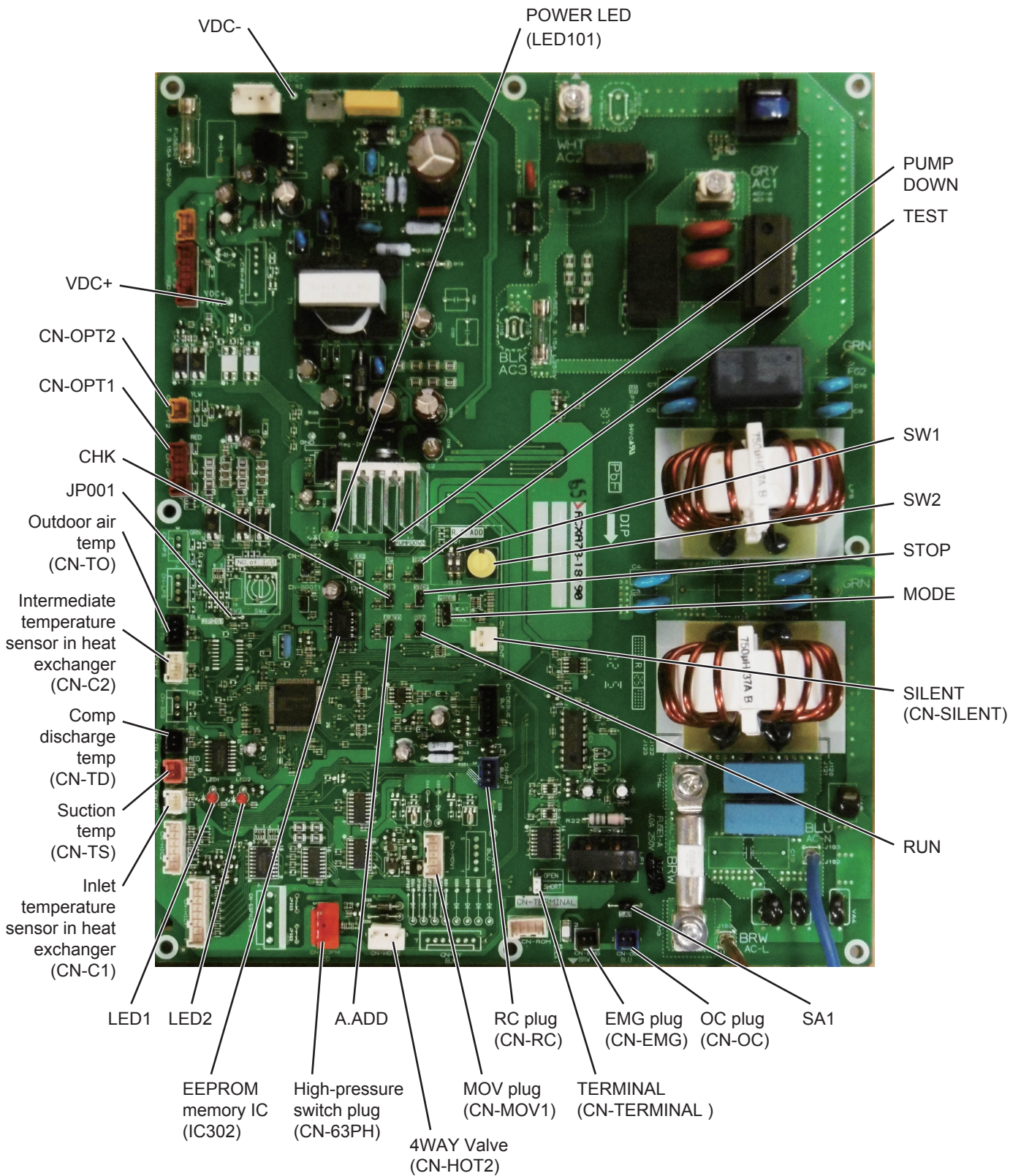
■ CR-PCB  
ACXA73-18200 (U-100PZ2E5)



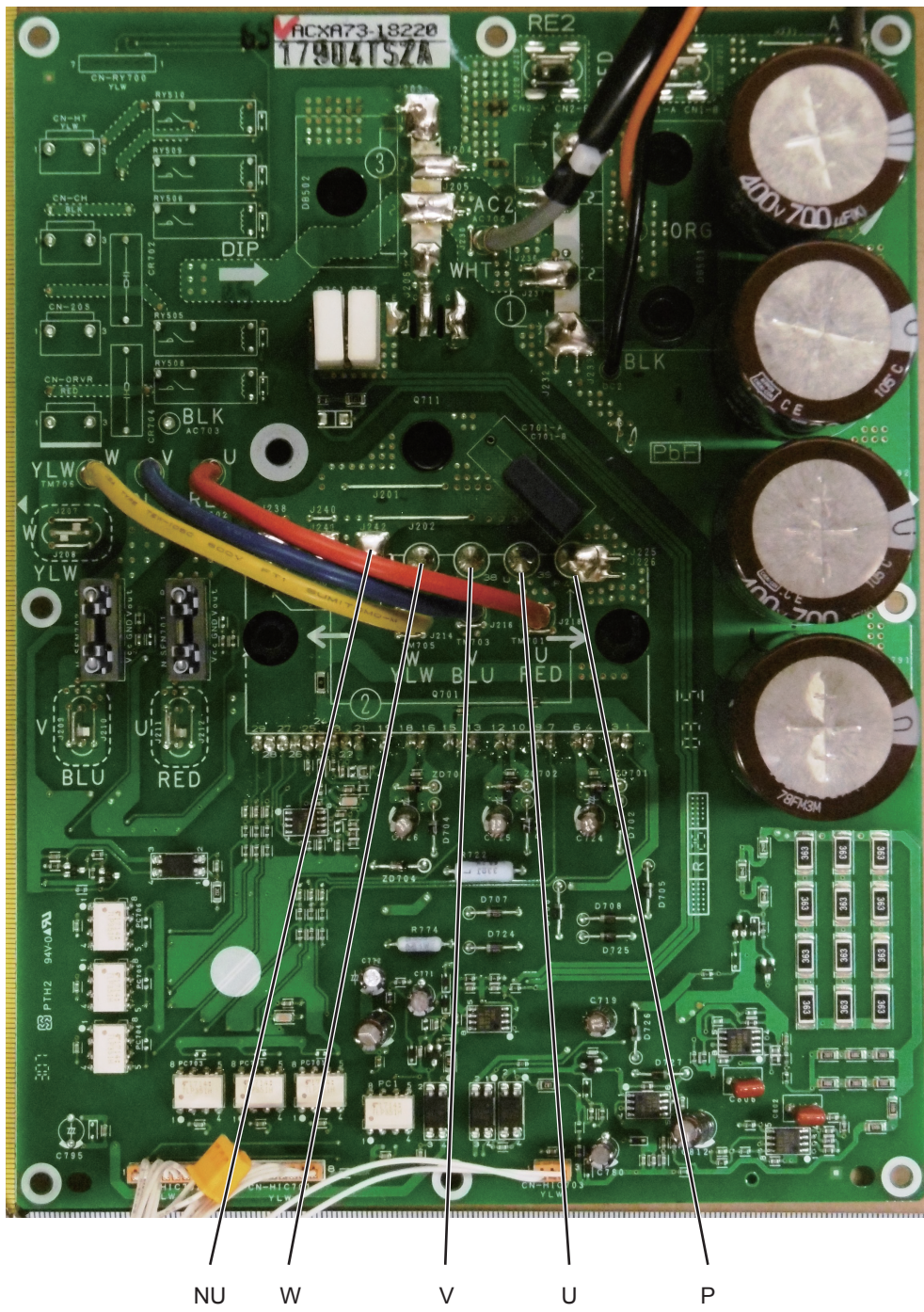
4-13-1. Single-Phase Unit (continued)

■ CR-PCB  
ACXA73-18190 ( U-125PZ2E5, U-140PZ2E5)

4

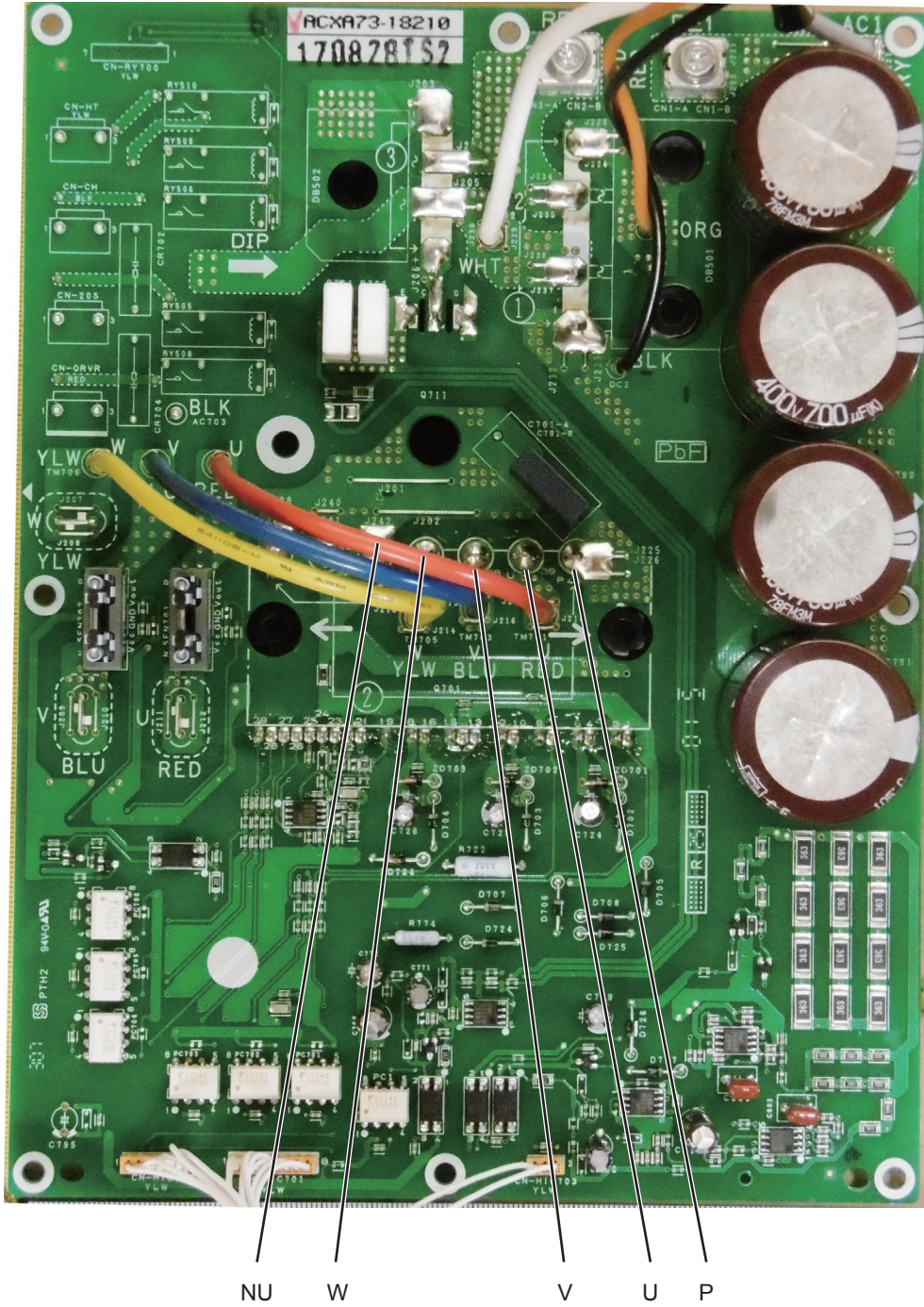


■ HIC-PCB (continued)  
ACXA73-18220 (U-100PZ2E5)



■ HIC-PCB (continued)  
 ACXA73-18210 (U-125PZ2E5, U-140PZ2E5)

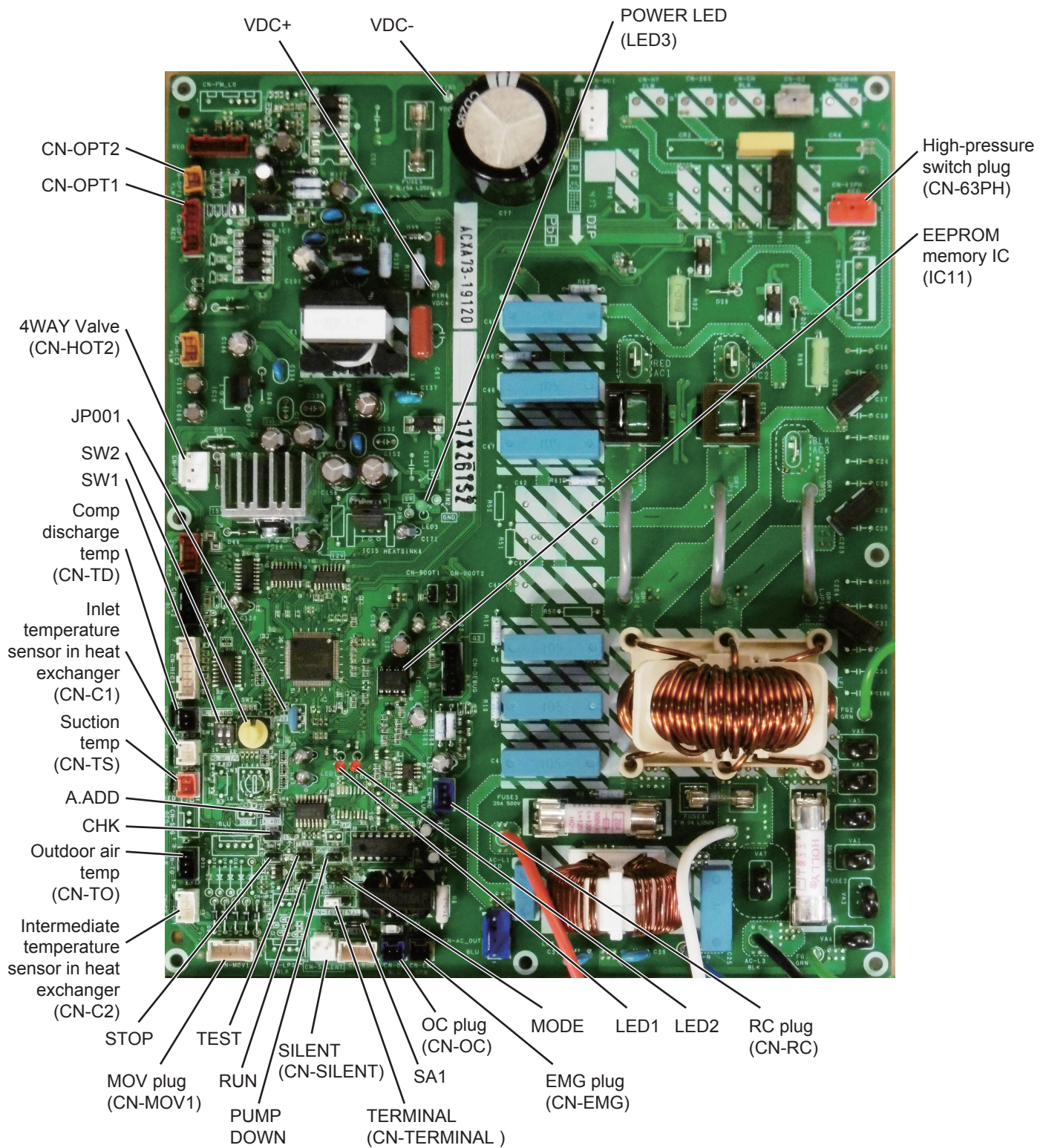
4



NU W V U P

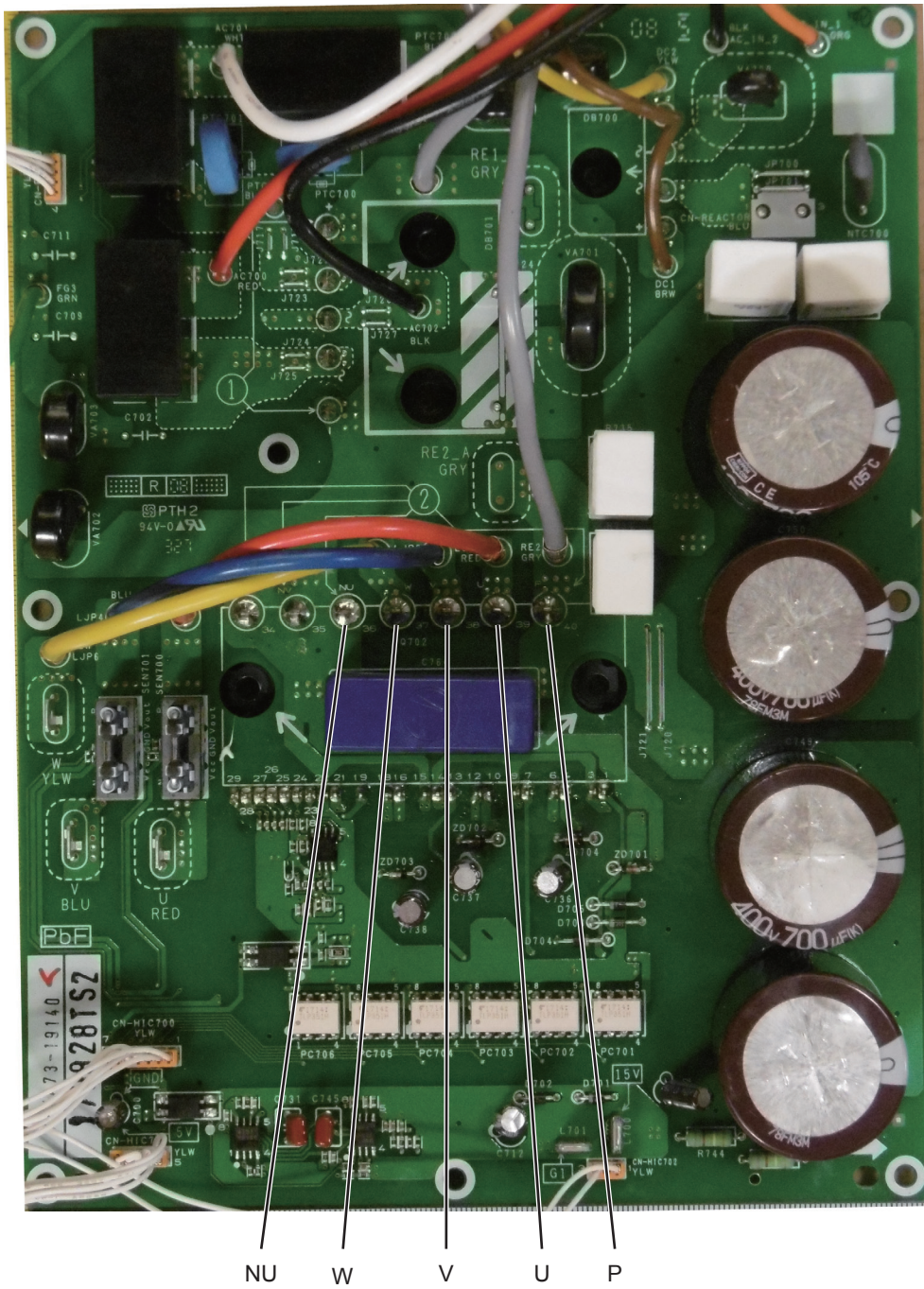
4-13-2. 3-Phase Unit

■ CR-PCB  
ACXA73-19120 (U-100PZ2E8, U-125PZ2E8, U-140PZ2E8)



■ HIC-PCB  
ACXA73-19140 (U-100PZ2E8, U-125PZ2E8, U-140PZ2E8)

4



NU W V U P

#### 4-14. Functions of Outdoor Unit PCB

A.ADD	<p>2P plug : Automatic address setting pin</p> <ul style="list-style-type: none"> <li>• Short-circuit this pin for 1 second or longer to automatically set the addresses at the indoor units that are connected to that outdoor unit and are within the same system.</li> <li>• The system address is “1” at the time of shipment. Automatic address setting is necessary even for communications lines in a single system where the inter-unit control wiring does not cross to any other systems.</li> <li>• While automatic address setting is in progress, the 2 LEDs (LED1, 2: red) on the outdoor unit control PCB blink alternately. (Short-circuiting this pin while automatic address setting is in progress will stop the automatic address setting operation.)</li> </ul>
SW2	<p>Rotary switch (10 positions, yellow): Outdoor system address setting switch</p> <ul style="list-style-type: none"> <li>• The setting is “1” at the time of shipment. It is not necessary to change the setting if wiring is connected only to an outdoor unit and indoor units in a single system and the inter-unit control wiring does not cross multiple systems.</li> <li>• If wiring links the inter-unit control wiring for multiple systems to the same communications lines, then a different address must be set for each refrigerant tubing system.</li> <li>• If wiring links multiple systems, a maximum of 30 systems (up to 64 indoor units) can be connected. This setting can be set up to “39,” however control will be for 30 systems even if the setting is set to higher than 30. An alarm will be displayed if system addresses are duplicated. (For details, refer to Table 1.)</li> </ul>
SW1	<p>DIP switch (2P): Switches for setting system address 10s digit and 20s digit</p> <ul style="list-style-type: none"> <li>• If 10 systems or more are set, the setting is made by a combination of this DIP switch and SW2.</li> <li>• If 10 – 19 systems are set, set switch 1 (10s digit) to ON.</li> <li>• If 20 – 29 systems are set, set switch 2 (20s digit) to ON, and set switch 1 (10s digit) to OFF.</li> <li>• If 30 systems are set, set both switch 1 (10s digit) and switch 2 (20s digit) to ON.</li> </ul> <p>(For details concerning SW2 and SW1, refer to Table 1.)</p>
JP001	<p>Jumper wire</p>
TERMINAL	<p>3P plug : For communications circuit impedance matching</p> <ul style="list-style-type: none"> <li>• A connecting socket (3P, black) is attached to the terminal plug at the time of shipment from the factory.</li> <li>• In the case of link wiring which combines the inter-unit control wiring for multiple systems into a single communications circuit, leave the connecting socket in place at only one of the outdoor units, and move the socket from the “SHORT” side to the “OPEN” side at all other outdoor units. If multiple connecting sockets are left in place, communications trouble will occur.</li> </ul>
EMG plug	<p>2P plug (brown)</p> <ul style="list-style-type: none"> <li>• If "TO INDOOR UNIT" accidentally connected to high voltage, use the following method.             <ol style="list-style-type: none"> <li>1. Replace the wire CN-OC with the wire CN-EMG.</li> <li>2. Cut off SA1.</li> </ol> </li> </ul>

LED 1 LED 2	LED (red × 2) <ul style="list-style-type: none"> <li>• LED 1 and 2 blink alternately while automatic address setting is in progress.</li> <li>• Display the alarm contents for alarms that are detected by the outdoor unit.</li> </ul>
POWER LED	LED (green): Power indicator Indicates the DC 5V power on the outdoor unit control PCB.
RUN	2P plug (black) : Start pin Short-circuit this pin and apply a pulse signal to start all indoor units in that refrigerant system.
STOP	2P plug (black): Stop pin Short-circuit this pin and apply a pulse signal to stop all indoor units in that refrigerant system.
PUMP DOWN	2P plug (black): Refrigerant recovery Pin <ul style="list-style-type: none"> <li>• Short circuit this pin to perform refrigerant recovery control using cooling operation. The indoor unit fan will operate at HIGH and 55 Hz for a maximum of 10 minutes. When refrigerant recovery is completed, close the valves and open circuit this pin to stop the operation.</li> </ul>
MODE	3P plug (black): Indoor unit Heating/Cooling mode change pin <ul style="list-style-type: none"> <li>• When operating the compressors to perform automatic address setting, operation in Heating mode can be normally used. However, short-circuiting this pin performs operation in Cooling mode. (Static signal)</li> <li>• Short-circuiting this pin during ordinary operation changes the mode from Cooling to Heating (if the current mode is Cooling) or from Heating to Cooling (if the current mode is Heating).</li> </ul>
TEST	2P plug (black) <ul style="list-style-type: none"> <li>• This pin is used to test the PCB at the factory.</li> <li>• When the power is turned ON after this pin has been short-circuited, all output signals will be output in sequence. (Sequential output does not occur if this pin is short-circuited when the power is already ON.) Releasing this pin returns the unit to normal control.</li> </ul>
CHK	2P plug (black) Short-circuit during the test run operation. Open the circuit after the test run.



**Table 1. Setting the System Address [SW2: Rotary switch (yellow), SW1: 2P DIP (black)]**

	Outdoor system address No.	SW2 setting (system address switch)	SW1 setting	
			1P (10s digit)	2P (20s digit)
<b>1 refrigerant system only</b>	1	0	OFF	OFF
<b>Link wiring</b>	1	1	OFF	OFF
	2	2	OFF	OFF
	3	3	OFF	OFF
	4	4	OFF	OFF
	5	5	OFF	OFF
	6	6	OFF	OFF
	7	7	OFF	OFF
	8	8	OFF	OFF
	9	9	OFF	OFF
	10	0	ON	OFF
	11	1	ON	OFF
	12	2	ON	OFF
	13	3	ON	OFF
	14	4	ON	OFF
	15	5	ON	OFF
	16	6	ON	OFF
	17	7	ON	OFF
	18	8	ON	OFF
	19	9	ON	OFF
	20	0	OFF	ON
	21	1	OFF	ON
	22	2	OFF	ON
	23	3	OFF	ON
	24	4	OFF	ON
	25	5	OFF	ON
	26	6	OFF	ON
	27	7	OFF	ON
	28	8	OFF	ON
	29	9	OFF	ON
	30	0	ON	ON

#### 4-15. Self-Diagnostics Function Table

- Causes and corrections in instances when automatic address setting cannot be started.

Trouble	Cause and correction
The power LED on the outdoor unit control PCB does not turn ON.	Check for any errors in the power wiring to the outdoor unit, and check for a missing phase.
LED 1 and 2 on the outdoor unit control PCB do not turn OFF when the outdoor unit power is turned ON, and automatic address setting cannot be started.	Check the "Alarm Displays" table and correct the problem.
An alarm appears immediately when automatic address setting is started from the remote controller.	
Nothing happens when the operator attempts to start automatic address setting from the remote controller.	Check that the remote controller wiring and the inter-unit control wiring are connected correctly. Check that the indoor unit power is ON.

- Causes and corrections in instances when automatic address setting starts, but cannot be completed successfully.

Trouble	Cause and correction
An alarm appears on the remote controller sometime from several seconds to several minutes after automatic address setting is started.	Check the "Alarm Displays" table and correct the problem.
LED 1 and 2 on the outdoor unit control PCB indicate that automatic address setting is in progress (the LEDs blink alternately) for several minutes after automatic address setting is started (the compressors may also start and stop several times), however LED 1 and 2 never indicate that automatic address setting is completed (turn OFF).	Check the alarm details on the "Outdoor Unit Control PCB LED 1 and 2 Alarms" table, then check the "Alarm Displays" table and correct the problem.

- If alarm E15, E16, or E20 appears after automatic address setting is started, check the following items.

Alarm display	Alarm description
E15	The total capacity of indoor units is too lower than that of outdoor unit.
E16	The total capacity of indoor units is too higher than that of outdoor unit.
E20	The outdoor unit received no serial signals from indoor units within 90 seconds after automatic address setting was started.

Check items	E15	E16	E20
Check that the indoor unit power is turned ON.	○		○
Check that the inter-unit control wiring is connected correctly. (Check that there are no open circuits, short circuits, terminal plugs, incorrect wiring to the remote controller terminals, or similar problems.)	○	○	○
Check that the remote controller wiring is connected correctly. (Check that there are no open circuits, short circuits, incorrect wiring to the inter-unit control wiring terminals, control wiring for group control, or similar problems.)	○		○
Check that the amount of additional refrigerant charge is correct (if automatic address setting is performed with the compressors ON).	○		
Check that the refrigerant tubing connections are correct (if automatic address setting is performed with the compressors ON).	○	○	
Check that there are no problems with indoor unit sensors E1 and E3 (if automatic address setting is performed with the compressors ON).	○		
Check that there are no indoor units where the system address was already incorrectly set by manual or automatic address setting.		○	

- When automatic address setting is started from the outdoor unit control PCB or from the remote controller, **SETTING** (SETTING) appears on the remote controller at units where the inter-unit control wiring and remote controller wiring are connected correctly. LED 1 and 2 on the outdoor unit control PCB blink alternately.
- In the case of indoor unit group control, if there is a mistake in the remote controller inter-unit control wiring for group control, addresses may not be set even if **SETTING** (SETTING) appears.
- Even if alarm E15 or E16 appears, addresses are set at those indoor units which could be verified. The set addresses can be checked using the remote controller.
- If one of the below alarms appears when the remote controller is operated after automatic address setting was completed (LED 1 and 2 on the outdoor unit control PCB are turned OFF), follow the instructions in the table below and correct the problem location.

Remote controller display	Cause
Nothing is displayed.	The remote controller is not connected correctly (power trouble). The indoor unit power was cut off after automatic address setting was completed.
E01	The remote controller is not connected correctly (remote controller receiving trouble). The remote controller of an indoor unit where the indoor unit address is not set is inadvertently operated. (Communications with the outdoor unit are not possible.)
E02	The remote controller is not connected correctly (trouble with sending of the signal from the remote controller to the indoor unit).
E09	The indoor unit ceiling panel connector is not connected correctly.

- The outdoor unit maintenance remote controller can be used to check the alarm display. The number of times that LED 1 and 2 blink on the outdoor unit control PCB can be used to check the alarm display. (Refer to "Checking the LED 1 and 2 Alarm Display on the Outdoor Unit Control PCB.")

Alarm Code	Alarm Meaning
E01	Remote Controller Reception Error
E02	Remote Controller Transmission Error
E03	Error in Indoor Unit Receiving Signal from Remote Controller (central)
E04	Error in Indoor Unit Receiving Signal from the Outdoor Unit
E05	Error in Indoor Unit Transmitting Signal to the Outdoor Unit
E06	Outdoor Unit Failed to Receive Serial Communication Signals from Indoor Unit
E08	Duplicate Indoor Unit Address Settings Error
E09	More Than One Remote Controller Set to Main Error
E12	Automatic Address Setting Start is Prohibited while Auto-address Setting in Progress.
E14	Main Unit duplication in Simultaneous-operation Multi Control (detected outdoor unit)
E15	Automatic Address Alarm (The total capacity of indoor units is too low.)
E16	Automatic Address Alarm (The total capacity of indoor units is too high or the total number of indoor units is too many.)
E18	Faulty Communication in Group Control Wiring
E20	Connection Problem of Indoor/Outdoor Units.

F04	Compressor Discharge Temperature Sensor (TD) Trouble
F06	Inlet Temperature Sensor (C1) in Heat Exchanger Trouble
F07	Intermediate Temperature Sensor (C2) in Heat Exchanger Trouble
F08	Outdoor Air Temperature Sensor (TO) Trouble
F12	Compressor Inlet Suction Temperature Sensor (TS) Trouble
F31	Outdoor Unit Nonvolatile Memory (EEPROM) Trouble

H01	Primary (input) Overcurrent Detected
H02	PAM Trouble
H03	Primary Current CT Sensor (current sensor) Failure
H31	HIC Trouble

L04	Outdoor Unit Address Duplication
L10	Outdoor Unit Capacity not Set or Invalid
L13	Indoor Unit Type Setting Error
L18	4-Way Valve Operation Failure

P03	Compressor Discharge Temperature Trouble
P04	High Pressure Trouble
P05	AC Power Supply Trouble
P13	Alarm Valve Open
P14	O <sub>2</sub> Sensor Detect
P15	Insufficient Gas Level Detected
P16	Compressor Overcurrent Trouble
P22	Outdoor Unit Fan Motor Trouble
P29	Lack of INV compressor wiring, INV compressor actuation failure (including locked), DCCT failure
P31	Group Control Error

## 5. TROUBLE DIAGNOSIS

5-1.	Contents of Remote Controller Switch Alarm Display .....	5-2
5-2.	Outdoor Unit Control Panel LED Display .....	5-4
5-3.	PAC System Alarm Codes .....	5-5
5-4.	Inspection of Parts (Outdoor Unit) .....	5-61
5-5.	Symptom: Thermostat in OFF continues or cycles OFF & ON too frequently .....	5-62
5-6.	How to Clean Heat Exchanger .....	5-63
5-7.	How to Replace Fan Motor .....	5-64

## 5-1. Contents of Remote Controller Switch Alarm Display

ON: ○ Blinking: ☀ OFF: ●

Possible cause of malfunction		Wired remote control display	Wireless remote controller receiver display		
			Operation	Timer	Standby
Serial communication errors Missetting	Failure in receiving serial signal from remote controller's indoor unit	Faulty remote controller Disconnection/Contact failure of remote controller wiring CHK(check) pins on the indoor unit control PCB are short circuited	E01	Operating lamp blinking ☀ ● ●	
	Settings of system address, indoor unit address and group control are not made	In the case of non-group control: • Power supply OFF of outdoor unit • Disconnection / Contact failure of inter-unit wiring In the case of group control: Automatic address operation was not carried out.			
	Setting failure of nonvolatile memory IC	Faulty setting of EEPROM (IC1010) on indoor unit			
	Failure in indoor unit serial signal from remote controller	Faulty remote controller Wrong wiring of remote controller	E02		
	Error in indoor unit receiving signal from remote controller (central)		E03		
	Failure in indoor unit receiving serial signal from outdoor unit	Disconnection / Contact failure of inter-unit wiring	E04	Standby lamp blinking ● ● ☀	
		• Faulty indoor unit control PCB • Faulty outdoor unit control PCB • Communication circuit fuse (F302) on indoor unit control PCB opened • Fuse on outdoor unit control PCB opened Since failure of an outdoor fan motor is considered as a cause, both outdoor unit control PCB and outdoor unit fan motor are exchanged simultaneously.			
	Failure in outdoor unit receiving serial signal from indoor unit	• Disconnection / Contact failure of inter-unit wiring	E06	● ● ☀	
		• Disconnection of inter-unit wiring • Communication circuit fuse (F302) on indoor unit control PCB opened Indoor unit control PCB address setting error			
	Duplication of indoor unit address	Duplication of indoor unit address setting	E08		
	Duplication of main remote controller setting	Error because of more than one remote controller setting to main	E09		
	Improper setting	Automatic address setting start is prohibited	E12	Operating lamp blinking ☀ ● ●	
		Duplication of main unit in group control	E14		
	Communication error between main and sub indoor units	• Disconnection of wiring between main unit and additional units • Contact failure of wiring • Faulty indoor unit control PCB (Main or Addition)	E18		
	Automatic address settings failure	Automatic Address Alarm The total capacity of indoor units is too low	E15	Standby lamp blinking ● ● ☀	
		Automatic Address Alarm The total capacity of indoor units is too high	E16		
		Automatic Address Alarm No indoor unit connected	E20		
	Outdoor unit Communication error		E24		
	Outdoor unit Communication error		E29		
	Indoor & outdoor unit type miss-matched	Setting error, indoor/outdoor unit type/model miss-matched	L02		
Duplication of group control's main indoor unit	Duplication of main indoor unit address in group control	L03	Operating and Standby lamps blinking simultaneously ☀ ● ☀		
Group control wiring is connected to individual control indoor unit	Group control wiring is connected to individual control indoor unit	L07			
Indoor unit address is not set		L08	☀ ● ☀		
Indoor unit capacity is not set		L09			
Duplication of outdoor unit address		L04	Operating and Standby lamps blinking simultaneously ☀ ● ☀		
Outdoor unit capacity is not set or setting error		L10			
Indoor unit type setting error		L13	☀ ○ ☀		
4-way valve locked trouble / operation failure		L18			

Continued

ON: ○ Blinking: ☀ OFF: ●

Possible cause of malfunction			Wired remote control display	Wireless remote controller receiver display		
				Operation	Timer	Standby
Activation of protective device	Faulty wiring connections of (ceiling) indoor unit panel		P09			
	Indoor unit fan motor trouble	Indoor unit fan motor locked	P01			
		Indoor unit fan motor layer short				
		Contact failure in thermostat protector circuit				
	Activation of float switch wiring	Faulty drain pump	P10			
		Drainage failure				
		Contact failure of float switch wiring				
	Faulty drain pump	Faulty drain pump	P11	●	☀	☀
		Drain pump locked				
	Indoor unit fan motor trouble	Indoor unit fan motor locked Faulty wiring connections of indoor unit fan motor	P12			
	Valve error	Valve error	P13			
	O <sub>2</sub> sensor error	O <sub>2</sub> sensor detected	P14			
	Discharge temperature protective alarm	Compressor discharge temperature trouble	P03			
	Activation of high pressure switch	Compressor discharge pressure trouble	P04			
	Power supply failure	Open phase detected AC power supply trouble	P05			
	Insufficient gas	Insufficient gas level detected	P15			
	Compressor overcurrent trouble		P16	☀	●	☀
	Fan motor locked/reversed airflow detected	Outdoor unit fan motor trouble	P22			
		Outdoor unit fan trouble				
	Inverter compressor trouble		P29			
Group control trouble	Indoor unit in group control trouble	P31				
Activation of current control compressor's protective device	Primary (input) overcurrent detected	H01				
PAM trouble (overcurrent/over-voltage), Activation of compressor's protective device	PAM trouble	H02				
Primary current control, Activation of compressor's protective device	Primary current CT sensor failure	H03	●	☀	●	
HIC trouble	HIC trouble DC voltage not detected	H31				
Thermistor fault	Indoor unit thermistor open/short	Indoor heat exchanger temperature sensor (E1) trouble	F01			
		Indoor heat exchanger temperature sensor (E2) trouble	F02			
		Indoor air temperature sensor (TA) trouble	F10	☀	☀	●
	Outdoor unit thermistor open/short	Compressor discharge temperature sensor (TD) trouble	F04			
		Outdoor heat exchanger temperature sensor (C1) trouble	F06			
		Outdoor heat exchanger temperature sensor (C2) trouble	F07			
		Outdoor air temperature sensor (TO) trouble	F08	☀	☀	○
Compressor suction temperature sensor (TS) trouble	F12					
Nonvolatile memory failure	Indoor unit EEPROM trouble	F29	☀	☀	●	
	Outdoor unit EEPROM trouble	F31	☀	☀	○	

## 5-2. Outdoor Unit Control Panel LED Display

Contents of LED Display on Outdoor Unit Control PCB

( ○ : ON    ☀ : Blinking    ● : OFF )

LED1	LED2	Display meaning
○	○	After the power is turned ON (and automatic address setting is not in progress), no communication with the indoor units in that system is possible.
(Both ON)		
●	○	After power is turned ON (and automatic address setting is not in progress), 1 or more indoor units are confirmed in that system; however, the number of indoor units does not match the number that was set.
(OFF)	(ON)	
●	●	Automatic address setting was completed successfully. (After the power is turned ON, the number of detected indoor units connected to that system matches the number that was set, and regular communications are occurring.)
(Both OFF)		
☀	☀	Automatic address setting is in progress.
(Blinking alternately)		
☀	☀	Alarm display LED 1 blinks M times, then LED 2 blinks N times. The cycle then repeats. M = 2: P alarm 3: H alarm 4: E alarm 5: F alarm 6: L alarm N = Alarm No. Example: LED 1 blinks 2 times, then LED 2 blinks 16 times. The cycle then repeats. Alarm is "P16."
(Blinking alternately)		
☀	○	PUMP DOWN is in progress.
LED 1 : Blinking LED 2 : ON		
☀ (0.8 / 0.3) *	●	P04 (High pressure trouble) Pre-trip display
LED 1 : Blinking LED 2 : OFF		
☀ (0.5 / 0.5)	●	Other Pre-trip display
LED 1 : Blinking LED 2 : OFF		

\* Blinking (0.8 / 0.3) indicates that the lamp illuminates for 0.8 seconds, and then is OFF 0.3 seconds.



## 5-3. PAC System Alarm Codes

### Alarms for outdoor units

Alarm Code	Alarm Meaning
E01	Remote Controller Reception Error
E02	Remote Controller Transmission Error
E03	Error in Indoor Unit Receiving Signal from Remote Controller (central)
E04	Error in Indoor Unit Receiving Signal from the Outdoor Unit
E05	Error in Indoor Unit Transmitting Signal to the Outdoor Unit
E06	Outdoor Unit Failed to Receive Serial Communication Signals from Indoor Unit
E08	Duplicate Indoor Unit Address Settings Error
E09	More Than One Remote Controller Set to Main Error
E12	Automatic Address Setting Start is Prohibited while Auto-address Setting in Progress.
E14	Main Unit duplication in Simultaneous-operation Multi Control (detected outdoor unit)
E15	Automatic Address Alarm (The total capacity of indoor units is too low.)
E16	Automatic Address Alarm (The total capacity of indoor units is too high or the total number of indoor units is too many.)
E18	Faulty Communication in Group Control Wiring
E20	Connection Problem of Indoor/Outdoor Units.
F04	Compressor Discharge Temperature Sensor (TD) Trouble
F06	Inlet Temperature Sensor (C1) in Heat Exchanger Trouble
F07	Intermediate Temperature Sensor (C2) in Heat Exchanger Trouble
F08	Outdoor Air Temperature Sensor (TO) Trouble
F12	Compressor Inlet Suction Temperature Sensor (TS) Trouble
F31	Outdoor Unit Nonvolatile Memory (EEPROM) Trouble
H01	Primary (input) Overcurrent Detected
H02	PAM Trouble
H03	Primary Current CT Sensor (current sensor) Failure
H31	HIC Trouble
L04	Outdoor Unit Address Duplication
L10	Outdoor Unit Capacity not Set or Invalid
L13	Indoor Unit Type Setting Error
L18	4-Way Valve Operation Failure
P03	Compressor Discharge Temperature Trouble
P04	High Pressure Trouble
P05	AC Power Supply Trouble
P13	Alarm Valve Open
P14	O <sub>2</sub> Sensor Detect
P15	Insufficient Gas Level Detected
P16	Compressor Overcurrent Trouble
P22	Outdoor Unit Fan Motor Trouble
P29	Lack of INV compressor wiring, INV compressor actuation failure (including locked), DCCT failure
P31	Group Control Error

## Symptoms and Parts to Inspect

Remote controller alarm display	Alarm contents	Judgement conditions	Eliminating condition of alarm	Judgement and correction
P03	Abnormal discharge temperature error • Discharge temp. detected at or above the specified value	Stops when temp. exceeds 106 °C. Alarm output on 5 pre-trips	Recovery at restart	1. Check refrigerant cycle (gas leak). 2. Trouble with electronic expansion valve 3. Check discharge temperature sensor (TD).
P05	CT disconnected or AC power supply error	The current value transmitted from the microcomputer on the outdoor unit control substrate is low. When no AC power input for more than 30 seconds to 5 minutes : Single alarm	Recovery at restart	1. Check outdoor unit control PCB. 2. Lack of reactor wire
P15	Insufficient gas level detected.	• Discharge temperature is 95 °C or higher. • Electronic expansion valve is at Step 480. When the above has continued for 1 minute. Indoor air sucking due to body thermostat max (E1 or E2) - TA ≤ 4 °C	Recovery at restart	1. Check refrigerant cycle (gas leak). 2. Trouble with electronic expansion valve 3. Check outdoor unit valve opening.
L18	4-Way valve operation failure • Judged after heating operating for 5 minutes consecutively.	The indoor unit heat exchanger temperature drops even though the compressor is switched on during the heating mode : To +20 °C ≤ C1 Pre-trip 1 time	Recovery at restart	1. Check 4-Way valve. 2. Check 4-Way valve wiring. 3. Check outdoor unit control PCB.
P04	High-pressure protection error	High pressure switched ON → OFF (Alarm is output when switch opened.) Pre-trip 4 times.	Recovery at restart	Overload operation of refrigerant cycle
P22	Outdoor unit fan motor trouble • Inverter protection circuit was activated, or lock was detected at outdoor unit fan motor.	Inverter stops after alarm is detected. Pre-trip 10 times	Recovery at restart	1. Position detection trouble. 2. Outdoor unit fan motor over-current Protection circuit is activated. • Check outdoor unit control PCB. • Refer to outdoor unit fan judgement methods.
P29	Lack of INV compressor wiring, INV compressor actuation failure, DCCT failure	Inverter stops after alarm is detected. Alarm is output when inverter stops (pre-trip) consecutively 10 times.	Recovery at restart	1. Stops immediately even when operations restarted. • Layer short on the compressor 2. Check HIC circuit. • Wiring trouble
H31	HIC trouble	Pre-trip consecutively 10 times	Temperature dropped	Heat sink and PCB (HIC) • Contact trouble

## Check Prior to Auto Address Setting

※ If an outdoor unit displays an alarm, conduct this process after diagnosing the problem.

1 Auto Address	1-1	Is the power of the indoor unit(s) and outdoor unit(s) on?	Yes	2-1
			No	Power on
2 Indoor/ outdoor control line	2-1	Has the wiring of the indoor/outdoor control line been completed? Is it all connected?	Yes	2-2
			No	Connect the wiring
	2-2	Has high voltage (over AC200V) been applied to the control line circuit? Has the fuse on the control PC board blown? (Check each board of the indoor unit(s) and outdoor unit(s).)	Yes	2-3
			No	3-1
2-3	The power line and indoor/outdoor control line are miswired. Turn off the power, check & correct the miswiring and then make connections of the indoor/outdoor control lines to the emergency side of all the control PC boards and controllers.			
3 Installation or setting related	3-1	Be sure that the indoor and outdoor units are connected with correct combination written in catalog.	Yes	3-2
			No	Correct the connection
	3-2	Is the indoor/outdoor control line connected to more than one outdoor unit? (Network wired?)	Yes	3-3
			No	3-6
	3-3	Is the Terminal resistor select switch on the outdoor control PC board set to just one unit?	Yes	3-4
			No	Correct the setting
	3-4	Are other outdoor units using a duplicate setting?	Yes	3-5
			No	3-6
3-5	When units are networked, first set the system address for each outdoor unit in the order 1-2-3 and then run auto address setting.			
3-6	Run the auto address setting.			

## E01 Remote Controller Reception Error

(When indoor unit(s) are connected)

### 1. Error Detection Method

It is judged an error if no self-addressed communication is sent to the remote controller in a 3-minute period.

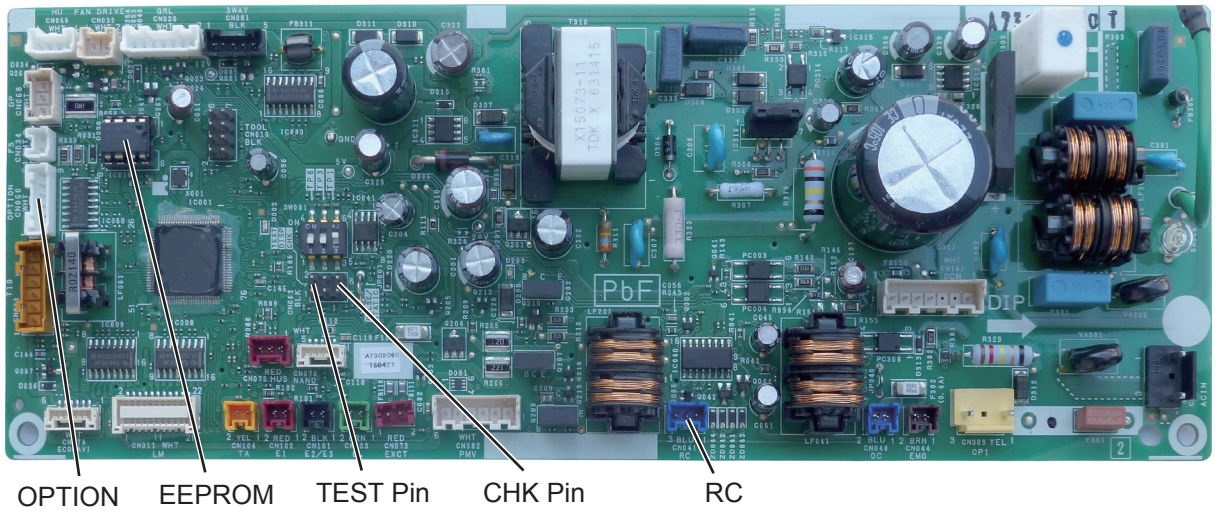
- When a remote controller is set to sub remote controller.
- When there are nine or more indoor units in a remote control group's wiring.
- When the CHK (check pin) and/or TEST (test pin) on the indoor unit control PC board are short circuited.
- The nonvolatile memory (EEPROM) is not installed or faulty when turning on the power.
- Indoor unit control PC board error
- Remote controller check mode
- Malfunctions of the remote controller itself (reception circuit error)

### 2. Error Diagnosis

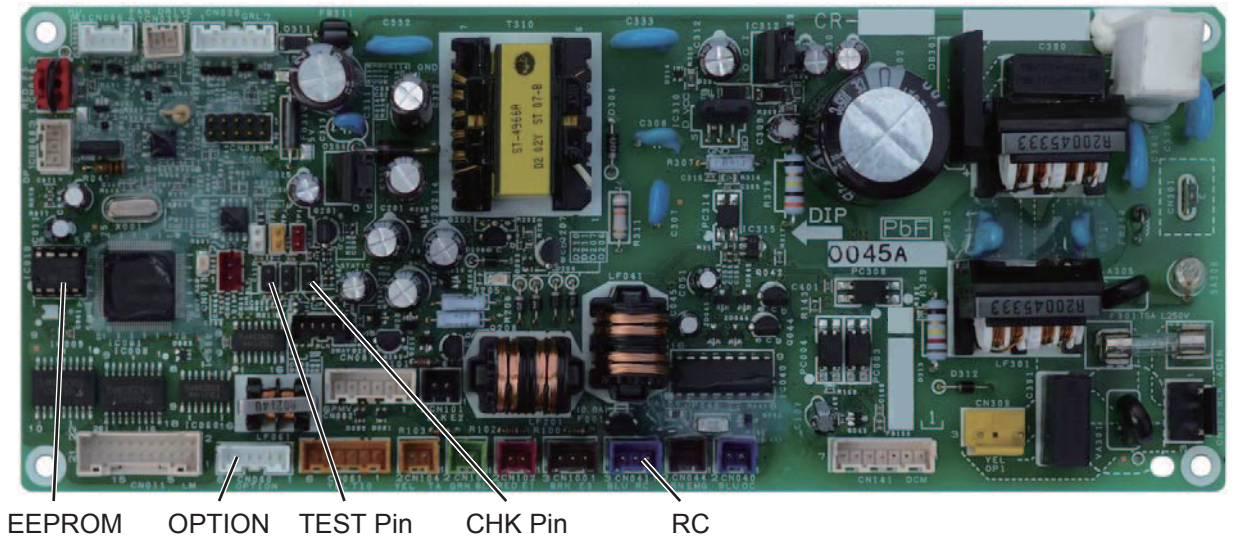
1 Auto Address	1-1	Is auto address setting complete?	Yes	1-2
			No	1-3
	1-2	Is there an auto address setting error (Is the outdoor unit showing an alarm)?	Yes	1-3
No			2-1	
	1-3	Conduct checks prior to auto address setting.		
2 Group Control Wiring	2-1	Is that indoor unit under group control?	Yes	2-2
			No	3-1
	2-2	Are there any indoor units with their power off in the remote control group's wiring?	Yes	Power on
			No	2-3
	2-3	Are nine or more indoor units connected in one remote control group's wiring?	Yes	Correct the wiring
No			2-4	
2-4	Was the remote control group's wiring changed after auto address setting was complete? Alternatively, were group settings changed in the remote control detailed settings mode?	Yes	2-5	
		No	3-1	
	2-5	No main unit in the remote control group's wiring? Re-execute auto address setting.		
3 Installation or setting related	3-1	Are the CHK pin and TEST pin on the indoor unit control board short-circuited?	Yes	Remove the short
			No	3-2
	3-2	Is the wireless remote controller connected to on the indoor unit's control PC board?	Yes	3-3
			No	3-5
	3-3	Disconnect the connector mentioned above on the PC board of the indoor unit control PC board, and see whether the E01 goes off after several minutes. (When doing so, if two remote controllers are being used and the wireless remote controller is the main remote controller, set the other remote controller as the main.)	Yes	3-4
			No	3-5
	3-4	Replace wireless remote control parts including wiring.		
3-5	Is the LED blinking on the indoor unit's control PC board?	Yes	3-6	
		No	3-7	
3-6	The nonvolatile memory (EEPROM) on the indoor unit's control PC board is either not installed, improperly installed or the nonvolatile memory is faulty. Correct this or after replacing the nonvolatile memory, write model data to it in the remote control detailed settings mode.			
3-7	Is there a short, miswiring, disconnection, wrong contact or grounding in the remote control's wiring?	Yes	Correct the wiring	
		No	Replace the indoor unit's control board.	

- Regarding the remote controller check, refer to the Reference Materials.
- For information on the procedures for replacing the nonvolatile memory (EEPROM) of the indoor unit and/or replacing the indoor unit's control board, refer to the manual that is packaged with the indoor unit service board.

**ACXA73-25530 : 4-Way Cassette Type (Type U2) Indoor Unit Control Board**

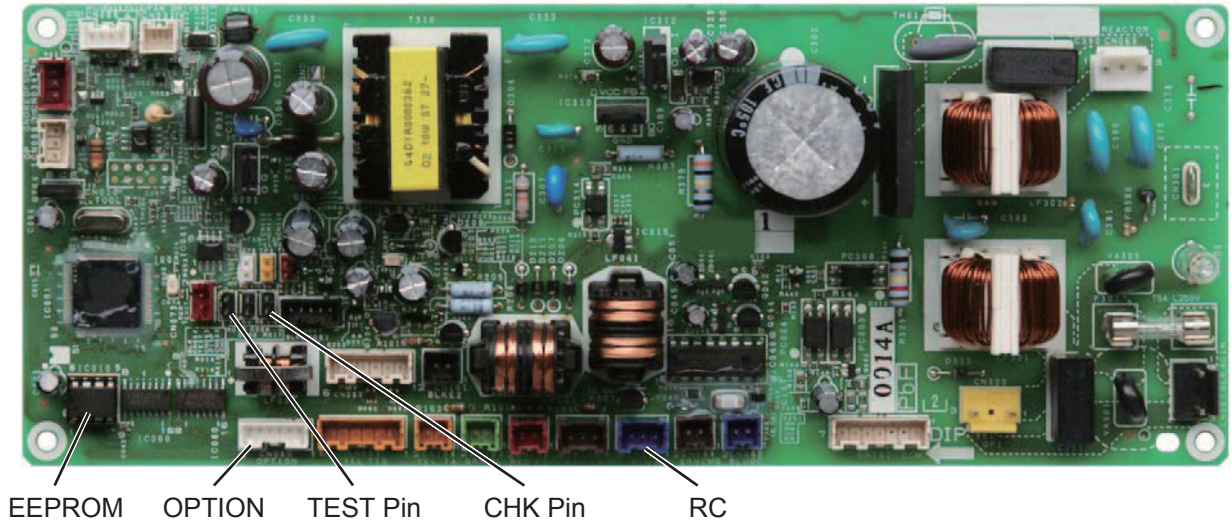


**ACXA73-25270 : Ceiling Type (Type T2) Indoor Unit Control Board**

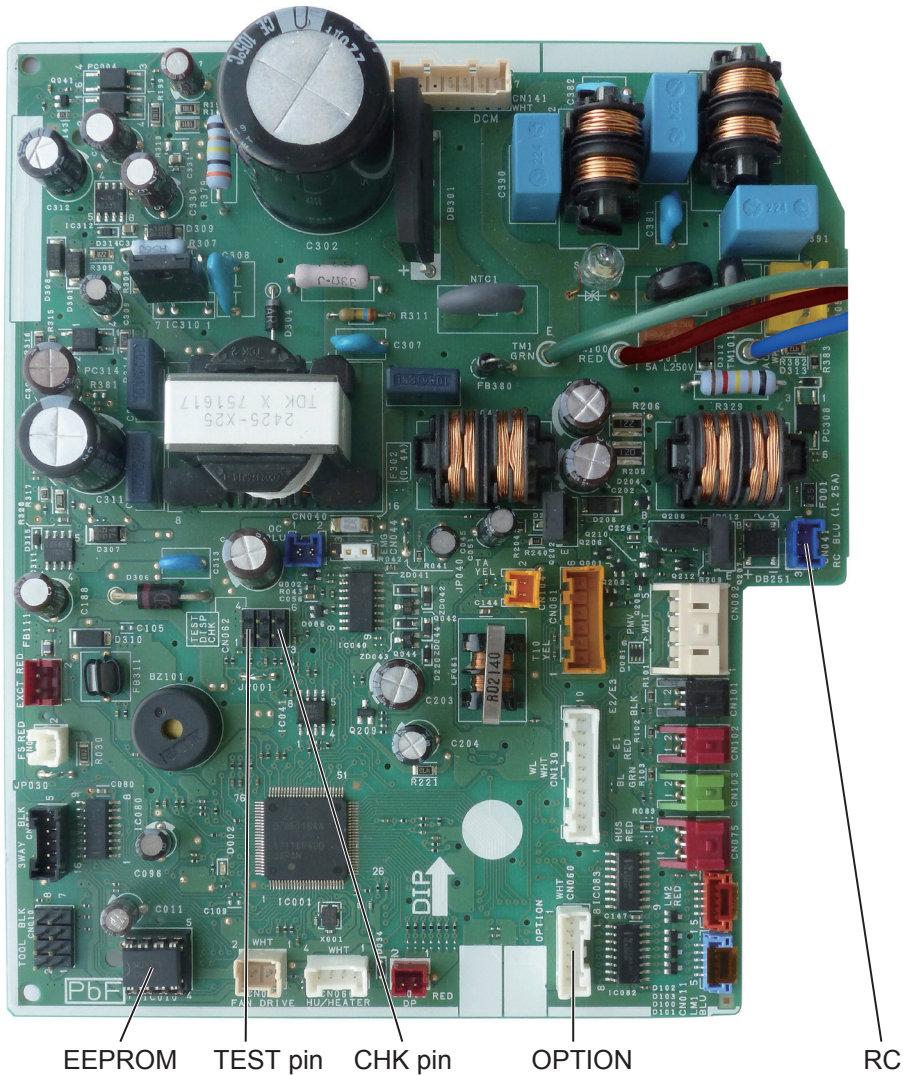


5

**ACXA73-25280 : Low Silhouette Ducted Type (Type F1) Indoor Unit Control Board**



**ACXA73C41820 : Wall Mounted Type (Type K2) Indoor Unit Control Board**



## E02 Remote Controller Transmission Error

### 1. Error Detection Method

When the remote controller itself cannot transmit. Or when it cannot receive the signal it transmitted itself, or when they are different and judged an error.

- Malfunction of the remote controller itself (transmit circuit error)

### 2. Error Diagnosis

1 Remote Control Group Wiring	1-1	Is the indoor unit under group control?	Yes	1-2
			No	2-1
	1-2	Are the wires 1 (white) & 2 (black) to the remote control group shorted or opened?	Yes	Correct the wiring
			No	2-1
2 Group Control Wiring	2-1	Is the wireless remote controller connected to on the indoor unit's control PC board?	Yes	2-2
			No	2-4
	2-2	Disconnect the connector mentioned above on the board of the indoor unit control PC board, and see whether the E02 goes off after several minutes. (When doing so, if two remote controllers are being used and the wireless remote controller is the main remote controller, set the other remote controller as the main.)	Yes	2-3
			No	2-4
	2-3	Replace wireless remote control parts including wiring.		
2-4	Is there a short, miswiring, open, wrong contact or grounding in the remote control's wiring?	Yes	Correct the wiring	
		No	Replace the indoor unit's control PC board	

- Regarding the remote controller check, refer to the Reference Materials.
- For information on the procedures for replacing the nonvolatile memory (EEPROM) of the indoor unit and/or replacing the indoor unit's control board, refer to the manual that is packaged with the indoor unit service board.

## E03 Error in Indoor Unit Receiving Signal from Remote Controller (central)

(When indoor unit(s) are connected)

### 1. Error Detection Method

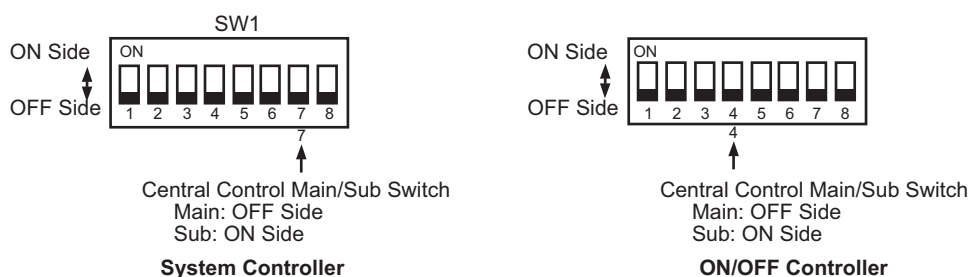
It is judged an error when there is no communication from any remote controller (collectively) in a 3-minute period or if there is no communication from the central device in a 15-minute period.

- When there was once communication, but during use the remote control wiring is opened or miswired.
- The line to the central control unit for indoor/outdoor operations is opened.
- Settings are made only for sub remote controller.
- The power to the central control unit is not on and remote controllers are not being used (or the indoor/outdoor operations line to the central control unit is opened).
- When remote controller are not being used, only the sub remote controller is set up.

### 2. Error Diagnosis

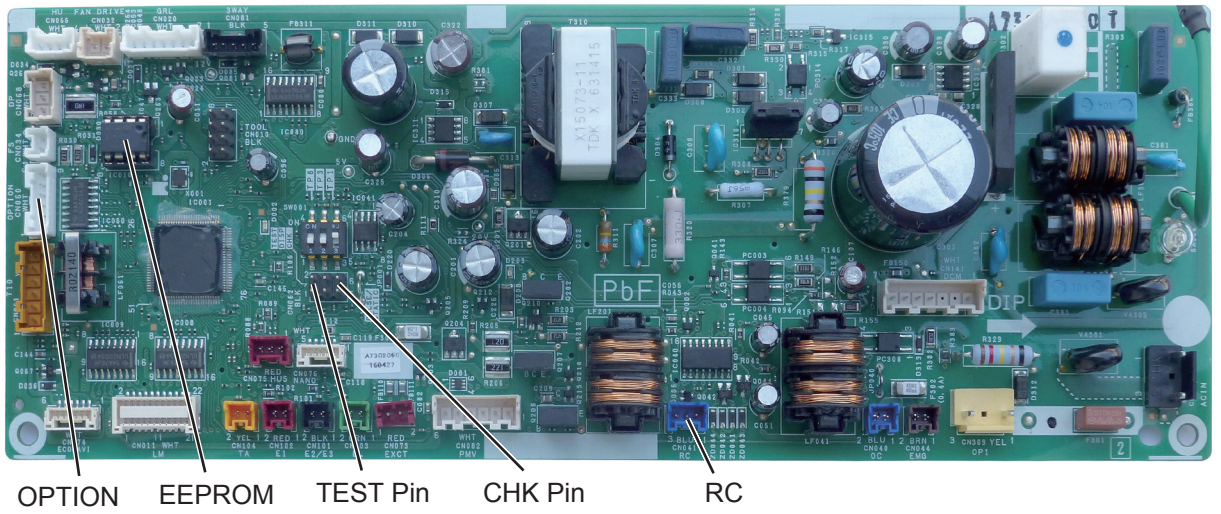
1 Central control unit	1-1	Is the central control unit connected?	Yes	1-2
			No	2-1
	1-2	Is the central control unit's powered off?	Yes	Power on
			No	1-3
	1-3	Are all the Main/Sub switches on the connected central control unit set to Sub?	Yes	1-4
No			1-5	
1-4	Of the central control units that are connected, set only the uppermost central control unit to Main and the others to Sub. The order from top to bottom is communication adaptor → system controller → ON/OFF controller.			
1-5	Is the indoor/outdoor operations line connected to the central control unit opened?	Yes	Correct the setting	
		No	2-1	
2 Remote controller	2-1	Is the indoor unit under group control?	Yes	2-2
			No	3-1
2-2	Are the wires 1 (white) & 2 (black) to the remote control group opened, have wrong contact or grounded?	Yes	Correct the setting	
		No	3-1	
3 Indoor unit control PC board	3-1	Is the wireless remote controller connected to on the indoor unit's control PC board?	Yes	3-2
			No	3-4
	3-2	Disconnect the connector mentioned above on the control PC board of the indoor unit control PC board, and see whether the E03 goes off after several minutes. (When doing so, if two remote controllers are being used and the wireless remote controller is the main remote controller, set the other remote controller as the main.)	Yes	3-3
			No	3-4
3-3	Replace wireless remote control parts including wiring.			
3-4	Is there a short, miswiring, open, wrong contact or grounding in the remote control's wiring?	Yes	Correct the wiring	
		No	Replace the indoor unit control board	

- Regarding the remote controller check, refer to the Reference Materials.
- For information on the procedures for replacing the nonvolatile memory (EEPROM) of the indoor unit and/or replacing the indoor unit's control board, refer to the manual that is packaged with the indoor unit service board.

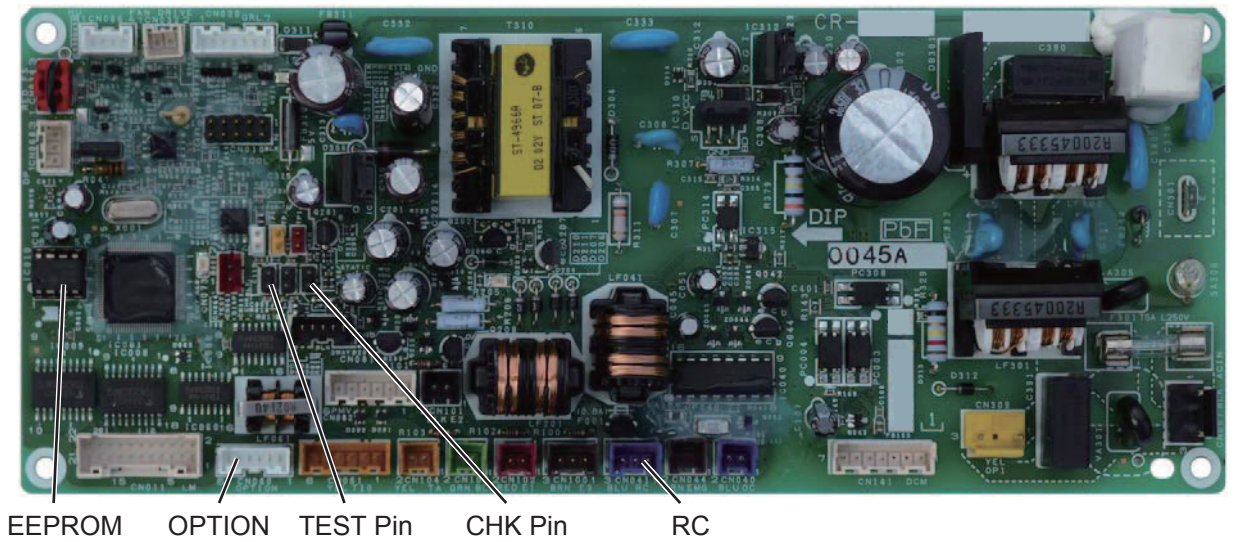




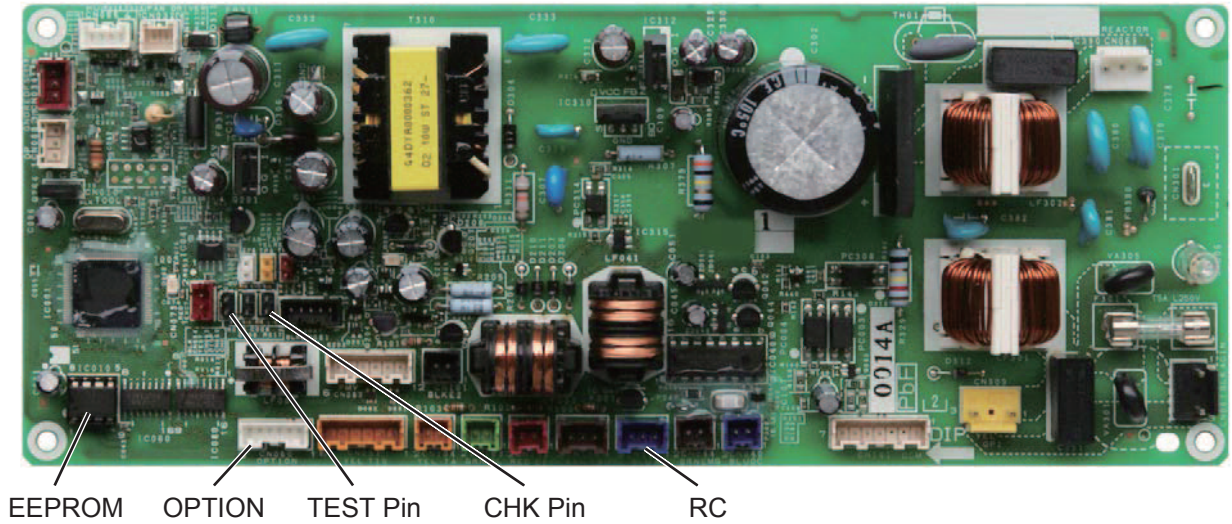
**ACXA73-25530 : 4-Way Cassette Type (Type U2) Indoor Unit Control Board**



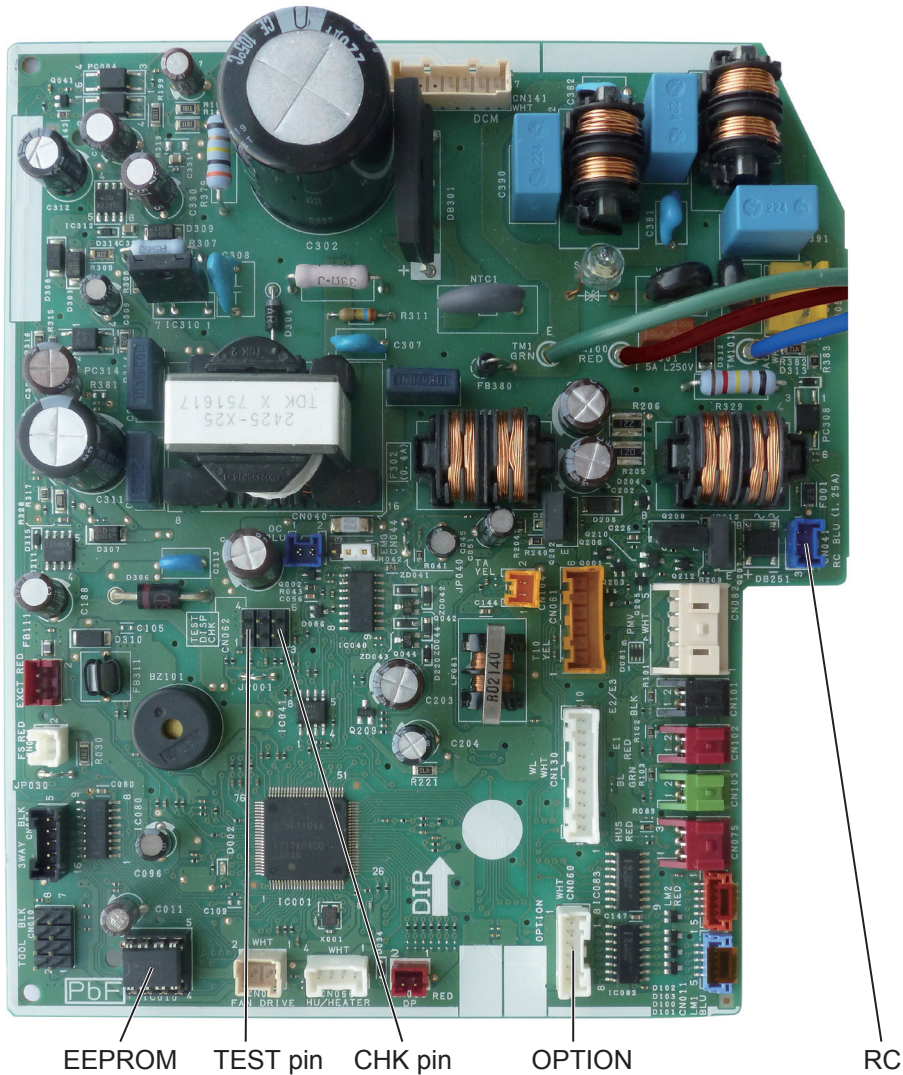
**ACXA73-25270 : Ceiling Type (Type T2) Indoor Unit Control Board**



**ACXA73-25280 : Low Silhouette Ducted Type (Type F1) Indoor Unit Control Board**



**ACXA73C41820 : Wall Mounted Type (Type K2) Indoor Unit Control Board**



## E04 Error in Indoor Unit Receiving Signal from the Outdoor unit

### 1. Error Detection Method

When there is no communication within a 3-minute period from the outdoor unit. Or, judged an error when no reply comes from the outdoor unit.

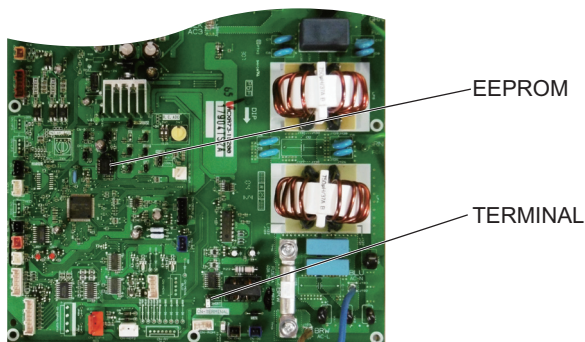
- The outdoor unit is not turned on.
- When the network of indoor/outdoor operation line was wired, the (SHORT) setting of the terminal resistor switch on the outdoor control PC board was set on multiple units (four or more).
- When the power was turned on after auto address setting was completed, the number of indoor units had been changed.
- Forgot to turn on the indoor unit.
- The CHK pin and/or TEST pin on the indoor unit's control PC board are shorted.
- Forgot to install the nonvolatile memory (EEPROM) when replacing the indoor unit control PC board.
- Mistakenly set the indoor unit address to Not Set in the remote control's detailed setting mode.
- When indoor unit addresses are duplicated.
- There is a short, open, wrong contact or grounding of the indoor/outdoor operation line.
- There is an error in the receiving circuit on the signal output PC board (optional control PC board).
- Malfunctions of the outdoor unit
- High voltage was applied (over AC200V) in the indoor/outdoor operations line circuit.
- The thermistor inside the indoor unit is grounded.

### 2. Error Diagnosis

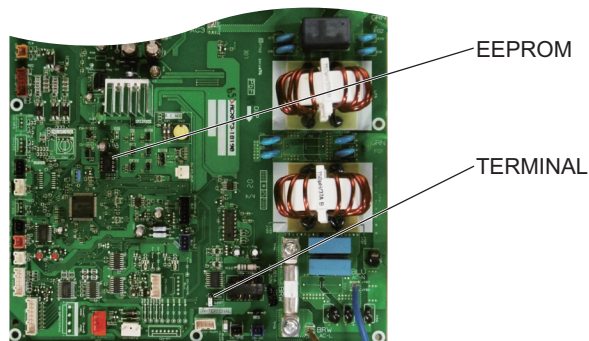
1 Power Source	1-1	Is/was the power to the outdoor unit cut off?	Yes	After turning the power on, wait three minutes
			No	1-2
	1-2	Is the indoor unit powered off?	Yes	Power on
			No	2-1
2 Indoor/outdoor control line	2-1	Is the indoor/outdoor operation line shorted, opened, grounded or has a wrong contact?	Yes	Correct the wiring
			No	2-2
	2-2	When the network of indoor/outdoor operation line was wired, was the (SHORT) setting of the terminal resistor switch on the outdoor control PC board set on multiple units (four or more)?	Yes	Normally the (SHORT) setting is just one unit.
			No	2-3
2-3	Was a high voltage (over AC200V) applied in the indoor/outdoor operations line circuit?	Yes	3-2	
		No	3-1	
3 No. of Indoor Units	3-1	Was the number of indoor units increased or decreased after auto address setting was complete?	Yes	3-2
			No	3-3
	3-2	Conduct checks prior to auto address setting.		
3-3	Check the indoor unit addresses from the remote control's detailed settings mode. Is it Not Set (99), or is the indoor unit's address duplicated?	Yes	3-2	
		No	4-1	
4 Indoor unit control PC board	4-1	Are the CHK pin and/or TEST pin on the indoor unit control PC board short-circuited?	Yes	Remove the short
			No	4-2
	4-2	Is the wireless remote controller connected to on the indoor unit's control PC board?	Yes	4-3
			No	4-5
	4-3	Disconnect the connector mentioned above on the control PC board of the indoor unit control PC board, and see whether the E04 goes off after several minutes. (When doing so, if two remote controllers are being used and the wireless remote controller is the main remote controller, set the other remote controller as the main.)	Yes	4-4
			No	4-5
	4-4	Replace wireless remote control parts including wiring.		
4-5	Is the LED on the indoor unit control PC board blinking?	Yes	4-6	
		No	4-7	
4-6	The nonvolatile memory (EEPROM) on the indoor unit's control PC board is either not installed, improperly installed or the nonvolatile memory is faulty. Correct this or after replacing the nonvolatile memory, write model data to it in the remote control detailed settings mode.			
4-7	Are all the remote controllers of the other indoor units connected to that outdoor unit displaying E04?	Yes	Replace the outdoor unit control board	
		No	Replace the indoor unit control board	

- Regarding the remote controller check, refer to the Reference Materials.
- For information on the procedures for replacing the nonvolatile memory (EEPROM) of the indoor unit and/or replacing the indoor unit's control board, refer to the manual that is packaged with the indoor unit service board.

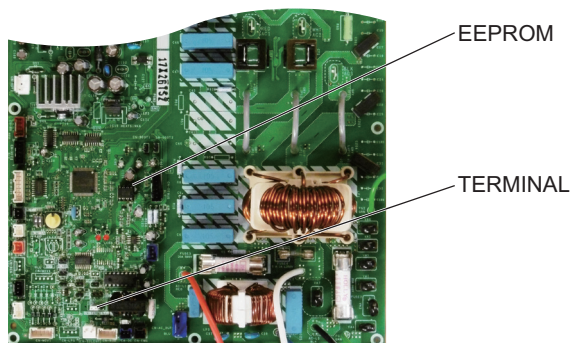
■ **Outdoor Unit Control PCB**  
**ACXA73-18200 : (U-100PZ2E5)**  
 (for single-phase outdoor unit PCB)



**ACXA73-18190 : (U-125PZ2E5, U-140PZ2E5)**  
 (for single-phase outdoor unit PCB)

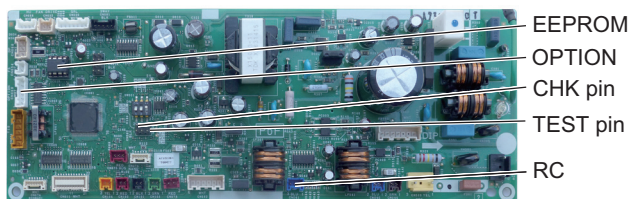


**ACXA73-19120 : (U-100PZ2E8, U-125PZ2E8, U-140PZ2E8)**  
 (for 3-phase outdoor unit PCB)

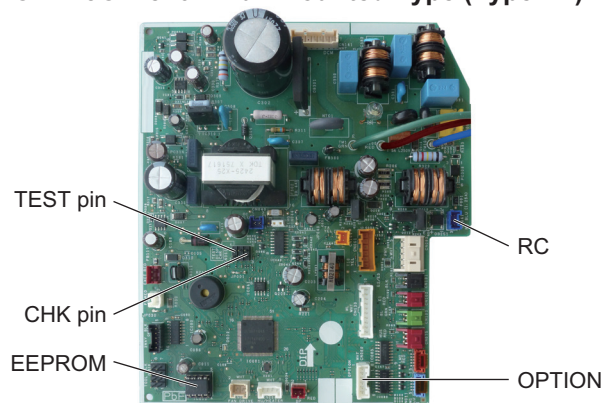


5

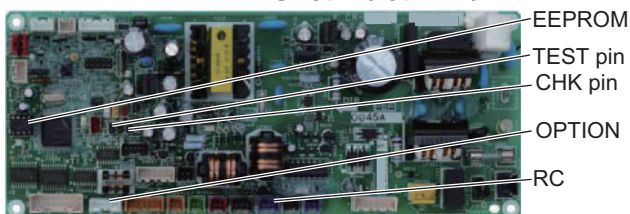
■ **Indoor Unit Control PCB**  
**ACXA73-25530 : 4-Way Cassette Type (Type U2)**



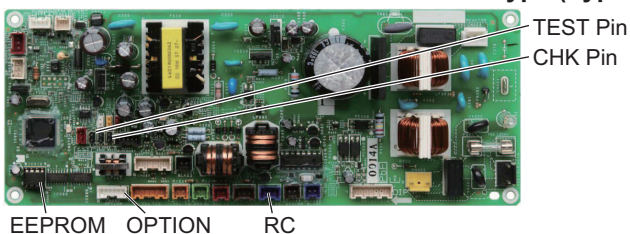
**ACXA73C41820 : Wall Mounted Type (Type K2)**



**ACXA73-25270 : Ceiling Type (Type T2)**



**ACXA73-25280 : Low Silhouette Ducted Type (Type F1)**



## E05 Error in Indoor Unit Transmitting Signal to the Outdoor Unit

### 1. Error Detection Method

It is judged an error when a unit itself cannot receive a signal that it has sent.

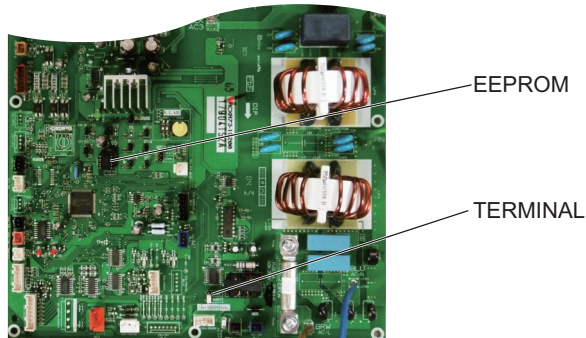
- Indoor unit control PC board error
- The setting of the terminal resistor select switch on the outdoor unit main PC board is set incorrectly.

### 2. Error Diagnosis

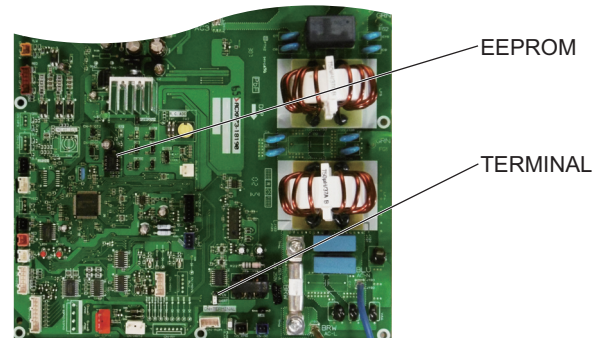
1 Indoor unit control PC board	1-1	Is the indoor/outdoor operation line connected to more than one outdoor unit? (Network wired?)	Yes	1-2
			No	1-3
	1-2	Is the SHORT on the terminal resistor select switch on the outdoor main PC board set to one unit, and the others are OPEN?	Yes	1-4
			No	Set the SHORT to one unit only
	1-3	Is the terminal resistor select switch on the outdoor main PC board set to OPEN?	Yes	Make the SHORT setting
No			1-4	
1-4	Is the indoor/outdoor operation line opened or shorted?	Yes	Correct the wiring	
		No	1-5	
1-5	Replace the indoor unit control PC board.			

- For information on the procedures for replacing the indoor unit's control PC board, refer to the manual that is packaged with the indoor unit service board.

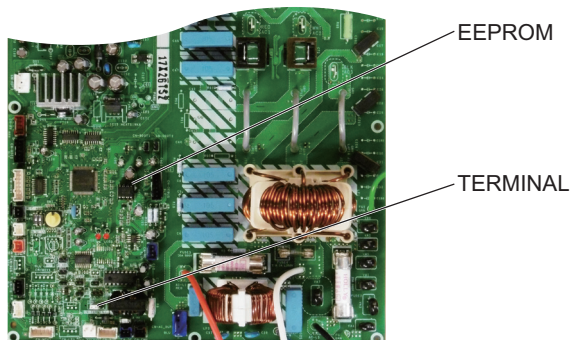
**ACXA73-18200 : (U-100PZ2E5)**  
(for single-phase outdoor unit PCB)



**ACXA73-18190 : (U-125PZ2E5, U-140PZ2E5)**  
(for single-phase outdoor unit PCB)



**ACXA73-19120 : (U-100PZ2E8, U-125PZ2E8, U-140PZ2E8)**  
(for 3-phase outdoor unit PCB)



## E06 Outdoor Unit Failed to Receive Serial Communication Signals from Indoor Unit

(When indoor unit(s) are connected)

### 1. Error Detection Method

It is judged an error when there is no transmission (reply) from the indoor unit to the outdoor unit for a period of three minutes.

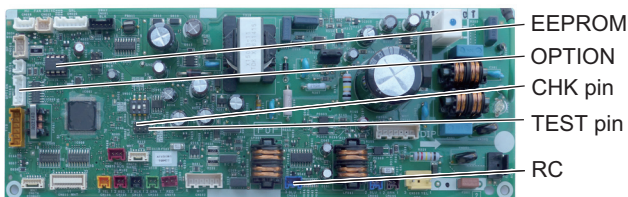
- The indoor unit is not turned on.
- The DISP pin of the indoor unit is shorted.
- There is a short, open, wrong contact or grounding of the indoor/outdoor operation line.
- The signal output control PC board (optional control PC board) inside the indoor unit has failed.
- The thermistor inside the indoor unit is grounded.

### 2. Error Diagnosis

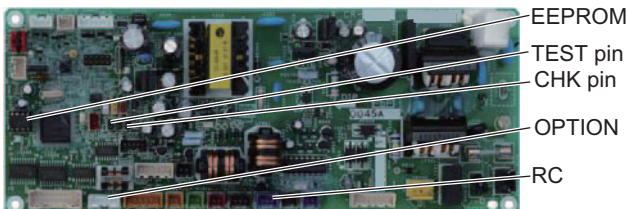
1 Indoor unit power	1-1	Is the indoor unit powered off?	Yes	Power on
			No	2-1
2 Indoor/outdoor operation line	2-1	Is the indoor/outdoor operation line shorted, opened, grounded or has a wrong contact?	Yes	Correct the wiring
			No	3-1
3 Indoor units control PC board	3-1	Are the DISP pin and CHK pin on the indoor unit control PC board short-circuited?	Yes	Remove the short
			No	3-2
	3-2	Is the wireless remote controller connected to on the indoor unit's control PC board?	Yes	3-3
			No	3-5
	3-3	Disconnect the connector mentioned above on the control PC board of the indoor unit control PC board, and see whether the E06 goes off after several minutes. (When doing so, if two remote controllers are being used and the wireless remote controller is the main remote controller, set the other remote controller as the main.)	Yes	3-4
			No	3-5
3-4	Replace wireless remote control parts including wiring.			
3-5	Indoor unit control PC board failure → Replace board.			

- For information on the procedures for replacing the indoor unit's control board, refer to the manual that is packaged with the indoor unit control PCB.

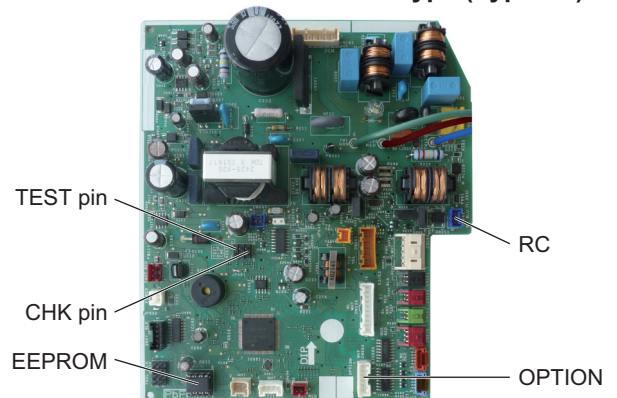
**ACXA73-25530 : 4-Way Cassette Type (Type U2)**



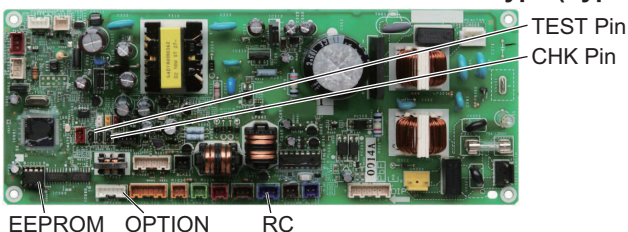
**ACXA73-25270 : Ceiling Type (Type T2)**



**ACXA73C41820 : Wall Mounted Type (Type K2)**



**ACXA73-25280 : Low Silhouette Ducted Type (Type F1)**



## E08 Duplicate Indoor Unit Address Settings Error

### 1. Error Detection Method

It is judged an error if the addresses of indoor units are duplicated.

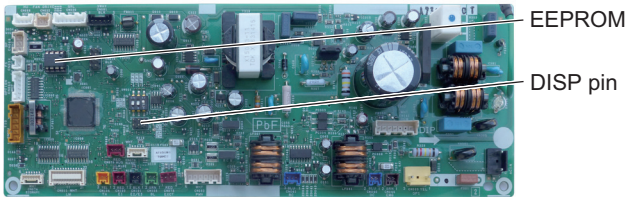
- The indoor unit address settings are duplicated in the remote control detailed settings mode.
- The multiple unit DISP pin is shorted across the indoor unit whose address is Not Set.

### 2. Error Diagnosis

1 Indoor unit control PC board	1-1	Is the DISP pin on the indoor unit control PC board shorted?	Yes	Remove the short
			No	1-2
	1-2	Conduct checks prior to auto address setting. Does E08 fail to go off even after running auto address setting again?	Yes	1-3
			No	1-4
	1-3	The nonvolatile memory (EEPROM) on the indoor unit board has failed. ↓ Replace the EEPROM.		
1-4	Do not make changes to indoor unit addresses with the detailed settings of the remote controller. Make them in the remote control address change mode.			

- For information on the procedures for replacing the nonvolatile memory (EEPROM) of the indoor unit, refer to the manual that is packaged with the indoor unit service board.

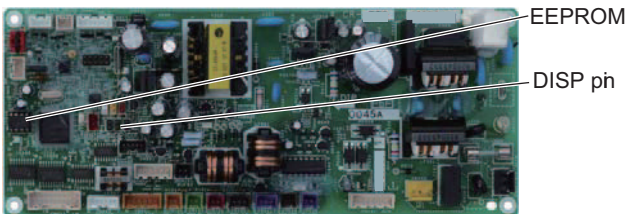
**ACXA73-25530 : 4-Way Cassette Type (Type U2)**



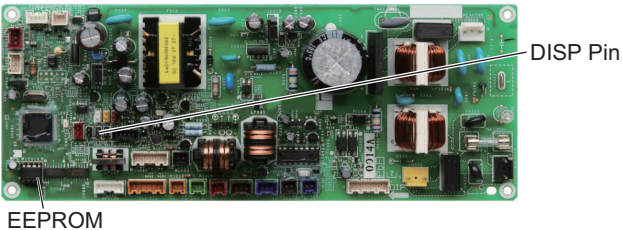
**ACXA73C41820 : Wall Mounted Type (Type K2)**



**ACXA73-25270 : Ceiling Type (Type T2)**



**ACXA73-25280 : Low Silhouette Ducted Type (Type F1)**



## E09 More Than One Remote Controller Set to Main Error

### 1. Error Detection Method

It is judged an error when more than one remote controller in a remote control group is set as the main remote controller.

- Forgot to set one remote controller to sub in a 2-remote control group.
- When using one wireless and one wired remote controller in a control group, forgot to set one of them to sub.

### 2. Error Diagnosis

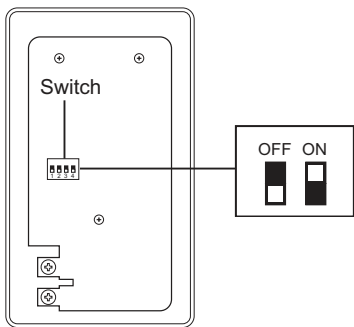
1 Remote controller	1-1	Set one of the 2 remote controllers to sub.
---------------------	-----	---

• Method for setting a remote controller to sub (CZ-RTC2)

1. Press and hold both + buttons for 4 seconds or longer.
2. This will display **SETTING**, the item "01" and the setting data "0001" or the like on the remote controller's display.
3. Press Timer / buttons to switch the setting data to "0000". (0000:SUB 0001:Main)
4. Press button (Once the display changes from flashing to steady, the setting is complete).
5. Once you press button, the remote controller returns to its normal display.

Wireless remote controller

#### CZ-RWSC3

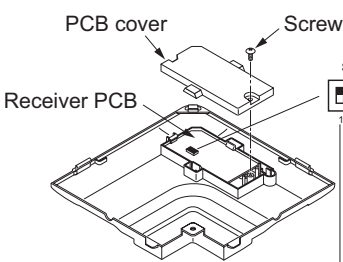


#### Main/Sub setting

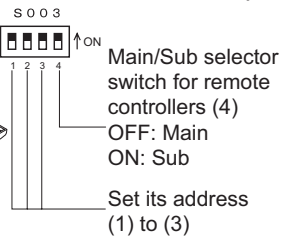
- Use this to set Main/Sub for the remote controller and the receiver.
- Set one to [Main] and the other to [Sub].
- Factory default: [Main]
- It is recommended to set the wired remote controller to [Main].

Main/Sub	MAIN	SUB
Main/Sub switch position		

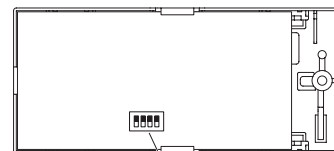
#### CZ-RWSU3



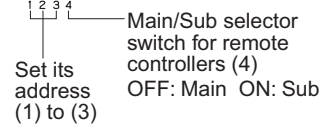
All set at OFF when shipped from the factory.



#### CZ-RWST3N



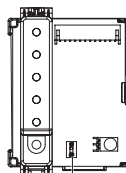
All set at OFF when shipped from the factory.



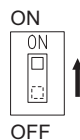
#### Type K2

<When Using Wireless Remote Controller Instead of Wired Remote Controller>  
When the wireless remote controller is to be used, slide the switch (SW502) to the ON position.

If this setting is not made, an alarm will occur. (The operation lamp on the display blinks.)



SW502



Setting status
ON: Wireless: main, Wired: sub
OFF: Wired: main, Wireless: sub (at shipment)

See "Section 8-18. <Optional parts setting and wiring>".



## **E12 Automatic Address Setting Start is Prohibited While Auto-address Setting in Progress.**

### **1. Error Detection Method**

It is judged an error if a command to start auto address setting comes from another controller during auto address setting.

- This occurs in a system that has more than one outdoor unit and operating lines among the indoor/outdoor units (networked wiring), when an instruction to start auto address setting is given from another controller during the auto address setting process.

### **2. Error Diagnosis**

1 Auto Address	1-1	When one controller in a networked system is running auto address setting, it is not possible to start auto address setting from another controller. Wait until the auto address setting in progress finishes.
----------------	-----	---

## E14 Main Unit duplication in Simultaneous-operation Multi Control (detected outdoor unit)

### 1. Error Detection Method

It is judged an error that the main units are duplicated in the indoor unit group.

- Main unit setting was made in the indoor unit group control setting of the remote control detailed settings mode.

### 2. Failure Diagnosis

1 Group Control Address	1-1	Are multiple indoor units set up as the main unit?	Yes	2-1
			No	2-2
2 Installation & Setting	2-1	Set up only one indoor unit as the main unit and other indoor units to the sub-unit.		
	2-2	Carry out the auto address setting.		

## E15 Automatic Address Alarm (The total capacity of indoor units is too low.)

### 1. Error Detection Method

Connecting indoor unit

It is judged an error the total capacity of indoor units replied by communication is lower than that of outdoor unit.

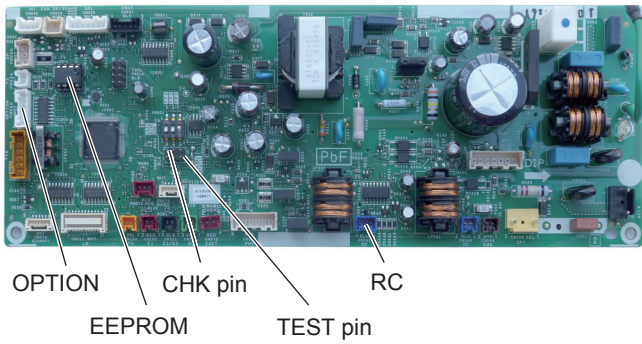
- The total capacity of indoor units is lower than that of outdoor unit.
- Some indoor unit(s) are connected but power is not turned on.
- The CHK pin (CN062/CN071) and/or TEST pin (CN064) of the indoor unit is shorted when its power is turned on.
- High voltage was applied (over AC200V) in the indoor/outdoor operations line circuit.

### 2. Error Diagnosis

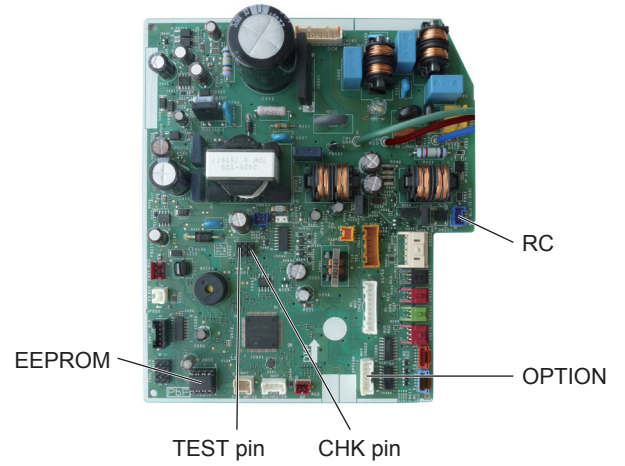
1 Power Source	1-1	Is the indoor unit powered off?	Yes	Power on
			No	2-1
2 Indoor/outdoor control line	2-1	Is the indoor/outdoor control line opened or shorted?	Yes	Correct the wiring
			No	2-2
	2-2	Was a high voltage (over AC200V) applied in the indoor/outdoor operations line circuit?	Yes	3-2
			No	3-1
3 No. of Indoor Units	3-1	Was the number of indoor units changed after auto address setting finished?	Yes	3-2
			No	4-1
	3-2	Conduct checks prior to auto address setting.		
4 Indoor unit control PC board	4-1	Are the CHK pin and TEST pin on the indoor unit control board short-circuited?	Yes	Remove the short
			No	4-2
	4-2	Is the wireless remote controller connected to on the indoor unit's control PC board?	Yes	4-3
			No	4-5
	4-3	Disconnect the connector mentioned above on the control PC board of the indoor unit control PC board and see whether the E15 goes off after several minutes. (When doing so, if two remote controllers are being used and the wireless remote controller is the main remote controller, set the other remote controller as the main.)	Yes	4-4
			No	4-5
	4-4	Replace wireless remote control parts including wiring.		
4-5	Is the LED blinking on the indoor unit's control PC board?	Yes	4-6	
		No	5-1	
4-6	The nonvolatile memory (EEPROM) on the indoor unit's control board is either not installed, improperly installed or the nonvolatile memory is faulty. Correct this or after replacing the nonvolatile memory, write model data to it in the remote control detailed settings mode.			
5 Outdoor unit control PC board	5-1	Check all items under the section "Check Prior to Auto Address Setting".		

- For information on the procedures for replacing the nonvolatile memory (EEPROM) of the indoor unit, refer to the manual that is packaged with the indoor unit service board.
- For information on the remote control's detailed settings, refer to the Reference Materials.
- The alarm also occurs when the indoor unit cannot be recognized (indoor unit only blackout, disconnection of indoor/outdoor operation line, etc.) during auto address setting.

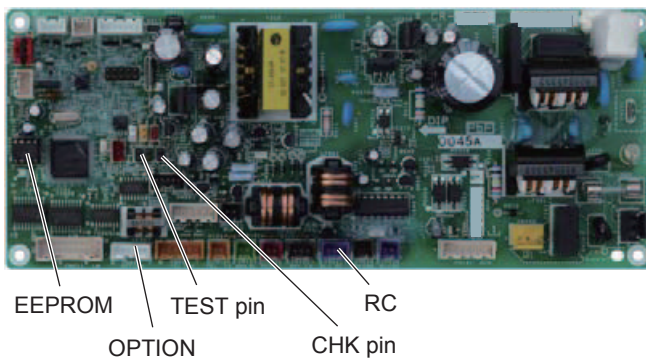
**ACXA73-25530 : 4-Way Cassette Type (Type U2)**



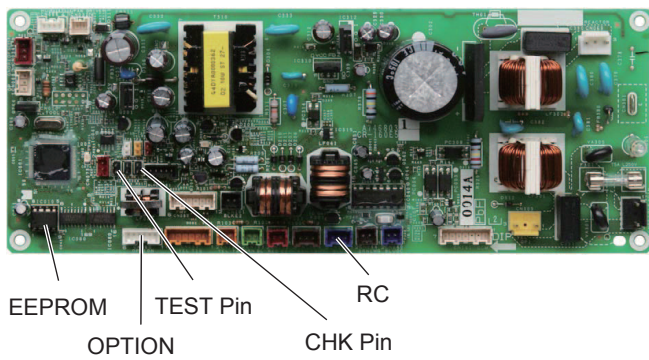
**ACXA73C41820 : Wall Mounted Type (Type K2)**



**ACXA73-25270 : Ceiling Type (Type T2)**



**ACXA73-25280 : Low Silhouette Ducted Type (Type F1)**



## E16 Automatic Address Alarm (The total capacity of indoor units is too high.)

### 1. Error Detection Method

It is judged an error the total capacity of indoor units is too high or the total number of indoor units is too many.

- The total capacity of indoor units is too high.
- The total number of indoor units is too many.

### 2. Error Diagnosis

1 Auto Address	1-1	Conduct checks prior to auto address setting.
----------------	-----	---

## E18 Faulty Communication in Group Control Wiring

### 1. Error Detection Method

When the main remote controller cannot communicate with a sub remote controller in the remote control group. It is judged an error if a sub remote controller in a remote control group fails to communicate with the main remote controller for a period of three minutes.

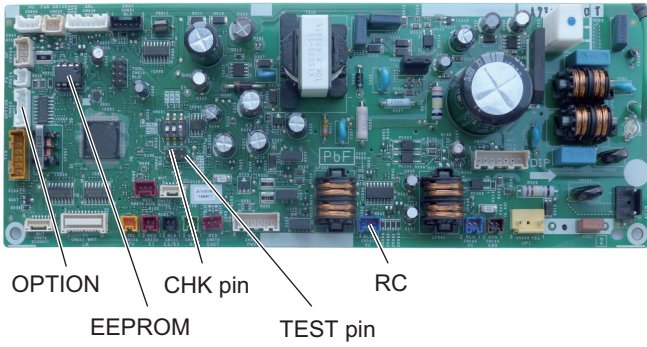
- An indoor unit within the control group does not have its power on.
- The CHK pin and TEXT pin on the indoor unit in the control group are shorted.
- The DISP pin of an indoor unit sub remote controller in the control group is shorted.
- Remote control group wiring is opened.
- More than one indoor unit in the control group is set to Main.
- An indoor unit in the control group is set to Separate.

### 2. Error Diagnosis

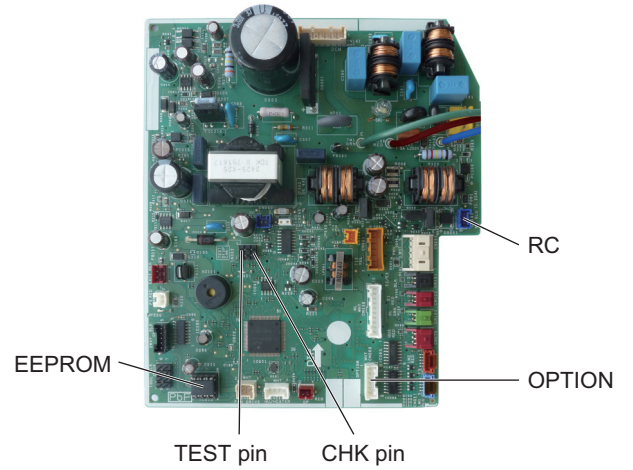
1 Indoor Unit	1-1	Is the indoor unit powered off?	Yes	Power on
			No	1-2
	1-2	Are the CHK pin, TEST pin and DISP pin on the indoor unit control PC board short-circuited?	Yes	Remove the short
			No	2-1
2 Substitute Sub Remote Controller	2-1	Is the remote control group's wiring opened?	Yes	Correct the wiring
			No	2-2
	2-2	Check the group settings (Item Code 14) from the remote control's detailed settings mode. Is the main remote controller (1) set to more than one remote controller or to separate (0)?	Yes	2-3
			No	3-1
	2-3	Is the wiring of the remote control group wired according to the wiring diagram?	Yes	2-4
			No	2-5
2-4	Run the auto address setting again.			
2-5	Run the auto address setting again after correcting the wiring of the remote control group.			
3 Indoor unit control PCB	3-1	Is the wireless remote controller connected to on the indoor unit's control PC board?	Yes	3-2
			No	3-4
	3-2	Disconnect the connector mentioned above on the control PC board of the indoor unit control PC board, and see whether the E18 goes off after several minutes. (When doing so, if two remote controllers are being used and the wireless remote controller is the main remote controller, set the other remote controller as the main.)	Yes	3-3
			No	3-4
	3-3	Replace wireless remote control parts including wiring.		
3-4	Replace the indoor unit control PC board.			

- For information on the remote control's detailed settings, refer to the Reference Materials.
- For information on the procedures for replacing the Indoor unit control PCB, refer to the manual that is packaged with the indoor unit service board.

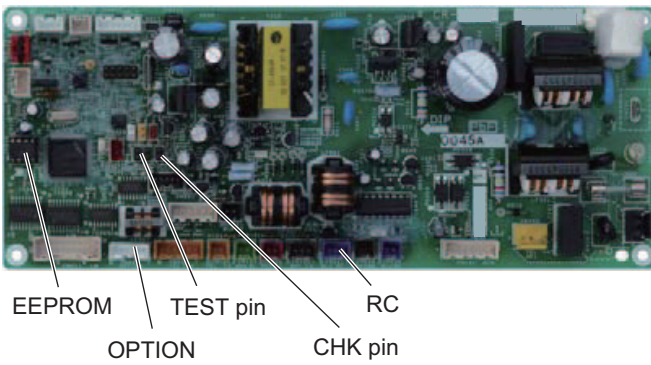
**ACXA73-25530 : 4-Way Cassette Type (Type U2)**



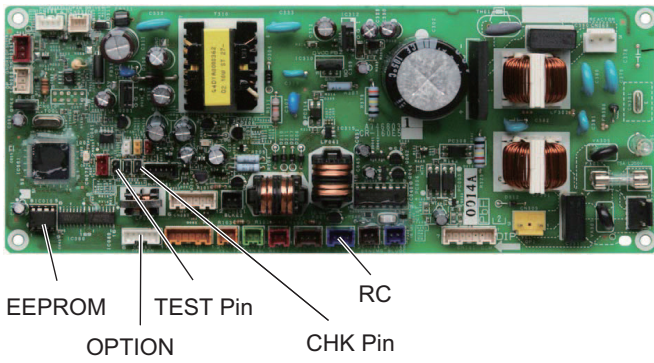
**ACXA73C41820 : Wall Mounted Type (Type K2)**



**ACXA73-25270 : Ceiling Type (Type T2)**



**ACXA73-25280 : Low Silhouette Ducted Type (Type F1)**



## E20 Connection Problem of Indoor/Outdoor Units

### 1. Error Detection Method

The outdoor unit detects an error at following cases during auto address setting.

- Indoor unit is not turned On.
- Indoor/outdoor control line is disconnected and also detects an error in the following cases when the outdoor unit is turned On.
- Address(es) of indoor unit(s) are not assigned correctly.
- Capacity of indoor/outdoor units is mismatched.
- Total number of indoor units is too many.

### 2. Error Diagnosis

1 Indoor Unit	1-1	Are the address(es) of indoor unit(s) assigned correctly?	Yes	1-2
			No	Set its address
	1-2	Are the indoor units turned on?	Yes	1-3
			No	Power on
	1-3	Be sure that the indoor and outdoor units are connected with correct combination written in catalog.	Yes	1-4
			No	Correct the connection
	1-4	The indoor/outdoor control line may be disconnected somewhere between the indoor unit(s) and the outdoor unit. Make sure the indoor/outdoor control line is connected.		



## F04 Compressor Discharge Temperature Sensor (TD) Trouble

### 1. Error Detection Method

It is judged an error based on the criteria listed below.

- Open circuit or Short circuit

### 2. Error Diagnosis

1 Sensor	1-1	Sensor connector is connected to PC board properly.	Yes	1-2
			No	Reconnect and check
	1-2	Sensor is correctly installed at holder side.	Yes	Replace sensor
			No	Correct and see what happens. 1-3
	1-3	Abnormal temperature exists even after replacing sensor.	Yes	2-1
			No	See what happens.
2 PC board	2-1	Resistance between connector pins on PC board is less than 1 k ohm	Yes	Replace PC board
			No	2-2
	2-2	Abnormal temperature exists even after replacing PC board.	Yes	3-1
			No	See what happens.
3 Operating status	3-1	Peripheral temperature of outdoor unit is over 46°C.	Yes	Correct
			No	3-2
	3-2	Tends to have insufficient refrigerant charge in the system.	Yes	Adjust the amount of refrigerant
			No	3-3
	3-3	Check noise.		

## F06 Inlet Temperature Sensor (C1) in Heat Exchanger Trouble

### 1. Error Detection Method

- In case of open or short

### 2. Error Diagnosis

1 Sensor Trouble	1-1	Is the connector properly connected to PCB?	Yes	1-2
			No	Reconnect & check
	1-2	Is the resistor between the sockets infinity or 0Ω?	Yes	Replace sensor.
			No	2-1
2 Control PCB Failure	2-1	Outdoor unit control PCB failure Replace PCB with a new one.		

## F07 Intermediate Temperature (C2) in Heat Exchanger Trouble

### 1. Error Detection Method

It is judged an error when open circuit or short circuit.

### 2. Error Diagnosis

1 Sensor	1-1	Sensor connector is connected to PC board properly.	Yes	1-2
			No	Reconnect and check
	1-2	Resistance between sockets is infinity or 0 ohm.	Yes	Replace sensor
			No	2-1
2 PC board	2-1	Replace PC board because of outdoor control PC board failure.		

## F08 Outdoor Air Temperature Sensor (TO) Trouble

### 1. Error Detection Method

It is judged an error when open circuit or short circuit.

### 2. Error Diagnosis

1 Sensor	1-1	Sensor connector is connected to PC board properly.	Yes	1-2
			No	Reconnect and check
	1-2	Resistance between sockets is infinity or 0 ohm.	Yes	Replace sensor
			No	2-1
2 PC board	2-1	Replace PC board because of outdoor control PC board failure.		

## F12 Compressor Inlet Suction Temperature Sensor (TS) Trouble

### 1. Error Detection Method

It is judged an error when open circuit or short circuit.

### 2. Error Diagnosis

1 Sensor	1-1	Sensor connector is connected to PC board properly.	Yes	1-2
			No	Reconnect and check
	1-2	Resistance between sockets is infinity or 0 ohm.	Yes	Replace sensor
			No	2-1
2 Outdoor control PC board	2-1	Replace PC board because of outdoor control PC board failure.		

## F31 Outdoor Unit Nonvolatile Memory (EEPROM) Trouble

### 1. Error Detection Method

It is judged an error based on the criteria listed below.

- When power initially turned ON for the first time, nonvolatile memory (EEPROM) is not installed.
- Read values after writing onto nonvolatile memory (EEPROM) is inconsistent.

### 2. Error Diagnosis

1 PC board	1-1	Does EEPROM exist on the control PC board?	Yes	1-2
			No	Install EEPROM
	1-2	Is EEPROM installed properly? (Check: Bent IC pin or incorrect installation, etc.)	Yes	1-3
			No	Correct
1-3	Incorrect EEPROM Replace with correct EEPROM.			

## H01 Primary (input) Overcurrent Detected

### 1. Error Detection Method

- Primary current effective value detected overcurrent (trip current value).

Trip current value                      hp = horse power

Single-phase model	4 hp	5 hp	6 hp
Heating	27.0A	29.0A	30.0A
Cooling	27.0A	29.0A	30.0A

Trip current value                      hp = horse power

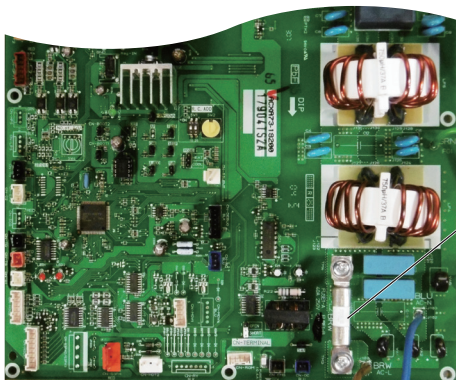
3-phase model	4 hp	5 hp	6 hp
Heating	12.5A	13.5A	14.5A
Cooling	12.0A	12.6A	13.0A

### 2. Error Diagnosis

1 Power supply*	1-1	Not satisfied with $\pm 10\%$ rated supply voltage	Yes	Check power supply
			No	1-2
	1-2	Extreme voltage fluctuations	Yes	Check power supply
			No	1-3
	1-3	Extreme distortion of voltage waveform	Yes	Check power supply
			No	1-4
	1-4	Instantaneous blackout may sometimes occur.	Yes	Check power supply
			No	2-1
2 PC board wiring	2-1	Has FUSE 1/FUSE 2 blown? Check the electrical conduction with tester.	Yes	2-3
			No	2-2
	2-2	Loose electrical wire connection	Yes	Correct wiring
			No	2-3
	2-3	Replace CR board.		

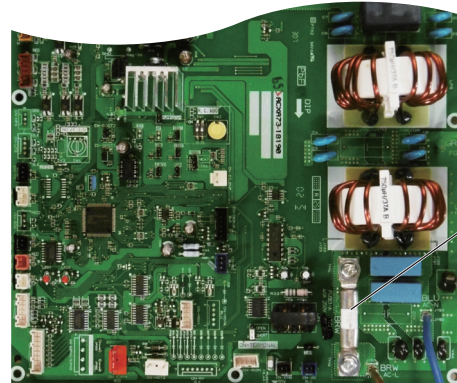
\* Check not only in the outdoor unit stop mode but in the drive mode.

**ACXA73-18200 : (U-100PZ2E5)**  
(for single-phase outdoor unit PCB)



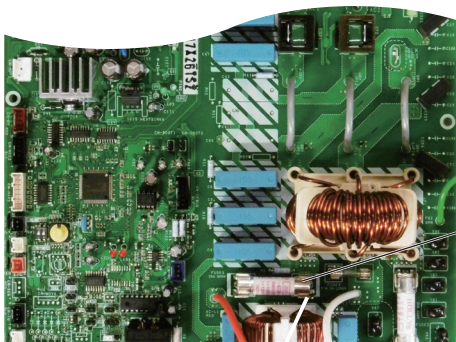
FUSE1

**ACXA73-18190 : (U-125PZ2E5, U-140PZ2E5)**  
(for single-phase outdoor unit PCB)



FUSE1

**ACXA73-19120 : (U-100PZ2E8, U-125PZ2E8, U-140PZ2E8)**  
(for 3-phase outdoor unit PCB)



FUSE3

## H02 PAM Trouble (Single-phase only)

### 1. Error Detection Method

- Error is detected by over-voltage and overcurrent of DC side.

### 2. Error Diagnosis

1 Power supply*	1-1	Not satisfied with $\pm 10\%$ rated supply voltage	Yes	Check power supply
			No	1-2
	1-2	Extreme voltage fluctuations	Yes	Check power supply
			No	1-3
	1-3	Extreme distortion of voltage waveform	Yes	Check power supply
			No	2-1
2 PC board wiring	2-1	Loose electrical wire connection	Yes	Correct connection
			No	2-2
	2-2	Is HIC PC board connector (CN-PAM) poorly connected or opened with wire?	Yes	Correct connection or wiring
			No	2-3
	2-3	Replace HIC PC board.		

\* Check not only in the outdoor unit stop mode but in the drive mode.



## H03 Primary Current CT Sensor (current sensor) Failure

### 1. Error Detection Method

It is judged an error based on the criteria listed below.

- If 18A or greater is detected when the compressor is stopped (alarm triggered even if the connector is unplugged).
- If no current is detected even though a compressor is running.

### 2. Error Diagnosis

1 Check the control PC board	1-1	Turn the power on again and run the outdoor unit. Is alarm occurred after operation?	Yes	Replace CR board.
			No	See what happens.

- Check also the power supply.

## H05 Sensor Failure, Compressor Discharge Temperature Sensor (TD) Disconnected

### 1. Error Detection Method

- (In case of outdoor temperature over 5°C) For 10 minutes since started, variation of discharge temperature is always detected within 2°C comparing with the temperature just before starting.
- (In case of outdoor temperature less than 5°C) For 30 minutes since started, variation of discharge temperature is always detected within 2°C comparing with the temperature just before starting.

1 Sensor Trouble	1-1	Is the sensor properly installed at the holder side?	Yes	1-2
			No	Reinstall correctly.
	1-2	Replace the sensor with a new one.		

## H31 HIC Trouble

### 1. Error Detection Method

It is judged an error if the computer detects an error signal from the HIC.

An error signal is issued by the HIC if abnormal heat occurs inside the HIC or if there is an overcurrent.

However, it is judged an error in the same way if the signal line from the HIC is not connected properly or opened.

- HIC overcurrent due to HIC fault
- HIC abnormal heat caused by defective HIC or HIC radiation error
- Signal line is not connected properly or opened between the HIC and the outdoor CR board.

### 2. Error Diagnosis

1 Wiring between HIC & outdoor control PC board	1-1	The wiring (power cord and signal line) between the HIC and the outdoor CR board is connected properly.	Yes	1-2
			No	Correct wiring (connector)
	1-2	Everything is normal in the wiring (power cord & signal line) between the HIC and the outdoor CR board. Check the wiring one by one with a tester if there is opened and grounding.	Yes	2-1
			No	Replace wiring
2 HIC poor radiation	2-1	The heat dissipating surface on the back of the HIC is in good contact with the heat sink (heat dissipating fins) of the electrical box. Check for looseness in the fastening screws and the condition of the heat-conducting putty.	Yes	2-2
			No	Tighten screw(s), add putty
	2-2	A good flow of cooling air passes through the heat sink (heat dissipating fins) of the electrical box. Check for debris blocking the fins.	Yes	3-1
			No	Remove foreign matter
3 HIC overcurrent	3-1	The results of the pass/fail tests for the following HIC board IPM show it to be outside the range of the resistance of a conforming part.	Yes	Replace the HIC PC board
			No	3-2
	3-2	The inverter compressor was stopped/started more than 10 times and it triggered H31 at a high rate. If alarm code P16 occurs at times, refer to the alarm code P16.	Yes	Replace the HIC PC board
			No	Refer to alarm code P16

#### • HIC board IPM Pass/Fail Tests

- Measure with an analog tester. (Set to the k ohm range)
- Measure the board by itself. (Remove wires connected from other parts.)
- Measure using IPM terminals.

#### ★ Conforming part resistance value (measure with an analog tester)

Tester terminals	P				NU			
+	P				NU			
-	U	V	W	NU	U	V	W	P
Resistance value (ohm)	1 k to 5 k	1 k to 5 k	1 k to 5 k	5 k to 10 k	100 k to ∞	100 k to ∞	100 k to ∞	100 k to ∞
Tester terminals	P				NU			
-	P				NU			
+	U	V	W		U	V	W	
Resistance value (ohm)	100 k to ∞	100 k to ∞	100 k to ∞		1 k to 5 k	1 k to 5 k	1 k to 5 k	

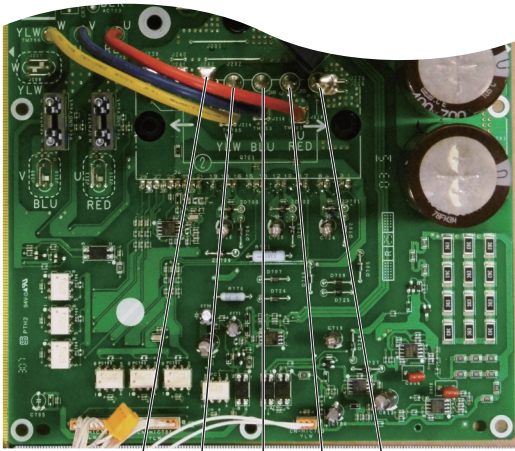
- Excepting the parts of "100 k to ∞", it is acceptable if a small resistance value appears as a reference value unless the value is "0 = short-circuit".

Tester terminals								
+	HIC+				HIC-			
-	U	V	W	HIC-	U	V	W	HIC+
Resistance value (ohm)	1 k to 10 k	1 k to 10 k	1 k to 10 k	5 k to 20 k	20 k to $\infty$	20 k to $\infty$	20 k to $\infty$	20 k to $\infty$
Tester terminals								
-	HIC+				HIC-			
+	U	V	W		U	V	W	
Resistance value (ohm)	20 k to $\infty$	20 k to $\infty$	20 k to $\infty$		1 k to 10 k	1 k to 10 k	1 k to 10 k	

- Excepting the parts of " 20 k to  $\infty$  ", it is acceptable if a small resistance value appears as a reference value unless the value is "0 = short-circuit".

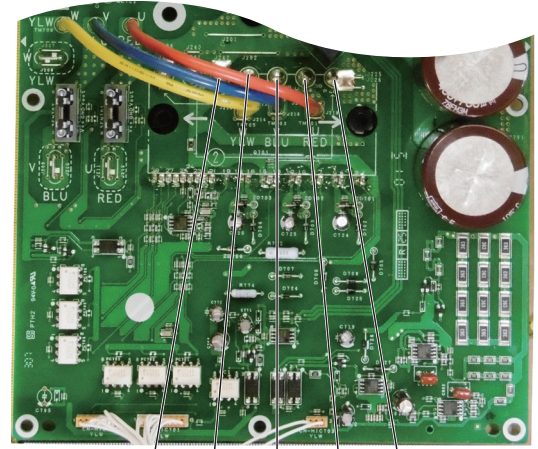
■ Outdoor Unit Control HIC PCB

ACXA73-18220 : (U-100PZ2E5)  
(for single-phase outdoor unit HIC PCB)



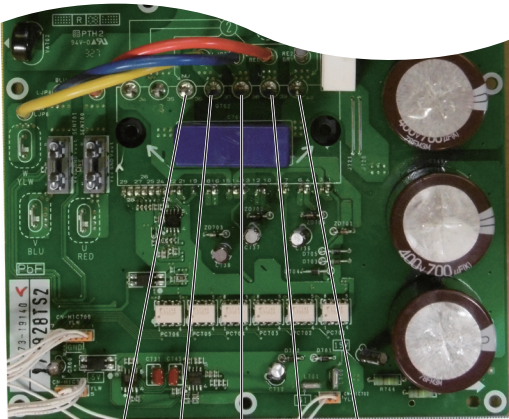
NU W V U P

ACXA73-18210 : (U-125PZ2E5, U-140PZ2E5)  
(for single-phase outdoor unit HIC PCB)



NU W V U P

ACXA73-19140 : (U-100PZ2E8, U-125PZ2E8, U-140PZ2E8)  
(for 3-phase outdoor unit HIC PCB)



NU W V U P

## L04 Outdoor Unit Address Duplication

### 1. Error Detection Method

It is judged an error when the identical self-address communication on the indoor and outdoor wirings is received over 5 times within 3 minutes.

### 2. Error Diagnosis

1 System address	1-1	Are other outdoor units using a duplicate setting?	Yes	2-1
			No	2-2
2 Installation or setting related	2-1	When units are networked, first set the system address for each outdoor unit in the order 1-2-3 and then run auto address setting.		
	2-2	Run the auto address setting.		

## L10 Outdoor Unit Capacity not Set or Invalid

### 1. Error Detection Method

It is judged an error when outdoor unit capacity not yet setup or systematically unauthorized setting.

### 2. Error Diagnosis

1 Check the control PC board	1-1	Was EEPROM replaced when PC board was replaced?	Yes	2-1
			No	Replace EEPROM
2 Installation or setting related	2-1	Set an applicable capacity value on the item code 81 display of maintenance remote controller.		

- Check : Connect the outdoor maintenance remote controller and check whether item code 81 outdoor capacity value shows "0" or unauthorized capacity is set on the detailed setting mode display of the outdoor EEPROM.  
If the capacity value of the item code 81 with the outdoor maintenance remote controller is incorrect, recorrect and set it again.

\* After setting the capacity value, be sure to reset the power supply switches of both indoor and outdoor units.

## L13 Indoor Unit Type Setting Error

### 1. Error Detection method

- Discordance model(s) between outdoor and indoor units are detected.

1 Discordance Unit	1-1	Are models for outdoor and indoor units matched respectively? (Ex: Are multiple indoor units connected to commercial outdoor units?)	Yes	2-1
			No	Replace indoor units.
2 Installation Failure	2-1	Check the indoor unit's motor valve with the remote control detailed settings mode (2C code) and commercial indoor unit is set to "2" and multiple indoor unit is "0".	Yes	3-1
			No	Change installation.
3 Operating Wires for Indoor & Outdoor Units	3-1	Check whether or not indoor and outdoor unit operating wires are short circuit, disconnection, loose connection or earth fault.		



## L18 4-Way Valve Operation Failure

### 1. Error Detection Method

It is judged an error when during heating operation (Comp. ON), the highest detected temperature at an outdoor unit heat exchanger (C1) was 20°C or more above the outdoor air temperature (Air Temp.) continuously for 5 minutes or longer.

### 2. Error Diagnosis

1 PC board wiring	1-1	Is the connector wired from the 4-Way valve plugged in the CN-20S connector on the HIC PC board properly?	Yes	1-2
			No	Correct connector
	1-2	Has the 4-Way valve wiring become opened?	Yes	Correct wiring
			No	1-3
	1-3	Is the wire from the coil for controlling the 4-Way valve firmly connected to the 4-Way valve?	Yes	2-1
			No	Correct connector
2 4-Way valve	2-1	During heating mode (Comp. ON), insert and remove the connector wired from the 4-Way valve into or from CN-20S connector on the HIC PC board. At the same time, does the ON & OFF sounds occur from the 4-Way valve?	Yes	2-2
			No	Replace HIC PC board
	2-2	During heating mode (Comp. ON), does the alarm code L18 reproduce for 5 minutes or longer after insertion and removal of CN-20S connector wired from the 4-Way valve connector on the HIC PC board?	Yes	2-3
			No	See what happens
	2-3	The parts inside the 4-Way valve might have fixed at the cooling side. Replace the 4-Way valve		

## P03 Compressor Discharge Temperature Trouble

### 1. Error Detection Method

- When the discharge temperature is over 106°C.

### 2. Error Diagnosis

1 Adjustment to refrigerant charge	1-1	Not additional refrigerant charged	Yes	Additional refrigerant charge
			No	2-2
	1-2	Tends to have insufficient refrigerant charge in the system.	Yes	Adjust the refrigerant amount
			No	Replace CR board
2 Blockage in refrigerant circuit	2-1	Service valve inside the outdoor unit closed	Yes	Open service valve
			No	2-2
	2-2	Are the tubes clogged?	Yes	Avoid clogging
			No	2-3
	2-3	Is the outdoor unit's electronic control valve operating correctly? (Check for debris clogging the electronic control valve, a problem with the electrical coil and/or the control PC board.)	Yes	2-4
			No	Replace the electronic control valve
	2-4	Is it observable difference in status of the dew or frost between the strainer's primary and secondary sides?	Yes	Replace the strainer
			No	Replace CR board

## P04 High Pressure Trouble

### 1. Error Detection Method

It is judged an error if the internal circuit of the high pressure switch is dead.  
 The electronic circuitry of the high pressure switch is cut off if the pressure at the pressure sensor port of the high pressure switch reaches 3.80 MPa. Once it is cut off, it remains cut off until the pressure drops to 3.15 MPa.

- The high pressure switch is malfunctioning.
- Service valve inside the outdoor unit closed
- There is a short air circuit through the outdoor unit's heat exchanger. (when cooling)
- The outdoor unit's fan is broken. (when cooling)
- The outdoor unit's heat exchanger is clogged. (when cooling)
- There is a short air circuit at the indoor unit. (when heating)
- The filter of the indoor unit is clogged. (when heating)
- The fan of the indoor unit is broken or the fan motor is malfunctioning. (when heating)
- The refrigerant circuit is closed and the high pressure is increasing abnormally high. (solenoid valve or expansion valve not activated, a stuck check valve, etc.)
- Refrigerant overcharged.
- Nitrogen or air contaminated in the refrigerant system

### 2. Error Diagnosis

1 High pressure switch	1-1	The socket of the high pressure switch is securely inserted in the PC board. The wiring is not opened.	Yes	1-2
			No	Correct connection and/or wiring
	1-2	Even if parts near the high pressure switch are shaken quite a lot, the high pressure cutoff will be activated. Even if the covering is in good condition, in several cases vibration has caused wiring inside to open.	Yes	Replace the high pressure switch (wiring)
			No	2-1
2 Service valve	2-1	Service valve inside the outdoor unit closed	Yes	Open the service valve
			No	2-2
	2-2	There is an extreme difference in temperature in/out of the service valve.	Yes	2-3
			No	3-1
2-3	Check the flare connection, someone may have forgotten to remove the bonnet. If there is a problem within the service valve, replace the valve.			
3 Problem around the heat exchanger	3-1	While cooling is operating an alarm is occurred.	Yes	3-2
			No	3-5
	3-2	The intake temperature (ambient temperature) of the outdoor unit's heat exchanger is above 46°C.	Yes	Prevent air short circuit
			No	3-3
	3-3	The outdoor unit's heat exchanger is clogged.	Yes	Clean the heat exchanger
			No	3-4
	3-4	Check whether the outdoor unit fan is normal or if the sockets are firmly pressed onto the plugs on the outdoor PC board, as well as if any wiring is opened. Are these checking finished without fail?	Yes	4-1
No			Replace the outdoor unit fan. Correct connection and/or wiring	
3-5	While heating is operating an alarm is occurred.	Yes	3-6	
		No	4-1	

3 Problem around the heat exchanger	3-6	The intake temperature (ambient temperature) of the indoor unit is above 36°C.	Yes	Prevent air short circuit
			No	3-7
	3-7	The filter of the indoor unit is clogged.	Yes	Clean the filter
			No	3-8
	3-8	The fan of the indoor unit is broken or the fan motor is faulty.	Yes	Replace the indoor fan (motor)
			No	4-1
4 Blockage in the refrigerant circuit	4-1	Is the outdoor unit's electronic control valve operating correctly? (Check for debris clogging the electronic control valve, a problem with the electrical coil and/or the control PC board.)	Yes	4-3
			No	Repair the electronic control valve of the outdoor unit
	4-2	The indoor unit's expansion valve is operating correctly. (check for debris clogging the valve, a problem with the electrical coil and/or the control PC board)	Yes	4-3
			No	Repair the expansion valve of the indoor unit
	4-3	If an alarm is occurred with the high pressure below 3.80 MPa, with the pressure measured as displayed by the manifold gauge, check the check valve in the compressor discharge line. Are these checking finished without fail?	Yes	4-4
			No	Replace the check valve in the compressor discharge line
	4-4	The electronic control valve is faulty. In systems where the solenoid valve kits and the ice thermal storage tank are connected, check these solenoid valves.	Yes	Replace the electronic control valve and/or solenoid valve.
			No	5-1
5 Overcharging	5-1	Error occurs when the system is operating in cooling mode.	Yes	5-3
			No	5-2
	5-2	Error occurs when the system is operating in heating mode.	Yes	5-4
			No	5-5
	5-3	An alarm is occurred with the high pressure at 3.80 MPa, with the pressure measured either as displayed by the monitoring software or with a manifold gauge, at which time the temperature of liquid in the outdoor unit's heat exchanger is detected to be at the temperature of the outside air.	Yes	5-5
			No	Contact the service representative
	5-4	An alarm is occurred with the high pressure at 3.80 MPa, with the pressure measured either as displayed by the monitoring software or with a manifold gauge, at which time the temperature of liquid in the indoor heat exchanger is detected to be at room temperature (intake temperature).	Yes	5-5
			No	Contact the service representative
5-5	The system may be overcharged. Check how much refrigerant was added during installation. When a system is inspected for airtightness, it is seldom that enough nitrogen has been expelled, so some remains in the circuit. In this case, it is necessary to collect the refrigerant and then recharge the system.			

## P05 AC Power Supply Trouble

### 1. Error Detection Method

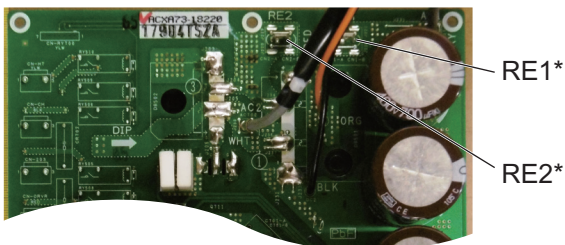
- Instantaneous blackout
- Zero-cross (waveform input of power supply) error
- DC voltage charge failure

### 2. Error Diagnosis

Note : The work involved in diagnosing each of the items is extremely dangerous, so turn the power off at the breaker before performing the tests.

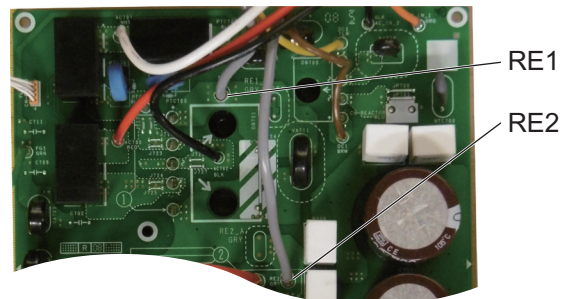
1 Check the power supply & the wiring	1-1	Is the voltage on each of the terminal boards within $\pm 10\%$ of the rated voltage?	Yes	1-3 : Single-phase model 1-2 : 3-phase model
			No	Check for open circuit and the voltage at the breaker. if a problem is found, fix it and check again.
	1-2	Power wiring L1 and L3 are connected.	Yes	Correct wiring
			No	1-3
	1-3	Turn the power back on and check again. Is the alarm triggered again?	Yes	2-1
			No	3-1
2 Check the outdoor unit HIC PC board	2-1	Are the wires (RE1, RE2) from the reactor firmly installed? Are the wires also connected to the side of the reactor?	Yes	2-2
			No	Correct wiring
	2-2	Turn the power back on and check again. Is the alarm triggered again?	Yes	Replace the outdoor unit HIC PC board.
			No	3-1
3 Final check	3-1	There may be a instantaneous blackout failure. If there is nothing abnormal, see what happens.		

**Single-phase outdoor unit HIC PCB**



Common in RE1 and RE2  
 4HP: Plug-in type  
 5HP, 6HP : Fastening screw type

**3-phase outdoor unit HIC PCB**



## P13 Alarm Valve Open

### 1. Error Detection Method

Detection is performed only in the test run. When once detected or the test run finished without any error, the second detection will not be done.

In case of forgetting to open a valve, P04 (high-pressure switch operational alarm) is occasionally preceded due to the following conditions.

- The status of small temperature change of the operating indoor unit continues for the first 7 minutes since the cooling test run has started.

### 2. Error Diagnosis

1 Service valve	1-1	Service valve inside the outdoor unit closed	Yes	Open the service valve
			No	2-1
2 Adjustment to refrigerant change	2-1	Not additional refrigerant charged	Yes	Additional refrigerant charge
			No	3-1
3 Blockage in refrigerant circuit	3-1	Are the tubes clogged?	Yes	Avoid clogging
			No	3-2
	3-2	Is the outdoor unit's electronic control valve operating correctly? (Check for debris clogging the electronic control valve, a problem with the electrical coil and/or the control PC board.)	Yes	3-3
			No	Replace the electronic control valve
3-3	As the second detection is not done, restart and see what happens if there is no error.			

## P14 O<sub>2</sub> Sensor Detect

### 1. Error Detection Method

- It is judged an error whenever the outdoor unit receives the signal "O<sub>2</sub> Alarm Occurred" from the indoor unit.
- With the indoor unit's EEPROM setting (item code 0B) set to 0001, the EXCT input was shorted.

### 2. Error Diagnosis

1 System configuration	1-1	Is an O <sub>2</sub> sensor being used?	Yes	3-1
			No	2-1
2 Indoor unit's EEPROM setting	2-1	Is the indoor EEPROM setting, item code 0B, on the indoor unit's control PC board set to 0001?	Yes	After correcting the setting, 3-1
			No	4-1
3 Indoor EXCT wiring	3-1	Is the indoor EXCT socket (wire) shorted?	Yes	Correct wiring
			No	4-1
4 Indoor unit's control PC board	4-1	Is the alarm triggered if the indoor EXCT socket (wire) is disconnected, and the power is reset?	Yes	4-3
			No	4-2
	4-2	Since there is no error, see what happens.		
	4-3	Indoor unit control PC board error → replace PC board.		

## P15 Insufficient Gas Level Detected

### 1. Abnormal Detection Method

Alarm occurs in the following cases:

- Compressor's current value shows lower than a certain value.
- Compressor's discharge temperature exceeds 95°C.
- Electronic expansion valve is fully opened.
- The difference between indoor unit heat exchanger temperature and intake temperature is less than 4K.

### 2. Error Diagnosis

1 Adjustment of refrigerant amount	1-1	Insufficient gas level (Check whether or not pressure level is normal.)	Yes	Recharge with additional refrigerant.
			No	1-2
	1-2	Check leakage of refrigeration (leak test)	Yes	Replace leaking part with a new one.
			No	See what happens.



## P16 Compressor Overcurrent Trouble

### 1. Meaning of Alarm

- Secondary current effective value detected the overcurrent (trip current value).  
 Single-phase model (4hp – 6hp) : Trip current = 27.0 A      3-phase model (4hp – 6hp) : Trip current = 17.0 A
- Secondary current instantly detected overcurrent (trip current value).  
 Single-phase model (4hp – 6hp) : Trip current = 45.0 A<sub>peak</sub>      3-phase model (4hp – 6hp) : Trip current = 27.0 A<sub>peak</sub>

### 2. Check of content

0 Multiple factors	0-1	Replaced the compressor (added oil, if it was necessary) but it occurred again immediately.	Yes	7-1
			No	-
	0-2	Replaced the board, but it occurred again immediately.	Yes	Replace compressor along with adding oil, then recheck from 1-1
			No	-
1 Power Source	1-1	Power cord connections are loose.	Yes	Correct the wiring
			No	1-2
	1-2	Rated power voltage is not within $\pm 10\%$ .	Yes	Test the power supply
			No	1-3
	1-3	Extreme fluctuations in voltage.	Yes	Test the power supply
			No	1-4
	1-4	An open phase state is observed.	Yes	Test the power supply
			No	2-1
2 Board wiring	2-1	Disconnected parts, miswiring and/or poor connections (loose) are observed in the connections on the CR board and/or in the connections of components that are connected by wiring from the CR board.	Yes	Correct
			No	2-2
	2-2	Disconnected parts, miswiring and/or poor connections (loose) are observed in the connections of outdoor board(s) that are connected by wiring from the CR board.	Yes	Correct
			No	2-3
	2-3	Disconnected parts, miswiring and/or poor connections (loose) are observed in the connections of outdoor board(s) that are connected by wiring from the HIC board.	Yes	Correct
			No	2-4
	2-4	Disconnected parts, miswiring and/or poor connections (loose) are observed in the connections of HIC boards connected by wiring from the CR board.	Yes	Correct
			No	2-5
	2-5	Disconnected parts, miswiring and/or poor connections (loose) are observed in the connections of HIC board(s) that are connected by wiring from the outdoor board.	Yes	Correct
			No	2-6
	2-6	Disconnected parts, miswiring and/or poor connections (loose) are observed in the connections of HIC board(s) that are connected by wiring to a compressor.	Yes	Correct
			No	3-1
3 Compressor wiring	3-1	Disconnections and/or miswiring are observed in the connecting location of the compressor terminals.	Yes	Correct
			No	3-2
	3-2	Conditions such as burned terminal covers and/or discolored terminals are observed in the connecting location of the compressor terminals.	Yes	Eliminate looseness by changing the terminals, or crimping the terminals again.
			No	4-1

4 Check the situation	4-1	Outdoor air intake temperature is high.	Yes	Take measures
			No	4-2
	4-2	May be caused by poor outdoor unit air flow (dirty or clogged heat exchanger, blocked discharge port, etc.)	Yes	Correct
			No	4-3
	4-3	Air short circuit has occurred. This is a phenomenon when discharged air (exhaust heat) from the outdoor unit is drawn back into the suction vent.	Yes	Prevent air short circuit
			No	4-4
	4-4	Indoor air intake temperature is high.	Yes	Take measures
			No	4-5
	4-5	The filter of the indoor unit is clogged.	Yes	Clean the filter
			No	4-6
	4-6	Air short circuit has occurred. This is a phenomenon when discharged air (exhaust heat) from the indoor unit is drawn back into the suction vent.	Yes	Prevent air short circuit
			No	5-1
5 Check operation	5-1	Possible to operate.	Yes	5-2
			No	6-1
	5-2	Operating pressure is affected by pressure overload.	Yes	5-3
			No	5-4
	5-3	Tends to have an overcharge of refrigerant in the system.	Yes	Adjust the amount of refrigerant
			No	5-4
	5-4	Tends to operate for a long time turning gas back into liquid.	Yes	Check the operation of functional parts
			No	5-5
	5-5	Tends to have insufficient refrigerant charge in the system.	Yes	Adjust the amount of refrigerant
			No	5-6
	5-6	Even though the high pressure saturation temperature is 43°C or less, the secondary current of the inverter is high. (The frequency (Hz) ends up dropping due to the current.)	Yes	Replace the compressor
			No	See what happens.
6 Check history	6-1	Dividing the outdoor EEPROM INV operation time by the number of times oil was supplied to the system yields 3 hours or less.	Yes	6-2
			No	6-2
	6-2	There is a history of H31 in the pre-trip counter of the outdoor EEPROM alarm history.	Yes	Replace the compressor and add oil. However if 6-1 was "no," it is not necessary to add oil.
			No	7-1
7 Check the HIC boards	7-1	The results of HIC board IPM Pass/Fail Tests show the outside the range of the resistance of a conforming part listed in the next page.	Yes	Replace HIC board
			No	8-1
8 Check the compressor	8-1	The compressor is causing a failure in the insulation.	Yes	Replace the compressor
			No	8-2
	8-2	The winding resistance of the compressor is abnormal. See Section "5-4. (3) Coil Resistance of Compressor".	Yes	Replace the compressor
			No	9-1

9 Check the HIC PC boards	9-1	Replace the HIC PC board and operate the unit. (Apply putty and screws must not be loose) Does it operate normally?	Yes	See what happens.
			No	10-1
10 Check the outdoor unit main PC board	10-1	Replace the control PC board and operate the unit.	See what happens.	

- (Check content of 7) The test check of the HIC board is only a check on the output level, so the input stage may not be working.
- With the filter board broken, alarm P16 may not be triggered.

**• HIC board IPM Pass/Fail Tests**

- Measure with an analog tester. (Set to the k ohm range.)
- Measure the board by itself. (Remove wires connected from other parts.)
- Measure using IPM terminals.

**★ Conforming part resistance value (measure with an analog tester)**

Tester terminals	P				NU			
+								
-	U	V	W	NU	U	V	W	P
Resistance value (ohm)	1 k to 5 k	1 k to 5 k	1 k to 5 k	5 k to 10 k	100 k to ∞	100 k to ∞	100 k to ∞	100 k to ∞

Tester terminals	P				NU			
-								
+	U	V	W		U	V	W	
Resistance value (ohm)	100 k to ∞	100 k to ∞	100 k to ∞		1 k to 5 k	1 k to 5 k	1 k to 5 k	

- Excepting the parts of “100 k to ∞”, it is acceptable if a small resistance value appears as a reference value unless the value is “0 = short-circuit”.

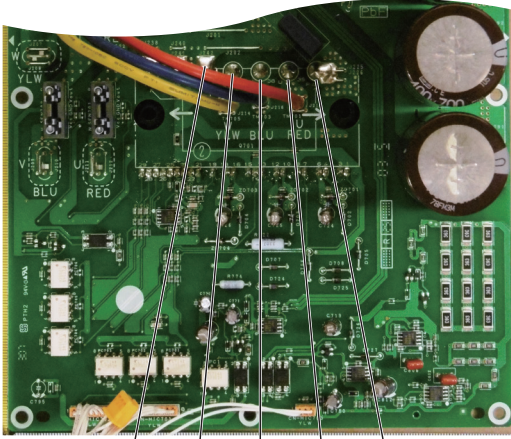
Tester terminals	HIC+				HIC-			
+								
-	U	V	W	HIC-	U	V	W	HIC+
Resistance value (ohm)	1 k to 10 k	1 k to 10 k	1 k to 10 k	5 k to 20 k	20 k to ∞	20 k to ∞	20 k to ∞	20 k to ∞

Tester terminals	HIC+				HIC-			
-								
+	U	V	W		U	V	W	
Resistance value (ohm)	20 k to ∞	20 k to ∞	20 k to ∞		1 k to 10 k	1 k to 10 k	1 k to 10 k	

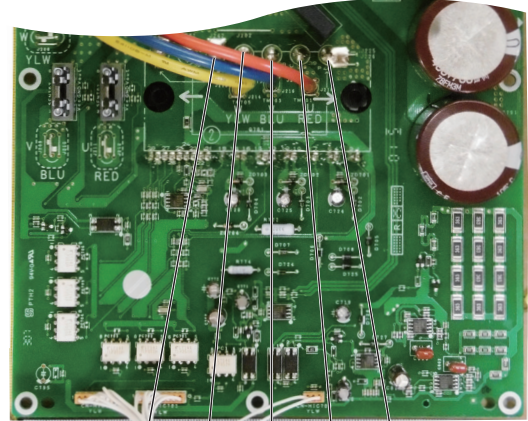
- Excepting the parts of “20 k to ∞”, it is acceptable if a small resistance value appears as a reference value unless the value is “0 = short-circuit”.

■ Outdoor Unit Control HIC PCB

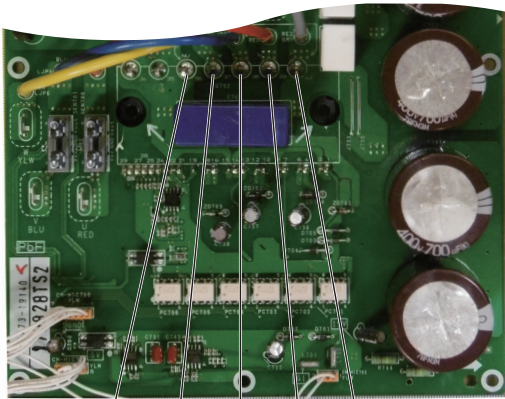
ACXA73-18220 : (U-100PZ2E5)  
(for single-phase outdoor unit HIC PCB)



ACXA73-18210 : (U-125PZ2E5, U-140PZ2E5)  
(for single-phase outdoor unit HIC PCB)



ACXA73-19140 : (U-100PZ2E8, U-125PZ2E8, U-140PZ2E8)  
(for 3-phase outdoor unit HIC PCB)



## P22 Outdoor Unit Fan Motor Trouble

### 1. Error Detection Method

- It is judged an error when the outdoor fan motor's rotating signal cannot be detected normally.

### 2. Error Diagnosis

1 Wiring	1-1	Are the connectors "CN-FMA", "CN-FMB", "CN-FM1", and "CN-FM2" firmly connected to the outdoor control PC board (lock engaged)?	Yes	2-1
			No	Correct the connector connections
2 Outdoor fan motor	2-1	Disconnect the connectors "CN-FMA", "CN-FMB", "CN-FM1", and "CN-FM2" from the outdoor control PC board and rotate the outdoor fan by hand; does it rotate freely? (Check the outdoor fan motor lock)	Yes	3-1
			No	Replace the outdoor fan motor
3 Outdoor control PC board	3-1	Turn the power on and run the unit again; is P22 triggered again? Or can you see or hear anything that is obviously wrong in its rotation?	Yes	3-2
			No	3-3
	3-2	Replace the outdoor control PC board. (If it fails to operate normally even after replacing the outdoor control PC board, replace the outdoor fan motor.)		
	3-3	If there is nothing particularly out of the ordinary, see what happens.		

## P29 Lack of INV compressor wiring, INV compressor actuation failure (including locked), DCCT failure

### 1. Error Detection Method

- Abnormal current is detected at DCCT before start-up.
- Start-up failed during overcurrent and/or step-out detected.
- Open-wire of compressor and/or backspin detected.
- Secondary current is not detected during INV compressor is running.

### 2. Error Diagnosis

1 Wiring	1-1	Disconnected parts, miswiring and/or poor connections (loose) are observed in the connections of HIC PC board(s) that are connected by wiring to a compressor. *1	Yes	Correct wiring connections
			No	1-2
	1-2	Disconnected parts, miswiring and/or poor connections (loose) are observed in the connections of outdoor board(s) that are connected by wiring from the HIC PC board. *1	Yes	Correct wiring connections
			No	2-1
2 Compressor wiring	2-1	Disconnections and/or miswiring is observed in the connections of the compressor terminals. *1	Yes	Correct
			No	2-2
	2-2	Conditions such as burned terminal covers and/or discolored terminals are observed at the connectors of the compressor terminals. *1	Yes	Eliminate looseness by changing the terminals, or crimping the terminals again.
			No	3-1
3 Check the HIC PC boards	3-1	The results of the pass/fail tests for the following HIC PC board IPM show it to be outside the range of the resistance of a conforming part.	Yes	Replace the HIC board
			No	3-2
	3-2	Replace the HIC PC board and operate the unit. (Apply putty and screws must not be loose) Does it operate normally?	Yes	See what happens.
			No	4-1
4 Check the outdoor control PC board	4-1	Replace the control PC board and operate the unit.	See what happens.	

\*1 Checking for looseness of compressor terminals by wiggling them has the adverse effect of loosening them, so do not do it. Evaluate them by discoloration of wire insulation near the terminal.

#### • HIC board IPM Pass/Fail Tests

- Measure with an analog tester. (Set to the k ohm range)
- Measure the board by itself. (Remove wires connected from other parts.)
- Measure using IPM terminals.

#### ★ Conforming part resistance value (measure with an analog tester)

Tester terminals	P				NU			
+								
-	U	V	W	NU	U	V	W	P
Resistance value (ohm)	1 k to 5 k	1 k to 5 k	1 k to 5 k	5 k to 10 k	100 k to ∞	100 k to ∞	100 k to ∞	100 k to ∞

Tester terminals	P				NU			
-								
+	U	V	W		U	V	W	
Resistance value (ohm)	100 k to ∞	100 k to ∞	100 k to ∞		1 k to 5 k	1 k to 5 k	1 k to 5 k	

- Excepting the parts of "100 k to ∞", it is acceptable if a small resistance value appears as a reference value unless the value is "0 = short-circuit".

Tester terminals	HIC+				HIC-			
+								
-	U	V	W	HIC-	U	V	W	HIC+
Resistance value (ohm)	1 k to 10 k	1 k to 10 k	1 k to 10 k	5 k to 20 k	20 k to ∞	20 k to ∞	20 k to ∞	20 k to ∞

Tester terminals	HIC+				HIC-			
-								
+	U	V	W		U	V	W	
Resistance value (ohm)	20 k to ∞	20 k to ∞	20 k to ∞		1 k to 10 k	1 k to 10 k	1 k to 10 k	

- Excepting the parts of "20 k to ∞", it is acceptable if a small resistance value appears as a reference value unless the value is "0 = short-circuit".

## P31 Group Control Error

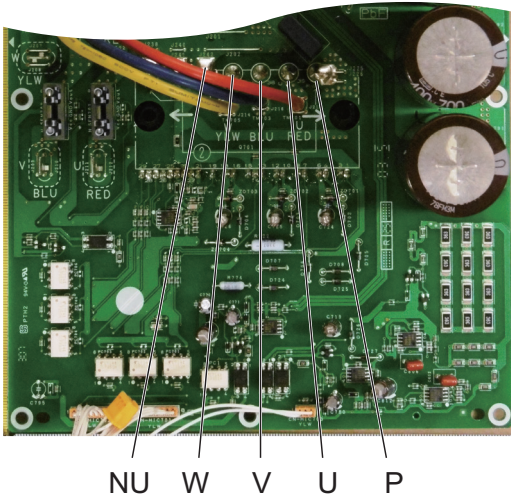
### 1. Error Detection Method

- Other indoor unit alarms within the group.

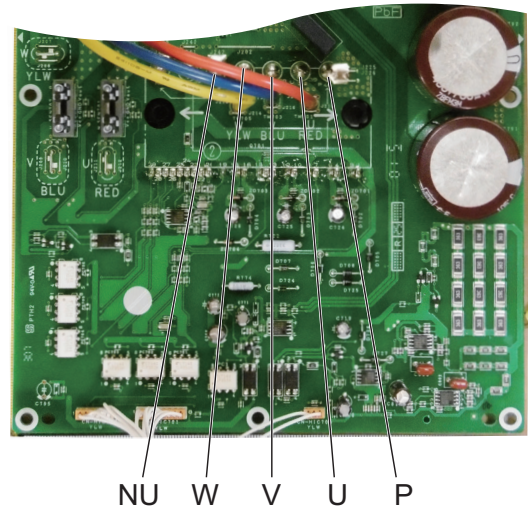
1 Other indoor unit	1-1	Survey the indoor unit that alarms other than "P31" in the indoor unit group and specify the causes of failure.
---------------------	-----	---

■ Outdoor Unit Control HIC PCB

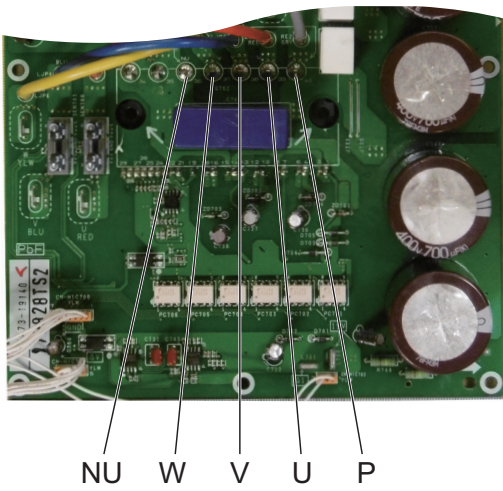
ACXA73-18220 : (U-100PZ2E5)  
(for single-phase outdoor unit HIC PCB)



ACXA73-18210 : (U-125PZ2E5, U-140PZ2E5)  
(for single-phase outdoor unit HIC PCB)



ACXA73-19140 : (U-100PZ2E8, U-125PZ2E8, U-140PZ2E8)  
(for 3-phase outdoor unit HIC PCB)





## 5-4. Inspection of Parts (Outdoor Unit)

### (1) Electronic control valve (MOV1)

- MOV1: Measure the voltage between plug pin 5 and pins 1 through 4 at the CN-MOV1 connector (5P, white) on the outdoor unit control PCB. (Because of the pulse output, a simplified measurement method is used. Set the tester to the 12 V range; if the value displayed is approximately 4 V, then the voltage is normal.) If the voltage is normal, measure the resistance between connector pin 5 and pins 1 through 4. Resistance between pin 5 and pins 1 through 4 should be approximately 46 Ω for all. (If the result is 0 Ω or, ∞ then replace the coil.)

### (2) Outdoor Unit Fan Motor

Model No.	Part No. (Panasonic)	Part No.
U-100PZ2E5, U-125PZ2E5, U-140PZ2E5, U-100PZ2E8, U-125PZ2E8, U-140PZ2E8	L6CBYYYYL0245	NFD-81FW-D8120-5

### (3) Coil Resistance of Compressor

Model No.	Part No. (Panasonic)	Part No.	Inverter compressor (at 20°C)		
			U - V	V - W	U - W
U-100PZ2E5	ACXB09-05130	9VD330XAB21	0.872	0.884	0.859
U-125PZ2E5	ACXB09-05140	9VD420XAB21	0.659	0.670	0.650
U-140PZ2E5	ACXB09-05140	9VD420XAB21	0.659	0.670	0.650
U-100PZ2E8	ACXB09-05180	9VD330XBA21	3.071	3.125	3.031
U-125PZ2E8	ACXB09-05190	9VD420XBA21	2.510	2.561	2.475
U-140PZ2E8	ACXB09-05190	9VD420XBA21	2.510	2.561	2.475

## 5-5. Symptom: Thermostat in OFF continues or cycles OFF & ON too frequently

### 1. How to detect abnormality

- Abnormality does not occur. Protective function can be checked when the outdoor maintenance remote controller is connected.

### 2. Error Diagnosis

1 Indoor control PC board	1-1	Setting temperature reaches the level set ON thermostat. Setting temperature is too low in heating mode and too high in cooling and dry mode.	Yes	Adjust setting temperature
			No	1-2
	1-2	Check if the sensors are connected correctly. Are all connection made properly? Room temp. (TA) in yellow, heat exchanger (E1) in red, heat exchanger (E2) in black, heat exchanger (E3) in brown, air outlet (BL) in green	Yes	Connect correctly
			No	1-3
	1-3	DISP (display mode) is applied.	Yes	Turn OFF(OPEN)
			No	1-4
	1-4	With a thermostat OFF in heating mode, wind speed (item code 05) is out of range 0 - 6. (Use Simple Setting Function on standard timer remote controller.)	Yes	Choose one of 0 to 6
			No	1-5
	1-5	DEMAND is applied.	Yes	Turn OFF(OPEN)
			No	2-1
2 Outdoor control PC board	2-1	Outdoor unit and protective function of a system are operating. (Connect outdoor maintenance remote controller to RC socket on outdoor unit main control PC board and check alarm messages.)	Yes	See operational status
			No	2-2
	2-2	Discharge temperature is over 80°C in stop mode and does not decrease. (Connect outdoor maintenance remote controller to RC socket on outdoor unit main control PC board and check alarm messages.)	Yes	Replace discharge temperature sensor
			No	2-3
	2-3	Demand value always stays low. (The value is lower than 70. Excluding -1 (unlimited))(Connect outdoor maintenance remote controller to RC socket on outdoor unit main control PC board and check alarm messages.)	Yes	Increase values (over 70)
			No	2-4
2-4	DEMAND is applied.	Yes	Turn OFF(OPEN)	
		No	3-1	
3 Control equipment	3-1	Demand setting is made by control units (P-AIMS, Seri-Para I/O unit for outdoor unit, Seri-Para I/O each indoor unit.)	Yes	Turn OFF
			No	4-1
4 System	4-1	When operating in cooling (including auto cooling & heating) and dry mode, lowest temp. of indoor E1, E2 and E3 sensor is less than 2°C (under anti-freeze control).	Yes	Wait until more than 2°C reaches
			No	4-2
	4-2	During defrosting operation	Yes	Wait for a few minutes to 10 minutes or so
			No	4-3
	4-3	Outdoor unit PC board failure → Replacement		

- According to a type of model, the indoor sensors will not be supplied in some cases.
- According to a type of model, the outdoor DEMAND will not be supplied in some cases.
- When LINE Checker is used, the temperature sensors can be observed (display, record) simultaneously.
- According to some areas, some of the models are unreleased.

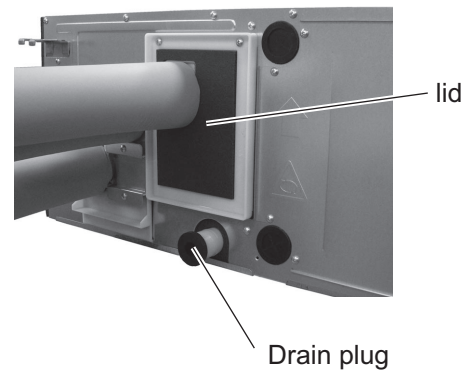
## 5-6. How to Clean Heat Exchanger

1. Turn off the power supply.

### WARNING

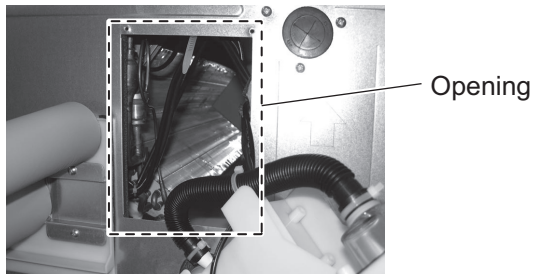


**ELECTRICAL SHOCK CAN CAUSE SEVERE PERSONAL INJURY OR DEATH.**

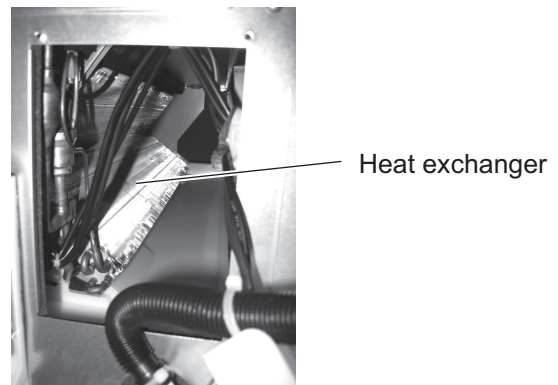


**Fig. 1**

2. Remove the lid (drain pump). (Fig. 1)
3. Remove the drain plug and drain the water from the drain pan. (Fig. 1)
4. Insert a high pressure cleaner from the opening (Fig. 2) and clean the heat exchanger. (Fig. 3)



**Fig. 2**



**Fig. 3**

5. When finished cleaning, install the drain plug and lid (drain pump).

## 5-7. How to Replace Fan Motor

### Type F1

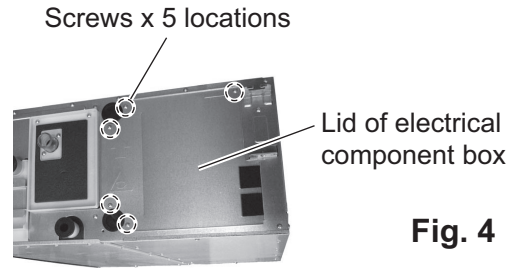
#### Removing Fan Motor

1. Turn off the power supply.

#### WARNING

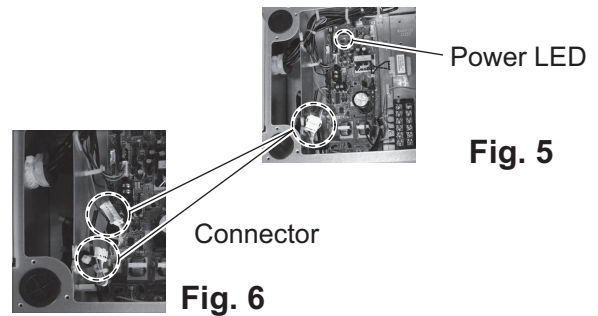


**ELECTRICAL SHOCK CAN CAUSE SEVERE PERSONAL INJURY OR DEATH.**



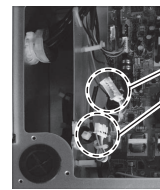
**Fig. 4**

2. Remove the lid of the electrical component box.  
(Screws x 5 locations: Fig. 4)  
Make sure the PC board should not be electrified.  
Power supply LED should be lit off on PC board.  
(Fig. 5)



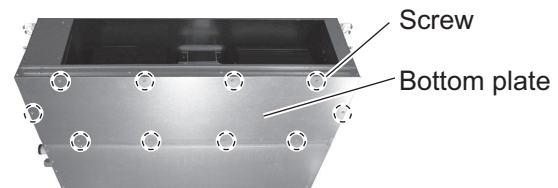
**Fig. 5**

3. Disconnect the interconnector in the middle of the wiring to the fan motor. (Fig. 6)



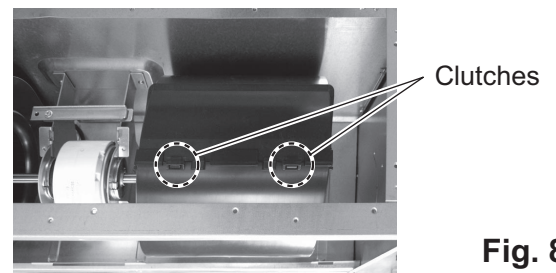
**Fig. 6**

4. Remove the bottom plate. (Fig. 7)

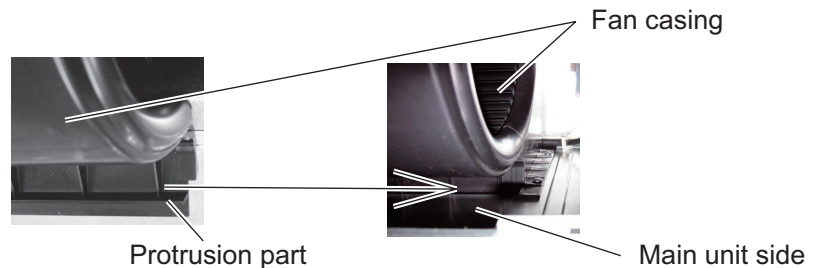


**Fig. 7**

5. Disconnect two (2) clutches (Fig. 8) fixing the lower side of the fan casing and pull out the protrusion part (Fig. 10) placed onto the side of the main unit (Fig. 9). Then remove the fan casing.



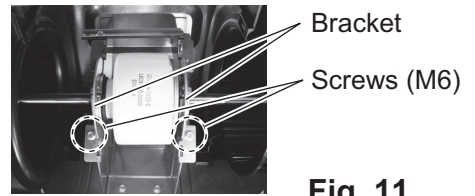
**Fig. 8**



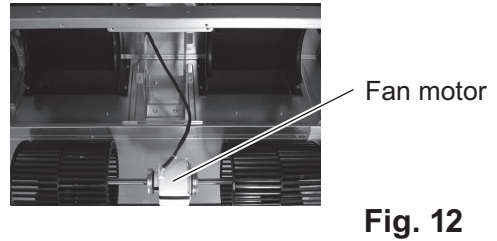
**Fig. 10**

**Fig. 9**

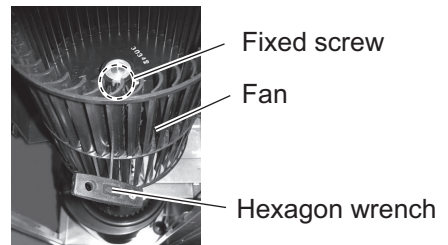
- Remove the screws (M6 x2 locations: Fig. 11) fixing the fan motor. It is recommended that a nutdriver (8mm) be used.



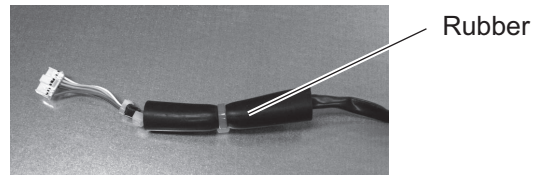
- Remove the bracket (Fig. 11) and then remove the fan and fan motor (Fig. 12).



- Loosen the fixed screw with a hexagon wrench (3mm, over 100mm in length) and remove the fan.



- Remove the rubber attached to the wiring of the fan motor (Fig. 14).



### Installing Fan Motor

- For installation, reverse the procedure above.
- Fine tune so that the fan can be positioned in the center of the fan casing.

Type K2

### Removing Fan Motor



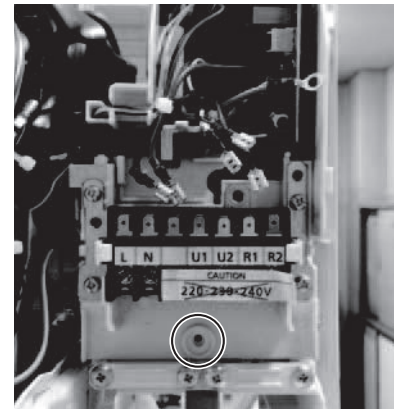
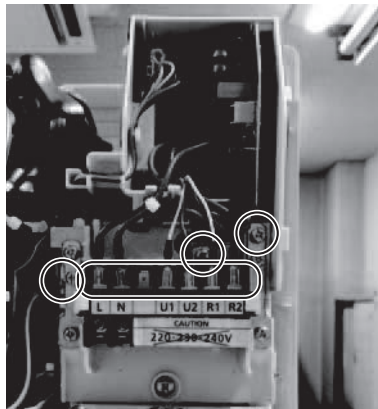
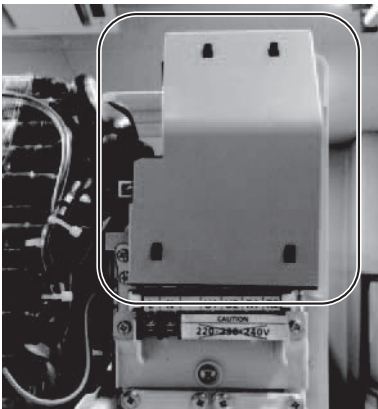
1. Remove 4 screws (4x16) and detach the front grille.

2. Remove the electrical cover.

3. Remove 3 fixing screws from the terminal and ground wires.

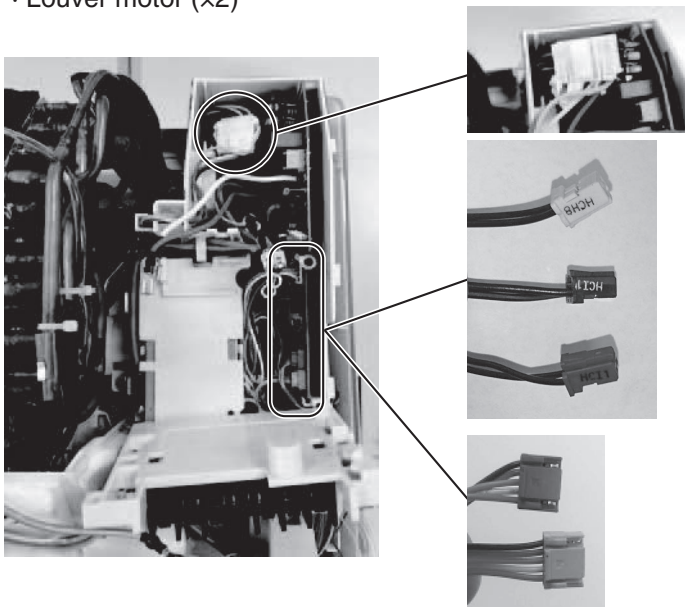
4. Remove 1 screw (4x10) and lift the terminal cover.

5

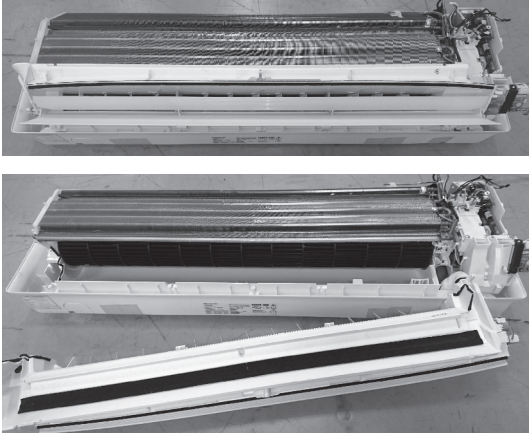


5. Remove the connector.

- Fan motor
- Thermistor (air intake, E1, E2)
- Louver motor (x2)

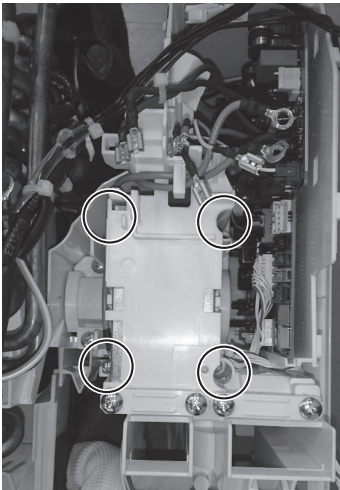


6. Remove the air discharge grille.

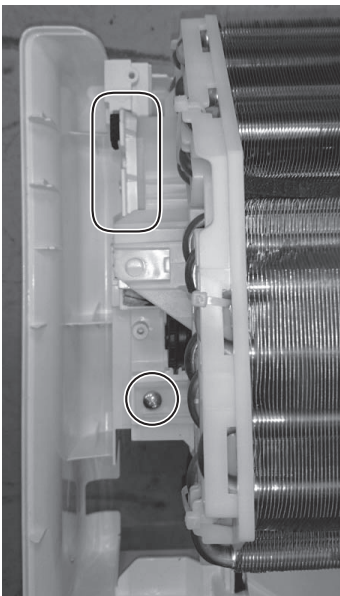


\* Photo shows the right-hand drain.

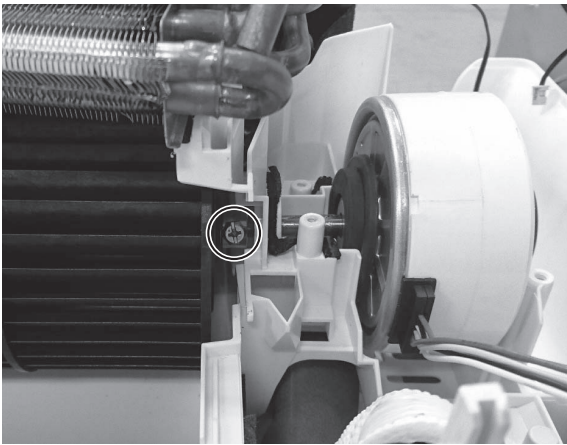
7. Remove 4 screws (4x16) and detach the electrical component box.



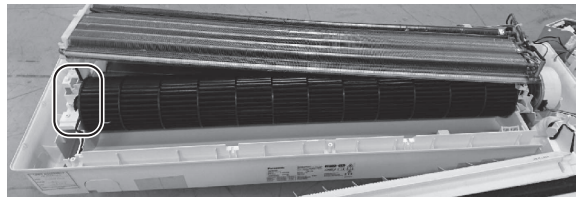
8. Remove 1 screw (4x12).  
Disengage the tabs and lift the heat exchanger.



9. Remove the fixing screw of the fan.



10. Disengage the fan shaft.

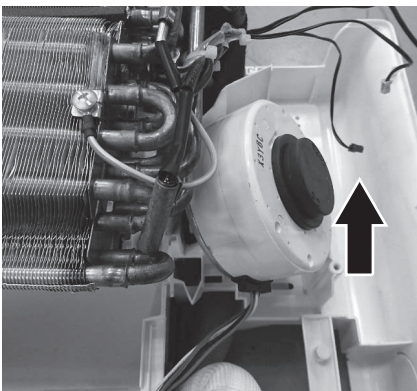


11. Pull the fan toward the front left side and remove it.

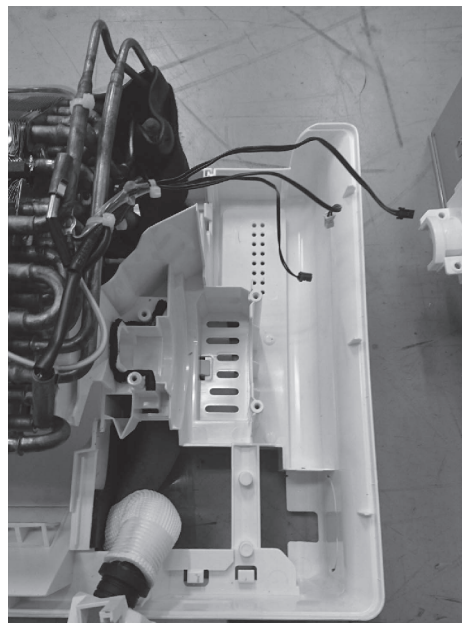


5

12. Lift the fan motor and remove it.



13. Uninstallation is completed.

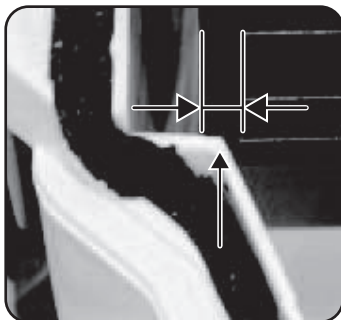
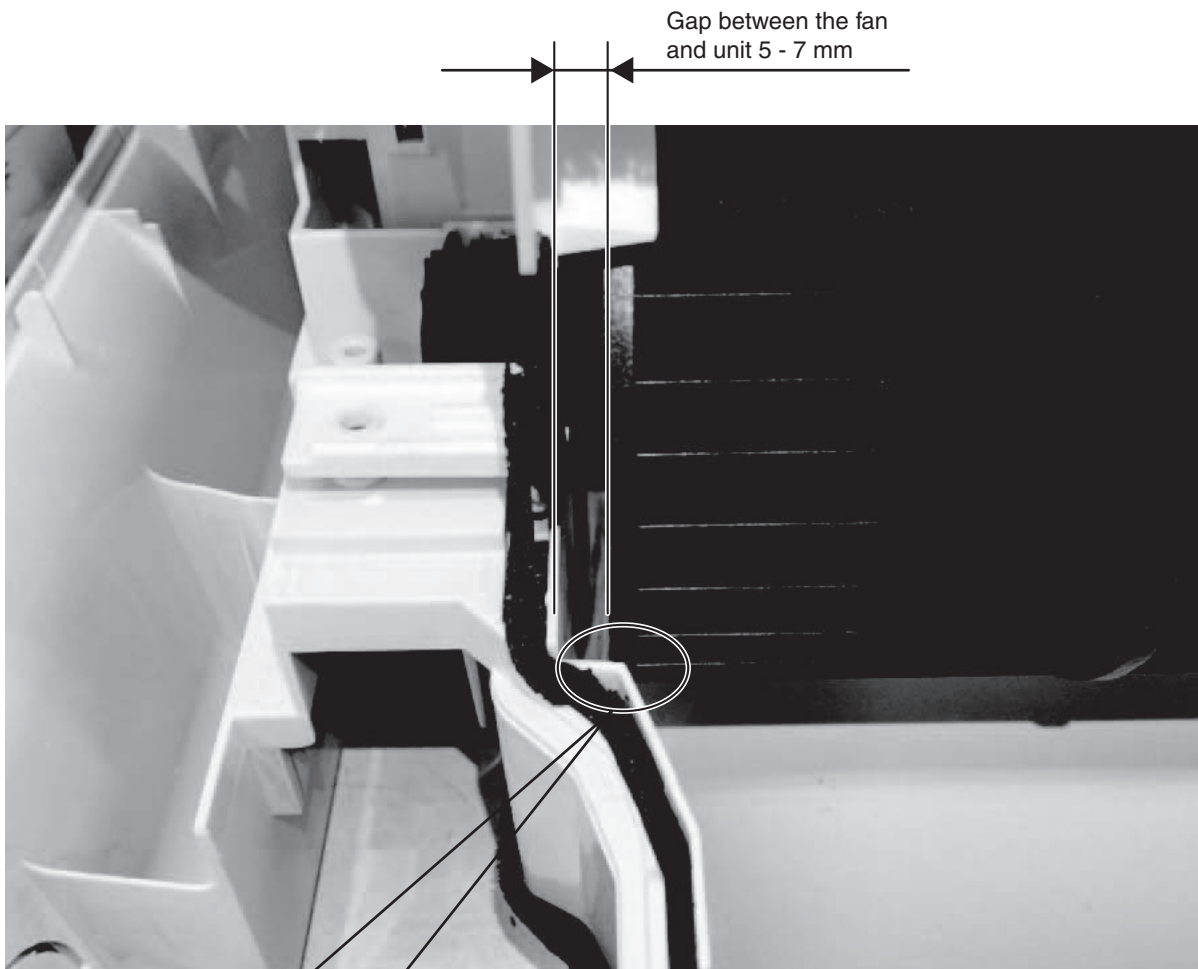




### Installing Fan Motor

Carry out installation in reverse order to assemble.

Fan installation should be made following the figure below while confirming the position.



Reference  
Fan plate and corner of the wall of unit should be in the same position.

**NOTE**

Noise or damage to the fan can be caused by misalignment of the motor due to its mounting position.

– MEMO –

## 6. OUTDOOR UNIT MAINTENANCE REMOTE CONTROLLER

6-1.	Overview .....	6-2
6-2.	Functions.....	6-2
6-3.	Normal Display Operations and Functions .....	6-3
6-4.	Monitoring Operations: Display of Indoor Unit and Outdoor Unit Sensor Temperatures .....	6-8
6-5.	Monitoring the Outdoor Unit Alarm History: Display of Outdoor Unit Alarm History .....	6-10
6-6.	Settings Modes: Setting the Outdoor Unit EEPROM.....	6-11

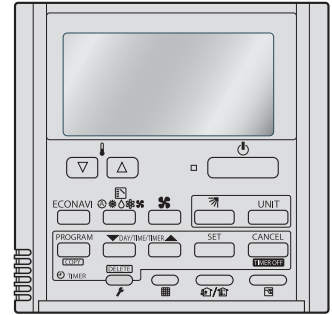
## 6-1. Overview

### What is the outdoor unit maintenance remote controller?

Beginning with the DC-INV series of outdoor units, nonvolatile memory (EEPROM) is used in the outdoor unit PCB. In this way, the setting switches that were located on earlier PCBs have been converted to EEPROM data. This remote controller is an outdoor unit maintenance tool that is used to make and change the EEPROM settings.

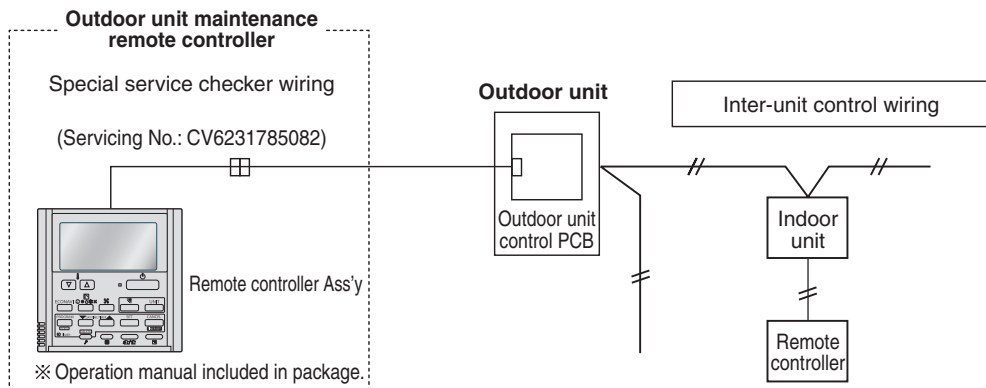
This remote controller can be used for checking the outdoor unit EEPROM settings and contents, and also can be used to monitor the outdoor unit alarm history and indoor/outdoor unit temperatures, and to check the status of the indoor unit connections (No. of units, operating status, etc.).

**Note:** Because this tool does not function as a remote controller, it is used only during test runs and servicing.



CZ-RTC4

### System diagram



- \* The special service checker wiring is required in order to connect the outdoor unit maintenance remote controller to the outdoor unit PCB.
- \* Even when the outdoor unit maintenance remote controller is connected, a separate remote controller or other control device must be connected to the indoor unit.

## 6-2. Functions

### ■ Normal display functions

(1) Functions: Button operations can be used to perform the following functions.

- Start/stop of all indoor units
- Switching between cooling and heating
- Test run of all indoor units
- High-speed operation of indoor units (Do not use with actual units. This may damage the devices.)

(2) Display: The following can be displayed.

- Alarm details display
- No. of indoor/outdoor units
- Unit Nos. of connected indoor/outdoor units
- Indoor/outdoor unit operating status (blinks when an alarm occurs)
- Indoor unit thermostat ON
- Individual display of outdoor unit alarms
- Outdoor unit compressor total operating time
- Outdoor unit total power ON time
- Outdoor unit microcomputer version
- Other

### ■ Temperature monitor

- Displays the indoor/outdoor unit sensor temperatures.

### ■ Outdoor unit alarm history monitor

- Displays the outdoor unit alarm history.

### ■ Setting modes

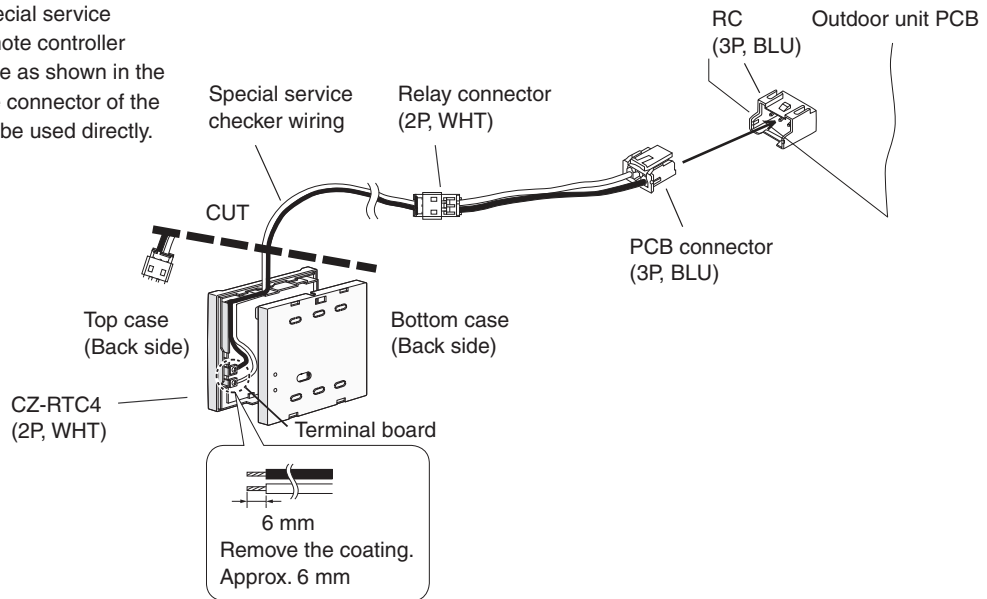
- Setting mode 1 and setting mode 2 are used to make the outdoor EEPROM setting.

## 6-3. Normal Display Operations and Functions

### ■ Normal display functions

- Connect the special service checker wiring to the outdoor unit PCB. The connection is shown in the figure below.


When connecting the special service checker wiring to the remote controller CZ-RTC4, cut out the wire as shown in the figure below because the connector of the remote controller cannot be used directly.



- \* It is not necessary to disconnect the communications line in the inter-unit control wiring if it has already been connected at this time.
- \* Setting modes 1 and 2 can be used even when the outdoor unit is independent (when 1 maintenance remote controller is connected to 1 outdoor unit and automatic address setting for the indoor units has not been completed).
- \* Displays the overall system status for that refrigerant system.
- \* “**SETTING**” is displayed until auto address setting is completed.

● All units start/stop (Fig. 6-1)

<Operation>

The  (Start/Stop operation) button can be used to start and stop all the indoor units.


- The LED illuminates if any indoor units is operating.
- The LED blinks if an alarm at any of the operating indoor units occurs.

● Cooling/heating change (Fig. 6-1)

**NOTE**

Cooling and heating mode changes are only available when all indoor units are stopped.


<Operation>

The  (Mode) button can be used to change between heating and cooling operation.

- The display indicates the operating mode of the indoor unit with the lowest unit No.

● All units test run (Fig. 6-2)

<Operation>


The  (Check) button can be used to start and stop a test run for all indoor units.


- Press and hold for 4 seconds to turn ON. During the test run “TEST” is displayed.
- The status of test runs performed from the indoor unit remote controller is not displayed on the outdoor unit maintenance remote controller.

● Double-speed (Fig. 6-3)

- Do not use for actual operation. (Doing so may damage the devices.)

<Operation>

The timer button  can be used to change between double-speed and normal operation.

- During double-speed operation, the Sleeping Mode  mark is displayed.

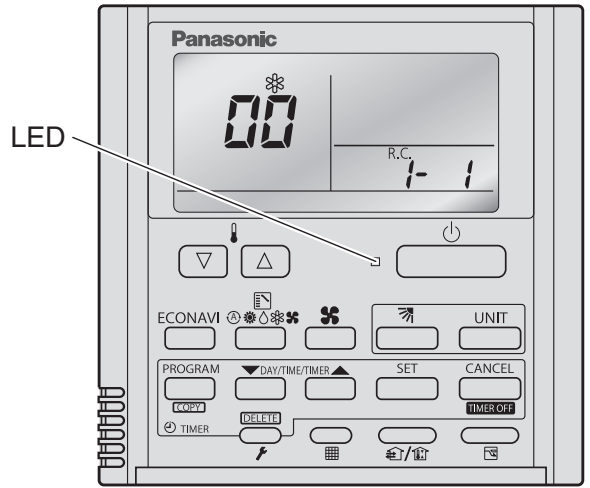


Fig. 6-1

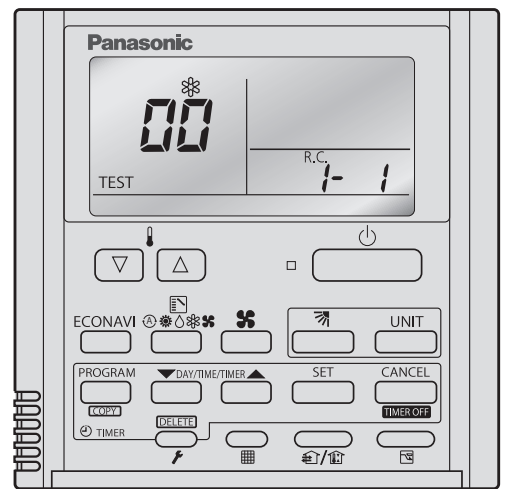


Fig. 6-2

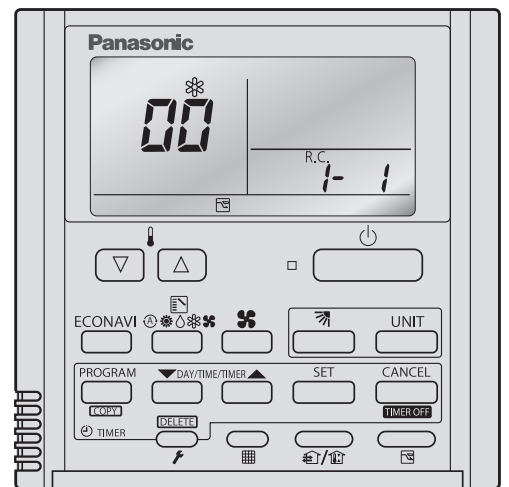


Fig. 6-3

■ **Display (functions)**

- Use the temperature setting  and  buttons to change the item code.

(1) Item code	(2) Display contents	Remarks
00	Outdoor unit contents (code) : OFF when normal Blinking 8 - alarm code display at pre-trip,LED	At initial status
01	No. of indoor units connected in that refrigerant system	
02	Unit Nos. of connected indoor units in that refrigerant system	
03	Operating status of indoor units in that refrigerant system (blinks when alarms occur)	
04	Unit Nos. of indoor units in that refrigerant system where the thermostats are ON	
05	No. of outdoor units connected in that refrigerant system	No. of connected units :1
06	Unit Nos. of connected outdoor units in that refrigerant system	
07	Operating status of outdoor units in that refrigerant system (blinks when alarms occur)	
08		
09		
0A		
0b		
0C		
0d		
0E		
0F		
10	Total compressor operating time (in 1-hour. units)	
11		
12		
13		
14		
15		
16	Total power ON time of outdoor unit (in 1-hour. units)	
17	Compressor start count	
18		
19		
FE	Outdoor unit microcomputer firmware version	
FF	Outdoor unit microcomputer software version	

(1) and (2) correspond to Fig. 6-4 on the next page.

(3) XX-YY R.C.

Displays the outdoor unit sub-bus address which is currently selected.

XX = Outdoor system address on main bus line (1 – 30)

YY = Outdoor unit sub-bus address (1 – 8)

“1” appears when there is only 1 outdoor unit.

Locations where (1), (2), and (3) are displayed as shown in Fig. 6-4.

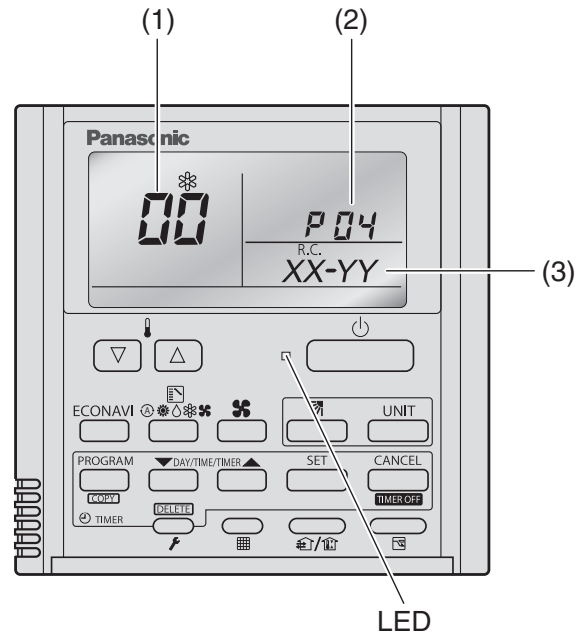
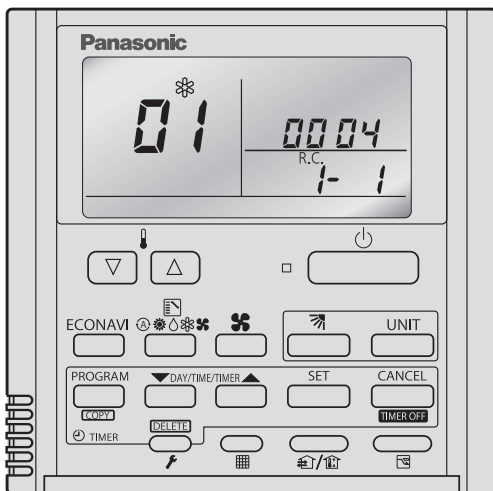
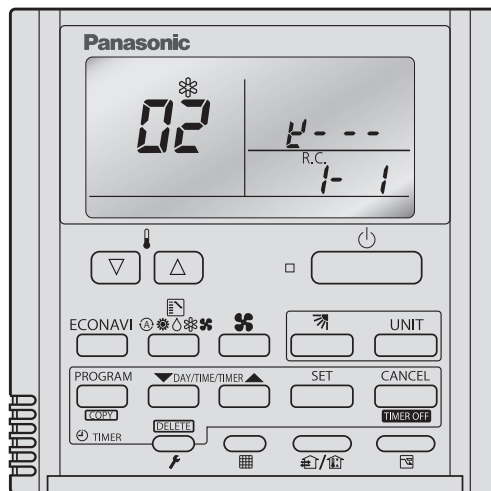


Fig. 6-4

<Sample displays>



01: <No. of connected indoor units>  
4 units connected



02: <Unit Nos. 1, 2, 3, and 4 are connected>

Fig. 6-5

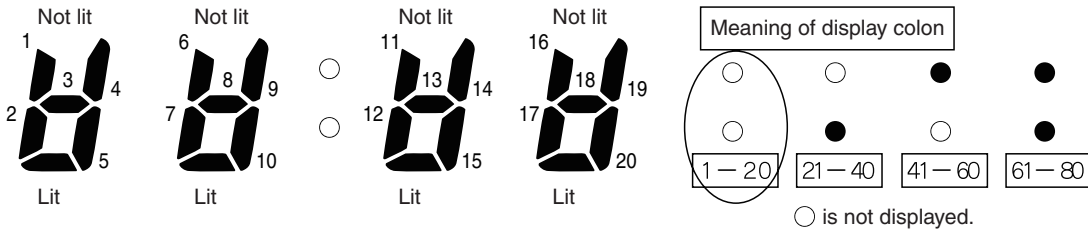
Fig. 6-6



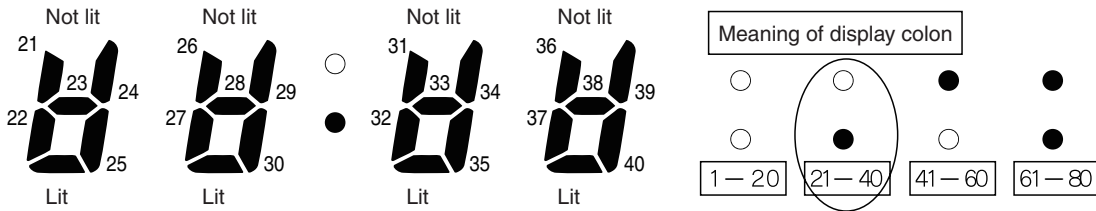
■ 7-segment, 4-digit display for remote controller timer display

The connected unit Nos. are displayed as shown below, using the 7-segment 4-digit (00:00) display and the colon.

● Display for unit Nos. 1 – 20

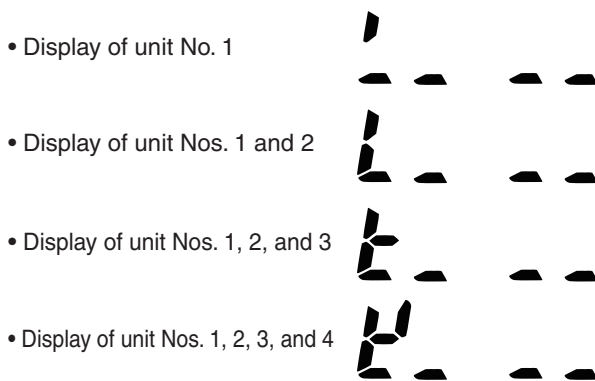


● Display for unit Nos. 21 – 40



● The meaning of the colon display changes in the same way, allowing unit Nos. up to 80 to be displayed.

● Sample displays of the unit Nos. of connected indoor units

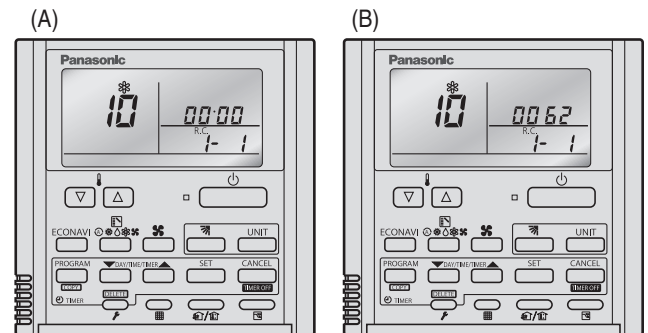


**NOTE**

The change of the colon display (between unit Nos. 1-20 to unit Nos. 21-40) occurs automatically every 10 seconds. (However the display does not change if there are no higher-number units connected.) To change the display to the higher-number units before 10 seconds have passed, press the (Flap) button.

■ The total compressor operating time is displayed (in 1-hour units) using 8 digits.

- When the first 4 digits are displayed, the top dot of the colon is illuminated. (Figure (A))
- When the last 4 digits are displayed, the colon dot is OFF. (Figure (B))
- The display of the first 4 digits and last 4 digits changes automatically after 10 seconds. The display can also be changed by pressing the (Flap) button.





10: <Compressor's total operating time>  
 (A) and (B) are displayed alternately.  
 (The example here (0000, 0062) indicates 62 hours.)

**NOTE**

With the outdoor unit maintenance remote controller (when connected to the outdoor unit), the unit remote controller check functions will not operate.


## 6-4. Monitoring Operations: Display of Indoor Unit and Outdoor Unit Sensor Temperatures



<Operating procedure>

- (1) Press and hold the  (Check) button and  buttons simultaneously for 4 seconds or longer to engage temperature monitor mode.


During temperature monitoring,  is illuminated.

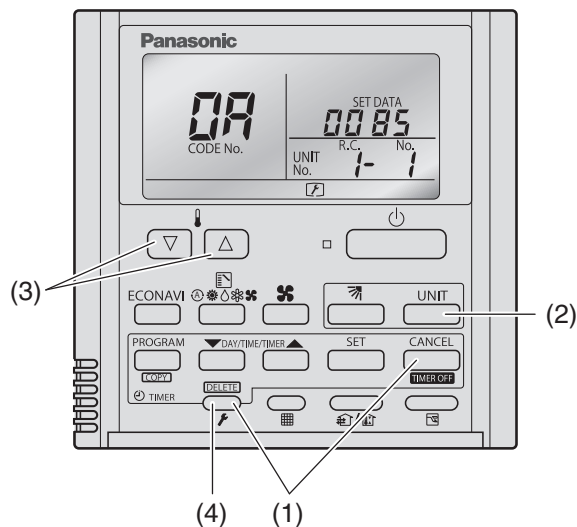
(The display and operations are the same as for monitor mode using the indoor unit remote controller.)

- (2) Press the  button and select the indoor unit to monitor.

- (3) Press the temperature setting  and  buttons and select the item code of the temperature to monitor.

The unit No. of the selected indoor unit, and the temperature data, are displayed.

- (4) To end monitoring, press the  (Check) button. The display returns to the normal display.



**NOTE** The display does not blink.

\* The display does not blink.

	Item code	Meaning of Code
Indoor unit data	02	Indoor unit intake temp.
	03	Indoor unit heat exchanger temp. (E1)
	04	Indoor unit heat exchanger temp. (E2)
	05	–
	06	–
	07	–
	08	–
	09	
Outdoor unit data	0A	Discharge temp. (TD)
	0b	–
	0C	–
	0d	Intake temp. (TS)
	0E	Outdoor unit heat exchanger temp. (C1)
	0F	Outdoor unit heat exchanger temp. (C2)
	10	–
	11	Outdoor air temp. ( TO )
	12	–
	13	Current value (CTL2)
	14	Current value (CTL1)
	15	Outdoor MV value (MOV1)
	16	–
	19	Frequency



\* Depending on the model, some items may not be displayed.


## 6-5. Monitoring the Outdoor Unit Alarm History: Display of Outdoor Unit Alarm History

\* Displays outdoor unit alarms only. Does not display indoor unit alarms.




\* Check the indoor unit alarm histories separately using the indoor unit remote controllers or other control device.

### <Operating procedure>

- (1) Press and hold the  (Check) button and  button simultaneously for 4 seconds or longer to engage outdoor unit alarm history mode.

During temperature monitoring,  illuminates.

The display and operations are the same as for the alarm history monitor performed from the indoor unit remote controller. However the "UNIT No." display shows the outdoor unit address.

- (2) Press the  button and select the outdoor unit for which to monitor the alarm history.
- (3) Press the temperature setting  and  buttons and select the item code for the alarm history.

The select outdoor unit address, the item code, and the alarm history (alarm data) are displayed.

The outdoor unit address is displayed as R.C. XX-YY.



System XX = Outdoor unit system address

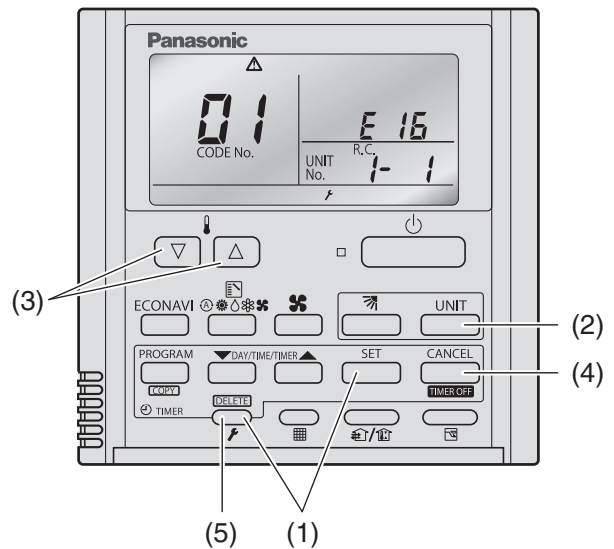
R.C. XX = Outdoor unit system address

YY = Outdoor unit sub-bus address

Item codes 01-08 are displayed. 01 indicates the most recent alarm.

The alarm history displays the alarm code. (If no alarm are present, then -- -- is displayed.)







- (4) To clear the alarm history, press the  button. (The outdoor unit alarm history will be cleared.)
- (5) To exit, press the  (Check) button. The display returns to the normal display.




## 6-6. Settings Modes: Setting the Outdoor Unit EEPROM

### ● Setting mode 1

<Operating procedure>

- (1) Press and hold the  (Check) button and  (Ventilation) button simultaneously for 4 seconds or longer.
- (2) Press the temperature setting  and  buttons to change the item code. The item codes and setting data are shown in the table below.
- (3) Press the timer time  and  buttons to change the setting data.


To confirm the changed setting data, press the  button.

(At this time, “SETTING” display stops blinking and remains lit.)

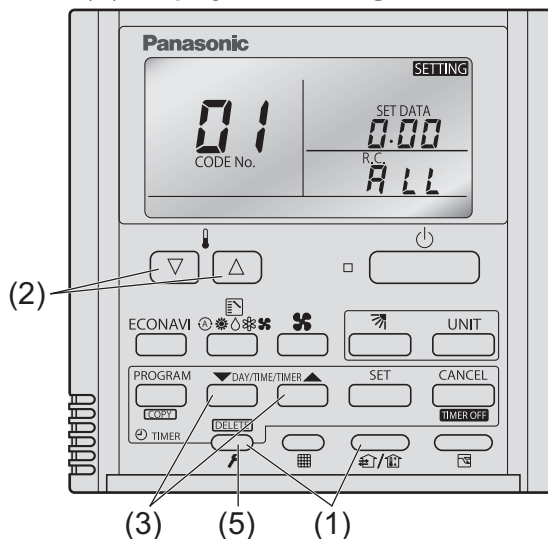
- (4) During this mode, “SETTING” is displayed, blinking. The outdoor unit address display section displays “ALL,” the item code and number (DN value in the table), and the setting data (6 digits).

(The setting data is displayed in 6 digits. The display changes between the first 3 digits (Fig. (C)). and the last 3 digits (Fig. (D)).

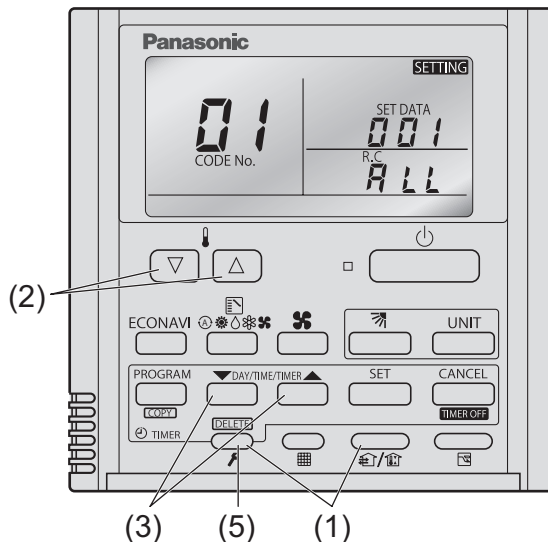
(When the first 3 digits are displayed, the bottom dot of the colon is illuminated.)

- (5) To exit the setting mode, press the  (Check) button.

(C) Display of first 3 digits



(D) Display of last 3 digits



(C) and (D) are displayed alternately.  
(Example shows display of 000 001.)

**List of Item Codes (Some item codes cannot be set due to the type of models.)**

Item code	Parameter	
07	Ignore capacity	0 = Disabled 1 = Ignores capacity ratio
0C	Indoor unit drain pump forced operation	0 = Invalid 1 = stop for 2 hours and drive for 20 minutes constantly 2 = stop for 20 minutes and drive for 20 minutes constantly 3 = Drive constantly 4 = When indoor unit thermostat On changed to thermostat Off (including stop mode), forced operation is activated for xx minutes (setting: 2b). 5 = Movement object: When indoor unit operation mode (regardless of thermostat On and Off) changed to stop mode, forced operation is activated for xx minutes (setting: 2b). 6 = Operates the contents of No.4 and No.5. 7 = Operates the content of No. 5 limited to cooling and dry mode (at shipment).
0E	Cooling only	0 = Heat pump 1 = Cooling only
12	Silent mode	0 = Normal (at shipment) 1 = Auto silent 2 = Capacity priority
13	Silent mode starting time (hour)	22 = 22 o'clock (at shipment)
14	Silent mode starting time (minute)	00 = 00 minute (at shipment)
15	Silent mode finishing time (hour)	08 = 8 o'clock (at shipment)
16	Silent mode finishing time (minute)	00 = 00 minute (at shipment)
1A	Demand 1	70% ~ 100% (40% ~ 130% setting capable) (at shipment 100%)
1b	Demand 2	70% ~ 100% (40% ~ 130% setting capable) (at shipment 70%)
1d	Current control level	70% ~ 100% (40% ~ 130% setting capable), -1 (No control) (at shipment)
2b	DP operation time for slime measures	20 = 20 minutes 30 = 30 minutes (at shipment) 40 = 40 minutes 50 = 50 minutes 60 = 60 minutes
80	Refrigerant type	407 = R407C 22 = R22 410 = R410A 32 = R32
81	Outdoor unit capacity*	0 = Disabled 112 = Type 100 140 = Type 125 160 = Type 140

\* Figures in parentheses indicate the data at the time of shipment from the factory.

## 7. REMOTE CONTROLLER FUNCTIONS SECTION










7-1.	Simple Settings Function .....	7-2
7-2.	List of Simple Setting Items .....	7-4
7-3.	Detailed Settings Function .....	7-5
7-4.	List of Detailed Setting Items .....	7-7
7-5.	Simple Setting Items .....	7-11
7-6.	Detailed Setting Items .....	7-13
7-7.	Remote Controller Servicing Functions.....	7-17
7-8.	Test Run Function .....	7-19

## 7-1. Simple Settings Function

- This allows the filter lifetime, operating mode priority change, central control address, and other settings to be made for an individual or group-control indoor unit to which the remote controller used for simple settings is connected.

When simple settings mode is engaged, operation stops at the individual or group-control indoor unit to which the remote controller for simple settings is connected.

### <Procedure of CZ-RTC4>

- Press and hold the  and  buttons simultaneously for 4 seconds or longer.
- "SETTING", unit No. "1-1" (or "ALL" in the case of group control), item code "01," and settings data "00XX" are displayed blinking on the remote controller LCD display (Fig. 7-1). At this time, the indoor unit fan (or all indoor unit fans in the case of group control) begins operating.
- If group control is in effect, press the  button and select the address (unit No.) of the indoor unit to set. At this time, the fan at the indoor unit begins operating.  
\*If unit No. "ALL" is displayed, the same setting will be made for all indoor units.
- Press the temperature setting  /  buttons to select the item code to change.
- Press the timer time  /  buttons to select the desired setting data.  
\*For item codes and setting data, refer to the following page.
- Press the  button. (The display stops blinking and remains lit, and setting is completed.)
- Press the  button to return to normal remote controller display.

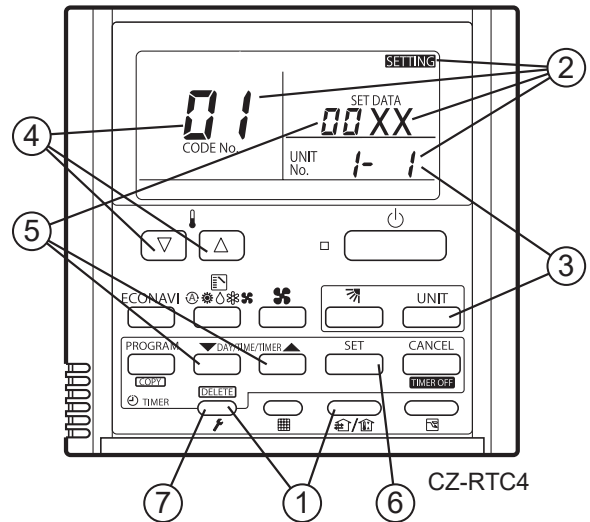


Fig. 7-1



<Procedure of CZ-RTC5A / CZ-RTC5B>



CZ-RTC5A / CZ-RTC5B

Fig. 7-2

- ① Keep pressing the , and buttons simultaneously for 4 or more seconds. The “Maintenance func” screen appears on the LCD display.

Maintenance func		20:30 (THU)
1. Outdoor unit error data		
2. Service contact		
3. RC setting mode		
4. Test run		
▼ Sel.	▶ Page [←]	Confirm

- ② Press the or button to see each menu. If you wish to see the next screen instantly, press the or button. Select “7. Simple settings” on the LCD display and press the button.

Maintenance func		20:30 (THU)
5. Sensor info.		
6. Servicing check		
7. Simple settings		
8. Detailed settings		
↕ Sel.	◀ ▶ Page [←]	Confirm

The “Simple settings” screen appears on the LCD display.

Select the “Unit no.” by pressing the or button for changes.

Simple settings		20:30 (THU)
Unit no.	Code no.	Set data
3-1	01	0001
↕ Sel.	▶ Next	

- ③ Select the “Code no.” by pressing the or button. Change the “Code no.” by pressing the or button.

Simple settings		20:30 (THU)
Unit no.	Code no.	Set data
3-1	01	0001
↕ Sel.	▶ Next	

- ④ Select the “Set data” by pressing the or button. Select one of the “Set data” by pressing the or button. Then press the button.

Detailed settings		20:30 (THU)
Unit no.	Code no.	Set data
3-1	10	0001
↕ Sel.	[←] Confirm	

- ⑤ Select the “Unit no.” by pressing the or button and press the button. The “Exit simple settings and restart?” (Simple setting-end) screen appears on the LCD display. Select “YES” and press the button.

Exit simple settings and restart?		20:30 (THU)
YES	▶	NO
↕ Sel.	▶ Next	

## 7-2. List of Simple Setting Items

Item code	Item	Setting data		
		No.	Description	
01	Filter sign ON time (filter life time)	0000	Not displayed	
		0001	150 hours	
		0002	2,500 hours	
		0003	5,000 hours	
		0004	10,000 hours	
		0005	Use the filter clogging sensor.	
02	Degree of filter fouling	0000	Standard (setting at time of shipping)	
		0001	Highly fouled (Filter sign ON time is reduced to one-half the set time.)	
03	Central control address	0001	Central control address 1	
		0002	Central control address 2	
		0003	Central control address 3	
		}	}	
		0064	Central control address 64	
		0099	No central control address set (setting at time of shipping)	
04	Operating mode priority change	0000	Normal ( setting at time of shipping)	
		0001	Priority	
05	Fan speed when heating thermostat is OFF		Compressor ON	Compressor OFF
		0000	Lo 1 min., LL 3 min.	LL
		0001	Lo	LL
		0002	LL	LL
		0004	Lo 1 min., LL 3 min. Lo	Lo
		0005	Lo	Lo
		0006	LL	Lo
06	Heating intake temperature shift	0000	No shift	
		0001	Shifts intake temperature 1 °C down.	
		0002	Shifts intake temperature 2 °C down.	
		0003	Shifts intake temperature 3 °C down.	
		0004	Shifts intake temperature 4 °C down.	
		0005	Shifts intake temperature 5 °C down.	
		0006	Shifts intake temperature 6 °C down.	
07	Electric heater installation	0000	No heater	
		0001	Heater installed	
08	Humidifying when heater thermostat is OFF	0000	No (setting at time of shipping)	
		0001	Yes	
0d	Permit/prohibit automatic heating/cooling	0000	Permit	
		0001	Prohibit	
0F	Cool-only	0000	Normal	
		0001	Cool only (Set "1" for item code OD.)	

### NOTE









- In order to avoid water leakage and damage to the fan, do not set for humidifying when the thermostat is OFF unless a vaporizing humidifier is used.
- Consider the device purpose and type when changing the settings. Incorrect settings may result in malfunction.
- Do not change any setting data that does not appear in this list.

### 7-3. Detailed Settings Function



- This allows the system address, indoor unit address, and other settings to be made for the individual or group-control indoor unit to which the remote controller used for detailed settings is connected.

When detailed settings mode is engaged, operation stops at the individual or group-control indoor unit where the remote controller used for detailed settings is connected. Simple settings items can also be set at this time.

#### <Procedure of CZ-RTC4>

- Press and hold the ,  and  buttons simultaneously for 4 seconds or longer.
- "SETTING", unit No. "1-1" (or "ALL" in the case of group control), item code "10," and settings data "00XX" are displayed blinking on the remote controller LCD display (Fig. 7-3). At this time, the indoor unit fan (or all indoor unit fans in the case of group control) begins operating.
- If group control is in effect, press the  button and select the address (unit No.) of the indoor unit to set. At this time, the fan at the indoor unit begins operating.
- Press the temperature setting  /  buttons to select the item code to change.
- Press the timer time  /  buttons to select the desired setting data.

\*For item codes and setting data, refer to the following page.

- Press the  button. (The display stops blinking and remains lit, and setting is completed.)
- Press the  button to return to normal remote controller display.

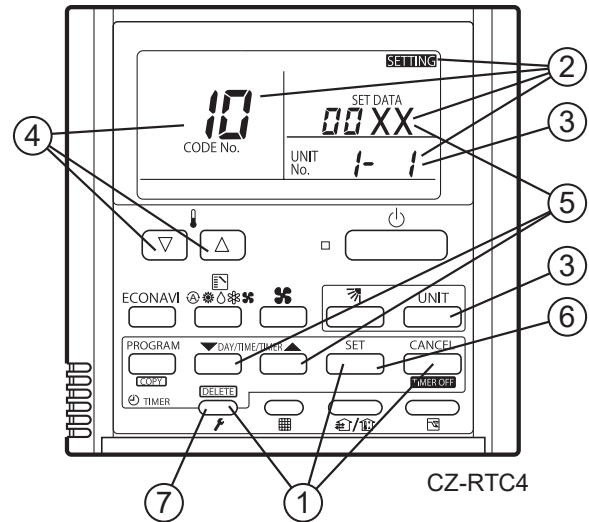


Fig. 7-3

<Procedure of CZ-RTC5A / CZ-RTC5B>



CZ-RTC5A / CZ-RTC5B

Fig. 7-4

- ① Keep pressing the , and buttons simultaneously for 4 or more seconds. The “Maintenance func” screen appears on the LCD display.

Maintenance func	20:30 (THU)
1. Outdoor unit error data	
2. Service contact	
3. RC setting mode	
4. Test run	
▼ Sel.	▶ Page [] Confirm

- ② Press the or button to see each menu. If you wish to see the next screen instantly, press the or button. Select “8. Detailed settings” on the LCD display and press the button.

Maintenance func	20:30 (THU)
5. Sensor info.	
6. Servicing check	
7. Simple settings	
8. Detailed settings	
↕ Sel.	◀ ▶ Page [] Confirm

The “Detailed settings” screen appears on the LCD display.

Select the “Unit no.” by pressing the or button for changes.

Detailed settings		20:30 (THU)
Unit no.	Code no.	Set data
3-1	10	0001
↕ Sel.	▶ Next	

- ③ Select the “Code no.” by pressing the or button. Change the “Code no.” by pressing the or button (or keeping it pressed).

Detailed settings		20:30 (THU)
Unit no.	Code no.	Set data
3-1	10	0001
↕ Sel.	▶ Next	

- ④ Select the “Set data” by pressing the or button. Select one of the “Set data” by pressing the or button. Then press the button.

Detailed settings		20:30 (THU)
Unit no.	Code no.	Set data
3-1	10	0001
↕ Sel.	[] Confirm	

- ⑤ Select the “Unit no.” by pressing the or button and press the button. The “Exit detailed settings and restart?” (Detailed setting-end) screen appears on the LCD display. Select “YES” and press the button.

Detailed settings		20:30 (THU)
Exit detailed settings and restart?		
YES ▶ NO		
↕ Sel.	▶ Next	

#### 7-4. List of Detailed Setting Items

Item code	Item	Setting data			
		No.	Description	No.	Description
10	Type	0001	4-Way Cassette (U2)	0005	Low Silhouette Ducted (F1)
		0007	Ceiling (T2)	0008	Wall Mounted (K2)
11	Indoor unit capacity	0009	56(Type 50)	0011	71 (Type 60)
		0012	80 (Type 71)	0015	112 (Type 100)
		0017	140 (Type 125)	0018	160 (Type 140)
12	System address	0001	Unit No. 1		
		0002	Unit No. 2		
		0003	Unit No. 3		
		}	}		
		0030	Unit No. 30		
		0099	Not set		
13	Indoor unit address	0001	Unit No. 1		
		0002	Unit No. 2		
		0003	Unit No. 3		
		}	}		
		0064	Unit No. 64		
		0099	Not set		
14	Group control address	0000	Individual (1:1 = Indoor unit with no group wiring)		
		0001	Main unit (One of the group-control indoor units)		
		0002	Sub unit (All group-control indoor units except for main unit)		
		0099	Not set		
17	Cooling intake temperature shift	-010	Shifts intake temperature 10°C down.		
		-009	Shifts intake temperature 9°C down.		
		}	}		
		-001	Shifts intake temperature 1°C down.		
		0000	No intake temperature shift		
		0001	Shifts intake temperature 1°C up.		
		}	}		
		0009	Shifts intake temperature 9°C up.		
0010	Shifts intake temperature 10°C up.				
18	Automatic stop time after operation start  * Can be set in 5-minute units.	0000	Function disabled		
		0001	Stops automatically 5 minutes after operation starts.		
		0002	Stops automatically 10 minutes after operation starts.		
		}	}		
		0123	Stops automatically 615 minutes after operation starts.		
		0124	Stops automatically 620 minutes after operation starts.		
		0125	Stops automatically 625 minutes after operation starts.		

Item code	Item	Setting data		
		No.	Description	
<b>1b</b> (1B)	Forced thermostat ON time	0000	5 minutes	
		0001	4 minutes	
<b>1E</b>	Temperature shift for cooling/heating change in auto heat/cool mode	0001	± 1°C	
		0002	± 2°C	
		0003	± 3°C	
		{	}	
		0007	± 7°C	
<b>1F</b> (Upper limit) <b>20</b> (Lower limit)	Change to remote control temperature setting range	Cooling	0018	18°C (Lower limit at shipment)
			0019	19°C
			}	}
			0029	29°C
<b>21</b> (Upper limit) <b>22</b> (Lower limit)		Heating	0016	16°C (Lower limit at shipment)
			0017	17°C
			}	}
			0029	29°C
<b>23</b> (Upper limit) <b>24</b> (Lower limit)		Drying	0018	18°C (Lower limit at shipment)
			0019	19°C
			}	}
			0029	29°C
<b>25</b> (Upper limit) <b>26</b> (Lower limit)	Auto heat/cool	0017	17°C (Lower limit at shipment)	
		0018	18°C	
		}	}	
		0026	26°C	
<b>29</b>	Humidifier operation	0000	Normal	
		0001	Ignore heat exchanger temperature conditions.	
<b>2A</b>	Filter (CN70) input switching	0000	Filter input (differential pressure switch input)	
		0001	Alarm input (for trouble input about air cleaner or similar device)	
		0002	Humidifier input (Operates linked with drain pump when humidifier is ON.)	
<b>2C</b>	Indoor unit electronic control valve	0000	None	
		0002	Present (Setting at shipment)	
<b>2E</b>	T10 terminal switching	0000	Normal (Used as optional relay PCB or JEMA standard HA terminal.)	
		0001	Used for OFF reminder	
		0002	Fire prevention input	

Item code	Item	Setting data	
		No.	Description
2F	Automatic drain pump operation	0000	No forced operation
		0001	Forced operation for 1 minute
		}	}
		0060	Continuous operation
31	Ventilation fan operation	0000	None
		0001	Ventilation fan operated by remote controller.
32	Wired remote controller sensor	0000	Not used. (Body sensor is used.)
		0001	Remote control sensor is used.
34	"Operation change control in progress" display	0000	Normal (displayed)
		0001	Not displayed
35	OFF reminder function for when weekly timer is used	0000	None
		0001	Only stop time setting is enabled.
3E	Heat exchanger temperature for cold air discharge (Heat exchanger control point for control to prevent cold air)	0013	Control temperature 13°C
		0014	Control temperature 14°C
		}	}
		0025	Control temperature 25°C
3d	Fan output switching	0000	Output linked with fan. (ON when indoor unit fan is operating.)
		0001	Fan mode operation output
3E	Drain pump delayed stop time	0000	No delayed stop
		0001	1 minute delayed stop
		0002	2 minutes delayed stop
		}	}
		0058	58 minutes delayed stop
		0059	59 minutes delayed stop
		0060	60 minutes delayed stop
40	Humidifier setting	0000	Humidifier output OFF. Drain pump stopped.
		0001	Humidifier output ON. Drain pump operates.
		0002	Humidifier output ON. Drain pump operates for 1 minute when total humidifier operating time reaches 60 minutes.
		0003	Humidifier output ON. Drain pump stopped.
45	Flap operation mode	0000	Standard setting
		0001	Draft reduction mode (Flap lower-limit position is shifted upwards.)
46	Flap swing mode	0000	Smudging reduction mode (Flap swing upper-limit position is shifted downwards.)
		0001	Normal mode
		0002	Draft reduction mode (Flap swing lower-limit position is shifted upwards.)

Item code	Item	Setting data	
		No.	Description
5d	Fan tap setting (Fan tap change in order to prevent drop in air discharge caused by filter installation)		Purpose
		0000	Standard (factory setting)
		0001	High ceiling setting 1 (U2, T2)
			Air-flow blocking kit (when a duct is connected : U2)
			Air-flow blocking kit (for 3-way air flow : U2)
		0003	High ceiling setting 2 (U2)
0006	Air-flow blocking kit (for 2-way air flow : U2)		
5E	Humidifier ON time (ON time per 60 seconds)	0000	No humidifier output
		0001	1 second
		0002	2 seconds
		{	}
		0058	58 seconds
		0059	59 seconds
		0060	Continuously ON
60	Timer function change prohibit	0000	Function disabled
		0001	Function enabled
62	Smudging control	0000	No smudging control
FC	Refrigerant adaptability	0000	None
		0001	Standard (factory setting)



## 7-5. Simple Setting Items

Item code	Item	Description
01	Filter sign ON time (filter life time)	Changes the indoor unit filter lifetime when a high-performance filter or other optional product is installed.
02	Degree of filter fouling	Reduces the filter sign ON time to 1/2 of the standard time (setting at the time of shipping) for cases when filter fouling is more severe than normal.

### Filter sign ON times for each model

Item code 10 Model data	Model	Filter sign ON time			
		Standard		Long-life	
		Standard	High fouling	Standard	High fouling
0001	4-Way Cassette (U2)	x	x	2500	1250
0007	Ceiling (T2)	x	x	1500	750
0008	Wall Mounted (K2)	150	75	x	x

#### NOTE

- x indicates that there is no corresponding filter.
- **150** indicates the filter sign ON time that is set at shipment.
- High fouling: Set when **0001** is selected for the degree of filter fouling (item code **02**).

Item code	Item	Description
03	Central control address	Set when using a central control device. Used when setting the central control address manually from the remote controller.
04	Operating mode priority change	Note (1)

#### NOTE

There are other methods to avoid control in which the mode selected first takes priority.

Methods of remotely controlling the operating mode

- (1) Use the central functions of a central control device.
- (2) Use a remote control relay PCB at the outdoor unit.

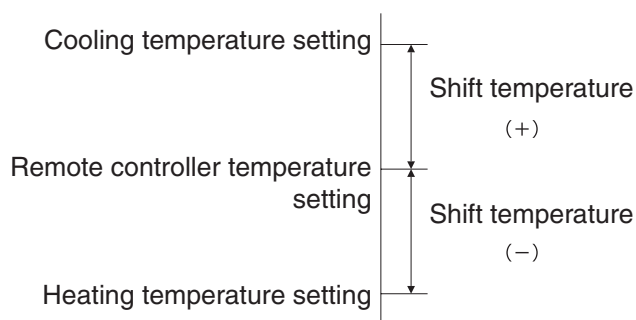
When the operating mode at the priority remote controller is changed, the operating modes of other remote controllers change as shown below.

Mode change at priority remote controller		Operating modes at other remote controllers	
Current mode	New mode	Current mode	New mode
Cooling or dry	Heating	Cooling or dry	Heating
		Fan	Fan (not changed)
Heating	Cooling	Heating	Cooling
		Fan	Fan (not changed)
Cooling	Dry	Cooling	Cooling (not changed)
		Dry	Dry (not changed)
Heating	Dry	Heating	Cooling
		Fan	Fan (not changed)
Cooling or dry	Fan	Cooling	Cooling (not changed)
		Dry	Dry (not changed)
		Fan	Fan (not changed)
Heating	Fan	Heating	Heating (not changed)
		Fan	Fan (not changed)

Item code	Item	Description
05	Fan speed setting when heating thermostat is OFF	Changes the fan speed setting when the heating thermostat is OFF.
06	Heating intake temperature shift	Shifts the intake temperature during heating. Can be set when the body thermostat is used.
07	Electric heater installation	Set when cost distribution is performed using an AMY central control system or similar system, and when an optional electric heater is installed. (This is unrelated to control of the electric heater.)
08	Humidifying when heater thermostat is OFF	Normally humidifying does not occur when the thermostat is OFF during heating operation. However, this setting can be changed in order to increase the amount of humidifying. Caution: In order to avoid water leakage and damage to the fan, do not use this setting unless a vaporizing humidifier is used.
0D	Permit/prohibit automatic heating/cooling	This setting can be used to prevent the automatic heating/cooling display on the remote control if the unit configuration permits automatic heating/cooling operation.
0F	Cooling-only	This setting allows a heat pump indoor unit to be operated as a cooling-only unit.

## 7-6. Detailed Setting Items

Item code	Item	Description
10	Unit type	Set when the indoor unit EEPROM memory is replaced during servicing.
11	Indoor unit capacity	
12	System (outdoor unit) address	These are not set at the time of shipping from the factory. These must be set after installation if automatic address setting is not performed.
13	Indoor unit address	
14	Group address	
17	Cooling intake temperature shift	Shifts the intake temperature during cooling and dry operation. (Enabled only when the body thermostat is used.) Increase this value when it is difficult to turn the thermostat ON.
18	Automatic stop time after operation start	The time at which an indoor unit is automatically stopped after operation starts can be set in increments of 5 minutes
1b	Forced thermostat ON time	Use this setting to change the time for forced operation at installation or servicing from 5 minutes to 4 minutes. (Enabled only with PAC models.)
1E	Temperature shift for cooling/heating change in "auto heat/cool" mode	"Auto heat/cool" selects the operating mode automatically based on the difference between the room temperature and the temperature set on the remote controller. This setting establishes a shift temperature for the heating/cooling temperature setting relative to the remote controller temperature setting.



Item code	Item	Description	
1F (Upper limit) 20 (Lower limit)	Change to the remote control temperature setting range	This setting changes the temperature range (upper limit and lower limit) which is set from the remote controller or central control device. The set upper limit must be greater than or equal to the lower limit. If the temperature setting is to be a single point, set the upper limit and lower limit to the same temperature.	
21 (Upper limit) 22 (Lower limit)			Cooling
23 (Upper limit) 24 (Lower limit)			Heating
25 (Upper limit) 26 (Lower limit)			Drying
			Auto heat/cool
29	Humidifier operation which ignores the heat exchanger temperature	During heating operation, the humidifier operates when the heat exchanger temperature is suitable for humidifying. This setting is used to ignore this condition for humidifier operation and operate the humidifier more.	
2A	Filter input switching	This setting switches the filter input according to the purpose of use.	
2C	Indoor unit electronic control valve	This setting indicates whether or not an indoor unit electronic control valve is present. At the time of shipping, this setting is set according to the conditions of the indoor unit.	
2E	T10 terminal input switching	Ordinarily, the T10 terminal is used as the HA terminal at the time of shipping. However, this setting is used when the T10 terminal is used for OFF reminder or for fire prevention input.	
31	Ventilation fan operation from remote controller	It is possible to install a total heat exchanger and ventilation fan in the system, which can be started and stopped by the wired remote controller. The ventilation fan can operate linked with the start and stop of the indoor unit, or can be operated even when the indoor unit is stopped. Use a ventilation fan that can accept the no-voltage A contact as the external input signal. In the case of group control, the fans are operated together. They cannot be operated individually.	
32	Switching to remote controller sensor	This setting is used to switch from the body sensor to the remote controller sensor. Check that "remote controller sensor" is displayed. Do not use this setting with models that do not include a remote controller sensor. Do not use this setting if both the body sensor and remote sensor are used.	
34	ON/OFF of "Operation change control in progress" display	In a MULTI system with multiple remote controllers, switching between heating and cooling is restricted, and "Operation change control in progress" is displayed. This setting is used to prevent this display from appearing. Refer to the item concerned with operating mode priorities.	
35	OFF reminder function for weekly timer	This setting switches the operation when the weekly timer is connected to the remote controller. This can be used to prevent cases in which the unit is accidentally left ON. There is no change when this setting is ON, however it is necessary to set the weekly timer ON time.	

(Continued)

(Continued from previous page)

<b>Item code</b>	<b>Item</b>	<b>Description</b>
<b>3C</b>	Heat exchanger temperature for cold air discharge	The heat exchanger temperature control point for prevention of cold air discharge during heating operation can be changed.
<b>3d</b>	Fan output switching	The indoor unit PCB optional output for the fan can be switched according to the purpose of use.
<b>3E</b>	Drain pump delayed stop time	The drain pump stops for the set time delay after cooling operation stops.
<b>40</b>	Humidifier drain pump setting	This specifies the humidifier and drain pump setting.
<b>45</b>	DC flap operation mode	Changes flap operation to draft reduction mode.
<b>46</b>	DC flap swing mode	Selects the swing operation mode for the flap.
<b>5d</b>	DC fan tap setting	Sets the DC fan tap according to the purpose of use. Change the settings data at the same time.
<b>5E</b>	Humidifier ON time	Sets the humidifier output ON time for when the humidifier is operating. ON/OFF control is performed during humidifier operation. This setting therefore sets the ON time per 60-second interval.
<b>60</b>	Timer function change prohibit	This function prohibits changes from being made to the remote controller time setting.
<b>62</b>	Smudging control	Smudging control is disabled when 0000 is set.
<b>FC</b>	Refrigerant adaptability	This item is set to 01 when the indoor unit model adapted with both R410A and R32.

## ■ DC Fan Tap Change Procedure (in the case of 4-way Cassette)

### <Procedure>

It is necessary to set the fan speed in accordance with the intended application and the optional parts to be used if any such part is used. (Table 1)

If this speed is not changed, a reduction in the air flow may result, causing the air outlet temperature to drop and condensation to form during cooling.

There are two ways to set the fan speed: either (1) change the positions of the DIP switches on the indoor unit control PCB or (2) set the speed using the wired remote controller. Select one of these ways.

\* Priority is given to setting the fan speed by changing the positions of the DIP switches.

**(Table. 1) DC fan motor tap setting table**

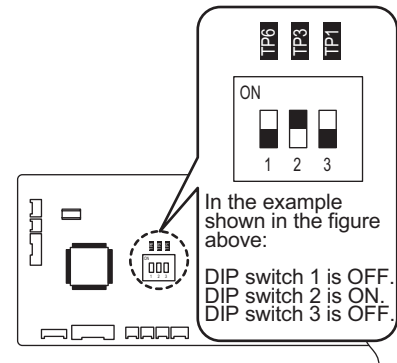
Setting No	Item code 5D/5d setting data	Intended application / name of optional parts	Setting No	Item code 5D/5d setting data	Intended application / name of optional parts
	0000	Standard (factory setting)	(1)	0001	Air-flow blocking kit (for 3-way air flow)
(1)	0001	High-ceiling setting 1 (with standard, ECONAVI panel)	(3)	0003	High-ceiling setting 2 (with standard, ECONAVI panel)
		Air-flow blocking kit (when a duct is connected.)	(6)	0006	Air-flow blocking kit (for 2-way air flow)

### (1) When setting the fan speed by changing the positions of the DIP switches on the indoor unit control PCB

<Procedure> Be absolutely sure to turn off the power (earth-leakage circuit breaker).

- <1> On Table 1, check out the "Setting No." that corresponds to the intended application and the optional parts to be used.
- <2> Open the cover of the electrical parts box, and check the indoor unit control PCB. (Fig. 7-5)
- <3> Select the Setting No. which was checked out on Table 1, and change the positions of the DIP switches on the indoor unit control PCB.

Setting No.	DIP switch
(1)	<p>DIP switch "ON" position "OFF" position</p>
(3)	<p>DIP switch "ON" position "OFF" position</p>
(6)	<p>DIP switch "ON" position "OFF" position</p>



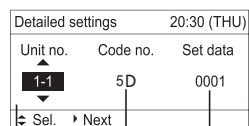
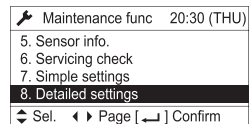
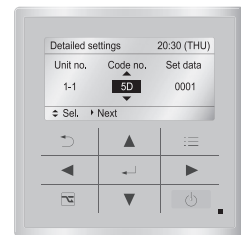
(Fig. 7-5) Indoor unit control PCB

### (2) When setting the fan speed using a wired remote controller (optional parts: CZ-RTC5A, CZ-RTC5B)

On Table 1, check out the "Item code 5D setting data" that corresponds to the intended application and the optional parts to be used.

<Procedure> Ensure that the unit has stopped operating before changing the fan speed.

- <1> Hold down the + + buttons together for at least 4 seconds. The maintenance function screen is displayed.
- <2> Use the / buttons to select the display and the / buttons to select the page.  
Select "8. Detailed settings" and press the button. The [Detailed settings screen] appears.  
Using the / buttons, select the unit No.
- <3> Using the / buttons, select the item code.  
Using the / buttons, change the item code to "5D."
- <4> Using the / buttons, select the setting data.  
Using the / buttons, change the setting data to the value checked out on Table 1, and press the button.
- <5> After selecting the unit No. using the / buttons, press the button. The [Detailed settings completion screen] appears. Select "Yes", and press the button.



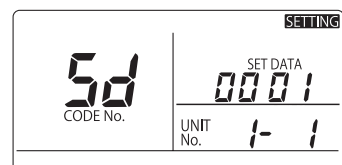
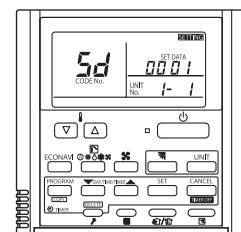
Unit No. Setting data Item code

### (3) When setting the fan speed using a wired remote controller (optional parts: CZ-RTC4)

On Table 1, check out the "Item code 5d setting data" that corresponds to the intended application and the optional parts to be used.

<Procedure> Ensure that the units have stopped operating before changing the fan speed.

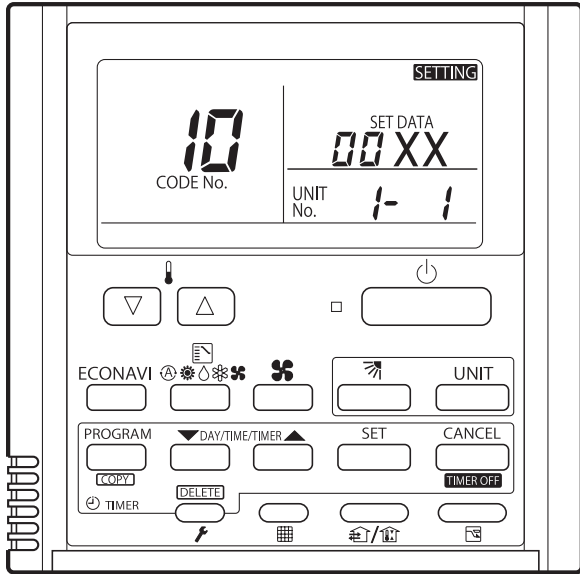
- <1> Hold down the + + buttons together for at least 4 seconds.
- <2> Each time the button is pressed, the numbers of the indoor units under group control are displayed in sequence.  
The fan motor of only the indoor unit that has been selected will run.
- <3> Specify item code "5d" using the temperature setting ( / ) buttons.
- <4> Change the setting data using the hour buttons. The setting data details are as given on Table 1.
- <5> Press the button. (OK if the display changes from flashing to lighted.)
- <6> Press the button. The normal stop status is established.  
Go to step <2> to change the selected indoor unit.
- <7> Press the button. The normal stop status is established.



## 7-7. Remote Controller Servicing Functions

- The remote controller includes a number of servicing functions. Use these as needed for test runs and inspections.

### ■ Timer Remote Controller CZ-RTC4



CZ-RTC4








Fig. 7-6

### List of Servicing Functions

Functions	Description	Button operation	Reset operation	Unit status
Test run	Operation with forced thermostat ON	Press and hold the  button for 4 seconds or longer.		
Sensor temperature display	Temperature display from each sensor	Press and hold the  and  buttons for 4 seconds or longer.		Current operation is maintained.
Servicing check display	Alarm history display	Press and hold the  and  buttons for 4 seconds or longer.	Press the  button.	
Simple settings	Filter lifetime, operating mode priority, central control address, and other settings	Press and hold the  and  buttons for 4 seconds or longer.		When settings are made from a remote controller, the indoor unit where that remote controller is connected stops.
Detailed settings	System address, indoor unit address, central control address, and other settings	Press and hold the ,  and  buttons for 4 seconds or longer.		
Automatic address	Automatic address setting based on command from the wired remote controller	Press and hold the  and the timer operation  buttons for 4 seconds or longer.	Automatic reset	
Address change	Change of indoor unit address	Press and hold the  and the timer operation  buttons for 4 seconds or longer.	Press the  button.	Entire system stops.

## ■ High-spec Wired Remote Controller CZ-RTC5A / CZ-RTC5B

Display of "maintenance function" screen

- ① Keep pressing the ,  and  buttons simultaneously for 4 or more seconds. The "Maintenance func" screen appears on the LCD display.
- ② Press the  or  button to see each menu. If you wish to see the next screen instantly, press the  or  button.

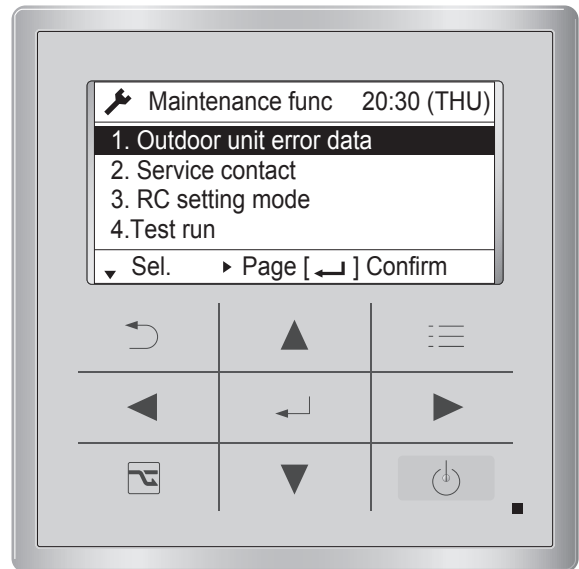




Fig. 7-7

### List of Servicing Functions




Functions	Description	Menu selection	Reset operation	Unit status
Test run	Operation with forced thermostat ON	4. Test run		
Sensor temperature display	Temperature display from each sensor	5. Sensor info	Press the  button.	
Servicing check display	Alarm history display	6. Service check		
Simple settings	Filter lifetime, operating mode priority, central control address, and other settings	7. Simple settings	Press the  button. (Restart)	When settings are made from a remote controller, the indoor unit where that remote controller is connected stops.
Detailed settings	System address, indoor unit address, central control address, and other settings	8. Detailed settings		
Automatic address	Automatic address setting based on command from the wired remote controller	9. Auo address	Automatic reset	Entire system stops.

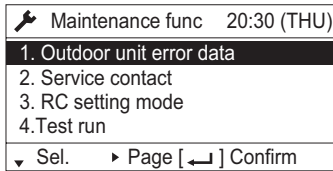







## 7-8. Test Run Function

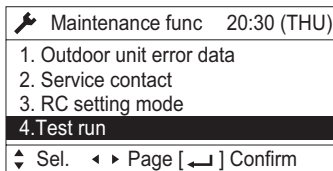
Operates the unit with the thermostat forced ON.




### <Procedure of CZ-RTC5A / CZ-RTC5B>

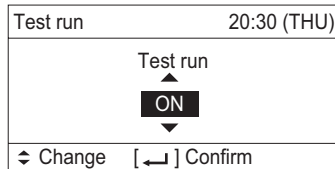
- Keep pressing the ,  and  buttons simultaneously for 4 or more seconds. The "Maintenance func" screen appears on the LCD display.






- Press the  or  button to see each menu. If you wish to see the next screen instantly, press the  or  button. Select "4. Test run" on the LCD display and press the  button.



Change the display from OFF to ON by pressing the  or  button. Then press the  button.




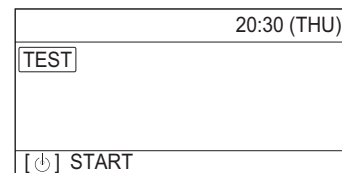
### <Procedure of CZ-RTC4>


- Press and hold the  button for 4 seconds or longer.
- "TEST" appears on the remote controller LCD display (Fig. 7-9).
- Press the  button to start the test run.
- Press the  button to return to normal remote controller display.



CZ-RTC5A / CZ-RTC5B  
Fig. 7-8

- Press the  button. "TEST" will be displayed on the LCD display.



- Press the  button. Test run will be started. Test run setting mode screen appears on the LCD display.

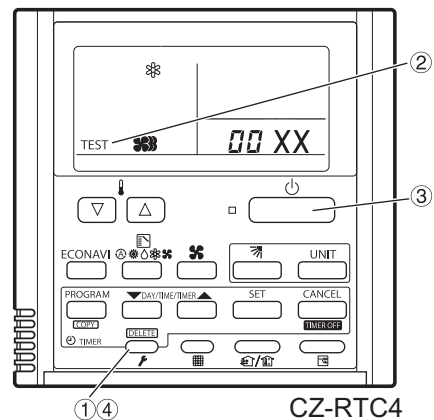
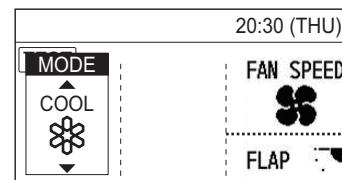








Fig. 7-9

CZ-RTC4

## ■ Sensor Temperature Display Function (displayed regardless of whether unit is operating or stopped)

The procedure below displays the sensor temperatures from the remote controller, indoor unit, and outdoor unit on the remote controller.

### <Procedure of CZ-RTC4>

- ① Press and hold the  and  buttons simultaneously for 4 seconds or longer.
- ② The unit No. "X-X" (main unit No.), item code "XX" (sensor address), and servicing monitor "00 YY" (sensor temperature) are displayed on the remote controller LCD display. (See Fig. 7-10 at right.)
- ③ Press the temperature setting  /  buttons and select the item code to the address of the sensor to monitor.
- ④ If group control is in effect, press the  button to select the unit to monitor.  
Press the temperature setting buttons to select the item code to change.
- ⑤ Press the  button to return to normal remote controller display.

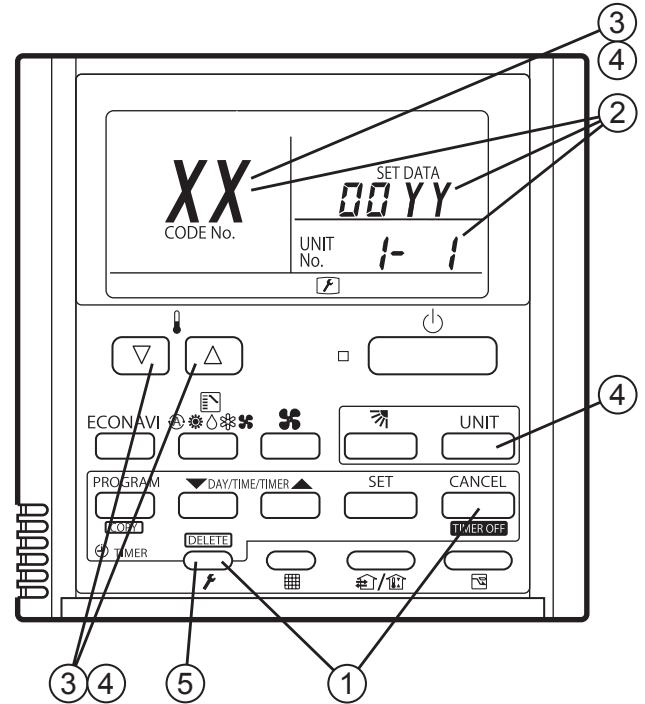





Fig. 7-10






	Item code	Meaning of Code
Indoor unit data	02	Indoor unit intake temp.
	03	Indoor unit heat exchanger temp. (E1)
	04	Indoor unit heat exchanger temp. (E2)
	05	—
	06	—
	07	—
	08	—
	09	—
	Outdoor unit data	0A
0b		—
0C		—
0d		Intake temp. (TS)
0E		Outdoor unit heat exchanger temp. (C1)
0F		Outdoor unit heat exchanger temp. (C2)
10		—
11		Outdoor air temp. (TO)
12		—
13		Current value (CTL2)
14		Current value (CTL1)
15	Outdoor MV value (MOV1)	
16	—	
19	Frequency	

\* Depending on the model, some items may not be displayed.



**<Procedure of CZ-RTC5A / CZ-RTC5B>**

- ① Keep pressing the ,  and  buttons simultaneously for 4 or more seconds. The "Maintenance func" screen appears on the LCD display.

Maintenance func		20:30 (THU)
1. Outdoor unit error data		
2. Service contact		
3. RC setting mode		
4. Test run		
▼ Sel.	▶ Page [←]	Confirm

- ② Press the  or  button to see each menu. If you wish to see the next screen instantly, press the  or  button. Select "5. Sensor info." on the LCD display and press the  button.



Maintenance func		20:30 (THU)
5. Sensor info.		
6. Servicing check		
7. Simple settings		
8. Detailed settings		
↕ Sel.	◀▶ Page [←]	Confirm

Select the "Unit no." by pressing the  or  button for changes.

Sensor info.			20:30 (THU)
Unit no.	Code no.	Data	
▲	00	0026	
1-1	01	0028	
▼	02	0026	
↕ Sel.	▶ Next		

Then press the  button. Display sensor information of the unit.

Sensor info.			20:30 (THU)
Unit no.	Code no.	Data	
1-1	00	0026	
	01	0028	
	02	0026	
↕ Scroll			

Refer the information by pressing the  or  button.






CZ-RTC5A / CZ-RTC5B



Fig. 7-11


## Automatic address setting



### <Procedure of CZ-RTC5A / CZ-RTC5B>

① Keep pressing the ,  and  buttons simultaneously for 4 or more seconds. The “Maintenance func” screen appears on the LCD display.



② Press the  or  button to see each menu.

If you wish to see the next screen instantly, press the  or  button.



Select “9. Auto address” on the LCD display and press the  button.




 Maintenance func	20:30 (THU)
<b>9. Auto address</b>	
10. Set elec. consumption	
11. Set touch key	
12. Check touch key	
↕ Sel. ◀ Page [  ] Confirm	

③ The “Auto address” screen appears on the LCD display.

Change the “Code no.” to “A1” by pressing the  or  button.

Auto address	20:30 (THU)
Code no.	O/D unit no.
<b>A1</b>	1
↕ Sel. ▶ Next	

④ Select the “O/D unit no.” by pressing the  or  button.

Select one of the “O/D unit no.” for automatic address by pressing the  or  button. Then press the  button.

Approximately about 10 minutes are required.




When automatic address setting is completed, the units return to normal stopped status.





CZ-RTC5A / CZ-RTC5B



Fig. 7-12


## Checking indoor unit addresses



① Keep pressing the ,  and  buttons simultaneously for 4 or more seconds. The “Maintenance func” screen appears on the LCD display.

 Maintenance func	20:30 (THU)
<b>1. Outdoor unit error data</b>	
2. Service contact	
3. RC setting mode	
4. Test run	
▼ Sel. ▶ Page [  ] Confirm	



② Press the  or  button to see each menu.

If you wish to see the next screen instantly, press the  or  button.

Select “7. Simple settings” on the LCD display and press the  button.

 Maintenance func	20:30 (THU)
5. Sensor info.	
6. Servicing check	
<b>7. Simple settings</b>	
8. Detailed settings	
↕ Sel. ◀ ▶ Page [  ] Confirm	

The “Simple settings” screen appears on the LCD display.

Select the “Unit no.” by pressing the  or  button for changes.

Simple settings	20:30 (THU)	
Unit no.	Code no.	Set data
<b>3-1</b>	01	0001
↕ Sel. ▶ Next		

The indoor unit fan operates only at the selected indoor unit.

## 8. HOW TO INSTALL THE WIRELESS REMOTE CONTROLLER RECEIVER

■ Important Safety Instructions .....	8-2
■ Optional Controller (Remote Controller) .....	8-3
8-1. Names and Functions .....	8-3
8-2. Installing Batteries .....	8-5
8-3. Setting the Current Time .....	8-5
8-4. Operation .....	8-6
8-5. Timer Operation .....	8-7
8-6. Adjusting the Wind Direction .....	8-8
8-7. Operating Multiple In/Outdoor Units Simultaneously (Group Control) .....	8-8
8-8. Using the Remote Controller .....	8-9
8-9. For Best Results .....	8-9
8-10. Addresses .....	8-9
8-11. Emergency Operation .....	8-11
8-12. Miscellaneous Settings .....	8-12
8-13. Before Requesting Service .....	8-13
■ How to Install the Wireless Remote Controller Receiver .....	8-14
8-14. Common to All Models.....	8-14
8-15. CZ-RWSU3 .....	8-16
8-16. CZ-RWST3N .....	8-18
8-17. CZ-RWSC3 .....	8-20
8-18. Type K2 .....	8-24
8-19. Common to All Models .....	8-25

## ■ Important Safety Instructions

### WARNING

#### Installation Precautions

- Do not install yourself  
Installation should always be performed by your dealer or a professional service provider.  
Electric shock or fire may result if an inexperienced person performs any installation or wiring procedures incorrectly.
- Use only specified air conditioners  
Always use only air conditions specified by the dealer.

#### Precautions for Use

- Do not touch switches with wet hands  
Electric shock and damage to the system can result.
- Protect the remote controller from water  
Damage to the system can result.
- Stop the system and turn the power off if you sense unusual smells or other irregularities  
Continuing operation when the system is out of order can result in electric shock, fire, and damage to the system.  
Contact your dealer.
- Do not swallow the battery.

#### Moving and Repair Precautions

- Do not repair  
Never repair the system by yourself.
- Contact your dealer before moving the system  
Contact your dealer or a professional service provider about moving and reinstalling the system.  
Electric shock or fire may result if an inexperienced person performs any installation procedures incorrectly.





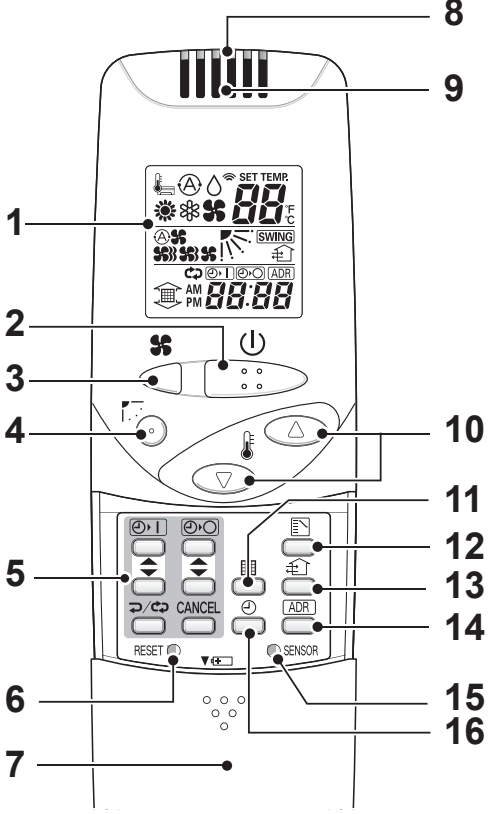










## ■ Optional Controller (Remote Controller)


Wireless Remote Controller CZ-RWSU3 / CZ-RWST3N / CZ-RWSC3 / CZ-RWSK2

One remote controller can control a group of up to eight indoor units.

### 8-1. Names and Functions

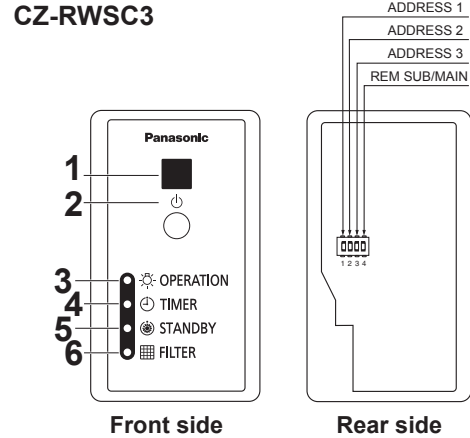
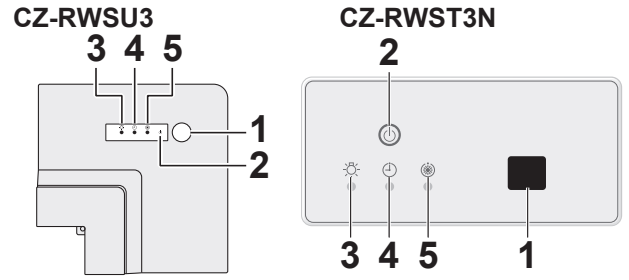
#### REMOTE CONTROLLER

<b>1. Operation Display</b>	Displays the operation status. (The figure shows all the statuses.) • The auto-flap display may be different, depending on the installed unit.	<b>15. Sensor button</b>	Use this button to activate the temperature sensor on the remote controller instead of the one on the indoor unit. The temperature sensor on the indoor unit is selected before shipment. At this time  is shown on the display.
<b>2. Start/Stop button</b> 	Pressing this button once starts and pressing again stops the operation.	<b>16. Clock button</b> 	Use this button to set the clock.
<b>3. Fan speed button</b> 			
<b>4. Swing/Wind Direction button</b> 			
<b>5. Timer setting button</b>  	Use for operating with a timer.		
<b>6. Reset button</b>	Use this button after changing the batteries.		
<b>7. Cover</b>	Press at the top center and then slide down.		
<b>8. Transmitter</b>			
<b>9. Remote controller sensor</b>	Detects the temperature at the remote controller when detection has been switched to the remote controller by the sensor button.		
<b>10. Temperature setting buttons</b>	 raises the temperature setting 1 °C at a time.  lowers the temperature setting 1 °C at a time.		
<b>11. Filter button</b> 	CZ-RWSC3 Press to turn off the filter lamp on the receiver.		
<b>12. Mode Select button</b> 	Press to switch the operation mode.		
<b>13. Ventilation button</b> 	Use this button when connected to an aftermarket fan. Pressing this button starts and stops the fan. When the air conditioner is started or stopped, the fan starts or stops at the same time. (  appears on the display of the remote controller when the fan is operating.)		
<b>14. Address button</b> 			

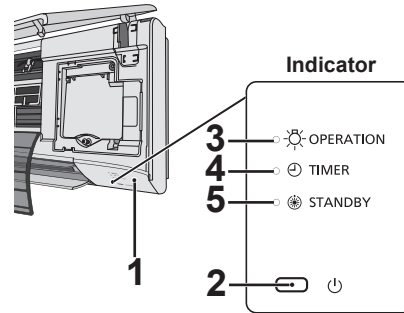
From this page on the names of remote controller's buttons will be indicated with the above illustrations.  
 E.g.: Start/Stop button → 

**RECEIVER**

<b>1. Receiver</b>	Receives the signal sent from the remote controller.
<b>2. Emergency operation button</b>	<b>Display lamps</b> When an error occurs, one of the lamps flashes. When a display lamp is blinking, refer to " Before Requesting Service ".
<b>3. Operating lamp</b>	This lamp is lit when the unit is operating.
<b>4. Timer lamp</b>	This lamp is lit when the timer is set.
<b>5. Standby lamp</b>	<ul style="list-style-type: none"> <li>• When the heater is working, the lamp lights at the following times. When the thermostat has operated during defrosting at the time of the startup.</li> <li>• The lamp flashes when an error occurs.</li> </ul>
<b>6. Filter lamp</b>	This lamp is for notifying you when the filter needs to be cleaned.



**Indoor Unit (Type K2)**



**NOTE**

- If a heat pump model is being used, it will beep twice and the operating lamp will light up on the display; if the timer and standby lamps blink alternately, a conflict between the heating and cooling exists, so the unit cannot operate in the desired mode. (On models that do not have an Auto function, even if Auto is selected, it works in the same way.)
- When the local operation is disabled by such as the centralized control, and if the Start, Stop, Mode or Temperature setting buttons are pressed, the unit will beep five times and the change will not be made.



## 8-2. Installing Batteries

1. Remove the cover.

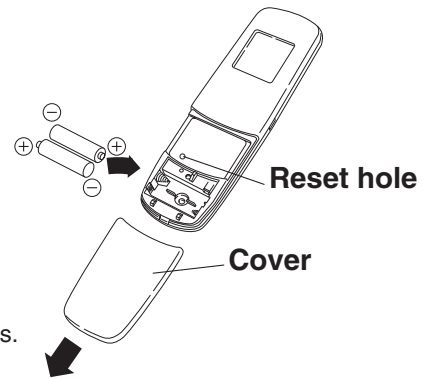
2. Insert two LR03 size batteries.

Put the batteries in with the polarity [+/-] as shown in the figure.

3. Gently insert one end of an unfolded paper clip (or a similar object that can fit) into the Reset hole and press the Reset button inside the hole, then put the cover back on.

### NOTE

- Change the batteries when the display of the remote controller gets weak or if it will not work unless close to the receiver.  
(Alkaline batteries generally last about one year.)
- When changing batteries, always use two fresh batteries of the same make.
- If the remote controller will not be used for a long period of time, remove the batteries.
- Please dispose of batteries appropriately.
- After changing the batteries, follow the procedures on the next page to reset the current time.



### How to remove batteries

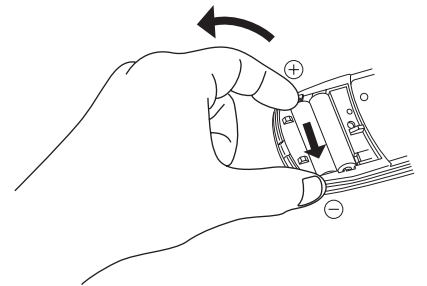
1. Remove the cover.

2. Press the battery toward the negative end and lift it out by its positive end.  
(As shown at right)

3. Remove the other battery in the same way.

### NOTE

- Dispose of the used batteries at the designated location in compliance with the applicable local ordinances.



### WARNING

- Do not swallow the battery.
- After removing the battery from remote controller, keep it away from the reach of children.  
The battery can cause death by suffocation if swallowed.
- When inserting the battery, make sure the polarities (+ and -) are correct.

## 8-3. Setting the Current Time

After changing the batteries and pressing reset, be sure to reset the current time.

(When reset is pressed, the current time reverts to [0:00])

1. Press **⏸** for two seconds or more.

Once the clock displays starts blinking, the clock can be set.

2. Set the hour with **▶** / **◀** of the **⌚**.

If you press and hold the button, the time changes quickly.

3. Set the minutes with **▶** / **◀** of the **⌚**.

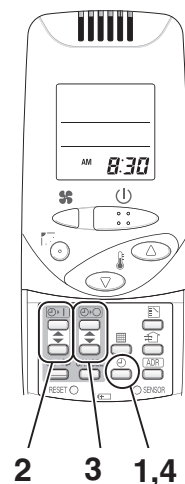
If you press and hold the button, the time changes quickly.

4. Pressing **⏸** completes the time setting.

- While you are setting the current time, the time display flashes but the colon does not.
- If the buttons are not pressed for three minutes while setting the current time, it is set to the displayed time.

### NOTE

When reset is pressed, the timer settings are deleted.














## 8-4. Operation





**Auto** , **Heat** , **Dry** , **Cool** , **Fan** 

Models that only provide the cooling function cannot operate in the auto or heating modes.

**Power:** Turn on the power of the indoor unit at least 14 hours before operation.

1. Press .
2. Press  and select from among Auto , Heat , Dry , Cool  and Fan .
3. Press  and select the desired speed.  
If set to Auto , the fan speed switches automatically.  
(Auto does not work when in the Fan mode.)
4. Press one of the   buttons and set the desired temperature.

Temperature settings cannot be made when in the Fan mode.

	MAX	MIN
Auto 	27	17
Heat 	30	16
Dry  / Cool 	30	18

**Stop:** Press .

When the unit is stopped with the remote controller, the fan on the outdoor unit may continue to run for a while, even though the compressor of the outdoor unit stops.

**If the unit is not heating very effectively with a Low fan speed , switch the fan speed to High  or Medium .**

Depending on the indoor unit being used, it may indicate a function that it does not have. (The fan speed is set.)


**If you cannot turn the air conditioner off in the normal way.**

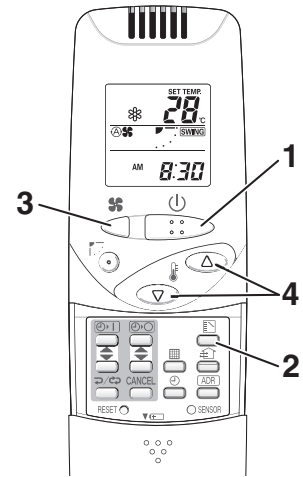
Disconnect the power to the indoor unit and contact the dealer where the product was purchased.

### <Auto Operation>

Only when identical refrigerant system inside all the indoor units or cooling/heating free-type are under control as one group. It heats or cools automatically via the differences between the set temperature and the room temperature.

### <Dry Operation>

- Depending on the indoor unit used, the remote controller may have a [Dry]  indicator on its display even though the unit does not have the Dry function. (Same as cooler operation)
- When the room temperature approaches the temperature setting, the unit continues to start up or stop automatically.
- When the drying mode stops operating, the indoor unit's fan blows a gentle breeze in order to keep the moisture from returning to the room at a minimum.
- Depending on the indoor unit used, and/or the temperature in the room, the fan speed may not be adjustable.
- Depending on the unit used, when the outside air temperature is 15 °C or less, the dry function will not operate.



## 8-5. Timer Operation

- When setting the timer, make sure the current time on the remote controller is accurate.
- The timer's clock can only be set when the display of the remote controller is ON.
- After setting the timer, put the remote controller in a place where its signal will reach the receiver of the indoor unit. (When the time set for the timer is reached, a signal is sent from the remote controller to Start/Stop the unit.)

### Using the Timer

1. Press either ▲ / ▼ of the or , and while the time is being displayed, if you press ▲ / ▼ again, a scheduled time can be set.

The time last set on the timer is displayed.

“--:--” indicates time to change the batteries.

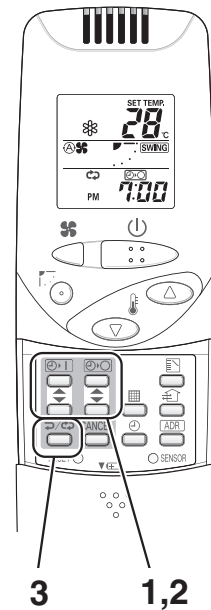
2. Press either ▲ / ▼ of the or and set the timer to the desired time.

Every time you press ▲ / ▼, the time changes in 10 minute increments.

If you press and hold the button, the time changes quickly.

3. After setting the timer, if you press , the time you set changes to a steady display, indicating settings are complete.

After the timer setting is displayed for three seconds, the display reverts to the current time.



### Combining ON and OFF Timers

- Setting the ON and OFF timers, respectively.

### Checking the timer setting

- If you press either ▲ / ▼ for the or the , the scheduled time is displayed for four seconds.
- When no timer setting has been made, it displays --:--. (Initial Setting)

### Changing a timer setting

- Press ▲ / ▼ for the or the , and then when the timer setting is displayed, press ▲ / ▼ for the timer again.

### Canceling a timer setting

- If you press [CANCEL], the timer setting is canceled.
- If you wish to cancel the setting for either the or the timer, press ▲ / ▼, and long-press [CANCEL] while scheduled time is displayed.

### Using the same timer setting every day

- If you press for 2 or more seconds, “” is displayed and the **ON timer** or the **OFF timer** will operate repeatedly every day.
- If you press again for two seconds or more, “” goes off and the timer operates only one time.


## 8-6. Adjusting the Wind Direction

- Never try to manually move the flap (up-down wind direction plate) that is operated by the remote controller.
- When the unit stops, the flap (up-down wind direction plate) automatically faces downwards.
- When the unit is in heating standby, the flap (up-down wind direction plate) faces upward.



Also, bear in mind that the flap starts swinging after the heating standby mode is released, but the display on the remote controller indicates Auto Flap during standby heating as well.

### CZ-RWSU3 / CZ-RWST3N / Indoor Unit (CZ-RWSK2)



#### Setting the Wind Direction

While the unit is operating, every time you press , the direction the flap faces changes.

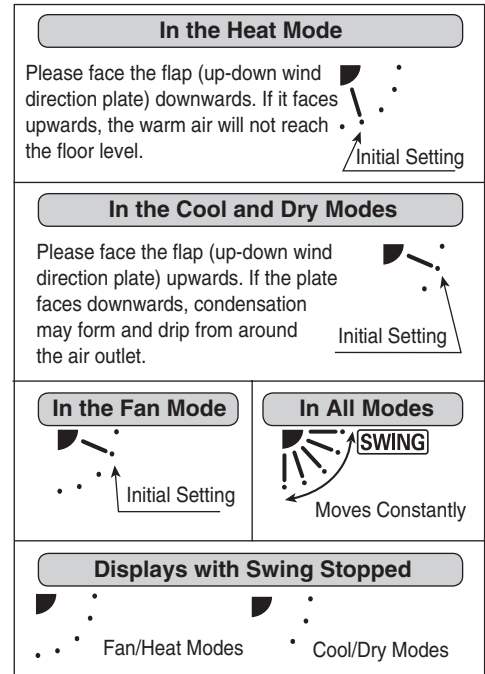
#### Setting Flap to Swing

If you press  to set the flap (up-down wind direction plate) in its most downward facing position, and then press  again, **SWING** is displayed and the flap swings automatically up and down.

#### Stopping Flap Swing

If you press  again while the flap is swinging, you can stop the flap from swinging and set it in place as desired. Thereafter, if you press , you can set the wind direction starting from the most upward position.

- When the unit is in the Cool or Dry modes, the flap cannot stop facing downwards. If you try to stop the flap from swinging while it is facing downwards, it will continue moving until it is in the third position from the top.



### CZ-RWSC2

The available functions differ depending on the indoor unit being used.

The wind direction cannot be set via remote controller for any models other than those noted below.

For more information, please refer to the users' manual that came with your indoor unit.

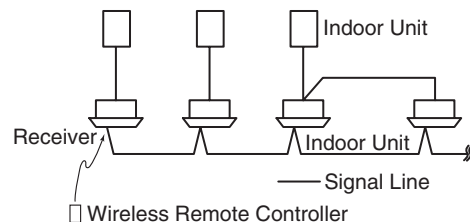
**Four-direction Ceiling Cassette Models, Bi-directional Ceiling Cassette Models, Unidirectional Cassette Models for High Ceilings, Ceiling Suspended Models, Wall Models**

Please refer to *Setting the Wind Direction and Stopping Flap Swing*.

## 8-7. Operating Multiple In/Outdoor Units Simultaneously (Group Control)

**Group control works well for providing air conditioning to one, large room with more than one air conditioning units.**


- One remote controller can operate up to eight indoor units.
- All the indoor units have identical settings.
- Set temperature sensing to the indoor unit (Main Sensor). (See page 8-3.)



## 8-8. Using the Remote Controller

- Point the transmitter of the remote controller at the receiver. When the signal is received correctly it will beep once. (It beeps twice only when the unit starts operating.)
- The signal can be received at a distance of about 6 meters. This distance should be used only as a guide. It depends on battery strength.
- Make sure nothing is between the remote controller and the receiver that could block the signal.
- Do not leave the remote controller in direct sunlight, where the wind from the air conditioner can blow directly on it, or near any other heat source.
- Take care not to drop, throw or wash the remote controller with water.
- The signal from the remote controller may not be received in rooms with rapid start fluorescent lighting, inverter lights, plasma displays, LCD televisions (monitor), etc. For more information, please contact the dealer where the product was purchased.

### Wall Mount Use

- Press  from the location you wish to mount the remote controller and make sure the signal is received properly.
- Pull the remote controller forward to remove it.

## 8-9. For Best Results

### Don't get the remote controller too far away from the receiver.

This may cause a malfunction. Be sure to keep the remote controller in the same room as the receiver.

### Point the remote controller at the receiver.

When the signal is received properly, it will beep one time.

### Avoid locating the remote controller where it is covered, such as behind a curtain.

Keep it out in the open.


## 8-10. Addresses

**In both multi and single unit installations**, when more than one indoor units are installed in the same room with a compatible wireless remote controller, addresses can be set up to avoid crosstalk. By setting the address switches on the receivers and matching them with the number of addresses on the remote controller, up to six indoor units can be controlled separately with the remote controller. (When using units in a flexible combination or operating multiple units simultaneously, they cannot be controlled individually as they are operated at the same time.) There are separate address settings, receiver addresses for the receivers and transmitter addresses for the remote controller.

For more information, please contact the distributor where the product was purchased.

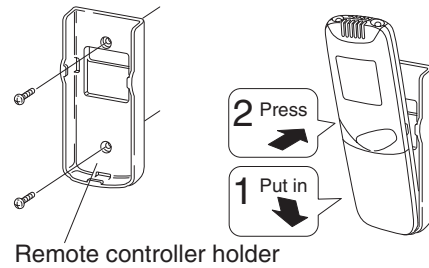
- The setting procedure is different for Indoor Unit (CZ-RWSK2). (See Setting Addresses (CZ-RWSK2) in the next page.)
- These settings are saved in nonvolatile memory in the remote controller, so even when its batteries are changed, the settings do not have to be made again.

### Checking Addresses

When you press  on the remote controller, its current address appears on the display. If this address corresponds to the address of a receiver, the buzzer sounds. (If it is on ALL, the buzzer will always sound.)

If it is on ALL, it can be operated regardless of receiver addresses. Point the remote controller at the receiver you wish to operate and transmit.

Fasten the remote controller holder with screws.      Fitting the remote controller in the holder.



## Matching up Addresses



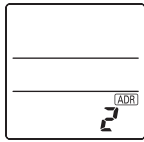
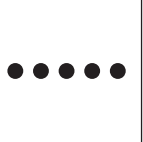
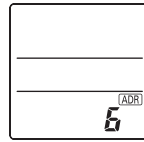
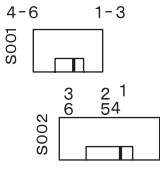
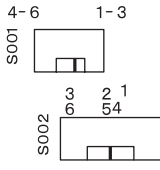
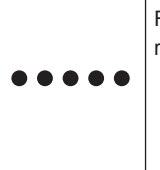
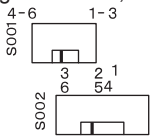
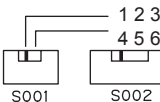
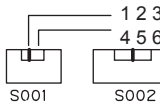

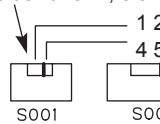
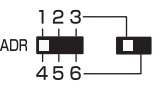
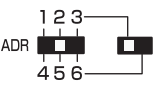
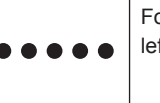
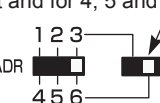
### Setting Remote Controller Addresses

1. If you press **[ADR]** and **↻/↺** at the same time, "SET" will blink.
2. While holding **[ADR]** down, every time you press **↻/↺**, it cycles from ALL → 1 → 2 → 3... 6 → ALL.

Set it to the receiver address switch of the indoor unit you wish to operate.



3. When you release **[ADR]**, the address that was displayed is set.

When you do this, if it corresponds to the receiver's address setting, the buzzer sounds.


Address Display on the Remote Controller					
<b>CZ-RWSU3</b>					
Position of receiver's (inside indoor unit) address switch	The position of the receiver's address switch does not matter.				For 1, 2 and 3, set the switch on the right and for 4, 5 and 6, to the left. 
<b>CZ-RWST3N</b>					
Position of receiver's (inside indoor unit) address switch	The position of the receiver's address switch does not matter.				For 1, 2 and 3, set the switch on the left and for 4, 5 and 6, to the right. 
<b>CZ-RWSC3</b>					
Position of the Receiver's Address Switch	The position of the receiver's address switch does not matter.				For 1, 2 and 3, set the switch on the left and for 4, 5 and 6, to the right. 

### Setting Addresses (CZ-RWSK2)

(Setting the address of the indoor unit)

1. First of all, set the address for the remote controller with Setting Remote Controller Address (See Page 8-9).
2. Press **[Emergency Operation]**  of the indoor unit for four seconds or more.  
When you do this, the lamps of the display will blink one after another.
3. Press **[ADR]** on the remote controller.
4. The buzzer will sound and the address of the indoor unit will change to the address displayed on the remote controller.
5. If you press **[Emergency Operation]**  of the indoor unit once, the lamps on the indoor unit's display will turn off.

#### NOTE

- Please do not hold the **[Emergency Operation]**  button of the indoor unit down while the indoor unit's display lamps are blinking one after another.
- Make sure to operate while the indoor unit is stopped.
- The address of indoor unit is set to "ALL" at the time of the shipment.

## 8-11. Emergency Operation

Use [Emergency Operation]  in the following situations when there is an urgent need.

- When the remote controller's batteries have failed.
- When the remote controller is broken.
- When the remote controller is lost.

\*1 Figures: CZ-RWSU3 and CZ-RWST3N are of receivers (inside indoor unit), and Indoor Unit (CZ-RWSK2) is of its front panel.

### CZ-RWSU3 / Indoor Unit (S-100PK2E5B) / CZ-RWST3N / CZ-RWSC3

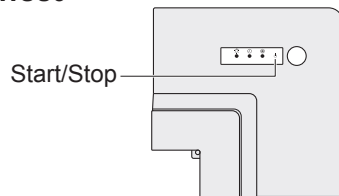
**Start :** press [Emergency Operation]  of the receiver.

If the indoor temperature is 24 °C or greater when the unit starts running, it will act as a cooler.

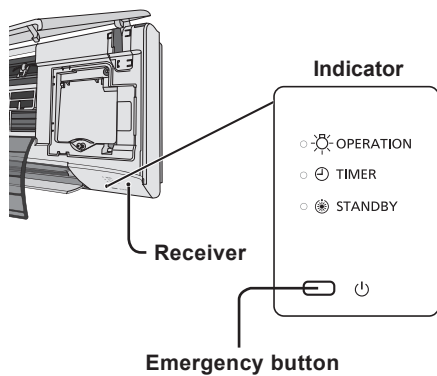
If the indoor temperature is less than 24 °C when the unit starts running, it will act as a heater.

**Stop :** press [Emergency Operation]  of the receiver again.

#### CZ-RWSU3



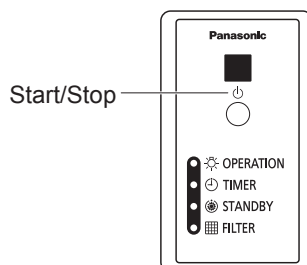
#### Indoor Unit (Type K2)



#### CZ-RWST3N



#### CZ-RWSC3





## 8-12. Miscellaneous Settings














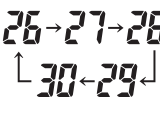
A variety of changes can be made to settings, depending on the indoor unit being used.

### Operation mode indicator, time display (24 hour, AM/PM), Heat Max Temp

- (These settings are saved in nonvolatile memory in the remote controller, so even when its batteries are changed, the settings do not have to be made again.)
- First check the display of the remote controller when the unit is stopped and then make any desired settings.

#### How to Operate

- While holding down the buttons below, every time  is pressed the remote controller's display changes.
- Whatever is being displayed when you release  is set.

Setting Item	Operation Button	Setting Content	Remote Controller Display
Remote controller operation mode display setting when  is pressed	Press  while pressing 	Heat Pump (with Auto)	
		Heat Pump (without Auto)	
		Dedicated air conditioner	
Clock display setting	Press  while pressing 	24 Hour	
		AM/PM	
Max possible temperature setting in the Heat mode	Press  while pressing  	Maximum heating temperature range is 26 °C – 30 °C	



## 8-13. Before Requesting Service

Before requesting service, please check the followings.

Problem	Cause	Solution
The unit doesn't work even when $\odot$ is pressed on the remote controller.	The power to the indoor unit is not ON.	Make sure the power to the indoor unit is ON.
	Are the remote controller's batteries dead?	Change the batteries.
	Is there a mismatch between the display lamp and cooling/heating or is it set to something other than Auto? (The operating lamp stays lit, while the timer lamp and the standby lamp blink alternately.)	Change the operating mode.
	Do the addresses match one another?	Check the addresses of the receiver* <sup>1</sup> and the remote controller. (See Page 8-9)
The air conditioner starts and stops on its own.	Has the timer been set to repeat?	Check the timer settings. (See Page 8-7)
"EP" is displayed on the remote controller when the unit is stopped.	An error has occurred in the non-volatile memory.	Please contact your sales outlet.
Although the unit is for air conditioning only, either Auto or Heat is indicated in the display.		Make settings to the remote controller's operation mode display. (See Page 8-12)
After putting the batteries in the remote controller, even when it is operated, the display does not change.		Press the Reset button on the remote controller. (See Page 8-5)
The timer cannot be set.		Make the settings when the remote controller is in Operation Display. (See Page 8-7)

If the problem persists even after you check the foregoing items, stop the unit, disconnect the power to the indoor unit and contact the dealer where the product was purchased with the model number and problem you are having.

As it is dangerous, under no circumstances should you undertake repairs yourself.

Further, when the receiver's\*<sup>2</sup> lamps are blinking; please contact your retailer with that information.

## Specifications

### CZ-RWSU3/CZ-RWSC3/CZ-RWSK2/CZ-RWST3N

Wireless Remote Controller	Dimensions	182 mm (H) X 61 mm (W) X 18.5 mm (D)
	Power source	Two LR03 size batteries
	Clock Accuracy	±30 seconds per month (at 25 °C)

### CZ-RWSU3/CZ-RWSC3/CZ-RWST3N

Receiver	Dimensions	CZ-RWSU3	29.7 mm (H) X 211.8 mm (W) X 211.8 mm (D)
		CZ-RWSC3	120 mm (H) X 70 mm (W) X 20 mm (D)
		CZ-RWST3N	65 mm (H) X 141 mm (W) X 22.5 mm (D)
	Power source	16 V DC (Supplied from the terminal strip of the indoor unit's remote controller)	

# How to Install the Wireless Remote Controller Receiver

## 8-14. Common to All Models

### 1. Warnings about Installation of Receivers

The wireless remote controller uses a very weak infrared light for its signal, which can result in the signal not being received because of the following influences, so take care in where the unit is installed.

- Inverter or rapid-start type fluorescent lights. (Models without glow lamps)
- Plasma display or LCD televisions.
- Direct sunlight or other sources of bright light.

### 2. Warnings about Installing Remote Controllers

- (1) If a remote controller is to be operated from a remote controller holder that is hung on a wall, turn on the lights in the room as well as any electrical appliances and then check to make sure the air conditioner works with the remote controller in the location where it will be installed. If it works, continue with installation.
- (2) If the air conditioner is to be switched from the main sensor to a remote controller sensor, pay attention to the following when installing.
  - Locate where no warm or cold drafts will affect it.
  - Locate in a place free from direct sunlight.
  - Locate where it will not be affected by any other heat/cold source.

### 3. Things to remember when wired and wireless remote controllers are installed at the same time

Two remote controllers can be used to controller the unit if the wireless remote controller kit is installed at the same time as the wired remote controller.

(Up to 2 remote controllers [a wireless remote controller kit and the wired remote controller] can be installed.)

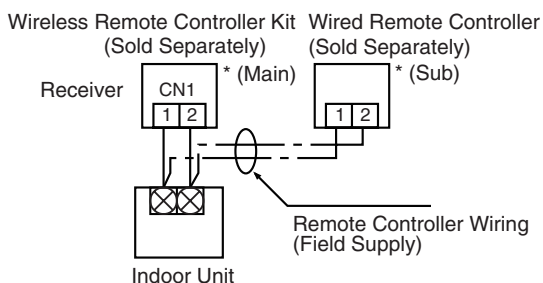
When using 2 remote controllers, one or more units can be operated by the remote controllers.

#### NOTE

1. When wiring remote controllers, be sure to double-check the terminal numbers of the indoor unit before connecting them so there are no mistakes in the wiring. (Damage will occur if high voltage [e.g. supply voltage] is applied)
  2. It is not possible to use more than one wireless remote controller kit with one indoor unit.  
(A receiver located separately can be used at the same time)
  3. If both a wireless and a wired remote controller are to be installed and used at the same time, one of them must be set up as the sub remote controller.
- If the wired remote controller is to be the sub remote controller, change the wired remote controller to the sub remote controller.
  - If the wireless remote controller is to be the secondary, turn the #3 switch on the wireless receiver (operation panel) from OFF to ON. (see next page)

#### When 1 indoor unit is operated by 2 remote controllers:

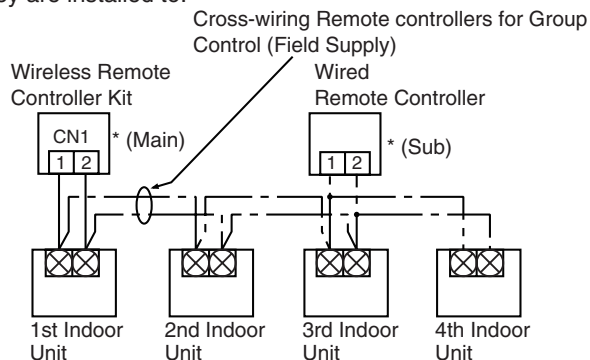
\* Either of the remote controllers can be set to main/sub.



- Use wiring of 0.5 mm<sup>2</sup> to 2 mm<sup>2</sup> for field supply.
- Use a total wire length of no more than 400 m.

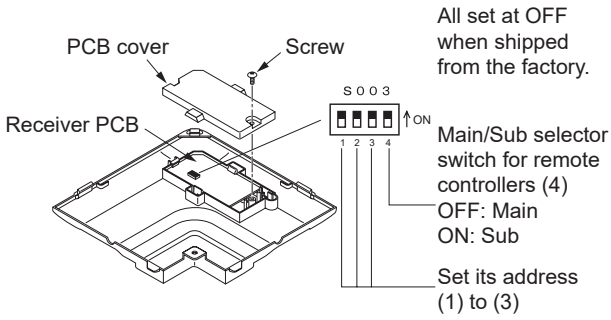
#### If a group of units are to be controlled by 2 remote controllers;

\* Main/sub remote controllers will work regardless of which indoor unit they are installed to.

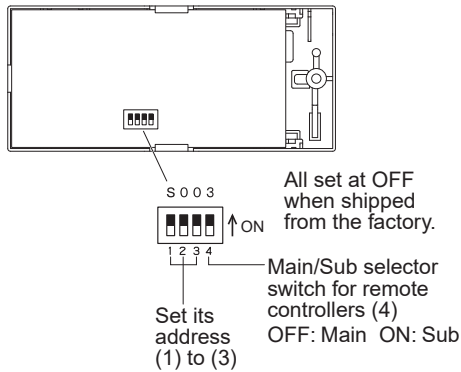


- Use wiring of 0.5 mm<sup>2</sup> to 2 mm<sup>2</sup> for field supply.
- Make the total wire length when cross-wiring a group no more than 200 m.

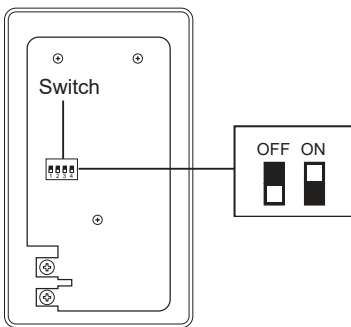
**CZ-RWSU3**



**CZ-RWST3N**



**CZ-RWSC3**



**Main/Sub setting**

- Use this to set Main/Sub for the remote controller and the receiver.
- Set one to [Main] and the other to [Sub].
- Factory default: [Main]
- It is recommended to set the wired remote controller to [Main].

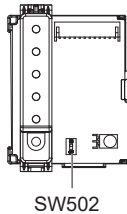
Main/Sub	MAIN	SUB
Main/Sub switch position	<p>1 2 3 4</p>	<p>1 2 3 4</p>

**Type K2**

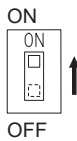
**<When Using Wireless Remote Controller Instead of Wired Remote Controller>**

When the wireless remote controller is to be used, slide the switch (SW502) to the ON position.

- If this setting is not made, an alarm will occur. (The operation lamp on the display blinks.)



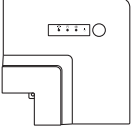


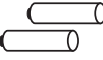




**Setting status**  
**ON:** Wireless: main,  
 Wired: sub  
**OFF:** Wired: main,  
 Wireless: sub (at shipment)



See "Section 8-18. <Optional parts setting and wiring>".

## 8-15. CZ-RWSU3

### 1. Accessories

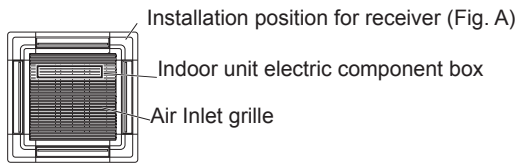
Supplied accessories							
Receiver (1)	Wireless Remote Controller (1)	Remote Controller Holder (1)	LR03 Size Battery (2)	Operating Instructions (1)	Quick Reference (1)	Wood Screw M4 × 16 (2)	Clamper (1)
							

### 2. Installing the Receiver

- The receiver can be installed only on the corner shown in Fig. A. Consider the direction where the panel is attached to the indoor unit.

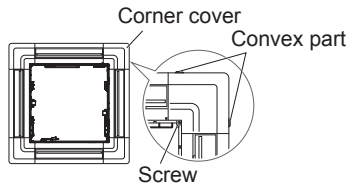
#### 1 Remove the air inlet grille

Indoor unit electric component box

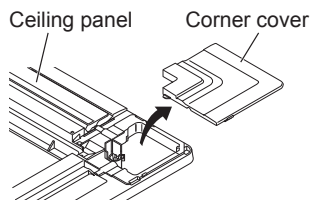


#### 2 Remove the corner cover.

- Remove the screw fixing the corner cover.

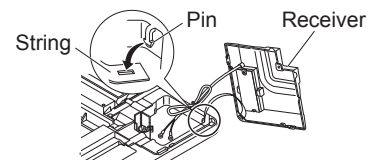


- Place a hand on both the right and left convex parts of the corner cover to remove it.



#### 3 Wire the receiver.

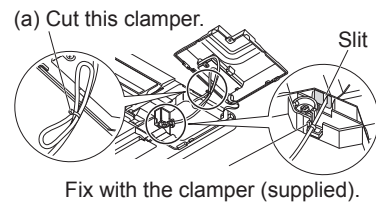
- Hang the string of the receiver on the pin of the ceiling panel.



- Pass the wiring from the wireless receiver section into the slit. (See "Wiring for the Receiver")

- Fix the wiring with the clamper (supplied) while leaving enough length of wiring to remove the receiver.

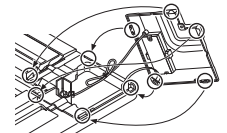
- When attaching the filter chamber, cut the clamper (a), and attach the receiver.



#### 4 Fix the receiver.

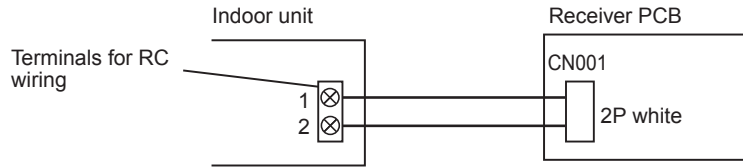
- Fit the receiver to the ceiling panel so the 5 claws are properly set, and fix it with the removed screw.

- Make sure the wire is not caught.
- Refer to the installation instructions supplied with the panel.



### 3. Wiring the Receiver

#### • Wiring Diagram



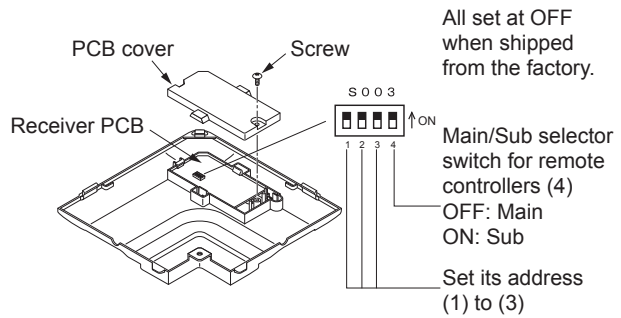
#### • How to Connect the Wires

- Connect the wires from the receiver to the terminals for RC wiring on the indoor unit. (No polarity)

### 4. Setting for receiver

- Check the settings of the [S003] DIP switch on the receiver's PCB.

\* Remove the cover from the receiver when performing the PCB settings.



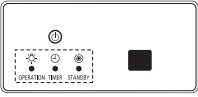

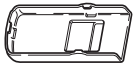
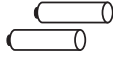




### 5. Setting Address Switches

- When more than 1 receiver is installed in the same room, setting addresses prevents interference.
- For how to change addresses of wireless remote controllers, see the operating instructions of wireless remote controllers.
- To change the receiver's address, remove the cover from the receiver's PCB and set No.1 to No.3 of the [003] DIP switch on PCB.

Remote Controller Address Display	Address	Address	Address	Address	Address	Address	Address	ON/OFF States
	<b>ALL</b>	<b>1</b>	<b>2</b>	<b>3</b>	<b>4</b>	<b>5</b>	<b>6</b>	
Position of the receiver's address switch	Receipt is possible at all of the address positions							

## 8-16. CZ-RWST3N

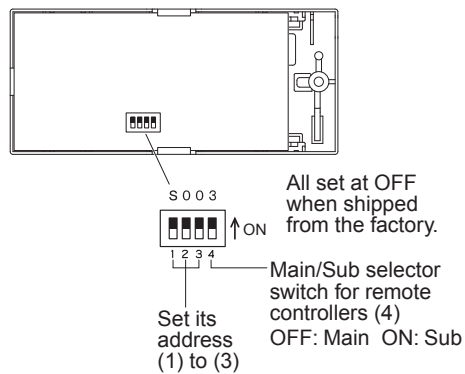
### 1. Part Names

Supplied accessories							
<b>Receiver</b> (1) 	<b>Wireless Remote Controller</b> (1) 	<b>Remote Controller Holder</b> (1) 	<b>LR03 Size Battery</b> (2) 	<b>Operating Instructions</b> (1) 	<b>Quick Reference</b> (1) 	<b>Wood Screw M4 x 16</b> (2) 	<b>Clamper</b> (1) 

### 2. Settings

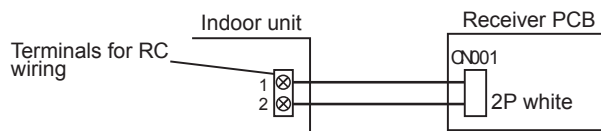
- Before installing the receiver, see the sections on "Wiring for the Receiver" and "Setting Address Switches". Then check the settings of the [S003] DIP switch on the receiver's PCB.

\* Remove the cover from the receiver when performing the PCB settings.



### 3. Wiring for the Receiver

#### Wiring Diagram



#### How to Connect the Wires

Connect the wires from the receiver to the terminals for RC wiring on the indoor unit. (No polarity)

## 4. Installing the Receiver

### ● Ceiling Suspended Model

- (1) Remove the screw, and slide the latch to open the air-intake grille. (Fig. 8-1)
- (2) Insert a flat-head screwdriver from the side, and remove the cover while pressing down on the two cover tabs. (Fig. 8-2)
- (3) Route the remote control wiring through the panel, and mount the receiver into the panel holes. (Fig. 8-3)
- (4) Route the remote control wiring through the adjustable clamber, and draw in the wire from the remote control wiring inlet to the inside of the indoor unit. (Fig. 8-3) (See Fig. 8-4 for how to loosen the adjustable clamber.)
- (5) Route the remote control wiring through the three saddles, and draw the wire into the electrical box. (Fig. 8-4)
  - \* Draw in the power wire and remote control wiring separately.
- (6) Connect the remote control wiring to the terminal board, route through the cable tie (accessory) to the holding clamp, and secure the remote control wiring. (Fig. 8-5)
- (7) Mount the side cover, and close the air-intake grille.

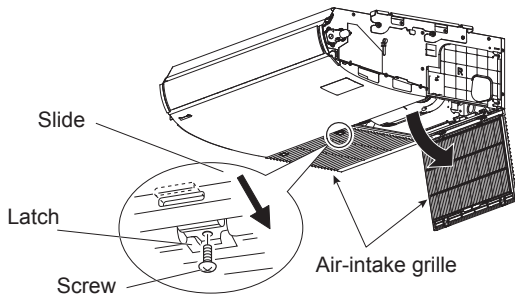


Fig. 8-1

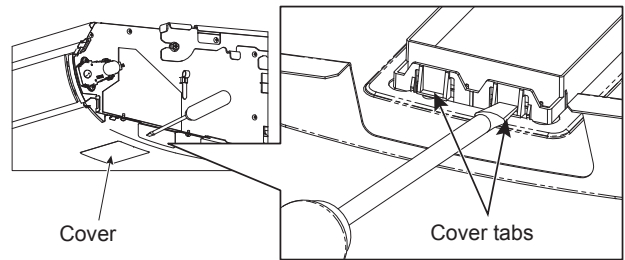


Fig. 8-2

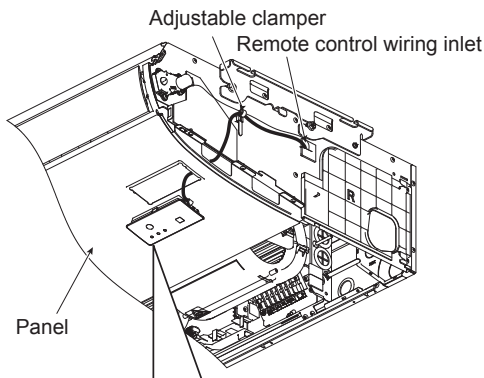


Fig. 8-3

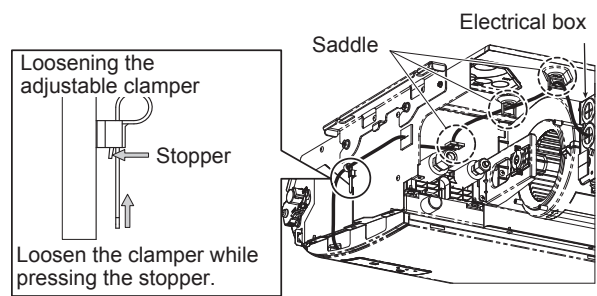


Fig. 8-4

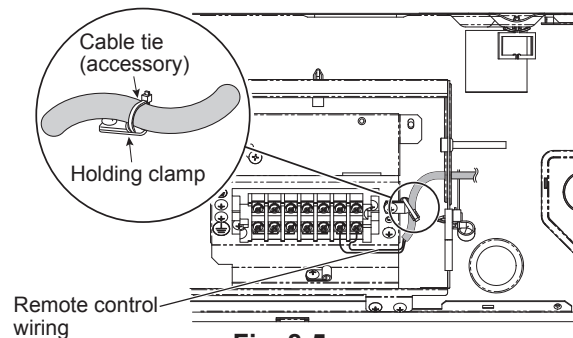
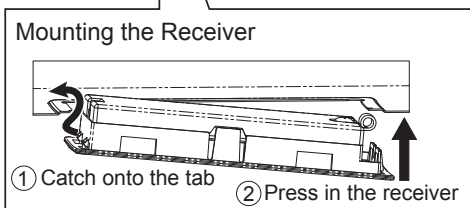


Fig. 8-5

### ● Removing and Mounting the Side Cover

#### Removing the side cover

Remove the side cover mounting screw, and slide the side cover to the front side (direction of arrow in Fig. 8-6) to remove.

#### Mounting the side cover

Slide in the side cover from the indoor unit front side, mount to the latch tabs, and secure using the side cover mounting screw.

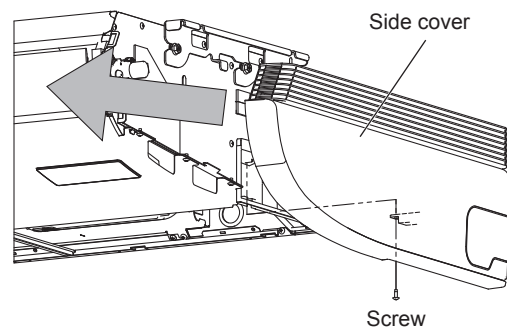
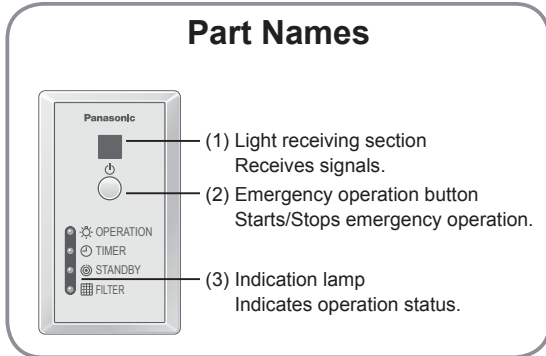


Fig. 8-6

## 8-17. CZ-RWSC3

### Installation Instructions Wireless Receiver for ALL



## Safety Precautions

### Read before installation

- Read the Installation Instructions carefully to install the unit correctly and safely.  
Be sure to read the Safety Precautions in particular before installation.
- After the installation is complete, perform test operation to confirm that no abnormality is present.

#### **WARNING**

This symbol refers to a hazard or unsafe practice which can result in severe personal injury or death.

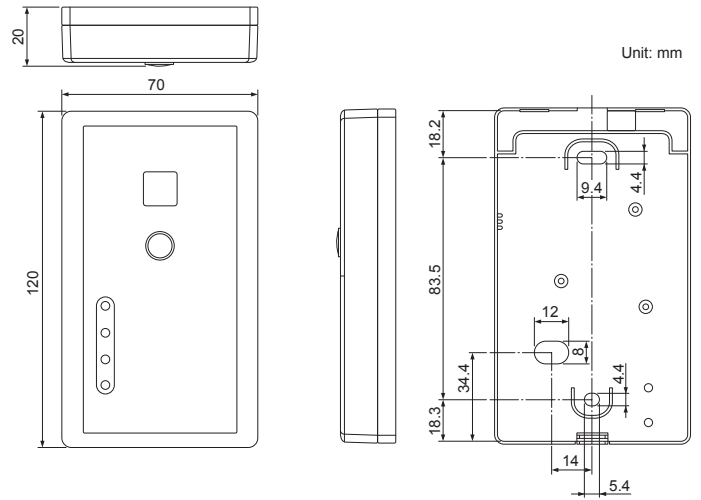
#### **WARNING**

- Turn off the circuit breaker of the units before installation.
- Ask your dealer or professionals for installation and electric work.
- This receiver shall be installed in accordance with National Wiring Regulations.
- Securely connect and fix the specified cables for wiring.
- Do not allow the connection to be exposed to the external force of the cables.
- Choose an installation location that sufficiently supports the weight of the receiver.

### 1. Accessories

Supplied accessories	
Wood screw M4 × 15.5 (2) 	Clamper (1) 

## Dimensions



- We assume no responsibility for accidents or damages resulting from methods other than those described in the installation instructions or methods without using specified parts.  
Malfunctions that occurred due to the unauthorised installation methods are not covered by the product warranty.
- Read the installation instructions supplied with indoor units as well.

#### **CAUTION**

This symbol refers to a hazard or unsafe practice which can result in personal injury or product or property damage.

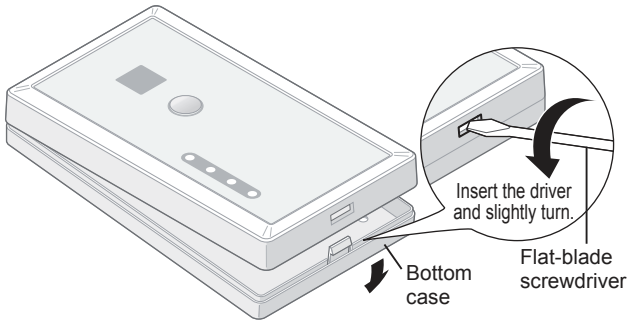
#### **CAUTION**

- Do not use at the following locations.
  - Location where condensation occurs
  - Location where flammable gases, etc. may leak
  - Location where corrosive gases, etc. may leak
  - Location with lots of water or oil droplets (including machine oil)
  - Location where voltage fluctuation frequently occurs
  - Location where there is a machine producing electromagnetic radiation
  - Location where droplets of organic solvents spread  
Location where acidic or alkaline solutions or special sprays are frequently used
- Do not operate with wet hands.
- **Do not wash with water.**



## 2. Installing the Receiver

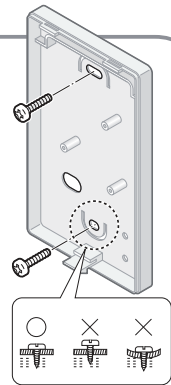
### 1 Remove the bottom case.



### Attention

#### Mounting the bottom case

- Tighten the screws securely until the screw heads touch the bottom case. (Otherwise, loose screw heads may hit the PCB and cause malfunction when mounting the top case.)
- Do not over-tighten the screws. (The bottom case may be deformed, resulting in fall of the unit.)



#### Connecting the remote controller wiring

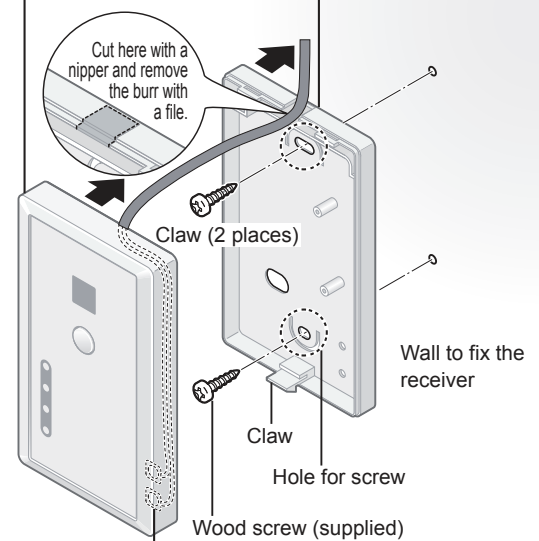
- Arrange the wires as shown in the illustration for ② in step 2, avoiding unnecessary wires being stored in the case. (Caught wires may destroy the PCB.)
- Avoid wires touching parts on the PCB. (Caught wires may destroy the PCB.)

### 2 Mount to the wall.

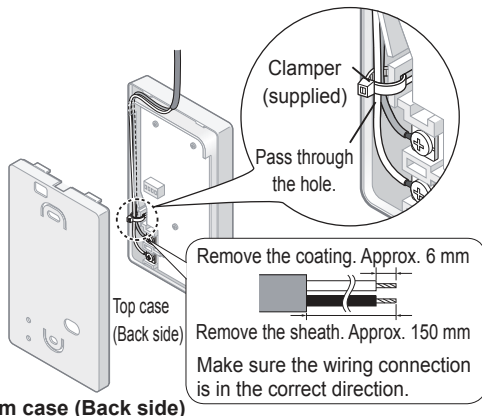
#### Exposed type

Preparation: Make 2 holes for screws using a driver.

- Mount the top case.
  - Align the claws of the top case and then align the claws of the bottom case.
- Mount the bottom case to the wall.



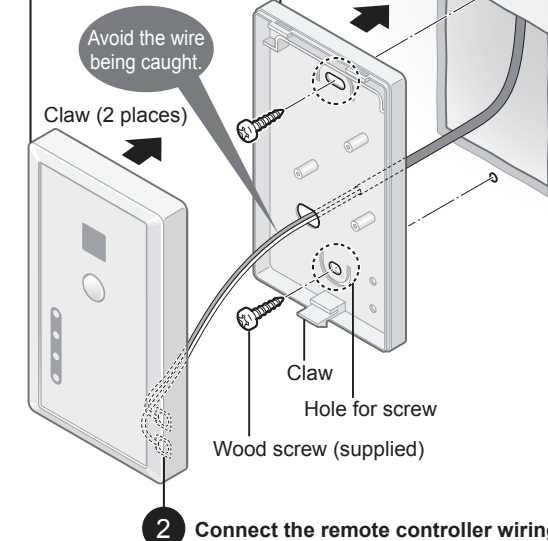
- Connect the remote controller wiring.
  - Arrange the wires along the groove of the case.



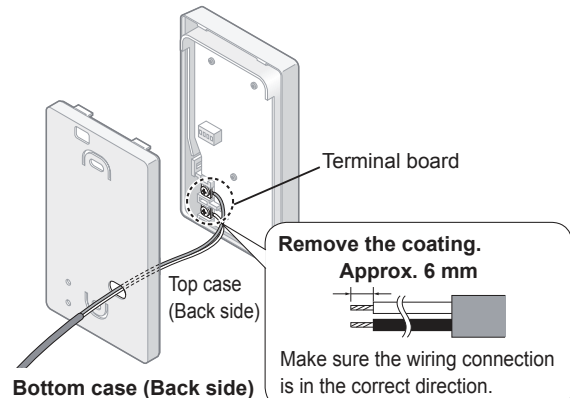
#### Embedded type

Preparation: Make 2 holes for screws using a driver.

- Mount the top case.
  - Align the claws of the top case and then align the claws of the bottom case.
- Mount the bottom case to the wall.
  - Pass the wire through the hole in the centre of the bottom case.



- Connect the remote controller wiring.



### 3. Wiring the Receiver

#### Wiring for the receiver

■ **Wiring diagram**

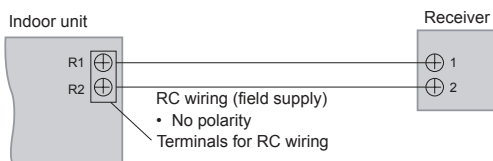
■ **Type of wiring**

Use cables of 0.5 to 1.25 mm<sup>2</sup>.

■ **Total wire length:** 400 m or less  
(The wire length between indoor units should be 200 m or less.)

■ **Number of connectable units**

Remote controller and receiver: Max. 2, Indoor unit: Max. 8

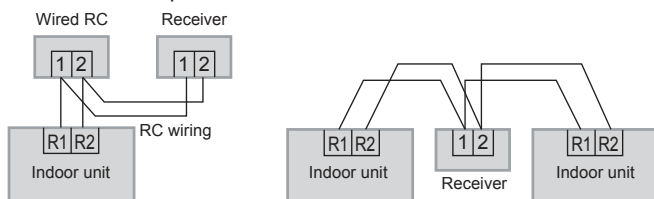


#### Attention

- Be careful not to connect cables to other terminals of indoor units (e.g. power source wiring terminal). Malfunction may occur.
- Do not bundle together with the power source wiring or store in the same metal tube. Operation error may occur.
- If noise is induced to the unit power supply, attach a noise filter.

- For the RC wiring of field supply, please use insulated wires with sheath. The insulation thickness should be at least 1 mm.
- Regulations on wire diameters differ from locality to locality. For field wiring rules, please refer to your LOCAL ELECTRICAL CODES before beginning.
- You must ensure that installation complies with all relevant rules and regulations.

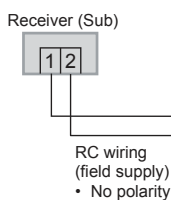
\*Wiring as shown below is prohibited.



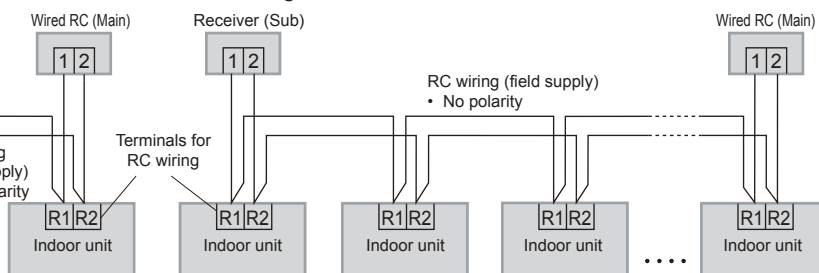
#### Installation when setting Main/Sub for the remote controller and the receiver

■ **Using 1 indoor unit**

Installation example



■ **Using more than 1 indoor unit**



After installation, according to the "Main/Sub setting" in the "Setting" section, set one to [Main] and the other to [Sub].  
Setting the wired remote controller to [Main] is recommended.

**Note**

The remote controller and the receiver can be connected to any indoor unit for operation.

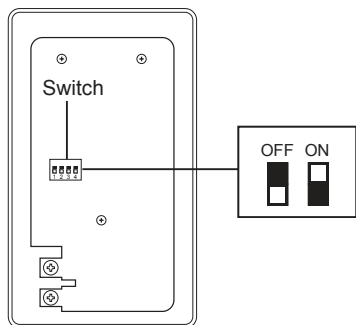
### Specifications

Model No.	CZ-RWSC3
Dimensions	(H) 120 mm × (W) 70 mm × (D) 20 mm
Weight	75 g
Temperature/Humidity range	0 °C to 40 °C / 20 % to 80 % (No condensation) *Indoor use only.
Power Source	DC16 V (supplied from indoor unit)

## 4. Setting Address Switches

- Main/Sub setting
- Address setting

Remove the top case of the receiver for setting.



### Main/Sub setting

- Use this to set Main/Sub for the remote controller and the receiver.
- Set one to [Main] and the other to [Sub].
- Factory default: [Main]
- It is recommended to set the wired remote controller to [Main].

Main/Sub	MAIN	SUB
Main/Sub switch position	 1 2 3 4	 1 2 3 4

### Address setting

- When more than 1 receiver is installed in the same room, setting addresses prevents interference.
- For how to change addresses of wireless remote controllers, see operating instructions of wireless remote controllers.

Wireless remote controller address display	Address	Address	Address	Address	Address	Address	Address
	<b>ALL</b>	<b>1</b>	<b>2</b>	<b>3</b>	<b>4</b>	<b>5</b>	<b>6</b>
Address switch position	Receiving is possible at all address positions.						
		1 2 3 4	1 2 3 4	1 2 3 4	1 2 3 4	1 2 3 4	1 2 3 4

## 5. Test operation

Preparation : Turn on the circuit breaker of units and then turn the power on. After the power is turned on, remote controller operation is ignored for approx. 1 minute because setting is being made. This is not malfunction. (Contents received while setting are disabled.)

1. To start test operation, press and hold the emergency operation button for 10 seconds.
2. The indication lamps (OPERATION, TIMER, STANDBY) blink during test operation.
3. To finish test operation, press and hold the emergency operation button for 10 seconds.

### Attention

- Do not use this mode for purposes other than the test operation. (To prevent overload of the units)
- Read the installation instructions supplied with the units.
- Any of the Heat, Cool and Fan operations can only be performed.
- Temperature cannot be changed.
- The test operation mode is automatically turned off in 60 minutes. (To prevent continuous test operation)
- Outdoor units do not operate for approx. 3 minutes after the power is turned on or operation is stopped.

### Self-diagnostics table and detected contents

- The "Alarm Display" as shown in the table below expresses the alarm contents displayed when the wired remote controller is connected. For how to handle the alarms, see installation instructions of indoor units or technical guide.

Detected contents	Alarm Display	Indication lamp on the receiver			
		OPERATION	TIMER	STANDBY	Blinking
Communication error in the remote controller circuit	E01–E03, E08–E14, E17, E18	□	●	●	
Communication error either in the in/outdoor operation line or the sub-bus of the outdoor unit	E04–E07, E15, E16, E19–E31	●	●	□	
Operation of indoor protection device	P01, P09–P14	●	□	□	Alternately
Operation of outdoor protection device	P02–P08, P15–P31	□	●	□	Alternately
Error in the indoor thermistor	F01–F03, F10–F11	□	□	●	Alternately
Error in the outdoor thermistor	F04–F09, F12–F28	□	□	○	Alternately
Error in the indoor EEPROM	F29	□	□	●	Simultaneously
Error in the outdoor EEPROM	F30, F31	□	□	○	Simultaneously
Error related to the compressor	H01–H31	●	□	●	
Error in indoor settings	L01–L03, L05–L09	□	●	□	Simultaneously
Error in outdoor settings	L04, L10–L31	□	○	□	Simultaneously
Inconsistency in Air/Heat (Including an auto-temp setting for a model without auto-temp settings)		○	□	□	Alternately
Oil Alarm (Same as operation of outdoor protection device)		□	●	□	Alternately
Test operation		□	□	□	Simultaneously

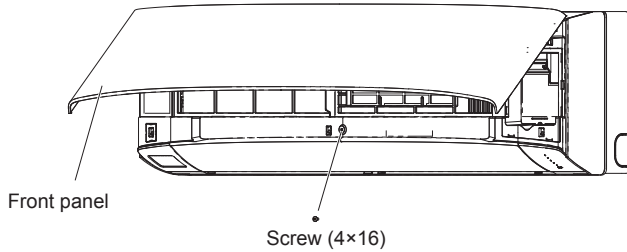
●: OFF ○: ON (Illuminated) □: Blinking (0.5 seconds interval)

## 8-18. Type K2

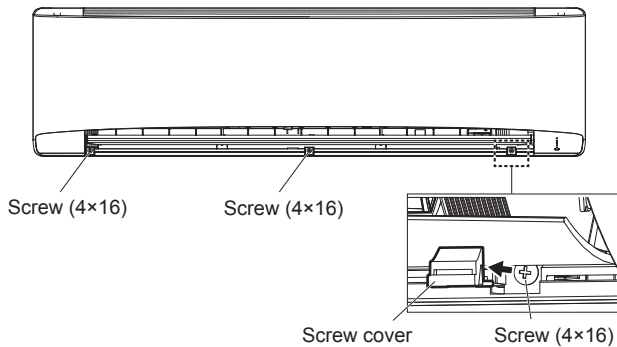
### When Using Wireless Remote Controller Instead of Wired Remote Controller

<Optional parts setting and wiring>

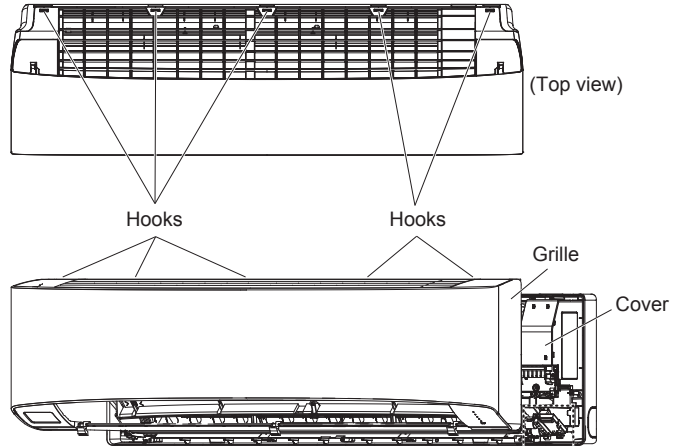
- (1) Open the front panel and remove the screw (×1).  
Then close the panel.



- (2) Open the flap and disengage the screw covers (×3).  
Then remove the screws (×3).



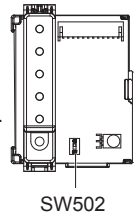
- (3) Disengage the hooks holding and lifting both ends of the grille.  
Remove the cover of electrical component box.



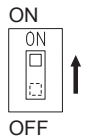
<When Using Wireless Remote Controller  
Instead of Wired Remote Controller>

When the wireless remote controller is to be  
used, slide the switch (SW502) to the ON position.

If this setting is not made, an alarm will occur.  
(The operation lamp on the display blinks.)



Setting status
ON: Wireless: main, Wired: sub
OFF: Wired: main, Wireless: sub (at shipment)



## 8-19. Common to All Models

### 1. The Self-Diagnosis Function Display and What is Detected

Alarm Display in the table below indicates the content of alarms that are displayed when a wired remote controller is connected. For information on how to deal with the alarms, refer to the Mounting Instructions for the indoor unit or to Test Run or servicing materials.

Error Detected	Alarm Display	WL Remote Controller LED Display			
		Run	Timer	Standby	Blinking
Communication error in the remote controller circuit	E01–E03, E08–E14, E17, E18	⊙	●	●	
Communication error either in the in/outdoor operation line or the sub-bus of the outdoor unit	E04–E07, E15, E16, E19–E31	●	●	⊙	
Operation of indoor protection device	P01, P09–P14	●	⊙	⊙	Alternately
Operation of outdoor protection device	P02–P08, P15–P31	⊙	●	⊙	Alternately
Error in the indoor thermistor	F01–F03, F10–F11	⊙	⊙	●	Alternately
Error in the outdoor thermistor	F04–F09, F12–F28	⊙	⊙	○	Alternately
Error in the indoor EEPROM	F29	⊙	⊙	●	Simultaneously
Error in the outdoor EEPROM	F30, F31	⊙	⊙	○	Simultaneously
Error related to the compressor	H01–H31	●	⊙	●	
Error in indoor settings	L01–L03 L05–L09	⊙	●	⊙	Simultaneously
Error in outdoor settings	L04, L10–L31	⊙	○	⊙	Simultaneously
Inconsistency in Air/Heat (Including an auto-temp setting for a model without auto-temp settings)		○	⊙	⊙	Alternately
Oil Alarm (Same as operation of outdoor protection device)		⊙	●	⊙	Alternately
Test Run		⊙	⊙	⊙	Simultaneously

● : Off / ○ : On / ⊙ : Blinking (0.5 sec. intervals)

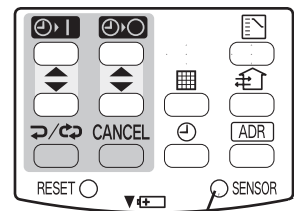
### 2. Room Temperature Sensor Settings

#### Common to All Models

- The indoor unit and the wireless remote controller are equipped with indoor temperature sensors. The sensing of indoor temperature works via one of them.
- When the unit is shipped, it is set to the indoor unit, but to switch to the remote controller, press the sensor button (diagram at right) inside the remote controller's cover and then check to make sure that Main Sensor on the LCD screen goes off.

#### NOTE

Even when the Sensor switch has been set to the remote controller, if the unit does not receive any room temperature data from the remote controller for ten minutes, it automatically switches back to the indoor unit sensor, so be sure to install the remote controller facing the receiver.



Sensor Button

Fig. 8-7

### 3. Setting Up Remote Controller Functions

The functions of the wireless remote controller can be set on site.

(These settings are saved in nonvolatile memory in the remote controller, so even when its batteries are changed, the settings do not revert to the defaults.)

#### NOTE

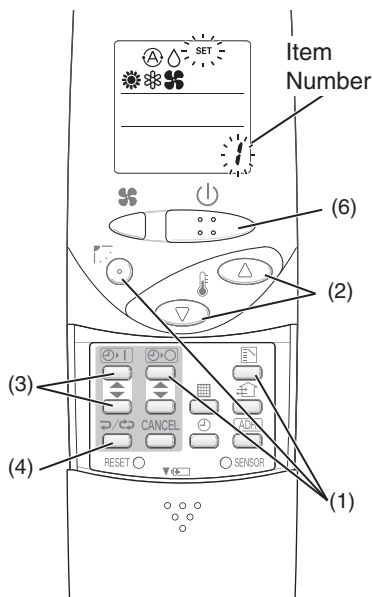
The operation of the air conditioner can be impacted, depending on the settings made, so only service personnel should make the settings.

Furthermore, making changes to these settings may cause actual operation to deviate from what is printed in the Users Manual, so be sure to explain this to the customer fully.

#### Making Settings (Do with unit stopped)

- (1) Holding down the Swing/Wind Direction + OFF Timer + Mode Select buttons at the same time for 4 or more seconds makes the Display switch to the setting screen. (See diagram below.)
- (2) Use the Temperature setting buttons, / , to select the number of the item to be set.
- (3) Use the ON Timer buttons, / , to change settings.
- (4) The settings are saved with the Once/Every Day button. When this is done, the settings display of the LCD changes from blinking to light.
- (5) If other settings are to be changed as well, repeat steps 2 to 4.
- (6) When all settings have been made, press the Start/Stop button.

#### Example: Operation mode setting screen



Item Number & Setting Item	Setting Content	Setting when Shipped
1 Operation Mode	→  →  → →  →  →	
2 Flap Display	→  →  → (No Display) (Note 1)	
3 Select Fan Speed	→  →  → (No Display)	
4 Display of Set Temperature	°C → °F → Setting Off (Note 2)	°C
5 Time Display	24 Hour (No Display) → AM/PM	24 Hour
6 Ventilation Fan ON/OFF	Off (No Display) → On	OFF (Note 3)
7 Cool temp Max	05 – 35°C	30
8 Cool temp Min	05 – 35°C	18
9 Heat temp Max	05 – 35°C	26 (Note 4)
10 Heat temp Min	05 – 35°C	16
11 Dry temp Max	05 – 35°C	30
12 Dry temp Min	05 – 35°C	18
13 Auto temp Max	05 – 35°C	27
14 Auto temp Min	05 – 35°C	17
16 Address Setting Max Value	00 (ALL only) → 01 – 31	06 (Note 5)
17 Heat temp Max ON/OFF	JP (Heater Max Temp Change Off) → EP (On)	JP

#### NOTE

- (1) While the unit is in the swinging mode (Swing/Wind Direction), the flap cannot be stopped in a desired position.
- (2) When Setting OFF is selected, "°C" is displayed on the LCD screen.
- (3) You can toggle between ON and OFF by pressing Ventilation for 4 seconds or more.
- (4) If the Heater Max ON/OFF setting is not changed to EP (ON), the setting change will not be reflected.
- (5) This is the number of addresses that can be set in the address change mode. Do not set it to 07 or above.

