

TEST RUN SERVICE MANUAL

2WAY SYSTEM

R410A



Model No. Outdoor Unit

Class		8HP	10HP	12HP	14HP	16HP	18HP	20HP
ME1	Model Name	U-8ME1E8	U-10ME1E8	U-12ME1E8	U-14ME1E8	U-16ME1E8	U-18ME1E8	U-20ME1E8
		U-8ME1E8E	U-10ME1E8E	U-12ME1E8E	U-14ME1E8E	U-16ME1E8E	U-18ME1E8E	U-20ME1E8E

Indoor Unit

Class		22	28	36	45	56	73	90	106	140	160
U1	4-Way Cassette	S-22MU1E5	S-28MU1E5	S-36MU1E5	S-45MU1E5	S-56MU1E5	S-73MU1E5		S-106MU1E5	S-140MU1E5	S-160MU1E5
Y1	4-Way Cassette 60×60	S-22MY1E5	S-28MY1E5	S-36MY1E5	S-45MY1E5	S-56MY1E5					
L1	2-Way Cassette	S-22ML1E5	S-28ML1E5	S-36ML1E5	S-45ML1E5	S-56ML1E5	S-73ML1E5				
D1	1-Way Cassette		S-28MD1E5	S-36MD1E5	S-45MD1E5	S-56MD1E5	S-73MD1E5				
F1	Low Silhouette Ducted	S-22MF1E5	S-28MF1E5	S-36MF1E5	S-45MF1E5	S-56MF1E5	S-73MF1E5	S-90MF1E5	S-106MF1E5	S-140MF1E5	S-160MF1E5
M1	Slim Low Static Ducted	S-22MM1E5	S-28MM1E5	S-36MM1E5	S-45MM1E5	S-56MM1E5					
T1	Ceiling			S-36MT1E5	S-45MT1E5	S-56MT1E5	S-73MT1E5		S-106MT1E5	S-140MT1E5	
K1	Wall Mounted	S-22MK1E5	S-28MK1E5	S-36MK1E5	S-45MK1E5	S-56MK1E5	S-73MK1E5		S-106MK1E5		
R1	Concealed Floor Standing	S-22MR1E5	S-28MR1E5	S-36MR1E5	S-45MR1E5	S-56MR1E5	S-71MR1E5				
P1	Floor Standing	S-22MP1E5	S-28MP1E5	S-36MP1E5	S-45MP1E5	S-56MP1E5	S-71MP1E5				

Class		73	106	140	224	280
E1	High Static Pressure Ducted	S-73ME1E5	S-106ME1E5	S-140ME1E5	S-224ME1E5	S-280ME1E5

IMPORTANT!

Please Read Before Starting

This air conditioning system meets strict safety and operating standards. As the installer or service person, it is an important part of your job to install or service the system so it operates safely and efficiently.

For safe installation and trouble-free operation, you must:

- Carefully read this instruction booklet before beginning.
- Follow each installation or repair step exactly as shown.
- Observe all local, state, and national electrical codes.
- This product is intended for professional use. Permission from the power supplier is required when installing the U-8ME1E8 (E) outdoor unit that is connected to a 16 A distribution network.
- This equipment complies with EN/IEC 61000-3-12 provided that the short-circuit power S_{sc} is greater than or equals to the values corresponding to each model as shown in the table below at the interface point between the user's supply and the public system. It is the responsibility of the installer or user of the equipment to ensure; by consultation with the distribution network operator if necessary that the equipment is connected only to supply with a short-circuit power S_{sc} greater than or equals to the values corresponding to each model as shown in the table below.

	U-10ME1E8(E)	U-12ME1E8(E)	U-14ME1E8(E)	U-16ME1E8(E)	U-18ME1E8(E)	U-20ME1E8(E)
S_{sc}	1,660 kW	1,660 kW	1,510 kW	1,510 kW	1,690 kW	1,690 kW

- This equipment complies with EN/IEC 61000-3-11 provided that the system impedance Z_{max} is less than or equals to the values corresponding to each model as shown in the table below at the interface point between the user's supply and the public system. Consult to the supply authority for the system impedance Z_{max} .

	U-10ME1E8(E)	U-12ME1E8(E)	U-14ME1E8(E)	U-16ME1E8(E)	U-18ME1E8(E)	U-20ME1E8(E)
Z_{max}	0.194 Ω	0.194 Ω	0.194 Ω	0.194 Ω	0.194 Ω	0.194 Ω

- Pay close attention to all warning and caution notices given in this manual.



WARNING

This symbol refers to a hazard or unsafe practice which can result in severe personal injury or death.



CAUTION

This symbol refers to a hazard or unsafe practice which can result in personal injury or product or property damage.

If Necessary, Get Help

These instructions are all you need for most installation sites and maintenance conditions. If you require help for a special problem, contact our sales/service outlet or your certified dealer for additional instructions.

In Case of Improper Installation

The manufacturer shall in no way be responsible for improper installation or maintenance service, including failure to follow the instructions in this document.

SPECIAL PRECAUTIONS

WARNING When Wiring



ELECTRICAL SHOCK CAN CAUSE SEVERE PERSONAL INJURY OR DEATH. ONLY A QUALIFIED, EXPERIENCED ELECTRICIAN SHOULD ATTEMPT TO WIRE THIS SYSTEM.

- Do not supply power to the unit until all wiring and tubing are completed or reconnected and checked.
- Highly dangerous electrical voltages are used in this system. Carefully refer to the wiring diagram and these instructions when wiring. Improper connections and inadequate grounding can cause **accidental injury or death**.
- **Ground the unit** following local electrical codes.
- Connect all wiring tightly. Loose wiring may cause overheating at connection points and a possible fire hazard.
- Provide a power outlet to be used exclusively for each unit, and a power supply disconnect, circuit breaker and earth leakage breaker for overcurrent protection should be provided in the exclusive line.
- Provide a power outlet exclusively for each unit, and full disconnection mean having a contact separation in all poles must be incorporated in the fixed wiring in accordance with the wiring rules.
- To prevent possible hazards from insulation failure, the unit must be grounded. 

When Transporting

Be careful when picking up and moving the indoor and outdoor units. Get a partner to help, and bend your knees when lifting to reduce strain on your back. Sharp edges or thin aluminum fins on the air conditioner can cut your fingers.

When Installing...

...In a Room

Properly insulate any tubing run inside a room to prevent "sweating" that can cause dripping and water damage to walls and floors.



CAUTION

Keep the fire alarm and the air outlet at least 1.5 m away from the unit.

...In Moist or Uneven Locations

Use a raised concrete pad or concrete blocks to provide a solid, level foundation for the outdoor unit. This prevents water damage and abnormal vibration.

...In an Area with High Winds

Securely anchor the outdoor unit down with bolts and a metal frame. Provide a suitable air baffle.

...In a Snowy Area (for Heat Pump-type Systems)

Install the outdoor unit on a raised platform that is higher than drifting snow. Provide snow vents.

When Connecting Refrigerant Tubing



WARNING

- When performing piping work do not mix air except for specified refrigerant (R410A) in refrigeration cycle. It causes capacity down, and risk of explosion and injury due to high tension inside the refrigerant cycle.
- Refrigerant gas leakage may cause fire.
- Ventilate the room well, in the event that is refrigerant gas leaks during the installation. Be careful not to allow contact of the refrigerant gas with a flame as this will cause the generation of poisonous gas.
- Keep all tubing runs as short as possible.
- Use the flare method for connecting tubing.
- Apply refrigerant lubricant to the matching surfaces of the flare and union tubes before connecting them, then tighten the nut with a torque wrench for a leak-free connection.
- Check carefully for leaks before starting the test run.
- Do not leak refrigerant while piping work for an installation or re-installation, and while repairing refrigeration parts.
Handle liquid refrigerant carefully as it may cause frostbite.

When Servicing



WARNING

- Turn the power OFF at the main power box (mains) before opening the unit to check or repair electrical parts and wiring. 
- Keep your fingers and clothing away from any moving parts.
- Clean up the site after you finish, remembering to check that no metal scraps or bits of wiring have been left inside the unit being serviced.





CAUTION

- Do not clean inside the indoor and outdoor units by users. Engage authorized dealer or specialist for cleaning.
- In case of malfunction of this appliance, do not repair by yourself. Contact the sales dealer or service dealer for repair.
- Do not touch the air inlet or the sharp aluminum fins of the outdoor unit. 
- Ventilate any enclosed areas when installing or testing the refrigeration system. Escaped refrigerant gas, on contact with fire or heat, can produce dangerously toxic gas.
- Confirm after installation that no refrigerant gas is leaking. If the gas comes in contact with a burning stove, gas water heater, electric room heater or other heat source, it can cause the generation of poisonous gas.

Others



CAUTION

- Do not touch the air inlet or the sharp aluminum fins of the outdoor unit. You may hurt. 
- Do not sit or step on the unit, you may fall down accidentally. 
- Do not stick any object into the FAN CASE. You may be injured and the unit may be damaged. 



Check of Density Limit

The room in which the air conditioner is to be installed requires a design that in the event of refrigerant gas leaking out, its density will not exceed a set limit.

The refrigerant (R410A), which is used in the air conditioner, is safe, without the toxicity or combustibility of ammonia, and is not restricted by laws imposed to protect the ozone layer. However, since it contains more than air, it poses the risk of suffocation if its density should rise excessively. Suffocation from leakage of refrigerant is almost non-existent. With the recent increase in the number of high density buildings, however, the installation of multi air conditioner systems is on the increase because of the need for effective use of floor space, individual control, energy conservation by curtailing heat and carrying power, etc.

Most importantly, the multi air conditioner system is able to replenish a large amount of refrigerant compared to conventional individual air conditioners. If a single unit of the multi air conditioner system is to be installed in a small room, select a suitable model and installation procedure so that if the refrigerant accidentally leaks out, its density does not reach the limit (and in the event of an emergency, measures can be made before injury can occur).

In a room where the density may exceed the limit, create an opening with adjacent rooms, or install mechanical ventilation combined with a gas leak detection device. The density is as given below.

Total amount of refrigerant (kg)

$$\text{Min. volume of the indoor unit installed room (m}^3\text{)} \leq \text{Density limit (kg/m}^3\text{)}$$

The density limit of refrigerant which is used in multi air conditioners is 0.3 kg/m^3 (ISO 5149).

NOTE

1. If there are 2 or more refrigerating systems in a single refrigerating device, the amount of refrigerant should be as charged in each independent device.

For the amount of charge in this example:

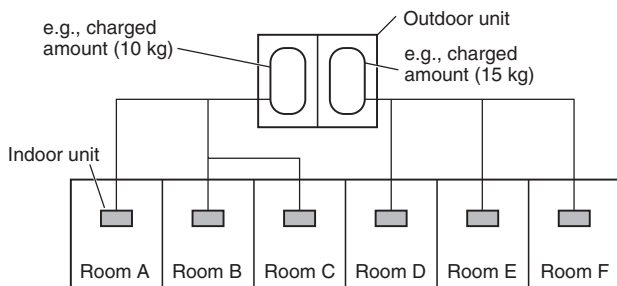

The possible amount of leaked refrigerant gas in rooms A, B and C is 10 kg.

The possible amount of leaked refrigerant gas in rooms D, E and F is 15 kg.

- RoHS** · This product does not contain any hazardous substances prohibited by the RoHS Directive.
- WARNING** · You are requested to use RoHS compliant parts for maintenance or repair.

2. The standards for minimum room volume are as follows.

- (1) No partition (shaded portion)

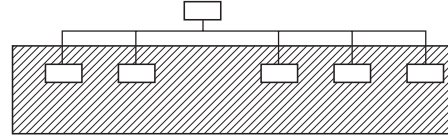

- (2) When there is an effective opening with the adjacent room for ventilation of leaking refrigerant gas (opening without a door, or an opening 0.15% or larger than the respective floor spaces at the top or bottom of the door).

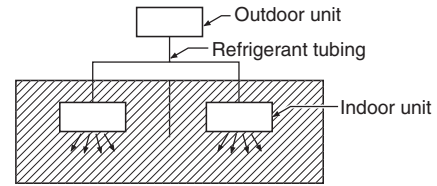

- (3) If an indoor unit is installed in each partitioned room and the refrigerant tubing is interconnected, the smallest room of course becomes the object. But when mechanical ventilation is installed interlocked with a gas leakage detector in the smallest room where the density limit is exceeded, the volume of the next smallest room becomes the object.

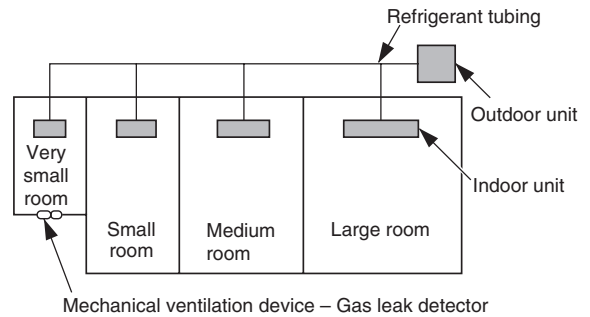

3. The minimum indoor floor space compared with the amount of refrigerant is roughly as follows: (When the ceiling is 2.7 m high)

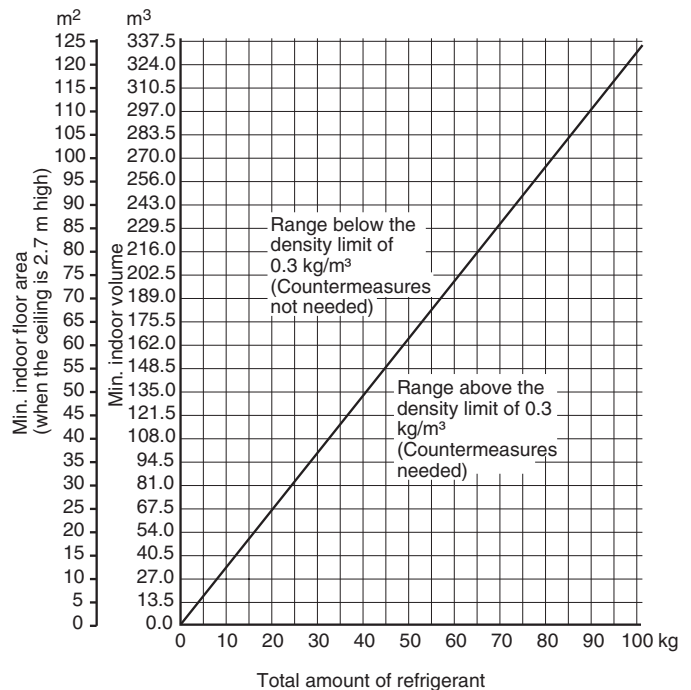

Contents

1. Address Settings	
(Outdoor Units)	1-1
1. Test Run.....	1-2
2. Settings of Indoor Unit Control PCB	1-3
3. Auto Address Setting	1-5
2. Remote Controller Functions	2-1
1. Remote Controller Test Run Settings.....	2-2
2. Simple Settings Function	2-3
3. Detailed Settings Function.....	2-5
4. Remote Controller Servicing Functions	2-13
3. Trouble Diagnosis	3-1
1. Contents of Remote Controller Switch Alarm Display.....	3-2
2. Outdoor Unit Control PCB LED Display	3-4
3. 2WAY Alarm Codes	3-5
4. Blinking (Inspection) Display on Remote Controller.....	3-26
5. Symptom: Thermostat in OFF continues or cycles OFF & ON too frequently ...	3-28
4. PCB Settings	4-1
1. Outdoor Unit Control PCB.....	4-2
5. Self-Diagnostics Function Table	5-1
1. Self-Diagnostics Function Table.....	5-2
6. Service Checker	6-1
1. Outdoor Unit Maintenance Remote Controller.....	6-2

– MEMO –

Contents

**1. Address Settings
(Outdoor Units)**

1. Test Run.....1-2
2. Settings of Indoor Unit Control PCB.....1-3
3. Auto Address Setting.....1-5





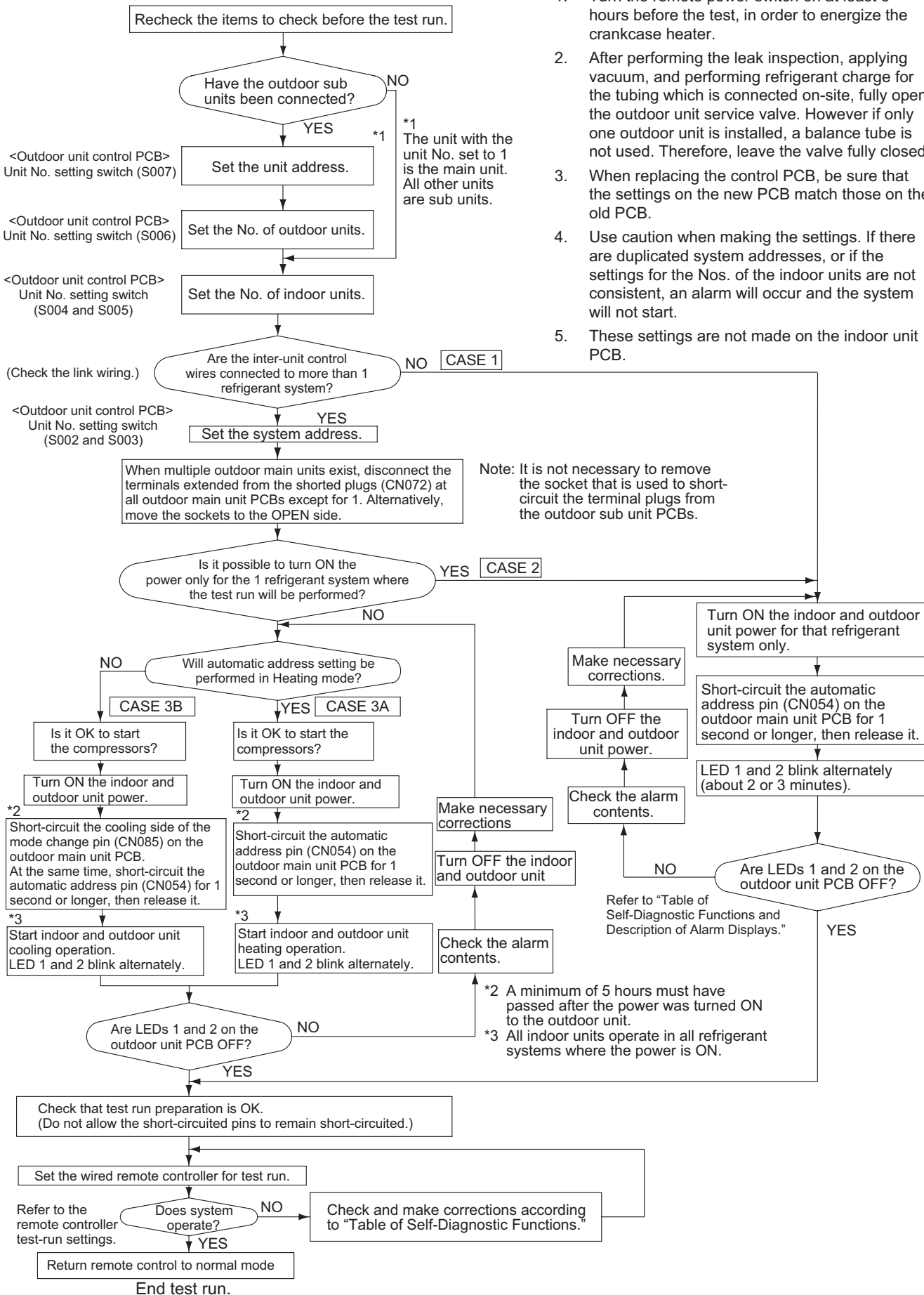









1. Test Run

Test Run Procedure





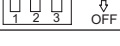





2. Settings of Indoor Unit Control PCB

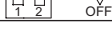

● Examples of the No. of indoor units settings (S005, S004)

No. of indoor units	Indoor unit setting (S005) (3P DIP switch, blue) 10 20 30	Indoor unit setting (S004) (Rotary switch, red)
1 unit (factory setting)	All OFF 	
11 units	1 ON 	 Set to 1
21 units	2 ON 	 Set to 1
31 units	3 ON 	 Set to 1
40 units	1 & 3 ON 	 Set to 0
58 units	2 & 3 ON 	 Set to 8
64 units	All ON 	 Set to 4

● Examples of refrigerant circuit (R.C.) address settings (required when link wiring is used) (S003,S002)

System address No.	System address (S003) (2P DIP switch, blue) 10 20	System address (S002) (Rotary switch, black)
System 1 (factory setting)	Both OFF 	 Set to 1
System 11	1 ON 	 Set to 1
System 21	2 ON 	 Set to 1
System 30	1 & 2 ON 	 Set to 0

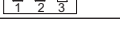

● Examples of the No. of outdoor units settings (S006)

No. of outdoor units	Outdoor unit setting (S006) (3P DIP switch, blue)
1 unit (factory setting)	1 ON 
2 units	2 ON 
3 units	1 & 2 ON 
4 units	3 ON 

● Address setting of main outdoor unit (S007)

Unit No. setting	Address setting of outdoor unit (S007) (3P DIP switch, blue)
Unit No. 1 (main unit) (factory setting)	

● Address setting of sub outdoor unit

Unit No. setting	Address setting of outdoor unit (S007) (3P DIP switch, blue)
Unit No. 2 (sub unit)	2 ON 
Unit No. 3 (sub unit)	1 & 2 ON 
Unit No. 4 (sub unit)	3 ON 

The sub unit control PCB contains the same switches as the main unit control PCB for No. of indoor units, No. of outdoor units, and system address. However it is not necessary to set these switches.

1

2. Settings of Indoor Unit Control PCB

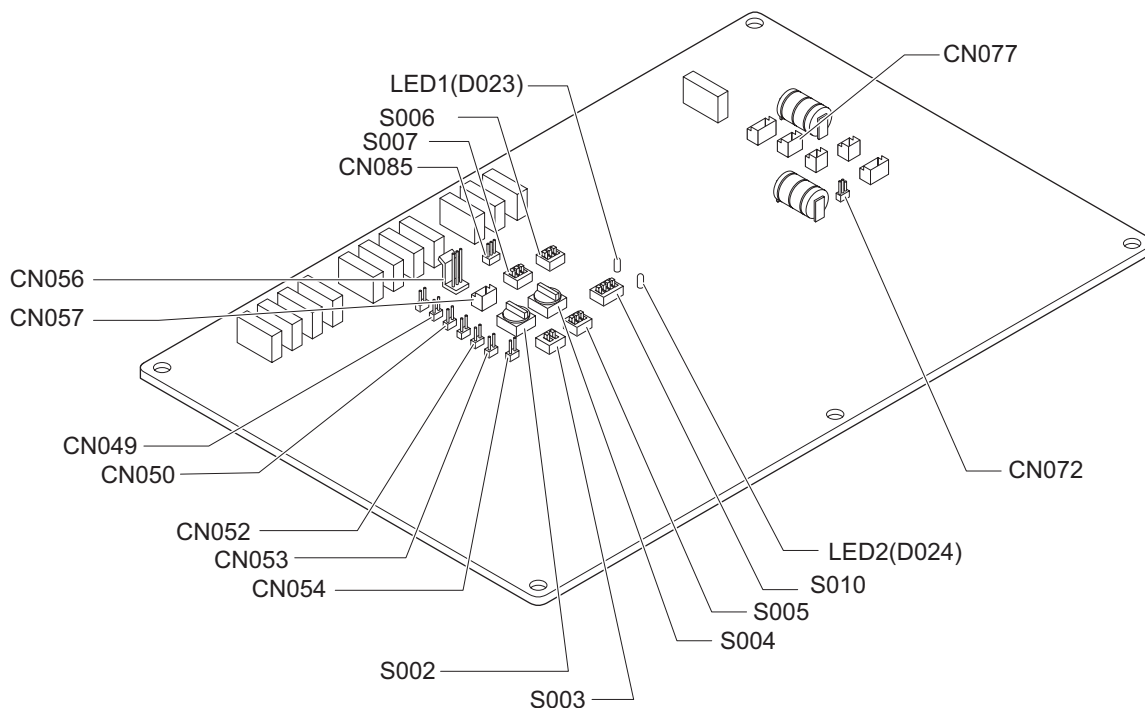

● Name And Function Of Each Switch On Outdoor Unit Control PC Board

<ul style="list-style-type: none"> • Mode Select switch (3P, Black) (CN085) 	Changes to the cooling or heating mode. (Main outdoor unit is only usable.)
<ul style="list-style-type: none"> <ul style="list-style-type: none"> • During normal drive 	When the cooling side is short-circuit, all indoor units change to cooling mode. When the heating side is short-circuit, changes to all heating mode.
<ul style="list-style-type: none"> • Auto Address pin (2P, White) (CN054) 	Short-circuit for 1 second or longer. → When opened, the auto address mode starts. When the short-circuit remains in effect for more than 1 second during auto address, the auto address is interrupted.
<ul style="list-style-type: none"> • CHK Pin (TestRun) (2P, White) (CN049) 	When set to short-circuit, changes to the test run mode. (The test run mode is automatically cancelled after an hour.) When short-circuit is cancelled, the test run mode is cancelled.
<ul style="list-style-type: none"> • RC socket (3P, Blue) (CN077) 	Connects to the outdoor unit maintenance remote control and the content of an alarm message will be checked.
<ul style="list-style-type: none"> • Run pin (2P, White) (CN052) 	When the pulse signal applied after short-circuit, all indoor units within the same series will be operated.
<ul style="list-style-type: none"> • Stop pin (2P, White) (CN053) 	When the pulse signal applied after short-circuit, all indoor units within the same series will be stopped. (When set to short-circuit, the remote control from the indoor unit can not be operated.)
<ul style="list-style-type: none"> • AP pin (Vacuum) (2P, White) (CN050) 	Used for vacuuming the outdoor unit.
Socket for Snow Area	
<ul style="list-style-type: none"> <ul style="list-style-type: none"> • Snow sensor (3P, Red) (CN057) 	Used for installing the snow sensor
Silent Socket	
<ul style="list-style-type: none"> <ul style="list-style-type: none"> • Socket for silent mode (2P, White) (CN056) 	Used for installing the external timer for the silent mode

3. Auto Address Setting

Auto Address Setting

Basic wiring diagram: Example (1)

- If link wiring is not used
(The inter-unit control wires are not connected to multiple refrigerant systems.)
Indoor unit addresses can be set without operating the compressors.

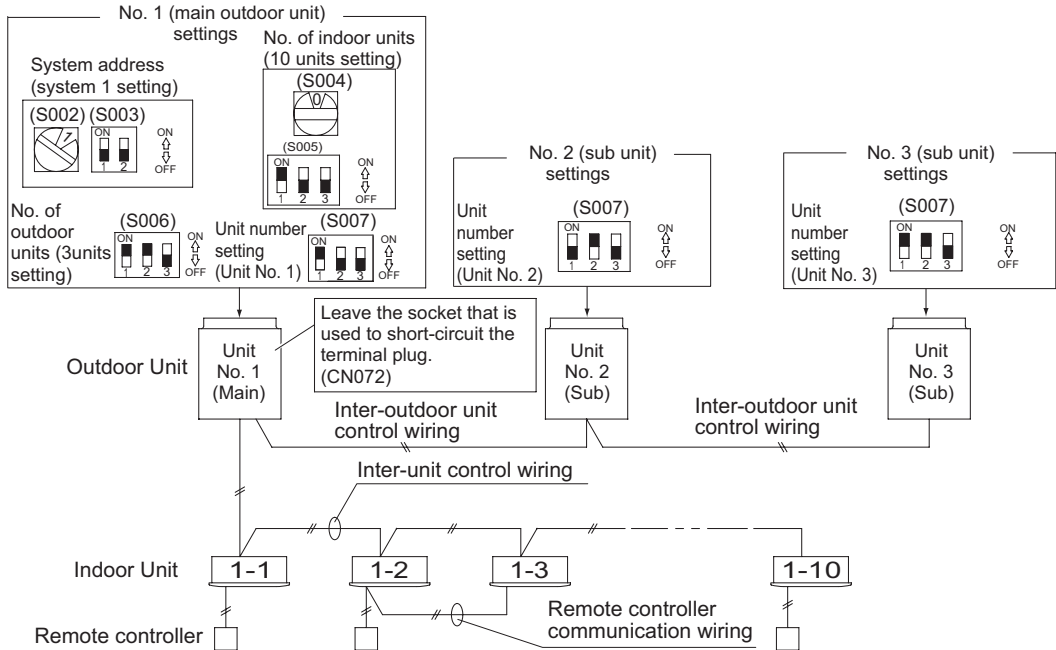

Case 1

(1) Automatic Address Setting from the Outdoor Unit

1. To set the number of outdoor units, on the outdoor main unit control PCB set the No. of outdoor units DIP switch (S006) to (3 units), and set the unit No. DIP switch (S007) to (unit No. 1 – main outdoor unit).

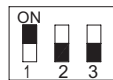
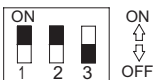

2. On the No. 2 (sub) unit control PCB, set the unit No. switch (S007) to (unit No. 2).

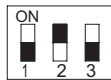

On the No. 3 (sub) unit control PCB, set the unit No. switch (S007) to (unit No. 3).

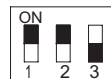

3. On the outdoor main unit control PCB, check that the system address rotary switch (S002) is set to “1” and that the DIP switch (S003) is set to “0.” (These are the settings at the time of factory shipment.)

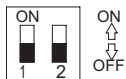

4. To set the number of indoor units that are connected to the outdoor unit to 10 on the outdoor main unit control PCB, set the No. of indoor units DIP switch (S005) to “1,” and set the rotary switch (S004) to “0.”



5. Turn ON the power to the indoor and outdoor units.
6. On the outdoor main unit control PCB, short-circuit the automatic address pin (CN054) for 1 second or longer, then release it.
↓
(Communication for automatic address setting begins.)
* To cancel, again short-circuit the automatic address pin (CN054) for 1 second or longer, then release it.
↓ The LED that indicates that automatic address setting is in progress turns OFF and the process is stopped.
Be sure to perform automatic address setting again.
(Automatic address setting is completed when LEDs 1 and 2 on the outdoor main unit control PCB turn OFF.)
↓
7. Operation from the remote controllers is now possible.
* To perform automatic address setting from the remote controller, perform steps 1 to 5, then use the remote controller and complete automatic address setting.

- Refer to “Automatic Address Setting from the Remote Controller.”



3. Auto Address Setting

Basic wiring diagram: Example (2)

• **If link wiring is used** * When multiple outdoor main units exist, remove the socket that is used to short-circuit the terminal plug (CN072) from all outdoor main unit PCBs except for one unit. Alternatively, move the sockets to the "OPEN" side.

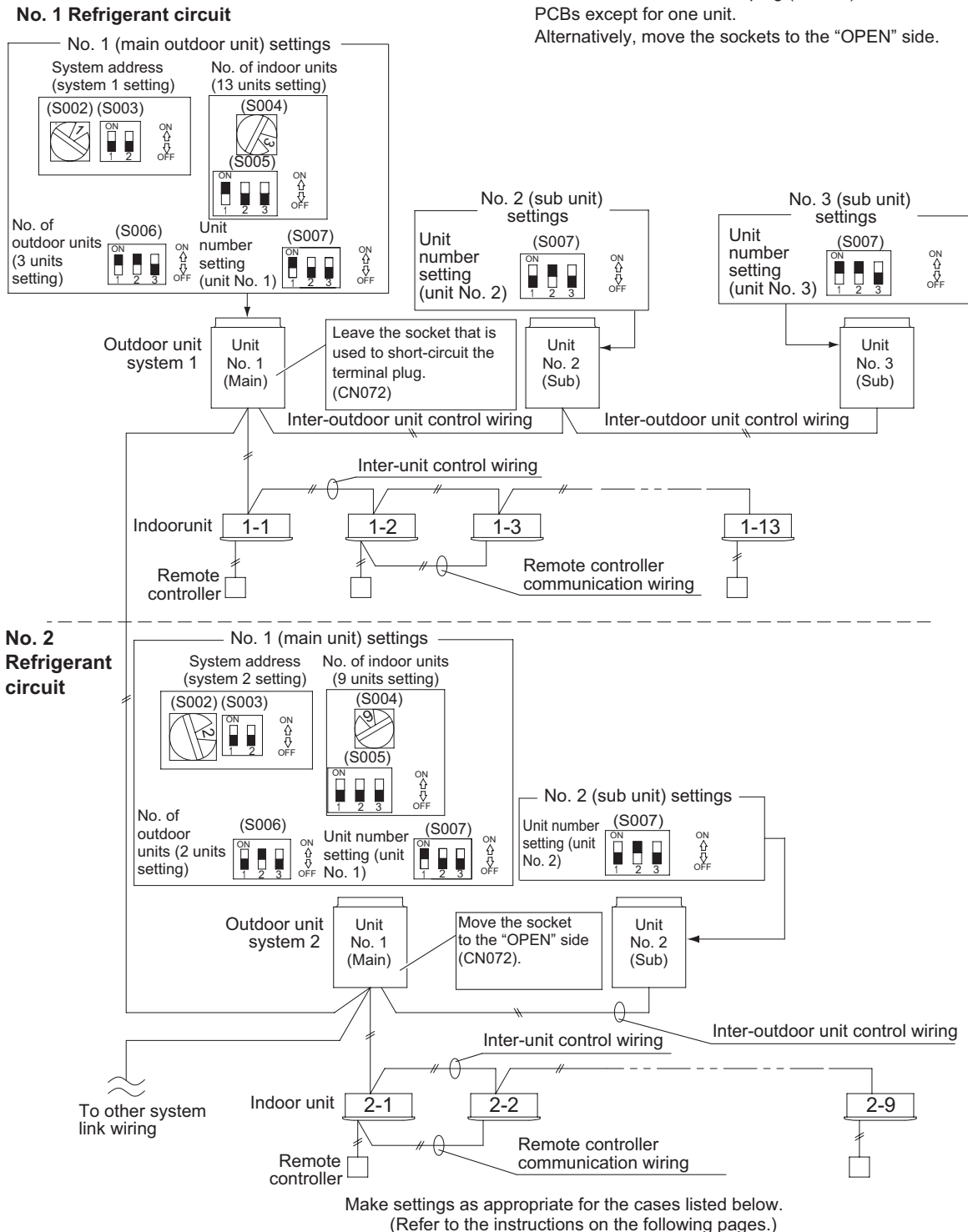

- Indoor and outdoor unit power can be turned ON for each system separately. → Case 2
- Indoor and outdoor unit power cannot be turned ON for each system separately.
 - Automatic address setting in Heating mode → Case 3A
 - Automatic address setting in Cooling mode → Case 3B

3. Auto Address Setting

Case 2 Automatic Address Setting (no compressor operation)

- Indoor and outdoor unit power can be turned ON for each system separately.

Indoor unit addresses can be set without operating the compressors.

Automatic Address Setting from Outdoor Unit

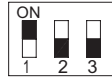
1. On the No. 1 (main) unit control PCB, set the unit No. switch (S007) to  (unit No. 1).

On the No. 2 (sub) unit control PCB, set the unit No. switch (S007) to  (unit No. 2).

On the No. 3 (sub) unit control PCB, set the unit No. switch (S007) to  (unit No. 3).

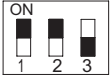
2. To set the number of outdoor units on the outdoor main unit control PCB, set the No. of outdoor units DIP switch (S006) to  (3 units).

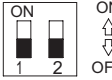
3. On the outdoor main unit control PCB, check that the system address rotary switch (S002) is set to "1" and that the DIP switch (S003) is set to "0" . (These are the settings at the time of factory shipment.)

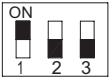
4. To set the number of indoor units that are connected to the outdoor unit to 13 on the outdoor main unit control PCB, set the No. of indoor units DIP switch (S005) to "1"  , and set the rotary switch (S004) to "3."

5. Turn on power to all indoor and outdoor units in the system.
6. Short-circuit the automatic address pin at the outdoor main unit (CN054) for 1 second or longer, then release it.

↓

(Communication for automatic address setting begins.)

* To cancel, again short-circuit the automatic address pin (CN054) for 1 second or longer, then release it. The LED that indicates automatic address setting is in progress turns OFF and the process is stopped. Be sure to perform automatic address setting again.

(Automatic address setting is completed when LEDs 1 and 2 on the outdoor main unit control PCB turn OFF.)

↓

7. Next turn the power ON only for the indoor and outdoor units of the next (different) system. Repeat steps 1 – 5 in the same way to complete automatic address settings for all systems.

↓

8. Operation from the remote controllers is now possible.

* To perform automatic address setting from the remote controller, perform steps 1 – 5, then use the remote controller and complete automatic address setting.

- Refer to "Automatic Address Setting from Remote Controller."

1

3. Auto Address Setting

Case 3A Automatic Address Setting in Heating Mode

- Indoor and outdoor unit power cannot be turned ON for each system separately.
In the following, automatic setting of indoor unit addresses is not possible if the compressors are not operating.
Therefore perform this process only after completing all refrigerant tubing work.

Automatic Address Setting from Outdoor Unit

1. Perform steps 1 – 4 in the same way as for **Case 2**.
5. Turn the indoor and outdoor unit power ON at all systems.
↓
6. To perform automatic address setting in **Heating mode**, on the outdoor main unit control PCB in the refrigerant system where you wish to set the addresses, short-circuit the automatic address pin (CN054) for 1 second or longer, then release it. (Be sure to perform this process for one system at a time. Automatic address settings cannot be performed for more than one system at the same time.)
↓

(Communication for automatic address setting begins, **the compressors turn ON, and automatic address setting in Heating mode begins.**)

(All indoor units operate.)

* To cancel, again short-circuit the automatic address pin (CN054) for 1 second or longer, then release it.

- ↓ The LED that indicates automatic address setting is in progress turns OFF and the process is stopped.
Be sure to perform automatic address setting again.

(Automatic address setting is completed when the compressors stop and LEDs 1 and 2 on the main unit control PCB turn OFF.)
↓

7. At the outdoor main unit in the next (different) system, short-circuit the automatic address pin (CN054) for 1 second or longer, then release it.
↓

(Repeat the same steps to complete automatic address setting for all units.)
↓

8. Operation from the remote controllers is now possible.
* To perform automatic address setting from the remote controller, perform steps 1 – 5, then use the remote controller and complete automatic address setting.
- Refer to “Automatic Address Setting from Remote Controller.”

3. Auto Address Setting

Case 3B Automatic Address Setting in Cooling Mode

- Indoor and outdoor unit power cannot be turned ON for each system separately.
In the following, automatic setting of indoor unit addresses is not possible if the compressors are not operating.
Therefore perform this process only after completing all refrigerant tubing work.
Automatic address setting can be performed during Cooling operation.

Automatic Address Setting from Outdoor Unit

1. Perform steps 1 – 4 in the same way as for **Case 2** .
5. Turn the indoor and outdoor unit power ON at all systems.
↓
6. To perform automatic address setting in **Cooling mode** , on the outdoor main unit control PCB in the refrigerant system where you wish to set the addresses, short-circuit the MODE COOL pin (CN085). At the same time, short-circuit the automatic address pin (CN054) for 1 second or longer, then release it. (Be sure to perform this process for one system at a time. Automatic address settings cannot be performed for more than one system at the same time.)

↓
(Communication for automatic address setting begins, **the compressors turn ON, and automatic address setting in Cooling mode begins.**)

(All indoor units operate.)

* To cancel, again short-circuit the automatic address pin (CN054) for 1 second or longer, then release it.

↓ The LED that indicates automatic address setting is in progress turns OFF and the process is stopped.

Be sure to perform automatic address setting again.

(Automatic address setting is completed when the compressors stop and LEDs 1 and 2 on the outdoor main unit control PCB turn OFF.)

7. At the outdoor main unit in the next (different) system, short-circuit the automatic address pin (CN054) for 1 second or longer, then release it.

↓
(Repeat the same steps to complete automatic address setting for all units.)

8. Operation from the remote controllers is now possible.

* Automatic address setting in Cooling mode cannot be done from the remote controller.

Automatic Address Setting* from the Remote Controller

Selecting each refrigerant system individually for automatic address setting

---Automatic address setting for each system: Item code "A1"

1. Press the remote controller timer time button and button at the same time. (Press and hold for 4 seconds or longer.)
2. Next, press either the temperature setting or button.
(Check that the item code is "A1.")
3. Use either the **UNIT** or button to set the system No. to perform automatic address setting.
4. Then press the **SET** button.

(Automatic address setting for one refrigerant system begins.)

(When automatic address setting for one system is completed, the system returns to normal stopped status.) <Approximately 4 – 5 minutes is required.> (During automatic address setting, "**SETTING**" is displayed on the remote controller. This message disappears when automatic address setting is completed.)

5. Repeat the same steps to perform automatic address setting for each successive system.

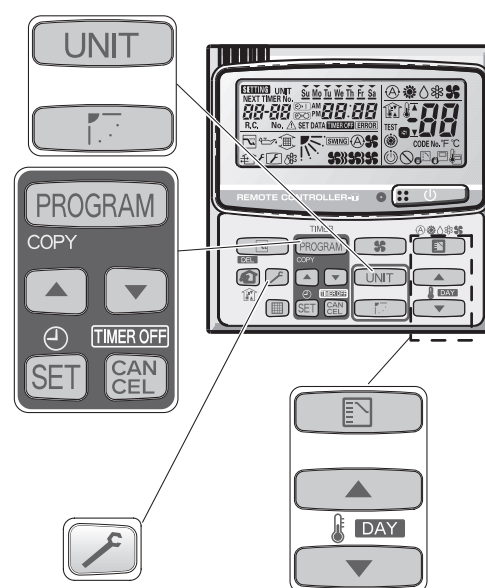

3. Auto Address Setting

Display during automatic address setting

● On outdoor main unit PCB



* Do not short-circuit the automatic address setting pin (CN054) again while automatic address setting is in progress. Doing so will cancel the setting operation and will cause LEDs 1 and 2 to turn OFF.

* When automatic address setting has been successfully completed, both LEDs 1 and 2 turn OFF.

* LED 1 is D023. LED 2 is D024.

* If automatic address setting is not completed successfully, refer to the table below and correct the problem. Then perform automatic address setting again.

● Display details of LEDs 1 and 2 on the outdoor unit control PCB

(☀: ON ☀: Blinking ●: OFF)

LED 1	LED 2	Display meaning
☀	☀	After the power is turned ON (and automatic address setting is not in progress), no communication with the indoor units in that system is possible.
●	☀	After the power is turned ON (and automatic address setting is not in progress), 1 or more indoor units are confirmed in that system; however, the number of indoor units does not match the number that was set.
☀	☀	Automatic address setting is in progress.
●	●	Automatic address setting completed.
☀	☀	At time of automatic address setting, the number of indoor units did not match the number that was set. “⚠” (when indoor units are operating) indication appears on the display.
☀	☀	Refer to “Table of Self-Diagnostic Functions and Description of Alarm Displays.”

Note: “⚠” indicates that the solenoid is fused or that there is a CT detection current failure (current is detected when the compressor is OFF).

● Remote controller display

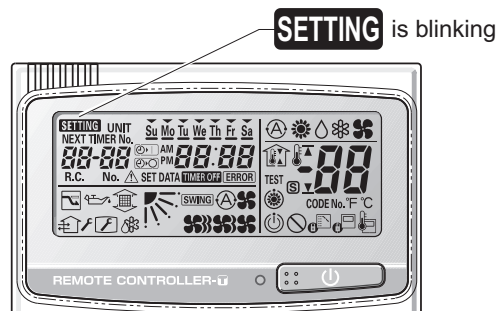

3. Auto Address Setting

Request concerning recording the indoor/outdoor unit combination Nos.

After automatic address setting has been completed, be sure to record them for future reference.

List the outdoor main unit system address and the addresses of the indoor units in that system in an easily visible location (next to the nameplate), using a permanent marking pen or similar means that cannot be abraded easily.



Example: (Outdoor) 1 - (Indoor) 1-1, 1-2, 1-3... (Outdoor) 2 - (Indoor) 2-1, 2-2, 2-3...

These numbers are necessary for later maintenance. Please be sure to indicate them.

Checking the indoor unit addresses

Use the remote controller to check the indoor unit address.

<If 1 indoor unit is connected to 1 remote controller>



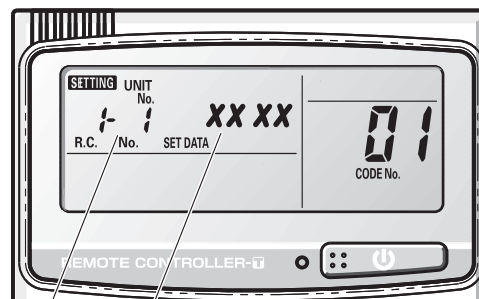

1. Press and hold the  button and  button for 4 seconds or longer (simple settings mode).
2. The address is displayed for the indoor unit that is connected to the remote controller.
(Only the address of the indoor unit that is connected to the remote controller can be checked.)
3. Press the  button again to return to normal remote controller mode.



Number changes to indicate which indoor unit is currently selected.

Indoor unit address

<If multiple indoor units are connected to 1 remote controller (group control)>

1. Press and hold the  button and  button for 4 seconds or longer (simple settings mode).
2. "ALL" is displayed on the remote controller.
3. Next, press the  button.
4. The address is displayed for 1 of the indoor units which is connected to the remote controller. Check that the fan of that indoor unit starts and that air is discharged.
5. Press the  button again and check the address of each indoor unit in sequence.
6. Press the  button again to return to normal remote controller mode.

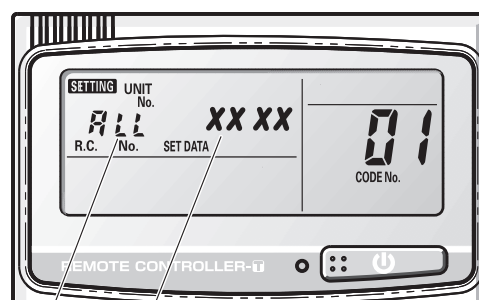

Number changes to indicate which indoor unit is currently selected.

Indoor unit address



– MEMO –

2. Remote Controller Functions

1. Remote Controller Test Run Settings	2-2
2. Simple Settings Function.....	2-3
3. Detailed Settings Function	2-5
4. Remote Controller Servicing Functions.....	2-13

1. Remote Controller Test Run Settings

Wired Remote Controller Test Run Settings

1. Press the remote controller  button for 4 seconds or longer.
2. "TEST" appears on the LCD display while the test run is in progress.
3. Then press the  button.
 - The temperature cannot be adjusted when in Test Run mode.
(This mode places a heavy load on the machines. Therefore use it only when performing the test run.)
 - The test run can be performed using the HEAT, COOL, or FAN operation modes.

NOTE The outdoor units will not operate for approximately 3 minutes after the power is turned ON and after operation is stopped.

- If correct operation is not possible, a error code is displayed on the remote controller LCD display.
(Refer to "Table of Self-Diagnostic Functions" and correct the problem.)
4. After the test run is completed, press the  button again. Check that "TEST" disappears from the LCD display.
 - To prevent continuous test runs, this remote controller includes a timer function that cancels the test run after 60 minutes.
 - The operation is possible even if the cassette-type ceiling panel has not been installed. ("P09" display does not occur.)

2. Simple Settings Function

List of Simple Setting Items

Item code	Item	Setting data		
		No.	Description	
01	Filter sign ON time (filter lifetime)	0000	Not displayed	
		0001	150 hours	
		0002	2,500 hours	
		0003	5,000 hours	
		0004	10,000 hours	
		0005	Use the filter clogging sensor.	
02	Degree of filter fouling	0000	Standard (setting at time of shipping)	
		0001	Highly fouled (Filter sign ON time is reduced to one-half the set time.)	
03	Central control address	0001	Central control address 1	
		0002	Central control address 2	
		0003	Central control address 3	
		}	}	
		0064	Central control address 64	
		0099	No central control address set (setting at time of shipping)	
04	Operating mode priority change	0000	Normal (setting at time of shipping)	
		0001	Priority	
05	Fan speed when heating thermostat is OFF		Compressor ON	Compressor OFF
		0000	MED 1 min., LO 3 min.	LO
		0001	MED	LO
		0002	LO	LO
		0004	MED 1 min., LO 3 min.	MED
		0005	MED	MED
		0006	LO	MED
06	Heating intake temperature shift	0000	No shift	
		0001	Shifts intake temperature 1°C down.	
		0002	Shifts intake temperature 2°C down.	
		0003	Shifts intake temperature 3°C down.	
		0004	Shifts intake temperature 4°C down.	
		0005	Shifts intake temperature 5°C down.	
		0006	Shifts intake temperature 6°C down.	
07	Electric heater installation	0000	No heater	
		0001	Heater installed	
08	Humidifying when heater thermostat is OFF	0000	No (setting at time of shipping)	
		0001	Yes	
0d	Permit/prohibit automatic heating/cooling	0000	Permit	
		0001	Prohibit	
0F	Cool-only	0000	Normal	
		0001	Cool only (Set "1" for item code OD.)	

NOTE

- In order to avoid water leakage and damage to the fan, do not set for humidifying when the thermostat is OFF unless a vaporizing humidifier is used.
- Consider the device purpose and type when changing the settings. Incorrect settings may result in malfunction.
- Do not change any setting data that does not appear in this list.

3. Detailed Settings Function

- This allows the system address, indoor unit address, and other settings to be made for the individual or group-control indoor unit to which the remote controller used for detailed settings is connected.

When detailed settings mode is engaged, operation stops at the individual or group-control indoor unit where the remote controller used for detailed settings is connected. Simple settings items can also be set at this time.

<Procedure>

- ① Press and hold the , **SET** and **CANCEL** buttons simultaneously for 4 seconds or longer.
- ② “**SETTING**,” unit No. “**1-1**” (or “**ALL**” in the case of group control), item code “**10**,” and settings data “**00XX**” are displayed blinking on the remote controller LCD display (Fig. 2-2).
At this time, the indoor unit fan (or all indoor unit fans in the case of group control) begins operating.

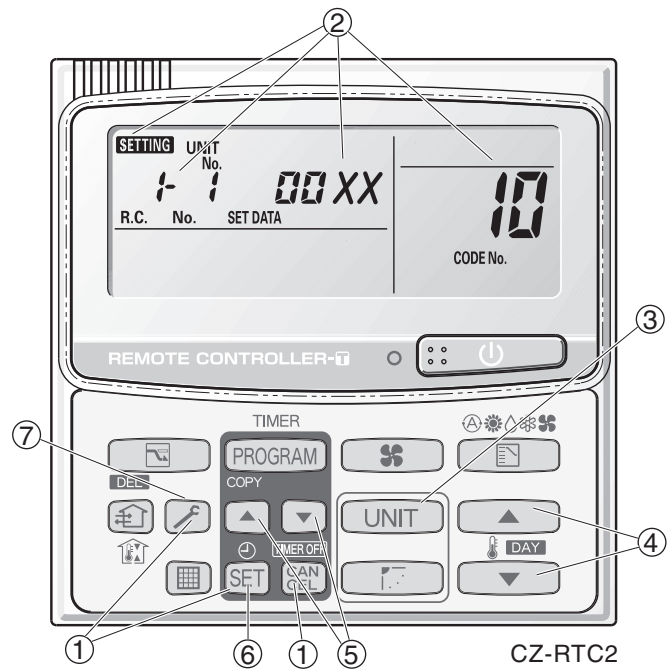





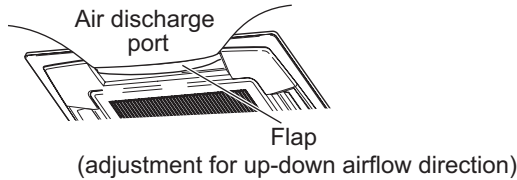

Fig. 2-2

- ③ If group control is in effect, press the **UNIT** button and select the address (unit No.) of the indoor unit to set. At this time, the fan at the indoor unit begins operating.
- ④ Press the temperature setting  /  buttons to select the item code to change.
- ⑤ Press the timer time  /  buttons to select the desired setting data.
* For item codes and setting data, refer to the following page.
- ⑥ Press the **SET** button.
(The display stops blinking and remains lit, and setting is completed.)
- ⑦ Press the  button to return to normal remote controller display.



3. Detailed Settings Function

- Setting the Flap Separately (When setting the CZ-RTC2)
 - The 4-air outlet flap can be adjusted separately during operation. When not adjusted separately, all flaps operate in the same manner.



<Procedure>

Stop the system before performing these steps.

- Press and hold the , **SET** and **CANCEL** buttons simultaneously for 4 seconds or longer.
- If group control is in effect, press the **UNIT** button and select the address (unit No.) of the indoor unit to set. At this time, the fan at the indoor unit begins operating.
- SETTING**, unit No. "1-1" (or "ALL" in the case of group control), item code "XX," and settings data "YYYY" are displayed blinking on the remote controller LCD display.
- Designate the item code "XX" by adjusting the Temperature Setting  /  buttons.

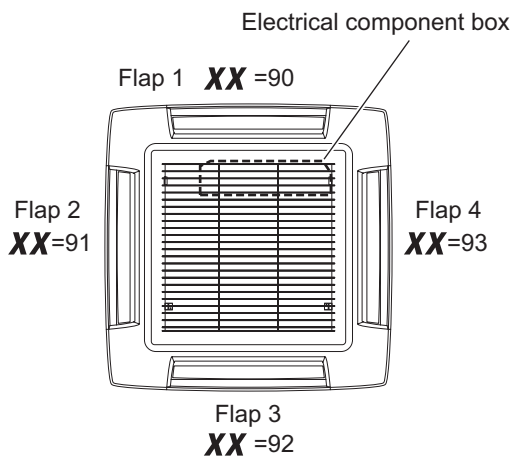

- Press the timer time  /  buttons to select the desired setting data.

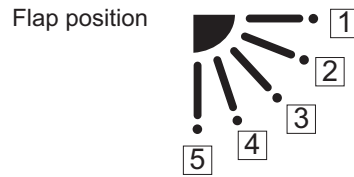

Fig. 2-3

- * Setting data "YYYY" (refer to Fig.2-3)

Setting data	Flap position during operation
0000	Without separate setting
0001	Swing
0002	Move to position 1 and stay
0003	Move to position 2 and stay
0004	Move to position 3 and stay
0005	Move to position 4 and stay
0006	Move to position 5 and stay

When the flap position is set to 4 or 5 and the unit is in the cooling or dry mode, the flap position is moved to 3 and the operation is started. (refer to Fig.2-3)

NOTE

The flap swings during the operation under "Setting the Flap Separately".

At this time, the unselected flaps are moved to the position 1. (refer to Fig.2-3)

- Press the **SET** button.
(The display stops blinking and remains lit, and setting is completed.)
If you wish to change the selected indoor unit, follow the step 2 .
- Press the  button to return to normal remote controller display.

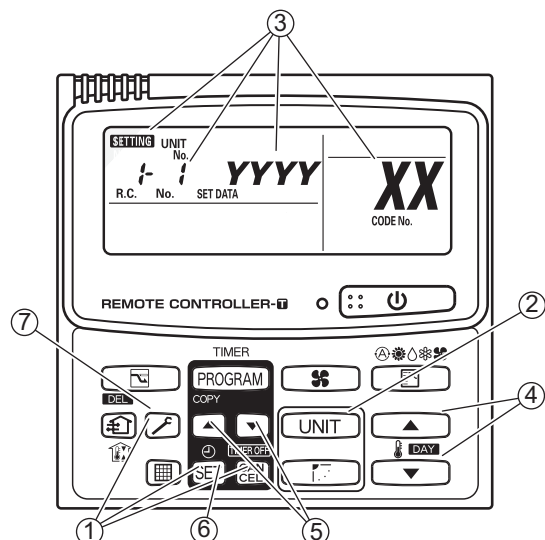

3. Detailed Settings Function

List of Detailed Setting Items

Item code	Item	Setting data					
		No.	Description	No.	Description	No.	Description
10	Type	0001	4-Way Casette (60x60) (U1, Y1)	0002	2-WAY Cassette (L1)	0003	1-Way Cassette (D1)
		0005	Low Silhouette Ducted (F1) Slim Low Static Ducted (M1)	0006	High Static Pressure Ducted (E1)	0007	Ceiling (T1)
		0008	Wall mounted (K1)	0010	Floor Standing (P1)	0011	Concealed Floor Standing (R1)
11	Indoor unit capacity	0001	22 (Type 22)	0003	28 (Type 28)	0005	36 (Type 36)
		0007	45 (Type 45)	0009	56 (Type 56)	0011	71 (Type 73) For S-71MP1E5 and S-71MR1E5
		0012	80 (Type 73) (Except S-71MP1E5, S-71MR1E5)	0013	90 (Type 90)	0015	112 (Type 106)
		0017	140 (Type 140)	0018	160 (Type 160)	0021	224 (Type 224)
		0023	280 (Type 280)				
12	System address	0001	Unit No. 1				
		0002	Unit No. 2				
		0003	Unit No. 3				
		}	}				
		0030	Unit No. 30				
		0099	Not set				
13	Indoor unit address	0001	Unit No. 1				
		0002	Unit No. 2				
		0003	Unit No. 3				
		}	}				
		0064	Unit No. 64				
		0099	Not set				
14	Group control address	0000	Individual (1:1 = Indoor unit with no group wiring)				
		0001	Main unit (One of the group-control indoor units)				
		0002	Sub unit (All group-control indoor units except for main unit)				
		0099	Not set				
17	Cooling intake temperature shift	-010	Shifts intake temperature by -10°C.				
		-009	Shifts intake temperature by -9°C.				
		}	}				
		-001	Shifts intake temperature by -1°C.				
		0000	No intake temperature shift				
		0001	Shifts intake temperature by +1°C.				
		}	}				
		0009	Shifts intake temperature by +9°C.				
0010	Shifts intake temperature by +10°C.						
18	Automatic stop time after operation start *Can be set in 5-minute units.	0000	Function disabled				
		0001	Stops automatically 5 minutes after operation starts.				
		0002	Stops automatically 10 minutes after operation starts.				
		}	}				
		0123	Stops automatically 615 minutes after operation starts.				
		0124	Stops automatically 620 minutes after operation starts.				
		0125	Stops automatically 625 minutes after operation starts.				

3. Detailed Settings Function

Item code	Item	Setting data		
		No.	Description	
1b (1B)	Forced thermostat ON time	0000	5 minutes	
		0001	4 minutes	
1c	Cooling discharge temperature shift	-010	-10°C	
		-009	-9°C	
		-008	-8°C	
		}	}	
		0010	10°C	
1d	Heating discharge temperature shift	-010	-10°C	
		-009	-9°C	
		-008	-8°C	
		}	}	
		0010	10°C	
1e	Temperature shift for cooling/heating change in "Auto Heat/Cool" mode	0001	±1°C	
		0002	±2°C	
		0003	±3°C	
		}	}	
		0007	±7°C	
1f (Upper limit) 20 (Lower limit)	Change to remote control temperature setting range	Cooling	0018	18°C (Lower limit at time of shipping)
			0019	19°C
			}	}
			0029	29°C
			0030	30°C (Upper limit at time of shipping)
21 (Upper limit) 22 (Lower limit)		Heating	0016	16°C (Lower limit at time of shipping)
			0017	17°C
			}	}
			0029	29°C
23 (Upper limit) 24 (Lower limit)		Drying	0018	18°C (Lower limit at time of shipping)
			0019	19°C
			}	}
			0030	30°C (Upper limit at time of shipping)
25 (Upper limit) 26 (Lower limit)		Auto heat/cool	0017	17°C (Lower limit at time of shipping)
			0018	18°C
			}	}
			0026	26°C
29		Humidifier operation	0000	Normal
			0001	Ignore heat exchanger temperature conditions.
2a		Filter (CN70) input switching	0000	Filter input (differential pressure switch input)
	0001		Alarm input (for trouble input about air cleaner or similar device)	
	0002		Humidifier input (Operates linked with drain pump when humidifier is ON.)	
2c	Indoor unit electronic control valve	0000	Present (Setting at time of shipping)	
		0002	None	
2e	T10 terminal switching	0000	Normal (Used as optional relay PCB or JEMA standard HA terminal.)	
		0001	Used for OFF reminder	
		0002	Fire prevention input	

3. Detailed Settings Function

Item code	Item	Setting data	
		No.	Description
2F	Automatic drain pump operation	0000	No forced operation
		0001	Forced operation for 1 minute
		}	}
		0060	Continuous operation
31	Ventilation fan operation	0000	None
		0001	Ventilation fan operated by remote controller.
32	Wired remote controller sensor	0000	Not used. (Body sensor is used.)
		0001	Remote control sensor is used.
34	"Operation change control in progress" display	0000	Normal (displayed)
		0001	Not displayed
35	OFF reminder function for when weekly timer is used	0000	None
		0001	Only stop time setting is enabled.
3A	Discharge temperature control	0000	Discharge temperature control OFF
		0001	Discharge temperature control ON
3C	Heat exchanger temperature for cold air discharge (Heat exchanger control point for control to prevent cold air)	0013	Control temperature 13°C
		0014	Control temperature 14°C
		}	}
		0025	Control temperature 25°C
		0026	Control temperature 26°C
3d	Fan output switching	0000	Output linked with fan. (ON when indoor unit fan is operating.)
		0001	Fan mode operation output
3E	Drain pump delayed start time	0000	No delayed start
		0001	1 sec. delayed start
		0002	2 sec. delayed start
		}	}
		0058	58 sec. delayed start
		0059	59 sec. delayed start
		0060	60 sec. delayed start
40	Humidifier setting	0000	Humidifier output OFF. Drain pump stopped.
		0001	Humidifier output ON. Drain pump operates.
		0002	Humidifier output ON. Drain pump operates for 1 minute when total humidifier operating time reaches 60 minutes.
		0003	Humidifier output ON. Drain pump stopped.
45	Flap operation mode	0000	Standard setting
		0001	Draft reduction mode (Flap swing lower-limit position is shifted upwards.)
46	Flap swing mode	0000	Smudging reduction mode (Flap swing upper-limit position is shifted downwards.)
		0001	Normal mode
		0002	Draft reduction mode (Flap lower-limit position is shifted upwards.)

3. Detailed Settings Function

Item code	Item	Setting data																	
		No.	Description																
5d	Fan tap setting (Fan tap change in order to prevent drop in air discharge caused by filter installation)		DC fan tap operating mode Purpose																
		0000	Standard Standard (setting at time of shipping)																
		0001	High ceiling use High ceiling setting 1 (with standard panel)																
			For low static-pressure filter Ultra long-life filter, oil guard panel, ammonia deodorizing filter, optical regenerative deodorizing filter																
		0003	High ceiling use High ceiling setting 2 (with standard panel)																
			For low static-pressure filter (Antibacterial) high-performance filter (90%) (Antibacterial) high-performance filter (65%) Air-cleaning unit, air-cleaning unit + optical regenerative deodorizing filter, deodorant (activated charcoal) filter																
0006	For air-blocking material For 3-way discharge, when discharge duct is connected																		
5E	Humidifier ON time (ON time per 60 seconds)	0000	No humidifier output																
		0001	1 sec.																
		0002	2 sec.																
		}	}																
		0058	58 sec.																
		0059	59 sec.																
		0060	Continuously ON																
5F	Repeat timer switching	0000	Function disabled																
		0001	Function enabled																
60	Timer function change prohibit	0000	Function disabled																
		0001	Function enabled																
62	Smudging control	0000	No smudging control																
90	Setting the Flap Separately * Only for 4-way Cassette type	0000																	
		0001																	
91	Setting the Flap Separately * Only for 4-way Cassette type	0002																	
		0003																	
92	Setting the Flap Separately * Only for 4-way Cassette type	0004																	
		0005																	
93	Setting the Flap Separately * Only for 4-way Cassette type	0006																	
		<table border="1"> <thead> <tr> <th>Setting data</th> <th>Flap position during operation</th> </tr> </thead> <tbody> <tr> <td>0000</td> <td>Without separate setting</td> </tr> <tr> <td>0001</td> <td>Swing</td> </tr> <tr> <td>0002</td> <td>Move to position 1 and stay</td> </tr> <tr> <td>0003</td> <td>Move to position 2 and stay</td> </tr> <tr> <td>0004</td> <td>Move to position 3 and stay</td> </tr> <tr> <td>0005</td> <td>Move to position 4 and stay</td> </tr> <tr> <td>0006</td> <td>Move to position 5 and stay</td> </tr> </tbody> </table>	Setting data	Flap position during operation	0000	Without separate setting	0001	Swing	0002	Move to position 1 and stay	0003	Move to position 2 and stay	0004	Move to position 3 and stay	0005	Move to position 4 and stay	0006	Move to position 5 and stay	<p>When the flap position is set to 4 or 5 and the unit is in the cooling or dry mode, the flap position is moved to 3 and the operation is started.</p> <p>NOTE The flap swings during the operation under "Setting the Flap Separately". At this time, the unselected flaps are moved to the position 1.</p>
Setting data	Flap position during operation																		
0000	Without separate setting																		
0001	Swing																		
0002	Move to position 1 and stay																		
0003	Move to position 2 and stay																		
0004	Move to position 3 and stay																		
0005	Move to position 4 and stay																		
0006	Move to position 5 and stay																		

3. Detailed Settings Function

Selecting the DC fan motor tap (when setting with the remote controller)

<Procedure>

Stop the system before performing these steps.

- ① Press and hold the , **SET** and **CAN CEL** buttons simultaneously for 4 seconds or longer.
- ② If group control is in effect, press the **UNIT** button and select the address (unit No.) of the indoor unit to set. At this time, the fan at the indoor unit begins operating.
- ③ Use the temperature setting buttons to select item code "5d."
- ④ Press the timer time / buttons to select the desired setting data.
* For item codes and setting data, refer to Table 1 – Table 3.
- ⑤ Press the **SET** button. (The display stops blinking and remains lit, and setting is completed.)
* If air-blocking material is used, use the same procedure as in steps (3) – (5) above and change the setting for item code "62" to "0000."

To change the selected indoor unit, go to step (2).

- ⑥ Press the button to return to normal remote controller display.

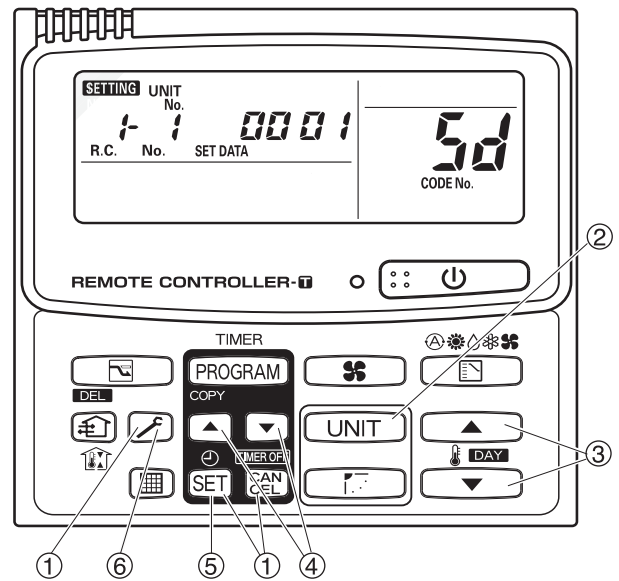

Fig. 2-4

* Failure to make this setting may result in decreased airflow and condensation.

Table 1 Table of DC Fan Motor Tap Settings (4-way cassette type)

Setting No.	Remote controller setting data	Contents & optional parts name
(3)	0000	Standard (setting at time of shipping)
	0003	Air-blocking material (for 3-way air discharge)
	0003	Air-blocking material (when a discharge duct is connected)
(6)	0006	Air-blocking material (for 2-way air discharge)

Table 2 Table of DC Fan Motor Tap Settings (Ceiling type)

Setting No.	Remote controller setting data	Purpose of use, names of accessories
(1)	0001	Standard (setting at time of shipping)
		High ceiling setting
		Super long-life filter
		Ammonia deodorant filter (65% by JIS colorimetric method)
		Optical regeneration deodorant filter
(3)	0003	High performance filter (65% by JIS colorimetric method)
		Deodorant filter (65% by JIS colorimetric method)

Table 3 Table of DC Fan Motor Tap Settings (Slim Low Static Ducted type)

Setting No.	Remote controller setting data	Purpose of use, names of accessories
(1)	0001	Standard (setting at time of shipping)
		High ceiling setting
(3)	0003	Discharge grille (purchased separately) is installed. 2-way lowered-ceiling system

3. Detailed Settings Function

Selecting the DC fan motor tap (when setting from the PCB)

● 4-Way Cassette

<Procedure> Stop the system before performing these steps.

- ① Open the electrical component box cover, then check the indoor unit control PCB. (Fig. 2-5)
- ② Connect the jumper connector (2P: yellow) which was supplied with the accessory to the correct connector pin on the indoor unit control PCB according to the setting number which was confirmed in Table for DC Fan Motor Tap Settings.

Setting No. (3) :

Then connect the jumper connector to the connector pin TP3 (2P: yellow) on the indoor unit control PCB.

Setting No. (6) :

Then connect the jumper connector to the connector pin TP6 (2P: white) on the indoor unit control PCB.

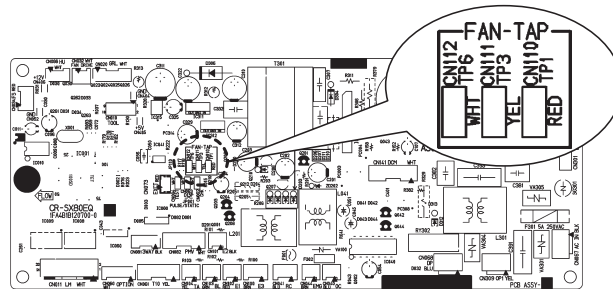

Fig. 2-5

● Ceiling

<Procedure> Stop the system before performing these steps.

- ① Open the electrical component box cover, then check the indoor unit control PCB. (Fig. 2-6)
- ② Connect the jumper connector (2P: yellow) which was supplied with the accessory to the correct connector pin on the indoor unit control PCB according to the setting number which was confirmed in Table 2 (Table of DC Fan Motor Tap Settings).
 - If the setting No. is (1), then connect the jumper connector to the connector pin TP1 (2P: red) on the indoor unit control PCB.
 - If the setting No. is (3), then connect the jumper connector to the connector pin TP3 (2P: yellow) on the indoor unit control PCB.

● 1-Way Cassette

<Procedure> Be sure to turn OFF the main power source before performing the steps below.

- ① Open the electrical component box cover, then check the indoor unit control PCB. (Fig. 2-6)
- ② Connect the jumper connector (2P: yellow) which was supplied with the accessory to the correct connector pin on the indoor unit control PCB according to the setting number which was confirmed in Table 3 (Table of DC Fan Motor Tap Settings).
 - When using with the high ceiling settings
Connect the jumper connector to the connector pin TP1 (2P: red) on the indoor unit control PCB.
 - When using with the discharge grille (purchased separately) attached (2-way lowered ceiling system)
Connect the jumper connector to the connector pin TP3 (2P: yellow) on the indoor unit control PCB.

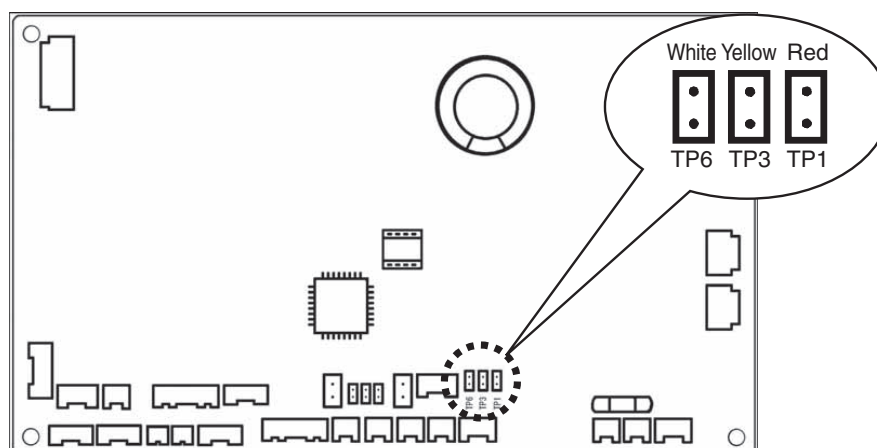















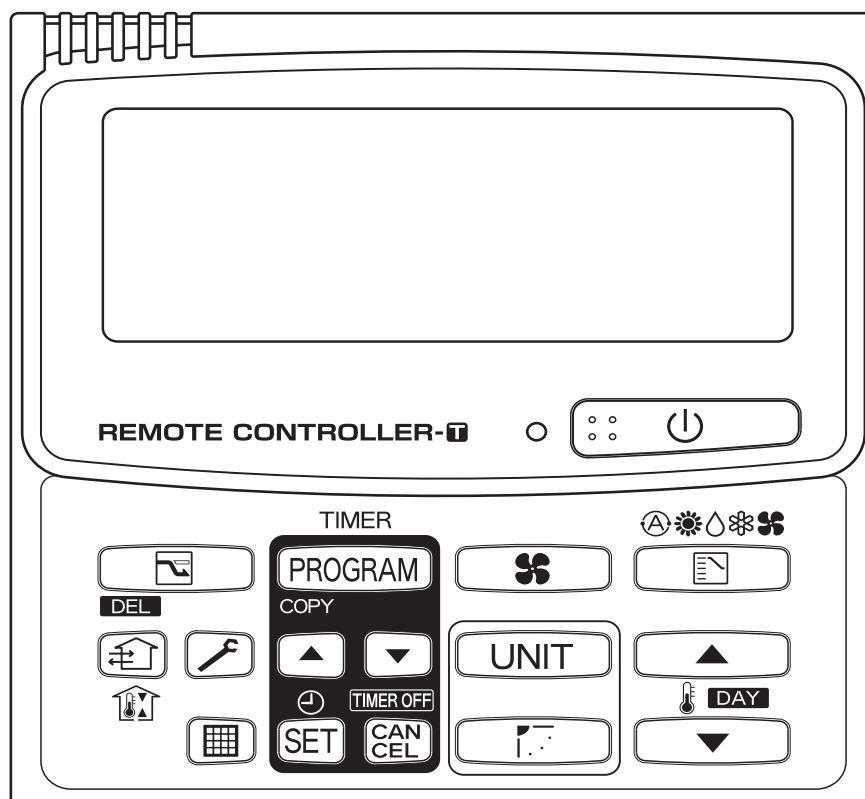

Fig. 2-6

4. Remote Controller Servicing Functions

List of Servicing Functions

Function	Description	Button operations	Reset operation	Unit status
Test run	Operation with forced thermostat ON	Press and hold the  button for 4 seconds or longer.	Press the  button.	Current operation is maintained.
Sensor temperature display	Temperature display from each sensor	Press and hold the  and  buttons for 4 seconds or longer.		
Servicing check display	Alarm history display	Press and hold the  and  buttons for 4 seconds or longer.		
Simple settings	Filter lifetime, operating mode priority, central control address, and other settings	Press and hold the  and  buttons for 4 seconds or longer.		
Detailed settings	System address, indoor unit address, central control address, and other settings	Press and hold the  ,  , and  buttons for 4 seconds or longer.	Automatic reset	When settings are made from a remote controller, the indoor unit where that remote controller is connected stops.
Automatic address	Automatic address setting based on command from the wired remote controller	Press and hold the  and the timer operation  buttons for 4 seconds or longer.		
Address change	Change of indoor unit address	Press and hold the  and the timer operation  buttons for 4 seconds or longer.		





4. Remote Controller Servicing Functions

Test Run Function

Operates the unit with the thermostat forced ON.

<Procedure>

- ① Press and hold the  button for 4 seconds or longer.
- ② "Test" appears on the remote controller LCD display (Fig. 2-7).
- ③ Start operation.
- ④ Press the  button to return to normal remote controller display.

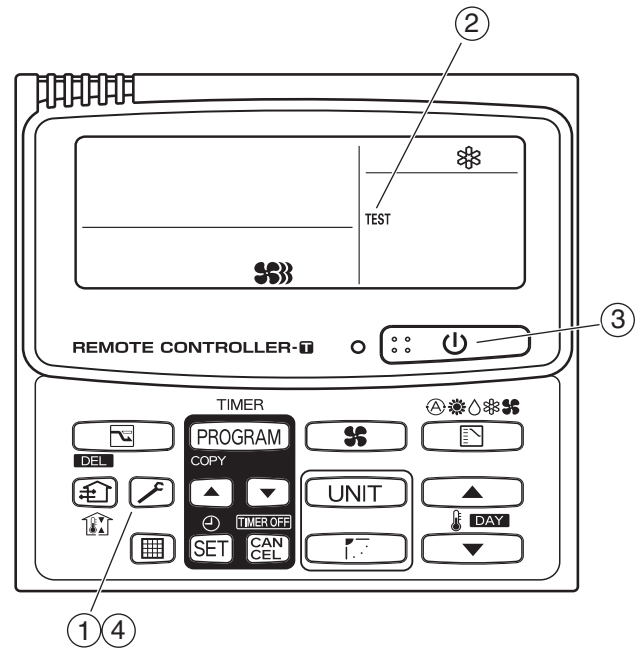







Fig. 2-7

4. Remote Controller Servicing Functions

■ Sensor Temperature Display Function (displayed regardless of whether unit is operating or stopped)

The procedure below displays the sensor temperatures from the remote controller, indoor unit, and outdoor unit on the remote controller.

<Procedure>

- ① Press and hold the  and  buttons simultaneously for 4 seconds or longer.
- ② The unit No. "X-X" (main unit No.), item code "XX" (sensor address), and servicing monitor "00XX" (sensor temperature) are displayed on the remote controller LCD display. (See Fig. 2-8 at right.)
- ③ Press the temperature setting  /  buttons and select the item code to the address of the sensor to monitor.
(For the relationships between the sensor addresses and sensor types, refer to the table of temperature sensors and addresses below.)
- ④ If group control is in effect, press the  button to select the unit to monitor.
Press the temperature setting buttons to select the item code to change.
- ⑤ Press the  button to return to normal remote controller display.

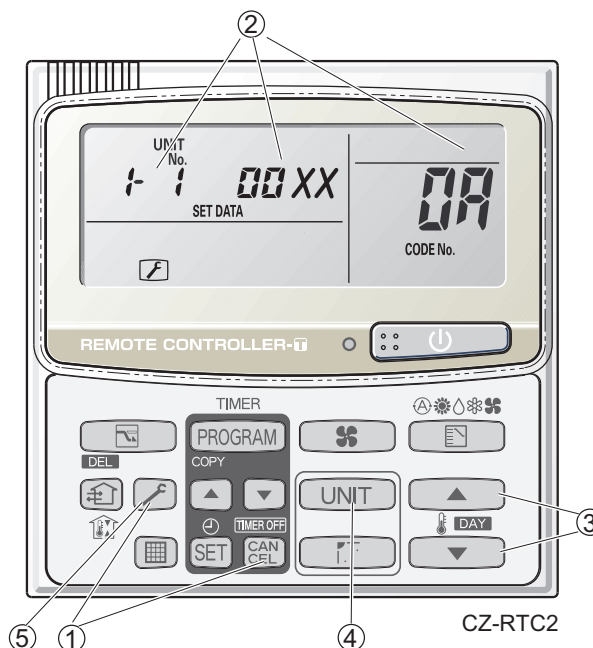

* Display shows a discharge temperature of 00XX at unit No. 1-1.
In case, for example, the display shows "0085" in the figure above, a discharge temperature from the outdoor unit stands for 85°C.

Fig. 2-8

NOTE

The temperature display appears as "- - -" for units that are not connected.

* If monitor mode is engaged while normal operation is in progress, only the parts of the LCD display shown in the figure will change. Other parts continue to display the same information as during normal operation.

Indoor unit sensors	
02	Intake temp.
03	E1
04	E2
05	E3
06	Discharge temp.
07	Discharge temp. setting
08	Position of indoor unit electronic control valve

Outdoor unit sensors			
Unit No.1	Unit No.2	Unit No.3	
0A	2A	4A	Discharge temp. 1
0B	2B	4B	Discharge temp. 2
0C	2C	4C	High-pressure sensor temp.
0D	2D	4D	Heat exchanger gas 1
0E	2E	4E	Heat exchanger liquid 1
0F	2F	4F	Heat exchanger gas 2
10	30	50	Heat exchanger liquid 2
11	31	51	Outdoor air temp.
12	32	52	—
13	33	53	For inspection
14	34	54	CT2
15	35	55	For inspection
16	36	56	For inspection
17	37	57	Discharge temp. 3
18	38	58	CT3
19	39	59	For inspection
1A	3A	5A	For inspection
1B	3B	5B	Heat exchanger gas 3
1C	3C	5C	Heat exchanger liquid 3
1D	3D	5D	Low-pressure sensor temp.
1E	3E	5E	Suction temp.
1F	3F	5F	Oil 1
20	40	60	Oil 2
21	41	61	Oil 3
22	42	62	For inspection

– MEMO –

Contents

3. Trouble Diagnosis

1. Contents of Remote Controller Switch Alarm Display	3-2
2. Outdoor Unit Control PCB LED Display	3-4
3. 2WAY Alarm Codes.....	3-5
4. Blinking (Inspection) Display on the Remote Controller	3-26

1. Contents of Remote Controller Switch Alarm Display

ON: ○ Blinking: ☀ OFF: ●

Possible cause of malfunction			Wired remote control display	Wireless remote controller receiver display			
				Operation	Timer	Standby for heating	
Serial communication errors Mis-setting	Remote controller is detecting error signal from indoor unit.	Error in receiving serial communication signal. (Signal from main indoor unit in case of group control) Outdoor system address, indoor unit address, or indoor unit address independent/main/sub unit setting has not been made. (Auto address is not completed.)	<E01>	Operating lamp blinking	☀	●	
		Error in transmitting serial communication signal.	<E02>	●	●	●	
	Indoor unit is detecting error signal from remote controller and system controller.		<<E03>>				
	Indoor unit is detecting error signal from outdoor unit.	<ul style="list-style-type: none"> Error in receiving serial communication signal. When turning on the power supply, the number of connected indoor units does not correspond to the number set. (Except R.C. address is "0.") Group wiring failure of indoor units in the refrigerant system (occurring when remote controller is operated immediately after automatic address setting) 	E04	Heating ready lamp blinking	●	●	
	Outdoor unit is detecting error signal from indoor unit.	<ul style="list-style-type: none"> Error in receiving serial communication signal. There is an indoor unit which does not send signals when the power is ON. 	E06		●	☀	
	Improper setting	Indoor unit address setting is duplicated.		<<E08>>	Operating lamp blinking	●	●
			Duplicated remote controller "main" setting.	<<E09>>			
	Improper setting	Automatic address setting start is prohibited. AP pin was short-circuited at time when automatic address setting was started.		E12	☀	●	●
	Indoor unit communication error of group control wiring.	Error of main indoor unit in receiving serial communication signal from sub indoor units.		E18			
	During auto. address setting, number of connected units does not correspond to number set.	Number of connected indoor units is less than the number set.		E15	Heating ready lamp blinking	●	●
		Number of connected indoor units is more than the number set.		E16			
		No indoor unit is connected during auto. address setting.		E20			
		Main outdoor unit is detecting error signal from sub outdoor unit.		E24			
		Duplicated outdoor unit address.		E25			
		Mismatch in "No. of outdoor units" setting.		E26			
Error of sub outdoor unit in receiving serial communication signal from main outdoor unit.			E29				
Outdoor unit serial communications failure.			E30				
Communication error between the microcomputers			E31				
Improper setting	Connected indoor unit is not a multi unit.		<<L02>>	Operating and heating ready lamps blinking simultaneously	☀	●	
	Duplication of main indoor unit address setting in group control.		<L03>				
	Duplicated indoor unit priority (priority indoor unit).		L05				
	Duplicated indoor unit priority (non-priority indoor unit) and outdoor unit.		L06				
	Indoor unit address is not set.		L08				☀
	Capacity code of indoor unit is not set.		<<L09>>				☀
	Mismatch of outdoor unit type.		L17				
	4-way valve operation failure		L18				
	Duplication of outdoor R.C. address setting.		L04				
	Capacity code of outdoor unit is not set.		L10				☀
Thermistor fault	Indoor unit	Indoor coil temp. sensor (E1)	<<F01>>	Operating and timer lamps blinking alternately	☀	○	
		Indoor coil temp. sensor (E3)	<<F03>>				
		Indoor suction air (room) temp. sensor	<<F10>>				
		Indoor discharge air temp. sensor	<<F11>>				☀

Continued

1. Contents of Remote Controller Switch Alarm Display

ON: ○ Blinking: ☀ OFF: ●

Possible cause of malfunction			Wired remote control display	Wireless remote controller receiver display			
				Operation	Timer	Standby for heating	
Thermistor fault	Outdoor unit	Compressor 1 (INV) discharge temp. sensor	F04	Operating and timer lamps blinking alternately	☀	☀	
		Compressor 2 (constant speed) discharge temp. sensor	F05				
		Compressor 3 (constant speed) discharge temp. sensor	F22				
		Outdoor air temp. sensor	F08				
		Heat exchanger 1 liquid temp. sensor	F07				
		Heat exchanger 1 gas temp. sensor	F06				
		Compressor intake temp. sensor (suction temp)	F12				
		High-pressure sensor	F16				
		Low-pressure sensor	F17				
		Heat exchanger 2 liquid temp. sensor	F24				
		Heat exchanger 2 gas temp. sensor	F23				
Ceiling panel connection failure			<<P09>>	Timer and heat ready lamp blinking alternately			
Protective device	Indoor unit	Thermal protector in indoor unit fan motor is activated.	<<P01>>	Operating and heat ready lamp blinking alternately	●	☀	
		Float switch is activated.	<<P10>>				
		Fan inverter protection function activated.	<<P12>>				
	Outdoor unit	Oxygen (O ₂) gas sensor activated.	P14		Operating and heat ready lamp blinking alternately	☀	●
		Compressor thermal protector is activated. Power supply voltage is unusual. (More than 260V or less than 160V between L1 and L2 phase.)	P02				
		Compressor 1 (INV) discharge temp. trouble	P03				
		High-pressure switch	P04				
		Reverse phase (missing phase) detected.	P05				
		DCCT, ACCT overcurrent	P16				
		Compressor 2 (constant speed) discharge temp. trouble	P17				
		Compressor 3 (constant speed) discharge temp. trouble	P18				
		High load alarm	P20				
		Outdoor unit fan trouble	P22				
		INV compressor start failure. (Missing phase or lock alarm)	P29				
Failure of nonvolatile memory IC (EEPROM) on indoor unit control PCB			F29	Operating and timer lamp blinking simultaneously			
Failure of nonvolatile memory IC (EEPROM) on outdoor unit control PCB			F31	Operating and timer lamp blinking simultaneously			
Protective device	Overload current detected.	Compressor 2 (constant speed)	H11	Timer lamp blinking	●	☀	
		Compressor 3 (constant speed)	H21				
	Lock current detected.	Compressor 2 (constant speed)	H12				
		Compressor 3 (constant speed)	H22				
	No current detected when compressor was ON.	Compressor 1 (INV)	H03				
		Compressor 2 (constant speed)	H13				
		Compressor 3 (constant speed)	H23				
	Discharge temp. sensor trouble	Compressor 1 (INV)	H05				
		Compressor 2 (constant speed)	H15				
	Outdoor unit protection	Compressor 3 (constant speed)	H25				
Low-pressure trouble		H06					
Outdoor unit protection	HIC trouble alarm	H31					
Low oil alarm			H07				
Connection failure of oil detection sensor	Compressor 1 (INV)		H08				
	Compressor 2 (constant speed)		H27				
	Compressor 3 (constant speed)		H28				
Fusing of electromagnetic contact (Current detected when compressor was OFF)			CHECK only blinking	(No display changes)			
Automatic backup operation							

<< >> alarm indication: Does not affect the operation of other indoor units.

< > alarm indication: In some cases may affect the operation of other indoor units.



2. Outdoor Unit Control PCB LED Display

(○ : ON ☀ : Blinking ● : OFF)

LED (RED)		Display meaning
1	2	
○	○	After the power is turned ON (and automatic address setting is not in progress), no communication with the indoor units in that system is possible.
(Both ON)		
●	○	After power is turned ON (and automatic address setting is not in progress), one or more indoor units are confirmed in that system; however, the number of indoor units does not match the number that was set.
(OFF)	(ON)	
●	●	Automatic address setting was completed successfully. (After the power is turned ON, and automatic address setting is not in progress, the number of detected indoor units connected to that system matches the number that was set, and regular communications are occurring.)
(Both OFF)		
☀	☀	Automatic address setting is in progress.
(Blinking alternately)		
☀	☀	At time of automatic address setting, the number of indoor units did not match the number that was set.
(Both blinking)		
☀	☀	Alarm display LED 1 blinks M times, then LED 2 blinks N times. The cycle then repeats. M = 2: P alarm 3: H alarm 4: E alarm 5: F alarm 6: L alarm N = Alarm No. Example: LED 1 blinks 2 times, then LED 2 blinks 17 times. The cycle then repeats. Alarm is "P17."
(Blinking alternately)		

3. 2WAY Alarm Codes

With type 8HP, the INV compressor is compressor 1 only.

With types 10HP, 12HP, 14HP and 16HP, the INV compressor is compressor 1, and the constant-speed compressors (AC1) are compressors 2 .

With types 18HP and 20HP, the INV compressor is compressor 1, and the constant-speed compressors (AC1, AC2) are compressors 2 and 3.

Alarm code	Alarm meaning	Page
E06	Outdoor unit failed to receive serial communication signals from indoor unit.	3-7
E12	Automatic address setting start is prohibited.	3-7
E15	Automatic address setting alarm (too few units)	3-7
E16	Automatic address setting alarm (too many units)	3-8
E20	No indoor units at automatic address setting.	3-8
E24	Outdoor unit (INV) failed to receive communications from another outdoor unit (constant-speed).	3-8
E25	Outdoor unit address setting failure (duplication)	3-9
E26	Mismatch in outdoor unit quantity	3-9
E29	Outdoor unit failed to receive communication from outdoor unit (main)	3-9
E31	Communication error between the microcomputers	3-9
F04	Compressor 1 discharge temperature sensor trouble	3-10
F05	Compressor 2 discharge temperature sensor trouble	3-10
F22	Compressor 3 discharge temperature sensor trouble	3-10
F06	Gas temperature sensor trouble at outdoor heat exchanger 1 (In)	3-11
F07	Liquid temperature sensor trouble at outdoor heat exchanger 1 (Out)	3-11
F08	Outdoor air temperature sensor trouble	3-12
F12	Compressor intake temperature sensor trouble	3-12
F16	High-pressure sensor trouble	3-13
F17	Low-pressure sensor trouble	3-14
F23	Gas temperature sensor trouble at outdoor heat exchanger 2 (In)	3-11
F24	Liquid temperature sensor trouble at outdoor heat exchanger 2 (Out)	3-11
F31	Outdoor unit non-volatile memory (EEPROM) trouble	3-14
H11	Constant speed compressor 2 overcurrent alarm	3-15
H12	Constant speed compressor 2 lock current alarm	3-15
H03	Compressor 1 CT sensor disconnected or short-circuit	3-16
H05	Compressor 1 discharge temperature sensor disconnected	3-16
H06	Low-pressure switch activated	3-17
H08	Compressor 1 oil detection sensor (connection) trouble	3-18
H13	Compressor 2 CT sensor disconnected or short-circuit	3-16
H15	Compressor 2 discharge temperature sensor disconnected	3-16
H21	Compressor 3 overcurrent alarm	3-15
H22	Compressor 3 lock current alarm	3-15
H23	Compressor 3 CT sensor disconnected or short-circuit	3-16
H25	Compressor 3 discharge temperature sensor disconnected	3-16
H27	Compressor 2 oil detection sensor (connection) trouble	3-18
H28	Compressor 3 oil detection sensor (connection) trouble	3-18
H31	HIC trouble alarm	3-19
L04	Outdoor system address duplication	3-19
L10	Outdoor unit capacity not set	3-20
L17	Outdoor unit model mismatch	3-20
L18	4-way valve operation failure	3-20

3. 2WAY Alarm Codes

P02	Compressor thermal protector is activated.(trip only and no alarm)	3-20
P03	Compressor 1 discharge temperature trouble	3-21
P04	High-pressure switch activated	3-22
P05	Reverse phase (or missing phase) detected	3-22
P14	O2 sensor differential alarm (Only when optional O2 sensor supplied)	3-23
P16	Compressor 1 (INV) overcurrent alarm	3-23
P17	Compressor 2 discharge temperature trouble	3-21
P18	Compressor 3 discharge temperature trouble	3-21
P20	High load alarm	3-24
P22	Fan motor trouble	3-24
P29	Inverter compressor missing phase or lock alarm	3-25

Blinking Inspection Display on the remote controller	CHECK blinking (1)	3-26
	CHECK blinking (2)	3-27

3. 2WAY Alarm Codes

E06 Alarm

Alarm code	E06
Alarm meaning	Outdoor unit failed to receive serial communication signals from indoor unit.
Alarm conditions	Outdoor unit failed to receive serial communication signals from indoor unit.
Probable cause	(1) The indoor unit power was cut OFF after initial communications were completed. (2) An open circuit or short-circuit occurred in the inter-unit control wiring after initial communications were completed.
Check	Check the power at the indoor and outdoor units, and check the inter-unit control wiring.
Correction	—
Example	—
Notes	This alarm is detected after initial communications are completed. Therefore, it does not occur in cases of “disconnected serial connector,” “no terminal unit set,” or other trouble that occurs before initial communications are completed. If initial communications have not been completed, alarm E04 occurs.

E12 Alarm

Alarm code	E12
Alarm meaning	Automatic address setting start is prohibited.
Alarm conditions	Automatic address setting was started when automatic address setting was in progress at another outdoor unit in the same link.
Probable cause	Automatic address setting is in progress at another outdoor unit.
Check	This alarm is not displayed on the remote controller. Therefore check the blinking on the outdoor unit PCB.
Correction	Wait for automatic address setting to be completed at the outdoor unit where it is currently in progress. Then start automatic address setting again.
Example	—
Notes	—

E15 Alarm

Alarm code	E15
Alarm meaning	Automatic address setting alarm (too few units)
Alarm conditions	The number of indoor units was too few when automatic address setting was performed.
Probable cause	(1) The number of indoor units set at the indoor unit quantity setting SW (S004, S005) on the outdoor unit PCB is too many. (2) The inter-unit control wiring between indoor units has been cut.
Check	(1) Refer to the test run servicing materials and check the indoor unit quantity setting SW (S004, S005). (2) Check the inter-unit control wiring at the indoor and outdoor units.
Correction	After correcting the indoor unit quantity setting or the inter-unit control wiring, perform automatic address setting again.
Example	—
Notes	2WAY switch position

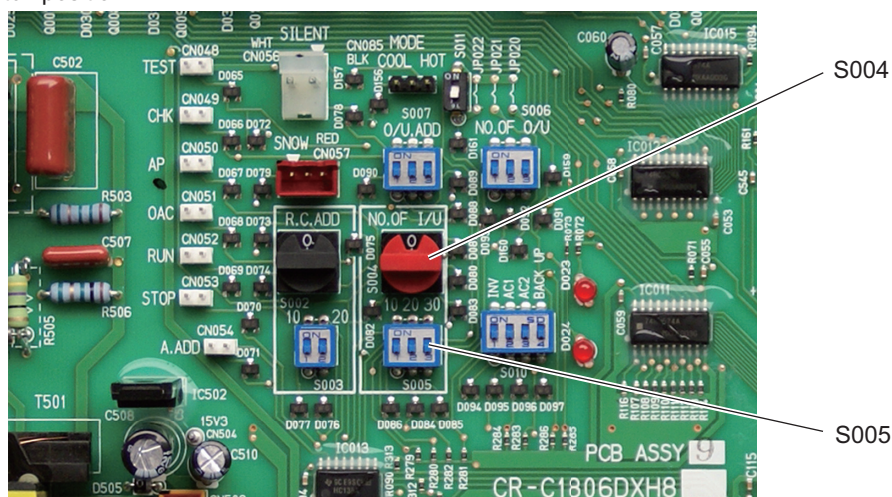

3. 2WAY Alarm Codes

E16 Alarm

Alarm code	E16
Alarm meaning	Automatic address setting alarm (too many units)
Alarm conditions	<ul style="list-style-type: none"> The number of indoor units was too many when automatic address setting was performed. After initial communications were completed, an unrecognized unit was detected.
Probable cause	<p>(1) The number of indoor units set at the indoor unit quantity setting SW (S004, S005) on the outdoor unit PCB is less than the number set.</p> <p>(2) The inter-unit control wiring is wired incorrectly.</p>
Check	<p>(1) Refer to the test run servicing materials and check the number of indoor units that is set.</p> <p>(2) Check the inter-unit control wiring at the indoor and outdoor units.</p>
Correction	After correcting the indoor unit quantity setting or the inter-unit control wiring, perform automatic address setting again.
Example	—
Notes	—

E20 Alarm

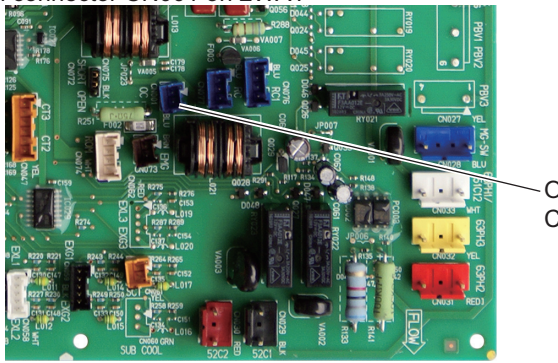
Alarm code	E20
Alarm meaning	No indoor units at automatic address setting.
Alarm conditions	When automatic address setting was performed, no indoor units were recognized.
Probable cause	<p>(1) The inter-unit control wiring from the outdoor unit to the indoor units has been cut.</p> <p>(2) Serial connector 1 (CN001) is disconnected at the outdoor unit.</p> <p>(3) The power is OFF at all indoor units in the system.</p>
Check	<p>(1) Check whether the inter-unit control wiring from the outdoor unit to the indoor units is cut.</p> <p>(2) Check whether serial connector 1 (CN001) is disconnected at the outdoor unit.</p> <p>(3) Check the power at the indoor units.</p>
Correction	(1) Reconnect the inter-unit control wire from the outdoor unit to the indoor unit.
Example	—
Notes	<p>Position of serial connector CN001 on 2WAY</p> 

E24 Alarm

Alarm code	E24
Alarm meaning	Outdoor unit (INV) failed to receive communications from other outdoor unit (constant-speed).
Alarm conditions	After initial communications were completed, communications from an outdoor unit stopped.
Probable cause	<p>(1) After initial communications were completed, the control wiring between main and sub outdoor units was cut.</p> <p>(2) After initial communications were completed, the outdoor unit power was turned OFF.</p>
Check	—
Correction	—
Example	—
Notes	—

3. 2WAY Alarm Codes

E25 Alarm

Alarm code	E25
Alarm meaning	Outdoor unit address setting failure (duplication)
Alarm conditions	Communication by outdoor unit main-sub control wiring was received that contained the same address as that unit 5 times or more within 3 minutes.
Probable cause	The unit number is set incorrectly.
Check	Check the unit number again.
Correction	Correct the incorrect unit number setting.
Example	—
Notes	Recovery from this alarm occurs automatically (when communication that contains the same address is not received for 3 minutes).

E26 Alarm

Alarm code	E26
Alarm meaning	Mismatch in outdoor unit quantity
Alarm conditions	After power initialization, the set outdoor unit quantity did not match the number of outdoor units detected on the outdoor unit main-sub control wiring for 3 minutes or longer.
Probable cause	(1) The outdoor unit quantity is set incorrectly. (2) The outdoor unit main-sub control wiring is cut.
Check	(1) Check the outdoor unit quantity setting again. (2) Check the outdoor unit main-sub control wiring.
Correction	(1) Correct the incorrect outdoor unit quantity setting. (2) Repair the outdoor unit main-sub control wiring.
Example	—
Notes	Recovery from this alarm occurs automatically (when the set outdoor unit quantity matches the number of outdoor units detected on the outdoor unit main-sub control wiring).

E29 Alarm

Alarm code	E29
Alarm meaning	Outdoor unit failed to receive communication from outdoor unit (main).
Alarm conditions	Outdoor unit communications from outdoor unit (main) were interrupted for 3 minutes or longer.
Probable cause	(1) After initial communications were completed, the outdoor unit main-sub control wiring was cut. (2) After initial communications were completed, the RC connector became disconnected. (3) The power at the outdoor unit (main unit) is turned OFF.
Check	(1) Check the outdoor unit main-sub control wiring. (2) Check the RC connectors. (3) Check the power at the outdoor unit (main).
Correction	(1) Repair the outdoor unit main-sub control wiring. (2) Correct the RC connector connection. (3) Turn ON the outdoor unit (main) power.
Example	—
Notes	—

E31 Alarm

Alarm code	E31
Alarm meaning	Communication error between two microcomputers on the Control P.C. Board
Alarm conditions	—
Probable cause	When does it occur? (1) When failed in rewriting microcomputer. (2) When the unit power shut down during rewriting microcomputer. (3) When wiring between PCB and ROM writer disconnected.
Check	(1) Rewrite microcomputer again. (2) Switch on the unit power again.
Correction	Replace Control PCB.
Example	—
Notes	—

3. 2WAY Alarm Codes

F04, F05, F22 Alarm

Alarm code	F04, F05, F22
Alarm meaning	Compressor 1 discharge temperature sensor trouble, compressor 2 discharge temperature sensor trouble, Compressor 3 discharge temperature sensor trouble.
Alarm conditions	(1) Discharge temp. of 100°C or higher was detected 20 minutes or more after that compressor stopped operating. (2) Discharge temp. of 70°C or higher was detected after all compressors had been stopped for 60 minutes or longer. (3) A/D step is 10 steps or less (short circuit).
Probable cause	(1) Sensor malfunction <ul style="list-style-type: none"> • Sensor element malfunction • Sensor wiring is partially disconnected, resulting in increased electrical resistance. ☆ This alarm does not occur when the wiring is cut or when the connector is not connected to the outdoor unit PCB. (2) Crossed wiring or installation error <ul style="list-style-type: none"> • The discharge temperature sensor of that compressor is connected to the discharge tube of the other compressor. • The connector for the discharge temperature sensor of the problem compressor is connected to the outdoor unit PCB connector for the other compressor. (3) Outdoor unit PCB failure (4) The check valve on the discharge tube for that compressor is wet. (5) An air short blockage in the area around the outdoor unit has increased the outdoor unit ambient temperature, reducing the cooling effects after the compressor stops. (6) There is a cause that results in P03, P17, or P02 alarm. (7) Electrical noise
Check	(1) Sensor malfunction and outdoor unit PCB failure Trouble: <ul style="list-style-type: none"> • Constantly indicates a high temperature. • When monitoring software or other means are used for monitoring, the discharge temperature at times fluctuates suddenly and wildly. • In some cases, the precise temperature may not be known, even when monitoring software is used. Check: <ul style="list-style-type: none"> • Wiggle the sensor and check whether the trouble continues. • Check whether the connector is partially disconnected from the PCB. ☆ An F04 alarm will not result if the connector is completely disconnected (circuit is open). • If the cause is still uncertain, check the following to determine whether a sensor or PCB failure has occurred. Step 1: Connect the other compressor discharge sensor, or a discharge sensor where the F04 alarm has not occurred, to the connector for this compressor on the PCB. Measure the temperature at the same point (a location where temperature fluctuations are small), and check whether there is a temperature difference. Difference → A PCB or sensor failure is possible. No difference → PCB and sensor are normal. Step 2: If an abnormality was found at Step 1, connect the problem compressor sensor to the other compressor connector on the PCB, or to the PCB connector of a device where the F04 alarm has not occurred. Measure the temperature at the same point (a location where temperature fluctuations are small), and check whether there is a temperature difference. Difference → Sensor failure. No difference → PCB failure. ☆ It is convenient at this time to have a discharge temperature sensor on hand. (2) Crossed wiring or installation error Trouble: Although the other compressor is operating and this compressor is stopped, the discharge temperature of the other compressor does not increase and the discharge temperature of this compressor rises. * The discharge temperature remains high immediately after the compressor stops. Wait for some time after the compressor stops and observe. Check: Check for crossed wiring and installation errors.

Continued

3. 2WAY Alarm Codes

Check	(3) Leakage from the discharge tube check valve Trouble: Although the other compressor is operating and this compressor is stopped, the discharge temperature of this compressor rises together with the temperature of the other compressor. (4) The ambient temperature around the outdoor unit when it is stopped is 43 °C or higher. (5) If the cause is still unknown after checking the above, then it is possible that electrical noise is the cause of the trouble. It is necessary to provide a line filter or carry out other noise countermeasures.
Correction	(1) Replace the sensor. (2) Replace the outdoor unit PCB. (3) Carry out noise countermeasures. (4) Repair the refrigerant tubing. (5) Adjust the amount of refrigerant. (6) Correct the trouble.
Example	(1) Sensor wiring is partially cut.
Notes	This alarm does not indicate that the sensor is disconnected. In order to prevent overheating during operation, the outdoor units in this system will not allow a compressor to start if the discharge temperature does not decrease while the compressor is stopped. If a sensor malfunction results in continuous detection of a high discharge temperature, then the compressor may stop for no apparent reason. The purpose of this alarm is to facilitate identification of the problem in this case.

F06, F23 Alarm

Alarm code	F06, F23
Alarm meaning	Gas temperature sensor trouble at outdoor heat exchanger 1; Gas temperature sensor trouble at outdoor heat exchanger 2.
Alarm conditions	(1) A/D step is 10 steps or less (short circuit). (2) A/D step is 1014 steps or more (open circuit).
Probable cause	(1) Sensor malfunction (including connector) (2) PCB malfunction
Check	(1) Measure the sensor resistance. Check that the sensor is operating normally. (2) Use a remote controller monitor or PC monitor to check the temperature that is recognized by the microcomputer.
Correction	—
Example	—
Notes	—

F07, F24 Alarm

Alarm code	F07, F24
Alarm meaning	Liquid temperature sensor trouble at outdoor heat exchanger 1; Liquid temperature sensor trouble at outdoor heat exchanger 2.
Alarm conditions	(1) A/D step is 10 steps or less (short circuit). (2) A/D step is 1014 steps or more (open circuit).
Probable cause	(1) Sensor malfunction (including connector) (2) PCB malfunction
Check	(1) Measure the sensor resistance. Check that the sensor is operating normally. (2) Use a remote controller monitor or PC monitor to check the temperature that is recognized by the microcomputer.
Correction	—
Example	—
Notes	—

3. 2WAY Alarm Codes

F08 Alarm

Alarm code	F08
Alarm meaning	Outdoor air temperature sensor trouble
Alarm conditions	(1) A/D step is 10 steps or less (short circuit). (2) A/D step is 1014 steps or more (open circuit)
Probable cause	(1) Sensor malfunction (including connector) (2) PCB malfunction
Check	(1) Measure the sensor resistance. Check that the sensor is operating normally. (2) Use a remote controller monitor or PC monitor to check the temperature that is recognized by the microcomputer.
Correction	—
Example	—
Notes	—

F12 Alarm

Alarm code	F12
Alarm meaning	Compressor intake temperature sensor trouble
Alarm conditions	(1) A/D step is 10 steps or less (short circuit). (2) A/D step is 1014 steps or more (open circuit)
Probable cause	(1) Sensor malfunction (including connector) (2) PCB malfunction
Check	(1) Measure the sensor resistance. Check that the sensor is operating normally. (2) Use a remote controller monitor or PC monitor to check the temperature that is recognized by the microcomputer.
Correction	—
Example	—
Notes	—

3. 2WAY Alarm Codes

F16 Alarm

Alarm code	F16
Alarm meaning	High-pressure sensor trouble (abnormal rise in high pressure) (In some cases this may not be the result of a high-pressure sensor malfunction.)
Alarm conditions	<ul style="list-style-type: none"> • High-pressure SW activated although the detected pressure was lower (3.03 MPa or below) than the high-pressure SW activation pressure: Undershift • High-pressure SW failed to activate although the detected pressure was higher (3.43 MPa or above) than the high-pressure SW activation pressure: Overshift • The saturation temperature at the detected pressure is 5°C or more below the highest indoor-unit E1 temperature continuously for 30 minutes. • High-pressure sensor disconnected or open circuit.
Probable cause	<ol style="list-style-type: none"> (1) High-pressure sensor malfunction (2) Failure to connect the connector to the outdoor unit PCB (3) Failure to open the service valve (4) Clogged tubing (5) Valve leakage (6) Over-charging (7) Outdoor unit PCB failure (8) Electrical noise
Check	<ol style="list-style-type: none"> (1) High-pressure sensor failure <ul style="list-style-type: none"> • Check the sensor resistance value. (Use a tester and measure the resistance between sensor No. 1 and No. 3) Resistance of less than 10kΩ indicates a short circuit or other trouble. Resistance of 10kΩ - 200kΩ is normal. Resistance of more than 200kΩ indicates an open circuit or other trouble. • Connect a gauge to the high-pressure outlet and check for changes in the value displayed by the monitoring software, and for large deviation of the gauge pressure. • During heating, check whether the temperature is lower than the highest indoor-unit E1 temperature. * The pressure detected by the high-pressure sensor is the highest pressure in the system. Therefore during heating the converted saturation temperature will never be lower than any indoor-unit E1 temperature. During cooling this temperature will never be lower than the outdoor unit liquid temperature. (2) Failure to open the service valve, clogged tubing, valve leakage, over-charging. In all of these cases an alarm occurs when there are rapid pressure fluctuations and tracking of the detected pressure is poor. <ul style="list-style-type: none"> • Check the open/closed status of the valve. • Check for clogging of the tubing. To check for clogging, disconnect the high-pressure sensor from the PCB and check whether the high-pressure SW activates. • Check for valve leakage and over-charging When valve leakage or over-charging occurs, refrigerant is likely to accumulate in the outdoor units or indoor units, resulting in a sudden rise in pressure at start that occurs before the refrigerant in the heat exchanger is discharged. * The representative valves to check are the liquid valves and mechanical valves. (3) Outdoor unit PCB failure <ul style="list-style-type: none"> • The check items are the same as for a high-pressure sensor malfunction. A normal PCB is needed to determine whether the problem is a PCB failure or a pressure sensor malfunction. If an abnormality was found at the check items for a high-pressure sensor malfunction, first try replacing the PCB and check again. Trouble is corrected: Outdoor unit PCB failure Trouble is not corrected: High-pressure sensor malfunction

Continued

3. 2WAY Alarm Codes

Correction	<p>(1) Replace the high-pressure sensor. Caution: Because the high-pressure sensor connection employs a Schrader-type valve, it can be removed and replaced. However, the high-pressure sensor can be easily damaged by high voltage; therefore use sufficient caution with regard to static electricity.</p> <p>(2) Replace the PCB.</p> <p>(3) Correct the locations of problems in the refrigeration cycle.</p> <ul style="list-style-type: none"> • Correct locations where clogging or leakage has occurred. • In the case of over-charging, recover refrigerant. (Adjust the amount of refrigerant). <p>* Guide for over-charging Be sure to connect the gauge to the high-pressure pressure outlet when checking for over-charging.</p> <p>During cooling: The following does not apply when outdoor air temperature is low or when fan speed is controlled. When both compressor 1 and compressor 2 are operating, and the fan mode is 14 (maximum fan speed), then the high pressure saturation temperature should be approximately 15°C above the outdoor air temperature. If it is 5°C or more above this level, then it is possible that over-charging may have occurred.</p> <p>During heating: There is an indoor unit where refrigerant flow is poor (E1 temperature and discharge temperature are low), and the mechanical valve of that unit is opened to 300 pulses or more, and the E1 temperature is close to room temperature. However be aware that this kind of data results often when there is a height difference between indoor units. Reducing the amount of refrigerant will improve the refrigerant flow, however reducing it too much will increase the likelihood of alarms related to low oil level (scroll-side), the low pressure SW, and discharge temperature. Use caution.</p>
Example	This alarm may result when the service valve is closed or when valve leakage (particularly from the mechanical valve) occurs.

F17 Alarm

Alarm code	F17
Alarm meaning	Low-pressure sensor trouble
Alarm conditions	(1) Sensor short circuit (2) Sensor open circuit
Probable cause	(1) Sensor malfunction (including connector) (2) PCB malfunction
Check	(1) Measure the sensor resistance. Check that the sensor is operating normally. (2) Use a remote monitor or a PC monitor to check the temperature that is recognized by the microcomputer.
Correction	—
Example	—
Notes	—

F31 Alarm

Alarm code	F31
Alarm meaning	Outdoor unit non-volatile memory (EEPROM) trouble
Alarm conditions	(1) Non-volatile memory is not present when power initialization occurs. (2) Read values do not match after writing to non-volatile memory is complete.
Probable cause	(1) Memory was not inserted after the PCB was replaced. (2) The lifetime of the non-volatile memory has been reached. (3) Non-volatile memory is installed incorrectly (wrong direction, bent pins, etc.).
Check	(1) Check the non-volatile memory on the PCB.
Correction	—
Example	—
Notes	—

3. 2WAY Alarm Codes

H11, H12, H21, H22 Alarm

Alarm code	H11, H12, H21, H22
Alarm meaning	H11: Constant speed compressor 2 overcurrent alarm H12: Constant speed compressor 2 lock current alarm H21: Constant speed compressor 3 overcurrent alarm H22: Constant speed compressor 3 lock current alarm
Alarm conditions	Hx1: During operation, the compressor current value exceeded 12 A for 30 seconds or longer. However this alarm is not detected for 4 seconds after the compressor starts. Hx2: During operation, the compressor current value exceeded 14 A for 4 seconds or longer. However this alarm is not detected for 2 seconds after the compressor starts.
Probable cause	(1) Compressor failure (locked or partially locked) (2) CT circuit failure (including cut wiring) (3) Missing power phase (4) Low power voltage (5) PCB failure
Check	(1) Compressor failure (partially locked) Trouble: Current value during operation greatly exceeds the value shown above. Check: When the current for each phase is measured with a clamp meter or similar instrument, check that the current value for all phases is not high. If MG was forced ON (use caution), check that compressor noise will not occur or the compressor will not run with a groaning sound. (2) CT circuit failure, PCB failure Trouble: Check: <ul style="list-style-type: none"> • Check for poor connector contact. • Check the continuity of the CT circuit. • Install a normal CT in place of this CT and check. If current is detected, then the PCB can be judged OK. →CT circuit failure • Check that current is flowing in the phase where the CT circuit is connected. →Check voltage and current. (3) Missing power phase Trouble: This alarm primarily occurs when the T-phase is missing. When the R-phase or S-phase is missing, CT trouble or PCB continuity trouble occur. However this may not be true in the case of a missing phase caused by magnet SW trouble. Check: There is the possibility of a magnet SW failure. Therefore, check the phase voltage at a location that is as close to the compressor as possible. (4) Low power voltage Trouble: In most cases, this occurs when another constant-speed compressor (including compressors in other units) or other device starts. It also occurs when the power wiring is extremely long. Check: Check the voltage between each of the phases. However if this trouble occurs when other devices or compressors start, then an oscilloscope is required. (5) PCB failure Trouble: Check: Check that the current value measured with the clamp meter is not lower than the value measured with the PC or remote controller. (6) If the cause is still unknown after checking the above, then it is possible that noise is the cause of the trouble. It is necessary to connect a PC or other instrument.
Correction	(1) Replace the compressor. (2) Replace the CT circuit. (3) Repair the power circuit. (4) Adjust the primary-side power. Repair the power wiring. (5) Replace the outdoor unit PCB. (6) Correct the trouble. * In the case of a compressor failure, it is likely that steps must be taken to correct the cause of the compressor failure (such as liquid back-up) in order to prevent recurrence. Be sure to check that there is no cause which may result in compressor locking.
Example	—

3. 2WAY Alarm Codes

H03, H13, H23 Alarm

Alarm code	H03, H13, H23
Alarm meaning	Compressor 1 CT sensor disconnected or short-circuit; Compressor 2 CT sensor disconnected or short-circuit; Compressor 3 CT sensor disconnected or short-circuit
Alarm conditions	Current value at compressor 1 was 18 A or less, and at compressors 2 and 3 was 2 A or less when 2 seconds or more had passed after the compressor began operation and output. * No current is detected even though the compressor is operating.
Probable cause	(1) CT circuit failure (including cut wiring, etc.) (2) Disconnected CT circuit connector (3) Missing phase where CT circuit is connected (4) This CT circuit is connected to the connector of the other CT circuit. (5) PCB failure (6) Electrical noise
Check	(1) CT circuit failure, PCB failure Trouble: • Current value during compressor operation is below the threshold value. Check: • Check that the connector is not disconnected. • Check the continuity of the CT circuit. • Install a normal CT in place of this CT and check. If current is detected, then the PCB can be judged OK. →CT circuit failure • Check that current is flowing in the phase where the CT circuit is connected. →Check voltage and current. (2) Crossed wiring or installation error Trouble: When the compressor is stopped, the current value at the other compressor is high. ☆ When this type of condition occurs, seizing-detection control takes priority. (3) If the cause is still unknown after checking the above, then it is possible that noise is the cause of the trouble. It is necessary to connect a PC or other instrument.
Correction	(1) Replace the CT circuit. (2) Replace the outdoor unit PCB. (3) Correct the problem.
Example	(1) The connector was not inserted after the PCB was replaced.
Notes	Use a normal CT as a tool to determine whether the trouble is a PCB failure or CT failure.

3

H05, H15, H25 Alarm

Alarm code	H05, H15, H25
Alarm meaning	Compressor 1 discharge temperature sensor disconnected; Compressor 2 discharge temperature sensor disconnected; Compressor 3 discharge temperature sensor disconnected
Alarm conditions	• This alarm occurs when the discharge sensor temperature detector is not inserted into the tube's sensor holder, or when the sensor itself has suffered some kind of malfunction other than a cut wire. • When outdoor air temperature is 10°C or higher: Alarm occurs if the temperature detected by the discharge sensor has changed by less than 2°C when the compressor has operated for 10 minutes immediately after start. • When outdoor air temperature is below 10°C: Alarm occurs if the temperature detected by the discharge sensor has changed by less than 2°C when the compressor has operated for 30 minutes immediately after start.
Probable cause	(1) Discharge sensor temperature detector is not inserted into the tube's sensor holder. (2) Discharge sensor itself has suffered some kind of malfunction other than a cut wire.
Check	(1) Check that the discharge temperature sensor is inserted into the sensor holder. (2) Check that sufficient heat-conducting putty is applied. (3) Remove the discharge sensor from the sensor holder and expose the sensor to the outside air for approximately 5 minutes. Check that the temperature detected by the sensor changes to match the outside air temperature. (However the sensor cannot detect temperatures at or below 0 °C.)
Correction	(1) Install the sensor into the holder, and apply sufficient heat-conducting putty. (2) If the sensor is malfunctioning, replace it.
Example	
Notes	The discharge temperature sensor is generally a sensor intended for accurate detection of high temperatures. Therefore, it will not accurately detect the temperature if the temperature at the measurement point is 20 °C or below.

3. 2WAY Alarm Codes

H06 Alarm

Alarm code	H06
Alarm meaning	Low-pressure switch activated
Alarm conditions	<p>A report occurs during A/C operation when the low-pressure sensor installed at constant low-pressure parts detects a pressure of 0.05 MPa or less continuously for 2 minutes, or an instantaneous pressure of 0.02 MPa or less. (These values represent abnormal low pressure which may damage the compressor.)</p> <p>However, the alarm does not actually occur the first 2 times that the above operation takes place. At these times, the outdoor unit is stopped and the conditions are monitored. The alarm occurs when the above operation occurs for the fifth time. The first 4 times before the alarm occurs are called "pre-trip." After pre-trip occurs, if the low-pressure sensor detects a pressure of 0.15 MPa or more for 3 minutes of continuous operation, the pre-trip count is reset to 0.</p> <p>If the low-pressure sensor detects a pressure of 0.16 MPa or less continuously for 30 minutes when the compressor is stopped, an alarm occurs immediately (no pre-trip).</p>
Probable cause	<p>The A/C unit low pressure has dropped to a level that does not occur under ordinary conditions.</p> <p>(1) The absolute amount of gas in the system is too low (as a result of insufficient refrigerant charge or leak).</p> <p>(2) The refrigerant has accumulated in the circuit and has not returned to the compressor. Refrigerant has accumulated in a location of one-way flow and cannot escape. High-pressure level is low, resulting in poor flow of refrigerant in the circuit. (A lower high-pressure level results in a smaller difference between low pressure and high pressure, that may be insufficient to cause refrigerant flow.)</p> <p>(3) The refrigerant circuit has become closed, and refrigerant has not returned to the compressor. In some cases when moisture enters the refrigerant circuit, it can freeze at the low-pressure locations and the resulting ice can block the circuit.</p> <p>☆ If the alarm occurs when there is sufficient refrigerant in the system ((1) and (3)), liquid refrigerant has definitely accumulated somewhere in the system. Liquid refrigerant generally accumulates in high-pressure locations. In this case the high pressure gradually increases (however it may not increase if the location where the liquid accumulates is sufficiently large). Depending on the refrigerant saturation temperature, it may also accumulate in low pressure locations. In this case the high pressure is unlikely to increase.</p>
Check	<p>(1) Check that the service valve is open.</p> <p>(2) Check that none of the valves (solenoid valves, mechanical valves) in the main refrigerant circuit is closed due to an operation failure.</p> <p>(3) Check that there is no possibility of foreign objects or water having entered the refrigerant circuit.</p> <p>(4) Check that valve leakage at a stopped sub unit has not resulted in accumulation of refrigerant at that sub unit.</p> <p>(5) Check that no refrigerant leakage has occurred.</p>
Correction	<p>(1) If there was a valve operation failure, in general it is necessary to replace the valve.</p> <p>(2) If a foreign object or moisture has entered the circuit, install a strainer or dry core (depending on the degree of the problem).</p> <p>(3) If refrigerant has leaked into stopped sub units, it is likely that valve leakage has occurred. The valve must be replaced.</p>
Example	
Notes	

3. 2WAY Alarm Codes

H08, H27, H28 Alarm

Alarm code	H08, H27, H28
Alarm meaning	Trouble (open circuit) with the oil sensor (connection) at compressor 1, compressor 2, or compressor 3
Alarm conditions	This alarm occurs when a connector connection (pins 1 and 2 for compressor 1, pins 4 and 5 for compressor 2, and pins 7 and 8 for compressor 3) is open.
Probable cause	Disconnected connector
Check	Check that the connector is securely connected.
Correction	(1) Connect the connector. (2) Correct the connection at connector pins 4 and 5.
Example	—
Notes	

3. 2WAY Alarm Codes

H31 Alarm

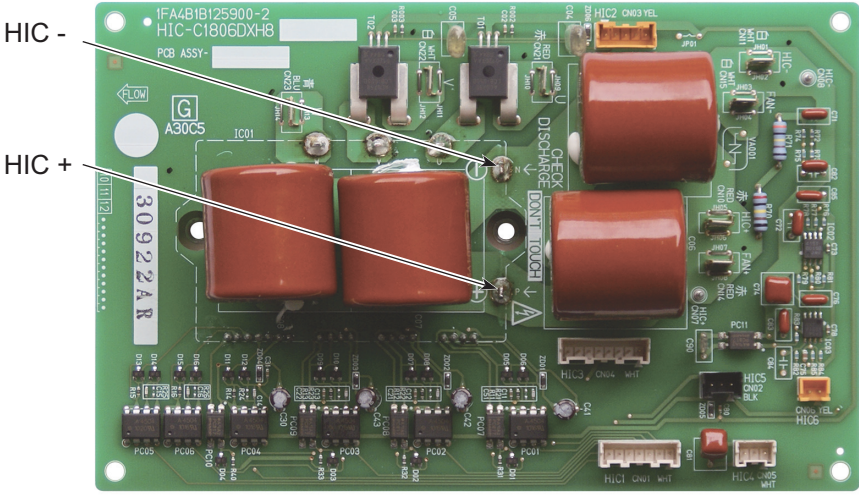
Alarm code	H31
Alarm meaning	HIC trouble alarm
Alarm conditions	This alarm occurs when the microcomputer identifies a trouble signal (indicating abnormal HIC temperature or other trouble) from the HIC. The HIC judges the current and temperature, and outputs the trouble signal. In general this indicates trouble with the HIC itself.
Probable cause	Overcurrent in HIC circuit, and the resultant abnormal heating, caused by HIC failure
Check	Check the power wiring and connector wiring. If the wiring and connectors are normal, use a tester to measure the resistance between the compressor HIC power (HIC+) and ground (HIC-). If there is a short-circuit, there is an HIC malfunction.
	 <p style="text-align: center;">HIC PCB</p>
Correction	If an HIC failure is found, replace the PCB.
Example	—
Notes	Turn OFF the power, and check the continuity of HIC+ and HIC- on the HIC PCB.

L04 Alarm

Alarm code	L04
Alarm meaning	Outdoor system address duplication
Alarm conditions	Communication by inter-unit control wiring was received that contained the same address as that unit 5 times or more within 3 minutes.
Probable cause	Incorrect outdoor system address settings
Check	Check the system address settings again.
Correction	Correct the system address settings.
Example	—
Notes	Recovery from this alarm occurs automatically (when communication that contains the same address as that unit is not received for 3 minutes after detection).

3. 2WAY Alarm Codes

L10 Alarm

Alarm code	L10
Alarm meaning	Outdoor unit capacity not set
Alarm conditions	The outdoor unit capacity has not been set, or the setting is not allowed by the system.
Probable cause	This alarm occurs because the capacity has not been set.
Check	Connect the outdoor unit maintenance remote controller. On the outdoor unit EEPROM detailed setting mode screen, check the value for the outdoor unit capacity (item code 81). Check that it is not set to "0" or to a capacity that is not allowed.
Correction	If item code 81 is incorrect, use the outdoor unit maintenance remote controller and set it correctly. * After changing the setting, be sure to reset both the indoor and outdoor power.
Example	—
Notes	The outdoor unit maintenance remote controller is required in order to set the capacity in the outdoor unit EEPROM.

L17 Alarm

Alarm code	L17
Alarm meaning	Outdoor unit model mismatch
Alarm conditions	This alarm occurs when a unit other than a R410A refrigerant model is connected.
Probable cause	(1) A unit that uses R407C refrigerant, or a R22 model unit, was connected by mistake. (2) The connected unit is correct, however the refrigerant type setting in the outdoor unit EEPROM (item code 80) is incorrect.
Check	(1) Check the refrigerant type at the connected unit. (2) Use the outdoor unit maintenance remote controller and check the item code 80 refrigerant type. If the setting is incorrect, change it to R410A.
Correction	—
Example	—
Notes	The outdoor unit maintenance remote controller is required in order to set the refrigerant type in the outdoor unit EEPROM.

L18 Alarm

Alarm code	L18
Alarm meaning	4-way valve operation failure
Alarm conditions	During heating operation (Comp. ON), the highest detected temperature at an outdoor unit heat exchanger (EXG 1, EXG 2, EXL 1, or EXL 2) was 20°C or more above the outdoor air temperature (Air Temp.) continuously for 5 minutes or longer, or the detected suction temperature (SCT) was 20°C or more above the outdoor air temperature continuously for 5 minutes or longer.
Probable cause	(1) The 4-way valve connector (20S CN022) has become disconnected from the control PCB. (2) The 4-way valve circuit is locked (malfunctioning).
Check	(1) Check the 4-way valve connector (20S CN022). (2) If the connector is normal, check the 4-way valve wiring and the PCB circuit.
Correction	If the connector is normal, correct or replace the problem locations.
Example	—
Notes	—

P02 Alarm

Alarm code	P02
Alarm meaning	Compressor thermal protector is activated. (trip only and no alarm)
Alarm conditions	When the current is not detected over 4 seconds long after the compressor ON.
Probable cause	Activating condition of the compressor thermal protector (The voltage is more than 260V or less than 160V between L and N phase.)
Check	(1) Check the constant speed compressor. (2) Check the current transformer.
Correction	• Put the constant speed compressor OFF over 60 minutes and cool the thermostat. • Replace defective parts with new ones.
Example	—
Notes	—

3. 2WAY Alarm Codes

P03, P17, P18 Alarm

Alarm code	P03, P17, P18
Alarm meaning	Compressor 1 discharge temperature trouble; Compressor 2 discharge temperature trouble; Compressor 3 discharge temperature trouble
Alarm conditions	Temperature is 106°C or higher and pre-trip stop has occurred. The alarm occurs when pre-trip stop occurs more than once. However the pre-trip counter is cleared if the compressor operates continuously for a specified length of time.
Probable cause	<ol style="list-style-type: none"> (1) Clogging of liquid valve capillaries (2) Insufficient amount of refrigerant (including trouble resulting from an insufficient initial charge and from gas leakage) (3) Blocking of low-pressure parts caused by intrusion of foreign objects (moisture, scale, etc.) (4) Crossing (tubing or PCB connectors) with the other compressor thermistor (5) Expansion valve operation failure (6) Accumulation of refrigerant at stopped outdoor units (7) Compressor discharge sensor failure (8) PCB failure (A/D conversion failure) (9) Electrical noise
Check	<ol style="list-style-type: none"> (1) Clogging of capillaries Trouble: Compressor discharge temperature does not decrease even when the liquid valve is ON. Check: When the liquid valve is operating and the liquid valve is ON, check that the secondary side of the liquid capillaries is cold. (2) Insufficient refrigerant Trouble: Liquid effectiveness is poor. Check: Check whether or not the superheating temperature is declining if the evaporator mechanical valve is opened to 300 pulses or more (after checking for foreign object intrusion). (3) Foreign object intrusion Trouble: Liquid valve effectiveness is poor. Check: Check that there is no difference in the condensation or frost conditions between the strainer primary-side and secondary-side tubing. (4) Crossed thermistor Trouble: The discharge temperature of the other compressor is high although only this compressor is operating. When the liquid valve turns ON, the discharge temperature of the other compressor decreases. (5) Accumulation of refrigerant in stopped outdoor units Trouble: <ul style="list-style-type: none"> • System is OK when all outdoor units are operating, however symptoms of insufficient gas occur when a certain outdoor unit is stopped. • Condensation or frost is visible up to the top of the accumulator of the stopped outdoor unit. • After an outdoor unit stops, there is the sound of refrigerant flowing into an outdoor unit that was stopped for a long time. • When an outdoor unit starts after being stopped for a long time, the start is accompanied by much vibration. Check: <ul style="list-style-type: none"> • Representative parts include the liquid capillaries (secondary side of capillaries will be cool during cooling operation), mechanical valve, mechanical valve bypass check valve (sound of refrigerant flow can be heard, and stops when the liquid valve is closed), hot gas defrost valve (if valve secondary side remains hot even after much time has passed, be careful not to mistake transmitted heat for a valve failure). • Ice is growing on the lower parts of some outdoor unit heat exchangers but not on others. Because this trouble may occur even in outdoor units with a high operating rate under conditions of insufficient gas, caution is needed. (6) Sensor failure Check: <ul style="list-style-type: none"> • This alarm is likely to occur when wiring is partially cut. (It is difficult to identify, even when continuity is checked.) The detected discharge temperature is high. • Although such conditions rarely occur, a P02 alarm is likely if the detected discharge temperature is low. • Replace the sensor with another discharge sensor and compare the temperature conditions. (7) If the cause is still unknown after checking the above, then it is possible that electrical noise is the cause of the trouble.
Correction	<ol style="list-style-type: none"> (1) Replace the sensor. (2) Replace the outdoor unit PCB. (3) Correct the problem locations.
Example	All of the probable causes
Notes	Operates continuously for a set length of time. Indicates 2.5 minutes or longer for an inverter unit and 30 seconds or longer for a constant-speed compressor.

3. 2WAY Alarm Codes

P04 Alarm

Alarm code	P04
Alarm meaning	High-pressure switch activated.
Alarm conditions	The operation of the electronic circuit in the high-pressure switch may short-circuit the terminal depending on the pressure. A pressure of 3.3 MPa or above will short-circuit the terminal. Once the terminal is short-circuited, it will remain in that state until the pressure goes below 2.6 MPa.
Probable cause	<ol style="list-style-type: none"> (1) Failure of the check valve in the compressor discharge tube. (2) The service valve is closed. (3) Clogging of the outdoor heat exchanger during cooling. (4) An air short in the outdoor unit during cooling. (5) Failure of the outdoor fan during cooling. (6) Clogging of the air filter in the indoor unit during heating. (7) An air short in the indoor unit during heating. (8) Failure of the indoor fan during heating. (9) Clogging of the refrigerant circuit. (10) Failure of the mechanical valve. (11) Failure of the solenoid valve kit. (12) Too much refrigerant has been charged. (13) Failure of the high-pressure switch.
Check	<ol style="list-style-type: none"> (1) Make sure that the high-pressure switch connector has been properly connected. (2) If the high-pressure switch is properly connected, connect a high-pressure gauge to the high-pressure outlet port and monitor the pressure during operation to check the pressure when the high-pressure switch is activated. Check valve failure is likely if the pressure is less than 3.3 MPa. The following describes checks to be made when the pressure is high. (3) During cooling, check whether the outdoor unit heat exchanger is clogged. Remove any foreign material that prevents ventilation. (4) During cooling, check whether an air short blockage has occurred in the outdoor unit. The system is operating normally unless the temperature around the outdoor unit is excessively high. (5) During cooling, check for outdoor fan failure. Check whether the screws securing the fan are loose and whether the fan connector in the outdoor unit PCB is properly connected. (6) During heating, check whether the air filters in the indoor unit are clogged. If clogged, clean the filters. (7) During heating, check whether an air short blockage has occurred in the indoor unit. The system operates normally unless the temperature around the indoor unit is excessively high. (8) During heating, check for indoor fan failure. (9) Check whether the refrigerant circuit is clogged. Check that all service valves are closed. Check whether welded locations are clogged. (10) Check for mechanical valve failure. Check whether the mechanical valves make a clattering sound when the power is reset. Since the mechanical valve in the indoor unit is in a location that makes aural inspection difficult, use an electric means to check. Check that the connector pin of the mechanical valve on the PCB outputs 4 V. In addition, check that the coil resistance of the mechanical valve is several tens of Ω. (11) Check for solenoid valve kit failure. Removing a coil that is on will result in a clicking sound. Also, removing a coil that is off will not produce such a sound. (12) Check whether too much refrigerant has been charged. Too much refrigerant has been charged if the sub-cool temperature of the condenser is 15°C or more.
Correction	Replace damaged components and correct the amount of charged refrigerant.
Example	—
Notes	—

P05 Alarm

Alarm code	P05
Alarm meaning	Reverse phase (or missing phase) detected
Alarm conditions	This alarm occurs when a reverse phase or missing phase is detected in the L1-L2-L3-N phases.
Probable cause	Reverse phase or missing phase in the L1-L2-L3-N phases
Check	Check the wiring at the power terminal plate.
Correction	Switch the phases and reinsert. Check if the result is OK.
Example	—
Notes	—

3. 2WAY Alarm Codes

P14 Alarm

Alarm code	P14
Alarm meaning	O ₂ sensor operation
Alarm conditions	(1) It is judged an error whenever the outdoor unit receives the signal "O ₂ Alarm Generated" from the indoor unit. (2) With the indoor unit's EEPROM setting (item code 0B) set to 0001, the EXCT input was shorted.
Probable cause	—
Check and Correction	(1) System configuration 1-1 Is an O ₂ sensor being used? If "Yes", see "3-1". If "No", see "2-1". (2) Indoor EEPROM setting 2-1 Is the EEPROM setting, item code 0B, on the indoor control board set to 0001? If "Yes", see "3-1" after modification. If "No", see "4-1". (3) EXCT wiring 3-1 Is the EXCT socket (wire) shorted? If "Yes", Modify the wiring. If "No", see "4-1". (4) Indoor control board 4-1 Is the alarm triggered if the EXCT socket (wire) is disconnected, and the power is reset? If "Yes", see "4-3". If "No", see "4-2". 4-2 Since there is no error, see what happens. 4-3 Indoor control board defective → replace board
Example	—
Notes	—

P16 Alarm

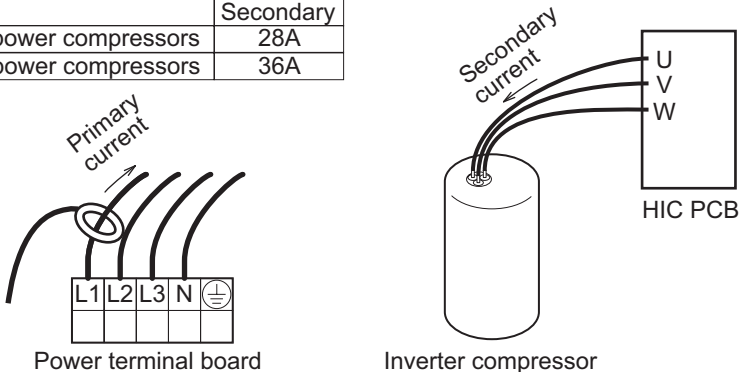
Alarm code	P16															
Alarm meaning	Compressor 1 (INV) overcurrent alarm															
Alarm conditions	This alarm occurs when current trouble or current detection trouble occur (when trouble judgment current is detected in the primary or secondary current, or when an instantaneous secondary current of 18A* or higher is detected). * Changed to output error by current regardless of the inverter frequency. In addition, there are 6 horsepower and 10 horsepower compressors. (1) When more than the over-current values shown in the table were detected in the primary and secondary current. <table border="1" style="margin-left: 20px;"> <thead> <tr> <th></th> <th>Primary</th> <th>Secondary</th> </tr> </thead> <tbody> <tr> <td>6 horsepower compressors</td> <td>18A</td> <td>18A</td> </tr> <tr> <td>10 horsepower compressors</td> <td>21A</td> <td>21A</td> </tr> </tbody> </table> (2) When more than the current values shown in the table are instantly detected in the secondary current. <table border="1" style="margin-left: 20px;"> <thead> <tr> <th></th> <th>Secondary</th> </tr> </thead> <tbody> <tr> <td>6 horsepower compressors</td> <td>28A</td> </tr> <tr> <td>10 horsepower compressors</td> <td>36A</td> </tr> </tbody> </table> 		Primary	Secondary	6 horsepower compressors	18A	18A	10 horsepower compressors	21A	21A		Secondary	6 horsepower compressors	28A	10 horsepower compressors	36A
	Primary	Secondary														
6 horsepower compressors	18A	18A														
10 horsepower compressors	21A	21A														
	Secondary															
6 horsepower compressors	28A															
10 horsepower compressors	36A															
Probable cause	There is a strong possibility of a compressor failure. An alarm occurs for current detection trouble when it is judged that no current is flowing after start (DCCT is damaged). In this case, the cause is a DCCT failure.															
Check	Check the power wiring and connector wiring.															
Correction	It is possible to resolve this trouble by limiting the maximum frequency.															
Example	—															
Notes	—															

3. 2WAY Alarm Codes

P20 Alarm

Alarm code	P20
Alarm meaning	High load alarm
Alarm conditions	The high pressure increase is not rapid but the alarm occurs when the horsepower down does not meet the anticipated time.
Probable cause	(1) Forgot to open the valve. (2) Operation failure of mechanical valve (3) Idle away of outdoor fan
Check	Check the valve, mechanical valve and outdoor fan.
Correction	—
Example	—
Notes	—

P22 Alarm

Alarm code	P22
Alarm meaning	Fan motor trouble
Alarm conditions	Fan motor start failure, fan motor Hall IC input failure
Probable cause	Possible causes are a Hall IC input circuit failure and a fan HIC failure.
Check	<p>Check the fan motor wiring, the Hall IC wiring, and the connector connections. If the wiring and connectors are normal, then check that the capacitor of the Hall IC input circuit is securely soldered on the outdoor unit control PCB. Also use a tester and measure the resistance between fan HIC power (HIC+) and ground (HIC-). If there is a short-circuit, there is an HIC malfunction.</p>
Correction	<p>If the fan does not start, the below corrections may be effective. (1) If there is a fan HIC failure or circuit failure, replace the PCB. (2) If the fan motor is locked, replace the fan motor.</p>
Example	—
Notes	Turn OFF the power, and check the continuity of “+” and “-” on the fan circuit PCB.

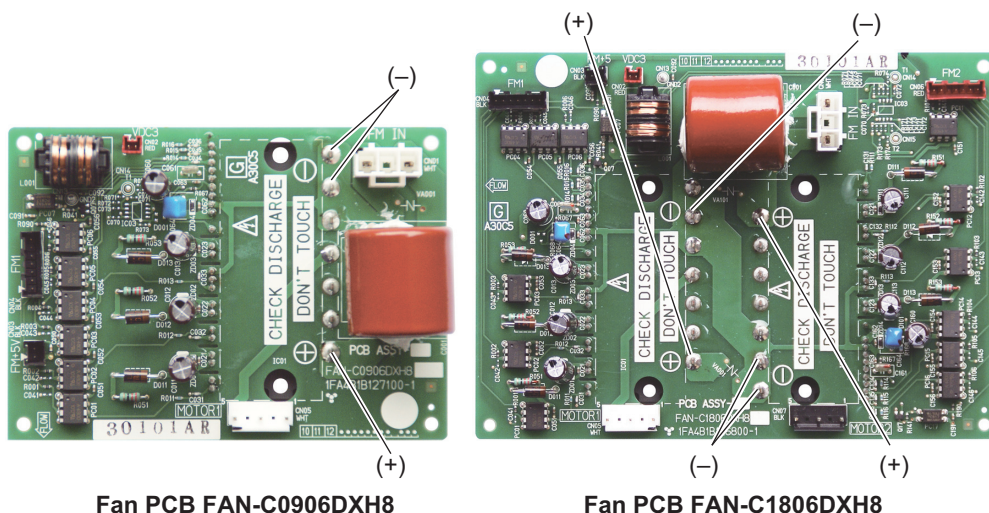

3. 2WAY Alarm Codes

P29 Alarm

Alarm code	P29
Alarm meaning	Inverter compressor missing phase or lock alarm
Alarm conditions	This alarm may occur at start, and occurs when missing phase or lock is detected, and when a DCCT failure occurs.
Probable cause	Generally this alarm occurs when the refrigerant pressure balance is uneven at start, or when inverter compressor lock occurs, there is a missing phase in the inverter compressor wiring, or a DCCT failure occurs. This can be judged to be starting trouble which is not caused by HIC.
Check	Check the power wiring and connector wiring.
Correction	DCCT failure (replace PCB) or compressor failure
Example	—
Notes	Use a tester to measure the voltage between the DCCT output terminal on the rear of the PCB and the ground. If the voltage is not within 2 – 3 V, then the DCCT has malfunctioned.

4. Blinking (Inspection) Display on The Remote Controller



CAUTION

Currently the blinking inspection display can be displayed only on the wired remote controller and system remote controller.

Blinking inspection display (1) (Automatic backup)

Alarm code	(Blinking inspection display)
Alarm meaning	Automatic backup is in progress. A/C units can be operated. Status: The compressor at one of the outdoor units where the outdoor unit fan is running should be operating. * Blinking inspection display also occurs when seizing of the compressor magnet SW is detected. Because this may also be the case, refer to "Blinking inspection display (compressor magnet SW seizing detection)."
Alarm conditions	When alarm P16, P22, P29, Hx1, Hx2, or H31 has occurred, correcting the control device (remote controller, etc.) input engages this mode.
Probable cause	Because alarm P16, P22, P29, Hx1, Hx2, or H31 has occurred, check the alarm history then refer to the corresponding items.
Correction	Follow the instructions in the corresponding items to correct the trouble.
Recovery	After repairing the malfunctioning locations, reset the power for the system (all outdoor units). Caution: Automatic backup mode will not be canceled until the power is reset.
Notes	Automatic backup mode is not engaged in cases of alarms other than those listed above. Reasons: <ul style="list-style-type: none"> • There is no need for automatic backup if recovery is possible by correcting the remote controller input. • With alarms for which automatic recovery is possible (such as sensor alarms), the presence of electrical noise may result in a new alarm. However, it is believed that this occurs for a comparatively short time only. In these cases, a mode (automatic backup mode) that limits operation may be engaged. • Control is not possible when a communications system alarm has occurred. Automatic backup mode is not engaged in order to avoid causing secondary damage.

4. Blinking (Inspection) Display on The Remote Controller

Blinking inspection display (2) (compressor magnet SW seizing detection)

Alarm code	(Blinking inspection display)
Alarm meaning	<p>Compressor magnet SW seizing detected</p> <p>Status: Although an outdoor unit exists where the outdoor unit fan is running, no compressors in the system are operating.</p> <p>☆ Because the fan is running only at the outdoor unit where seizing was detected, check the corresponding outdoor unit.</p> <p>* The fan may also run on its own when fan cracking prevention control is in effect or when snowfall sensor input is present. Therefore monitor for approximately 10 minutes if the outdoor unit fans are operating at multiple units.</p>
Alarm conditions	<p>Current is detected in the CT circuit when the compressor is stopped.</p> <p>(1) This control is not engaged for the first 30 seconds after the compressor turns ON → OFF.</p> <p>(2) For 1 minute following the first 30 seconds after the compressor turned ON → OFF, the threshold for the detected current is 10 A or more continuing for 2 seconds.</p> <p>(3) All times other than the above:</p> <ul style="list-style-type: none"> • If the low-pressure SW has not activated, the threshold for the detected current is 7A or more continuing for 5 seconds. • If the low-pressure switch has activated, the threshold for the detected current is 7A or more continuing for 2 seconds.
Probable cause	<p>(1) Magnet SW malfunction</p> <ul style="list-style-type: none"> • The magnet SW has seized, and the compressor is continuing to run. <ul style="list-style-type: none"> → Even when the power is turned OFF, the primary side and secondary side contacts remain together. • The conditions of magnet SW operation are poor (difficult to open). <ul style="list-style-type: none"> → When a magnet SW is used in a DC circuit, it may be difficult for the SW to open at times. In an AC circuit the magnet SW should open instantaneously as long as the current is within the allowable range. However, this kind of trouble can occur if excessive current flows, and may prevent the SW from opening. <p>(2) CT circuit failure or PCB failure (A/D failure)</p> <ul style="list-style-type: none"> • CT circuit contact failure <ul style="list-style-type: none"> → Check that the connector is not partially disconnected. Wiggle the connector to check the connection.* * These symptoms will not occur if the connector is completely disconnected or the wire is cut. In these cases alarm Hx3 occurs. • Current of 7A or higher was detected although the compressor was stopped, or a higher current was detected at occasional intervals. • The compressor continues to operate at a time when the outdoor unit should be stopped (such as when all indoor units are stopped). <ul style="list-style-type: none"> → Check whether or not 200 V is output from the PCB to the magnet SW. If the voltage is output, there is a PCB failure. <p>(3) Installation error</p> <ul style="list-style-type: none"> • CT2 connector is connected to the compressor 3 side • CT2 circuit is connected to the compressor 3 side • CT3 connector is connected to the compressor 2 side • CT3 circuit is connected to the compressor 2 side <p>(4) Electrical noise</p>
Correction	<p>(1) Replace the CT circuit.</p> <p>(2) Replace the magnet SW.</p> <p>(3) Replace the PCB.</p> <p>If the above probable causes are not the cause of the alarm, it is possible that in rare cases the alarm may be caused by the effects of noise. See notes.</p>
Notes	<p>The effects of electrical noise are difficult to identify unless a PC is connected and the conditions are monitored for a long period of time.</p>

– MEMO –

4. PCB Settings

1. Outdoor Unit Control PCB4-2

1. Outdoor Unit Control PCB

1-1. Outdoor Unit Control PCB CR-C1806DXH8

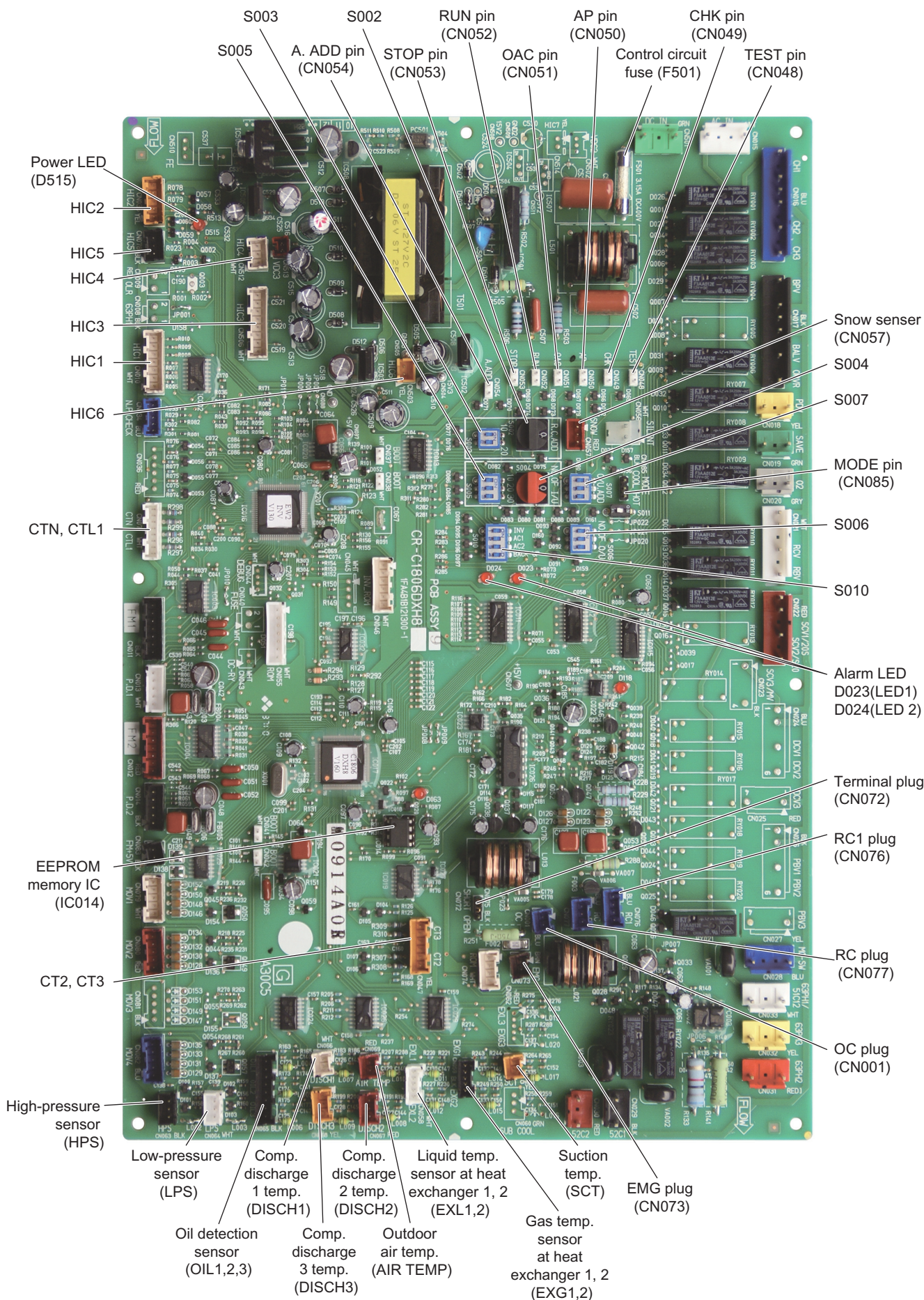

4

1. Outdoor Unit Control PCB

Functions (for CR-C1155DXHN8)

Automatic address setting (CN054)	<p>2P plug (white): Automatic address setting pin</p> <ul style="list-style-type: none"> Short-circuit this pin for 1 second or longer to automatically set the addresses at the indoor units that are connected to that outdoor unit and are within the same system. The system address is "1" at the time of shipment. Automatic address setting is necessary even for communications lines in a single system where the inter-unit control wiring does not cross to any other systems. While automatic address setting is in progress, the 2 LEDs (LED1, 2: red) on the outdoor unit control PCB blink alternately. (Short-circuiting this pin while automatic address setting is in progress will stop the automatic address setting operation.)
S002	<p>Rotary switch (10 positions, black): Outdoor system address setting switch</p> <ul style="list-style-type: none"> The setting is "1" at the time of shipment. It is not necessary to change the setting if wiring is connected only to an outdoor unit and indoor units in a single system and the inter-unit control wiring does not cross multiple systems. If wiring links the inter-unit control wiring for multiple systems to the same communications lines, then a different address must be set for each refrigerant tubing system. If wiring links multiple systems, a maximum of 30 systems (up to 64 indoor units) can be connected. This setting can be set up to "39," however control will be for 30 systems even if the setting is set to higher than 30. An alarm will be displayed if system addresses are duplicated. (For details, refer to Table 1.)
S003	<p>DIP switch (2P, blue): Switches for setting system address 10s digit and 20s digit</p> <ul style="list-style-type: none"> If 10 systems or more are set, the setting is made by a combination of this DIP switch and S002. If 10 - 19 systems are set, set switch 1 (10s digit) to ON. If 20 - 29 systems are set, set switch 2 (20s digit) to ON, and set switch 1 (10s digit) to OFF If 30 systems are set, set both switch 1 (10s digit) and switch 2 (20s digit) to ON. (For details concerning S002 and S003, refer to Table 1.)
S004	<p>Rotary switch (10 positions, red): Switch for setting the number of connected indoor units In order to allow the outdoor unit to manage indoor units in the same refrigerant system, set the number of connected indoor units. (For details, refer to Table 2.)</p>
S005	<p>DIP switch (3P, blue): Switches for setting the 10s, 20s, and 30s digit for the number of connected indoor units</p> <ul style="list-style-type: none"> If 10 systems or more are set, the setting is made by a combination of this DIP switch and S004. If 10 - 19 systems are set, set only switch 1 (10s digit) to ON. If 20 - 29 systems are set, set switch 2 (20s digit) to ON, and set switch 1 (10s digit) to OFF. If 30 - 39 systems are set, set only switch 3 (30s digit) to ON. (For details concerning S004 and S005, refer to Table 2.)
S006	<p>DIP switch (3P, blue): Switch for setting the number of outdoor units</p> <ul style="list-style-type: none"> Turn the switches ON according to the number of outdoor units (1 - 4). (For details, refer to Table 3.)
S007	<p>DIP switch (3P, blue): Unit No. setting switch</p> <ul style="list-style-type: none"> The setting is "1" at the time of shipment. (For details, refer to Table 4.)
S010	<p>DIP switch (4P, blue): Backup operation switch</p> <p>If an INV compressor has malfunctioned, turn CT1 ON and Back Up SW ON to operate the outdoor unit using only the constant-speed compressor.</p> <p>If a constant-speed compressor has malfunctioned, turn CT2 ON and Back Up SW ON to operate the outdoor unit using only the INV compressor. (Disconnect the wiring from the constant-speed compressor.)</p>

1. Outdoor Unit Control PCB

Terminal plug (CN072)	<p>3P plug (black): For communications circuit impedance matching</p> <ul style="list-style-type: none"> • A connecting socket (3P, black) is attached to the terminal plug at the time of shipment from the factory. • In the case of link wiring which combines the inter-unit control wiring for multiple systems into a single communications circuit, leave the connecting socket in place at only one of the outdoor units, and move the socket from the "SHORT" side to the "OPEN" side at all other outdoor units. If multiple connecting sockets are left in place, communications trouble will occur.
LED1, 2 (D023, D024)	<p>LED (red × 2)</p> <ul style="list-style-type: none"> • LED 1 and 2 blink alternately while automatic address setting is in progress. • Display the alarm contents for alarms which were detected by the outdoor unit.
Power LED (D515)	<p>LED (red): Power indicator</p> <p>Indicates the DC 5V power on the outdoor unit control PCB.</p>
Run (CN052)	<p>2P plug (white): Start pin</p> <p>Short-circuit this pin and apply a pulse signal to start all indoor units in that refrigerant system.</p>
Stop (CN053)	<p>2P plug (white): Stop pin</p> <p>Short-circuit this pin and apply a pulse signal to stop all indoor units in that refrigerant system.</p>
AP (CN050)	<p>2P plug (white): Vacuuming pin</p> <ul style="list-style-type: none"> • To perform vacuuming of the outdoor unit, short-circuit this pin and then turn the power ON. All solenoid valves turn ON and vacuuming begins smoothly. (Do not perform automatic address setting at this time.) • Release the short-circuit to return the unit to normal status.
Mode (CN085)	<p>3P plug (white): Indoor unit Heating/Cooling mode change pin</p> <ul style="list-style-type: none"> • When operating the compressors to perform automatic address setting, operation in Heating mode can be normally used. However, short-circuiting this pin performs operation in Cooling mode. (Static signal) • Short-circuiting this pin on COOL side during ordinary operation changes the mode to Cooling. • Short-circuiting this pin on HOT side during ordinary operation changes the mode to Heating.
Test (CN048)	<p>2P plug (white)</p> <ul style="list-style-type: none"> • This pin is used to test the PCB at the factory. • When the power is turned ON after this pin has been short-circuited, all output signals will be output in sequence. (Sequential output does not occur if this pin is short-circuited when the power is already ON.) Releasing this pin returns the unit to normal control.
CHK (Test Run) (CN049)	<p>2P plug (white) / Test run pin</p> <ul style="list-style-type: none"> • Test run mode is operated while short-circuit.

4

Snowfall sensor (CN057) ----- 3P plug (red)

With the Relay ON, the outdoor fan circulates regardless of the compressor's running and stop.

• Sample Wiring

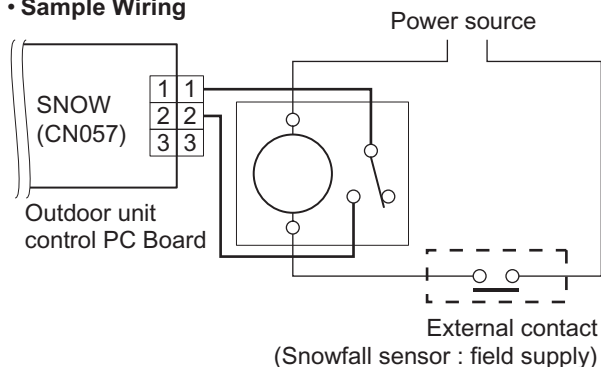

NOTE

1. Ensure that the wiring length between the outdoor unit control PCB and Relay is less than 2m.
Lead wire with 3P socket :
(service parts available: part code / CV9231851818)
2. Select the Relay that is the minimum load 0.1mA for the contact specifications.
3. Install the air-discharge chamber in the area of outdoor air temperature lower than approx. 0°C and also when operating in the cooling mode all through the year.
* When operating in the snow sensor mode, the unit will not operate by the effect of the freeze-prevention.

1. Outdoor Unit Control PCB

Table 1.
Setting the System Address
[S002: Rotary switch (black), S003: 2P DIP (blue)]

	Outdoor system address	S002 setting	S003 setting	
			1P (10s digit)	2P (20s digit)
1 refrigerant system only	1	0	OFF	OFF
Link wiring	1	1	OFF	OFF
	2	2	OFF	OFF
	3	3	OFF	OFF
	4	4	OFF	OFF
	5	5	OFF	OFF
	6	6	OFF	OFF
	7	7	OFF	OFF
	8	8	OFF	OFF
	9	9	OFF	OFF
	10	0	ON	OFF
	11	1	ON	OFF
	12	2	ON	OFF
	13	3	ON	OFF
	14	4	ON	OFF
	15	5	ON	OFF
	16	6	ON	OFF
	17	7	ON	OFF
	18	8	ON	OFF
	19	9	ON	OFF

	Outdoor system address	S002 setting	S003 setting	
			1P (10s digit)	2P (20s digit)
Link wiring	20	0	OFF	ON
	21	1	OFF	ON
	22	2	OFF	ON
	23	3	OFF	ON
	24	4	OFF	ON
	25	5	OFF	ON
	26	6	OFF	ON
	27	7	OFF	ON
	28	8	OFF	ON
	29	9	OFF	ON
	30	0	ON	ON

Table 2.
Setting the Number of Indoor Units
[S004: Rotary switch (red), S005: 3P DIP (blue)]

Number of Indoor Units	S004 Setting	S005 Setting		
		1	2	3
1	1	OFF	OFF	OFF
2	2	OFF	OFF	OFF
3	3	OFF	OFF	OFF
<hr/>				
9	9	OFF	OFF	OFF
10	0	ON	OFF	OFF
11	1	ON	OFF	OFF
<hr/>				
19	9	ON	OFF	OFF
20	0	OFF	ON	OFF
21	1	OFF	ON	OFF
<hr/>				
29	9	OFF	ON	OFF
30	0	OFF	OFF	ON
31	1	OFF	OFF	ON
<hr/>				
39	9	OFF	OFF	ON
40	0	ON	OFF	ON
41	1	ON	OFF	ON
<hr/>				
49	9	ON	OFF	ON
50	0	OFF	ON	ON
51	1	OFF	ON	ON
<hr/>				
59	9	OFF	ON	ON
60	0	ON	ON	ON
61	1	ON	ON	ON
62	2	ON	ON	ON
63	3	ON	ON	ON
64	4	ON	ON	ON

Table 3.
Setting the Number of Outdoor Units
[S006: DIP switch (blue)]

Number of Indoor Units	S006 Setting		
	1	2	3
1	ON	OFF	OFF
2	OFF	ON	OFF
3	ON	ON	OFF
4	OFF	OFF	ON

Table 4.
Setting the Outdoor Unit address

Outdoor Unit Address	S007 Setting		
	1	2	3
1	ON	OFF	OFF
2	OFF	ON	OFF
3	ON	ON	OFF
4	OFF	OFF	ON

– MEMO –

5. Self-Diagnostics Function Table

1. Self-Diagnostics Function Table.....5-2

1. Self-Diagnostics Function Table

Self-Diagnostics Function Table

- Causes and corrections in instances when automatic address setting cannot be started

Trouble	Cause and correction
The power LED (D515) on the outdoor unit control PCB does not turn ON.	Check for any errors in the power wiring to the outdoor unit, and check for a missing phase.
LED 1 and 2 on the outdoor unit control PCB do not turn OFF when the outdoor unit power is turned ON, and automatic address setting cannot be started.	Check the "Alarm Display" table and correct the problem. (See page 3-2 to 3-4.)
An alarm appears immediately when automatic address setting is started from the wired remote controller.	
Nothing happens when the operator attempts to start automatic address setting from the wired remote controller.	Check that the wired remote controller wiring and the inter-unit control wiring are connected correctly. Check that the indoor unit power is ON.

- Causes and corrections in instances when automatic address setting starts, but cannot be completed successfully

Trouble	Cause and correction
An alarm appears on the wired remote controller sometime from several seconds to several minutes after automatic address setting is started.	Check the "Alarm Display" table and correct the problem. (See page 3-2 to 3-4.) Check the alarm details on the "Outdoor Unit Control PCB LED 1 and 2 Alarms" , then correct the problem.
LED 1 and 2 on the outdoor unit control PCB indicate that automatic address setting is in progress (the LEDs blink alternately) for several minutes after automatic address setting is started (the compressors may also start and stop several times), however LED 1 and 2 never indicate that automatic address setting is completed (turn OFF).	

- If alarm E15, E16, or E20 appears after automatic address setting is started, check the following items.

Alarm display	Alarm description
E15	The number of indoor units detected during automatic address setting was smaller than the number of indoor units which was set with switch S004 and S005 on the outdoor unit PCB.
E16	The number of indoor units detected during automatic address setting was larger than the number of indoor units which was set with switch S004 and S005 on the outdoor unit PCB.
E20	The outdoor unit received no serial signals from indoor units within 90 seconds after automatic address setting was started.

1. Self-Diagnostics Function Table

Check items	E15	E16	E20
Check that the indoor unit power is turned ON.	○		○
Check that the inter-unit control wiring is connected correctly. (Check that there are no open circuits, short circuits, terminal plugs, incorrect wiring to the remote controller terminals, or similar problems.)	○	○	○
Check that the remote controller wiring is connected correctly. (Check that there are no open circuits, short circuits, incorrect wiring to the inter-unit control wiring terminals, group control crossover wiring, or similar problems.)	○		○
Check that the number of indoor units has been set correctly using switch S004 and S005 on the outdoor unit control PCB.	○	○	
Check that the amount of additional refrigerant charge is correct when performing Auto Address Setting Case 3A or Case 3B in the flow chart described on page 1-2.	○		
Check that the refrigerant tubing connections are correct when performing Auto Address Setting Case 3A or Case 3B in the flow chart described on page 1-2.	○	○	
Check that there are no problems with indoor unit sensors E1 and E3 when performing Auto Address Setting Case 3A or Case 3B in the flow chart described on page 1-2.	○		
Check that there are no indoor units where the system address was already incorrectly set by manual or automatic address setting.		○	

- When automatic address setting is started from the outdoor unit control PCB or from the remote controller, **SETTING** (SETTING) appears on the remote controller at units where the inter-unit control wiring and remote controller wiring are connected correctly. LED 1 and 2 on the outdoor unit control PCB blink alternately.
- In the case of indoor unit group control, if there is a mistake in the group-control wiring, addresses may not be set even if **SETTING** (SETTING) appears.
- Even if alarm E15 or E16 appears, addresses are set at those indoor units which could be verified. The set addresses can be checked using the wired remote controller.
- If one of the below alarms appears when the remote controller is operated after automatic address setting was completed (LED 1 and 2 on the outdoor unit control PCB are turned OFF), follow the instructions in the table below and correct the problem location.

Remote controller display	Cause
Nothing is displayed.	The remote controller is not connected correctly (power trouble). The indoor unit power was cut off after automatic address setting was completed.
E01	The remote controller is not connected correctly (remote controller receiving trouble). The remote controller of an indoor unit where the indoor unit address is not set is inadvertently operated. (Communications with the outdoor unit are not possible.)
E02	The remote controller is not connected correctly (trouble with sending of the signal from the remote controller to the indoor unit).
P09	The indoor unit ceiling panel connector is not connected correctly.

1. Self-Diagnostics Function Table

- The outdoor unit maintenance remote controller can be used to check the alarm display.
The number of times that LED 1 and 2 blink on the outdoor unit control PCB can be used to check the alarm display.
(Refer to “Checking the LED 1 and 2 Alarm Display on the Outdoor Unit Control PCB.”)

Alarm code	Alarm meaning
E06	Outdoor unit failed to receive serial communication signals from indoor unit.
E12	Automatic address setting start is prohibited.
E15	Automatic address setting alarm (too few units)
E16	Automatic address setting alarm (too many units)
E20	No indoor units at automatic address setting.
E24	Outdoor unit failed to receive communications from another outdoor unit.
E25	Outdoor unit address setting failure (duplication)
E26	Mismatch in outdoor unit quantity
E29	Outdoor unit failed to receive communication from another outdoor unit.
E30	Outdoor unit serial communications failure
E31	Communication error between the microcomputers
F04	Compressor 1 discharge temperature sensor trouble (DISCH1)
F05	Compressor 2 discharge temperature sensor trouble (DISCH2)
F06	Gas temperature sensor trouble at outdoor heat exchanger 1 (EXG1)
F07	Liquid temperature sensor trouble at outdoor heat exchanger 1 (EXL1)
F08	Outdoor air temperature sensor trouble (AIR TEMP)
F12	Compressor intake temperature sensor trouble (SCT)
F16	High-pressure sensor trouble (HPS)
F17	Low-pressure sensor trouble (LPS)
F22	Compressor 3 discharge temperature sensor trouble (DISCH3)
F23	Gas temperature sensor trouble at outdoor heat exchanger 2 (EXG2)
F24	Liquid temperature sensor trouble at outdoor heat exchanger 2 (EXL2)
F31	Outdoor unit non-volatile memory (EEPROM) trouble
H03	Compressor 1 CT sensor disconnected or short-circuit
H05	Compressor 1 discharge temperature sensor disconnected
H06	Low-pressure trouble
H08	Compressor 1 oil detection sensor (connection) trouble
H11	Constant speed compressor 2 overcurrent alarm
H12	Constant speed compressor 2 lock current alarm
H13	Compressor 2 CT sensor disconnected or short-circuit
H15	Compressor 2 discharge temperature sensor disconnected
H21	Compressor 3 overcurrent alarm
H22	Compressor 3 lock current alarm
H23	Compressor 3 CT sensor disconnected or short-circuit
H25	Compressor 3 discharge temperature sensor disconnected
H27	Compressor 2 lock current alarm
H28	Compressor 3 lock current alarm
H31	HIC trouble alarm
L04	Outdoor unit address duplication
L10	Outdoor unit capacity not set
L17	Outdoor unit model mismatch
L18	4-way valve operation failure.
P02	Compressor thermal protector is activated.(trip only and no alarm)
P03	Compressor 1 discharge temperature trouble
P04	High-pressure switch activated
P05	Reverse phase (or missing phase) detected, capacity mismatch
P14	O ₂ sensor is activated.
P16	Compressor 1 overcurrent
P17	Compressor 2 discharge temp trouble
P18	Compressor 3 discharge temp trouble
P20	High load alarm
P22	Fan motor trouble
P29	Inverter compressor missing phase or lock alarm

Contents

6. Service Checker

1. Outdoor Unit Maintenance Remote Controller6-2

1. Outdoor Unit Maintenance Remote Controller

1-1. Overview

■ About the outdoor unit maintenance remote controller

The outdoor unit utilizes non-volatile memory (EEPROM) on its PCB. This allows EEPROM data to replace the setting switches that were present on previous PCBs. The outdoor unit maintenance remote controller is used to set and change these EEPROM data.

In addition to setting and checking the outdoor unit EEPROM data, this remote controller can also be used to monitor the outdoor unit alarm history, monitor the various indoor and outdoor temperatures, and check the indoor unit connection status (number of units, operating mode, etc.).

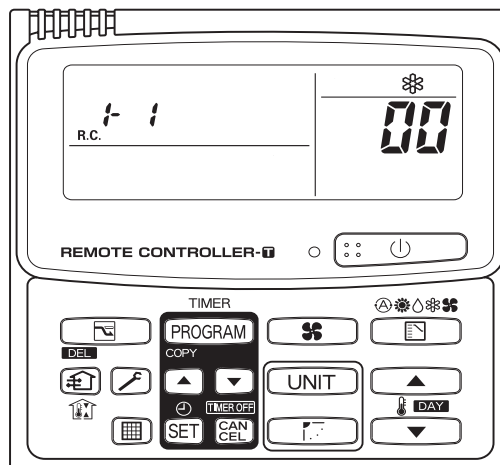

NOTE

Outdoor unit maintenance remote controller does not function as an ordinary remote controller. It is therefore only used for test runs and during servicing.

System Diagram

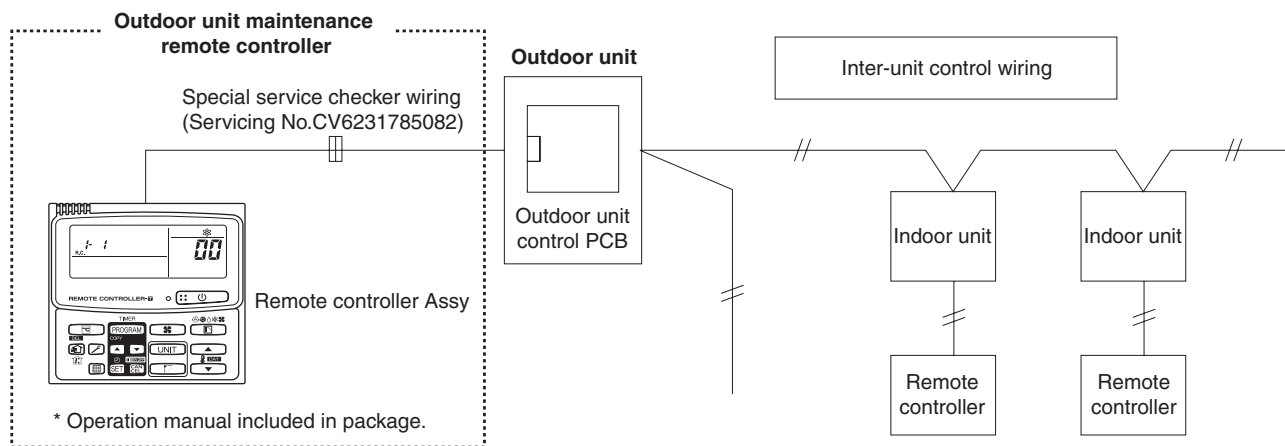

- The special service checker wiring is required in order to connect the outdoor unit maintenance remote controller to the outdoor unit PCB.
- Ordinary remote controllers or other controllers are still required for the indoor units, even when the outdoor unit maintenance remote controller is connected.

1-2. Functions

■ Functions on the ordinary display

- (1) Press the buttons to execute the following functions.
 - All indoor units stop/start
 - Cooling/heating change
 - All indoor units test run
- (2) Display: The following displays are possible.
 - Alarm display
 - No. of indoor/outdoor units
 - Unit Nos. of connected indoor/outdoor units
 - Operating status of indoor/outdoor units (Blinks when alarm occurs.)
 - Indoor thermostat ON
 - Display of individual outdoor unit alarms
 - Total operating time of outdoor unit compressors
 - Oil level of the outdoor unit oil sensor
 - Total outdoor unit power ON time
 - Outdoor unit microcomputer version, other information.

1. Outdoor Unit Maintenance Remote Controller

■ Temperature monitor

Displays the temperature from each indoor/outdoor sensor.

■ Outdoor unit alarm history monitor

Displays the outdoor unit alarm history.

■ Setting the outdoor unit EEPROM data

Settings mode 1 and settings mode 2 can be used to make outdoor unit EEPROM data settings.

1-3. Ordinary Display Controls and Functions

■ Functions on the ordinary display

Connect the special service checker wiring to the outdoor unit PCB.

The connection diagram is shown below.

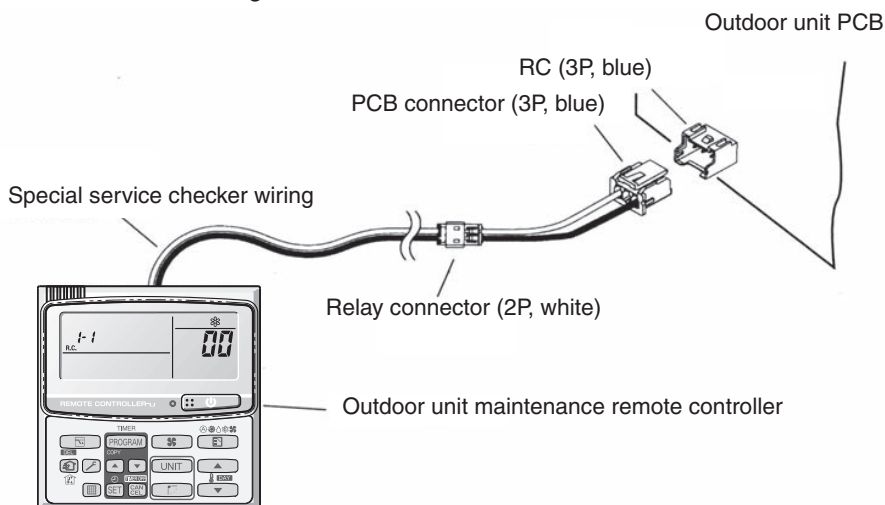

- If the inter-unit control wiring is connected, it can be left as-is.
- In case of an independent outdoor unit (1 maintenance remote controller connected to 1 outdoor unit, automatic address setting for indoor units not completed), both setting mode 1 and setting mode 2 can be used for outdoor unit EEPROM data settings.
- The overall system status for that refrigerant system is displayed.

All units start/stop (Fig. 6-1)

<Operation>

The (ON/OFF operation) button can be used to start and stop all indoor units.

- The LED illuminates if any indoor unit is operating.
- The LED blinks if an alarm occurs at any of the operating indoor units.

Cooling/heating change (Fig. 6-1)

<Operation>

The (MODE) button can be used to change between heating and cooling operation.

- The display indicates the operating mode of the indoor unit with the lowest unit No.

All units test run (Fig. 6-2)

<Operation>

The (CHECK) button can be used to start and stop a test run for all units.

- To start, press and hold the button for 4 seconds. During the test run, "Test" is displayed.
- The status of test runs performed from the indoor unit remote controller is not displayed on the outdoor unit maintenance remote controller.

Double-speed

- Do not use for actual operation. (Doing so may damage the devices.)

<Operation>

The timer button can be used to change between double-speed and normal operation.

- During double-speed operation, the SLEEPING MODE mark is displayed.

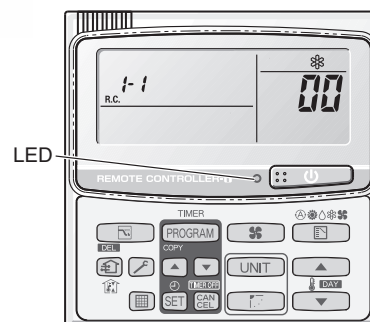

Fig. 6-1

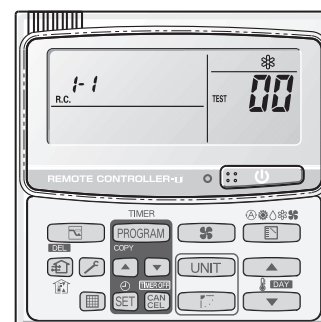
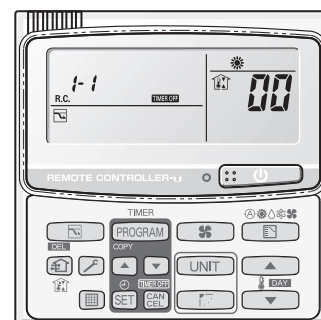

Fig. 6-2



1. Outdoor Unit Maintenance Remote Controller

■ Display (functions)

- The item codes can be changed with the 「▲」 and 「▼」 buttons.

① Item code	② Item	Remarks
00	Outdoor unit alarm	Alarm code display
01	No. of connected indoor units	Quantity
02	Unit Nos. of connected indoor unit	7-segment display
03	Operating status of indoor unit	7-segment display
04	Thermostat ON status of indoor unit	7-segment display
05	No. of connected outdoor units	1 – 8
06	Unit Nos. of connected outdoor units	7-segment display
07	Operating status of outdoor unit compressor	7-segment display
08		
09		
10	Compressor 1 operating time	0 – 99999999 hrs
11	Compressor 2 operating time	0 – 99999999 hrs
12	Compressor 3 operating time	
13	Compressor 1 oil level	0 = Empty 1 = Insufficient 2 = Sufficient
14	Compressor 2 oil level	0 = Empty 1 = Insufficient 2 = Sufficient
15	Compressor 3 oil level	0 = Empty 1 = Insufficient 2 = Sufficient
16	Outdoor unit power ON time	0 – 99999999 hrs
17	Compressor 1 operation count	0 – 65535 times
18	Compressor 2 operation count	0 – 65535 times
19	Compressor 3 operation count	0 – 65535 times
F0	Alarm history 1 (most recent)	Display only. Alarm code and unit No. of unit where alarm occurred are displayed alternately. 0 = CCU 1 – 4 = Outdoor unit
F1	Alarm history 2	
F2	Alarm history 3	
F3	Alarm history 4	
F4	Alarm history 5	
F5	Alarm history 6	
F6	Alarm history 7	
F7	Alarm history 8 (oldest)	
FE	Firmware version	Displays the version No. × 100.
FF	Program version	Displays the version No. × 100.

① and ② correspond to Fig. 6-3 on the next page.

1. Outdoor Unit Maintenance Remote Controller

③ XX-YY R.C.

Displays the outdoor unit sub-bus address which is currently selected.

XX = Outdoor unit system address (1 – 30)

YY = Outdoor unit address (1 – 4)

The locations where ①, ② and ③ are displayed as shown on Fig. 6-3.

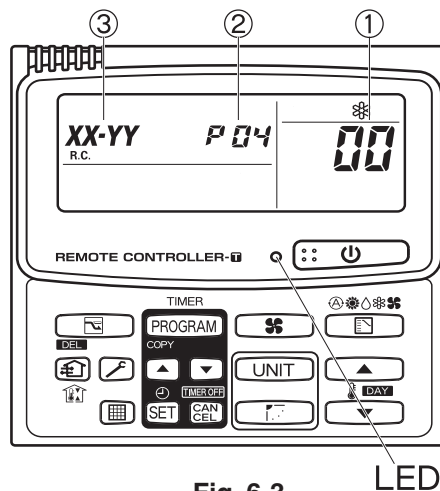
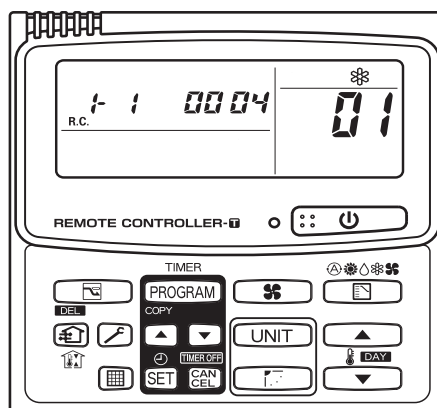

Fig. 6-3

Sample display (Fig. 6-4, Fig. 6-5)



01 : <No. of connected indoor units>
4 units connected

Fig. 6-4

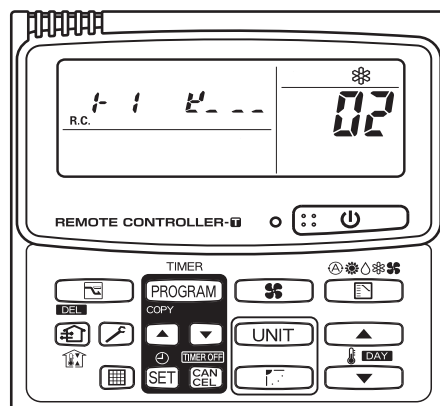

02 : <Unit Nos. 1, 2, 3, 4 connected>

Fig. 6-5

1. Outdoor Unit Maintenance Remote Controller

Concerning the 7-segment 4-digit display of remote controller timer time

- The unit Nos. of connected units are indicated by four 7-segment digits (**00 : 00**) and a colon.

① Display of unit Nos. 1 – 20

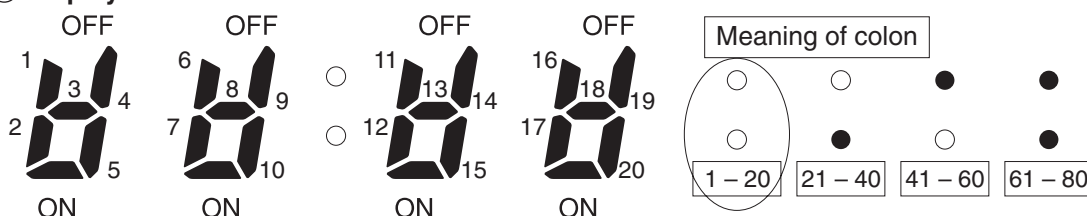

② Display of unit Nos. 21 – 40

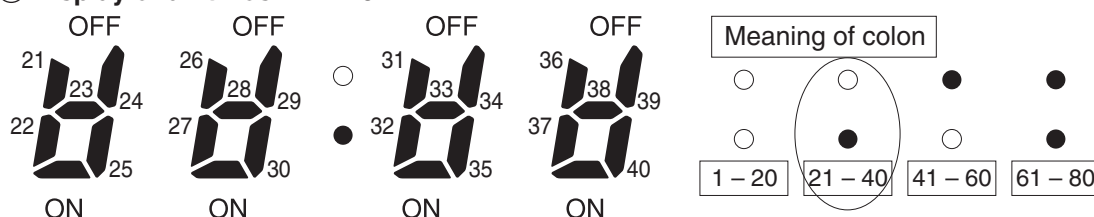

- The meaning of the colon changes in the same way to indicate unit Nos. up to 80.

④ Sample displays of connected indoor unit Nos.

- Display of unit No. 1
- Display of unit Nos. 1 and 2
- Display of unit Nos. 1, 2, and 3
- Display of unit Nos. 1, 2, 3, and 4



NOTE

The change of the colon display (between unit Nos. 1 – 20 to unit Nos. 21 – 40) occurs automatically every 10 seconds. (However the display does not change if there are no higher-number units connected.) To change the display to the higher-number units before 10 seconds have passed, press the (FLAP) button.

An 8-digit display is used for display of the compressor total operating time (in 1-hour units).

- When the first 4 digits are displayed, the top dot of the colon is illuminated. (Figure (A))
- When the last 4 digits are displayed, the colon dot is OFF. (Figure (B))
- The display of the first 4 digits and last 4 digits changes automatically after 10 seconds.

The display can also be changed by pressing the (FLAP) button.

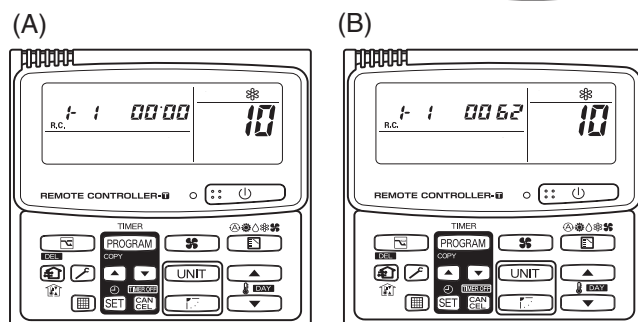

: <Compressor's total operating time>
(A) and (B) are displayed alternately
(The example here (0000, 0062)
indicates 62 hours.)

Sample Display (A), (B)

NOTE







With the outdoor unit maintenance remote controller (when connected to the outdoor unit), the unit remote controller check functions will not operate.

1. Outdoor Unit Maintenance Remote Controller

1-4. Monitoring Operations

Display the indoor unit and outdoor unit sensor temperatures.

<Operating procedure>

- ① Press and hold the  (CHECK) and  (CANCEL) buttons simultaneously for 4 seconds or longer to engage temperature monitor mode. During temperature monitoring,  (CHECK) illuminates. (The display and operations are the same as for monitor mode using the indoor unit remote controller.)
- ② Press the  (UNIT) button and select the indoor unit to monitor.
- ③ Press the temperature setting  and  buttons and select the item code of the temperature to monitor. The unit No. of the selected indoor unit, and the temperature data, are displayed.
- ④ To end monitoring, press the  (CHECK) button. The display returns to the normal display.

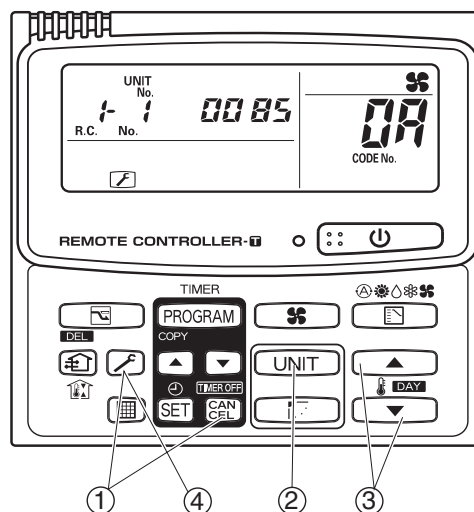

NOTE The display does not blink.

■ Display of unit No. 1 (main unit)

DN	Description		Remarks
02	Intake temp.	°C	Indoor unit
03	E1	°C	
04	E2	°C	
05	E3	°C	
06	Discharge temp.	°C	
07	Discharge temp. setting	°C	
08	Indoor unit electronic control valve position	STEP	
0A	Discharge temp. 1 at Compressor 1	°C	
0b	Discharge temp. 2 at Compressor 2	°C	
0c	High-pressure sensor temp.	°C	
0d	Heat exchanger gas 1	°C	Outdoor unit
0E	Heat exchanger liquid 1	°C	
0F	Heat exchanger gas 2	°C	
10	Heat exchanger liquid 2	°C	
11	Outdoor air temp.	°C	
12	Not used		
13	Inverter primary current	A	
14	Current at Compressor 2 (CT2)	A	
15	MOV1 pulse	STEP	
16	MOV2 pulse	STEP	
17	Discharge temp. 3 at Compressor 3	°C	
18	CT3	A	
19	MOV3 pulse	STEP	
1A	MOV4 pulse	STEP	
1b	Heat exchanger gas 3	°C	
1c	Heat exchanger liquid 3	°C	
1d	Low-pressure sensor temp.	°C	
1E	Suction temp.	°C	
1F	Oil 1	°C	
20	Oil 2	°C	
21	Oil 3	°C	
22	Actual operating frequency	Hz	

NOTE 0A and subsequent items are outdoor unit data. 0A – 22 are for unit No. 1.
2A – 42 are for unit No. 2. 4A – 62 are for unit No. 3. 62 – 89 are for unit No. 4.









1. Outdoor Unit Maintenance Remote Controller

1-5. Outdoor Unit Alarm History Monitor

Recalls and displays the outdoor unit alarm history.

- This is for the outdoor unit only. Indoor unit alarms cannot be recalled.
- The indoor unit alarm history can be viewed on the indoor unit remote controller or other controller.

<Operation procedure>

- ① Press and hold the  (CHECK) button and  (SET) button simultaneously for 4 seconds or longer to engage outdoor unit alarm history mode. During temperature monitoring,  illuminates. The display and operations are the same as for the alarm history monitor performed from the indoor unit remote controller. However the “unit No.” display shows the outdoor unit address.
- ② Press the  (UNIT) button, and select the outdoor unit for which to monitor the alarm history.
- ③ Press the temperature setting  and  buttons and select the item code for the alarm history. The selected outdoor unit address, the item code, and the alarm history (alarm data) are displayed.
The outdoor unit address is displayed as R.C. XX – YY.
(R.C. XX = Outdoor unit system address
YY = Outdoor unit address
Item codes 01 – 08 are displayed. 01 indicates the most recent alarm.
The alarm history displays the alarm code.
(If no alarms are present, then _ _ _ is displayed.)
- ④ To clear the alarm history, press the  (CANCEL) button.
(The outdoor unit alarm history will be cleared.)
- ⑤ To exit, press the  (CHECK) button.
The display returns to the normal display.

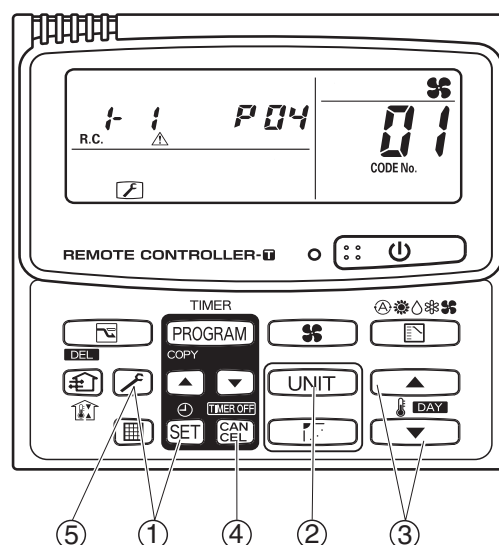







1. Outdoor Unit Maintenance Remote Controller

1-6. Setting the outdoor unit EEPROM data

This function is used to make the outdoor unit EEPROM data settings.

■ Setting mode 1

- ① Press and hold the  (CHECK) button and the  (VENTILATION) button simultaneously for 4 seconds or longer.
- ② Press the temperature setting  and  buttons to change the item code. The item codes and setting data are shown in the table of "List of Item Codes" on the next page.

- ③ Press the timer time  and  buttons to change the setting data.

To confirm the changed setting data, press the  (SET) button.

(At this time, the "SET DATA" display stops blinking and remains lit.)

- ④ During this mode, "SET DATA" is displayed, blinking. The outdoor unit address display section displays "ALL," the item code and number (DN value in the table), and the setting data (8 digits). (The setting data is displayed in 8 digits. The display changes between the first 4 digits (Fig. (A)) and the last 4 digits (Fig. (B)).

(The setting data is displayed in 8 digits. The display changes between the first 4 digits (Fig. (A)) and the last 4 digits (Fig. (B)).

When the first 4 digits are displayed, the top dot of the colon is illuminated.)

- ⑤ To exit setting mode, press the  (CHECK) button.

(A) Display of first 4 digits

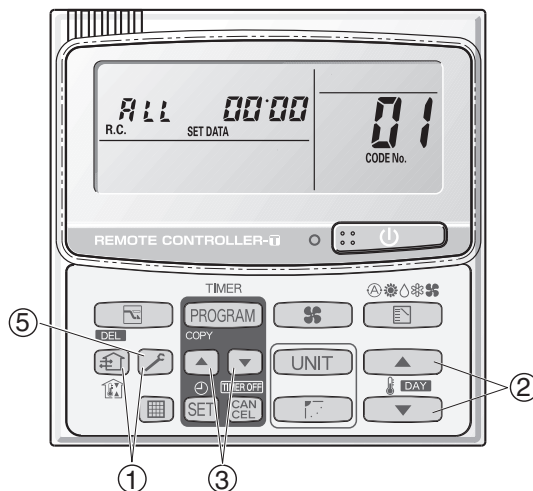

(B) Display of last 4 digits

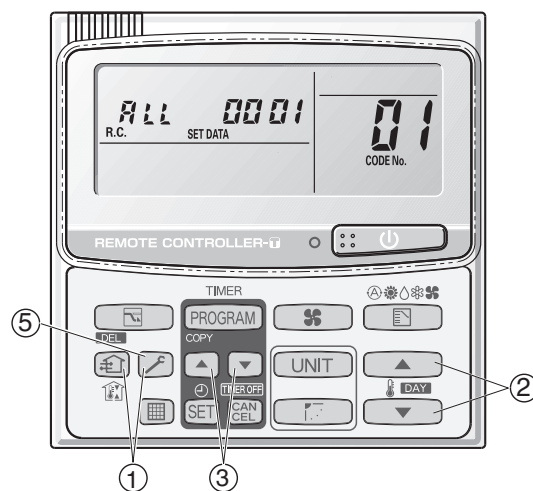









(A) and (B) are displayed alternately.
(Example shows display of 0000 0001.)

Code No.	Parameter	Description (SET DATA)
04	Snowfall sensor usage	0000 = Sensor input not present. Control is performed. 0001 = Sensor input present. Control is performed. 0002 = Sensor input not present. Control is not performed. 0003 = Sensor input present. Control is not performed.
05	Outdoor unit fan Quiet mode	0000 = Disabled 0001 = Quiet mode 1 0002 = Quiet mode 2 0003 = Quiet mode 3 0004 = Quiet mode 4
1a	Demand 1 current	0000 = 0% 0001 = 40 ... 0004 = 70 0007 = 100 0008 = 120 0009 = 140 0010 = 160 0011 = 200 0012 = -1 (no limit)
1b	Demand 2 current	0000 = 0% 0001 = 40 ... 0004 = 70 0007 = 100 0008 = 120 0009 = 140 0010 = 160 0011 = 200 0012 = -1 (no limit)

1. Outdoor Unit Maintenance Remote Controller

■ Setting mode 2

- ① Press and hold the  (CHECK) button,  (SET) button and the  (CANCEL) button simultaneously for 4 seconds or longer.
- ② Press the temperature setting  and  buttons to change the item code. The item codes and setting data are shown in the table below.
- ③ Press the timer time  and  buttons to change the setting data.
To confirm the changed setting data, press the  (SET) button.
(At this time, the “SET DATA” display stops blinking and remains lit.)
- ④ During this mode, “SET DATA” is displayed, blinking. The display shows the set outdoor unit address “System XX-YY” (System XX = System address, YY = Address at outdoor unit sub-bus), item code number (DN value in the table below), and the setting data (8 digits).
(The setting data is displayed in 8 digits. The display changes between the first 4 digits (Fig. (C)) and the last 4 digits (Fig. (D)). When the first 4 digits are displayed, the top point of the colon is illuminated.)
- ⑤ To exit setting mode, press the  (CHECK) button. Returns to normal display mode.

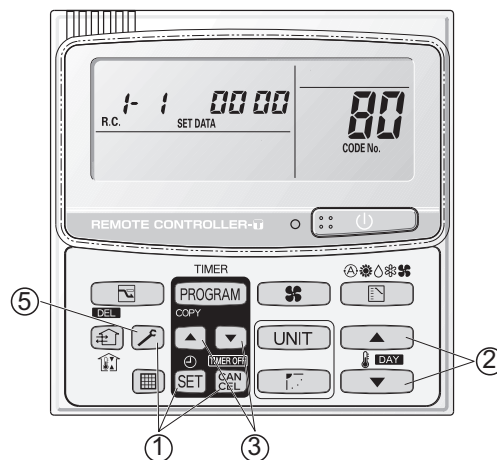

(C) Display of first 4 digits

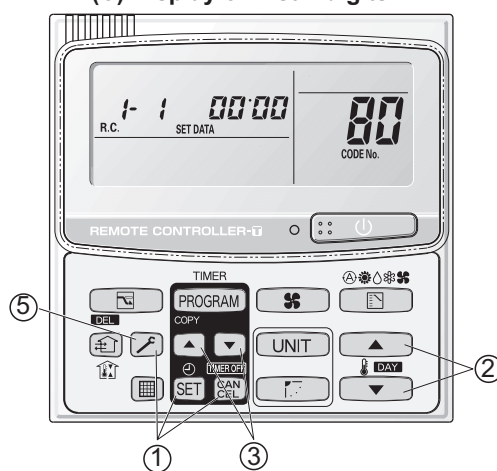

(D) Display of last 4 digits



Refrigerant type: (C) and (D) are displayed alternately.
Example shows 0000, 0410 (R410A).

List of Item Codes

CODE NO.	Parameter	Description (SET DATA)			
	Outdoor unit capacity	0	Disabled	400	14HP type
		224	8HP type	450	16HP type
		280	10HP type	500	18HP type
		355	12HP type	560	20HP type

