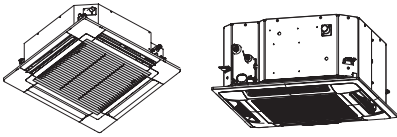
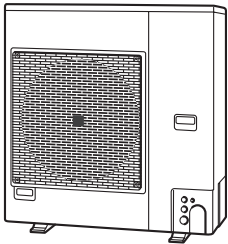
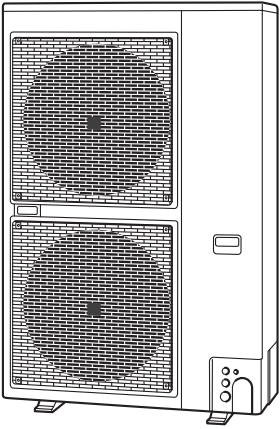

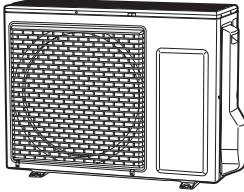

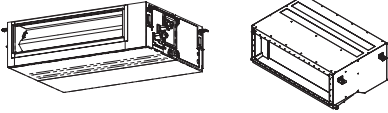


## TECHNICAL DATA & SERVICE MANUAL

# R410A

# INVERTER

| Indoor Unit   |  | Outdoor Unit   |  |
|---|--|--|--|
|    | 4-Way Cassette<br>4-Way Cassette 60 x 60 |   |  |
|    | Ceiling                                  |  |  |
|  | Wall Mounted                             |  |  |
|  | Low Silhouette Ducted<br>Ducted          |  |  |

### ■ R410A Models

Model No.

#### Indoor Units

| Type | Indoor Units Type      | 36         | 45         | 50         | 60         | 71         | 100         | 125         | 140         |
|------|------------------------|------------|------------|------------|------------|------------|-------------|-------------|-------------|
| U2   | 4-Way Cassette         | S-36PU2E5A | S-45PU2E5A | S-50PU2E5A | S-60PU2E5A | S-71PU2E5A | S-100PU2E5A | S-125PU2E5A | S-140PU2E5A |
| T2   | Ceiling                | S-36PT2E5A | S-45PT2E5A | S-50PT2E5A | S-60PT2E5A | S-71PT2E5A | S-100PT2E5A | S-125PT2E5A | S-140PT2E5A |
| K1   | Wall Mounted           | S-36PK1E5A | S-45PK1E5A | S-50PK1E5A | S-60PK1E5A | S-71PK1E5A | S-100PK1E5A | –           | –           |
| F1   | Low Silhouette Ducted  | S-36PF1E5A | S-45PF1E5A | S-50PF1E5A | S-60PF1E5A | S-71PF1E5A | S-100PF1E5A | S-125PF1E5A | S-140PF1E5A |
| N1   | Ducted                 | S-36PN1E5A | S-45PN1E5A | S-50PN1E5A | S-60PN1E5A | S-71PN1E5A | S-100PN1E5A | S-125PN1E5A | S-140PN1E5A |
| Y2   | 4-Way Cassette 60 x 60 | S-36PY2E5A | S-45PY2E5A | S-50PY2E5A | –          | –          | –           | –           | –           |

#### Outdoor Units

| Type | Outdoor Units Type     | 36         | 50         | 60         | 71         | 100         | 125         | 140         |
|------|------------------------|------------|------------|------------|------------|-------------|-------------|-------------|
| PE1  | Single Split (1-phase) | –          | –          | –          | U-71PE1E5A | U-100PE1E5A | U-125PE1E5A | U-140PE1E5A |
|      | Single Split (3-phase) | –          | –          | –          | U-71PE1E8A | U-100PE1E8A | U-125PE1E8A | U-140PE1E8A |
| PE2  | Single Split (1-phase) | U-36PE2E5A | U-50PE2E5A | U-60PE2E5A | –          | –           | –           | –           |
| PEY1 | Single Split (1-phase) | –          | –          | –          | –          | U-100PEY1E5 | U-125PEY1E5 | –           |
|      | Single Split (3-phase) | –          | –          | –          | –          | U-100PEY1E8 | U-125PEY1E8 | U-140PEY1E8 |
| PEY2 | Single Split (1-phase) | –          | –          | U-60PEY2E5 | U-71PEY2E5 | –           | –           | –           |

## IMPORTANT! Please Read Before Starting

This air conditioner must be installed by the sales dealer or installer.

This information is provided for use only by authorized persons.

**For safe installation and trouble-free operation, you must:**

- Carefully read this instruction booklet before beginning.
- Follow each installation or repair step exactly as shown.
- This air conditioner shall be installed in accordance with National Wiring Regulations.
- Pay close attention to all warning and caution notices given in this manual.



**WARNING**

This symbol refers to a hazard or unsafe practice which can result in severe personal injury or death.



**CAUTION**

This symbol refers to a hazard or unsafe practice which can result in personal injury or product or property damage.

### If Necessary, Get Help

These instructions are all you need for most installation sites and maintenance conditions. If you require help for a special problem, contact our sales/service outlet or your certified dealer for additional instructions.

### In Case of Improper Installation

The manufacturer shall in no way be responsible for improper installation or maintenance service, including failure to follow the instructions in this document.


## SPECIAL PRECAUTIONS



**WARNING When Wiring**



**ELECTRICAL SHOCK CAN CAUSE SEVERE PERSONAL INJURY OR DEATH. ONLY A QUALIFIED, EXPERIENCED ELECTRICIAN SHOULD ATTEMPT TO WIRE THIS SYSTEM.**

- Do not supply power to the unit until all wiring and tubing are completed or reconnected and checked.
- Highly dangerous electrical voltages are used in this system. Carefully refer to the wiring diagram and these instructions when wiring. Improper connections and inadequate grounding can cause **accidental injury or death.**
- Connect all wiring tightly. Loose wiring may cause overheating at connection points and a possible fire hazard.
- Provide a power outlet to be used exclusively for each unit.
- Provide a power outlet exclusively for each unit, and full disconnection means having a contact separation in all poles must be incorporated in the fixed wiring in accordance with the wiring rules.
- To prevent possible hazards from insulation failure, the unit must be grounded. 
- This equipment is strongly recommended to be installed with Earth Leakage Circuit Breaker (ELCB) or Residual Current Device (RCD). Otherwise, it may cause electrical shock and fire in case of equipment breakdown or insulation breakdown.

## When Transporting

- It may need two or more people to carry out the installation work.
- Be careful when picking up and moving the indoor and outdoor units. Get a partner to help, and bend your knees when lifting to reduce strain on your back. Sharp edges or thin aluminum fins on the air conditioner can cut your fingers.

## When Installing...

Select an installation location which is rigid and strong enough to support or hold the unit, and select a location for easy maintenance.

### ...In a Room

Properly insulate any tubing run inside a room to prevent “sweating” that can cause dripping and water damage to walls and floors.



### CAUTION

Keep the fire alarm and the air outlet at least 1.5 m away from the unit.

### ...In Moist or Uneven Locations

Use a raised concrete pad or concrete blocks to provide a solid, level foundation for the outdoor unit. This prevents water damage and abnormal vibration.

### ...In an Area with High Winds

Securely anchor the outdoor unit down with bolts and a metal frame. Provide a suitable air baffle.

### ...In a Snowy Area (for Heat Pump-type Systems)

Install the outdoor unit on a raised platform that is higher than drifting snow. Provide snow vents.

## When Connecting Refrigerant Tubing


Pay particular attention to refrigerant leakages.



### WARNING

- When performing piping work, do not mix air except for specified refrigerant (R410A) in refrigeration cycle. It causes capacity down, and risk of explosion and injury due to high tension inside the refrigerant cycle.
- If the refrigerant comes in contact with a flame, it produces a toxic gas.
- Do not add or replace refrigerant other than specified type. It may cause product damage, burst and injury, etc.
- Ventilate the room immediately, in the event that is refrigerant gas leaks during the installation. Be careful not to allow contact of the refrigerant gas with a flame as this will cause the generation of toxic gas.
- Keep all tubing runs as short as possible.
- Apply refrigerant lubricant to the matching surfaces of the flare and union tubes before connecting them, then tighten the nut with a torque wrench for a leak-free connection.
- Check carefully for leaks before starting the test run.
- Do not leak refrigerant while piping work for an installation or re-installation, and while repairing refrigeration parts. Handle liquid refrigerant carefully as it may cause frostbite.

## When Servicing

- Turn the power OFF at the main power box (mains), wait at least 10 minutes until it is discharged, then open the unit to check or repair electrical parts and wiring. 
- Keep your fingers and clothing away from any moving parts.
- Clean up the site after you finish, remembering to check that no metal scraps or bits of wiring have been left inside the unit.

### **WARNING**

- This product must not be modified or disassembled under any circumstances. Modified or disassembled unit may cause fire, electric shock or injury.
- Do not clean inside the indoor and outdoor units by users. Engage authorized dealer or specialist for cleaning.
- In case of malfunction of this appliance, do not repair by yourself. Contact to the sales dealer or service dealer for a repair.

### **CAUTION**




- Ventilate any enclosed areas when installing or testing the refrigeration system. Leaked refrigerant gas, on contact with fire or heat, can produce dangerously toxic gas.
- Confirm after installation that no refrigerant gas is leaking. If the gas comes in contact with a burning stove, gas water heater, electric room heater or other heat source, it can cause the generation of toxic gas.

## Others

### **WARNING**

- Do not sit or step on the unit, you may fall down accidentally. 

### **CAUTION**

- Do not touch the air inlet or the sharp aluminum fins of the outdoor unit. You may get injured. 
- Do not stick any object into the FAN CASE. You may be injured and the unit may be damaged.  

## Check of Density Limit

Check the amount of refrigerant in the system and floor space of the room according to the legislation on refrigerant drainage. If there is no applicable legislation, follow the standards described below.

The room in which the air conditioner is to be installed requires a design that in the event of refrigerant gas leaking out, its density will not exceed a set limit.

The refrigerant (R410A), which is used in the air conditioner, is safe, without the toxicity or combustibility of ammonia, and is not restricted by laws imposed to protect the ozone layer. However, since it contains more than air, it poses the risk of suffocation if its density should rise excessively. Suffocation from leakage of refrigerant is almost non-existent. With the recent increase in the number of high density buildings, however, the installation of multi air conditioner systems is on the increase because of the need for effective use of floor space, individual control, energy conservation by curtailing heat and carrying power, etc.

Most importantly, the multi air conditioner system is able to replenish a large amount of refrigerant compared to conventional individual air conditioners. If a single unit of the multi air conditioner system is to be installed in a small room, select a suitable model and installation procedure so that if the refrigerant accidentally leaks out, its density does not reach the limit (and in the event of an emergency, measures can be made before injury can occur).

In a room where the density may exceed the limit, create an opening with adjacent rooms, or install mechanical ventilation combined with a gas leak detection device. The density is as given below.

### Total amount of refrigerant (kg)

Min. volume of the indoor unit installed room (m<sup>3</sup>)

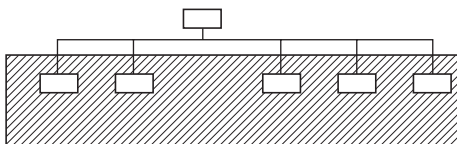
≤ Density limit (kg/m<sup>3</sup>)

The density limit of refrigerant which is used in multi air conditioners is 0.44 kg/m<sup>3</sup> (ISO 5149).

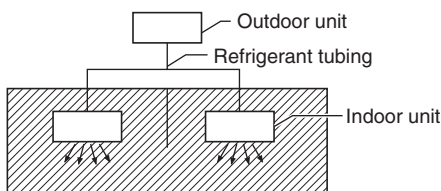
#### NOTE

1. The standards for minimum room volume are as follows.

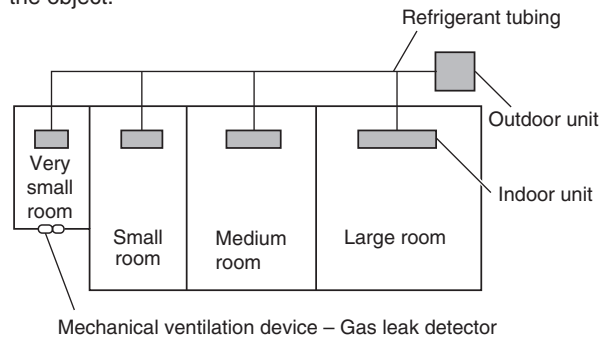
(1) No partition (shaded portion)



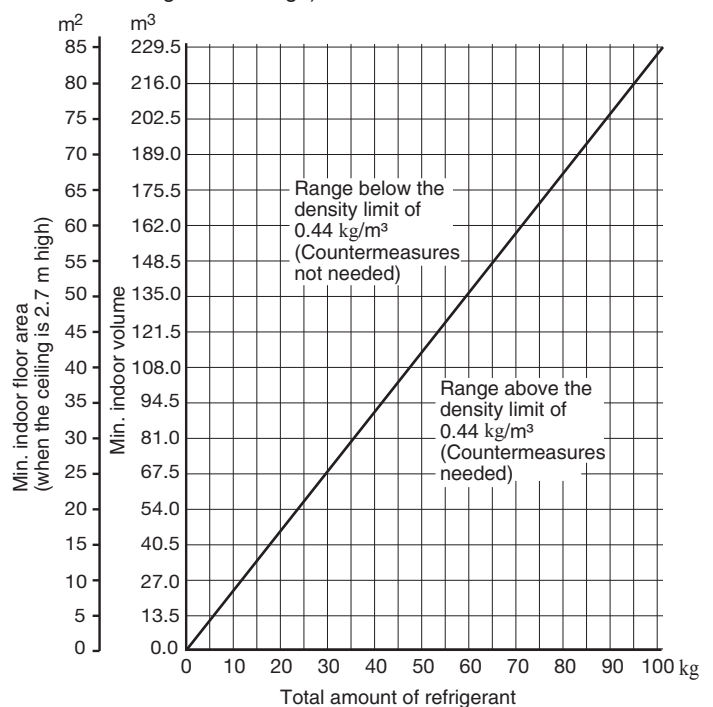
(2) When there is an effective opening with the adjacent room for ventilation of leaking refrigerant gas (opening without a door, or an opening 0.15% or larger than the respective floor spaces at the top or bottom of the door).



(3) If an indoor unit is installed in each partitioned room and the refrigerant tubing is interconnected, the smallest room of course becomes the object. But when mechanical ventilation is installed interlocked with a gas leakage detector in the smallest room where the density limit is exceeded, the volume of the next smallest room becomes the object.



2. The minimum indoor floor space compared with the amount of refrigerant is roughly as follows: (When the ceiling is 2.7 m high)



# Precautions for Installation Using New Refrigerant

## 1. Care regarding tubing

### 1-1. Process tubing

- **Material:** Use seamless phosphorous deoxidized copper tube for refrigeration. Wall thickness shall comply with the applicable legislation. The minimal wall thickness must be in accordance with the table below.
- **Tubing size: Be sure to use the sizes indicated in the table below.**  
For the renewal tubing size, refer to the Technical Data.
- Use a tube cutter when cutting the tubing, and be sure to remove any flash. This also applies to distribution joints (optional).
- When bending tubing, use a bending radius that is 4 times the outer diameter of the tubing or larger.



**CAUTION**

**Use sufficient care in handling the tubing. Seal the tubing ends with caps or tape to prevent dirt, moisture, or other foreign substances from entering. These substances can result in system malfunction.**

Unit: mm

| Material    |                | Temper - O (Soft copper tube) |      |      |       |
|-------------|----------------|-------------------------------|------|------|-------|
| Copper tube | Outer diameter | 6.35                          | 9.52 | 12.7 | 15.88 |
|             | Wall thickness | 0.8                           | 0.8  | 0.8  | 1.0   |

1-2. Prevent impurities including water, dust and oxide from entering the tubing. Impurities can cause R410A refrigerant deterioration and compressor defects. Due to the features of the refrigerant and refrigerating machine oil, the prevention of water and other impurities becomes more important than ever.

## 2. Be sure to recharge the refrigerant only in liquid form.

- 2-1. Since R410A is a non-azeotrope, recharging the refrigerant in gas form can lower performance and cause defects in the unit.
- 2-2. Since refrigerant composition changes and performance decreases when gas leaks, collect the remaining refrigerant and recharge the required total amount of new refrigerant after fixing the leak.

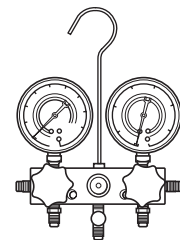
## 3. Different tools required

3-1. Tool specifications have been changed due to the characteristics of R410A.

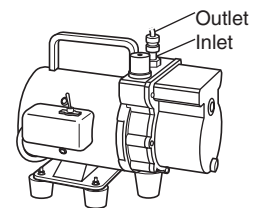
Some tools for R22- and R407C-type refrigerant systems cannot be used.

| Item           | New tool? | R407C tools compatible with R410A? | Remarks   |
|----------------|-----------|------------------------------------|---|
| Manifold gauge | Yes       | No                                 | Types of refrigerant, refrigerating machine oil, and pressure gauge are different.  |
| Charge hose    | Yes       | No                                 | To resist higher pressure, material must be changed.  |
| Vacuum pump    | Yes       | Yes                                | Use a conventional vacuum pump if it is equipped with a check valve. If it has no check valve, purchase and attach a vacuum pump adapter.   |
| Leak detector  | Yes       | No                                 | Leak detectors for CFC and HCFC that react to chlorine do not function because R410A contains no chlorine. Leak detectors for HFC134a can be used for R410A.  |
| Flaring oil    | Yes       | No                                 | For systems that use R22, apply mineral oil (Suniso oil) to the flare nuts on the tubing to prevent refrigerant leakage. For machines that use R407C or R410A, apply synthetic oil (ether oil) to the flare nuts. |

**Manifold gauge**



**Vacuum pump**



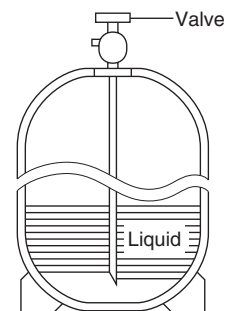
\* Using tools for R22 and R407C and new tools for R410A together can cause defects.

3-2. Use R410A exclusive cylinder only.

### Single-outlet valve

(with siphon tube)

Liquid refrigerant should be recharged with the cylinder standing on end as shown.



## Important Information Regarding The Refrigerant Used

This product contains fluorinated greenhouse gases. Do not vent gases into the atmosphere.

Refrigerant type: R410A

GWP<sup>(1)</sup> value: 2088

<sup>(1)</sup>GWP = global warming potential

Periodical inspections for refrigerant leaks may be required depending on European or local legislation. Please contact your local dealer for more information.

Please fill in with indelible ink,

- ①: the factory refrigerant charge of the product
- ②: the additional refrigerant amount charged in the field
- ① + ②: the total refrigerant charge
- (① + ②) x ③/1000: CO<sub>2</sub> equivalent in tons; multiply the total refrigerant charge by GWP value, then divided by 1000. on the refrigerant charge label supplied with the product.

The filled out label must be adhered in the proximity of the product charging port (e.g. onto the inside of the service cover).

This product contains fluorinated greenhouse gases.  
CO<sub>2</sub> equivalent amount is shown in "CO<sub>2</sub> eq."

**R410A**

GWP : 2088 ③

① = [ ] kg

② = [ ] kg

① + ② = [ ] kg

"CO<sub>2</sub> eq."  
(① + ②) x ③  
1 000 = [ ] ton

\* English text printed on this label is original. Each language label will be sealed on this original text.

1. Factory refrigerant charge of the product: see unit name plate
2. Additional refrigerant amount charged in the field\*
3. Total refrigerant charge
4. Contains fluorinated greenhouse gases
5. Outdoor unit
6. Refrigerant cylinder and manifold for charging
7. GWP(global warming potential) of the refrigerant used in this product
8. CO<sub>2</sub> equivalent of fluorinated greenhouse gases contained in this product

\* See the section "Tubing Size" on page 1-11-1-6.

# Combination of Indoor and Outdoor Units

**PE1** **PE2**

## Single-phase

|           | 36                           | 45                           | 50                           | 60                           | 71                           | 100                        | 125                        | 140                        |
|-----------|------------------------------|------------------------------|------------------------------|------------------------------|------------------------------|----------------------------|----------------------------|----------------------------|
| <b>U2</b> | S-36PU2E5A<br>U-36PE2E5A     |                              | S-50PU2E5A<br>U-50PE2E5A     | S-60PU2E5A<br>U-60PE2E5A     | S-71PU2E5A<br>U-71PE1E5A     | S-100PU2E5A<br>U-100PE1E5A | S-125PU2E5A<br>U-125PE1E5A | S-140PU2E5A<br>U-140PE1E5A |
|           | S-36PU2E5A x2<br>U-71PE1E5A  |                              | S-50PU2E5A x2<br>U-100PE1E5A | S-60PU2E5A x2<br>U-125PE1E5A | S-71PU2E5A x2<br>U-140PE1E5A |                            |                            |                            |
|           | S-36PU2E5A x3<br>U-100PE1E5A | S-45PU2E5A x3<br>U-125PE1E5A | S-50PU2E5A x3<br>U-140PE1E5A |                              |                              |                            |                            |                            |
|           | S-36PU2E5A x4<br>U-125PE1E5A |                              |                              |                              |                              |                            |                            |                            |
| <b>T2</b> | S-36PT2E5A<br>U-36PE2E5A     |                              | S-50PT2E5A<br>U-50PE2E5A     | S-60PT2E5A<br>U-60PE2E5A     | S-71PT2E5A<br>U-71PE1E5A     | S-100PT2E5A<br>U-100PE1E5A | S-125PT2E5A<br>U-125PE1E5A | S-140PT2E5A<br>U-140PE1E5A |
|           | S-36PT2E5A x2<br>U-71PE1E5A  |                              | S-50PT2E5A x2<br>U-100PE1E5A | S-60PT2E5A x2<br>U-125PE1E5A | S-71PT2E5A x2<br>U-140PE1E5A |                            |                            |                            |
|           | S-36PT2E5A x3<br>U-100PE1E5A | S-45PT2E5A x3<br>U-125PE1E5A | S-50PT2E5A x3<br>U-140PE1E5A |                              |                              |                            |                            |                            |
|           | S-36PT2E5A x4<br>U-125PE1E5A |                              |                              |                              |                              |                            |                            |                            |
| <b>K1</b> | S-36PK1E5A<br>U-36PE2E5A     |                              | S-50PK1E5A<br>U-50PE2E5A     | S-60PK1E5A<br>U-60PE2E5A     | S-71PK1E5A<br>U-71PE1E5A     | S-100PK1E5A<br>U-100PE1E5A |                            |                            |
|           | S-36PK1E5A x2<br>U-71PE1E5A  |                              | S-50PK1E5A x2<br>U-100PE1E5A |                              |                              |                            |                            |                            |
|           | S-36PK1E5A x3<br>U-100PE1E5A |                              |                              |                              |                              |                            |                            |                            |
|           |                              |                              |                              |                              |                              |                            |                            |                            |
| <b>F1</b> | S-36PF1E5A<br>U-36PE2E5A     |                              | S-50PF1E5A<br>U-50PE2E5A     | S-60PF1E5A<br>U-60PE2E5A     | S-71PF1E5A<br>U-71PE1E5A     | S-100PF1E5A<br>U-100PE1E5A | S-125PF1E5A<br>U-125PE1E5A | S-140PF1E5A<br>U-140PE1E5A |
|           | S-36PF1E5A x2<br>U-71PE1E5A  |                              | S-50PF1E5A x2<br>U-100PE1E5A | S-60PF1E5A x2<br>U-125PE1E5A | S-71PF1E5A x2<br>U-140PE1E5A |                            |                            |                            |
|           | S-36PF1E5A x3<br>U-100PE1E5A | S-45PF1E5A x3<br>U-125PE1E5A | S-50PF1E5A x3<br>U-140PE1E5A |                              |                              |                            |                            |                            |
|           | S-36PF1E5A x4<br>U-125PE1E5A |                              |                              |                              |                              |                            |                            |                            |
| <b>N1</b> | S-36PN1E5A<br>U-36PE2E5A     |                              | S-50PN1E5A<br>U-50PE2E5A     | S-60PN1E5A<br>U-60PE2E5A     | S-71PN1E5A<br>U-71PE1E5A     | S-100PN1E5A<br>U-100PE1E5A | S-125PN1E5A<br>U-125PE1E5A | S-140PN1E5A<br>U-140PE1E5A |
|           | S-36PN1E5A x2<br>U-71PE1E5A  |                              | S-50PN1E5A x2<br>U-100PE1E5A | S-60PN1E5A x2<br>U-125PE1E5A | S-71PN1E5A x2<br>U-140PE1E5A |                            |                            |                            |
|           | S-36PN1E5A x3<br>U-100PE1E5A | S-45PN1E5A x3<br>U-125PE1E5A | S-50PN1E5A x3<br>U-140PE1E5A |                              |                              |                            |                            |                            |
|           | S-36PN1E5A x4<br>U-125PE1E5A |                              |                              |                              |                              |                            |                            |                            |
| <b>Y2</b> | S-36PY2E5A<br>U-36PE2E5A     |                              | S-50PY2E5A<br>U-50PE2E5A     |                              |                              |                            |                            |                            |
|           | S-36PY2E5A x2<br>U-71PE1E5A  |                              | S-50PY2E5A x2<br>U-100PE1E5A |                              |                              |                            |                            |                            |
|           | S-36PY2E5A x3<br>U-100PE1E5A | S-45PY2E5A x3<br>U-125PE1E5A | S-50PY2E5A x3<br>U-140PE1E5A |                              |                              |                            |                            |                            |
|           | S-36PY2E5A x4<br>U-125PE1E5A |                              |                              |                              |                              |                            |                            |                            |



# Combination of Indoor and Outdoor Units

**PE1**

## 3-phase

|           | 36                           | 45                           | 50                           | 60                           | 71                           | 100                        | 125                        | 140                        |
|-----------|------------------------------|------------------------------|------------------------------|------------------------------|------------------------------|----------------------------|----------------------------|----------------------------|
| <b>U2</b> |                              |                              |                              |                              | S-71PU2E5A<br>U-71PE1E8A     | S-100PU2E5A<br>U-100PE1E8A | S-125PU2E5A<br>U-125PE1E8A | S-140PU2E5A<br>U-140PE1E8A |
|           | S-36PU2E5A x2<br>U-71PE1E8A  |                              | S-50PU2E5A x2<br>U-100PE1E8A | S-60PU2E5A x2<br>U-125PE1E8A | S-71PU2E5A x2<br>U-140PE1E8A |                            |                            |                            |
|           | S-36PU2E5A x3<br>U-100PE1E8A | S-45PU2E5A x3<br>U-125PE1E8A | S-50PU2E5A x3<br>U-140PE1E8A |                              |                              |                            |                            |                            |
|           | S-36PU2E5A x4<br>U-125PE1E8A |                              |                              |                              |                              |                            |                            |                            |
| <b>T2</b> |                              |                              |                              |                              | S-71PT2E5A<br>U-71PE1E8A     | S-100PT2E5A<br>U-100PE1E8A | S-125PT2E5A<br>U-125PE1E8A | S-140PT2E5A<br>U-140PE1E8A |
|           | S-36PT2E5A x2<br>U-71PE1E8A  |                              | S-50PT2E5A x2<br>U-100PE1E8A | S-60PT2E5A x2<br>U-125PE1E8A | S-71PT2E5A x2<br>U-140PE1E8A |                            |                            |                            |
|           | S-36PT2E5A x3<br>U-100PE1E8A | S-45PT2E5A x3<br>U-125PE1E8A | S-50PT2E5A x3<br>U-140PE1E8A |                              |                              |                            |                            |                            |
|           | S-36PT2E5A x4<br>U-125PE1E8A |                              |                              |                              |                              |                            |                            |                            |
| <b>K1</b> |                              |                              |                              |                              | S-71PK1E5A<br>U-71PE1E8A     | S-100PK1E5A<br>U-100PE1E8A |                            |                            |
|           | S-36PK1E5A x2<br>U-71PE1E8A  |                              | S-50PK1E5A x2<br>U-100PE1E8A |                              |                              |                            |                            |                            |
|           | S-36PK1E5A x3<br>U-100PE1E8A |                              |                              |                              |                              |                            |                            |                            |
|           |                              |                              |                              |                              |                              |                            |                            |                            |
| <b>F1</b> |                              |                              |                              |                              | S-71PF1E5A<br>U-71PE1E8A     | S-100PF1E5A<br>U-100PE1E8A | S-125PF1E5A<br>U-125PE1E8A | S-140PF1E5A<br>U-140PE1E8A |
|           | S-36PF1E5A x2<br>U-71PE1E8A  |                              | S-50PF1E5A x2<br>U-100PE1E8A | S-60PF1E5A x2<br>U-125PE1E8A | S-71PF1E5A x2<br>U-140PE1E8A |                            |                            |                            |
|           | S-36PF1E5A x3<br>U-100PE1E8A | S-45PF1E5A x3<br>U-125PE1E8A | S-50PF1E5A x3<br>U-140PE1E8A |                              |                              |                            |                            |                            |
|           | S-36PF1E5A x4<br>U-125PE1E8A |                              |                              |                              |                              |                            |                            |                            |
| <b>N1</b> |                              |                              |                              |                              | S-71PN1E5A<br>U-71PE1E8A     | S-100PN1E5A<br>U-100PE1E8A | S-125PN1E5A<br>U-125PE1E8A | S-140PN1E5A<br>U-140PE1E8A |
|           | S-36PN1E5A x2<br>U-71PE1E8A  |                              | S-50PN1E5A x2<br>U-100PE1E8A | S-60PN1E5A x2<br>U-125PE1E8A | S-71PN1E5A x2<br>U-140PE1E8A |                            |                            |                            |
|           | S-36PN1E5A x3<br>U-100PE1E8A | S-45PN1E5A x3<br>U-125PE1E8A | S-50PN1E5A x3<br>U-140PE1E8A |                              |                              |                            |                            |                            |
|           | S-36PN1E5A x4<br>U-125PE1E8A |                              |                              |                              |                              |                            |                            |                            |
| <b>Y2</b> |                              |                              |                              |                              |                              |                            |                            |                            |
|           | S-36PY2E5A x2<br>U-71PE1E8A  |                              | S-50PY2E5A x2<br>U-100PE1E8A |                              |                              |                            |                            |                            |
|           | S-36PY2E5A x3<br>U-100PE1E8A | S-45PY2E5A x3<br>U-125PE1E8A | S-50PY2E5A x3<br>U-140PE1E8A |                              |                              |                            |                            |                            |
|           | S-36PY2E5A x4<br>U-125PE1E8A |                              |                              |                              |                              |                            |                            |                            |

## Combination of Indoor and Outdoor Units

**PEY1** **PEY2**

### Single-phase

|           | 50                           | 60                           | 71                       | 100                        | 125                        | 140 |
|-----------|------------------------------|------------------------------|--------------------------|----------------------------|----------------------------|-----|
| <b>U2</b> |                              | S-60PU2E5A<br>U-60PEY2E5     | S-71PU2E5A<br>U-71PEY2E5 | S-100PU2E5A<br>U-100PEY1E5 | S-125PU2E5A<br>U-125PEY1E5 |     |
|           | S-50PU2E5A x2<br>U-100PEY1E5 | S-60PU2E5A x2<br>U-125PEY1E5 |                          |                            |                            |     |
| <b>T2</b> |                              | S-60PT2E5A<br>U-60PEY2E5     | S-71PT2E5A<br>U-71PEY2E5 | S-100PT2E5A<br>U-100PEY1E5 | S-125PT2E5A<br>U-125PEY1E5 |     |
|           | S-50PT2E5A x2<br>U-100PEY1E5 | S-60PT2E5A x2<br>U-125PEY1E5 |                          |                            |                            |     |
| <b>K1</b> |                              | S-60PK1E5A<br>U-60PEY2E5     | S-71PK1E5A<br>U-71PEY2E5 | S-100PK1E5A<br>U-100PEY1E5 |                            |     |
|           | S-50PK1E5A x2<br>U-100PEY1E5 |                              |                          |                            |                            |     |
| <b>F1</b> |                              | S-60PF1E5A<br>U-60PEY2E5     | S-71PF1E5A<br>U-71PEY2E5 | S-100PF1E5A<br>U-100PEY1E5 | S-125PF1E5A<br>U-125PEY1E5 |     |
|           | S-50PF1E5A x2<br>U-100PEY1E5 | S-60PF1E5A x2<br>U-125PEY1E5 |                          |                            |                            |     |
| <b>N1</b> |                              | S-60PN1E5A<br>U-60PEY2E5     | S-71PN1E5A<br>U-71PEY2E5 | S-100PN1E5A<br>U-100PEY1E5 | S-125PN1E5A<br>U-125PEY1E5 |     |
|           | S-50PN1E5A x2<br>U-100PEY1E5 | S-60PN1E5A x2<br>U-125PEY1E5 |                          |                            |                            |     |
| <b>Y2</b> |                              |                              |                          |                            |                            |     |
|           | S-50PY2E5A x2<br>U-100PEY1E5 |                              |                          |                            |                            |     |

**PEY1**

### 3-phase

|           | 50                           | 60                           | 71                           | 100                        | 125                        | 140                        |
|-----------|------------------------------|------------------------------|------------------------------|----------------------------|----------------------------|----------------------------|
| <b>U2</b> |                              |                              |                              | S-100PU2E5A<br>U-100PEY1E8 | S-125PU2E5A<br>U-125PEY1E8 | S-140PU2E5A<br>U-140PEY1E8 |
|           | S-50PU2E5A x2<br>U-100PEY1E8 | S-60PU2E5A x2<br>U-125PEY1E8 | S-71PU2E5A x2<br>U-140PEY1E8 |                            |                            |                            |
| <b>T2</b> |                              |                              |                              | S-100PT2E5A<br>U-100PEY1E8 | S-125PT2E5A<br>U-125PEY1E8 | S-140PT2E5A<br>U-140PEY1E8 |
|           | S-50PT2E5A x2<br>U-100PEY1E8 | S-60PT2E5A x2<br>U-125PEY1E8 | S-71PT2E5A x2<br>U-140PEY1E8 |                            |                            |                            |
| <b>K1</b> |                              |                              |                              | S-100PK1E5A<br>U-100PEY1E8 |                            |                            |
|           | S-50PK1E5A x2<br>U-100PEY1E8 |                              |                              |                            |                            |                            |
| <b>F1</b> |                              |                              |                              | S-100PF1E5A<br>U-100PEY1E8 | S-125PF1E5A<br>U-125PEY1E8 | S-140PF1E5A<br>U-140PEY1E8 |
|           | S-50PF1E5A x2<br>U-100PEY1E8 | S-60PF1E5A x2<br>U-125PEY1E8 | S-71PF1E5A x2<br>U-140PEY1E8 |                            |                            |                            |
| <b>N1</b> |                              |                              |                              | S-100PN1E5A<br>U-100PEY1E8 | S-125PN1E5A<br>U-125PEY1E8 | S-140PN1E5A<br>U-140PEY1E8 |
|           | S-50PN1E5A x2<br>U-100PEY1E8 | S-60PN1E5A x2<br>U-125PEY1E8 | S-71PN1E5A x2<br>U-140PEY1E8 |                            |                            |                            |
| <b>Y2</b> |                              |                              |                              |                            |                            |                            |
|           | S-50PY2E5A x2<br>U-100PEY1E8 |                              |                              |                            |                            |                            |

# — CONTENTS —

|   |                |
|---|----------------|
| <b>Section 1. SPECIFICATIONS</b> .....  | <b>1-1-1-1</b> |
| 1-1. Unit Specifications .....  | 1-1-1-2        |
| 1-2. Dimensional Data .....   | 1-2-1          |
| 1-3. Refrigerant Flow Diagram .....   | 1-3-1          |
| 1-4. Operating Range .....  | 1-4-1          |
| 1-5. Capacity Correction Graph According to Temperature Condition .....   | 1-5-1          |
| 1-6. Noise Criterion Curves .....   | 1-6-1          |
| 1-7. Indoor Fan Performance .....   | 1-7-1          |
| 1-8. Airflow Distance Chart .....   | 1-8-1          |
| 1-9. Fresh Air Intake .....   | 1-9-1          |
| 1-10. Electrical Wiring .....   | 1-10-1         |
| 1-11. Installation Instructions .....   | 1-11-1-1       |
| ■ Outdoor Unit .....  | 1-11-1-1       |
| ■ Indoor Unit .....   | 1-11-3-1       |
| 1-12. How to select AHU system .....  | 1-12-1         |
| 1-13. Capacity Table .....  | 1-13-1-1       |
| 1. Cooling Capacity Performance Data .....  | 1-13-1-1       |
| 2. Heating Capacity Performance Data .....  | 1-13-2-1       |
| 1-14. Product Fiche .....   | 1-14-1         |
| 1-15. Information Table.....  | 1-15-1         |
| <b>Section 2. TEST RUN</b> .....  | <b>2-1</b>     |
| ■ U-36PE2E5A, U-50PE2E5A, U-60PE2E5A<br>U-60PEY2E5, U-71PEY2E5  |                |
| 2-1. Preparing for Test Run.....  | 2-2            |
| 2-2. Caution.....   | 2-3            |
| 2-3. Test Run Procedure .....   | 2-3            |
| 2-4. Items to Check Before the Test Run .....   | 2-3            |
| 2-5. Test Run Using the Remote Controller .....   | 2-4            |
| 2-6. Precautions .....  | 2-5            |
| 2-7. Setting the outdoor unit system addresses .....  | 2-6            |
| 2-8. Auto address setting using the remote controller.....  | 2-7            |
| 2-9. Indicating (marking) the indoor and outdoor unit combination number .....  | 2-9            |
| 2-10. Contents of the alarm on the remote controller .....  | 2-10           |
| 2-11. Auto address setting from the outdoor unit.....   | 2-13           |
| 2-12. Test run using the indicator of the indoor unit (Type K1) .....   | 2-13           |
| 2-13. Caution for Pump Down.....  | 2-13           |
| ■ U-71PE1E5A, U-100PE1E5A, U-125PE1E5A, U-140PE1E5A<br>U-100PEY1E5, U-125PEY1E5<br>U-71PE1E8A, U-100PE1E8A, U-125PE1E8A, U-140PE1E8A<br>U-100PEY1E8, U-125PEY1E8, U-140PEY1E8 |                |
| 2-14. PRECAUTIONS REGARDING TEST RUN .....  | 2-14           |
| 2-15. CHECKS AFTER INSTALLATION HAVE COMPLETED .....  | 2-15           |
| 2-16. REGARDING DELIVERY TO THE CUSTOMER .....  | 2-15           |
| <b>Section 3. ELECTRICAL DATA</b> .....   | <b>3-1</b>     |
| 3-1. Indoor Units (Electric Wiring Diagram) .....   | 3-2            |
| 3-2. Outdoor Units (Electric Wiring Diagram) .....  | 3-9            |

|   |            |
|---|------------|
| <b>Section 4. CONTROL FUNCTIONS .....</b>   | <b>4-1</b> |
| 4-1. Room Temperature Control .....   | 4-2        |
| 4-2. Heating Standby .....  | 4-4        |
| 4-3. Automatic Fan Speed Control .....  | 4-5        |
| 4-4. Drain Pump Control .....   | 4-6        |
| 4-5. Automatic Heating/Cooling Control .....  | 4-7        |
| 4-6. Automatic Flap Control .....   | 4-8        |
| 4-7. Filter Sign .....  | 4-8        |
| 4-8. Fan Control during Dry Mode .....  | 4-9        |
| 4-9. Ventilation Fan Output .....   | 4-9        |
| 4-10. T10 Terminal .....  | 4-9        |
| 4-11. Parameter .....   | 4-10       |
| 4-12. Control Functions .....   | 4-11       |
| 4-13. Outdoor Unit Control PCB .....  | 4-23       |
| <b>Section 5. TROUBLE DIAGNOSIS .....</b>   | <b>5-1</b> |
| 5-1. Contents of Remote Controller Switch Alarm Display .....                                 | 5-2        |
| 5-2. Outdoor Unit Control Panel LED Display .....   | 5-6        |
| 5-3. PAC System Alarm Codes .....   | 5-7        |
| 5-4. Inspection of Parts (Outdoor Unit) .....   | 5-78       |
| 5-5. Symptom: Thermostat in OFF continues or cycles OFF & ON too frequently .....             | 5-79       |
| 5-6. How to Clean Heat Exchanger .....  | 5-80       |
| 5-7. How to Replace Fan Motor .....   | 5-81       |
| <b>Section 6. OUTDOOR UNIT MAINTENANCE REMOTE CONTROLLER .....</b>                            | <b>6-1</b> |
| 6-1. Overview .....   | 6-2        |
| 6-2. Functions .....  | 6-2        |
| 6-3. Normal Display Operations and Functions .....  | 6-3        |
| 6-4. Monitoring Operations: Display of Indoor Unit and Outdoor Unit Sensor Temperatures ..... | 6-8        |
| 6-5. Monitoring the Outdoor Unit Alarm History: Display of Outdoor Unit Alarm History .....   | 6-10       |
| 6-6. Settings Modes: Setting the Outdoor Unit EEPROM .....                                    | 6-11       |
| <b>Section 7. REMOTE CONTROLLER FUNCTIONS SECTION .....</b>                                   | <b>7-1</b> |
| 7-1. Simple Settings Function .....   | 7-2        |
| 7-2. List of Simple Setting Items .....   | 7-5        |
| 7-3. Detailed Settings Function .....   | 7-6        |
| 7-4. List of Detailed Setting Items .....   | 7-9        |
| 7-5. Simple Setting Items .....   | 7-13       |
| 7-6. Detailed Setting Items .....   | 7-15       |
| 7-7. Remote Controller Servicing Functions .....  | 7-19       |
| 7-8. Test Run Function .....  | 7-22       |

**Section 8. HOW TO INSTALL THE WIRELESS REMOTE CONTROLLER RECEIVER ..... 8-1**

- Important Safety Instructions ..... 8-2
- Optional Controller (Remote Controller) ..... 8-3
- 8-1. Names and Functions ..... 8-3
- 8-2. Installing Batteries ..... 8-5
- 8-3. Setting the Current Time ..... 8-5
- 8-4. Operation ..... 8-6
- 8-5. Timer Operation ..... 8-7
- 8-6. Adjusting the Wind Direction ..... 8-8
- 8-7. Operating Multiple In/Outdoor Units Simultaneously (Group Control) ..... 8-8
- 8-8. Using the Remote Controller ..... 8-9
- 8-9. For Best Results ..... 8-9
- 8-10. Addresses ..... 8-9
- 8-11. Emergency Operation ..... 8-11
- 8-12. Miscellaneous Settings ..... 8-12
- 8-13. Before Requesting Service ..... 8-13
- How to Install the Wireless Remote Controller Receiver ..... 8-14
- 8-14. Common to All Models ..... 8-14
- 8-15. CZ-RWSU3 ..... 8-16
- 8-16. CZ-RWSC3 ..... 8-18
- 8-17. CZ-RWST3N ..... 8-22
- 8-18. Common to All Models ..... 8-24

– MEMO –

# 1. SPECIFICATIONS

|  |                 |
|--|-----------------|
| <b>1-1. Unit Specifications .....</b>  | <b>1-1-1-2</b>  |
| <b>PE1 PE2</b>   |                 |
| 1. 4-Way Cassette Type (U2) .....  | 1-1-1-2         |
| 2. Ceiling Type (T2) .....   | 1-1-2-1         |
| 3. Wall Mounted Type (K1) .....  | 1-1-3-1         |
| 4. Low Silhouette Ducted Type (F1) .....                                       | 1-1-4-1         |
| 5. Ducted Type (N1) .....  | 1-1-5-1         |
| 6. 4-Way Cassette 60 x 60 Type (Y2).....                                       | 1-1-6-1         |
| <b>PEY1 PEY2</b>   |                 |
| 7. 4-Way Cassette Type (U2) .....  | 1-1-7-1         |
| 8. Ceiling Type (T2) .....   | 1-1-8-1         |
| 9. Wall Mounted Type (K1) .....  | 1-1-9-1         |
| 10. Low Silhouette Ducted Type (F1) .....                                      | 1-1-10-1        |
| 11. Ducted Type (N1) .....   | 1-1-11-1        |
| 12. 4-Way Cassette 60 x 60 Type (Y2) .....                                     | 1-1-12-1        |
| <b>1-2. Dimensional Data .....</b>   | <b>1-2-1</b>    |
| (A) Indoor Units .....   | 1-2-1           |
| (B) Outdoor Units .....  | 1-2-11          |
| <b>1-3. Refrigerant Flow Diagram .....</b>                                     | <b>1-3-1</b>    |
| <b>1-4. Operating Range .....</b>  | <b>1-4-1</b>    |
| <b>1-5. Capacity Correction Graph According to Temperature Condition .....</b> | <b>1-5-1</b>    |
| <b>1-6. Noise Criterion Curves .....</b>                                       | <b>1-6-1</b>    |
| <b>1-7. Indoor Fan Performance .....</b>                                       | <b>1-7-1</b>    |
| <b>1-8. Airflow Distance Chart .....</b>                                       | <b>1-8-1</b>    |
| <b>1-9. Fresh Air Intake .....</b>   | <b>1-9-1</b>    |
| <b>1-10. Electrical Wiring .....</b>   | <b>1-10-1</b>   |
| <b>1-11. Installation Instructions .....</b>                                   | <b>1-11-1-1</b> |
| <b>Outdoor Unit</b> .....  | 1-11-1-1        |
| 1. U-36PE2E5A, U-50PE2E5A, U-60PE2E5A, U-60PEY2E5, U-71PEY2E5 .....            | 1-11-1-1        |
| Supplement .....   | 1-11-1-14       |
| 2. U-71PE1E5A ~ U-140PE1E5A, U-71PE1E8A ~ U-140PE1E8A                          |                 |
| U-100PEY1E5, U-125PEY1E5, U-100PEY1E8, U-125PEY1E8, U-140PEY1E8.....           | 1-11-2-1        |
| <b>Indoor Unit</b> .....   | 1-11-3-1        |
| 3. 4-Way Cassette Type (U2) .....  | 1-11-3-1        |
| 4. Ceiling Type (T2) .....   | 1-11-4-1        |
| 5. Wall Mounted Type (K1) .....  | 1-11-5-1        |
| 6. Low Silhouette Ducted Type (F1) .....                                       | 1-11-6-1        |
| 7. Ducted Type (N1) .....  | 1-11-7-1        |
| 8. 4-Way Cassette 60 x 60 Type (Y2) .....                                      | 1-11-8-1        |
| <b>1-12. How to select AHU system .....</b>                                    | <b>1-12-1</b>   |
| <b>1-13. Capacity Table .....</b>  | <b>1-13-1-1</b> |
| 1. Cooling Capacity Performance Data .....                                     | 1-13-1-1        |
| 2. Heating Capacity Performance Data .....                                     | 1-13-2-1        |
| <b>1-14. Product Fiche .....</b>   | <b>1-14-1</b>   |
| <b>1-15. Information Table .....</b>   | <b>1-15-1</b>   |

# Single -Type

## 1-1. Unit Specifications

**PE2**

### 1. 4-Way Cassette Type S-36PU2E5A / U-36PE2E5A

| INDOOR   |  | MODEL                    | S-36PU2E5A   |            |                               | -                                  |              |              | -    |        |      |
|--|--|--------------------------|--|------------|-------------------------------|------------------------------------|--------------|--------------|------|--------|------|
| PANEL  |  | MODEL                    | Standard type:CZ-KPU3 / ECONAVI type:CZ-KPU3A            |            |                               | -                                  |              |              | -    |        |      |
| OUTDOOR  |  | MODEL                    | -  |            |                               | U-36PE2E5A                         |              |              | -    |        |      |
| Branch pipe  |  | MODEL                    | -  |            |                               | -                                  |              |              | -    |        |      |
| Performance test condition                                 |  |                          | ISO5151 / EN14511 / EN12102/ EN14825                     |            |                               |                                    |              |              |      |        |      |
| Power supply   |  | Ø, Hz                    | 1Ø 50Hz  |            |                               | 1Ø 50Hz                            |              |              |      |        |      |
|  |  | V                        | 220V   | 230V       | 240V                          | 220V                               | 230V         | 240V         | Min  | Max    |      |
| C<br>O<br>O<br>L<br>I<br>N<br>G                            | Capacity                                 | kW                       | 3.6  | 3.6        | 3.6                           | -                                  | -            | -            | 1.5  | 4.0    |      |
|  |  | BTU/h                    | 12300  | 12300      | 12300                         | -                                  | -            | -            | 5100 | 13600  |      |
|  | Current                                  | A                        | 0.23   | 0.23       | 0.22                          | 3.75                               | 3.55         | 3.40         | -    | -      |      |
|  |  | W                        | 24   | 24         | 24                            | 0.746k                             | 0.746k       | 0.746k       | -    | -      |      |
|  | Input power                              | TOTAL W                  | -  | -          | -                             | 0.770k                             | 0.770k       | 0.770k       | 240  | 910    |      |
|  |  | Annual consumption       | TOTAL kWh *4   | -          | -                             | -                                  | -            | 385          | -    | -      | -    |
|  | EER/EER CLASS                            | TOTAL (W/W) *5 / ("A"-G) | -  | -          | -                             | 4.68                               | 4.68/A       | 4.68         | 6.25 | 4.40   |      |
|  | E <sub>rp</sub> *6                       | Pdesign                  | kW   | -          | -                             | -                                  | -            | 3.6          | -    | -      | -    |
|  |  | SEER                     | (W/W)  | -          | -                             | -                                  | -            | 7.4          | -    | -      | -    |
|  |  | Annual consumption       | kWh  | -          | -                             | -                                  | -            | 170          | -    | -      | -    |
| Class  |  |                          | -  | -          | -                             | -                                  | A++          | -            | -    | -      |      |
| Power factor   | %  | -                        | -  | -          | 91                            | 91                                 | 91           | -            | -    |        |      |
| Noise indoor   | dB-A (H/M/L) *7                          | 30/28/27                 |  |            | -                             |                                    |              | -            | -    |        |      |
|  | Power Level dB                           | 45/43/42                 |  |            | -                             |                                    |              | -            | -    |        |      |
| Noise outdoor  | dB-A (H/L)                               | -                        |  |            | 45/-                          |                                    |              | -            | -    |        |      |
|  | Power Level dB                           | -                        |  |            | 64/-                          |                                    |              | -            | -    |        |      |
| H<br>E<br>A<br>T<br>I<br>N<br>G                            | Capacity                                 | kW                       | 4.0  | 4.0        | 4.0                           | -                                  | -            | -            | 1.5  | 5.0    |      |
|  |  | BTU/h                    | 13600  | 13600      | 13600                         | -                                  | -            | -            | 5100 | 17100  |      |
|  | Current                                  | A                        | 0.22   | 0.22       | 0.21                          | 3.80                               | 3.60         | 3.45         | -    | -      |      |
|  |  | W                        | 22   | 22         | 22                            | 0.758k                             | 0.758k       | 0.758k       | -    | -      |      |
|  | Input power                              | TOTAL W                  | -  | -          | -                             | 0.780k                             | 0.780k       | 0.780k       | 190  | 1.080k |      |
|  |  | COP/COP CLASS            | TOTAL (W/W) *5 / ("A"-G)                                 | -          | -                             | -                                  | 5.13         | 5.13/A       | 5.13 | 7.89   | 4.63 |
|  | E <sub>rp</sub> *6                       | Pdesign at -10°C         | kW   | -          | -                             | -                                  | -            | 3.6          | -    | -      | -    |
|  |  | Tbivalent                | °C   | -          | -                             | -                                  | -            | -10          | -    | -      | -    |
|  |  | SCOP                     | (W/W)  | -          | -                             | -                                  | -            | 4.6          | -    | -      | -    |
|  |  | Annual consumption       | kWh  | -          | -                             | -                                  | -            | 1095         | -    | -      | -    |
| Class  |  | -                        | -  | -          | -                             | A++                                | -            | -            | -    |        |      |
| Power factor   | %  | -                        | -  | -          | 91                            | 91                                 | 91           | -            | -    |        |      |
| Noise indoor   | dB-A (H/M/L) *7                          | 30/28/27                 |  |            | -                             |                                    |              | -            | -    |        |      |
|  | Power Level dB                           | 45/43/42                 |  |            | -                             |                                    |              | -            | -    |        |      |
| Noise outdoor  | dB-A (H/L)                               | -                        |  |            | 46/-                          |                                    |              | -            | -    |        |      |
|  | Power Level dB                           | -                        |  |            | 66/-                          |                                    |              | -            | -    |        |      |
| EXTRA LOW TEMP   Total capacity(kW) / Input power(W) / COP |  |                          | -  |            |                               |                                    |              |              |      | -      |      |
| Max Current(A) / Max Input power(W)                        |  |                          | 0.23/24  | 0.23/24    | 0.22/24                       | 11.0 / 2.20k                       | 11.0 / 2.30k | 11.0 / 2.40k | -    | -      |      |
| Starting current(A) / Comp output(W)                       |  |                          | -  | -          | -                             | 3.80 / 1.1k                        | 3.60 / 1.1k  | 3.45 / 1.1k  | -    | -      |      |
| Network Impedance(ΩMAX.)                                   |  |                          | -  |            |                               |                                    |              |              |      | -      |      |
| Fan motor output (Indoor/Outdoor) W                        |  |                          | 60   |            |                               | 60                                 |              |              | -    | -      |      |
| Moisture removal volume                                    |  | L/h(Pt/h)                | 0.7  | -          | (1.5)                         | -                                  |              |              | -    | -      |      |
| External static pressure                                   |  |                          | Pa   |            |                               | -                                  |              |              | -    | -      |      |
| Indoor Air flow *7   | Cooling                                  | m³/min (ft³/min)         | 14.5/13.0/11.5 (512)/(459)/(406)                         |            |                               | -                                  |              |              | -    | -      |      |
|  | Heating                                  | m³/min (ft³/min)         | 14.5/13.0/11.5 (512)/(459)/(406)                         |            |                               | -                                  |              |              | -    | -      |      |
| Outdoor Air flow   | Cooling                                  | m³/min (ft³/min)         | -  |            |                               | 38 (1342)                          |              |              | -    | -      |      |
|  | Heating                                  | m³/min (ft³/min)         | -  |            |                               | 38 (1342)                          |              |              | -    | -      |      |
| Refrigerant type / amount g(oz)                            |  |                          | -  |            |                               | R410A 1.40k (49.4)                 |              |              | -    | -      |      |
| Product dimension  | Height                                   | mm(inch)                 | 256  | (10-5/64)  |                               | 619                                | (24-3/8)     |              | -    | -      |      |
|  | Width                                    | mm(inch)                 | 840  | (33-5/64)  |                               | 799                                | (31-29/64)   |              | -    | -      |      |
|  | Depth                                    | mm(inch)                 | 840  | (33-5/64)  |                               | 299                                | (11-49/64)   |              | -    | -      |      |
| Product dimension (Panel)                                  |  | H×W×D mm, inch           | 33.5×950×950   |            | 1-11/32 × 37-13/32 × 37-13/32 |                                    | -            |              |      | -      |      |
| Packing dimension  | Height                                   | mm(inch)                 | 302  | (11-57/64) |                               | 688                                |              |              | -    | -      |      |
|  | Width                                    | mm(inch)                 | 898  | (35-3/8)   |                               | 931                                |              |              | -    | -      |      |
|  | Depth                                    | mm(inch)                 | 898  | (35-3/8)   |                               | 422                                |              |              | -    | -      |      |
| Weight   | (NET)                                    | kg(lb)                   | 19   | (42)       |                               | 39                                 | (86)         |              | -    | -      |      |
|  | (GROSS)                                  | kg(lb)                   | 26   | (57)       |                               | 44                                 | (97)         |              | -    | -      |      |
|  | Panel (NET)                              | kg(lb)                   | 5  | (11)       |                               | -                                  |              |              | -    | -      |      |
|  | Layers limit (actually)                  |                          | 11 (12)  |            |                               | 5 (6)                              |              |              | -    | -      |      |
| Operation condition  | Cool (DBT)                               |                          | 18°C ~ 32°C  |            |                               | -15°C ~ 46°C                       |              |              | -    | -      |      |
|  | Heat (DBT)                               |                          | 16°C ~ 30°C  |            |                               | -20°C ~ 24°C                       |              |              | -    | -      |      |
| P<br>I<br>P<br>I<br>N<br>G                                 | Pipe diameter mm (inch)                  |                          | (Liquid)Ø6.35(1/4) (Gas)Ø12.7(1/2)                       |            |                               | (Liquid)Ø6.35(1/4) (Gas)Ø12.7(1/2) |              |              | -    | -      |      |
|  | Connecting method, Standard length m(ft) |                          | flared type, 5.0(16.4)                                   |            |                               | flared type, 5.0(16.4)             |              |              | -    | -      |      |
| Pipe length range  |  | m (ft)                   | 3 ~ 40m (9.8 ~ 131.2)                                    |            |                               |                                    |              |              |      | -      |      |
| Indoor unit & Outdoor unit height difference               |  | m (ft)                   | 15m(OD located lower)/30m(OD located higher) (49.2/98.4) |            |                               |                                    |              |              |      | -      |      |
| Add gas amount   |  | g/m (oz/ft)              | 20g (0.215)  |            |                               |                                    |              |              |      | -      |      |
| Pipe length for additional gas                             |  | m (ft)                   | 30m (98.4)   |            |                               |                                    |              |              |      | -      |      |

\*1 In case it is necessary to indicate the air flow volume in (l/s), the value in (m³/min.) shall be multiplied by 16.7 and rounded down the decimal point.

\*2 If the EUROVENT Certified models can be operated under the "extra-low" temperature condition, -7°C dry bulb and -8°C wet-bulb temperatures with rated voltage 230V shall be used.

\*3 Network Impedance shall be applicable for EUROPE and CHINA models.

\*4 The annual consumption is calculated by multiplying the input power at 230V(400V) by an average of 500 hours per year in cooling mode.

\*5 EER and COP classification is at 230V(400V) only in accordance with EU directive 2002/31/EC.

\*6 SEER and SCOP classification is at 230V(400V) only in accordance with EN-14825. For heating, SCOP indicates the value of only Average heating season, Other fiche data indicates in an attached sheet.

\*7 H: High at setting 5 stage (Level 5), M: Middle at setting 5 stage (Level 3), L: Low at setting 5 stage (Level 1)



# Simultaneous (Twin) -Type

## 1-1. Unit Specifications

PE1

### 1. 4-Way Cassette Type S-36PU2E5A×2 / U-71PE1E5A

|  |  |  |   |             |                                     |                |              |        |      |        |
|--|--|--|---|-------------|-------------------------------------|----------------|--------------|--------|------|--------|
| INDOOR   |  | MODEL  | S-36PU2E5A×2                                      |             |                                     | -              |              |        | -    |        |
| PANEL  |  | MODEL  | Standard type:CZ-KPU3×2 / ECONAVI type:CZ-KPU3A×2 |             |                                     | -              |              |        | -    |        |
| OUTDOOR  |  | MODEL  | -   |             |                                     | U-71PE1E5A     |              |        | -    |        |
| Branch pipe  |  | MODEL  | -   |             |                                     | CZ-P155BK1     |              |        | -    |        |
| Performance test condition                               |  | ISO5151 / EN14511 / EN12102 / EN14825                    |   |             |                                     |                |              |        |      |        |
| Power supply   |  | ∅, Hz  | 1∅ 50Hz   |             |                                     | 1∅ 50Hz        |              |        |      |        |
|  |  | V  | 220V  | 230V        | 240V                                | 220V           | 230V         | 240V   | Min  | Max    |
| C<br>O<br>O<br>L<br>I<br>N<br>G                          | Capacity                                 | kW   | 7.1   | 7.1         | 7.1                                 | -              | -            | -      | 2.5  | 8.0    |
|  |  | BTU/h  | 24200   | 24200       | 24200                               | -              | -            | -      | 8500 | 27300  |
|  | Current                                  | A  | 0.23 ×2   | 0.23 ×2     | 0.22 ×2                             | 8.40           | 8.15         | 7.90   | -    | -      |
|  |  | W  | 24 ×2   | 24 ×2       | 24 ×2                               | 1.762k         | 1.762k       | 1.762k | -    | -      |
|  | Input power                              | TOTAL W  | -   | -           | -                                   | 1.810k         | 1.810k       | 1.810k | 450  | 2.650k |
|  |  | Annual consumption                                       | TOTAL kWh *4                                      | -           | -                                   | -              | -            | 905    | -    | -      |
|  | EER/EER CLASS                            | TOTAL (W/W) <sup>5)</sup> ("A"-G)                        | -   | -           | -                                   | 3.92           | 3.92/A       | 3.92   | 5.56 | 3.02   |
|  | E <sub>rp</sub> <sup>6)</sup>            | Pdesign  | kW  | -           | -                                   | -              | -            | 7.1    | -    | -      |
|  |  | SEER   | (W/W)   | -           | -                                   | -              | -            | 7.4    | -    | -      |
|  |  | Annual consumption                                       | kWh   | -           | -                                   | -              | -            | 336    | -    | -      |
| Class  |  |  | -   | -           | -                                   | -              | A++          | -      | -    |        |
| Power factor   | %  | -  | -   | -           | 95                                  | 94             | 93           | -      | -    |        |
| Noise indoor   | dB-A (H/M/L) *7                          | 30/28/27   |   |             | -                                   |                |              | -      | -    |        |
|  | Power Level dB                           | 45/43/42   |   |             | -                                   |                |              | -      | -    |        |
| Noise outdoor  | dB-A (H/L)                               | -  |   |             | 48/-                                |                |              | -      | -    |        |
|  | Power Level dB                           | -  |   |             | 65/-                                |                |              | -      | -    |        |
| H<br>E<br>A<br>T<br>I<br>N<br>G                          | Capacity                                 | kW   | 8.0   | 8.0         | 8.0                                 | -              | -            | -      | 2.0  | 9.0    |
|  |  | BTU/h  | 27300   | 27300       | 27300                               | -              | -            | -      | 6800 | 30700  |
|  | Current                                  | A  | 0.22 ×2   | 0.22 ×2     | 0.21 ×2                             | 8.65           | 8.25         | 8.00   | -    | -      |
|  |  | W  | 22 ×2   | 22 ×2       | 22 ×2                               | 1.826k         | 1.826k       | 1.826k | -    | -      |
|  | Input power                              | TOTAL W  | -   | -           | -                                   | 1.870k         | 1.870k       | 1.870k | 400  | 2.850k |
|  |  | COP/COP CLASS  | TOTAL (W/W) <sup>5)</sup> ("A"-G)                 | -           | -                                   | -              | 4.28         | 4.28/A | 4.28 | 5.00   |
|  | E <sub>rp</sub> <sup>6)</sup>            | Pdesign at -10°C   | kW  | -           | -                                   | -              | -            | 7.1    | -    | -      |
|  |  | Tbivalent  | °C  | -           | -                                   | -              | -            | -10    | -    | -      |
|  |  | SCOP   | (W/W)   | -           | -                                   | -              | -            | 4.3    | -    | -      |
|  |  | Annual consumption                                       | kWh   | -           | -                                   | -              | -            | 2312   | -    | -      |
| Class  |  | -  | -   | -           | -                                   | A+             | -            | -      |      |        |
| Power factor   | %  | -  | -   | -           | 96                                  | 96             | 95           | -      | -    |        |
| Noise indoor   | dB-A (H/M/L) *7                          | 30/28/27   |   |             | -                                   |                |              | -      | -    |        |
|  | Power Level dB                           | 45/43/42   |   |             | -                                   |                |              | -      | -    |        |
| Noise outdoor  | dB-A (H/L)                               | -  |   |             | 50/-                                |                |              | -      | -    |        |
|  | Power Level dB                           | -  |   |             | 67/-                                |                |              | -      | -    |        |
| EXTRA LOW TEMP Total capacity(kW) / Input power(W) / COP |  | -  |   |             |                                     |                |              |        |      |        |
| Max Current(A) / Max Input power(W)                      |  | 0.23×2/24×2  | 0.23×2/24×2                                       | 0.22×2/24×2 | 18.0 / 3.80k                        | 18.0 / 3.93k   | 18.0 / 4.06k | -      |      |        |
| Starting current(A) / Comp output(W)                     |  | -  | -   | -           | 8.65 / 2.0k                         | 8.25 / 2.0k    | 8.00 / 2.0k  | -      |      |        |
| Network Impedance(ΩMAX.)                                 |  | -  |   |             |                                     |                |              |        |      |        |
| Fan motor output (Indoor/Outdoor) W                      |  | 60   |   |             | 90                                  |                |              | -      |      |        |
| Moisture removal volume                                  |  | L/h(Pt/h)  | 1.4   | (0.7×2)     | (2.9)                               | -              |              |        | -    |        |
| External static pressure                                 |  | Pa   | -   |             |                                     | -              |              |        | -    |        |
| Indoor Air flow *7                                       | Cooling                                  | m³/min (ft³/min)   | 14.5×2/13.0×2/11.5×2 (512)×2/(459)×2/(406)×2      |             |                                     | -              |              |        | -    |        |
|  | Heating                                  | m³/min (ft³/min)   | 14.5×2/13.0×2/11.5×2 (512)×2/(459)×2/(406)×2      |             |                                     | -              |              |        | -    |        |
| Outdoor Air flow   | Cooling                                  | m³/min (ft³/min)   | -   |             |                                     | 60 (2119)      |              |        | -    |        |
|  | Heating                                  | m³/min (ft³/min)   | -   |             |                                     | 60 (2119)      |              |        | -    |        |
| Refrigerant type / amount g(oz)                          |  | -  |   |             | R410A 2.35k (82.9)                  |                |              | -      |      |        |
| Product dimension  | Height                                   | mm(inch)   | 256   | (10-5/64)   |                                     | 996 (39-7/32)  |              | -      |      |        |
|  | Width                                    | mm(inch)   | 840   | (33-5/64)   |                                     | 940 (37-1/32)  |              | -      |      |        |
|  | Depth                                    | mm(inch)   | 840   | (33-5/64)   |                                     | 340 (13-13/32) |              | -      |      |        |
| Product dimension (Panel)                                |  | H×W×D mm, inch   | 33.5×950×950                                      |             | 1-11/32 × 37-13/32 × 37-13/32       |                | -            |        |      |        |
| Packing dimension  | Height                                   | mm(inch)   | 302   | (11-57/64)  |                                     | 1136           |              | -      |      |        |
|  | Width                                    | mm(inch)   | 898   | (35-3/8)    |                                     | 1055           |              | -      |      |        |
|  | Depth                                    | mm(inch)   | 898   | (35-3/8)    |                                     | 485            |              | -      |      |        |
| Weight   | (NET)                                    | kg(lb)   | 19  | (42)        |                                     | 69             | (152)        |        | -    |        |
|  | (GROSS)                                  | kg(lb)   | 26  | (57)        |                                     | 77             | (170)        |        | -    |        |
|  | Panel (NET)                              | kg(lb)   | 5   | (11)        |                                     | -              |              | -      |      |        |
| Layers limit (actually)                                  |  | 11 (12)  |   |             | 2 (3)                               |                |              | -      |      |        |
| Operation condition                                      | Cool (DBT)                               | 18°C ~ 32°C  |   |             | -15°C ~ 46°C                        |                |              | -      |      |        |
|  | Heat (DBT)                               | 16°C ~ 30°C  |   |             | -20°C ~ 24°C                        |                |              | -      |      |        |
| P<br>I<br>P<br>I<br>N<br>G                               | Pipe diameter mm (inch)                  | (Liquid)∅6.35(1/4) (Gas)∅12.7(1/2)                       |   |             | (Liquid)∅9.52(3/8) (Gas)∅15.88(5/8) |                |              | -      |      |        |
|  | Connecting method, Standard length m(ft) | flared type, 5.0(16.4)                                   |   |             | flared type, 5.0(16.4)              |                |              | -      |      |        |
| Pipe length range m (ft)                                 |  | 5 ~ 50m (16.4 ~164)                                      |   |             |                                     |                |              |        |      |        |
| Indoor unit & Outdoor unit height difference m (ft)      |  | 15m(OD located lower)/30m(OD located higher) (49.2/98.4) |   |             |                                     |                |              |        |      |        |
| Add gas amount g/m (oz/ft)                               |  | 50g (0.538)  |   |             |                                     |                |              |        |      |        |
| Pipe length for additional gas m (ft)                    |  | 30m (98.4)   |   |             |                                     |                |              |        |      |        |

\*1 In case it is necessary to indicate the air flow volume in (l/s), the value in (m³/min.) shall be multiplied by 16.7 and rounded down the decimal point.  
 \*2 If the EUROVENT Certified models can be operated under the "extra-low" temperature condition, -7°C dry bulb and -8°C wet-bulb temperatures with rated voltage 230V shall be used.  
 \*3 Network Impedance shall be applicable for EUROPE and CHINA models.  
 \*4 The annual consumption is calculated by multiplying the input power at 230V(400V) by an average of 500 hours per year in cooling mode.  
 \*5 EER and COP classification is at 230V(400V) only in accordance with EU directive 2002/31/EC.  
 \*6 SEER and SCOP classification is at 230V(400V) only in accordance with EN-14825. For heating, SCOP indicates the value of only Average heating season, Other fiche data indicates in an attached sheet.  
 \*7 H: High at setting 5 stage (Level 5), M: Middle at setting 5 stage (Level 3), L: Low at setting 5 stage (Level 1)

# Simultaneous (Triple) -Type

## 1-1. Unit Specifications

**PE1**

### 1. 4-Way Cassette Type S-36PU2E5A×3 / U-100PE1E5A

| INDOOR                               |   | MODEL                                     | S-36PU2E5A×3   |             |                           | -                                   |              |              | -      |       |        |
|--------------------------------------|---|---|--|-------------|---------------------------|-------------------------------------|--------------|--------------|--------|-------|--------|
| PANEL                                |   | MODEL                                     | Standard type:CZ-KPU3×3 / ECONAVI type:CZ-KPU3A×3        |             |                           | -                                   |              |              | -      |       |        |
| OUTDOOR                              |   | MODEL                                     | -  |             |                           | U-100PE1E5A                         |              |              | -      |       |        |
| Branch pipe                          |   | MODEL                                     | -  |             |                           | CZ-P3HPC2                           |              |              | -      |       |        |
| Performance test condition           |   | ISO5151 / EN14511 / EN12102 / EN14825     |  |             |                           |                                     |              |              |        |       |        |
| C<br>O<br>O<br>L<br>I<br>N<br>G      | Power supply  |   | 1Ø 50Hz  |             |                           | 1Ø 50Hz                             |              |              |        |       |        |
|                                      |   |   | Ø, Hz  |             |                           |                                     |              |              |        |       |        |
|                                      |   |   | V  | 220V        | 230V                      | 240V                                | 220V         | 230V         | 240V   | Min   | Max    |
|                                      | Capacity  |   | kW   | 10.0        | 10.0                      | 10.0                                | -            | -            | -      | 3.3   | 12.5   |
|                                      |   |   | BTU/h  | 34100       | 34100                     | 34100                               | -            | -            | -      | 11300 | 42700  |
|                                      | Current   |   | A  | 0.23×3      | 0.23×3                    | 0.22×3                              | 10.6         | 10.3         | 9.8    | -     | -      |
|                                      | Input power   |   | W  | 24×3        | 24×3                      | 24×3                                | 2.268k       | 2.268k       | 2.268k | -     | -      |
|                                      |   |   | TOTAL W  |             |                           |                                     | 2.340k       | 2.340k       | 2.340k | 770   | 3.700k |
|                                      | Annual consumption                                  |   | TOTAL kWh *4   |             |                           |                                     | -            | 1170         | -      | -     | -      |
|                                      | EER/EER CLASS                                       |   | TOTAL (W/W) <sup>7</sup> ("A"-G)                         |             |                           |                                     | 4.27         | 4.27/A       | 4.27   | 4.29  | 3.38   |
|                                      | Erp *6  |   | Pdesign kW   |             |                           |                                     | -            | 10.0         | -      | -     | -      |
|                                      |   |   | SEER (W/W)   |             |                           |                                     | -            | 7.3          | -      | -     | -      |
|                                      |   |   | Annual consumption kWh                                   |             |                           |                                     | -            | 479          | -      | -     | -      |
|                                      |   |   | Class  |             |                           |                                     | -            | A++          | -      | -     | -      |
| Power factor                         |   | %   |  |             |                           | 97                                  | 96           | 96           | -      | -     |        |
| Noise indoor                         |   | dB-A (H/M/L) *7                           | 30/28/27   |             |                           |                                     |              |              | -      | -     |        |
|                                      |   | Power Level dB                            | 45/43/42   |             |                           |                                     |              |              | -      | -     |        |
| Noise outdoor                        |   | dB-A (H/L)                                |  |             |                           | 52/-                                |              |              | -      | -     |        |
|                                      |   | Power Level dB                            |  |             |                           | 69/-                                |              |              | -      | -     |        |
| H<br>E<br>A<br>T<br>I<br>N<br>G      | Capacity  |   | kW   | 11.2        | 11.2                      | 11.2                                | -            | -            | -      | 4.1   | 14.0   |
|                                      |   |   | BTU/h  | 38200       | 38200                     | 38200                               | -            | -            | -      | 14000 | 47800  |
|                                      | Current   |   | A  | 0.22×3      | 0.22×3                    | 0.21×3                              | 10.2         | 9.8          | 9.5    | -     | -      |
|                                      | Input power   |   | W  | 22×3        | 22×3                      | 22×3                                | 2.174k       | 2.174k       | 2.174k | -     | -      |
|                                      |   |   | TOTAL W  |             |                           |                                     | 2.240k       | 2.240k       | 2.240k | 790   | 4.400k |
|                                      | COP/COP CLASS                                       |   | TOTAL (W/W) <sup>7</sup> ("A"-G)                         |             |                           |                                     | 5.00         | 5.00/A       | 5.00   | 5.19  | 3.18   |
|                                      | Erp *6  |   | Pdesign at -10°C kW                                      |             |                           |                                     | -            | 10.0         | -      | -     | -      |
|                                      |   |   | Tbivalent °C   |             |                           |                                     | -            | -10          | -      | -     | -      |
|                                      |   |   | SCOP (W/W)   |             |                           |                                     | -            | 4.8          | -      | -     | -      |
|                                      |   |   | Annual consumption kWh                                   |             |                           |                                     | -            | 2917         | -      | -     | -      |
|                                      |   |   | Class  |             |                           |                                     | -            | A++          | -      | -     | -      |
|                                      | Power factor  |   | %  |             |                           |                                     | 97           | 96           | 95     | -     | -      |
|                                      | Noise indoor  |   | dB-A (H/M/L) *7  | 30/28/27    |                           |                                     |              |              |        | -     | -      |
|                                      |   |   | Power Level dB   | 45/43/42    |                           |                                     |              |              |        | -     | -      |
| Noise outdoor                        |   | dB-A (H/L)                                |  |             |                           | 52/-                                |              |              | -      | -     |        |
|                                      |   | Power Level dB                            |  |             |                           | 69/-                                |              |              | -      | -     |        |
| EXTRA LOW TEMP                       |   | Total capacity(kW) / Input power(W) / COP |  |             |                           |                                     |              |              |        |       |        |
| Max Current(A) / Max Input power(W)  |   |   | 0.23×3/24×3  | 0.23×3/24×3 | 0.22×3/24×3               | 25.0 / 5.35k                        | 25.0 / 5.55k | 25.0 / 5.75k |        |       |        |
| Starting current(A) / Comp output(W) |   |   | -  | -           | -                         | 10.6 / 3.0k                         | 10.3 / 3.0k  | 9.8 / 3.0k   |        |       |        |
| Network Impedance(ΩMAX.)             |   |   |  |             |                           |                                     |              |              |        |       |        |
| Fan motor output (Indoor/Outdoor) W  |   |   | 60   |             |                           | 90×2                                |              |              |        |       |        |
| Moisture removal volume              |   | L/h(P/h)                                  | 2.1  | (0.7×3)     | (4.4)                     |                                     |              |              |        |       |        |
| External static pressure             |   | Pa  |  |             |                           |                                     |              |              |        |       |        |
| Indoor Air flow *7                   | Cooling   | m³/min (ft³/min)                          | 14.5×3/13.0×3/11.5×3 (512)×3/(459)×3/(406)×3             |             |                           |                                     |              |              | -      | -     |        |
|                                      | Heating   | m³/min (ft³/min)                          | 14.5×3/13.0×3/11.5×3 (512)×3/(459)×3/(406)×3             |             |                           |                                     |              |              | -      | -     |        |
| Outdoor Air flow                     | Cooling   | m³/min (ft³/min)                          |  |             |                           | 110 (3885)                          |              |              | -      | -     |        |
|                                      | Heating   | m³/min (ft³/min)                          |  |             |                           | 95 (3355)                           |              |              | -      | -     |        |
| Refrigerant type / amount g(oz)      |   |   |  |             |                           | R410A 3.40k (119.9)                 |              |              |        |       |        |
| Product dimension                    | Height  | mm(inch)                                  | 256  | (10-5/64)   |                           | 1416 (55-3/4)                       |              |              |        |       |        |
|                                      | Width   | mm(inch)                                  | 840  | (33-5/64)   |                           | 940 (37-1/32)                       |              |              |        |       |        |
|                                      | Depth   | mm(inch)                                  | 840  | (33-5/64)   |                           | 340 (13-13/32)                      |              |              |        |       |        |
| Product dimension (Panel)            |   | H×W×D mm, inch                            | 33.5×950×950   |             | 1-11/32×37-13/32×37-13/32 |                                     |              |              |        |       |        |
| Packing dimension                    | Height  | mm(inch)                                  | 302  | (11-57/64)  |                           | 1556                                |              |              |        |       |        |
|                                      | Width   | mm(inch)                                  | 898  | (35-3/8)    |                           | 1055                                |              |              |        |       |        |
|                                      | Depth   | mm(inch)                                  | 898  | (35-3/8)    |                           | 485                                 |              |              |        |       |        |
| Weight                               | (NET)   | kg(lb)                                    | 19   | (42)        |                           | 98                                  | (216)        |              |        |       |        |
|                                      | (GROSS)   | kg(lb)                                    | 26   | (57)        |                           | 108                                 | (238)        |              |        |       |        |
|                                      | Panel (NET)   | kg(lb)                                    | 5  | (11)        |                           |                                     |              |              |        |       |        |
| Layers limit (actually)              |   |   | 11 (12)  |             |                           | 1 (2)                               |              |              |        |       |        |
| Operation condition                  |   | Cool (DBT)                                | 18°C ~ 32°C  |             |                           | -15°C ~ 46°C                        |              |              |        |       |        |
|                                      |   | Heat (DBT)                                | 16°C ~ 30°C  |             |                           | -20°C ~ 24°C                        |              |              |        |       |        |
| P                                    | Pipe diameter mm (inch)                             |   | (Liquid)Ø6.35(1/4) (Gas)Ø12.7(1/2)                       |             |                           | (Liquid)Ø9.52(3/8) (Gas)Ø15.88(5/8) |              |              |        |       |        |
| I                                    | Connecting method, Standard length m(ft)            |   | flared type, 5.0(16.4)                                   |             |                           | flared type, 5.0(16.4)              |              |              |        |       |        |
| P                                    | Pipe length range m (ft)                            |   | 5 ~ 75m (16.4 ~ 246.1)                                   |             |                           |                                     |              |              |        |       |        |
| I                                    | Indoor unit & Outdoor unit height difference m (ft) |   | 15m(OD located lower)/30m(OD located higher) (49.2/98.4) |             |                           |                                     |              |              |        |       |        |
| N                                    | Add gas amount g/m (oz/ft)                          |   | 50g (0.538)  |             |                           |                                     |              |              |        |       |        |
| G                                    | Pipe length for additional gas m (ft)               |   | 30m (98.4)   |             |                           |                                     |              |              |        |       |        |

\*1 In case it is necessary to indicate the air flow volume in (l/s), the value in (m³/min.) shall be multiplied by 16.7 and rounded down the decimal point.

\*2 If the EUROVENT Certified models can be operated under the "extra-low" temperature condition, -7°C dry bulb and -8°C wet-bulb temperatures with rated voltage 230V shall be used.

\*3 Network Impedance shall be applicable for EUROPE and CHINA models.

\*4 The annual consumption is calculated by multiplying the input power at 230V(400V) by an average of 500 hours per year in cooling mode.

\*5 EER and COP classification is at 230V(400V) only in accordance with EU directive 2002/31/EC.

\*6 SEER and SCOP classification is at 230V(400V) only in accordance with EN-14825. For heating, SCOP indicates the value of only Average heating season, Other fiche data indicates in an attached sheet.

\*7 H: High at setting 5 stage (Level 5), M: Middle at setting 5 stage (Level 3), L: Low at setting 5 stage (Level 1)

# Simultaneous (Double-Twin) -Type

## 1-1. Unit Specifications

PE1

### 1. 4-Way Cassette Type S-36PU2E5A×4 / U-125PE1E5A

| INDOOR                                       |  | MODEL                                     | S-36PU2E5A×4                                      |  |                                     | -              |              |        | -      |       |        |
|--|--|---|---|--|-------------------------------------|----------------|--------------|--------|--------|-------|--------|
| PANEL  |  | MODEL                                     | Standard type:CZ-KPU3×4 / ECONAVI type:CZ-KPU3A×4 |  |                                     | -              |              |        | -      |       |        |
| OUTDOOR                                      |  | MODEL                                     | -   |  |                                     | U-125PE1E5A    |              |        | -      |       |        |
| Branch pipe                                  |  | MODEL                                     | -   |  |                                     | CZ-P155BK1×3   |              |        | -      |       |        |
| Performance test condition                   |  | ISO5151 / EN14511 / EN12102 / EN14825     |   |  |                                     |                |              |        |        |       |        |
| C<br>O<br>L<br>L<br>I<br>N<br>G              | Power supply                             |   | 1Ø 50Hz   |  |                                     | 1Ø 50Hz        |              |        |        |       |        |
|  |  |   | Ø, Hz   |  |                                     |                |              |        |        |       |        |
|  |  |   | V   | 220V   | 230V                                | 240V           | 220V         | 230V   | 240V   | Min   | Max    |
|  | Capacity                                 |   | kW  | 12.5   | 12.5                                | 12.5           | -            | -      | -      | 3.3   | 14.0   |
|  |  |   | BTU/h   | 42700  | 42700                               | 42700          | -            | -      | -      | 11300 | 47800  |
|  | Current                                  |   | A   | 0.23×4   | 0.23×4                              | 0.22×4         | 15.3         | 14.8   | 14.3   | -     | -      |
|  | Input power                              |   | W   | 24×4   | 24×4                                | 24×4           | 3.274k       | 3.274k | 3.274k | -     | -      |
|  |  |   | TOTAL W   |  |                                     |                | 3.370k       | 3.370k | 3.370k | 770   | 4.600k |
|  | Annual consumption                       |   | TOTAL kWh *4                                      |  |                                     |                | -            | 1685   | -      | -     | -      |
|  | EER/EER CLASS                            |   | TOTAL (W/W) <sup>1/3</sup> ("A"-G)                |  |                                     |                | 3.70         | 3.70/A | 3.70   | 4.29  | 3.04   |
|  | Erp *6                                   |   | Pdesign   |  |                                     |                | -            | 12.5   | -      | -     | -      |
|  |  |   | η <sub>s.c</sub>                                  |  |                                     |                | -            | 277.5  | -      | -     | -      |
|  |  |   | Annual consumption                                |  |                                     |                | -            | -      | -      | -     | -      |
|  |  |   | Class   |  |                                     |                | -            | -      | -      | -     | -      |
| Power factor                                 |  | %   |   |  |                                     | 97             | 96           | 95     | -      | -     |        |
| Noise indoor                                 |  | dB-A (H/M/L) *7                           | 30/28/27  |  |                                     |                |              |        | -      | -     |        |
|  |  | Power Level dB                            | 45/43/42  |  |                                     |                |              |        | -      | -     |        |
| Noise outdoor                                |  | dB-A (H/L)                                |   |  |                                     | 53/-           |              |        | -      | -     |        |
|  |  | Power Level dB                            |   |  |                                     | 70/-           |              |        | -      | -     |        |
| H<br>E<br>A<br>T<br>I<br>N<br>G              | Capacity                                 |   | kW  | 14.0   | 14.0                                | 14.0           | -            | -      | -      | 4.1   | 16.0   |
|  |  |   | BTU/h   | 47800  | 47800                               | 47800          | -            | -      | -      | 14000 | 54600  |
|  | Current                                  |   | A   | 0.22×4   | 0.22×4                              | 0.21×4         | 13.8         | 13.4   | 12.9   | -     | -      |
|  | Input power                              |   | W   | 22×4   | 22×4                                | 22×4           | 2.952k       | 2.952k | 2.952k | -     | -      |
|  |  |   | TOTAL W   |  |                                     |                | 3.040k       | 3.040k | 3.040k | 790   | 5.040k |
|  | COP/COP CLASS                            |   | TOTAL (W/W) <sup>1/3</sup> ("A"-G)                |  |                                     |                | 4.60         | 4.60/A | 4.60   | 5.19  | 3.17   |
|  | Erp *6                                   |   | Pdesign at -10°C                                  |  |                                     |                | -            | 12.5   | -      | -     | -      |
|  |  |   | Tbivalent   |  |                                     |                | -            | -10    | -      | -     | -      |
|  |  |   | η <sub>s.h</sub>                                  |  |                                     |                | -            | 161.0  | -      | -     | -      |
|  |  |   | Annual consumption                                |  |                                     |                | -            | -      | -      | -     | -      |
|  |  |   | Class   |  |                                     |                | -            | -      | -      | -     | -      |
|  | Power factor                             |   | %   |  |                                     |                | 97           | 96     | 95     | -     | -      |
|  | Noise indoor                             |   | dB-A (H/M/L) *7                                   | 30/28/27   |                                     |                |              |        |        | -     | -      |
|  |  |   | Power Level dB                                    | 45/43/42   |                                     |                |              |        |        | -     | -      |
| Noise outdoor                                |  | dB-A (H/L)                                |   |  |                                     | 53/-           |              |        | -      | -     |        |
|  |  | Power Level dB                            |   |  |                                     | 70/-           |              |        | -      | -     |        |
| EXTRA LOW TEMP                               |  | Total capacity(kW) / Input power(W) / COP |   |  |                                     |                |              |        |        |       |        |
| Max Current(A) / Max Input power(W)          |  | 0.23×4/24×4                               | 0.23×4/24×4                                       | 0.22×4/24×4  | 28.0 / 6.00k                        | 28.0 / 6.20k   | 28.0 / 6.40k |        |        |       |        |
| Starting current(A) / Comp output(W)         |  | -   | -   | -  | 15.3 / 3.0k                         | 14.8 / 3.0k    | 14.3 / 3.0k  |        |        |       |        |
| Network Impedance(ΩMAX.)                     |  |   |   |  |                                     |                |              |        |        |       |        |
| Fan motor output (Indoor/Outdoor) W          |  | 60  |   |  | 90×2                                |                |              |        |        |       |        |
| Moisture removal volume                      |  | L/h(Pt/h)                                 | 2.8   | (0.7×4)  | (5.9)                               |                |              |        |        |       |        |
| External static pressure                     |  | Pa  |   |  |                                     |                |              |        |        |       |        |
| Indoor Air flow *7                           | Cooling                                  | m³/min (ft³/min)                          | 14.5×4/13.0×4/11.5×4 (512)×4/(459)×4/(406)×4      |  |                                     |                |              |        |        |       |        |
|  | Heating                                  | m³/min (ft³/min)                          | 14.5×4/13.0×4/11.5×4 (512)×4/(459)×4/(406)×4      |  |                                     |                |              |        |        |       |        |
| Outdoor Air flow                             | Cooling                                  | m³/min (ft³/min)                          |   |  |                                     | 130 (4591)     |              |        |        |       |        |
|  | Heating                                  | m³/min (ft³/min)                          |   |  |                                     | 110 (3885)     |              |        |        |       |        |
| Refrigerant type / amount g(oz)              |  |   |   |  | R410A 3.40k (119.9)                 |                |              |        |        |       |        |
| Product dimension                            | Height                                   | mm(inch)                                  | 256   | (10-5/64)  |                                     | 1416 (55-3/4)  |              |        |        |       |        |
|  | Width                                    | mm(inch)                                  | 840   | (33-5/64)  |                                     | 940 (37-1/32)  |              |        |        |       |        |
|  | Depth                                    | mm(inch)                                  | 840   | (33-5/64)  |                                     | 340 (13-13/32) |              |        |        |       |        |
| Product dimension (Panel)                    |  | H×W×D mm, inch                            | 33.5×950×950                                      |  | 1-11/32×37-13/32×37-13/32           |                |              |        |        |       |        |
| Packing dimension                            | Height                                   | mm(inch)                                  | 302   | (11-57/64)   |                                     | 1556           |              |        |        |       |        |
|  | Width                                    | mm(inch)                                  | 898   | (35-3/8)   |                                     | 1055           |              |        |        |       |        |
|  | Depth                                    | mm(inch)                                  | 898   | (35-3/8)   |                                     | 485            |              |        |        |       |        |
| Weight                                       | (NET)                                    | kg(lb)                                    | 19  | (42)   |                                     | 98             | (216)        |        |        |       |        |
|  | (GROSS)                                  | kg(lb)                                    | 26  | (57)   |                                     | 108            | (238)        |        |        |       |        |
|  | Panel (NET)                              | kg(lb)                                    | 5   | (11)   |                                     |                |              |        |        |       |        |
| Layers limit (actually)                      |  | 11 (12)                                   |   |  | 1 (2)                               |                |              |        |        |       |        |
| Operation condition                          | Cool (DBT)                               | 18°C ~ 32°C                               |   |  | -15°C ~ 46°C                        |                |              |        |        |       |        |
|  | Heat (DBT)                               | 16°C ~ 30°C                               |   |  | -20°C ~ 24°C                        |                |              |        |        |       |        |
| P<br>I<br>P<br>I<br>N<br>G                   | Pipe diameter mm (inch)                  | (Liquid)Ø6.35(1/4) (Gas)Ø12.7(1/2)        |   |  | (Liquid)Ø9.52(3/8) (Gas)Ø15.88(5/8) |                |              |        |        |       |        |
|  | Connecting method, Standard length m(ft) | flared type, 5.0(16.4)                    |   |  | flared type, 5.0(16.4)              |                |              |        |        |       |        |
| Pipe length range                            |  | m (ft)                                    |   | 5 ~ 75m (16.4 ~ 246.1)                                   |                                     |                |              |        |        |       |        |
| Indoor unit & Outdoor unit height difference |  | m (ft)                                    |   | 15m(OD located lower)/30m(OD located higher) (49.2/98.4) |                                     |                |              |        |        |       |        |
| Add gas amount                               |  | g/m (oz/ft)                               |   | 50g (0.538)  |                                     |                |              |        |        |       |        |
| Pipe length for additional gas               |  | m (ft)                                    |   | 30m (98.4)   |                                     |                |              |        |        |       |        |

\*1 In case it is necessary to indicate the air flow volume in (l/s), the value in (m³/min.) shall be multiplied by 16.7 and rounded down the decimal point.  
 \*2 If the EUROVENT Certified models can be operated under the "extra-low" temperature condition, -7°C dry bulb and -8°C wet-bulb temperatures with rated voltage 230V shall be used.  
 \*3 Network Impedance shall be applicable for EUROPE and CHINA models.  
 \*4 The annual consumption is calculated by multiplying the input power at 230V(400V) by an average of 500 hours per year in cooling mode.  
 \*5 EER and COP classification is at 230V(400V) only in accordance with EU directive 2002/31/EC.  
 \*6 SEER and SCOP classification is at 230V(400V) only in accordance with EN-14825. For heating, SCOP indicates the value of only Average heating season.  
 \*7 H: High at setting 5 stage (Level 5), M: Middle at setting 5 stage (Level 3), L: Low at setting 5 stage (Level 1)

# Simultaneous (Triple) -Type

## 1-1. Unit Specifications

**PE1**

### 1. 4-Way Cassette Type S-45PU2E5A×3 / U-125PE1E5A

| INDOOR                                       |  | MODEL                                      | S-45PU2E5A×3   |             |                           | -                                   |              |              | -      |       |        |
|--|--|--|--|-------------|---------------------------|-------------------------------------|--------------|--------------|--------|-------|--------|
| PANEL  |  | MODEL                                      | Standard type:CZ-KPU3×3 / ECONAVI type:CZ-KPU3A×3        |             |                           | -                                   |              |              | -      |       |        |
| OUTDOOR                                      |  | MODEL                                      | -  |             |                           | U-125PE1E5A                         |              |              | -      |       |        |
| Branch pipe                                  |  | MODEL                                      | -  |             |                           | CZ-P3HPC2                           |              |              | -      |       |        |
| Performance test condition                   |  | ISO5151 / EN14511 / EN12102 / EN14825      |  |             |                           |                                     |              |              |        |       |        |
| C<br>O<br>O<br>L<br>I<br>N<br>G              | Power supply                             |  | 1Ø 50Hz  |             |                           | 1Ø 50Hz                             |              |              |        |       |        |
|  |  |  | Ø, Hz  |             |                           |                                     |              |              |        |       |        |
|  |  |  | V  | 220V        | 230V                      | 240V                                | 220V         | 230V         | 240V   | Min   | Max    |
|  | Capacity                                 |  | kW   | 12.5        | 12.5                      | 12.5                                | -            | -            | -      | 3.3   | 14.0   |
|  |  |  | BTU/h  | 42700       | 42700                     | 42700                               | -            | -            | -      | 11300 | 47800  |
|  | Current                                  |  | A  | 0.25×3      | 0.25×3                    | 0.24×3                              | 15.4         | 14.9         | 14.4   | -     | -      |
|  | Input power                              |  | W  | 26×3        | 26×3                      | 26×3                                | 3.292k       | 3.292k       | 3.292k | -     | -      |
|  |  |  | TOTAL W  |             |                           |                                     | 3.370k       | 3.370k       | 3.370k | 770   | 4.600k |
|  | Annual consumption                       |  | TOTAL kWh *4   |             |                           |                                     | -            | 1685         | -      | -     | -      |
|  | EER/EER CLASS                            |  | TOTAL (W/W) <sup>5/7</sup> ("A"-G)                       |             |                           |                                     | 3.70         | 3.70/A       | 3.70   | 4.29  | 3.04   |
|  | Erp *6                                   |  | Pdesign  |             |                           |                                     | -            | 12.5         | -      | -     | -      |
|  |  |  | η <sub>s.c</sub>   |             |                           |                                     | -            | 277.5        | -      | -     | -      |
|  |  |  | Annual consumption                                       |             |                           |                                     | -            | -            | -      | -     | -      |
|  |  |  | Class  |             |                           |                                     | -            | -            | -      | -     | -      |
| Power factor                                 |  | %  |  |             |                           | 97                                  | 96           | 95           | -      | -     |        |
| Noise indoor                                 |  | dB-A (H/M/L) *7                            | 31/28/27   |             |                           |                                     |              |              | -      | -     |        |
|  |  | Power Level dB                             | 46/43/42   |             |                           |                                     |              |              | -      | -     |        |
| Noise outdoor                                |  | dB-A (H/L)                                 |  |             |                           | 53/-                                |              |              | -      | -     |        |
|  |  | Power Level dB                             |  |             |                           | 70/-                                |              |              | -      | -     |        |
| H<br>E<br>A<br>T<br>I<br>N<br>G              | Capacity                                 |  | kW   | 14.0        | 14.0                      | 14.0                                | -            | -            | -      | 4.1   | 16.0   |
|  |  |  | BTU/h  | 47800       | 47800                     | 47800                               | -            | -            | -      | 14000 | 54600  |
|  | Current                                  |  | A  | 0.24×3      | 0.24×3                    | 0.23×3                              | 13.9         | 13.4         | 13.0   | -     | -      |
|  | Input power                              |  | W  | 24×3        | 24×3                      | 24×3                                | 2.968k       | 2.968k       | 2.968k | -     | -      |
|  |  |  | TOTAL W  |             |                           |                                     | 3.040k       | 3.040k       | 3.040k | 790   | 5.040k |
|  | COP/COP CLASS                            |  | TOTAL (W/W) <sup>5/7</sup> ("A"-G)                       |             |                           |                                     | 4.60         | 4.60/A       | 4.60   | 5.19  | 3.17   |
|  | Erp *6                                   |  | Pdesign at -10°C   |             |                           |                                     | -            | 12.5         | -      | -     | -      |
|  |  |  | Tbivalent  |             |                           |                                     | -            | -10          | -      | -     | -      |
|  |  |  | η <sub>s.h</sub>   |             |                           |                                     | -            | 161.0        | -      | -     | -      |
|  |  |  | Annual consumption                                       |             |                           |                                     | -            | -            | -      | -     | -      |
|  |  |  | Class  |             |                           |                                     | -            | -            | -      | -     | -      |
|  | Power factor                             |  | %  |             |                           |                                     | 97           | 96           | 95     | -     | -      |
|  | Noise indoor                             |  | dB-A (H/M/L) *7  | 31/28/27    |                           |                                     |              |              |        | -     | -      |
|  |  |  | Power Level dB   | 46/43/42    |                           |                                     |              |              |        | -     | -      |
| Noise outdoor                                |  | dB-A (H/L)                                 |  |             |                           | 53/-                                |              |              | -      | -     |        |
|  |  | Power Level dB                             |  |             |                           | 70/-                                |              |              | -      | -     |        |
| EXTRA LOW TEMP                               |  | Total capacity(kW) / Input power(W) / COP  |  |             |                           |                                     |              |              |        |       |        |
| Max Current(A) / Max Input power(W)          |  |  | 0.25×3/26×3  | 0.25×3/26×3 | 0.24×3/26×3               | 28.0 / 6.00k                        | 28.0 / 6.20k | 28.0 / 6.40k |        |       |        |
| Starting current(A) / Comp output(W)         |  |  | -  | -           | -                         | 15.4 / 3.0k                         | 14.9 / 3.0k  | 14.4 / 3.0k  |        |       |        |
| Network Impedance(ΩMAX.)                     |  |  |  |             |                           |                                     |              |              |        |       |        |
| Fan motor output (Indoor/Outdoor) W          |  |  | 60   |             |                           | 90×2                                |              |              |        |       |        |
| Moisture removal volume                      |  | L/h(Pt/h)                                  | 3.9  | (1.3×3)     | (8.2)                     |                                     |              |              |        |       |        |
| External static pressure                     |  | Pa   |  |             |                           |                                     |              |              |        |       |        |
| Indoor Air flow *7                           | Cooling                                  | m <sup>3</sup> /min (ft <sup>3</sup> /min) | 15.5×3/13.0×3/11.5×3 (547)×3/(459)×3/(406)×3             |             |                           |                                     |              |              |        |       |        |
|  | Heating                                  | m <sup>3</sup> /min (ft <sup>3</sup> /min) | 15.5×3/13.0×3/11.5×3 (547)×3/(459)×3/(406)×3             |             |                           |                                     |              |              |        |       |        |
| Outdoor Air flow                             | Cooling                                  | m <sup>3</sup> /min (ft <sup>3</sup> /min) |  |             |                           | 130 (4591)                          |              |              |        |       |        |
|  | Heating                                  | m <sup>3</sup> /min (ft <sup>3</sup> /min) |  |             |                           | 110 (3885)                          |              |              |        |       |        |
| Refrigerant type / amount g(oz)              |  |  |  |             |                           | R410A 3.40k (119.9)                 |              |              |        |       |        |
| Product dimension                            | Height                                   | mm(inch)                                   | 256  | (10-5/64)   |                           | 1416 (55-3/4)                       |              |              |        |       |        |
|  | Width                                    | mm(inch)                                   | 840  | (33-5/64)   |                           | 940 (37-1/32)                       |              |              |        |       |        |
|  | Depth                                    | mm(inch)                                   | 840  | (33-5/64)   |                           | 340 (13-13/32)                      |              |              |        |       |        |
| Product dimension (Panel)                    |  | H×W×D mm, inch                             | 33.5×950×950   |             | 1-11/32×37-13/32×37-13/32 |                                     |              |              |        |       |        |
| Packing dimension                            | Height                                   | mm(inch)                                   | 302  | (11-57/64)  |                           | 1556                                |              |              |        |       |        |
|  | Width                                    | mm(inch)                                   | 898  | (35-3/8)    |                           | 1055                                |              |              |        |       |        |
|  | Depth                                    | mm(inch)                                   | 898  | (35-3/8)    |                           | 485                                 |              |              |        |       |        |
| Weight                                       | (NET)                                    | kg(lb)                                     | 19   | (42)        |                           | 98                                  | (216)        |              |        |       |        |
|  | (GROSS)                                  | kg(lb)                                     | 26   | (57)        |                           | 108                                 | (238)        |              |        |       |        |
|  | Panel (NET)                              | kg(lb)                                     | 5  | (11)        |                           |                                     |              |              |        |       |        |
| Layers limit (actually)                      |  |  | 11 (12)  |             |                           | 1 (2)                               |              |              |        |       |        |
| Operation condition                          | Cool (DBT)                               |  | 18°C ~ 32°C  |             |                           | -15°C ~ 46°C                        |              |              |        |       |        |
|  | Heat (DBT)                               |  | 16°C ~ 30°C  |             |                           | -20°C ~ 24°C                        |              |              |        |       |        |
| P<br>I<br>P<br>I<br>N<br>G                   | Pipe diameter mm (inch)                  |  | (Liquid)Ø6.35(1/4) (Gas)Ø12.7(1/2)                       |             |                           | (Liquid)Ø9.52(3/8) (Gas)Ø15.88(5/8) |              |              |        |       |        |
|  | Connecting method, Standard length m(ft) |  | flared type, 5.0(16.4)                                   |             |                           | flared type, 5.0(16.4)              |              |              |        |       |        |
| Pipe length range                            |  | m (ft)                                     | 5 ~ 75m (16.4 ~ 246.1)                                   |             |                           |                                     |              |              |        |       |        |
| Indoor unit & Outdoor unit height difference |  | m (ft)                                     | 15m(OD located lower)/30m(OD located higher) (49.2/98.4) |             |                           |                                     |              |              |        |       |        |
| Add gas amount                               |  | g/m (oz/ft)                                | 50g (0.538)  |             |                           |                                     |              |              |        |       |        |
| Pipe length for additional gas               |  | m (ft)                                     | 30m (98.4)   |             |                           |                                     |              |              |        |       |        |

\*1 In case it is necessary to indicate the air flow volume in (l/s), the value in (m<sup>3</sup>/min.) shall be multiplied by 16.7 and rounded down the decimal point.

\*2 If the EUROVENT Certified models can be operated under the "extra-low" temperature condition, -7°C dry bulb and -8°C wet-bulb temperatures with rated voltage 230V shall be used.

\*3 Network Impedance shall be applicable for EUROPE and CHINA models.

\*4 The annual consumption is calculated by multiplying the input power at 230V(400V) by an average of 500 hours per year in cooling mode.

\*5 EER and COP classification is at 230V(400V) only in accordance with EU directive 2002/31/EC.

\*6 SEER and SCOP classification is at 230V(400V) only in accordance with EN-14825. For heating, SCOP indicates the value of only Average heating season.

\*7 H: High at setting 5 stage (Level 5), M: Middle at setting 5 stage (Level 3), L: Low at setting 5 stage (Level 1)

# Single -Type

## 1-1. Unit Specifications

PE2

### 1. 4-Way Cassette Type S-50PU2E5A / U-50PE2E5A

| INDOOR   |   | MODEL              | S-50PU2E5A   |           |                               | -                                  |              |              | -      |      |        |   |
|--|---|--------------------|--|-----------|-------------------------------|------------------------------------|--------------|--------------|--------|------|--------|---|
| PANEL  |   | MODEL              | Standard type:CZ-KPU3 / ECONAVI type:CZ-KPU3A            |           |                               | -                                  |              |              | -      |      |        |   |
| OUTDOOR  |   | MODEL              | -  |           |                               | U-50PE2E5A                         |              |              | -      |      |        |   |
| Branch pipe  |   | MODEL              | -  |           |                               | -                                  |              |              | -      |      |        |   |
| Performance test condition                                 |   |                    | ISO5151 / EN14511 / EN12102 / EN14825                    |           |                               |                                    |              |              |        |      |        |   |
| C<br>O<br>O<br>L<br>I<br>N<br>G                            | Power supply  |                    | 1Ø 50Hz  |           |                               | 1Ø 50Hz                            |              |              |        |      |        |   |
|  |   |                    | Ø, Hz  |           |                               |                                    |              |              |        |      |        |   |
|  |   |                    | V  | 220V      | 230V                          | 240V                               | 220V         | 230V         | 240V   | Min  | Max    |   |
|  | Capacity  |                    | kW   | 5.0       | 5.0                           | 5.0                                | -            | -            | -      | 1.5  | 5.6    |   |
|  |   |                    | BTU/h  | 17100     | 17100                         | 17100                              | -            | -            | -      | 5100 | 19100  |   |
|  | Current   |                    | A  | 0.27      | 0.26                          | 0.25                               | 6.25         | 5.95         | 5.70   | -    | -      |   |
|  | Input power   |                    | W  | 29        | 29                            | 29                                 | 1.291k       | 1.291k       | 1.291k | -    | -      |   |
|  |   |                    | TOTAL W  | -         |                               |                                    | 1.320k       | 1.320k       | 1.320k | 240  | 1.620k |   |
|  | Annual consumption                                  |                    | TOTAL kWh *4   | -         |                               |                                    | 660          |              |        | -    | -      |   |
|  | EER/EER CLASS                                       |                    | TOTAL (W/W) *5 / ("A"-G)                                 | -         |                               |                                    | 3.79         | 3.79/A       | 3.79   | 6.25 | 3.46   |   |
|  | E<br>r<br>p<br>*6                                   | Pdesign            |  | kW        |                               |                                    | 5.0          |              |        | -    |        |   |
|  |   | SEER               |  | (W/W)     |                               |                                    | 7.1          |              |        | -    |        |   |
|  |   | Annual consumption |  | kWh       |                               |                                    | 246          |              |        | -    |        |   |
|  |   | Class              |  | -         |                               |                                    | A++          |              |        | -    |        |   |
|  | Power factor  |                    | %  |           | -                             |                                    |              | 94           | 94     | 94   | -      | - |
| Noise indoor   |   | dB-A (H/M/L) *7    |  | 32/29/27  |                               |                                    | -            |              |        | -    |        |   |
|  |   | Power Level dB     |  | 47/44/42  |                               |                                    | -            |              |        | -    |        |   |
| Noise outdoor  |   | dB-A (H/L)         |  | -         |                               |                                    | 46/-         |              |        | -    |        |   |
|  |   | Power Level dB     |  | -         |                               |                                    | 65/-         |              |        | -    |        |   |
| H<br>E<br>A<br>T<br>I<br>N<br>G                            | Capacity  |                    | kW   | 5.6       | 5.6                           | 5.6                                | -            | -            | -      | 1.5  | 6.5    |   |
|  |   |                    | BTU/h  | 19100     | 19100                         | 19100                              | -            | -            | -      | 5100 | 22200  |   |
|  | Current   |                    | A  | 0.26      | 0.25                          | 0.24                               | 6.05         | 5.75         | 5.50   | -    | -      |   |
|  | Input power   |                    | W  | 27        | 27                            | 27                                 | 1.233k       | 1.233k       | 1.233k | -    | -      |   |
|  |   |                    | TOTAL W  | -         |                               |                                    | 1.260k       | 1.260k       | 1.260k | 190  | 1.620k |   |
|  | COP/COP CLASS                                       |                    | TOTAL (W/W) *5 / ("A"-G)                                 | -         |                               |                                    | 4.44         | 4.44/A       | 4.44   | 7.89 | 4.01   |   |
|  | E<br>r<br>p<br>*6                                   | Pdesign at -10°C   |  | kW        |                               |                                    | 5.0          |              |        | -    |        |   |
|  |   | Tbivalent          |  | °C        |                               |                                    | -7           |              |        | -    |        |   |
|  |   | SCOP               |  | (W/W)     |                               |                                    | 4.4          |              |        | -    |        |   |
|  |   | Annual consumption |  | kWh       |                               |                                    | 1591         |              |        | -    |        |   |
|  | Class   |                    | -  |           |                               | A+                                 |              |              | -      |      |        |   |
|  | Power factor  |                    | %  |           | -                             |                                    |              | 93           | 93     | 93   | -      | - |
|  | Noise indoor  |                    | dB-A (H/M/L) *7  |           | 32/29/27                      |                                    |              | -            |        |      | -      |   |
|  |   |                    | Power Level dB   |           | 47/44/42                      |                                    |              | -            |        |      | -      |   |
|  | Noise outdoor                                       |                    | dB-A (H/L)   |           | -                             |                                    |              | 48/-         |        |      | -      |   |
| Power Level dB   |   |                    | -  |           |                               | 68/-                               |              |              | -      |      |        |   |
| EXTRA LOW TEMP   Total capacity(kW) / Input power(W) / COP |   |                    | -  |           |                               |                                    |              |              |        | -    |        |   |
| Max Current(A) / Max Input power(W)                        |   |                    | 0.27 / 29  | 0.26 / 29 | 0.25 / 29                     | 12.0 / 2.46k                       | 12.0 / 2.57k | 12.0 / 2.68k | -      |      |        |   |
| Starting current(A) / Comp output(W)                       |   |                    | -  | -         | -                             | 6.25 / 1.5k                        | 5.95 / 1.5k  | 5.70 / 1.5k  | -      |      |        |   |
| Network Impedance(ΩMAX.)                                   |   |                    | -  |           |                               |                                    |              |              |        | -    |        |   |
| Fan motor output (Indoor/Outdoor) W                        |   |                    | 60   |           |                               | 60                                 |              |              | -      |      |        |   |
| Moisture removal volume                                    |   | L/h(P/h)           | 1.6  | (3.4)     |                               | -                                  |              |              | -      |      |        |   |
| External static pressure                                   |   |                    | Pa   |           |                               | -                                  |              |              | -      |      |        |   |
| Indoor Air flow *7   | Cooling   | m³/min (ft³/min)   | 16.5 / 13.5 / 11.5 (583) / (477) / (406)                 |           |                               | -                                  |              |              | -      |      |        |   |
|  | Heating   | m³/min (ft³/min)   | 16.5 / 13.5 / 11.5 (583) / (477) / (406)                 |           |                               | -                                  |              |              | -      |      |        |   |
| Outdoor Air flow   | Cooling   | m³/min (ft³/min)   | -  |           |                               | 38 (1342)                          |              |              | -      |      |        |   |
|  | Heating   | m³/min (ft³/min)   | -  |           |                               | 41 (1448)                          |              |              | -      |      |        |   |
| Refrigerant type / amount g(oz)                            |   |                    | -  |           |                               | R410A 1.40k (49.4)                 |              |              | -      |      |        |   |
| Product dimension  |   | Height             | mm(inch)   | 256       | (10-5/64)                     | 619                                | (24-3/8)     | -            |        |      |        |   |
|  |   | Width              | mm(inch)   | 840       | (33-5/64)                     | 799                                | (31-29/64)   | -            |        |      |        |   |
|  |   | Depth              | mm(inch)   | 840       | (33-5/64)                     | 299                                | (11-49/64)   | -            |        |      |        |   |
| Product dimension (Panel)                                  |   | H×W×D mm, inch     | 33.5×950×950   |           | 1-11/32 × 37-13/32 × 37-13/32 |                                    | -            |              |        |      |        |   |
| Packing dimension  |   | Height             | mm(inch)   | 302       | (11-57/64)                    | 688                                |              |              | -      |      |        |   |
|  |   | Width              | mm(inch)   | 898       | (35-3/8)                      | 931                                |              |              | -      |      |        |   |
|  |   | Depth              | mm(inch)   | 898       | (35-3/8)                      | 422                                |              |              | -      |      |        |   |
| Weight   |   | (NET)              | kg(lb)   | 19        | (42)                          | 39                                 | (86)         | -            |        |      |        |   |
|  |   | (GROSS)            | kg(lb)   | 26        | (57)                          | 44                                 | (97)         | -            |        |      |        |   |
|  |   | Panel (NET)        | kg(lb)   | 5         | (11)                          | -                                  |              |              | -      |      |        |   |
| Layers limit (actually)                                    |   |                    | 11 (12)  |           |                               | 5 (6)                              |              |              | -      |      |        |   |
| Operation condition  |   | Cool (DBT)         | 18°C ~ 32°C  |           |                               | -15°C ~ 46°C                       |              |              | -      |      |        |   |
|  |   | Heat (DBT)         | 16°C ~ 30°C  |           |                               | -20°C ~ 24°C                       |              |              | -      |      |        |   |
| P  | Pipe diameter mm (inch)                             |                    | (Liquid)Ø6.35(1/4) (Gas)Ø12.7(1/2)                       |           |                               | (Liquid)Ø6.35(1/4) (Gas)Ø12.7(1/2) |              |              | -      |      |        |   |
| I  | Connecting method, Standard length m(ft)            |                    | flared type, 5.0(16.4)                                   |           |                               | flared type, 5.0(16.4)             |              |              | -      |      |        |   |
| P  | Pipe length range m (ft)                            |                    | 3 ~ 40m (9.8 ~ 131.2)                                    |           |                               | -                                  |              |              | -      |      |        |   |
| I  | Indoor unit & Outdoor unit height difference m (ft) |                    | 15m(OD located lower)/30m(OD located higher) (49.2/98.4) |           |                               | -                                  |              |              | -      |      |        |   |
| N  | Add gas amount g/m (oz/ft)                          |                    | 20g (0.215)  |           |                               | -                                  |              |              | -      |      |        |   |
| G  | Pipe length for additional gas m (ft)               |                    | 30m (98.4)   |           |                               | -                                  |              |              | -      |      |        |   |

\*1 In case it is necessary to indicate the air flow volume in (l/s), the value in (m³/min.) shall be multiplied by 16.7 and rounded down the decimal point.  
 \*2 If the EUROVENT Certified models can be operated under the "extra-low" temperature condition, -7°C dry bulb and -8°C wet-bulb temperatures with rated voltage 230V shall be used.  
 \*3 Network Impedance shall be applicable for EUROPE and CHINA models.  
 \*4 The annual consumption is calculated by multiplying the input power at 230V(400V) by an average of 500 hours per year in cooling mode.  
 \*5 EER and COP classification is at 230V(400V) only in accordance with EU directive 2002/31/EC.  
 \*6 SEER and SCOP classification is at 230V(400V) only in accordance with EN-14825. For heating, SCOP indicates the value of only Average heating season, Other fiche data indicates in an attached sheet.  
 \*7 H: High at setting 5 stage (Level 5), M: Middle at setting 5 stage (Level 3), L: Low at setting 5 stage (Level 1)

# Simultaneous (Twin) -Type

## 1-1. Unit Specifications

**PE1**

### 1. 4-Way Cassette Type S-50PU2E5A×2 / U-100PE1E5A

| INDOOR                               |   | MODEL  | S-50PU2E5A×2                                      |             |                                     | -              |              |        | -      |       |        |
|--------------------------------------|---|--|---|-------------|-------------------------------------|----------------|--------------|--------|--------|-------|--------|
| PANEL                                |   | MODEL  | Standard type:CZ-KPU3×2 / ECONAVI type:CZ-KPU3A×2 |             |                                     | -              |              |        | -      |       |        |
| OUTDOOR                              |   | MODEL  | -   |             |                                     | U-100PE1E5A    |              |        | -      |       |        |
| Branch pipe                          |   | MODEL  | CZ-P155BK1  |             |                                     |                |              |        |        | -     |        |
| Performance test condition           |   | ISO5151 / EN14511 / EN12102 / EN14825                    |   |             |                                     |                |              |        |        |       |        |
| C<br>O<br>O<br>L<br>I<br>N<br>G      | Power supply  |  | 1Ø 50Hz   |             |                                     | 1Ø 50Hz        |              |        |        |       |        |
|                                      |   |  | Ø, Hz   |             |                                     |                |              |        |        |       |        |
|                                      |   |  | V   | 220V        | 230V                                | 240V           | 220V         | 230V   | 240V   | Min   | Max    |
|                                      | Capacity  |  | kW  | 10.0        | 10.0                                | 10.0           | -            | -      | -      | 3.3   | 12.5   |
|                                      |   |  | BTU/h   | 34100       | 34100                               | 34100          | -            | -      | -      | 11300 | 42700  |
|                                      | Current   |  | A   | 0.27×2      | 0.26×2                              | 0.25×2         | 10.7         | 10.3   | 9.9    | -     | -      |
|                                      | Input power   |  | W   | 29×2        | 29×2                                | 29×2           | 2.282k       | 2.282k | 2.282k | -     | -      |
|                                      |   |  | TOTAL W   | -           | -                                   | -              | 2.340k       | 2.340k | 2.340k | 770   | 3.700k |
|                                      | Annual consumption                                  |  | TOTAL kWh *4                                      | -           | -                                   | -              | -            | 1170   | -      | -     | -      |
|                                      | EER/EER CLASS                                       |  | TOTAL (W/W) <sup>*5</sup> ("A"-G)                 | -           | -                                   | -              | 4.27         | 4.27/A | 4.27   | 4.29  | 3.38   |
|                                      | Erp <sup>*6</sup>                                   |  | Pdesign kW  | -           | -                                   | -              | -            | 10.0   | -      | -     | -      |
|                                      |   |  | SEER (W/W)  | -           | -                                   | -              | -            | 7.4    | -      | -     | -      |
|                                      |   |  | Annual consumption kWh                            | -           | -                                   | -              | -            | 473    | -      | -     | -      |
|                                      |   |  | Class   | -           | -                                   | -              | -            | A++    | -      | -     | -      |
| Power factor                         |   | %  | -   | -           | -                                   | 97             | 96           | 96     | -      | -     |        |
| Noise indoor                         |   | dB-A (H/M/L) <sup>*7</sup>                               | 32/29/27  |             |                                     | -              |              |        | -      | -     |        |
|                                      |   | Power Level dB   | 47/44/42  |             |                                     | -              |              |        | -      | -     |        |
| Noise outdoor                        |   | dB-A (H/L)   | -   |             |                                     | 52/-           |              |        | -      | -     |        |
|                                      |   | Power Level dB   | -   |             |                                     | 69/-           |              |        | -      | -     |        |
| H<br>E<br>A<br>T<br>I<br>N<br>G      | Capacity  |  | kW  | 11.2        | 11.2                                | 11.2           | -            | -      | -      | 4.1   | 14.0   |
|                                      |   |  | BTU/h   | 38200       | 38200                               | 38200          | -            | -      | -      | 14000 | 47800  |
|                                      | Current   |  | A   | 0.26×2      | 0.25×2                              | 0.24×2         | 10.2         | 9.9    | 9.6    | -     | -      |
|                                      | Input power   |  | W   | 27×2        | 27×2                                | 27×2           | 2.186k       | 2.186k | 2.186k | -     | -      |
|                                      |   |  | TOTAL W   | -           | -                                   | -              | 2.240k       | 2.240k | 2.240k | 790   | 4.400k |
|                                      | COP/COP CLASS                                       |  | TOTAL (W/W) <sup>*5</sup> ("A"-G)                 | -           | -                                   | -              | 5.00         | 5.00/A | 5.00   | 5.19  | 3.18   |
|                                      | Erp <sup>*6</sup>                                   |  | Pdesign at -10°C kW                               | -           | -                                   | -              | -            | 10.0   | -      | -     | -      |
|                                      |   |  | Tbivalent °C                                      | -           | -                                   | -              | -            | -10    | -      | -     | -      |
|                                      |   |  | SCOP (W/W)  | -           | -                                   | -              | -            | 4.8    | -      | -     | -      |
|                                      |   |  | Annual consumption kWh                            | -           | -                                   | -              | -            | 2917   | -      | -     | -      |
|                                      |   |  | Class   | -           | -                                   | -              | -            | A++    | -      | -     | -      |
|                                      | Power factor  |  | %   | -           | -                                   | -              | 97           | 96     | 95     | -     | -      |
|                                      | Noise indoor  |  | dB-A (H/M/L) <sup>*7</sup>                        | 32/29/27    |                                     |                | -            |        |        | -     | -      |
|                                      |   |  | Power Level dB                                    | 47/44/42    |                                     |                | -            |        |        | -     | -      |
| Noise outdoor                        |   | dB-A (H/L)   | -   |             |                                     | 52/-           |              |        | -      | -     |        |
|                                      |   | Power Level dB   | -   |             |                                     | 69/-           |              |        | -      | -     |        |
| EXTRA LOW TEMP                       |   | Total capacity(kW) / Input power(W) / COP                | -   |             |                                     |                |              |        |        |       |        |
| Max Current(A) / Max Input power(W)  |   | 0.27×2/29×2  | 0.26×2/29×2                                       | 0.25×2/29×2 | 25.0 / 5.35k                        | 25.0 / 5.55k   | 25.0 / 5.75k | -      |        |       |        |
| Starting current(A) / Comp output(W) |   | -  | -   | -           | 10.7 / 3.0k                         | 10.3 / 3.0k    | 9.9 / 3.0k   | -      |        |       |        |
| Network Impedance(ΩMAX.)             |   | -  |   |             |                                     |                |              |        |        |       |        |
| Fan motor output (Indoor/Outdoor) W  |   | 60   |   |             | 90×2                                |                |              | -      |        |       |        |
| Moisture removal volume              |   | L/h(P/h)   | 3.2   | (1.6×2)     | (6.7)                               | -              |              |        | -      |       |        |
| External static pressure             |   | Pa   | -   |             |                                     | -              |              |        | -      |       |        |
| Indoor Air flow <sup>*7</sup>        | Cooling   | m³/min (ft³/min)   | 16.5×2/13.5×2/11.5×2 (583)×2/(477)×2/(406)×2      |             |                                     | -              |              |        | -      |       |        |
|                                      | Heating   | m³/min (ft³/min)   | 16.5×2/13.5×2/11.5×2 (583)×2/(477)×2/(406)×2      |             |                                     | -              |              |        | -      |       |        |
| Outdoor Air flow                     | Cooling   | m³/min (ft³/min)   | -   |             |                                     | 110 (3885)     |              |        | -      |       |        |
|                                      | Heating   | m³/min (ft³/min)   | -   |             |                                     | 95 (3355)      |              |        | -      |       |        |
| Refrigerant type / amount g(oz)      |   | -  |   |             | R410A 3.40k (119.9)                 |                |              | -      |        |       |        |
| Product dimension                    | Height  | mm(inch)   | 256   | (10-5/64)   |                                     | 1416 (55-3/4)  |              |        | -      |       |        |
|                                      | Width   | mm(inch)   | 840   | (33-5/64)   |                                     | 940 (37-1/32)  |              |        | -      |       |        |
|                                      | Depth   | mm(inch)   | 840   | (33-5/64)   |                                     | 340 (13-13/32) |              |        | -      |       |        |
| Product dimension (Panel)            |   | H×W×D mm, inch   | 33.5×950×950                                      |             | 1-11/32 × 37-13/32 × 37-13/32       |                | -            |        |        |       |        |
| Packing dimension                    | Height  | mm(inch)   | 302   | (11-57/64)  |                                     | 1556           |              |        | -      |       |        |
|                                      | Width   | mm(inch)   | 898   | (35-3/8)    |                                     | 1055           |              |        | -      |       |        |
|                                      | Depth   | mm(inch)   | 898   | (35-3/8)    |                                     | 485            |              |        | -      |       |        |
| Weight                               | (NET)   | kg(lb)   | 19  | (42)        |                                     | 98             | (216)        |        | -      |       |        |
|                                      | (GROSS)   | kg(lb)   | 26  | (57)        |                                     | 108            | (238)        |        | -      |       |        |
|                                      | Panel (NET)   | kg(lb)   | 5   | (11)        |                                     | -              |              |        | -      |       |        |
| Layers limit (actually)              |   | 11 (12)  |   |             | 1 (2)                               |                |              | -      |        |       |        |
| Operation condition                  |   | Cool (DBT)   | 18°C ~ 32°C                                       |             |                                     | -15°C ~ 46°C   |              |        | -      |       |        |
|                                      |   | Heat (DBT)   | 16°C ~ 30°C                                       |             |                                     | -20°C ~ 24°C   |              |        | -      |       |        |
| P                                    | Pipe diameter mm (inch)                             | (Liquid)Ø6.35(1/4) (Gas)Ø12.7(1/2)                       |   |             | (Liquid)Ø9.52(3/8) (Gas)Ø15.88(5/8) |                |              | -      |        |       |        |
| I                                    | Connecting method, Standard length m(ft)            | flared type, 5.0(16.4)                                   |   |             | flared type, 5.0(16.4)              |                |              | -      |        |       |        |
| P                                    | Pipe length range m (ft)                            | 5 ~ 75m (16.4 ~ 246.1)                                   |   |             |                                     |                |              |        |        |       |        |
| I                                    | Indoor unit & Outdoor unit height difference m (ft) | 15m(OD located lower)/30m(OD located higher) (49.2/98.4) |   |             |                                     |                |              |        |        |       |        |
| N                                    | Add gas amount g/m (oz/ft)                          | 50g (0.538)  |   |             |                                     |                |              |        |        |       |        |
| G                                    | Pipe length for additional gas m (ft)               | 30m (98.4)   |   |             |                                     |                |              |        |        |       |        |

\*1 In case it is necessary to indicate the air flow volume in (l/s), the value in (m³/min.) shall be multiplied by 16.7 and rounded down the decimal point.

\*2 If the EUROVENT Certified models can be operated under the "extra-low" temperature condition, -7°C dry bulb and -8°C wet-bulb temperatures with rated voltage 230V shall be used.

\*3 Network Impedance shall be applicable for EUROPE and CHINA models.

\*4 The annual consumption is calculated by multiplying the input power at 230V(400V) by an average of 500 hours per year in cooling mode.

\*5 EER and COP classification is at 230V(400V) only in accordance with EU directive 2002/31/EC.

\*6 SEER and SCOP classification is at 230V(400V) only in accordance with EN-14825. For heating, SCOP indicates the value of only Average heating season, Other fiche data indicates in an attached sheet.

\*7 H: High at setting 5 stage (Level 5), M: Middle at setting 5 stage (Level 3), L: Low at setting 5 stage (Level 1)

# Simultaneous (Triple) -Type

## 1-1. Unit Specifications

PE1

### 1. 4-Way Cassette Type S-50PU2E5A×3 / U-140PE1E5A

| INDOOR   |  | MODEL                                 | S-50PU2E5A×3                                      |  |                                     | -              |              |        | -     |        |      |
|--|--|---------------------------------------|---|--|-------------------------------------|----------------|--------------|--------|-------|--------|------|
| PANEL  |  | MODEL                                 | Standard type:CZ-KPU3×3 / ECONAVI type:CZ-KPU3A×3 |  |                                     | -              |              |        | -     |        |      |
| OUTDOOR  |  | MODEL                                 | -   |  |                                     | U-140PE1E5A    |              |        | -     |        |      |
| Branch pipe  |  | MODEL                                 | CZ-P3HPC2   |  |                                     |                |              |        |       | -      |      |
| Performance test condition                               |  | ISO5151 / EN14511 / EN12102 / EN14825 |   |  |                                     |                |              |        |       |        |      |
| C<br>O<br>O<br>L<br>I<br>N<br>G                          | Power supply                             | ∅, Hz                                 | 1∅ 50Hz   |  |                                     | 1∅ 50Hz        |              |        |       |        |      |
|  |  | V                                     | 220V  | 230V   | 240V                                | 220V           | 230V         | 240V   | Min   | Max    |      |
|  | Capacity                                 | kW                                    | 14.0  | 14.0   | 14.0                                | -              | -            | -      | 3.3   | 15.5   |      |
|  |  | BTU/h                                 | 47800   | 47800  | 47800                               | -              | -            | -      | 11300 | 52900  |      |
|  | Current                                  | A                                     | 0.27 ×3   | 0.26 ×3  | 0.25 ×3                             | 19.4           | 18.8         | 18.2   | -     | -      |      |
|  |  | W                                     | 29 ×3   | 29 ×3  | 29 ×3                               | 4.153k         | 4.153k       | 4.153k | -     | -      |      |
|  | Input power                              | TOTAL W                               | -   | -  | -                                   | 4.240k         | 4.240k       | 4.240k | 770   | 5.740k |      |
|  |  | Annual consumption                    | TOTAL kWh *4                                      | -  | -                                   | -              | -            | 2120   | -     | -      |      |
|  | EER/EER CLASS                            | TOTAL (W/W) <sup>5/7</sup> ("A"-G)    | -   | -  | -                                   | 3.30           | 3.30/A       | 3.30   | 4.29  | 2.70   |      |
|  | Erp <sup>6</sup>                         | Pdesign                               | kW  | -  | -                                   | -              | -            | 14.0   | -     | -      |      |
|  |  | η <sub>s.c</sub>                      | %   | -  | -                                   | -              | -            | 260.9  | -     | -      |      |
|  |  | Annual consumption                    | kWh   | -  | -                                   | -              | -            | -      | -     | -      |      |
|  |  | Class                                 | -   | -  | -                                   | -              | -            | -      | -     | -      |      |
|  | Power factor                             | %                                     | -   | -  | -                                   | 97             | 96           | 95     | -     | -      |      |
| Noise indoor   | dB-A (H/M/L) *7                          | 32/29/27                              |   |  | -                                   |                |              | -      | -     |        |      |
|  | Power Level dB                           | 47/44/42                              |   |  | -                                   |                |              | -      | -     |        |      |
| Noise outdoor  | dB-A (H/L)                               | -                                     |   |  | 54/-                                |                |              | -      | -     |        |      |
|  | Power Level dB                           | -                                     |   |  | 71/-                                |                |              | -      | -     |        |      |
| H<br>E<br>A<br>T<br>I<br>N<br>G                          | Capacity                                 | kW                                    | 16.0  | 16.0   | 16.0                                | -              | -            | -      | 4.1   | 18.0   |      |
|  |  | BTU/h                                 | 54600   | 54600  | 54600                               | -              | -            | -      | 14000 | 61400  |      |
|  | Current                                  | A                                     | 0.26 ×3   | 0.25 ×3  | 0.24 ×3                             | 17.0           | 16.4         | 15.9   | -     | -      |      |
|  |  | W                                     | 27 ×3   | 27 ×3  | 27 ×3                               | 3.639k         | 3.639k       | 3.639k | -     | -      |      |
|  | Input power                              | TOTAL W                               | -   | -  | -                                   | 3.720k         | 3.720k       | 3.720k | 790   | 5.720k |      |
|  |  | COP/COP CLASS                         | TOTAL (W/W) <sup>5/7</sup> ("A"-G)                | -  | -                                   | -              | 4.30         | 4.30/A | 4.30  | 5.19   | 3.15 |
|  | Erp <sup>6</sup>                         | Pdesign at -10°C                      | kW  | -  | -                                   | -              | -            | 14.0   | -     | -      |      |
|  |  | Tbivalent                             | °C  | -  | -                                   | -              | -            | -7     | -     | -      |      |
|  |  | η <sub>s.h</sub>                      | %   | -  | -                                   | -              | -            | 152.9  | -     | -      |      |
|  |  | Annual consumption                    | kWh   | -  | -                                   | -              | -            | -      | -     | -      |      |
|  | Class                                    | -                                     | -   | -  | -                                   | -              | -            | -      | -     | -      |      |
|  | Power factor                             | %                                     | -   | -  | -                                   | 97             | 96           | 95     | -     | -      |      |
|  | Noise indoor                             | dB-A (H/M/L) *7                       | 32/29/27  |  |                                     | -              |              |        | -     | -      |      |
|  |  | Power Level dB                        | 47/44/42  |  |                                     | -              |              |        | -     | -      |      |
| Noise outdoor  | dB-A (H/L)                               | -                                     |   |  | 55/-                                |                |              | -      | -     |        |      |
|  | Power Level dB                           | -                                     |   |  | 71/-                                |                |              | -      | -     |        |      |
| EXTRA LOW TEMP Total capacity(kW) / Input power(W) / COP |  | -                                     |   |  |                                     |                |              |        |       |        |      |
| Max Current(A) / Max Input power(W)                      |  | 0.27×3/29×3                           | 0.26×3/29×3                                       | 0.25×3/29×3  | 30.0 / 6.45k                        | 30.0 / 6.65k   | 30.0 / 6.85k | -      |       |        |      |
| Starting current(A) / Comp output(W)                     |  | -                                     | -   | -  | 19.4 / 3.0k                         | 18.8 / 3.0k    | 18.2 / 3.0k  | -      |       |        |      |
| Network Impedance(ΩMAX.)                                 |  | -                                     |   |  |                                     |                |              |        |       |        |      |
| Fan motor output (Indoor/Outdoor) W                      |  | 60                                    |   |  | 90 × 2                              |                |              | -      |       |        |      |
| Moisture removal volume                                  |  | L/h(Pt/h)                             | 4.8   | (1.6×3)  | (10.1)                              | -              |              |        | -     |        |      |
| External static pressure                                 |  | Pa                                    | -   |  |                                     | -              |              |        | -     |        |      |
| Indoor Air flow *7                                       | Cooling                                  | m³/min (ft³/min)                      | 16.5×3/13.5×3/11.5×3 (583)×3/(477)×3/(406)×3      |  |                                     | -              |              |        | -     | -      |      |
|  | Heating                                  | m³/min (ft³/min)                      | 16.5×3/13.5×3/11.5×3 (583)×3/(477)×3/(406)×3      |  |                                     | -              |              |        | -     | -      |      |
| Outdoor Air flow   | Cooling                                  | m³/min (ft³/min)                      | -   |  |                                     | 135 (4767)     |              |        | -     | -      |      |
|  | Heating                                  | m³/min (ft³/min)                      | -   |  |                                     | 120 (4238)     |              |        | -     | -      |      |
| Refrigerant type / amount g(oz)                          |  | -                                     |   |  | R410A 3.40k (119.9)                 |                |              | -      |       |        |      |
| Product dimension  | Height                                   | mm(inch)                              | 256   | (10-5/64)  |                                     | 1416 (55-3/4)  |              |        | -     |        |      |
|  | Width                                    | mm(inch)                              | 840   | (33-5/64)  |                                     | 940 (37-1/32)  |              |        | -     |        |      |
|  | Depth                                    | mm(inch)                              | 840   | (33-5/64)  |                                     | 340 (13-13/32) |              |        | -     |        |      |
| Product dimension (Panel)                                |  | H×W×D mm, inch                        | 33.5×950×950                                      |  | 1-11/32 × 37-13/32 × 37-13/32       |                | -            |        |       |        |      |
| Packing dimension  | Height                                   | mm(inch)                              | 302   | (11-57/64)   |                                     | 1556           |              |        | -     |        |      |
|  | Width                                    | mm(inch)                              | 898   | (35-3/8)   |                                     | 1055           |              |        | -     |        |      |
|  | Depth                                    | mm(inch)                              | 898   | (35-3/8)   |                                     | 485            |              |        | -     |        |      |
| Weight   | (NET)                                    | kg(lb)                                | 19  | (42)   |                                     | 98             | (216)        |        | -     |        |      |
|  | (GROSS)                                  | kg(lb)                                | 26  | (57)   |                                     | 108            | (238)        |        | -     |        |      |
|  | Panel (NET)                              | kg(lb)                                | 5   | (11)   |                                     | -              |              |        | -     |        |      |
| Layers limit (actually)                                  |  | 11 (12)                               |   |  | 1 (2)                               |                |              | -      |       |        |      |
| Operation condition                                      | Cool (DBT)                               | 18°C ~ 32°C                           |   |  | -15°C ~ 46°C                        |                |              | -      |       |        |      |
|  | Heat (DBT)                               | 16°C ~ 30°C                           |   |  | -20°C ~ 24°C                        |                |              | -      |       |        |      |
| P<br>I<br>P<br>I<br>N<br>G                               | Pipe diameter mm (inch)                  | (Liquid)∅6.35(1/4) (Gas)∅12.7(1/2)    |   |  | (Liquid)∅9.52(3/8) (Gas)∅15.88(5/8) |                |              | -      |       |        |      |
|  | Connecting method, Standard length m(ft) | flared type, 5.0(16.4)                |   |  | flared type, 5.0(16.4)              |                |              | -      |       |        |      |
| Pipe length range  |  | m (ft)                                |   | 5 ~ 75m (16.4 ~ 246.1)                                   |                                     |                |              |        |       |        |      |
| Indoor unit & Outdoor unit height difference             |  | m (ft)                                |   | 15m(OD located lower)/30m(OD located higher) (49.2/98.4) |                                     |                |              |        |       |        |      |
| Add gas amount   |  | g/m (oz/ft)                           |   | 50g (0.538)  |                                     |                |              |        |       |        |      |
| Pipe length for additional gas                           |  | m (ft)                                |   | 30m (98.4)   |                                     |                |              |        |       |        |      |

\*1 In case it is necessary to indicate the air flow volume in (l/s), the value in (m³/min.) shall be multiplied by 16.7 and rounded down the decimal point.  
 \*2 If the EUROVENT Certified models can be operated under the "extra-low" temperature condition, -7°C dry bulb and -8°C wet-bulb temperatures with rated voltage 230V shall be used.  
 \*3 Network Impedance shall be applicable for EUROPE and CHINA models.  
 \*4 The annual consumption is calculated by multiplying the input power at 230V(400V) by an average of 500 hours per year in cooling mode.  
 \*5 EER and COP classification is at 230V(400V) only in accordance with EU directive 2002/31/EC.  
 \*6 SEER and SCOP classification is at 230V(400V) only in accordance with EN-14825. For heating, SCOP indicates the value of only Average heating season.  
 \*7 H: High at setting 5 stage (Level 5), M: Middle at setting 5 stage (Level 3), L: Low at setting 5 stage (Level 1)

# Single -Type

## 1-1. Unit Specifications

**PE2**

### 1. 4-Way Cassette Type S-60PU2E5A / U-60PE2E5A

| INDOOR   |  | MODEL              | S-60PU2E5A   |            |                               | -                                   |              |              | -      |      |        |
|--|--|--------------------|--|------------|-------------------------------|-------------------------------------|--------------|--------------|--------|------|--------|
| PANEL  |  | MODEL              | Standard type:CZ-KPU3 / ECONAVI type:CZ-KPU3A            |            |                               | -                                   |              |              | -      |      |        |
| OUTDOOR  |  | MODEL              | -  |            |                               | U-60PE2E5A                          |              |              | -      |      |        |
| Branch pipe  |  | MODEL              | -  |            |                               | -                                   |              |              | -      |      |        |
| Performance test condition                                 |  |                    | ISO5151 / EN14511 / EN12102 / EN14825                    |            |                               |                                     |              |              |        |      |        |
| C<br>O<br>O<br>L<br>I<br>N<br>G                            | Power supply                             |                    | 1Ø 50Hz  |            |                               | 1Ø 50Hz                             |              |              |        |      |        |
|  |  |                    | Ø, Hz  |            |                               |                                     |              |              |        |      |        |
|  |  |                    | V  | 220V       | 230V                          | 240V                                | 220V         | 230V         | 240V   | Min  | Max    |
|  | Capacity                                 |                    | kW   | 6.0        | 6.0                           | 6.0                                 | -            | -            | -      | 2.0  | 7.1    |
|  |  |                    | BTU/h  | 20500      | 20500                         | 20500                               | -            | -            | -      | 6800 | 24200  |
|  | Current                                  |                    | A  | 0.36       | 0.35                          | 0.34                                | 7.90         | 7.50         | 7.25   | -    | -      |
|  | Input power                              |                    | W  | 38         | 38                            | 38                                  | 1.562k       | 1.562k       | 1.562k | -    | -      |
|  |  |                    | TOTAL W  | -          | -                             | -                                   | 1.600k       | 1.600k       | 1.600k | 250  | 2.200k |
|  | Annual consumption                       |                    | TOTAL kWh **   | -          | -                             | -                                   | -            | 800          | -      | -    | -      |
|  | EER/EER CLASS                            |                    | TOTAL (W/W) <sup>7</sup> / ("A"-G)                       | -          | -                             | -                                   | 3.75         | 3.75/A       | 3.75   | 8.00 | 3.23   |
|  | E<br>r<br>p<br>*<br>6                    | Pdesign            | kW   | -          | -                             | -                                   | -            | 6.0          | -      | -    | -      |
|  |  | SEER               | (W/W)  | -          | -                             | -                                   | -            | 7.4          | -      | -    | -      |
|  |  | Annual consumption | kWh  | -          | -                             | -                                   | -            | 284          | -      | -    | -      |
|  |  | Class              |  | -          | -                             | -                                   | -            | A++          | -      | -    | -      |
| Power factor   |  | %                  | -  | -          | -                             | 90                                  | 90           | 90           | -      | -    |        |
| Noise indoor   |  | dB-A (H/M/L) *7    | 36/31/28   |            |                               | -                                   |              |              | -      | -    |        |
|  |  | Power Level dB     | 51/46/43   |            |                               | -                                   |              |              | -      | -    |        |
| Noise outdoor  |  | dB-A (H/L)         | -  |            |                               | 46/-                                |              |              | -      | -    |        |
|  |  | Power Level dB     | -  |            |                               | 65/-                                |              |              | -      | -    |        |
| H<br>E<br>A<br>T<br>I<br>N<br>G                            | Capacity                                 |                    | kW   | 7.0        | 7.0                           | 7.0                                 | -            | -            | -      | 1.8  | 8.0    |
|  |  |                    | BTU/h  | 23900      | 23900                         | 23900                               | -            | -            | -      | 6100 | 27300  |
|  | Current                                  |                    | A  | 0.35       | 0.34                          | 0.33                                | 8.50         | 8.15         | 7.80   | -    | -      |
|  | Input power                              |                    | W  | 36         | 36                            | 36                                  | 1.684k       | 1.684k       | 1.684k | -    | -      |
|  |  |                    | TOTAL W  | -          | -                             | -                                   | 1.720k       | 1.720k       | 1.720k | 200  | 2.050k |
|  | COP/COP CLASS                            |                    | TOTAL (W/W) <sup>7</sup> / ("A"-G)                       | -          | -                             | -                                   | 4.07         | 4.07/A       | 4.07   | 9.00 | 3.90   |
|  | E<br>r<br>p<br>*<br>6                    | Pdesign at -10°C   | kW   | -          | -                             | -                                   | -            | 6.0          | -      | -    | -      |
|  |  | Tbivalent          | °C   | -          | -                             | -                                   | -            | -8           | -      | -    | -      |
|  |  | SCOP               | (W/W)  | -          | -                             | -                                   | -            | 4.2          | -      | -    | -      |
|  |  | Annual consumption | kWh  | -          | -                             | -                                   | -            | 1999         | -      | -    | -      |
|  | Power factor                             |                    | %  | -          | -                             | -                                   | 90           | 90           | 90     | -    | -      |
|  | Noise indoor                             |                    | dB-A (H/M/L) *7  | 36/31/28   |                               |                                     | -            |              |        | -    | -      |
|  |  |                    | Power Level dB   | 51/46/43   |                               |                                     | -            |              |        | -    | -      |
|  | Noise outdoor                            |                    | dB-A (H/L)   | -          |                               |                                     | 49/-         |              |        | -    | -      |
| Power Level dB   |  |                    | -  |            |                               | 69/-                                |              |              | -      | -    |        |
| EXTRA LOW TEMP   Total capacity(kW) / Input power(W) / COP |  |                    | -  |            |                               |                                     |              |              |        | -    |        |
| Max Current(A) / Max Input power(W)                        |  |                    | 0.36 / 38  | 0.35 / 38  | 0.34 / 38                     | 16.5 / 3.27k                        | 16.5 / 3.42k | 16.5 / 3.57k | -      |      |        |
| Starting current(A) / Comp output(W)                       |  |                    | -  | -          | -                             | 8.50 / 1.7k                         | 8.15 / 1.7k  | 7.80 / 1.7k  | -      |      |        |
| Network Impedance(ΩMAX.)                                   |  |                    | -  |            |                               |                                     |              |              |        | -    |        |
| Fan motor output (Indoor/Outdoor) W                        |  |                    | 60   |            |                               | 60                                  |              |              | -      |      |        |
| Moisture removal volume                                    |  |                    | L/h(Pt/h)  | 1.7        | (3.6)                         | -                                   |              |              | -      |      |        |
| External static pressure                                   |  |                    | Pa   | -          |                               |                                     | -            |              |        | -    |        |
| Indoor Air flow *7   | Cooling                                  | m³/min (ft³/min)   | 21.0 / 16.0 / 13.0 (742) / (565) / (459)                 |            |                               | -                                   |              |              | -      | -    |        |
|  | Heating                                  | m³/min (ft³/min)   | 21.0 / 16.0 / 13.0 (742) / (565) / (459)                 |            |                               | -                                   |              |              | -      | -    |        |
| Outdoor Air flow   | Cooling                                  | m³/min (ft³/min)   | -  |            |                               | 38 (1342)                           |              |              | -      | -    |        |
|  | Heating                                  | m³/min (ft³/min)   | -  |            |                               | 41 (1448)                           |              |              | -      | -    |        |
| Refrigerant type / amount g(oz)                            |  |                    | -  |            |                               | R410A 1.95k (68.8)                  |              |              | -      |      |        |
| Product dimension  |  | Height mm(inch)    | 256  | (10-5/64)  |                               | 619                                 | (24-3/8)     |              | -      |      |        |
|  |  | Width mm(inch)     | 840  | (33-5/64)  |                               | 799                                 | (31-29/64)   |              | -      |      |        |
|  |  | Depth mm(inch)     | 840  | (33-5/64)  |                               | 299                                 | (11-49/64)   |              | -      |      |        |
| Product dimension (Panel)                                  |  | H×W×D mm, inch     | 33.5×950×950   |            | 1-11/32 × 37-13/32 × 37-13/32 |                                     | -            |              |        |      |        |
| Packing dimension  |  | Height mm(inch)    | 302  | (11-57/64) |                               | 688                                 |              | -            |        |      |        |
|  |  | Width mm(inch)     | 898  | (35-3/8)   |                               | 931                                 |              | -            |        |      |        |
|  |  | Depth mm(inch)     | 898  | (35-3/8)   |                               | 422                                 |              | -            |        |      |        |
| Weight   |  | (NET) kg(lb)       | 20   | (44)       |                               | 40                                  | (88)         |              | -      |      |        |
|  |  | (GROSS) kg(lb)     | 27   | (60)       |                               | 45                                  | (99)         |              | -      |      |        |
|  |  | Panel (NET) kg(lb) | 5  | (11)       |                               | -                                   |              | -            |        |      |        |
| Layers limit (actually)                                    |  |                    | 11 (12)  |            |                               | 5 (6)                               |              |              | -      |      |        |
| Operation condition  |  | Cool (DBT)         | 18°C ~ 32°C  |            |                               | -15°C ~ 46°C                        |              |              | -      |      |        |
|  |  | Heat (DBT)         | 16°C ~ 30°C  |            |                               | -20°C ~ 24°C                        |              |              | -      |      |        |
| P<br>I<br>P<br>I<br>N<br>G                                 | Pipe diameter mm (inch)                  |                    | (Liquid)Ø9.52(3/8) (Gas)Ø15.88(5/8)                      |            |                               | (Liquid)Ø9.52(3/8) (Gas)Ø15.88(5/8) |              |              | -      |      |        |
|  | Connecting method, Standard length m(ft) |                    | flared type, 5.0(16.4)                                   |            |                               | flared type, 5.0(16.4)              |              |              | -      |      |        |
| Pipe length range  |  | m (ft)             | 3 ~ 40m (9.8 ~ 131.2)                                    |            |                               | -                                   |              |              | -      |      |        |
| Indoor unit & Outdoor unit height difference               |  | m (ft)             | 15m(OD located lower)/30m(OD located higher) (49.2/98.4) |            |                               | -                                   |              |              | -      |      |        |
| Add gas amount   |  | g/m (oz/ft)        | 40g (0.430)  |            |                               | -                                   |              |              | -      |      |        |
| Pipe length for additional gas                             |  | m (ft)             | 30m (98.4)   |            |                               | -                                   |              |              | -      |      |        |

\*1 In case it is necessary to indicate the air flow volume in (l/s), the value in (m³/min.) shall be multiplied by 16.7 and rounded down the decimal point.

\*2 If the EUROVENT Certified models can be operated under the "extra-low" temperature condition, -7°C dry bulb and -8°C wet-bulb temperatures with rated voltage 230V shall be used.

\*3 Network Impedance shall be applicable for EUROPE and CHINA models.

\*4 The annual consumption is calculated by multiplying the input power at 230V(400V) by an average of 500 hours per year in cooling mode.

\*5 EER and COP classification is at 230V(400V) only in accordance with EU directive 2002/31/EC.

\*6 SEER and SCOP classification is at 230V(400V) only in accordance with EN-14825. For heating, SCOP indicates the value of only Average heating season, Other fiche data indicates in an attached sheet.

\*7 H: High at setting 5 stage (Level 5), M: Middle at setting 5 stage (Level 3), L: Low at setting 5 stage (Level 1)



# Simultaneous (Twin) -Type

## 1-1. Unit Specifications

PE1

### 1. 4-Way Cassette Type S-60PU2E5A×2 / U-125PE1E5A

| INDOOR                                       |  | MODEL                                     | S-60PU2E5A×2                                      |  |                                     | -              |              |        | -      |       |        |
|--|--|---|---|--|-------------------------------------|----------------|--------------|--------|--------|-------|--------|
| PANEL  |  | MODEL                                     | Standard type:CZ-KPU3×2 / ECONAVI type:CZ-KPU3A×2 |  |                                     | -              |              |        | -      |       |        |
| OUTDOOR                                      |  | MODEL                                     | -   |  |                                     | U-125PE1E5A    |              |        | -      |       |        |
| Branch pipe                                  |  | MODEL                                     | CZ-P155BK1  |  |                                     |                |              |        |        | -     |        |
| Performance test condition                   |  | ISO5151 / EN14511 / EN12102 / EN14825     |   |  |                                     |                |              |        |        |       |        |
| C<br>O<br>O<br>L<br>I<br>N<br>G              | Power supply                             |   | 1Ø 50Hz   |  |                                     | 1Ø 50Hz        |              |        |        |       |        |
|  |  |   | Ø, Hz   |  |                                     |                |              |        |        |       |        |
|  |  |   | V   | 220V   | 230V                                | 240V           | 220V         | 230V   | 240V   | Min   | Max    |
|  | Capacity                                 |   | kW  | 12.5   | 12.5                                | 12.5           | -            | -      | -      | 3.3   | 14.0   |
|  |  |   | BTU/h   | 42700  | 42700                               | 42700          | -            | -      | -      | 11300 | 47800  |
|  | Current                                  |   | A   | 0.36 ×2  | 0.35 ×2                             | 0.34 ×2        | 15.4         | 14.9   | 14.4   | -     | -      |
|  | Input power                              |   | W   | 38 ×2  | 38 ×2                               | 38 ×2          | 3.294k       | 3.294k | 3.294k | -     | -      |
|  |  |   | TOTAL W   | -  | -                                   | -              | 3.370k       | 3.370k | 3.370k | 770   | 4.600k |
|  | Annual consumption                       |   | TOTAL kWh *4                                      | -  | -                                   | -              | -            | 1685   | -      | -     | -      |
|  | EER/EER CLASS                            |   | TOTAL (W/W) <sup>5/7</sup> ("A"-G)                | -  | -                                   | -              | 3.70         | 3.70/A | 3.70   | 4.29  | 3.04   |
|  | Erp *6                                   |   | Pdesign   | kW   | -                                   | -              | -            | 12.5   | -      | -     | -      |
|  |  |   | η <sub>s.c</sub>                                  | %  | -                                   | -              | -            | 277.2  | -      | -     | -      |
|  |  |   | Annual consumption                                | kWh  | -                                   | -              | -            | -      | -      | -     | -      |
|  |  |   | Class   | -  | -                                   | -              | -            | -      | -      | -     | -      |
| Power factor                                 |  | %   | -   | -  | -                                   | 97             | 96           | 95     | -      | -     |        |
| Noise indoor                                 |  | dB-A (H/M/L) *7                           | 36/31/28  |  |                                     | -              |              |        | -      | -     |        |
|  |  | Power Level dB                            | 51/46/43  |  |                                     | -              |              |        | -      | -     |        |
| Noise outdoor                                |  | dB-A (H/L)                                | -   |  |                                     | 53/-           |              |        | -      | -     |        |
|  |  | Power Level dB                            | -   |  |                                     | 70/-           |              |        | -      | -     |        |
| H<br>E<br>A<br>T<br>I<br>N<br>G              | Capacity                                 |   | kW  | 14.0   | 14.0                                | 14.0           | -            | -      | -      | 4.1   | 16.0   |
|  |  |   | BTU/h   | 47800  | 47800                               | 47800          | -            | -      | -      | 14000 | 54600  |
|  | Current                                  |   | A   | 0.35 ×2  | 0.34 ×2                             | 0.33×2         | 13.9         | 13.4   | 13.0   | -     | -      |
|  | Input power                              |   | W   | 36 ×2  | 36 ×2                               | 36 ×2          | 2.968k       | 2.968k | 2.968k | -     | -      |
|  |  |   | TOTAL W   | -  | -                                   | -              | 3.040k       | 3.040k | 3.040k | 790   | 5.040k |
|  | COP/COP CLASS                            |   | TOTAL (W/W) <sup>5/7</sup> ("A"-G)                | -  | -                                   | -              | 4.60         | 4.60/A | 4.60   | 5.19  | 3.17   |
|  | Erp *6                                   |   | Pdesign at -10°C                                  | kW   | -                                   | -              | -            | 12.5   | -      | -     | -      |
|  |  |   | Tbivalent   | °C   | -                                   | -              | -            | -10    | -      | -     | -      |
|  |  |   | η <sub>s.h</sub>                                  | %  | -                                   | -              | -            | 161.0  | -      | -     | -      |
|  |  |   | Annual consumption                                | kWh  | -                                   | -              | -            | -      | -      | -     | -      |
|  |  |   | Class   | -  | -                                   | -              | -            | -      | -      | -     | -      |
|  | Power factor                             |   | %   | -  | -                                   | -              | 97           | 96     | 95     | -     | -      |
|  | Noise indoor                             |   | dB-A (H/M/L) *7                                   | 36/31/28   |                                     |                | -            |        |        | -     | -      |
|  |  |   | Power Level dB                                    | 51/46/43   |                                     |                | -            |        |        | -     | -      |
| Noise outdoor                                |  | dB-A (H/L)                                | -   |  |                                     | 53/-           |              |        | -      | -     |        |
|  |  | Power Level dB                            | -   |  |                                     | 70/-           |              |        | -      | -     |        |
| EXTRA LOW TEMP                               |  | Total capacity(kW) / Input power(W) / COP | -   |  |                                     |                |              |        |        |       |        |
| Max Current(A) / Max Input power(W)          |  | 0.36×2/38×2                               | 0.35×2/38×2                                       | 0.34×2/38×2  | 28.0 / 6.00k                        | 28.0 / 6.20k   | 28.0 / 6.40k | -      |        |       |        |
| Starting current(A) / Comp output(W)         |  | -   | -   | -  | 15.4 / 3.0k                         | 14.9 / 3.0k    | 14.4 / 3.0k  | -      |        |       |        |
| Network Impedance(ΩMAX.)                     |  | -   |   |  |                                     |                |              |        |        |       |        |
| Fan motor output (Indoor/Outdoor) W          |  | 60  |   |  | 90 × 2                              |                |              | -      |        |       |        |
| Moisture removal volume                      |  | L/h(Pt/h)                                 | 3.4   | (1.7×2)  | (7.1)                               | -              |              |        | -      |       |        |
| External static pressure                     |  | Pa  | -   |  |                                     | -              |              |        | -      |       |        |
| Indoor Air flow *7                           | Cooling                                  | m³/min (ft³/min)                          | 21.0×2/16.0×2/13.0×2 (742)×2/(565)×2/(459)×2      |  |                                     | -              |              |        | -      |       |        |
|  | Heating                                  | m³/min (ft³/min)                          | 21.0×2/16.0×2/13.0×2 (742)×2/(565)×2/(459)×2      |  |                                     | -              |              |        | -      |       |        |
| Outdoor Air flow                             | Cooling                                  | m³/min (ft³/min)                          | -   |  |                                     | 130 (4591)     |              |        | -      |       |        |
|  | Heating                                  | m³/min (ft³/min)                          | -   |  |                                     | 110 (3885)     |              |        | -      |       |        |
| Refrigerant type / amount g(oz)              |  | -   |   |  | R410A 3.40k (119.9)                 |                |              | -      |        |       |        |
| Product dimension                            | Height                                   | mm(inch)                                  | 256   | (10-5/64)  |                                     | 1416 (55-3/4)  |              |        | -      |       |        |
|  | Width                                    | mm(inch)                                  | 840   | (33-5/64)  |                                     | 940 (37-1/32)  |              |        | -      |       |        |
|  | Depth                                    | mm(inch)                                  | 840   | (33-5/64)  |                                     | 340 (13-13/32) |              |        | -      |       |        |
| Product dimension (Panel)                    |  | H×W×D mm, inch                            | 33.5×950×950                                      |  | 1-11/32 × 37-13/32 × 37-13/32       |                | -            |        |        |       |        |
| Packing dimension                            | Height                                   | mm(inch)                                  | 302   | (11-57/64)   |                                     | 1556           |              |        | -      |       |        |
|  | Width                                    | mm(inch)                                  | 898   | (35-3/8)   |                                     | 1055           |              |        | -      |       |        |
|  | Depth                                    | mm(inch)                                  | 898   | (35-3/8)   |                                     | 485            |              |        | -      |       |        |
| Weight                                       | (NET)                                    | kg(lb)                                    | 20  | (44)   |                                     | 98             | (216)        |        | -      |       |        |
|  | (GROSS)                                  | kg(lb)                                    | 27  | (60)   |                                     | 108            | (238)        |        | -      |       |        |
|  | Panel (NET)                              | kg(lb)                                    | 5   | (11)   |                                     | -              |              |        | -      |       |        |
| Layers limit (actually)                      |  | 11 (12)                                   |   |  | 1 (2)                               |                |              | -      |        |       |        |
| Operation condition                          | Cool (DBT)                               | 18°C ~ 32°C                               |   |  | -15°C ~ 46°C                        |                |              | -      |        |       |        |
|  | Heat (DBT)                               | 16°C ~ 30°C                               |   |  | -20°C ~ 24°C                        |                |              | -      |        |       |        |
| P<br>I<br>P<br>I<br>N<br>G                   | Pipe diameter mm (inch)                  | (Liquid)Ø9.52(3/8) (Gas)Ø15.88(5/8)       |   |  | (Liquid)Ø9.52(3/8) (Gas)Ø15.88(5/8) |                |              | -      |        |       |        |
|  | Connecting method, Standard length m(ft) | flared type, 5.0(16.4)                    |   |  | flared type, 5.0(16.4)              |                |              | -      |        |       |        |
| Pipe length range                            |  | m (ft)                                    |   | 5 ~ 75m (16.4 ~ 246.1)                                   |                                     |                |              |        |        |       |        |
| Indoor unit & Outdoor unit height difference |  | m (ft)                                    |   | 15m(OD located lower)/30m(OD located higher) (49.2/98.4) |                                     |                |              |        |        |       |        |
| Add gas amount                               |  | g/m (oz/ft)                               |   | 50g (0.538)  |                                     |                |              |        |        |       |        |
| Pipe length for additional gas               |  | m (ft)                                    |   | 30m (98.4)   |                                     |                |              |        |        |       |        |

\*1 In case it is necessary to indicate the air flow volume in (l/s), the value in (m³/min.) shall be multiplied by 16.7 and rounded down the decimal point.  
 \*2 If the EUROVENT Certified models can be operated under the "extra-low" temperature condition, -7°C dry bulb and -8°C wet-bulb temperatures with rated voltage 230V shall be used.  
 \*3 Network Impedance shall be applicable for EUROPE and CHINA models.  
 \*4 The annual consumption is calculated by multiplying the input power at 230V(400V) by an average of 500 hours per year in cooling mode.  
 \*5 EER and COP classification is at 230V(400V) only in accordance with EU directive 2002/31/EC.  
 \*6 SEER and SCOP classification is at 230V(400V) only in accordance with EN-14825. For heating, SCOP indicates the value of only Average heating season.  
 \*7 H: High at setting 5 stage (Level 5), M: Middle at setting 5 stage (Level 3), L: Low at setting 5 stage (Level 1)

# Single-Type

## 1-1. Unit Specifications

**PE1**

### 1. 4-Way Cassette Type S-71PU2E5A / U-71PE1E5A

| INDOOR   | MODEL                                    | S-71PU2E5A   |                                    |            | -                                   |              |              | -      |      |        |
|--|--|--|------------------------------------|------------|-------------------------------------|--------------|--------------|--------|------|--------|
| PANEL  | MODEL                                    | Standard type:CZ-KPU3:ECONAVI type:CZ-KPU3A              |                                    |            | -                                   |              |              | -      |      |        |
| OUTDOOR  | MODEL                                    | -  |                                    |            | U-71PE1E5A                          |              |              | -      |      |        |
| Branch pipe  | MODEL                                    | -  |                                    |            | -                                   |              |              | -      |      |        |
| Performance test condition                               |  | ISO5151 / EN14511 / EN12102/ EN14825                     |                                    |            |                                     |              |              |        |      |        |
| C<br>O<br>O<br>L<br>I<br>N<br>G                          | Power supply                             | Ø, Hz  | 1Ø 50Hz                            |            |                                     | 1Ø 50Hz      |              |        | Min  | Max    |
|  |  | V  | 220V                               | 230V       | 240V                                | 220V         | 230V         | 240V   |      |        |
|  | Capacity                                 | kW   | 7.1                                | 7.1        | 7.1                                 | -            | -            | -      | 2.5  | 8.0    |
|  |  | BTU/h  | 24200                              | 24200      | 24200                               | -            | -            | -      | 8500 | 27300  |
|  | Current                                  | A  | 0.40                               | 0.39       | 0.38                                | 8.40         | 8.10         | 7.90   | -    | -      |
|  |  | W  | 42                                 | 42         | 42                                  | 1.758k       | 1.758k       | 1.758k | -    | -      |
|  | Input power                              | TOTAL W  | -                                  | -          | -                                   | 1.800k       | 1.800k       | 1.800k | 450  | 2.650k |
|  |  | Annual consumption                                       | TOTAL kWh *4                       | -          | -                                   | -            | -            | 900    | -    | -      |
|  | EER/EER CLASS                            | TOTAL (W/W) <sup>7</sup> / ("A"-G)                       | -                                  | -          | -                                   | 3.94         | 3.94/A       | 3.94   | 5.56 | 3.02   |
|  | Erp <sup>5</sup>                         | Pdesign  | kW                                 | -          | -                                   | -            | -            | 7.1    | -    | -      |
|  |  | SEER   | (W/W)                              | -          | -                                   | -            | -            | 7.6    | -    | -      |
|  |  | Annual consumption                                       | kWh                                | -          | -                                   | -            | -            | 327    | -    | -      |
|  |  | Class  |                                    | -          | -                                   | -            | -            | A++    | -    | -      |
|  | Power factor                             | %  | -                                  | -          | -                                   | 95           | 94           | 93     | -    | -      |
| Noise indoor   | dB-A (H/M/L) *7                          | 37/31/28   |                                    |            | -                                   |              |              | -      | -    |        |
|  | Power Level dB                           | 52/46/43   |                                    |            | -                                   |              |              | -      | -    |        |
| Noise outdoor  | dB-A (H/L)                               | -  |                                    |            | 48/-                                |              |              | -      | -    |        |
|  | Power Level dB                           | -  |                                    |            | 65/-                                |              |              | -      | -    |        |
| H<br>E<br>A<br>T<br>I<br>N<br>G                          | Capacity                                 | kW   | 8.0                                | 8.0        | 8.0                                 | -            | -            | -      | 2.0  | 9.0    |
|  |  | BTU/h  | 27300                              | 27300      | 27300                               | -            | -            | -      | 6800 | 30700  |
|  | Current                                  | A  | 0.39                               | 0.38       | 0.37                                | 8.60         | 8.25         | 8.00   | -    | -      |
|  |  | W  | 40                                 | 40         | 40                                  | 1.820k       | 1.820k       | 1.820k | -    | -      |
|  | Input power                              | TOTAL W  | -                                  | -          | -                                   | 1.860k       | 1.860k       | 1.860k | 400  | 2.850k |
|  |  | COP/COP CLASS  | TOTAL (W/W) <sup>7</sup> / ("A"-G) | -          | -                                   | -            | 4.30         | 4.30/A | 4.30 | 5.00   |
|  | Erp <sup>5</sup>                         | Pdesign at -10°C   | kW                                 | -          | -                                   | -            | -            | 7.1    | -    | -      |
|  |  | Tbivalent  | °C                                 | -          | -                                   | -            | -            | -10    | -    | -      |
|  |  | SCOP   | (W/W)                              | -          | -                                   | -            | -            | 4.3    | -    | -      |
|  |  | Annual consumption                                       | kWh                                | -          | -                                   | -            | -            | 2312   | -    | -      |
|  | Class                                    |  | -                                  | -          | -                                   | -            | A+           | -      | -    |        |
|  | Power factor                             | %  | -                                  | -          | -                                   | 96           | 96           | 95     | -    | -      |
|  | Noise indoor                             | dB-A (H/M/L) *7  | 37/31/28                           |            |                                     | -            |              |        | -    | -      |
|  |  | Power Level dB   | 52/46/43                           |            |                                     | -            |              |        | -    | -      |
| Noise outdoor  | dB-A (H/L)                               | -  |                                    |            | 50/-                                |              |              | -      | -    |        |
|  | Power Level dB                           | -  |                                    |            | 67/-                                |              |              | -      | -    |        |
| EXTRA LOW TEMP Total capacity(kW) / Input power(W) / COP |  | -  |                                    |            |                                     |              |              |        |      |        |
| Max Current(A) / Max Input power(W)                      |  | 0.40/42  | 0.39/42                            | 0.38/42    | 18.0 / 3.80k                        | 18.0 / 3.93k | 18.0 / 4.06k | -      |      |        |
| Starting current(A) / Comp output(W)                     |  | -  | -                                  | -          | 8.60 / 2.0k                         | 8.25 / 2.0k  | 8.00 / 2.0k  | -      |      |        |
| Network Impedance(ΩMAX.)                                 |  | -  |                                    |            |                                     |              |              |        |      |        |
| Fan motor output (Indoor/Outdoor) W                      |  | 60   |                                    |            | 90                                  |              |              | -      |      |        |
| Moisture removal volume                                  |  | L/h(Pt/h)  | 2.5                                | (5.3)      | -                                   |              |              | -      |      |        |
| External static pressure                                 |  | Pa   | -                                  |            |                                     | -            |              |        | -    |        |
| Indoor Air flow *7                                       | Cooling                                  | m³/min (ft³/min)   | 22.0/16.0/13.0 (777)/(565)/(459)   |            |                                     | -            |              |        | -    | -      |
|  | Heating                                  | m³/min (ft³/min)   | 22.0/16.0/13.0 (777)/(565)/(459)   |            |                                     | -            |              |        | -    | -      |
| Outdoor Air flow   | Cooling                                  | m³/min (ft³/min)   | -                                  |            |                                     | 60 (2119)    |              |        | -    | -      |
|  | Heating                                  | m³/min (ft³/min)   | -                                  |            |                                     | 60 (2119)    |              |        | -    | -      |
| Refrigerant type / amount g(oz)                          |  | -  |                                    |            | R410A 2.35k (82.9)                  |              |              | -      |      |        |
| Product dimension  | Height                                   | mm(inch)   | 256                                | (10-5/64)  | 996 (39-7/32)                       |              |              | -      |      |        |
|  | Width                                    | mm(inch)   | 840                                | (33-5/64)  | 940 (37-1/32)                       |              |              | -      |      |        |
|  | Depth                                    | mm(inch)   | 840                                | (33-5/64)  | 340 (13-13/32)                      |              |              | -      |      |        |
| Product dimension (Panel)                                |  | H×W×D mm, inch   | 33.5×950×950                       |            | 1-11/32 × 37-13/32 × 37-13/32       |              | -            |        |      |        |
| Packing dimension  | Height                                   | mm(inch)   | 302                                | (11-57/64) | 1136                                |              |              | -      |      |        |
|  | Width                                    | mm(inch)   | 898                                | (35-3/8)   | 1055                                |              |              | -      |      |        |
|  | Depth                                    | mm(inch)   | 898                                | (35-3/8)   | 485                                 |              |              | -      |      |        |
| Weight   | (NET)                                    | kg(lb)   | 20                                 | (44)       | 69                                  | (152)        | -            |        |      |        |
|  | (GROSS)                                  | kg(lb)   | 27                                 | (60)       | 77                                  | (170)        | -            |        |      |        |
|  | Panel (NET)                              | kg(lb)   | 5                                  | (11)       | -                                   |              |              | -      |      |        |
| Layers limit (actually)                                  |  | 11 (12)  |                                    |            | 2 (3)                               |              |              | -      |      |        |
| Operation condition                                      | Cool (DBT)                               | 18°C ~ 32°C  |                                    |            | -15°C ~ 46°C                        |              |              | -      |      |        |
|  | Heat (DBT)                               | 16°C ~ 30°C  |                                    |            | -20°C ~ 24°C                        |              |              | -      |      |        |
| P<br>I<br>P<br>I<br>N<br>G                               | Pipe diameter mm (inch)                  | (Liquid)Ø9.52(3/8) (Gas)Ø15.88(5/8)                      |                                    |            | (Liquid)Ø9.52(3/8) (Gas)Ø15.88(5/8) |              |              | -      |      |        |
|  | Connecting method, Standard length m(ft) | flared type, 5.0(16.4)                                   |                                    |            | flared type, 5.0(16.4)              |              |              | -      |      |        |
| Pipe length range  |  | m (ft) 5 ~ 50m (16.4 ~164)                               |                                    |            |                                     |              |              |        |      |        |
| Indoor unit & Outdoor unit height difference m (ft)      |  | 15m(OD located lower)/30m(OD located higher) (49.2/98.4) |                                    |            |                                     |              |              |        |      |        |
| Add gas amount g/m (oz/ft)                               |  | 50g (0.538)  |                                    |            |                                     |              |              |        |      |        |
| Pipe length for additional gas m (ft)                    |  | 30m (98.4)   |                                    |            |                                     |              |              |        |      |        |

\*1 In case it is necessary to indicate the air flow volume in (l/s), the value in (m³/min.) shall be multiplied by 16.7 and rounded down the decimal point.

\*2 If the EUROVENT Certified models can be operated under the "extra-low" temperature condition, -7°C dry bulb and -8°C wet-bulb temperatures with rated voltage 230V shall be used.

\*3 Network Impedance shall be applicable for EUROPE and CHINA models.

\*4 The annual consumption is calculated by multiplying the input power at 230V(400V) by an average of 500 hours per year in cooling mode.

\*5 EER and COP classification is at 230V(400V) only in accordance with EU directive 2002/31/EC.

\*6 SEER and SCOP classification is at 230V(400V) only in accordance with EN-14825. For heating, SCOP indicates the value of only Average heating season, Other fiche data indicates in an attached sheet.

\*7 H: High at setting 5 stage (Level 5), M: Middle at setting 5 stage (Level 3), L: Low at setting 5 stage (Level 1)

# Simultaneous (Twin) -Type

## 1-1. Unit Specifications

**PE1**

### 1. 4-Way Cassette Type S-71PU2E5A×2 / U-140PE1E5A

| INDOOR  |                    | MODEL  | S-71PU2E5A×2                                      |                               |                                     | -              |              |        | -      |       |        |
|---|--------------------|--|---|-------------------------------|-------------------------------------|----------------|--------------|--------|--------|-------|--------|
| PANEL   |                    | MODEL  | Standard type:CZ-KPU3×2 / ECONAVI type:CZ-KPU3A×2 |                               |                                     | -              |              |        | -      |       |        |
| OUTDOOR   |                    | MODEL  | -   |                               |                                     | U-140PE1E5A    |              |        | -      |       |        |
| Branch pipe   |                    | MODEL  | -   |                               |                                     | CZ-P155BK1     |              |        | -      |       |        |
| Performance test condition                          |                    | ISO5151 / EN14511 / EN12102 / EN14825                    |   |                               |                                     |                |              |        |        |       |        |
| C<br>O<br>L<br>L<br>I<br>N<br>G                     | Power supply       |  | 1Ø 50Hz   |                               |                                     | 1Ø 50Hz        |              |        |        |       |        |
|   |                    |  | Ø, Hz   |                               |                                     |                |              |        |        |       |        |
|   |                    |  | V   | 220V                          | 230V                                | 240V           | 220V         | 230V   | 240V   | Min   | Max    |
|   | Capacity           |  | kW  | 14.0                          | 14.0                                | 14.0           | -            | -      | -      | 3.3   | 15.5   |
|   |                    |  | BTU/h   | 47800                         | 47800                               | 47800          | -            | -      | -      | 11300 | 52900  |
|   | Current            |  | A   | 0.40×2                        | 0.39×2                              | 0.38×2         | 19.4         | 18.8   | 18.2   | -     | -      |
|   | Input power        |  | W   | 42×2                          | 42×2                                | 42×2           | 4.156k       | 4.156k | 4.156k | -     | -      |
|   |                    |  | TOTAL W   | -                             | -                                   | -              | 4.240k       | 4.240k | 4.240k | 770   | 5.740k |
|   | Annual consumption |  | TOTAL kWh *4                                      | -                             | -                                   | -              | -            | 2120   | -      | -     | -      |
|   | EER/EER CLASS      |  | TOTAL (W/W) *5 / ("A"-G)                          | -                             | -                                   | -              | 3.30         | 3.30/A | 3.30   | 4.29  | 2.70   |
|   | Erp *6             |  | Pdesign kW  | -                             | -                                   | -              | -            | 14.0   | -      | -     | -      |
|   |                    |  | η <sub>s.c</sub> %                                | -                             | -                                   | -              | -            | 260.6  | -      | -     | -      |
|   |                    |  | Annual consumption kWh                            | -                             | -                                   | -              | -            | -      | -      | -     | -      |
|   |                    |  | Class   | -                             | -                                   | -              | -            | -      | -      | -     | -      |
| Power factor  |                    | %  | -   | -                             | -                                   | 97             | 96           | 95     | -      | -     |        |
| Noise indoor  |                    | dB-A (H/M/L) *7  | 37/31/28  |                               |                                     | -              |              |        | -      | -     |        |
|   |                    | Power Level dB   | 52/46/43  |                               |                                     | -              |              |        | -      | -     |        |
| Noise outdoor                                       |                    | dB-A (H/L)   | -   |                               |                                     | 54/-           |              |        | -      | -     |        |
|   |                    | Power Level dB   | -   |                               |                                     | 71/-           |              |        | -      | -     |        |
| H<br>E<br>A<br>T<br>I<br>N<br>G                     | Capacity           |  | kW  | 16.0                          | 16.0                                | 16.0           | -            | -      | -      | 4.1   | 18.0   |
|   |                    |  | BTU/h   | 54600                         | 54600                               | 54600          | -            | -      | -      | 14000 | 61400  |
|   | Current            |  | A   | 0.39×2                        | 0.38×2                              | 0.37×2         | 17.0         | 16.5   | 15.9   | -     | -      |
|   | Input power        |  | W   | 40×2                          | 40×2                                | 40×2           | 3.640k       | 3.640k | 3.640k | -     | -      |
|   |                    |  | TOTAL W   | -                             | -                                   | -              | 3.720k       | 3.720k | 3.720k | 790   | 5.720k |
|   | COP/COP CLASS      |  | TOTAL (W/W) *5 / ("A"-G)                          | -                             | -                                   | -              | 4.30         | 4.30/A | 4.30   | 5.19  | 3.15   |
|   | Erp *6             |  | Pdesign at -10°C kW                               | -                             | -                                   | -              | -            | 14.0   | -      | -     | -      |
|   |                    |  | Tbivalent °C                                      | -                             | -                                   | -              | -            | -7     | -      | -     | -      |
|   |                    |  | η <sub>s.h</sub> %                                | -                             | -                                   | -              | -            | 152.9  | -      | -     | -      |
|   |                    |  | Annual consumption kWh                            | -                             | -                                   | -              | -            | -      | -      | -     | -      |
|   |                    |  | Class   | -                             | -                                   | -              | -            | -      | -      | -     | -      |
|   | Power factor       |  | %   | -                             | -                                   | -              | 97           | 96     | 95     | -     | -      |
|   | Noise indoor       |  | dB-A (H/M/L) *7                                   | 37/31/28                      |                                     |                | -            |        |        | -     | -      |
|   |                    |  | Power Level dB                                    | 52/46/43                      |                                     |                | -            |        |        | -     | -      |
| Noise outdoor                                       |                    | dB-A (H/L)   | -   |                               |                                     | 55/-           |              |        | -      | -     |        |
|   |                    | Power Level dB   | -   |                               |                                     | 71/-           |              |        | -      | -     |        |
| EXTRA LOW TEMP                                      |                    | Total capacity(kW) / Input power(W) / COP                | -   |                               |                                     |                |              |        |        |       |        |
| Max Current(A) / Max Input power(W)                 |                    | 0.40×2/42×2  | 0.39×2/42×2                                       | 0.38×2/42×2                   | 30.0 / 6.45k                        | 30.0 / 6.65k   | 30.0 / 6.85k | -      |        |       |        |
| Starting current(A) / Comp output(W)                |                    | -  | -   | -                             | 19.4 / 3.0k                         | 18.8 / 3.0k    | 18.2 / 3.0k  | -      |        |       |        |
| Network Impedance(ΩMAX.)                            |                    | -  |   |                               |                                     |                |              |        |        |       |        |
| Fan motor output (Indoor/Outdoor) W                 |                    | 60   |   |                               | 90×2                                |                |              | -      |        |       |        |
| Moisture removal volume                             |                    | L/h(Pt/h)  | 5.0   | (2.5×2)                       | (10.5)                              | -              |              |        | -      |       |        |
| External static pressure                            |                    | Pa   | -   |                               |                                     | -              |              |        | -      |       |        |
| Indoor Air flow *7                                  | Cooling            | m³/min (ft³/min)   | 22.0×2/16.0×2/13.0×2 (777)×2/(565)×2/(459)×2      |                               |                                     | -              |              |        | -      |       |        |
|   | Heating            | m³/min (ft³/min)   | 22.0×2/16.0×2/13.0×2 (777)×2/(565)×2/(459)×2      |                               |                                     | -              |              |        | -      |       |        |
| Outdoor Air flow                                    | Cooling            | m³/min (ft³/min)   | -   |                               |                                     | 135 (4767)     |              |        | -      |       |        |
|   | Heating            | m³/min (ft³/min)   | -   |                               |                                     | 120 (4238)     |              |        | -      |       |        |
| Refrigerant type / amount g(oz)                     |                    | -  |   |                               | R410A 3.40k (119.9)                 |                |              | -      |        |       |        |
| Product dimension                                   | Height             | mm(inch)   | 256   | (10-5/64)                     |                                     | 1416 (55-3/4)  |              |        | -      |       |        |
|   | Width              | mm(inch)   | 840   | (33-5/64)                     |                                     | 940 (37-1/32)  |              |        | -      |       |        |
|   | Depth              | mm(inch)   | 840   | (33-5/64)                     |                                     | 340 (13-13/32) |              |        | -      |       |        |
| Product dimension (Panel)                           |                    | H×W×D mm, inch   | 33.5×950×950                                      | 1-11/32 × 37-13/32 × 37-13/32 |                                     | -              |              |        | -      |       |        |
| Packing dimension                                   | Height             | mm(inch)   | 302   | (11-57/64)                    |                                     | 1556           |              |        | -      |       |        |
|   | Width              | mm(inch)   | 898   | (35-3/8)                      |                                     | 1055           |              |        | -      |       |        |
|   | Depth              | mm(inch)   | 898   | (35-3/8)                      |                                     | 485            |              |        | -      |       |        |
| Weight  | (NET)              | kg(lb)   | 20  | (44)                          |                                     | 98             | (216)        |        | -      |       |        |
|   | (GROSS)            | kg(lb)   | 27  | (60)                          |                                     | 108            | (238)        |        | -      |       |        |
|   | Panel (NET)        | kg(lb)   | 5   | (11)                          |                                     | -              |              |        | -      |       |        |
| Layers limit (actually)                             |                    | 11 (12)  |   |                               | 1 (2)                               |                |              | -      |        |       |        |
| Operation condition                                 | Cool (DBT)         | 18°C ~ 32°C  |   |                               | -15°C ~ 46°C                        |                |              | -      |        |       |        |
|   | Heat (DBT)         | 16°C ~ 30°C  |   |                               | -20°C ~ 24°C                        |                |              | -      |        |       |        |
| Pipe diameter mm (inch)                             |                    | (Liquid)Ø9.52(3/8) (Gas)Ø15.88(5/8)                      |   |                               | (Liquid)Ø9.52(3/8) (Gas)Ø15.88(5/8) |                |              | -      |        |       |        |
| Connecting method, Standard length m(ft)            |                    | flared type, 5.0(16.4)                                   |   |                               | flared type, 5.0(16.4)              |                |              | -      |        |       |        |
| Pipe length range m (ft)                            |                    | 5 ~ 75m (16.4 ~ 246.1)                                   |   |                               | -                                   |                |              | -      |        |       |        |
| Indoor unit & Outdoor unit height difference m (ft) |                    | 15m(OD located lower)/30m(OD located higher) (49.2/98.4) |   |                               | -                                   |                |              | -      |        |       |        |
| Add gas amount g/m (oz/ft)                          |                    | 50g (0.538)  |   |                               | -                                   |                |              | -      |        |       |        |
| Pipe length for additional gas m (ft)               |                    | 30m (98.4)   |   |                               | -                                   |                |              | -      |        |       |        |

\*1 In case it is necessary to indicate the air flow volume in (l/s), the value in (m³/min.) shall be multiplied by 16.7 and rounded down the decimal point.

\*2 If the EUROVENT Certified models can be operated under the "extra-low" temperature condition, -7°C dry bulb and -8°C wet-bulb temperatures with rated voltage 230V shall be used.

\*3 Network Impedance shall be applicable for EUROPE and CHINA models.

\*4 The annual consumption is calculated by multiplying the input power at 230V(400V) by an average of 500 hours per year in cooling mode.

\*5 EER and COP classification is at 230V(400V) only in accordance with EU directive 2002/31/EC.

\*6 SEER and SCOP classification is at 230V(400V) only in accordance with EN-14825. For heating, SCOP indicates the value of only Average heating season.

\*7 H: High at setting 5 stage (Level 5), M: Middle at setting 5 stage (Level 3), L: Low at setting 5 stage (Level 1)

# Single-Type

## 1-1. Unit Specifications

**PE1**

### 1. 4-Way Cassette Type S-100PU2E5A / U-100PE1E5A

| INDOOR   |  | MODEL              | S-100PU2E5A                                 |  |          | -                                   |              |              | -              |       |        |  |
|--|--|--------------------|---|--|----------|-------------------------------------|--------------|--------------|----------------|-------|--------|--|
| PANEL  |  | MODEL              | Standard type:CZ-KPU3:ECONAVI type:CZ-KPU3A |  |          | -                                   |              |              | -              |       |        |  |
| OUTDOOR  |  | MODEL              | -   |  |          | U-100PE1E5A                         |              |              | -              |       |        |  |
| Branch pipe  |  | MODEL              | -   |  |          | -                                   |              |              | -              |       |        |  |
| Performance test condition                               |  |                    | ISO5151 / EN14511 / EN12102 / EN14825       |  |          |                                     |              |              |                |       |        |  |
| C<br>O<br>O<br>L<br>I<br>N<br>G                          | Power supply                             |                    | 1Ø 50Hz                                     |  |          | 1Ø 50Hz                             |              |              |                |       |        |  |
|  |  |                    | Ø, Hz                                       |  |          |                                     |              |              |                |       |        |  |
|  |  |                    | V   | 220V   | 230V     | 240V                                | 220V         | 230V         | 240V           | Min   | Max    |  |
|  | Capacity                                 |                    | kW  | 10.0   | 10.0     | 10.0                                | -            | -            | -              | 3.3   | 12.5   |  |
|  |  |                    | BTU/h                                       | 34100  | 34100    | 34100                               | -            | -            | -              | 11300 | 42700  |  |
|  | Current                                  |                    | A   | 0.82   | 0.79     | 0.76                                | 10.5         | 10.1         | 9.7            | -     | -      |  |
|  | Input power                              |                    | W   | 100  | 100      | 100                                 | 2,240k       | 2,240k       | 2,240k         | -     | -      |  |
|  |  |                    | TOTAL W                                     | -  | -        | -                                   | 2,340k       | 2,340k       | 2,340k         | 770   | 3,700k |  |
|  | Annual consumption                       |                    | TOTAL kWh *4                                | -  | -        | -                                   | -            | 1170         | -              | -     | -      |  |
|  | EER/EER CLASS                            |                    | TOTAL (W/W) <sup>7</sup> ("A"-G)            | -  | -        | -                                   | 4.27         | 4.27/A       | 4.27           | 4.29  | 3.38   |  |
|  | E<br>r<br>p<br>*6                        | Pdesign            |   | kW   | -        | -                                   | -            | 10.0         | -              | -     | -      |  |
|  |  | SEER               |   | (W/W)  | -        | -                                   | -            | 7.6          | -              | -     | -      |  |
|  |  | Annual consumption |   | kWh  | -        | -                                   | -            | 461          | -              | -     | -      |  |
|  |  | Class              |   |  | -        | -                                   | -            | A++          | -              | -     | -      |  |
| Power factor   |  | %                  | -   | -  | -        | 97                                  | 96           | 96           | -              | -     |        |  |
| Noise indoor   |  | dB-A (H/M/L) *7    |   | 45/38/32   |          |                                     | -            |              |                | -     |        |  |
|  |  | Power Level dB     |   | 60/53/47   |          |                                     | -            |              |                | -     |        |  |
| Noise outdoor  |  | dB-A (H/L)         |   | -  |          |                                     | 52/-         |              |                | -     |        |  |
|  |  | Power Level dB     |   | -  |          |                                     | 69/-         |              |                | -     |        |  |
| H<br>E<br>A<br>T<br>I<br>N<br>G                          | Capacity                                 |                    | kW  | 11.2   | 11.2     | 11.2                                | -            | -            | -              | 4.1   | 14.0   |  |
|  |  |                    | BTU/h                                       | 38200  | 38200    | 38200                               | -            | -            | -              | 14000 | 47800  |  |
|  | Current                                  |                    | A   | 0.81   | 0.78     | 0.75                                | 10.1         | 9.7          | 9.4            | -     | -      |  |
|  | Input power                              |                    | W   | 95   | 95       | 95                                  | 2,145k       | 2,145k       | 2,145k         | -     | -      |  |
|  |  |                    | TOTAL W                                     | -  | -        | -                                   | 2,240k       | 2,240k       | 2,240k         | 790   | 4,400k |  |
|  | COP/COP CLASS                            |                    | TOTAL (W/W) <sup>7</sup> ("A"-G)            | -  | -        | -                                   | 5.00         | 5.00/A       | 5.00           | 5.19  | 3.18   |  |
|  | E<br>r<br>p<br>*6                        | Pdesign at -10°C   |   | kW   | -        | -                                   | -            | 10.0         | -              | -     | -      |  |
|  |  | Tbivalent °C       |   |  | -        | -                                   | -            | -10          | -              | -     | -      |  |
|  |  | SCOP               |   | (W/W)  | -        | -                                   | -            | 4.8          | -              | -     | -      |  |
|  |  | Annual consumption |   | kWh  | -        | -                                   | -            | 2917         | -              | -     | -      |  |
|  | Class                                    |                    |   | -  | -        | -                                   | A++          | -            | -              | -     |        |  |
|  | Power factor                             |                    | %   | -  | -        | -                                   | 97           | 96           | 95             | -     | -      |  |
|  | Noise indoor                             |                    | dB-A (H/M/L) *7                             |  | 45/38/32 |                                     |              | -            |                |       | -      |  |
|  |  |                    | Power Level dB                              |  | 60/53/47 |                                     |              | -            |                |       | -      |  |
| Noise outdoor  |  | dB-A (H/L)         |   | -  |          |                                     | 52/-         |              |                | -     |        |  |
|  |  | Power Level dB     |   | -  |          |                                     | 69/-         |              |                | -     |        |  |
| EXTRA LOW TEMP Total capacity(kW) / Input power(W) / COP |  |                    | -   |  |          |                                     |              |              |                | -     |        |  |
| Max Current(A) / Max Input power(W)                      |  |                    | 0.82/100                                    | 0.79/100   | 0.76/100 | 25.0 / 5.35k                        | 25.0 / 5.55k | 25.0 / 5.75k | -              |       |        |  |
| Starting current(A) / Comp output(W)                     |  |                    | -   | -  | -        | 10.5 / 3.0k                         | 10.1 / 3.0k  | 9.7 / 3.0k   | -              |       |        |  |
| Network Impedance(ΩMAX.)                                 |  |                    | -   |  |          |                                     |              |              |                | -     |        |  |
| Fan motor output (Indoor/Outdoor) W                      |  |                    | 90  |  |          | 90 ×2                               |              |              | -              |       |        |  |
| Moisture removal volume                                  |  | L/h(Pt/h)          | 2.7   |  |          | (5.7)                               |              |              | -              |       |        |  |
| External static pressure                                 |  |                    | Pa  |  |          | -                                   |              |              | -              |       |        |  |
| Indoor Air flow *7                                       | Cooling                                  | m³/min (ft³/min)   | 36.0/26.0/18.0 (1271)/(918)/(636)           |  |          | -                                   |              |              | -              |       |        |  |
|  | Heating                                  | m³/min (ft³/min)   | 36.0/26.0/18.0 (1271)/(918)/(636)           |  |          | -                                   |              |              | -              |       |        |  |
| Outdoor Air flow   | Cooling                                  | m³/min (ft³/min)   | -   |  |          | 110 (3885)                          |              |              | -              |       |        |  |
|  | Heating                                  | m³/min (ft³/min)   | -   |  |          | 95 (3355)                           |              |              | -              |       |        |  |
| Refrigerant type / amount g(oz)                          |  |                    | -   |  |          | R410A 3.40k (119.9)                 |              |              | -              |       |        |  |
| Product dimension  |  | Height mm(inch)    | 319   |  |          | (12-9/16)                           |              |              | 1416 (55-3/4)  |       |        |  |
|  |  | Width mm(inch)     | 840   |  |          | (33-5/64)                           |              |              | 940 (37-1/32)  |       |        |  |
|  |  | Depth mm(inch)     | 840   |  |          | (33-5/64)                           |              |              | 340 (13-13/32) |       |        |  |
| Product dimension (Panel)                                |  | H×W×D mm, inch     | 33.5×950×950                                |  |          | 1-11/32 × 37-13/32 × 37-13/32       |              |              | -              |       |        |  |
| Packing dimension  |  | Height mm(inch)    | 365   |  |          | (14-3/8)                            |              |              | 1556           |       |        |  |
|  |  | Width mm(inch)     | 898   |  |          | (35-3/8)                            |              |              | 1055           |       |        |  |
|  |  | Depth mm(inch)     | 898   |  |          | (35-3/8)                            |              |              | 485            |       |        |  |
| Weight   |  | (NET) kg(lb)       | 25  |  |          | (55)                                |              |              | 98 (216)       |       |        |  |
|  |  | (GROSS) kg(lb)     | 32  |  |          | (71)                                |              |              | 108 (238)      |       |        |  |
|  |  | Panel (NET) kg(lb) | 5   |  |          | (11)                                |              |              | -              |       |        |  |
| Layers limit (actually)                                  |  |                    | 11 (12)                                     |  |          | 1 (2)                               |              |              | -              |       |        |  |
| Operation condition                                      |  | Cool (DBT)         | 18°C ~ 32°C                                 |  |          | -15°C ~ 46°C                        |              |              | -              |       |        |  |
|  |  | Heat (DBT)         | 16°C ~ 30°C                                 |  |          | -20°C ~ 24°C                        |              |              | -              |       |        |  |
| P<br>I<br>P<br>I<br>N<br>G                               | Pipe diameter mm (inch)                  |                    | (Liquid)Ø9.52(3/8) (Gas)Ø15.88(5/8)         |  |          | (Liquid)Ø9.52(3/8) (Gas)Ø15.88(5/8) |              |              | -              |       |        |  |
|  | Connecting method, Standard length m(ft) |                    | flared type, 5.0(16.4)                      |  |          | flared type, 5.0(16.4)              |              |              | -              |       |        |  |
| Pipe length range  |  | m (ft)             |   | 5 ~ 75m (16.4 ~ 246.1)                                   |          |                                     |              |              |                |       |        |  |
| Indoor unit & Outdoor unit height difference             |  | m (ft)             |   | 15m(OD located lower)/30m(OD located higher) (49.2/98.4) |          |                                     |              |              |                |       |        |  |
| Add gas amount   |  | g/m (oz/ft)        |   | 50g (0.538)  |          |                                     |              |              |                |       |        |  |
| Pipe length for additional gas                           |  | m (ft)             |   | 30m (98.4)   |          |                                     |              |              |                |       |        |  |

\*1 In case it is necessary to indicate the air flow volume in (l/s), the value in (m³/min.) shall be multiplied by 16.7 and rounded down the decimal point.

\*2 If the EUROVENT Certified models can be operated under the "extra-low" temperature condition, -7°C dry bulb and -8°C wet-bulb temperatures with rated voltage 230V shall be used.

\*3 Network Impedance shall be applicable for EUROPE and CHINA models.

\*4 The annual consumption is calculated by multiplying the input power at 230V(400V) by an average of 500 hours per year in cooling mode.

\*5 EER and COP classification is at 230V(400V) only in accordance with EU directive 2002/31/EC.

\*6 SEER and SCOP classification is at 230V(400V) only in accordance with EN-14825. For heating, SCOP indicates the value of only Average heating season, Other fiche data indicates in an attached sheet.

\*7 H: High at setting 5 stage (Level 5), M: Middle at setting 5 stage (Level 3), L: Low at setting 5 stage (Level 1)

# Single-Type

## 1-1. Unit Specifications

PE1

### 1. 4-Way Cassette Type S-125PU2E5A / U-125PE1E5A

| INDOOR   |                    | MODEL  | S-125PU2E5A                                 |          |                                     | -                   |                |              | -      |       |        |  |
|--|--------------------|--|---|----------|-------------------------------------|---------------------|----------------|--------------|--------|-------|--------|--|
| PANEL  |                    | MODEL  | Standard type:CZ-KPU3:ECONAVI type:CZ-KPU3A |          |                                     | -                   |                |              | -      |       |        |  |
| OUTDOOR  |                    | MODEL  | -   |          |                                     | U-125PE1E5A         |                |              | -      |       |        |  |
| Branch pipe  |                    | MODEL  | -   |          |                                     | -                   |                |              | -      |       |        |  |
| Performance test condition                               |                    |  | ISO5151 / EN14511 / EN12102 / EN14825       |          |                                     |                     |                |              |        |       |        |  |
| C<br>O<br>O<br>L<br>I<br>N<br>G                          | Power supply       |  | 1Ø 50Hz                                     |          |                                     | 1Ø 50Hz             |                |              |        |       |        |  |
|  |                    |  | Ø, Hz                                       |          |                                     |                     |                |              |        |       |        |  |
|  |                    |  | V   | 220V     | 230V                                | 240V                | 220V           | 230V         | 240V   | Min   | Max    |  |
|  | Capacity           |  | kW  | 12.5     | 12.5                                | 12.5                | -              | -            | -      | 3.3   | 14.0   |  |
|  |                    |  | BTU/h                                       | 42700    | 42700                               | 42700               | -              | -            | -      | 11300 | 47800  |  |
|  | Current            |  | A   | 0.91     | 0.88                                | 0.85                | 15.2           | 14.7         | 14.3   | -     | -      |  |
|  | Input power        |  | W   | 110      | 110                                 | 110                 | 3.260k         | 3.260k       | 3.260k | -     | -      |  |
|  |                    |  | TOTAL W                                     | -        | -                                   | -                   | 3.370k         | 3.370k       | 3.370k | 770   | 4.600k |  |
|  | Annual consumption |  | TOTAL kWh *4                                | -        | -                                   | -                   | -              | 1685         | -      | -     | -      |  |
|  | EER/EER CLASS      |  | TOTAL (W/W) *5 / ("A"-G)                    | -        | -                                   | -                   | 3.70           | 3.70/A       | 3.70   | 4.29  | 3.04   |  |
|  | E<br>r<br>p<br>*6  | Pdesign  |   | kW       | -                                   | -                   | -              | -            | 12.5   | -     | -      |  |
|  |                    | η <sub>s.c</sub>   |   | %        | -                                   | -                   | -              | -            | 273.4  | -     | -      |  |
|  |                    | Annual consumption                                       |   | kWh      | -                                   | -                   | -              | -            | -      | -     | -      |  |
|  |                    | Class  |   |          | -                                   | -                   | -              | -            | -      | -     | -      |  |
| Power factor   |                    | %  | -   | -        | -                                   | 97                  | 96             | 95           | -      | -     |        |  |
| Noise indoor   |                    | dB-A (H/M/L) *7  |   | 46/39/33 |                                     |                     |                |              |        |       |        |  |
|  |                    | Power Level dB   |   | 61/54/48 |                                     |                     |                |              |        |       |        |  |
| Noise outdoor  |                    | dB-A (H/L)   |   |          |                                     |                     | 53/-           |              |        |       |        |  |
|  |                    | Power Level dB   |   |          |                                     |                     | 70/-           |              |        |       |        |  |
| H<br>E<br>A<br>T<br>I<br>N<br>G                          | Capacity           |  | kW  | 14.0     | 14.0                                | 14.0                | -              | -            | -      | 4.1   | 16.0   |  |
|  |                    |  | BTU/h                                       | 47800    | 47800                               | 47800               | -              | -            | -      | 14000 | 54600  |  |
|  | Current            |  | A   | 0.90     | 0.87                                | 0.84                | 13.7           | 13.3         | 12.9   | -     | -      |  |
|  | Input power        |  | W   | 105      | 105                                 | 105                 | 2.935k         | 2.935k       | 2.935k | -     | -      |  |
|  |                    |  | TOTAL W                                     | -        | -                                   | -                   | 3.040k         | 3.040k       | 3.040k | 790   | 5.040k |  |
|  | COP/COP CLASS      |  | TOTAL (W/W) *5 / ("A"-G)                    | -        | -                                   | -                   | 4.60           | 4.60/A       | 4.60   | 5.19  | 3.17   |  |
|  | E<br>r<br>p<br>*6  | Pdesign at -10°C   |   | kW       | -                                   | -                   | -              | -            | 12.5   | -     | -      |  |
|  |                    | Tbivalent  |   | °C       | -                                   | -                   | -              | -            | -10    | -     | -      |  |
|  |                    | η <sub>s.h</sub>   |   | %        | -                                   | -                   | -              | -            | 160.9  | -     | -      |  |
|  |                    | Annual consumption                                       |   | kWh      | -                                   | -                   | -              | -            | -      | -     | -      |  |
|  | Class              |  |   | -        | -                                   | -                   | -              | -            | -      | -     |        |  |
|  | Power factor       |  | %   | -        | -                                   | -                   | 97             | 96           | 95     | -     | -      |  |
|  | Noise indoor       |  | dB-A (H/M/L) *7                             |          | 46/39/33                            |                     |                |              |        |       |        |  |
|  |                    |  | Power Level dB                              |          | 61/54/48                            |                     |                |              |        |       |        |  |
| Noise outdoor  |                    | dB-A (H/L)   |   |          |                                     |                     | 53/-           |              |        |       |        |  |
|  |                    | Power Level dB   |   |          |                                     |                     | 70/-           |              |        |       |        |  |
| EXTRA LOW TEMP Total capacity(kW) / Input power(W) / COP |                    |  |   |          |                                     |                     |                |              |        |       |        |  |
| Max Current(A) / Max Input power(W)                      |                    |  | 0.91/110                                    | 0.88/110 | 0.85/110                            | 28.0 / 6.00k        | 28.0 / 6.20k   | 28.0 / 6.40k |        |       |        |  |
| Starting current(A) / Comp output(W)                     |                    |  | -   | -        | -                                   | 15.2 / 3.0k         | 14.7 / 3.0k    | 14.3 / 3.0k  |        |       |        |  |
| Network Impedance(ΩMAX.)                                 |                    |  |   |          |                                     |                     |                |              |        |       |        |  |
| Fan motor output (Indoor/Outdoor) W                      |                    |  | 90  |          |                                     | 90 ×2               |                |              |        |       |        |  |
| Moisture removal volume                                  |                    |  | L/h(Pt/h)                                   |          | 4.8                                 | (10.1)              |                |              |        |       |        |  |
| External static pressure                                 |                    |  | Pa  |          |                                     |                     |                |              |        |       |        |  |
| Indoor Air flow *7                                       | Cooling            | m³/min (ft³/min)   | 37.0/27.0/19.0 (1307)/(953)/(671)           |          |                                     |                     |                |              |        |       |        |  |
|  | Heating            | m³/min (ft³/min)   | 37.0/27.0/19.0 (1307)/(953)/(671)           |          |                                     |                     |                |              |        |       |        |  |
| Outdoor Air flow   | Cooling            | m³/min (ft³/min)   |   |          |                                     | 130 (4591)          |                |              |        |       |        |  |
|  | Heating            | m³/min (ft³/min)   |   |          |                                     | 110 (3885)          |                |              |        |       |        |  |
| Refrigerant type / amount g(oz)                          |                    |  |   |          |                                     | R410A 3.40k (119.9) |                |              |        |       |        |  |
| Product dimension  |                    | Height mm(inch)  | 319   |          | (12-9/16)                           |                     | 1416 (55-3/4)  |              |        |       |        |  |
|  |                    | Width mm(inch)   | 840   |          | (33-5/64)                           |                     | 940 (37-1/32)  |              |        |       |        |  |
|  |                    | Depth mm(inch)   | 840   |          | (33-5/64)                           |                     | 340 (13-13/32) |              |        |       |        |  |
| Product dimension (Panel)                                |                    | H×W×D mm, inch   | 33.5×950×950                                |          | 1-11/32 × 37-13/32 × 37-13/32       |                     |                |              |        |       |        |  |
| Packing dimension  |                    | Height mm(inch)  | 365   |          | (14-3/8)                            |                     | 1556           |              |        |       |        |  |
|  |                    | Width mm(inch)   | 898   |          | (35-3/8)                            |                     | 1055           |              |        |       |        |  |
|  |                    | Depth mm(inch)   | 898   |          | (35-3/8)                            |                     | 485            |              |        |       |        |  |
| Weight   |                    | (NET) kg(lb)   | 25  |          | (55)                                |                     | 98             |              | (216)  |       |        |  |
|  |                    | (GROSS) kg(lb)   | 32  |          | (71)                                |                     | 108            |              | (238)  |       |        |  |
|  |                    | Panel (NET) kg(lb)                                       | 5   |          | (11)                                |                     |                |              |        |       |        |  |
| Layers limit (actually)                                  |                    |  | 11 (12)                                     |          |                                     | 1 (2)               |                |              |        |       |        |  |
| Operation condition                                      |                    | Cool (DBT)   | 18°C ~ 32°C                                 |          |                                     | -15°C ~ 46°C        |                |              |        |       |        |  |
|  |                    | Heat (DBT)   | 16°C ~ 30°C                                 |          |                                     | -20°C ~ 24°C        |                |              |        |       |        |  |
| Pipe diameter mm (inch)                                  |                    | (Liquid)Ø9.52(3/8) (Gas)Ø15.88(5/8)                      |   |          | (Liquid)Ø9.52(3/8) (Gas)Ø15.88(5/8) |                     |                |              |        |       |        |  |
| Connecting method, Standard length m(ft)                 |                    | flared type, 5.0(16.4)                                   |   |          | flared type, 5.0(16.4)              |                     |                |              |        |       |        |  |
| Pipe length range m (ft)                                 |                    | 5 ~ 75m (16.4 ~246.1)                                    |   |          |                                     |                     |                |              |        |       |        |  |
| Indoor unit & Outdoor unit height difference m (ft)      |                    | 15m(OD located lower)/30m(OD located higher) (49.2/98.4) |   |          |                                     |                     |                |              |        |       |        |  |
| Add gas amount g/m (oz/ft)                               |                    | 50g (0.538)  |   |          |                                     |                     |                |              |        |       |        |  |
| Pipe length for additional gas m (ft)                    |                    | 30m (98.4)   |   |          |                                     |                     |                |              |        |       |        |  |

\*1 In case it is necessary to indicate the air flow volume in (l/s), the value in (m³/min.) shall be multiplied by 16.7 and rounded down the decimal point.  
 \*2 If the EUROVENT Certified models can be operated under the "extra-low" temperature condition, -7°C dry bulb and -8°C wet-bulb temperatures with rated voltage 230V shall be used.  
 \*3 Network Impedance shall be applicable for EUROPE and CHINA models.  
 \*4 The annual consumption is calculated by multiplying the input power at 230V(400V) by an average of 500 hours per year in cooling mode.  
 \*5 EER and COP classification is at 230V(400V) only in accordance with EU directive 2002/31/EC.  
 \*6 SEER and SCOP classification is at 230V(400V) only in accordance with EN-14825. For heating, SCOP indicates the value of only Average heating season.  
 \*7 H: High at setting 5 stage (Level 5), M: Middle at setting 5 stage (Level 3), L: Low at setting 5 stage (Level 1)

# Single-Type

## 1-1. Unit Specifications

**PE1**

### 1. 4-Way Cassette Type S-140PU2E5A / U-140PE1E5A

| INDOOR                                       |  | MODEL                                     | S-140PU2E5A                                 |  |                                     | -              |              |        | -      |       |        |
|--|--|---|---|--|-------------------------------------|----------------|--------------|--------|--------|-------|--------|
| PANEL  |  | MODEL                                     | Standard type:CZ-KPU3:ECONAVI type:CZ-KPU3A |  |                                     | -              |              |        | -      |       |        |
| OUTDOOR                                      |  | MODEL                                     | -   |  |                                     | U-140PE1E5A    |              |        | -      |       |        |
| Branch pipe                                  |  | MODEL                                     | -   |  |                                     | -              |              |        | -      |       |        |
| Performance test condition                   |  | ISO5151 / EN14511 / EN12102 / EN14825     |   |  |                                     |                |              |        |        |       |        |
| C<br>O<br>L<br>L<br>I<br>N<br>G              | Power supply                             |   | 1Ø 50Hz                                     |  |                                     | 1Ø 50Hz        |              |        |        |       |        |
|  |  |   | Ø, Hz                                       |  |                                     |                |              |        |        |       |        |
|  |  |   | V   | 220V   | 230V                                | 240V           | 220V         | 230V   | 240V   | Min   | Max    |
|  | Capacity                                 |   | kW  | 14.0   | 14.0                                | 14.0           | -            | -      | -      | 3.3   | 15.5   |
|  |  |   | BTU/h                                       | 47800  | 47800                               | 47800          | -            | -      | -      | 11300 | 52900  |
|  | Current                                  |   | A   | 0.97   | 0.94                                | 0.91           | 19.3         | 18.6   | 18.0   | -     | -      |
|  | Input power                              |   | W   | 120  | 120                                 | 120            | 4.120k       | 4.120k | 4.120k | -     | -      |
|  |  |   | TOTAL W                                     | -  | -                                   | -              | 4.240k       | 4.240k | 4.240k | 770   | 5.740k |
|  | Annual consumption                       |   | TOTAL kWh *4                                | -  | -                                   | -              | -            | 2120   | -      | -     | -      |
|  | EER/EER CLASS                            |   | TOTAL (W/W) *5 / ("A"-G)                    | -  | -                                   | -              | 3.30         | 3.30/A | 3.30   | 4.29  | 2.70   |
|  | Erp *6                                   |   | Pdesign kW                                  | -  | -                                   | -              | -            | 14.0   | -      | -     | -      |
|  |  |   | η <sub>s.c</sub> %                          | -  | -                                   | -              | -            | 257.7  | -      | -     | -      |
|  |  |   | Annual consumption kWh                      | -  | -                                   | -              | -            | -      | -      | -     | -      |
|  |  |   | Class                                       | -  | -                                   | -              | -            | -      | -      | -     | -      |
| Power factor                                 |  | %   | -   | -  | -                                   | 97             | 96           | 95     | -      | -     |        |
| Noise indoor                                 |  | dB-A (H/M/L) *7                           | 47/40/34                                    |  |                                     | -              |              |        | -      | -     |        |
|  |  | Power Level dB                            | 62/55/49                                    |  |                                     | -              |              |        | -      | -     |        |
| Noise outdoor                                |  | dB-A (H/L)                                | -   |  |                                     | 54/-           |              |        | -      | -     |        |
|  |  | Power Level dB                            | -   |  |                                     | 71/-           |              |        | -      | -     |        |
| H<br>E<br>A<br>T<br>I<br>N<br>G              | Capacity                                 |   | kW  | 16.0   | 16.0                                | 16.0           | -            | -      | -      | 4.1   | 18.0   |
|  |  |   | BTU/h                                       | 54600  | 54600                               | 54600          | -            | -      | -      | 14000 | 61400  |
|  | Current                                  |   | A   | 0.96   | 0.93                                | 0.90           | 16.9         | 16.3   | 15.8   | -     | -      |
|  | Input power                              |   | W   | 115  | 115                                 | 115            | 3.605k       | 3.605k | 3.605k | -     | -      |
|  |  |   | TOTAL W                                     | -  | -                                   | -              | 3.720k       | 3.720k | 3.720k | 790   | 5.720k |
|  | COP/COP CLASS                            |   | TOTAL (W/W) *5 / ("A"-G)                    | -  | -                                   | -              | 4.30         | 4.30/A | 4.30   | 5.19  | 3.15   |
|  | Erp *6                                   |   | Pdesign at -10°C kW                         | -  | -                                   | -              | -            | 14.0   | -      | -     | -      |
|  |  |   | Tbivalent °C                                | -  | -                                   | -              | -            | -7     | -      | -     | -      |
|  |  |   | η <sub>s.h</sub> %                          | -  | -                                   | -              | -            | 152.9  | -      | -     | -      |
|  |  |   | Annual consumption kWh                      | -  | -                                   | -              | -            | -      | -      | -     | -      |
|  |  |   | Class                                       | -  | -                                   | -              | -            | -      | -      | -     | -      |
|  | Power factor                             |   | %   | -  | -                                   | -              | 97           | 96     | 95     | -     | -      |
|  | Noise indoor                             |   | dB-A (H/M/L) *7                             | 47/40/34   |                                     |                | -            |        |        | -     | -      |
|  |  |   | Power Level dB                              | 62/55/49   |                                     |                | -            |        |        | -     | -      |
| Noise outdoor                                |  | dB-A (H/L)                                | -   |  |                                     | 55/-           |              |        | -      | -     |        |
|  |  | Power Level dB                            | -   |  |                                     | 71/-           |              |        | -      | -     |        |
| EXTRA LOW TEMP                               |  | Total capacity(kW) / Input power(W) / COP | -   |  |                                     |                |              |        |        |       |        |
| Max Current(A) / Max Input power(W)          |  | 0.97/120                                  | 0.94/120                                    | 0.91/120   | 30.0 / 6.45k                        | 30.0 / 6.65k   | 30.0 / 6.85k | -      |        |       |        |
| Starting current(A) / Comp output(W)         |  | -   | -   | -  | 19.3 / 3.0k                         | 18.6 / 3.0k    | 18.0 / 3.0k  | -      |        |       |        |
| Network Impedance(ΩMAX.)                     |  | -   |   |  |                                     |                |              |        |        |       |        |
| Fan motor output (Indoor/Outdoor) W          |  | 90  |   |  | 90 × 2                              |                |              | -      |        |       |        |
| Moisture removal volume                      |  | L/h(Pt/h)                                 | 6.0   | (12.6)   |                                     | -              |              |        | -      |       |        |
| External static pressure                     |  | Pa  | -   |  |                                     | -              |              |        | -      |       |        |
| Indoor Air flow *7                           | Cooling                                  | m³/min (ft³/min)                          | 38.0/29.0/20.0 (1342)/(1024)/(706)          |  |                                     | -              |              |        | -      | -     |        |
|  | Heating                                  | m³/min (ft³/min)                          | 38.0/29.0/20.0 (1342)/(1024)/(706)          |  |                                     | -              |              |        | -      | -     |        |
| Outdoor Air flow                             | Cooling                                  | m³/min (ft³/min)                          | -   |  |                                     | 135 (4767)     |              |        | -      | -     |        |
|  | Heating                                  | m³/min (ft³/min)                          | -   |  |                                     | 120 (4238)     |              |        | -      | -     |        |
| Refrigerant type / amount g(oz)              |  | -   |   |  | R410A 3.40k (119.9)                 |                |              | -      |        |       |        |
| Product dimension                            | Height                                   | mm(inch)                                  | 319   | (12-9/16)  |                                     | 1416 (55-3/4)  |              |        | -      |       |        |
|  | Width                                    | mm(inch)                                  | 840   | (33-5/64)  |                                     | 940 (37-1/32)  |              |        | -      |       |        |
|  | Depth                                    | mm(inch)                                  | 840   | (33-5/64)  |                                     | 340 (13-13/32) |              |        | -      |       |        |
| Product dimension (Panel)                    |  | H×W×D mm, inch                            | 33.5×950×950                                |  | 1-11/32 × 37-13/32 × 37-13/32       |                | -            |        |        |       |        |
| Packing dimension                            | Height                                   | mm(inch)                                  | 365   | (14-3/8)   |                                     | 1556           |              |        | -      |       |        |
|  | Width                                    | mm(inch)                                  | 898   | (35-3/8)   |                                     | 1055           |              |        | -      |       |        |
|  | Depth                                    | mm(inch)                                  | 898   | (35-3/8)   |                                     | 485            |              |        | -      |       |        |
| Weight                                       | (NET)                                    | kg(lb)                                    | 25  | (55)   |                                     | 98             | (216)        |        | -      |       |        |
|  | (GROSS)                                  | kg(lb)                                    | 32  | (71)   |                                     | 108            | (238)        |        | -      |       |        |
|  | Panel (NET)                              | kg(lb)                                    | 5   | (11)   |                                     | -              |              |        | -      |       |        |
| Layers limit (actually)                      |  | 11 (12)                                   |   |  | 1 (2)                               |                |              | -      |        |       |        |
| Operation condition                          | Cool (DBT)                               | 18°C ~ 32°C                               |   |  | -15°C ~ 46°C                        |                |              | -      |        |       |        |
|  | Heat (DBT)                               | 16°C ~ 30°C                               |   |  | -20°C ~ 24°C                        |                |              | -      |        |       |        |
| P<br>I<br>P<br>I<br>N<br>G                   | Pipe diameter mm (inch)                  | (Liquid)Ø9.52(3/8) (Gas)Ø15.88(5/8)       |   |  | (Liquid)Ø9.52(3/8) (Gas)Ø15.88(5/8) |                |              | -      |        |       |        |
|  | Connecting method, Standard length m(ft) | flared type, 5.0(16.4)                    |   |  | flared type, 5.0(16.4)              |                |              | -      |        |       |        |
| Pipe length range                            |  | m (ft)                                    |   | 5 ~ 75m (16.4 ~ 246.1)                                   |                                     |                |              |        |        |       |        |
| Indoor unit & Outdoor unit height difference |  | m (ft)                                    |   | 15m(OD located lower)/30m(OD located higher) (49.2/98.4) |                                     |                |              |        |        |       |        |
| Add gas amount                               |  | g/m (oz/ft)                               |   | 50g (0.538)  |                                     |                |              |        |        |       |        |
| Pipe length for additional gas               |  | m (ft)                                    |   | 30m (98.4)   |                                     |                |              |        |        |       |        |

\*1 In case it is necessary to indicate the air flow volume in (l/s), the value in (m³/min.) shall be multiplied by 16.7 and rounded down the decimal point.

\*2 If the EUROVENT Certified models can be operated under the "extra-low" temperature condition, -7°C dry bulb and -8°C wet-bulb temperatures with rated voltage 230V shall be used.

\*3 Network Impedance shall be applicable for EUROPE and CHINA models.

\*4 The annual consumption is calculated by multiplying the input power at 230V(400V) by an average of 500 hours per year in cooling mode.

\*5 EER and COP classification is at 230V(400V) only in accordance with EU directive 2002/31/EC.

\*6 SEER and SCOP classification is at 230V(400V) only in accordance with EN-14825. For heating, SCOP indicates the value of only Average heating season.

\*7 H: High at setting 5 stage (Level 5), M: Middle at setting 5 stage (Level 3), L: Low at setting 5 stage (Level 1)

# Simultaneous (Twin) -Type

## 1-1. Unit Specifications

PE1

### 1. 4-Way Cassette Type S-36PU2E5A×2 / U-71PE1E8A

| INDOOR   |  | MODEL  | S-36PU2E5A×2                                      |             |                                     | -              |              |        | -     |        |
|--|--|--|---|-------------|-------------------------------------|----------------|--------------|--------|-------|--------|
| PANEL  |  | MODEL  | Standard type:CZ-KPU3×2 / ECONAVI type:CZ-KPU3A×2 |             |                                     | -              |              |        | -     |        |
| OUTDOOR  |  | MODEL  | -   |             |                                     | U-71PE1E8A     |              |        | -     |        |
| Branch pipe  |  | MODEL  | -   |             |                                     | CZ-P155BK1     |              |        | -     |        |
| Performance test condition                               |  | ISO5151 / EN14511 / EN12102 / EN14825                    |   |             |                                     |                |              |        |       |        |
| C<br>O<br>O<br>L<br>I<br>N<br>G                          | Power supply                             | ∅, Hz  | 1∅ 50Hz   |             |                                     | 3∅ 50Hz        |              |        | Min   | Max    |
|  |  | V  | 220V  | 230V        | 240V                                | 380V           | 400V         | 415V   |       |        |
|  | Capacity                                 | kW   | 7.1   | 7.1         | 7.1                                 | -              | -            | -      | 3.2   | 8.0    |
|  |  | BTU/h  | 24200   | 24200       | 24200                               | -              | -            | -      | 10900 | 27300  |
|  | Current                                  | A  | 0.23 ×2   | 0.23 ×2     | 0.22 ×2                             | 2.85           | 2.70         | 2.60   | -     | -      |
|  |  | W  | 24 ×2   | 24 ×2       | 24 ×2                               | 1.762k         | 1.762k       | 1.762k | -     | -      |
|  | Input power                              | TOTAL W  | -   | -           | -                                   | 1.810k         | 1.810k       | 1.810k | 560   | 2.650k |
|  |  | Annual consumption                                       | TOTAL kWh *4                                      | -           | -                                   | -              | -            | 905    | -     | -      |
|  | EER/EEER CLASS                           | TOTAL (W/W) <sup>*5</sup> ("A"-G)                        | -   | -           | -                                   | 3.92           | 3.92/A       | 3.92   | 5.71  | 3.02   |
|  | Erp <sup>*6</sup>                        | Pdesign  | kW  | -           | -                                   | -              | -            | 7.1    | -     | -      |
|  |  | SEER   | (W/W)   | -           | -                                   | -              | -            | 7.1    | -     | -      |
|  |  | Annual consumption                                       | kWh   | -           | -                                   | -              | -            | 350    | -     | -      |
|  |  | Class  |   | -           | -                                   | -              | -            | A++    | -     | -      |
|  | Power factor                             | %  | -   | -           | -                                   | 94             | 94           | 94     | -     | -      |
| Noise indoor   | dB-A (H/M/L) *7                          | 30/28/27   |   |             | -                                   |                |              | -      | -     |        |
|  | Power Level dB                           | 45/43/42   |   |             | -                                   |                |              | -      | -     |        |
| Noise outdoor  | dB-A (H/L)                               | -  |   |             | 48/-                                |                |              | -      | -     |        |
|  | Power Level dB                           | -  |   |             | 65/-                                |                |              | -      | -     |        |
| H<br>E<br>A<br>T<br>I<br>N<br>G                          | Capacity                                 | kW   | 8.0   | 8.0         | 8.0                                 | -              | -            | -      | 2.8   | 9.0    |
|  |  | BTU/h  | 27300   | 27300       | 27300                               | -              | -            | -      | 9600  | 30700  |
|  | Current                                  | A  | 0.22 ×2   | 0.22 ×2     | 0.21 ×2                             | 2.95           | 2.80         | 2.70   | -     | -      |
|  |  | W  | 22 ×2   | 22 ×2       | 22 ×2                               | 1.826k         | 1.826k       | 1.826k | -     | -      |
|  | Input power                              | TOTAL W  | -   | -           | -                                   | 1.870k         | 1.870k       | 1.870k | 500   | 2.850k |
|  |  | COP/COP CLASS  | TOTAL (W/W) <sup>*5</sup> ("A"-G)                 | -           | -                                   | -              | 4.28         | 4.28/A | 4.28  | 5.60   |
|  | Erp <sup>*6</sup>                        | Pdesign at -10°C   | kW  | -           | -                                   | -              | -            | 7.1    | -     | -      |
|  |  | Tbivalent  | °C  | -           | -                                   | -              | -            | -10    | -     | -      |
|  |  | SCOP   | (W/W)   | -           | -                                   | -              | -            | 4.3    | -     | -      |
|  |  | Annual consumption                                       | kWh   | -           | -                                   | -              | -            | 2312   | -     | -      |
|  | Class                                    |  | -   | -           | -                                   | -              | A+           | -      | -     |        |
|  | Power factor                             | %  | -   | -           | -                                   | 94             | 94           | 94     | -     | -      |
|  | Noise indoor                             | dB-A (H/M/L) *7  | 30/28/27  |             |                                     | -              |              |        | -     | -      |
|  |  | Power Level dB   | 45/43/42  |             |                                     | -              |              |        | -     | -      |
| Noise outdoor  | dB-A (H/L)                               | -  |   |             | 50/-                                |                |              | -      | -     |        |
|  | Power Level dB                           | -  |   |             | 67/-                                |                |              | -      | -     |        |
| EXTRA LOW TEMP Total capacity(kW) / Input power(W) / COP |  | -  |   |             |                                     |                |              |        |       |        |
| Max Current(A) / Max Input power(W)                      |  | 0.23×2/24×2  | 0.23×2/24×2                                       | 0.22×2/24×2 | 7.00 / 4.15k                        | 7.00 / 4.36k   | 7.00 / 4.53k | -      |       |        |
| Starting current(A) / Comp output(W)                     |  | -  | -   | -           | 2.95 / 2.0k                         | 2.80 / 2.0k    | 2.70 / 2.0k  | -      |       |        |
| Network Impedance(QMAX.)                                 |  | -  |   |             |                                     |                |              |        |       |        |
| Fan motor output (Indoor/Outdoor) W                      |  | 60   |   |             | 90                                  |                |              | -      |       |        |
| Moisture removal volume                                  |  | L/h(Pt/h)  | 1.4   | (0.7×2)     | (2.9)                               | -              |              |        | -     |        |
| External static pressure                                 |  | Pa   | -   |             |                                     | -              |              |        | -     |        |
| Indoor Air flow *7                                       | Cooling                                  | m³/min (ft³/min)   | 14.5×2/13.0×2/11.5×2 (512)×2/(459)×2/(406)×2      |             |                                     | -              |              |        | -     | -      |
|  | Heating                                  | m³/min (ft³/min)   | 14.5×2/13.0×2/11.5×2 (512)×2/(459)×2/(406)×2      |             |                                     | -              |              |        | -     | -      |
| Outdoor Air flow   | Cooling                                  | m³/min (ft³/min)   | -   |             |                                     | 60 (2119)      |              |        | -     | -      |
|  | Heating                                  | m³/min (ft³/min)   | -   |             |                                     | 60 (2119)      |              |        | -     | -      |
| Refrigerant type / amount g(oz)                          |  | -  |   |             | R410A 2.35k (82.9)                  |                |              | -      |       |        |
| Product dimension  | Height                                   | mm(inch)   | 256   | (10-5/64)   |                                     | 996 (39-7/32)  |              |        | -     |        |
|  | Width                                    | mm(inch)   | 840   | (33-5/64)   |                                     | 940 (37-1/32)  |              |        | -     |        |
|  | Depth                                    | mm(inch)   | 840   | (33-5/64)   |                                     | 340 (13-13/32) |              |        | -     |        |
| Product dimension (Panel)                                |  | H×W×D mm, inch   | 33.5×950×950                                      |             | 1-11/32 × 37-13/32 × 37-13/32       |                | -            |        |       |        |
| Packing dimension  | Height                                   | mm(inch)   | 302   | (11-57/64)  |                                     | 1136           |              |        | -     |        |
|  | Width                                    | mm(inch)   | 898   | (35-3/8)    |                                     | 1055           |              |        | -     |        |
|  | Depth                                    | mm(inch)   | 898   | (35-3/8)    |                                     | 485            |              |        | -     |        |
| Weight   | (NET)                                    | kg(lb)   | 19  | (42)        |                                     | 71             | (157)        |        | -     |        |
|  | (GROSS)                                  | kg(lb)   | 26  | (57)        |                                     | 79             | (174)        |        | -     |        |
|  | Panel (NET)                              | kg(lb)   | 5   | (11)        |                                     | -              |              |        | -     |        |
| Layers limit (actually)                                  |  | 11 (12)  |   |             | 2 (3)                               |                |              | -      |       |        |
| Operation condition                                      | Cool (DBT)                               | 18°C ~ 32°C  |   |             | -15°C ~ 46°C                        |                |              | -      |       |        |
|  | Heat (DBT)                               | 16°C ~ 30°C  |   |             | -20°C ~ 24°C                        |                |              | -      |       |        |
| P<br>I<br>P<br>I<br>N<br>G                               | Pipe diameter mm (inch)                  | (Liquid)∅6.35(1/4) (Gas)∅12.7(1/2)                       |   |             | (Liquid)∅9.52(3/8) (Gas)∅15.88(5/8) |                |              | -      |       |        |
|  | Connecting method, Standard length m(ft) | flared type, 5.0(16.4)                                   |   |             | flared type, 5.0(16.4)              |                |              | -      |       |        |
| Pipe length range  |  | m (ft) 5 ~ 50m (16.4 ~164)                               |   |             |                                     |                |              |        |       |        |
| Indoor unit & Outdoor unit height difference m (ft)      |  | 15m(OD located lower)/30m(OD located higher) (49.2/98.4) |   |             |                                     |                |              |        |       |        |
| Add gas amount g/m (oz/ft)                               |  | 50g (0.538)  |   |             |                                     |                |              |        |       |        |
| Pipe length for additional gas m (ft)                    |  | 30m (98.4)   |   |             |                                     |                |              |        |       |        |

\*1 In case it is necessary to indicate the air flow volume in (l/s), the value in (m³/min.) shall be multiplied by 16.7 and rounded down the decimal point.  
 \*2 If the EUROVENT Certified models can be operated under the "extra-low" temperature condition, -7°C dry bulb and -8°C wet-bulb temperatures with rated voltage 230V shall be used.  
 \*3 Network Impedance shall be applicable for EUROPE and CHINA models.  
 \*4 The annual consumption is calculated by multiplying the input power at 230V(400V) by an average of 500 hours per year in cooling mode.  
 \*5 EER and COP classification is at 230V(400V) only in accordance with EU directive 2002/31/EC.  
 \*6 SEER and SCOP classification is at 230V(400V) only in accordance with EN-14825. For heating, SCOP indicates the value of only Average heating season, Other fiche data indicates in an attached sheet.  
 \*7 H: High at setting 5 stage (Level 5), M: Middle at setting 5 stage (Level 3), L: Low at setting 5 stage (Level 1)

# Simultaneous (Triple) -Type

## 1-1. Unit Specifications

**PE1**

### 1. 4-Way Cassette Type S-36PU2E5A×3 / U-100PE1E8A

| INDOOR   |  | MODEL                                 | S-36PU2E5A×3  |  |                                     | -              |              |        | -     |        |      |
|--|--|---------------------------------------|---|--|-------------------------------------|----------------|--------------|--------|-------|--------|------|
| PANEL  |  | MODEL                                 | Standard type:CZ-KPU3 ×3 / ECONAVI type:CZ-KPU3A ×3 |  |                                     | -              |              |        | -     |        |      |
| OUTDOOR  |  | MODEL                                 | -   |  |                                     | U-100PE1E8A    |              |        | -     |        |      |
| Branch pipe  |  | MODEL                                 | -   |  |                                     | CZ-P3HPC2      |              |        | -     |        |      |
| Performance test condition                               |  | ISO5151 / EN14511 / EN12102 / EN14825 |   |  |                                     |                |              |        |       |        |      |
| C<br>O<br>O<br>L<br>I<br>N<br>G                          | Power supply                             | ∅, Hz                                 | 1∅ 50Hz   |  |                                     | 3∅ 50Hz        |              |        |       |        |      |
|  |  | V                                     | 220V  | 230V   | 240V                                | 380V           | 400V         | 415V   | Min   | Max    |      |
|  | Capacity                                 | kW                                    | 10.0  | 10.0   | 10.0                                | -              | -            | -      | 3.3   | 12.5   |      |
|  |  | BTU/h                                 | 34100   | 34100  | 34100                               | -              | -            | -      | 11300 | 42700  |      |
|  | Current                                  | A                                     | 0.23 ×3   | 0.23 ×3  | 0.22 ×3                             | 3.65           | 3.50         | 3.40   | -     | -      |      |
|  |  | W                                     | 24 ×3   | 24 ×3  | 24 ×3                               | 2.268k         | 2.268k       | 2.268k | -     | -      |      |
|  | Input power                              | TOTAL W                               | -   |  |                                     | 2.340k         | 2.340k       | 2.340k | 770   | 3.700k |      |
|  |  | Annual consumption                    | TOTAL kWh *4  | -  |                                     |                | -            | 1170   | -     | -      | -    |
|  | EER/EER CLASS                            | TOTAL (W/W) <sup>5</sup> ("A"-G)      | -   |  |                                     | 4.27           | 4.27/A       | 4.27   | 4.29  | 3.38   |      |
|  | E <sub>rp</sub> <sup>6</sup>             | Pdesign                               | kW  | -  |                                     |                | -            | 10.0   | -     | -      | -    |
| SEER   |  | (W/W)                                 | -   |  |                                     | -              | 7.1          | -      | -     | -      |      |
| Annual consumption                                       |  | kWh                                   | -   |  |                                     | -              | 493          | -      | -     | -      |      |
| Class  |  |                                       | -   |  |                                     | -              | A++          | -      | -     | -      |      |
| Power factor   | %  | -                                     |   |  | 94                                  | 94             | 93           | -      | -     |        |      |
| Noise indoor   | dB-A (H/M/L) *7                          | 30/28/27                              |   |  | -                                   |                |              | -      | -     |        |      |
|  | Power Level dB                           | 45/43/42                              |   |  | -                                   |                |              | -      | -     |        |      |
| Noise outdoor  | dB-A (H/L)                               | -                                     |   |  | 52/-                                |                |              | -      | -     |        |      |
|  | Power Level dB                           | -                                     |   |  | 69/-                                |                |              | -      | -     |        |      |
| H<br>E<br>A<br>T<br>I<br>N<br>G                          | Capacity                                 | kW                                    | 11.2  | 11.2   | 11.2                                | -              | -            | -      | 4.1   | 14.0   |      |
|  |  | BTU/h                                 | 38200   | 38200  | 38200                               | -              | -            | -      | 14000 | 47800  |      |
|  | Current                                  | A                                     | 0.22 ×3   | 0.22 ×3  | 0.21×3                              | 3.50           | 3.35         | 3.25   | -     | -      |      |
|  |  | W                                     | 22 ×3   | 22 ×3  | 22 ×3                               | 2.174k         | 2.174k       | 2.174k | -     | -      |      |
|  | Input power                              | TOTAL W                               | -   |  |                                     | 2.240k         | 2.240k       | 2.240k | 790   | 4.400k |      |
|  |  | COP/COP CLASS                         | TOTAL (W/W) <sup>5</sup> ("A"-G)                    | -  |                                     |                | 5.00         | 5.00/A | 5.00  | 5.19   | 3.18 |
|  | E <sub>rp</sub> <sup>6</sup>             | Pdesign at -10°C                      | kW  | -  |                                     |                | -            | 10.0   | -     | -      | -    |
|  |  | Tbivalent                             | °C  | -  |                                     |                | -            | -10    | -     | -      | -    |
|  |  | SCOP                                  | (W/W)   | -  |                                     |                | -            | 4.8    | -     | -      | -    |
|  |  | Annual consumption                    | kWh   | -  |                                     |                | -            | 2917   | -     | -      | -    |
| Class  |  | -                                     |   |  | -                                   | A++            | -            | -      | -     |        |      |
| Power factor   | %  | -                                     |   |  | 94                                  | 94             | 93           | -      | -     |        |      |
| Noise indoor   | dB-A (H/M/L) *7                          | 30/28/27                              |   |  | -                                   |                |              | -      | -     |        |      |
|  | Power Level dB                           | 45/43/42                              |   |  | -                                   |                |              | -      | -     |        |      |
| Noise outdoor  | dB-A (H/L)                               | -                                     |   |  | 52/-                                |                |              | -      | -     |        |      |
|  | Power Level dB                           | -                                     |   |  | 69/-                                |                |              | -      | -     |        |      |
| EXTRA LOW TEMP Total capacity(kW) / Input power(W) / COP |  | -                                     |   |  |                                     |                |              |        |       |        |      |
| Max Current(A) / Max Input power(W)                      |  | 0.23×3/24×3                           | 0.23×3/24×3   | 0.22×3/24×3  | 9.00 / 5.55k                        | 9.00 / 5.85k   | 9.00 / 6.10k | -      |       |        |      |
| Starting current(A) / Comp output(W)                     |  | -                                     | -   | -  | 3.65 / 3.0k                         | 3.50 / 3.0k    | 3.40 / 3.0k  | -      |       |        |      |
| Network Impedance(ΩMAX.)                                 |  | -                                     |   |  |                                     |                |              |        |       |        |      |
| Fan motor output (Indoor/Outdoor) W                      |  | 60                                    |   |  | 90 ×2                               |                |              | -      |       |        |      |
| Moisture removal volume                                  |  | L/h(Pt/h)                             | 2.1   | (0.7×3)  | (4.4)                               | -              |              |        | -     |        |      |
| External static pressure                                 |  | Pa                                    | -   |  |                                     | -              |              |        | -     |        |      |
| Indoor Air flow *7                                       | Cooling                                  | m³/min (ft³/min)                      | 14.5×3/13.0×3/11.5×3 (512)×3/(459)×3/(406)×3        |  |                                     | -              |              |        | -     | -      |      |
|  | Heating                                  | m³/min (ft³/min)                      | 14.5×3/13.0×3/11.5×3 (512)×3/(459)×3/(406)×3        |  |                                     | -              |              |        | -     | -      |      |
| Outdoor Air flow   | Cooling                                  | m³/min (ft³/min)                      | -   |  |                                     | 110 (3885)     |              |        | -     | -      |      |
|  | Heating                                  | m³/min (ft³/min)                      | -   |  |                                     | 95 (3355)      |              |        | -     | -      |      |
| Refrigerant type / amount g(oz)                          |  | -                                     |   |  | R410A 3.40k (119.9)                 |                |              | -      |       |        |      |
| Product dimension  | Height                                   | mm(inch)                              | 256   | (10-5/64)  |                                     | 1416 (55-3/4)  |              |        | -     |        |      |
|  | Width                                    | mm(inch)                              | 840   | (33-5/64)  |                                     | 940 (37-1/32)  |              |        | -     |        |      |
|  | Depth                                    | mm(inch)                              | 840   | (33-5/64)  |                                     | 340 (13-13/32) |              |        | -     |        |      |
| Product dimension (Panel)                                |  | H×W×D mm, inch                        | 33.5×950×950  |  | 1-11/32 × 37-13/32 × 37-13/32       |                | -            |        |       |        |      |
| Packing dimension  | Height                                   | mm(inch)                              | 302   | (11-57/64)   |                                     | 1556           |              |        | -     |        |      |
|  | Width                                    | mm(inch)                              | 898   | (35-3/8)   |                                     | 1055           |              |        | -     |        |      |
|  | Depth                                    | mm(inch)                              | 898   | (35-3/8)   |                                     | 485            |              |        | -     |        |      |
| Weight   | (NET)                                    | kg(lb)                                | 19  | (42)   |                                     | 98             | (216)        |        | -     |        |      |
|  | (GROSS)                                  | kg(lb)                                | 26  | (57)   |                                     | 108            | (238)        |        | -     |        |      |
|  | Panel (NET)                              | kg(lb)                                | 5   | (11)   |                                     | -              |              |        | -     |        |      |
| Layers limit (actually)                                  |  | 11 (12)                               |   |  | 1 (2)                               |                |              | -      |       |        |      |
| Operation condition                                      | Cool (DBT)                               | 18°C ~ 32°C                           |   |  | -15°C ~ 46°C                        |                |              | -      |       |        |      |
|  | Heat (DBT)                               | 16°C ~ 30°C                           |   |  | -20°C ~ 24°C                        |                |              | -      |       |        |      |
| P<br>I<br>P<br>I<br>N<br>G                               | Pipe diameter mm (inch)                  | (Liquid)∅6.35(1/4) (Gas)∅12.7(1/2)    |   |  | (Liquid)∅9.52(3/8) (Gas)∅15.88(5/8) |                |              | -      |       |        |      |
|  | Connecting method, Standard length m(ft) | flared type, 5.0(16.4)                |   |  | flared type, 5.0(16.4)              |                |              | -      |       |        |      |
| Pipe length range  |  | m (ft)                                |   | 5 ~ 75m (16.4 ~ 246.1)                                   |                                     |                |              |        |       |        |      |
| Indoor unit & Outdoor unit height difference             |  | m (ft)                                |   | 15m(OD located lower)/30m(OD located higher) (49.2/98.4) |                                     |                |              |        |       |        |      |
| Add gas amount   |  | g/m (oz/ft)                           |   | 50g (0.538)  |                                     |                |              |        |       |        |      |
| Pipe length for additional gas                           |  | m (ft)                                |   | 30m (98.4)   |                                     |                |              |        |       |        |      |

\*1 In case it is necessary to indicate the air flow volume in (l/s), the value in (m³/min.) shall be multiplied by 16.7 and rounded down the decimal point.

\*2 If the EUROVENT Certified models can be operated under the "extra-low" temperature condition, -7°C dry bulb and -8°C wet-bulb temperatures with rated voltage 230V shall be used.

\*3 Network Impedance shall be applicable for EUROPE and CHINA models.

\*4 The annual consumption is calculated by multiplying the input power at 230V(400V) by an average of 500 hours per year in cooling mode.

\*5 EER and COP classification is at 230V(400V) only in accordance with EU directive 2002/31/EC.

\*6 SEER and SCOP classification is at 230V(400V) only in accordance with EN-14825. For heating, SCOP indicates the value of only Average heating season, Other fiche data indicates in an attached sheet.

\*7 H: High at setting 5 stage (Level 5), M: Middle at setting 5 stage (Level 3), L: Low at setting 5 stage (Level 1)



# Simultaneous (Double-Twin) -Type

## 1-1. Unit Specifications

**PE1**

### 1. 4-Way Cassette Type S-36PU2E5A×4 / U-125PE1E8A

| INDOOR                                       |  | MODEL                                     | S-36PU2E5A×4                                      |  |                                     | -              |              |        | -      |       |        |
|--|--|---|---|--|-------------------------------------|----------------|--------------|--------|--------|-------|--------|
| PANEL  |  | MODEL                                     | Standard type:CZ-KPU3×4 / ECONAVI type:CZ-KPU3A×4 |  |                                     | -              |              |        | -      |       |        |
| OUTDOOR                                      |  | MODEL                                     | -   |  |                                     | U-125PE1E8A    |              |        | -      |       |        |
| Branch pipe                                  |  | MODEL                                     | -   |  |                                     | CZ-P155BK1×3   |              |        | -      |       |        |
| Performance test condition                   |  | ISO5151 / EN14511 / EN12102 / EN14825     |   |  |                                     |                |              |        |        |       |        |
| C<br>O<br>L<br>L<br>I<br>N<br>G              | Power supply                             |   | 1Ø 50Hz   |  |                                     | 3Ø 50Hz        |              |        |        |       |        |
|  |  |   | Ø, Hz   |  |                                     |                |              |        |        |       |        |
|  |  |   | V   | 220V   | 230V                                | 240V           | 380V         | 400V   | 415V   | Min   | Max    |
|  | Capacity                                 |   | kW  | 12.5   | 12.5                                | 12.5           | -            | -      | -      | 3.3   | 14.0   |
|  |  |   | BTU/h   | 42700  | 42700                               | 42700          | -            | -      | -      | 11300 | 47800  |
|  | Current                                  |   | A   | 0.23×4   | 0.23×4                              | 0.22×4         | 5.30         | 5.05   | 4.85   | -     | -      |
|  | Input power                              |   | W   | 24×4   | 24×4                                | 24×4           | 3.274k       | 3.274k | 3.274k | -     | -      |
|  |  |   | TOTAL W   | -  |                                     |                | 3.370k       | 3.370k | 3.370k | 770   | 4.600k |
|  | Annual consumption                       |   | TOTAL kWh *4                                      | -  |                                     |                | -            | 1685   | -      | -     | -      |
|  | EER/EER CLASS                            |   | TOTAL (W/W) <sup>1/3</sup> ("A"-G)                | -  |                                     |                | 3.70         | 3.70/A | 3.70   | 4.29  | 3.04   |
|  | Erp *6                                   |   | Pdesign   | -  |                                     |                | -            | 12.5   | -      | -     | -      |
|  |  |   | η <sub>s.c</sub>                                  | -  |                                     |                | -            | 276.4  | -      | -     | -      |
|  |  |   | Annual consumption                                | -  |                                     |                | -            | -      | -      | -     | -      |
|  |  |   | Class   | -  |                                     |                | -            | -      | -      | -     | -      |
| Power factor                                 |  | %   | -   |  |                                     | 94             | 94           | 94     | -      | -     |        |
| Noise indoor                                 |  | dB-A (H/M/L) *7                           | 30/28/27  |  |                                     | -              |              |        | -      | -     |        |
|  |  | Power Level dB                            | 45/43/42  |  |                                     | -              |              |        | -      | -     |        |
| Noise outdoor                                |  | dB-A (H/L)                                | -   |  |                                     | 53/-           |              |        | -      | -     |        |
|  |  | Power Level dB                            | -   |  |                                     | 70/-           |              |        | -      | -     |        |
| H<br>E<br>A<br>T<br>I<br>N<br>G              | Capacity                                 |   | kW  | 14.0   | 14.0                                | 14.0           | -            | -      | -      | 4.1   | 16.0   |
|  |  |   | BTU/h   | 47800  | 47800                               | 47800          | -            | -      | -      | 14000 | 54600  |
|  | Current                                  |   | A   | 0.22×4   | 0.22×4                              | 0.21×4         | 4.75         | 4.55   | 4.35   | -     | -      |
|  | Input power                              |   | W   | 22×4   | 22×4                                | 22×4           | 2.952k       | 2.952k | 2.952k | -     | -      |
|  |  |   | TOTAL W   | -  |                                     |                | 3.040k       | 3.040k | 3.040k | 790   | 5.040k |
|  | COP/COP CLASS                            |   | TOTAL (W/W) <sup>1/3</sup> ("A"-G)                | -  |                                     |                | 4.60         | 4.60/A | 4.60   | 5.19  | 3.17   |
|  | Erp *6                                   |   | Pdesign at -10°C                                  | -  |                                     |                | -            | 12.5   | -      | -     | -      |
|  |  |   | Tbivalent   | -  |                                     |                | -            | -10    | -      | -     | -      |
|  |  |   | η <sub>s.h</sub>                                  | -  |                                     |                | -            | 161.0  | -      | -     | -      |
|  |  |   | Annual consumption                                | -  |                                     |                | -            | -      | -      | -     | -      |
|  |  |   | Class   | -  |                                     |                | -            | -      | -      | -     | -      |
|  | Power factor                             |   | %   | -  |                                     |                | 94           | 94     | 94     | -     | -      |
|  | Noise indoor                             |   | dB-A (H/M/L) *7                                   | 30/28/27   |                                     |                | -            |        |        | -     | -      |
|  |  |   | Power Level dB                                    | 45/43/42   |                                     |                | -            |        |        | -     | -      |
| Noise outdoor                                |  | dB-A (H/L)                                | -   |  |                                     | 53/-           |              |        | -      | -     |        |
|  |  | Power Level dB                            | -   |  |                                     | 70/-           |              |        | -      | -     |        |
| EXTRA LOW TEMP                               |  | Total capacity(kW) / Input power(W) / COP | -   |  |                                     | -              |              |        | -      |       |        |
| Max Current(A) / Max Input power(W)          |  | 0.23×4/24×4                               | 0.23×4/24×4                                       | 0.22×4/24×4  | 10.0 / 6.20k                        | 10.0 / 6.50k   | 10.0 / 6.75k | -      |        |       |        |
| Starting current(A) / Comp output(W)         |  | -   | -   | -  | 5.30 / 3.0k                         | 5.05 / 3.0k    | 4.85 / 3.0k  | -      |        |       |        |
| Network Impedance(ΩMAX.)                     |  | -   |   |  | -                                   |                |              | -      |        |       |        |
| Fan motor output (Indoor/Outdoor) W          |  | 60  |   |  | 90×2                                |                |              | -      |        |       |        |
| Moisture removal volume                      |  | L/h(Pt/h)                                 | 2.8   | (0.7×4)  | (5.9)                               | -              |              |        | -      |       |        |
| External static pressure                     |  | Pa  | -   |  |                                     | -              |              |        | -      |       |        |
| Indoor Air flow *7                           | Cooling                                  | m³/min (ft³/min)                          | 14.5×4/13.0×4/11.5×4 (512)×4/(459)×4/(406)×4      |  |                                     | -              |              |        | -      |       |        |
|  | Heating                                  | m³/min (ft³/min)                          | 14.5×4/13.0×4/11.5×4 (512)×4/(459)×4/(406)×4      |  |                                     | -              |              |        | -      |       |        |
| Outdoor Air flow                             | Cooling                                  | m³/min (ft³/min)                          | -   |  |                                     | 130 (4591)     |              |        | -      |       |        |
|  | Heating                                  | m³/min (ft³/min)                          | -   |  |                                     | 110 (3885)     |              |        | -      |       |        |
| Refrigerant type / amount g(oz)              |  | -   |   |  | R410A 3.40k (119.9)                 |                |              | -      |        |       |        |
| Product dimension                            | Height                                   | mm(inch)                                  | 256   | (10-5/64)  |                                     | 1416 (55-3/4)  |              |        | -      |       |        |
|  | Width                                    | mm(inch)                                  | 840   | (33-5/64)  |                                     | 940 (37-1/32)  |              |        | -      |       |        |
|  | Depth                                    | mm(inch)                                  | 840   | (33-5/64)  |                                     | 340 (13-13/32) |              |        | -      |       |        |
| Product dimension (Panel)                    |  | H×W×D mm, inch                            | 33.5×950×950                                      |  | 1-11/32 × 37-13/32 × 37-13/32       |                | -            |        |        | -     |        |
| Packing dimension                            | Height                                   | mm(inch)                                  | 302   | (11-57/64)   |                                     | 1556           |              |        | -      |       |        |
|  | Width                                    | mm(inch)                                  | 898   | (35-3/8)   |                                     | 1055           |              |        | -      |       |        |
|  | Depth                                    | mm(inch)                                  | 898   | (35-3/8)   |                                     | 485            |              |        | -      |       |        |
| Weight                                       | (NET)                                    | kg(lb)                                    | 19  | (42)   |                                     | 98             | (216)        |        | -      |       |        |
|  | (GROSS)                                  | kg(lb)                                    | 26  | (57)   |                                     | 108            | (238)        |        | -      |       |        |
|  | Panel (NET)                              | kg(lb)                                    | 5   | (11)   |                                     | -              |              |        | -      |       |        |
| Layers limit (actually)                      |  | 11 (12)                                   |   |  | 1 (2)                               |                |              | -      |        |       |        |
| Operation condition                          | Cool (DBT)                               | 18°C ~ 32°C                               |   |  | -15°C ~ 46°C                        |                |              | -      |        |       |        |
|  | Heat (DBT)                               | 16°C ~ 30°C                               |   |  | -20°C ~ 24°C                        |                |              | -      |        |       |        |
| P<br>I<br>P<br>I<br>N<br>G                   | Pipe diameter mm (inch)                  | (Liquid)Ø6.35(1/4) (Gas)Ø12.7(1/2)        |   |  | (Liquid)Ø9.52(3/8) (Gas)Ø15.88(5/8) |                |              | -      |        |       |        |
|  | Connecting method, Standard length m(ft) | flared type, 5.0(16.4)                    |   |  | flared type, 5.0(16.4)              |                |              | -      |        |       |        |
| Pipe length range                            |  | m (ft)                                    |   | 5 ~ 75m (16.4 ~ 246.1)                                   |                                     |                |              |        |        |       |        |
| Indoor unit & Outdoor unit height difference |  | m (ft)                                    |   | 15m(OD located lower)/30m(OD located higher) (49.2/98.4) |                                     |                |              |        |        |       |        |
| Add gas amount                               |  | g/m (oz/ft)                               |   | 50g (0.538)  |                                     |                |              |        |        |       |        |
| Pipe length for additional gas               |  | m (ft)                                    |   | 30m (98.4)   |                                     |                |              |        |        |       |        |

\*1 In case it is necessary to indicate the air flow volume in (l/s), the value in (m³/min.) shall be multiplied by 16.7 and rounded down the decimal point.

\*2 If the EUROVENT Certified models can be operated under the "extra-low" temperature condition, -7°C dry bulb and -8°C wet-bulb temperatures with rated voltage 230V shall be used.

\*3 Network Impedance shall be applicable for EUROPE and CHINA models.

\*4 The annual consumption is calculated by multiplying the input power at 230V(400V) by an average of 500 hours per year in cooling mode.

\*5 EER and COP classification is at 230V(400V) only in accordance with EU directive 2002/31/EC.

\*6 SEER and SCOP classification is at 230V(400V) only in accordance with EN-14825. For heating, SCOP indicates the value of only Average heating season.

\*7 H: High at setting 5 stage (Level 5), M: Middle at setting 5 stage (Level 3), L: Low at setting 5 stage (Level 1)

# Simultaneous (Triple) -Type

## 1-1. Unit Specifications

**PE1**

### 1. 4-Way Cassette Type S-45PU2E5A×3 / U-125PE1E8A

| INDOOR                                       |  | MODEL                                     | S-45PU2E5A×3                                      |  |                                     | -              |              |        | -      |       |        |
|--|--|---|---|--|-------------------------------------|----------------|--------------|--------|--------|-------|--------|
| PANEL  |  | MODEL                                     | Standard type:CZ-KPU3×3 / ECONAVI type:CZ-KPU3A×3 |  |                                     | -              |              |        | -      |       |        |
| OUTDOOR                                      |  | MODEL                                     | -   |  |                                     | U-125PE1E8A    |              |        | -      |       |        |
| Branch pipe                                  |  | MODEL                                     | CZ-P3HPC2   |  |                                     |                |              |        |        | -     |        |
| Performance test condition                   |  | ISO5151 / EN14511 / EN12102 / EN14825     |   |  |                                     |                |              |        |        |       |        |
| C<br>O<br>L<br>L<br>I<br>N<br>G              | Power supply                             |   | 1Ø 50Hz   |  |                                     | 3Ø 50Hz        |              |        |        |       |        |
|  |  |   | Ø, Hz   |  |                                     |                |              |        |        |       |        |
|  |  |   | V   | 220V   | 230V                                | 240V           | 380V         | 400V   | 415V   | Min   | Max    |
|  | Capacity                                 |   | kW  | 12.5   | 12.5                                | 12.5           | -            | -      | -      | 3.3   | 14.0   |
|  |  |   | BTU/h   | 42700  | 42700                               | 42700          | -            | -      | -      | 11300 | 47800  |
|  | Current                                  |   | A   | 0.25×3   | 0.25×3                              | 0.24×3         | 5.30         | 5.05   | 4.85   | -     | -      |
|  | Input power                              |   | W   | 26×3   | 26×3                                | 26×3           | 3.292k       | 3.292k | 3.292k | -     | -      |
|  |  |   | TOTAL W   |  |                                     |                | 3.370k       | 3.370k | 3.370k | 770   | 4.600k |
|  | Annual consumption                       |   | TOTAL kWh *4                                      |  |                                     |                | -            | 1685   | -      | -     | -      |
|  | EER/EER CLASS                            |   | TOTAL (W/W) <sup>1/3</sup> ("A"-G)                |  |                                     |                | 3.70         | 3.70/A | 3.70   | 4.29  | 3.04   |
|  | Erp *6                                   |   | Pdesign   |  |                                     |                | -            | 12.5   | -      | -     | -      |
|  |  |   | η <sub>s.c</sub>                                  |  |                                     |                | -            | 276.4  | -      | -     | -      |
|  |  |   | Annual consumption                                |  |                                     |                | -            | -      | -      | -     | -      |
|  |  |   | Class   |  |                                     |                | -            | -      | -      | -     | -      |
| Power factor                                 |  | %   |   |  |                                     | 94             | 94           | 94     | -      | -     |        |
| Noise indoor                                 |  | dB-A (H/M/L) *7                           | 31/28/27  |  |                                     |                |              |        | -      | -     |        |
|  |  | Power Level dB                            | 46/43/42  |  |                                     |                |              |        | -      | -     |        |
| Noise outdoor                                |  | dB-A (H/L)                                |   |  |                                     | 53/-           |              |        | -      | -     |        |
|  |  | Power Level dB                            |   |  |                                     | 70/-           |              |        | -      | -     |        |
| H<br>E<br>A<br>T<br>I<br>N<br>G              | Capacity                                 |   | kW  | 14.0   | 14.0                                | 14.0           | -            | -      | -      | 4.1   | 16.0   |
|  |  |   | BTU/h   | 47800  | 47800                               | 47800          | -            | -      | -      | 14000 | 54600  |
|  | Current                                  |   | A   | 0.24×3   | 0.24×3                              | 0.23×3         | 4.80         | 4.55   | 4.40   | -     | -      |
|  | Input power                              |   | W   | 24×3   | 24×3                                | 24×3           | 2.968k       | 2.968k | 2.968k | -     | -      |
|  |  |   | TOTAL W   |  |                                     |                | 3.040k       | 3.040k | 3.040k | 790   | 5.040k |
|  | COP/COP CLASS                            |   | TOTAL (W/W) <sup>1/3</sup> ("A"-G)                |  |                                     |                | 4.60         | 4.60/A | 4.60   | 5.19  | 3.17   |
|  | Erp *6                                   |   | Pdesign at -10°C                                  |  |                                     |                | -            | 12.5   | -      | -     | -      |
|  |  |   | Tbivalent   |  |                                     |                | -            | -10    | -      | -     | -      |
|  |  |   | η <sub>s.h</sub>                                  |  |                                     |                | -            | 161.0  | -      | -     | -      |
|  |  |   | Annual consumption                                |  |                                     |                | -            | -      | -      | -     | -      |
|  |  |   | Class   |  |                                     |                | -            | -      | -      | -     | -      |
|  | Power factor                             |   | %   |  |                                     |                | 94           | 94     | 94     | -     | -      |
|  | Noise indoor                             |   | dB-A (H/M/L) *7                                   | 31/28/27   |                                     |                |              |        |        | -     | -      |
|  |  |   | Power Level dB                                    | 46/43/42   |                                     |                |              |        |        | -     | -      |
| Noise outdoor                                |  | dB-A (H/L)                                |   |  |                                     | 53/-           |              |        | -      | -     |        |
|  |  | Power Level dB                            |   |  |                                     | 70/-           |              |        | -      | -     |        |
| EXTRA LOW TEMP                               |  | Total capacity(kW) / Input power(W) / COP |   |  |                                     |                |              |        |        |       |        |
| Max Current(A) / Max Input power(W)          |  | 0.25×3/26×3                               | 0.25×3/26×3                                       | 0.24×3/26×3  | 10.0 / 6.20k                        | 10.0 / 6.50k   | 10.0 / 6.75k |        |        |       |        |
| Starting current(A) / Comp output(W)         |  | -   | -   | -  | 5.30 / 3.0k                         | 5.05 / 3.0k    | 4.85 / 3.0k  |        |        |       |        |
| Network Impedance(ΩMAX.)                     |  |   |   |  |                                     |                |              |        |        |       |        |
| Fan motor output (Indoor/Outdoor) W          |  | 60  |   |  | 90×2                                |                |              |        |        |       |        |
| Moisture removal volume                      |  | L/h(Pt/h)                                 | 3.9   | (1.3×3)  | (8.2)                               |                |              |        |        |       |        |
| External static pressure                     |  | Pa  |   |  |                                     |                |              |        |        |       |        |
| Indoor Air flow *7                           | Cooling                                  | m³/min (ft³/min)                          | 15.5×3/13.0×3/11.5×3 (547)×3/(459)×3/(406)×3      |  |                                     |                |              |        |        |       |        |
|  | Heating                                  | m³/min (ft³/min)                          | 15.5×3/13.0×3/11.5×3 (547)×3/(459)×3/(406)×3      |  |                                     |                |              |        |        |       |        |
| Outdoor Air flow                             | Cooling                                  | m³/min (ft³/min)                          |   |  |                                     | 130 (4591)     |              |        |        |       |        |
|  | Heating                                  | m³/min (ft³/min)                          |   |  |                                     | 110 (3885)     |              |        |        |       |        |
| Refrigerant type / amount g(oz)              |  |   |   |  | R410A 3.40k (119.9)                 |                |              |        |        |       |        |
| Product dimension                            | Height                                   | mm(inch)                                  | 256   | (10-5/64)  |                                     | 1416 (55-3/4)  |              |        |        |       |        |
|  | Width                                    | mm(inch)                                  | 840   | (33-5/64)  |                                     | 940 (37-1/32)  |              |        |        |       |        |
|  | Depth                                    | mm(inch)                                  | 840   | (33-5/64)  |                                     | 340 (13-13/32) |              |        |        |       |        |
| Product dimension (Panel)                    |  | H×W×D mm, inch                            | 33.5×950×950                                      |  | 1-11/32 × 37-13/32 × 37-13/32       |                |              |        |        |       |        |
| Packing dimension                            | Height                                   | mm(inch)                                  | 302   | (11-57/64)   |                                     | 1556           |              |        |        |       |        |
|  | Width                                    | mm(inch)                                  | 898   | (35-3/8)   |                                     | 1055           |              |        |        |       |        |
|  | Depth                                    | mm(inch)                                  | 898   | (35-3/8)   |                                     | 485            |              |        |        |       |        |
| Weight                                       | (NET)                                    | kg(lb)                                    | 19  | (42)   |                                     | 98             | (216)        |        |        |       |        |
|  | (GROSS)                                  | kg(lb)                                    | 26  | (57)   |                                     | 108            | (238)        |        |        |       |        |
|  | Panel (NET)                              | kg(lb)                                    | 5   | (11)   |                                     |                |              |        |        |       |        |
| Layers limit (actually)                      |  | 11 (12)                                   |   |  | 1 (2)                               |                |              |        |        |       |        |
| Operation condition                          | Cool (DBT)                               | 18°C ~ 32°C                               |   |  | -15°C ~ 46°C                        |                |              |        |        |       |        |
|  | Heat (DBT)                               | 16°C ~ 30°C                               |   |  | -20°C ~ 24°C                        |                |              |        |        |       |        |
| P<br>I<br>P<br>I<br>N<br>G                   | Pipe diameter mm (inch)                  | (Liquid)Ø6.35(1/4) (Gas)Ø12.7(1/2)        |   |  | (Liquid)Ø9.52(3/8) (Gas)Ø15.88(5/8) |                |              |        |        |       |        |
|  | Connecting method, Standard length m(ft) | flared type, 5.0(16.4)                    |   |  | flared type, 5.0(16.4)              |                |              |        |        |       |        |
| Pipe length range                            |  | m (ft)                                    |   | 5 ~ 75m (16.4 ~ 246.1)                                   |                                     |                |              |        |        |       |        |
| Indoor unit & Outdoor unit height difference |  | m (ft)                                    |   | 15m(OD located lower)/30m(OD located higher) (49.2/98.4) |                                     |                |              |        |        |       |        |
| Add gas amount                               |  | g/m (oz/ft)                               |   | 50g (0.538)  |                                     |                |              |        |        |       |        |
| Pipe length for additional gas               |  | m (ft)                                    |   | 30m (98.4)   |                                     |                |              |        |        |       |        |

\*1 In case it is necessary to indicate the air flow volume in (l/s), the value in (m³/min.) shall be multiplied by 16.7 and rounded down the decimal point.

\*2 If the EUROVENT Certified models can be operated under the "extra-low" temperature condition, -7°C dry bulb and -8°C wet-bulb temperatures with rated voltage 230V shall be used.

\*3 Network Impedance shall be applicable for EUROPE and CHINA models.

\*4 The annual consumption is calculated by multiplying the input power at 230V(400V) by an average of 500 hours per year in cooling mode.

\*5 EER and COP classification is at 230V(400V) only in accordance with EU directive 2002/31/EC.

\*6 SEER and SCOP classification is at 230V(400V) only in accordance with EN-14825. For heating, SCOP indicates the value of only Average heating season.

\*7 H: High at setting 5 stage (Level 5), M: Middle at setting 5 stage (Level 3), L: Low at setting 5 stage (Level 1)

# Simultaneous (Twin) -Type

## 1-1. Unit Specifications

PE1

### 1. 4-Way Cassette Type S-50PU2E5A×2 / U-100PE1E8A

| INDOOR   |  | MODEL                                 | S-50PU2E5A×2                                      |  |                                     | -              |              |        | -     |        |
|--|--|---------------------------------------|---|--|-------------------------------------|----------------|--------------|--------|-------|--------|
| PANEL  |  | MODEL                                 | Standard type:CZ-KPU3×2 / ECONAVI type:CZ-KPU3A×2 |  |                                     | -              |              |        | -     |        |
| OUTDOOR  |  | MODEL                                 | -   |  |                                     | U-100PE1E8A    |              |        | -     |        |
| Branch pipe  |  | MODEL                                 | -   |  |                                     | CZ-P155BK1     |              |        | -     |        |
| Performance test condition                               |  | ISO5151 / EN14511 / EN12102 / EN14825 |   |  |                                     |                |              |        |       |        |
| C<br>O<br>O<br>L<br>I<br>N<br>G                          | Power supply                             | ∅, Hz                                 | 1∅ 50Hz   |  |                                     | 3∅ 50Hz        |              |        | Min   | Max    |
|  |  | V                                     | 220V  | 230V   | 240V                                | 380V           | 400V         | 415V   |       |        |
|  | Capacity                                 | kW                                    | 10.0  | 10.0   | 10.0                                | -              | -            | -      | 3.3   | 12.5   |
|  |  | BTU/h                                 | 34100   | 34100  | 34100                               | -              | -            | -      | 11300 | 42700  |
|  | Current                                  | A                                     | 0.27 ×2   | 0.26 ×2  | 0.25 ×2                             | 3.70           | 3.50         | 3.40   | -     | -      |
|  |  | W                                     | 29 ×2   | 29 ×2  | 29 ×2                               | 2.282k         | 2.282k       | 2.282k | -     | -      |
|  | Input power                              | TOTAL W                               | -   | -  | -                                   | 2.340k         | 2.340k       | 2.340k | 770   | 3.700k |
|  |  | Annual consumption                    | TOTAL kWh *4                                      | -  | -                                   | -              | -            | 1170   | -     | -      |
|  | EER/EER CLASS                            | TOTAL (W/W) <sup>5/7</sup> ("A"-G)    | -   | -  | -                                   | 4.27           | 4.27/A       | 4.27   | 4.29  | 3.38   |
|  | Erp <sup>6</sup>                         | Pdesign                               | kW  | -  | -                                   | -              | -            | 10.0   | -     | -      |
|  |  | SEER                                  | (W/W)   | -  | -                                   | -              | -            | 7.2    | -     | -      |
|  |  | Annual consumption                    | kWh   | -  | -                                   | -              | -            | 486    | -     | -      |
|  |  | Class                                 |   | -  | -                                   | -              | -            | A++    | -     | -      |
|  | Power factor                             | %                                     | -   | -  | -                                   | 94             | 94           | 93     | -     | -      |
| Noise indoor   | dB-A (H/M/L) *7                          | 32/29/27                              |   |  | -                                   |                |              | -      | -     |        |
|  | Power Level dB                           | 47/44/42                              |   |  | -                                   |                |              | -      | -     |        |
| Noise outdoor  | dB-A (H/L)                               | -                                     |   |  | 52/-                                |                |              | -      | -     |        |
|  | Power Level dB                           | -                                     |   |  | 69/-                                |                |              | -      | -     |        |
| H<br>E<br>A<br>T<br>I<br>N<br>G                          | Capacity                                 | kW                                    | 11.2  | 11.2   | 11.2                                | -              | -            | -      | 4.1   | 14.0   |
|  |  | BTU/h                                 | 38200   | 38200  | 38200                               | -              | -            | -      | 14000 | 47800  |
|  | Current                                  | A                                     | 0.26 ×2   | 0.25 ×2  | 0.24 ×2                             | 3.55           | 3.35         | 3.25   | -     | -      |
|  |  | W                                     | 27 ×2   | 27 ×2  | 27 ×2                               | 2.186k         | 2.186k       | 2.186k | -     | -      |
|  | Input power                              | TOTAL W                               | -   | -  | -                                   | 2.240k         | 2.240k       | 2.240k | 790   | 4.400k |
|  |  | COP/COP CLASS                         | TOTAL (W/W) <sup>5/7</sup> ("A"-G)                | -  | -                                   | -              | 5.00         | 5.00/A | 5.00  | 5.19   |
|  | Erp <sup>6</sup>                         | Pdesign at -10°C                      | kW  | -  | -                                   | -              | -            | 10.0   | -     | -      |
|  |  | Tbivalent                             | °C  | -  | -                                   | -              | -            | -10    | -     | -      |
|  |  | SCOP                                  | (W/W)   | -  | -                                   | -              | -            | 4.8    | -     | -      |
|  |  | Annual consumption                    | kWh   | -  | -                                   | -              | -            | 2917   | -     | -      |
|  | Class                                    |                                       | -   | -  | -                                   | -              | A++          | -      | -     |        |
|  | Power factor                             | %                                     | -   | -  | -                                   | 94             | 94           | 94     | -     | -      |
|  | Noise indoor                             | dB-A (H/M/L) *7                       | 32/29/27  |  |                                     | -              |              |        | -     | -      |
|  |  | Power Level dB                        | 47/44/42  |  |                                     | -              |              |        | -     | -      |
| Noise outdoor  | dB-A (H/L)                               | -                                     |   |  | 52/-                                |                |              | -      | -     |        |
|  | Power Level dB                           | -                                     |   |  | 69/-                                |                |              | -      | -     |        |
| EXTRA LOW TEMP Total capacity(kW) / Input power(W) / COP |  | -                                     |   |  |                                     |                |              |        |       |        |
| Max Current(A) / Max Input power(W)                      |  | 0.27×2/29×2                           | 0.26×2/29×2                                       | 0.25×2/29×2  | 9.00 / 5.55k                        | 9.00 / 5.85k   | 9.00 / 6.10k | -      |       |        |
| Starting current(A) / Comp output(W)                     |  | -                                     | -   | -  | 3.70 / 3.0k                         | 3.50 / 3.0k    | 3.40 / 3.0k  | -      |       |        |
| Network Impedance(ΩMAX.)                                 |  | -                                     |   |  |                                     |                |              |        |       |        |
| Fan motor output (Indoor/Outdoor) W                      |  | 60                                    |   |  | 90 ×2                               |                |              | -      |       |        |
| Moisture removal volume                                  |  | L/h(Pt/h)                             | 3.2   | (1.6×2)  | (6.7)                               | -              |              |        | -     |        |
| External static pressure                                 |  | Pa                                    | -   |  |                                     | -              |              |        | -     |        |
| Indoor Air flow *7                                       | Cooling                                  | m³/min (ft³/min)                      | 16.5×2/13.5×2/11.5×2 (583)×2/(477)×2/(406)×2      |  |                                     | -              |              |        | -     | -      |
|  | Heating                                  | m³/min (ft³/min)                      | 16.5×2/13.5×2/11.5×2 (583)×2/(477)×2/(406)×2      |  |                                     | -              |              |        | -     | -      |
| Outdoor Air flow   | Cooling                                  | m³/min (ft³/min)                      | -   |  |                                     | 110 (3885)     |              |        | -     | -      |
|  | Heating                                  | m³/min (ft³/min)                      | -   |  |                                     | 95 (3355)      |              |        | -     | -      |
| Refrigerant type / amount g(oz)                          |  | -                                     |   |  | R410A 3.40k (119.9)                 |                |              | -      |       |        |
| Product dimension  | Height                                   | mm(inch)                              | 256   | (10-5/64)  |                                     | 1416 (55-3/4)  |              |        | -     |        |
|  | Width                                    | mm(inch)                              | 840   | (33-5/64)  |                                     | 940 (37-1/32)  |              |        | -     |        |
|  | Depth                                    | mm(inch)                              | 840   | (33-5/64)  |                                     | 340 (13-13/32) |              |        | -     |        |
| Product dimension (Panel)                                |  | H×W×D mm, inch                        | 33.5×950×950                                      |  | 1-11/32 × 37-13/32 × 37-13/32       |                | -            |        |       |        |
| Packing dimension  | Height                                   | mm(inch)                              | 302   | (11-57/64)   |                                     | 1556           |              |        | -     |        |
|  | Width                                    | mm(inch)                              | 898   | (35-3/8)   |                                     | 1055           |              |        | -     |        |
|  | Depth                                    | mm(inch)                              | 898   | (35-3/8)   |                                     | 485            |              |        | -     |        |
| Weight   | (NET)                                    | kg(lb)                                | 19  | (42)   |                                     | 98             | (216)        |        | -     |        |
|  | (GROSS)                                  | kg(lb)                                | 26  | (57)   |                                     | 108            | (238)        |        | -     |        |
|  | Panel (NET)                              | kg(lb)                                | 5   | (11)   |                                     | -              |              |        | -     |        |
|  | Layers limit (actually)                  |                                       | 11 (12)   |  |                                     | 1 (2)          |              |        | -     |        |
| Operation condition                                      | Cool (DBT)                               | 18°C ~ 32°C                           |   |  | -15°C ~ 46°C                        |                |              | -      |       |        |
|  | Heat (DBT)                               | 16°C ~ 30°C                           |   |  | -20°C ~ 24°C                        |                |              | -      |       |        |
| P<br>I<br>P<br>I<br>N<br>G                               | Pipe diameter mm (inch)                  | (Liquid)∅6.35(1/4) (Gas)∅12.7(1/2)    |   |  | (Liquid)∅9.52(3/8) (Gas)∅15.88(5/8) |                |              | -      |       |        |
|  | Connecting method, Standard length m(ft) | flared type, 5.0(16.4)                |   |  | flared type, 5.0(16.4)              |                |              | -      |       |        |
| Pipe length range  |  | m (ft)                                |   | 5 ~ 75m (16.4 ~ 246.1)                                   |                                     |                |              |        |       |        |
| Indoor unit & Outdoor unit height difference             |  | m (ft)                                |   | 15m(OD located lower)/30m(OD located higher) (49.2/98.4) |                                     |                |              |        |       |        |
| Add gas amount   |  | g/m (oz/ft)                           |   | 50g (0.538)  |                                     |                |              |        |       |        |
| Pipe length for additional gas                           |  | m (ft)                                |   | 30m (98.4)   |                                     |                |              |        |       |        |

\*1 In case it is necessary to indicate the air flow volume in (l/s), the value in (m³/min.) shall be multiplied by 16.7 and rounded down the decimal point.  
 \*2 If the EUROVENT Certified models can be operated under the "extra-low" temperature condition, -7°C dry bulb and -8°C wet-bulb temperatures with rated voltage 230V shall be used.  
 \*3 Network Impedance shall be applicable for EUROPE and CHINA models.  
 \*4 The annual consumption is calculated by multiplying the input power at 230V(400V) by an average of 500 hours per year in cooling mode.  
 \*5 EER and COP classification is at 230V(400V) only in accordance with EU directive 2002/31/EC.  
 \*6 SEER and SCOP classification is at 230V(400V) only in accordance with EN-14825. For heating, SCOP indicates the value of only Average heating season, Other fiche data indicates in an attached sheet.  
 \*7 H: High at setting 5 stage (Level 5), M: Middle at setting 5 stage (Level 3), L: Low at setting 5 stage (Level 1)

# Simultaneous (Triple) -Type

## 1-1. Unit Specifications

**PE1**

### 1. 4-Way Cassette Type S-50PU2E5A×3 / U-140PE1E8A

| INDOOR  |  | MODEL                                     | S-50PU2E5A×3   |             |                               | -                                   |              |              | -      |       |        |
|---|--|---|--|-------------|-------------------------------|-------------------------------------|--------------|--------------|--------|-------|--------|
| PANEL   |  | MODEL                                     | Standard type:CZ-KPU3×3 / ECONAVI type:CZ-KPU3A×3        |             |                               | -                                   |              |              | -      |       |        |
| OUTDOOR   |  | MODEL                                     | -  |             |                               | U-140PE1E8A                         |              |              | -      |       |        |
| Branch pipe   |  | MODEL                                     | -  |             |                               | CZ-P3HPC2                           |              |              | -      |       |        |
| Performance test condition                          |  | ISO5151 / EN14511 / EN12102 / EN14825     |  |             |                               |                                     |              |              |        |       |        |
| C<br>O<br>O<br>L<br>I<br>N<br>G                     | Power supply                             |   | 1Ø 50Hz  |             |                               | 3Ø 50Hz                             |              |              |        |       |        |
|   |  |   | Ø, Hz  |             |                               |                                     |              |              |        |       |        |
|   |  |   | V  | 220V        | 230V                          | 240V                                | 380V         | 400V         | 415V   | Min   | Max    |
|   | Capacity                                 |   | kW   | 14.0        | 14.0                          | 14.0                                | -            | -            | -      | 3.3   | 15.5   |
|   |  |   | BTU/h  | 47800       | 47800                         | 47800                               | -            | -            | -      | 11300 | 52900  |
|   | Current                                  |   | A  | 0.27×3      | 0.26×3                        | 0.25×3                              | 6.70         | 6.35         | 6.15   | -     | -      |
|   | Input power                              |   | W  | 29×3        | 29×3                          | 29×3                                | 4.153k       | 4.153k       | 4.153k | -     | -      |
|   |  |   | TOTAL W  |             |                               |                                     | 4.240k       | 4.240k       | 4.240k | 770   | 5.740k |
|   | Annual consumption                       |   | TOTAL kWh *4   |             |                               |                                     | -            | 2120         | -      | -     | -      |
|   | EER/EER CLASS                            |   | TOTAL (W/W) <sup>1/3</sup> ("A"-G)                       |             |                               |                                     | 3.30         | 3.30/A       | 3.30   | 4.29  | 2.70   |
|   | Erp *6                                   |   | Pdesign kW   |             |                               |                                     | -            | 14.0         | -      | -     | -      |
|   |  |   | η <sub>s.c</sub> %                                       |             |                               |                                     | -            | 260.0        | -      | -     | -      |
|   |  |   | Annual consumption kWh                                   |             |                               |                                     | -            | -            | -      | -     | -      |
|   |  |   | Class  |             |                               |                                     | -            | -            | -      | -     | -      |
| Power factor  |  | %   |  |             |                               | 94                                  | 94           | 94           | -      | -     |        |
| Noise indoor  |  | dB-A (H/M/L) *7                           | 32/29/27   |             |                               |                                     |              |              | -      | -     |        |
|   |  | Power Level dB                            | 47/44/42   |             |                               |                                     |              |              | -      | -     |        |
| Noise outdoor                                       |  | dB-A (H/L)                                |  |             |                               | 54/-                                |              |              | -      | -     |        |
|   |  | Power Level dB                            |  |             |                               | 71/-                                |              |              | -      | -     |        |
| H<br>E<br>A<br>T<br>I<br>N<br>G                     | Capacity                                 |   | kW   | 16.0        | 16.0                          | 16.0                                | -            | -            | -      | 4.1   | 18.0   |
|   |  |   | BTU/h  | 54600       | 54600                         | 54600                               | -            | -            | -      | 14000 | 61400  |
|   | Current                                  |   | A  | 0.26×3      | 0.25×3                        | 0.24×3                              | 5.90         | 5.60         | 5.40   | -     | -      |
|   | Input power                              |   | W  | 27×3        | 27×3                          | 27×3                                | 3.639k       | 3.639k       | 3.639k | -     | -      |
|   |  |   | TOTAL W  |             |                               |                                     | 3.720k       | 3.720k       | 3.720k | 790   | 5.720k |
|   | COP/COP CLASS                            |   | TOTAL (W/W) <sup>1/3</sup> ("A"-G)                       |             |                               |                                     | 4.30         | 4.30/A       | 4.30   | 5.19  | 3.15   |
|   | Erp *6                                   |   | Pdesign at -10°C kW                                      |             |                               |                                     | -            | 14.0         | -      | -     | -      |
|   |  |   | Tbivalent °C   |             |                               |                                     | -            | -7           | -      | -     | -      |
|   |  |   | η <sub>s.h</sub> %                                       |             |                               |                                     | -            | 152.9        | -      | -     | -      |
|   |  |   | Annual consumption kWh                                   |             |                               |                                     | -            | -            | -      | -     | -      |
|   |  |   | Class  |             |                               |                                     | -            | -            | -      | -     | -      |
|   | Power factor                             |   | %  |             |                               |                                     | 94           | 94           | 94     | -     | -      |
|   | Noise indoor                             |   | dB-A (H/M/L) *7  | 32/29/27    |                               |                                     |              |              |        | -     | -      |
|   |  |   | Power Level dB   | 47/44/42    |                               |                                     |              |              |        | -     | -      |
| Noise outdoor                                       |  | dB-A (H/L)                                |  |             |                               | 55/-                                |              |              | -      | -     |        |
|   |  | Power Level dB                            |  |             |                               | 71/-                                |              |              | -      | -     |        |
| EXTRA LOW TEMP                                      |  | Total capacity(kW) / Input power(W) / COP |  |             |                               |                                     |              |              |        |       |        |
| Max Current(A) / Max Input power(W)                 |  |   | 0.27×3/29×3  | 0.26×3/29×3 | 0.25×3/29×3                   | 11.0 / 6.80k                        | 11.0 / 7.15k | 11.0 / 7.45k |        |       |        |
| Starting current(A) / Comp output(W)                |  |   | -  | -           | -                             | 6.70 / 3.0k                         | 6.35 / 3.0k  | 6.15 / 3.0k  |        |       |        |
| Network Impedance(ΩMAX.)                            |  |   |  |             |                               |                                     |              |              |        |       |        |
| Fan motor output (Indoor/Outdoor) W                 |  |   | 60   |             |                               | 90×2                                |              |              |        |       |        |
| Moisture removal volume                             |  | L/h(Pt/h)                                 | 4.8  | (1.6×3)     | (10.1)                        |                                     |              |              |        |       |        |
| External static pressure                            |  | Pa  |  |             |                               |                                     |              |              |        |       |        |
| Indoor Air flow *7                                  | Cooling                                  | m³/min (ft³/min)                          | 16.5×3/13.5×3/11.5×3 (583)×3/(477)×3/(406)×3             |             |                               |                                     |              |              |        |       |        |
|   | Heating                                  | m³/min (ft³/min)                          | 16.5×3/13.5×3/11.5×3 (583)×3/(477)×3/(406)×3             |             |                               |                                     |              |              |        |       |        |
| Outdoor Air flow                                    | Cooling                                  | m³/min (ft³/min)                          |  |             |                               | 135 (4767)                          |              |              |        |       |        |
|   | Heating                                  | m³/min (ft³/min)                          |  |             |                               | 120 (4238)                          |              |              |        |       |        |
| Refrigerant type / amount g(oz)                     |  |   |  |             |                               | R410A 3.40k (119.9)                 |              |              |        |       |        |
| Product dimension                                   | Height                                   | mm(inch)                                  | 256  |             | (10-5/64)                     | 1416 (55-3/4)                       |              |              |        |       |        |
|   | Width                                    | mm(inch)                                  | 840  |             | (33-5/64)                     | 940 (37-1/32)                       |              |              |        |       |        |
|   | Depth                                    | mm(inch)                                  | 840  |             | (33-5/64)                     | 340 (13-13/32)                      |              |              |        |       |        |
| Product dimension (Panel)                           |  | H×W×D mm, inch                            | 33.5×950×950   |             | 1-11/32 × 37-13/32 × 37-13/32 |                                     |              |              |        |       |        |
| Packing dimension                                   | Height                                   | mm(inch)                                  | 302  |             | (11-57/64)                    | 1556                                |              |              |        |       |        |
|   | Width                                    | mm(inch)                                  | 898  |             | (35-3/8)                      | 1055                                |              |              |        |       |        |
|   | Depth                                    | mm(inch)                                  | 898  |             | (35-3/8)                      | 485                                 |              |              |        |       |        |
| Weight  | (NET)                                    | kg(lb)                                    | 19   |             | (42)                          | 98                                  |              | (216)        |        |       |        |
|   | (GROSS)                                  | kg(lb)                                    | 26   |             | (57)                          | 108                                 |              | (238)        |        |       |        |
|   | Panel (NET)                              | kg(lb)                                    | 5  |             | (11)                          |                                     |              |              |        |       |        |
| Layers limit (actually)                             |  |   | 11 (12)  |             |                               | 1 (2)                               |              |              |        |       |        |
| Operation condition                                 | Cool (DBT)                               |   | 18°C ~ 32°C  |             |                               | -15°C ~ 46°C                        |              |              |        |       |        |
|   | Heat (DBT)                               |   | 16°C ~ 30°C  |             |                               | -20°C ~ 24°C                        |              |              |        |       |        |
| P<br>I<br>P<br>I<br>N<br>G                          | Pipe diameter mm (inch)                  |   | (Liquid)Ø6.35(1/4) (Gas)Ø12.7(1/2)                       |             |                               | (Liquid)Ø9.52(3/8) (Gas)Ø15.88(5/8) |              |              |        |       |        |
|   | Connecting method, Standard length m(ft) |   | flared type, 5.0(16.4)                                   |             |                               | flared type, 5.0(16.4)              |              |              |        |       |        |
| Pipe length range m (ft)                            |  |   | 5 ~ 75m (16.4 ~ 246.1)                                   |             |                               |                                     |              |              |        |       |        |
| Indoor unit & Outdoor unit height difference m (ft) |  |   | 15m(OD located lower)/30m(OD located higher) (49.2/98.4) |             |                               |                                     |              |              |        |       |        |
| Add gas amount g/m (oz/ft)                          |  |   | 50g (0.538)  |             |                               |                                     |              |              |        |       |        |
| Pipe length for additional gas m (ft)               |  |   | 30m (98.4)   |             |                               |                                     |              |              |        |       |        |

\*1 In case it is necessary to indicate the air flow volume in (l/s), the value in (m³/min.) shall be multiplied by 16.7 and rounded down the decimal point.

\*2 If the EUROVENT Certified models can be operated under the "extra-low" temperature condition, -7°C dry bulb and -8°C wet-bulb temperatures with rated voltage 230V shall be used.

\*3 Network Impedance shall be applicable for EUROPE and CHINA models.

\*4 The annual consumption is calculated by multiplying the input power at 230V(400V) by an average of 500 hours per year in cooling mode.

\*5 EER and COP classification is at 230V(400V) only in accordance with EU directive 2002/31/EC.

\*6 SEER and SCOP classification is at 230V(400V) only in accordance with EN-14825. For heating, SCOP indicates the value of only Average heating season.

\*7 H: High at setting 5 stage (Level 5), M: Middle at setting 5 stage (Level 3), L: Low at setting 5 stage (Level 1)

# Simultaneous (Twin) -Type

## 1-1. Unit Specifications

PE1

### 1. 4-Way Cassette Type S-60PU2E5A×2 / U-125PE1E8A

| INDOOR  |                    | MODEL  | S-60PU2E5A×2                                      |             |                                     | -           |                |              | -            |              |        |
|---|--------------------|--|---|-------------|-------------------------------------|-------------|----------------|--------------|--------------|--------------|--------|
| PANEL   |                    | MODEL  | Standard type:CZ-KPU3×2 / ECONAVI type:CZ-KPU3A×2 |             |                                     | -           |                |              | -            |              |        |
| OUTDOOR   |                    | MODEL  | -   |             |                                     | U-125PE1E8A |                |              | -            |              |        |
| Branch pipe   |                    | MODEL  | -   |             |                                     | CZ-P155BK1  |                |              | -            |              |        |
| Performance test condition                          |                    | ISO5151 / EN14511 / EN12102 / EN14825                    |   |             |                                     |             |                |              |              |              |        |
| C<br>O<br>O<br>L<br>I<br>N<br>G                     | Power supply       |  | 1Ø 50Hz   |             |                                     | 3Ø 50Hz     |                |              |              |              |        |
|   |                    |  | Ø, Hz   |             |                                     |             |                |              |              |              |        |
|   |                    |  | V   | 220V        | 230V                                | 240V        | 380V           | 400V         | 415V         | Min          | Max    |
|   | Capacity           |  | kW  | 12.5        | 12.5                                | 12.5        | -              | -            | -            | 3.3          | 14.0   |
|   |                    |  | BTU/h   | 42700       | 42700                               | 42700       | -              | -            | -            | 11300        | 47800  |
|   | Current            |  | A   | 0.36×2      | 0.35×2                              | 0.34×2      | 5.30           | 5.05         | 4.85         | -            | -      |
|   | Input power        |  | W   | 38×2        | 38×2                                | 38×2        | 3.294k         | 3.294k       | 3.294k       | -            | -      |
|   |                    |  | TOTAL W   | -           | -                                   | -           | 3.370k         | 3.370k       | 3.370k       | 770          | 4.600k |
|   | Annual consumption |  | TOTAL kWh *4                                      | -           | -                                   | -           | -              | 1685         | -            | -            | -      |
|   | EER/EER CLASS      |  | TOTAL (W/W) <sup>5/7</sup> ("A"-G)                | -           | -                                   | -           | 3.70           | 3.70/A       | 3.70         | 4.29         | 3.04   |
|   | Erp *6             |  | Pdesign   | kW          | -                                   | -           | -              | 12.5         | -            | -            | -      |
|   |                    |  | η <sub>s.c</sub>                                  | %           | -                                   | -           | -              | 276.1        | -            | -            | -      |
|   |                    |  | Annual consumption                                | kWh         | -                                   | -           | -              | -            | -            | -            | -      |
|   |                    |  | Class   | -           | -                                   | -           | -              | -            | -            | -            | -      |
| Power factor  |                    | %  | -   | -           | -                                   | 94          | 94             | 94           | -            | -            |        |
| Noise indoor  |                    | dB-A (H/M/L) *7  | 36/31/28  |             |                                     | -           |                |              | -            | -            |        |
|   |                    | Power Level dB   | 51/46/43  |             |                                     | -           |                |              | -            | -            |        |
| Noise outdoor                                       |                    | dB-A (H/L)   | -   |             |                                     | 53/-        |                |              | -            | -            |        |
|   |                    | Power Level dB   | -   |             |                                     | 70/-        |                |              | -            | -            |        |
| H<br>E<br>A<br>T<br>I<br>N<br>G                     | Capacity           |  | kW  | 14.0        | 14.0                                | 14.0        | -              | -            | -            | 4.1          | 16.0   |
|   |                    |  | BTU/h   | 47800       | 47800                               | 47800       | -              | -            | -            | 14000        | 54600  |
|   | Current            |  | A   | 0.35×2      | 0.34×2                              | 0.33×2      | 4.80           | 4.55         | 4.40         | -            | -      |
|   | Input power        |  | W   | 36×2        | 36×2                                | 36×2        | 2.968k         | 2.968k       | 2.968k       | -            | -      |
|   |                    |  | TOTAL W   | -           | -                                   | -           | 3.040k         | 3.040k       | 3.040k       | 790          | 5.040k |
|   | COP/COP CLASS      |  | TOTAL (W/W) <sup>5/7</sup> ("A"-G)                | -           | -                                   | -           | 4.60           | 4.60/A       | 4.60         | 5.19         | 3.17   |
|   | Erp *6             |  | Pdesign at -10°C                                  | kW          | -                                   | -           | -              | 12.5         | -            | -            | -      |
|   |                    |  | Tbivalent   | °C          | -                                   | -           | -              | -10          | -            | -            | -      |
|   |                    |  | η <sub>s.h</sub>                                  | %           | -                                   | -           | -              | 161.0        | -            | -            | -      |
|   |                    |  | Annual consumption                                | kWh         | -                                   | -           | -              | -            | -            | -            | -      |
|   |                    |  | Class   | -           | -                                   | -           | -              | -            | -            | -            | -      |
|   | Power factor       |  | %   | -           | -                                   | -           | 94             | 94           | 94           | -            | -      |
|   | Noise indoor       |  | dB-A (H/M/L) *7                                   | 36/31/28    |                                     |             | -              |              |              | -            | -      |
|   |                    |  | Power Level dB                                    | 51/46/43    |                                     |             | -              |              |              | -            | -      |
| Noise outdoor                                       |                    | dB-A (H/L)   | -   |             |                                     | 53/-        |                |              | -            | -            |        |
|   |                    | Power Level dB   | -   |             |                                     | 70/-        |                |              | -            | -            |        |
| EXTRA LOW TEMP                                      |                    | Total capacity(kW) / Input power(W) / COP                | -   |             |                                     |             |                |              |              |              |        |
| Max Current(A) / Max Input power(W)                 |                    | 0.36×2/38×2  |   | 0.35×2/38×2 |                                     | 0.34×2/38×2 |                | 10.0 / 6.20k | 10.0 / 6.50k | 10.0 / 6.75k | -      |
| Starting current(A) / Comp output(W)                |                    | -  |   | -           |                                     | -           |                | 5.30 / 3.0k  | 5.05 / 3.0k  | 4.85 / 3.0k  | -      |
| Network Impedance(ΩMAX.)                            |                    | -  |   |             |                                     |             |                |              |              |              |        |
| Fan motor output (Indoor/Outdoor) W                 |                    | 60   |   |             | -                                   |             |                | 90×2         |              | -            |        |
| Moisture removal volume                             |                    | L/h(Pt/h)  | 3.4   | (1.7×2)     | (7.1)                               | -           |                |              | -            | -            |        |
| External static pressure                            |                    | Pa   | -   |             |                                     | -           |                |              | -            | -            |        |
| Indoor Air flow *7                                  | Cooling            | m³/min (ft³/min)   | 21.0×2/16.0×2/13.0×2 (742)×2/(565)×2/(459)×2      |             |                                     | -           |                |              | -            | -            |        |
|   | Heating            | m³/min (ft³/min)   | 21.0×2/16.0×2/13.0×2 (742)×2/(565)×2/(459)×2      |             |                                     | -           |                |              | -            | -            |        |
| Outdoor Air flow                                    | Cooling            | m³/min (ft³/min)   | -   |             |                                     | 130 (4591)  |                |              | -            | -            |        |
|   | Heating            | m³/min (ft³/min)   | -   |             |                                     | 110 (3885)  |                |              | -            | -            |        |
| Refrigerant type / amount g(oz)                     |                    | -  |   |             | R410A 3.40k (119.9)                 |             |                | -            | -            |              |        |
| Product dimension                                   | Height             | mm(inch)   | 256   |             | (10-5/64)                           |             | 1416 (55-3/4)  |              | -            |              |        |
|   | Width              | mm(inch)   | 840   |             | (33-5/64)                           |             | 940 (37-1/32)  |              | -            |              |        |
|   | Depth              | mm(inch)   | 840   |             | (33-5/64)                           |             | 340 (13-13/32) |              | -            |              |        |
| Product dimension (Panel)                           |                    | H×W×D mm, inch   | 33.5×950×950                                      |             | 1-11/32×37-13/32×37-13/32           |             | -              |              | -            |              |        |
| Packing dimension                                   | Height             | mm(inch)   | 302   |             | (11-57/64)                          |             | 1556           |              | -            |              |        |
|   | Width              | mm(inch)   | 898   |             | (35-3/8)                            |             | 1055           |              | -            |              |        |
|   | Depth              | mm(inch)   | 898   |             | (35-3/8)                            |             | 485            |              | -            |              |        |
| Weight  | (NET)              | kg(lb)   | 20  |             | (44)                                |             | 98 (216)       |              | -            |              |        |
|   | (GROSS)            | kg(lb)   | 27  |             | (60)                                |             | 108 (238)      |              | -            |              |        |
|   | Panel (NET)        | kg(lb)   | 5   |             | (11)                                |             | -              |              | -            |              |        |
| Layers limit (actually)                             |                    | 11 (12)  |   |             | 1 (2)                               |             |                | -            | -            |              |        |
| Operation condition                                 | Cool (DBT)         | 18°C ~ 32°C  |   |             | -15°C ~ 46°C                        |             |                | -            | -            |              |        |
|   | Heat (DBT)         | 16°C ~ 30°C  |   |             | -20°C ~ 24°C                        |             |                | -            | -            |              |        |
| Pipe diameter mm (inch)                             |                    | (Liquid)Ø9.52(3/8) (Gas)Ø15.88(5/8)                      |   |             | (Liquid)Ø9.52(3/8) (Gas)Ø15.88(5/8) |             |                | -            | -            |              |        |
| Connecting method, Standard length m(ft)            |                    | flared type, 5.0(16.4)                                   |   |             | flared type, 5.0(16.4)              |             |                | -            | -            |              |        |
| Pipe length range m (ft)                            |                    | 5 ~ 75m (16.4 ~ 246.1)                                   |   |             | -                                   |             |                | -            | -            |              |        |
| Indoor unit & Outdoor unit height difference m (ft) |                    | 15m(OD located lower)/30m(OD located higher) (49.2/98.4) |   |             | -                                   |             |                | -            | -            |              |        |
| Add gas amount g/m (oz/ft)                          |                    | 50g (0.538)  |   |             | -                                   |             |                | -            | -            |              |        |
| Pipe length for additional gas m (ft)               |                    | 30m (98.4)   |   |             | -                                   |             |                | -            | -            |              |        |

\*1 In case it is necessary to indicate the air flow volume in (l/s), the value in (m³/min.) shall be multiplied by 16.7 and rounded down the decimal point.  
 \*2 If the EUROVENT Certified models can be operated under the "extra-low" temperature condition, -7°C dry bulb and -8°C wet-bulb temperatures with rated voltage 230V shall be used.  
 \*3 Network Impedance shall be applicable for EUROPE and CHINA models.  
 \*4 The annual consumption is calculated by multiplying the input power at 230V(400V) by an average of 500 hours per year in cooling mode.  
 \*5 EER and COP classification is at 230V(400V) only in accordance with EU directive 2002/31/EC.  
 \*6 SEER and SCOP classification is at 230V(400V) only in accordance with EN-14825. For heating, SCOP indicates the value of only Average heating season.  
 \*7 H: High at setting 5 stage (Level 5), M: Middle at setting 5 stage (Level 3), L: Low at setting 5 stage (Level 1)

# Single-Type

## 1-1. Unit Specifications

**PE1**

### 1. 4-Way Cassette Type S-71PU2E5A / U-71PE1E8A

| INDOOR   |  | MODEL              | S-71PU2E5A   |            |                               | -                                   |              |              | -      |       |        |
|--|--|--------------------|--|------------|-------------------------------|-------------------------------------|--------------|--------------|--------|-------|--------|
| PANEL  |  | MODEL              | Standard type:CZ-KPU3:ECONAVI type:CZ-KPU3A              |            |                               | -                                   |              |              | -      |       |        |
| OUTDOOR  |  | MODEL              | -  |            |                               | U-71PE1E8A                          |              |              | -      |       |        |
| Branch pipe  |  | MODEL              | -  |            |                               | -                                   |              |              | -      |       |        |
| Performance test condition                                 |  |                    | ISO5151 / EN14511 / EN12102 / EN14825                    |            |                               |                                     |              |              |        |       |        |
| C<br>O<br>O<br>L<br>I<br>N<br>G                            | Power supply                             |                    | 1Ø 50Hz  |            |                               | 3Ø 50Hz                             |              |              |        |       |        |
|  |  |                    | Ø, Hz  |            |                               |                                     |              |              |        |       |        |
|  |  |                    | V  | 220V       | 230V                          | 240V                                | 380V         | 400V         | 415V   | Min   | Max    |
|  | Capacity                                 |                    | kW   | 7.1        | 7.1                           | 7.1                                 | -            | -            | -      | 3.2   | 8.0    |
|  |  |                    | BTU/h  | 24200      | 24200                         | 24200                               | -            | -            | -      | 10900 | 27300  |
|  | Current                                  |                    | A  | 0.40       | 0.39                          | 0.38                                | 2.80         | 2.70         | 2.60   | -     | -      |
|  | Input power                              |                    | W  | 42         | 42                            | 42                                  | 1.758k       | 1.758k       | 1.758k | -     | -      |
|  |  |                    | TOTAL W  | -          | -                             | -                                   | 1.800k       | 1.800k       | 1.800k | 560   | 2.650k |
|  | Annual consumption                       |                    | TOTAL kWh *4   | -          | -                             | -                                   | -            | 900          | -      | -     | -      |
|  | EER/EER CLASS                            |                    | TOTAL (W/W) <sup>7</sup> ("A"-G)                         | -          | -                             | -                                   | 3.94         | 3.94/A       | 3.94   | 5.71  | 3.02   |
|  | E<br>r<br>p<br>*6                        | Pdesign            | kW   | -          | -                             | -                                   | -            | 7.1          | -      | -     | -      |
|  |  | SEER               | (W/W)  | -          | -                             | -                                   | -            | 7.3          | -      | -     | -      |
|  |  | Annual consumption | kWh  | -          | -                             | -                                   | -            | 340          | -      | -     | -      |
|  |  | Class              |  | -          | -                             | -                                   | -            | A++          | -      | -     | -      |
| Power factor   |  | %                  | -  | -          | -                             | 95                                  | 94           | 94           | -      | -     |        |
| Noise indoor   |  | dB-A (H/M/L) *7    | 37/31/28   |            |                               | -                                   |              |              | -      | -     |        |
|  |  | Power Level dB     | 52/46/43   |            |                               | -                                   |              |              | -      | -     |        |
| Noise outdoor  |  | dB-A (H/L)         | -  |            |                               | 48/-                                |              |              | -      | -     |        |
|  |  | Power Level dB     | -  |            |                               | 65/-                                |              |              | -      | -     |        |
| H<br>E<br>A<br>T<br>I<br>N<br>G                            | Capacity                                 |                    | kW   | 8.0        | 8.0                           | 8.0                                 | -            | -            | -      | 2.8   | 9.0    |
|  |  |                    | BTU/h  | 27300      | 27300                         | 27300                               | -            | -            | -      | 9600  | 30700  |
|  | Current                                  |                    | A  | 0.39       | 0.38                          | 0.37                                | 2.90         | 2.80         | 2.70   | -     | -      |
|  | Input power                              |                    | W  | 40         | 40                            | 40                                  | 1.820k       | 1.820k       | 1.820k | -     | -      |
|  |  |                    | TOTAL W  | -          | -                             | -                                   | 1.860k       | 1.860k       | 1.860k | 500   | 2.850k |
|  | COP/COP CLASS                            |                    | TOTAL (W/W) <sup>7</sup> ("A"-G)                         | -          | -                             | -                                   | 4.30         | 4.30/A       | 4.30   | 5.60  | 3.16   |
|  | E<br>r<br>p<br>*6                        | Pdesign at -10°C   | kW   | -          | -                             | -                                   | -            | 7.1          | -      | -     | -      |
|  |  | Tbivalent          | °C   | -          | -                             | -                                   | -            | -10          | -      | -     | -      |
|  |  | SCOP               | (W/W)  | -          | -                             | -                                   | -            | 4.3          | -      | -     | -      |
|  |  | Annual consumption | kWh  | -          | -                             | -                                   | -            | 2312         | -      | -     | -      |
|  | Power factor                             |                    | %  | -          | -                             | -                                   | 95           | 94           | 94     | -     | -      |
|  | Noise indoor                             |                    | dB-A (H/M/L) *7  | 37/31/28   |                               |                                     | -            |              |        | -     | -      |
|  |  |                    | Power Level dB   | 52/46/43   |                               |                                     | -            |              |        | -     | -      |
|  | Noise outdoor                            |                    | dB-A (H/L)   | -          |                               |                                     | 50/-         |              |        | -     | -      |
| Power Level dB   |  |                    | -  |            |                               | 67/-                                |              |              | -      | -     |        |
| EXTRA LOW TEMP   Total capacity(kW) / Input power(W) / COP |  |                    |  |            |                               |                                     |              |              |        |       |        |
| Max Current(A) / Max Input power(W)                        |  |                    | 0.40/42  | 0.39/42    | 0.38/42                       | 7.00 / 4.15k                        | 7.00 / 4.36k | 7.00 / 4.53k | -      |       |        |
| Starting current(A) / Comp output(W)                       |  |                    | -  | -          | -                             | 2.90 / 2.0k                         | 2.80 / 2.0k  | 2.70 / 2.0k  | -      |       |        |
| Network Impedance(ΩMAX.)                                   |  |                    | -  |            |                               | -                                   |              |              | -      |       |        |
| Fan motor output (Indoor/Outdoor) W                        |  |                    | 60   |            |                               | 90                                  |              |              | -      |       |        |
| Moisture removal volume                                    |  |                    | L/h(Pt/h)  | 2.5        | (5.3)                         | -                                   |              |              | -      |       |        |
| External static pressure                                   |  |                    | Pa   | -          |                               |                                     | -            |              |        | -     |        |
| Indoor Air flow *7   | Cooling                                  | m³/min (ft³/min)   | 22.0/16.0/13.0 (777)/(565)/(459)                         |            |                               | -                                   |              |              | -      | -     |        |
|  | Heating                                  | m³/min (ft³/min)   | 22.0/16.0/13.0 (777)/(565)/(459)                         |            |                               | -                                   |              |              | -      | -     |        |
| Outdoor Air flow   | Cooling                                  | m³/min (ft³/min)   | -  |            |                               | 60 (2119)                           |              |              | -      | -     |        |
|  | Heating                                  | m³/min (ft³/min)   | -  |            |                               | 60 (2119)                           |              |              | -      | -     |        |
| Refrigerant type / amount g(oz)                            |  |                    | -  |            |                               | R410A 2.35k (82.9)                  |              |              | -      |       |        |
| Product dimension  |  | Height mm(inch)    | 256  | (10-5/64)  |                               | 996 (39-7/32)                       |              |              | -      |       |        |
|  |  | Width mm(inch)     | 840  | (33-5/64)  |                               | 940 (37-1/32)                       |              |              | -      |       |        |
|  |  | Depth mm(inch)     | 840  | (33-5/64)  |                               | 340 (13-13/32)                      |              |              | -      |       |        |
| Product dimension (Panel)                                  |  | H×W×D mm, inch     | 33.5×950×950   |            | 1-11/32 × 37-13/32 × 37-13/32 |                                     | -            |              |        |       |        |
| Packing dimension  |  | Height mm(inch)    | 302  | (11-57/64) |                               | 1136                                |              |              | -      |       |        |
|  |  | Width mm(inch)     | 898  | (35-3/8)   |                               | 1055                                |              |              | -      |       |        |
|  |  | Depth mm(inch)     | 898  | (35-3/8)   |                               | 485                                 |              |              | -      |       |        |
| Weight   |  | (NET) kg(lb)       | 20   | (44)       |                               | 71                                  | (157)        |              | -      |       |        |
|  |  | (GROSS) kg(lb)     | 27   | (60)       |                               | 79                                  | (174)        |              | -      |       |        |
|  |  | Panel (NET) kg(lb) | 5  | (11)       |                               | -                                   |              |              | -      |       |        |
| Layers limit (actually)                                    |  |                    | 11 (12)  |            |                               | 2 (3)                               |              |              | -      |       |        |
| Operation condition  |  | Cool (DBT)         | 18°C ~ 32°C  |            |                               | -15°C ~ 46°C                        |              |              | -      |       |        |
|  |  | Heat (DBT)         | 16°C ~ 30°C  |            |                               | -20°C ~ 24°C                        |              |              | -      |       |        |
| P<br>I<br>P<br>I<br>N<br>G                                 | Pipe diameter mm (inch)                  |                    | (Liquid)Ø9.52(3/8) (Gas)Ø15.88(5/8)                      |            |                               | (Liquid)Ø9.52(3/8) (Gas)Ø15.88(5/8) |              |              | -      |       |        |
|  | Connecting method, Standard length m(ft) |                    | flared type, 5.0(16.4)                                   |            |                               | flared type, 5.0(16.4)              |              |              | -      |       |        |
| Pipe length range  |  | m (ft)             | 5 ~ 50m (16.4 ~164)                                      |            |                               | -                                   |              |              | -      |       |        |
| Indoor unit & Outdoor unit height difference               |  | m (ft)             | 15m(OD located lower)/30m(OD located higher) (49.2/98.4) |            |                               | -                                   |              |              | -      |       |        |
| Add gas amount   |  | g/m (oz/ft)        | 50g (0.538)  |            |                               | -                                   |              |              | -      |       |        |
| Pipe length for additional gas                             |  | m (ft)             | 30m (98.4)   |            |                               | -                                   |              |              | -      |       |        |

\*1 In case it is necessary to indicate the air flow volume in (l/s), the value in (m³/min.) shall be multiplied by 16.7 and rounded down the decimal point.

\*2 If the EUROVENT Certified models can be operated under the "extra-low" temperature condition, -7°C dry bulb and -8°C wet-bulb temperatures with rated voltage 230V shall be used.

\*3 Network Impedance shall be applicable for EUROPE and CHINA models.

\*4 The annual consumption is calculated by multiplying the input power at 230V(400V) by an average of 500 hours per year in cooling mode.

\*5 EER and COP classification is at 230V(400V) only in accordance with EU directive 2002/31/EC.

\*6 SEER and SCOP classification is at 230V(400V) only in accordance with EN-14825. For heating, SCOP indicates the value of only Average heating season, Other fiche data indicates in an attached sheet.

\*7 H: High at setting 5 stage (Level 5), M: Middle at setting 5 stage (Level 3), L: Low at setting 5 stage (Level 1)

# Simultaneous (Twin) -Type

## 1-1. Unit Specifications

PE1

### 1. 4-Way Cassette Type S-71PU2E5A×2 / U-140PE1E8A

| INDOOR   |                | MODEL  | S-71PU2E5A×2                                      |                               |                                     | -              |              |        | -     |        |
|--|----------------|--|---|-------------------------------|-------------------------------------|----------------|--------------|--------|-------|--------|
| PANEL  |                | MODEL  | Standard type:CZ-KPU3×2 / ECONAVI type:CZ-KPU3A×2 |                               |                                     | -              |              |        | -     |        |
| OUTDOOR  |                | MODEL  | -   |                               |                                     | U-140PE1E8A    |              |        | -     |        |
| Branch pipe  |                | MODEL  | -   |                               |                                     | CZ-P155BK1     |              |        | -     |        |
| Performance test condition                                 |                | ISO5151 / EN14511 / EN12102 / EN14825                    |   |                               |                                     |                |              |        |       |        |
| C<br>O<br>L<br>L<br>I<br>N<br>G                            | Power supply   | ∅, Hz  | 1∅ 50Hz   |                               |                                     | 3∅ 50Hz        |              |        |       |        |
|  |                | V  | 220V  | 230V                          | 240V                                | 380V           | 400V         | 415V   | Min   | Max    |
|  | Capacity       | kW   | 14.0  | 14.0                          | 14.0                                | -              | -            | -      | 3.3   | 15.5   |
|  |                | BTU/h  | 47800   | 47800                         | 47800                               | -              | -            | -      | 11300 | 52900  |
|  | Current        | A  | 0.40×2  | 0.39×2                        | 0.38×2                              | 6.70           | 6.35         | 6.15   | -     | -      |
|  |                | W  | 42×2  | 42×2                          | 42×2                                | 4.156k         | 4.156k       | 4.156k | -     | -      |
|  | Input power    | TOTAL W  | -   | -                             | -                                   | 4.240k         | 4.240k       | 4.240k | 770   | 5.740k |
|  |                | Annual consumption                                       | TOTAL kWh *4                                      | -                             | -                                   | -              | -            | 2120   | -     | -      |
|  | EER/EER CLASS  | TOTAL (W/W) *5 / ("A"-G)                                 | -   | -                             | -                                   | 3.30           | 3.30/A       | 3.30   | 4.29  | 2.70   |
|  | Erp *6         | Pdesign  | kW  | -                             | -                                   | -              | -            | 14.0   | -     | -      |
|  |                | η <sub>s.c</sub>   | %   | -                             | -                                   | -              | -            | 259.7  | -     | -      |
|  |                | Annual consumption                                       | kWh   | -                             | -                                   | -              | -            | -      | -     | -      |
|  |                | Class  | -   | -                             | -                                   | -              | -            | -      | -     | -      |
|  | Power factor   | %  | -   | -                             | -                                   | 94             | 94           | 94     | -     | -      |
|  | Noise indoor   | dB-A (H/M/L) *7  | 37/31/28  |                               |                                     | -              |              |        | -     | -      |
| Power Level dB   |                | 52/46/43   |   |                               | -                                   |                |              | -      | -     |        |
| Noise outdoor  | dB-A (H/L)     | -  |   |                               | 54/-                                |                |              | -      | -     |        |
|  | Power Level dB | -  |   |                               | 71/-                                |                |              | -      | -     |        |
| H<br>E<br>A<br>T<br>I<br>N<br>G                            | Capacity       | kW   | 16.0  | 16.0                          | 16.0                                | -              | -            | -      | 4.1   | 18.0   |
|  |                | BTU/h  | 54600   | 54600                         | 54600                               | -              | -            | -      | 14000 | 61400  |
|  | Current        | A  | 0.39×2  | 0.38×2                        | 0.37×2                              | 5.90           | 5.60         | 5.40   | -     | -      |
|  |                | W  | 40×2  | 40×2                          | 40×2                                | 3.640k         | 3.640k       | 3.640k | -     | -      |
|  | Input power    | TOTAL W  | -   | -                             | -                                   | 3.720k         | 3.720k       | 3.720k | 790   | 5.720k |
|  |                | COP/COP CLASS  | TOTAL (W/W) *5 / ("A"-G)                          | -                             | -                                   | -              | 4.30         | 4.30/A | 4.30  | 5.19   |
|  | Erp *6         | Pdesign at -10°C   | kW  | -                             | -                                   | -              | -            | 14.0   | -     | -      |
|  |                | Tbivalent  | °C  | -                             | -                                   | -              | -            | -7     | -     | -      |
|  |                | η <sub>s.h</sub>   | %   | -                             | -                                   | -              | -            | 152.9  | -     | -      |
|  |                | Annual consumption                                       | kWh   | -                             | -                                   | -              | -            | -      | -     | -      |
|  | Class          | -  | -   | -                             | -                                   | -              | -            | -      | -     | -      |
|  | Power factor   | %  | -   | -                             | -                                   | 94             | 94           | 94     | -     | -      |
|  | Noise indoor   | dB-A (H/M/L) *7  | 37/31/28  |                               |                                     | -              |              |        | -     | -      |
|  |                | Power Level dB   | 52/46/43  |                               |                                     | -              |              |        | -     | -      |
|  | Noise outdoor  | dB-A (H/L)   | -   |                               |                                     | 55/-           |              |        | -     | -      |
| Power Level dB   |                | -  |   |                               | 71/-                                |                |              | -      | -     |        |
| EXTRA LOW TEMP   Total capacity(kW) / Input power(W) / COP |                | -  |   |                               |                                     |                |              |        |       |        |
| Max Current(A) / Max Input power(W)                        |                | 0.40×2/42×2  | 0.39×2/42×2                                       | 0.38×2/42×2                   | 11.0 / 6.80k                        | 11.0 / 7.15k   | 11.0 / 7.45k | -      |       |        |
| Starting current(A) / Comp output(W)                       |                | -  | -   | -                             | 6.70 / 3.0k                         | 6.35 / 3.0k    | 6.15 / 3.0k  | -      |       |        |
| Network Impedance(ΩMAX.)                                   |                | -  |   |                               |                                     |                |              |        |       |        |
| Fan motor output (Indoor/Outdoor) W                        |                | 60   |   |                               | 90×2                                |                |              | -      |       |        |
| Moisture removal volume                                    |                | L/h(Pt/h)  | 5.0   | (2.5×2)                       | (10.5)                              | -              |              |        | -     |        |
| External static pressure                                   |                | Pa   | -   |                               |                                     | -              |              |        | -     |        |
| Indoor Air flow *7   | Cooling        | m³/min (ft³/min)   | 22.0×2/16.0×2/13.0×2 (777)×2/(565)×2/(459)×2      |                               |                                     | -              |              |        | -     |        |
|  | Heating        | m³/min (ft³/min)   | 22.0×2/16.0×2/13.0×2 (777)×2/(565)×2/(459)×2      |                               |                                     | -              |              |        | -     |        |
| Outdoor Air flow   | Cooling        | m³/min (ft³/min)   | -   |                               |                                     | 135 (4767)     |              |        | -     |        |
|  | Heating        | m³/min (ft³/min)   | -   |                               |                                     | 120 (4238)     |              |        | -     |        |
| Refrigerant type / amount g(oz)                            |                | -  |   |                               | R410A 3.40k (119.9)                 |                |              | -      |       |        |
| Product dimension  | Height         | mm(inch)   | 256   | (10-5/64)                     |                                     | 1416 (55-3/4)  |              |        | -     |        |
|  | Width          | mm(inch)   | 840   | (33-5/64)                     |                                     | 940 (37-1/32)  |              |        | -     |        |
|  | Depth          | mm(inch)   | 840   | (33-5/64)                     |                                     | 340 (13-13/32) |              |        | -     |        |
| Product dimension (Panel)                                  |                | H×W×D mm, inch   | 33.5×950×950                                      | 1-11/32 × 37-13/32 × 37-13/32 |                                     | -              |              |        | -     |        |
| Packing dimension  | Height         | mm(inch)   | 302   | (11-57/64)                    |                                     | 1556           |              |        | -     |        |
|  | Width          | mm(inch)   | 898   | (35-3/8)                      |                                     | 1055           |              |        | -     |        |
|  | Depth          | mm(inch)   | 898   | (35-3/8)                      |                                     | 485            |              |        | -     |        |
| Weight   | (NET)          | kg(lb)   | 20  | (44)                          |                                     | 98             | (216)        |        | -     |        |
|  | (GROSS)        | kg(lb)   | 27  | (60)                          |                                     | 108            | (238)        |        | -     |        |
|  | Panel (NET)    | kg(lb)   | 5   | (11)                          |                                     | -              |              |        | -     |        |
| Layers limit (actually)                                    |                | 11 (12)  |   |                               | 1 (2)                               |                |              | -      |       |        |
| Operation condition  | Cool (DBT)     | 18°C ~ 32°C  |   |                               | -15°C ~ 46°C                        |                |              | -      |       |        |
|  | Heat (DBT)     | 16°C ~ 30°C  |   |                               | -20°C ~ 24°C                        |                |              | -      |       |        |
| Pipe diameter mm (inch)                                    |                | (Liquid)∅9.52(3/8) (Gas)∅15.88(5/8)                      |   |                               | (Liquid)∅9.52(3/8) (Gas)∅15.88(5/8) |                |              | -      |       |        |
| Connecting method, Standard length m(ft)                   |                | flared type, 5.0(16.4)                                   |   |                               | flared type, 5.0(16.4)              |                |              | -      |       |        |
| Pipe length range m (ft)                                   |                | 5 ~ 75m (16.4 ~ 246.1)                                   |   |                               |                                     |                |              |        |       |        |
| Indoor unit & Outdoor unit height difference m (ft)        |                | 15m(OD located lower)/30m(OD located higher) (49.2/98.4) |   |                               |                                     |                |              |        |       |        |
| Add gas amount g/m (oz/ft)                                 |                | 50g (0.538)  |   |                               |                                     |                |              |        |       |        |
| Pipe length for additional gas m (ft)                      |                | 30m (98.4)   |   |                               |                                     |                |              |        |       |        |

\*1 In case it is necessary to indicate the air flow volume in (l/s), the value in (m³/min.) shall be multiplied by 16.7 and rounded down the decimal point.  
 \*2 If the EUROVENT Certified models can be operated under the "extra-low" temperature condition, -7°C dry bulb and -8°C wet-bulb temperatures with rated voltage 230V shall be used.  
 \*3 Network Impedance shall be applicable for EUROPE and CHINA models.  
 \*4 The annual consumption is calculated by multiplying the input power at 230V(400V) by an average of 500 hours per year in cooling mode.  
 \*5 EER and COP classification is at 230V(400V) only in accordance with EU directive 2002/31/EC.  
 \*6 SEER and SCOP classification is at 230V(400V) only in accordance with EN-14825. For heating, SCOP indicates the value of only Average heating season.  
 \*7 H: High at setting 5 stage (Level 5), M: Middle at setting 5 stage (Level 3), L: Low at setting 5 stage (Level 1)

# Single-Type

## 1-1. Unit Specifications

**PE1**

### 1. 4-Way Cassette Type S-100PU2E5A / U-100PE1E8A

| INDOOR                                       |  | MODEL                                     | S-100PU2E5A  |          |          | -                                   |              |              | -              |       |        |
|--|--|---|--|----------|----------|-------------------------------------|--------------|--------------|----------------|-------|--------|
| PANEL  |  | MODEL                                     | Standard type:CZ-KPU3:ECONAVI type:CZ-KPU3A              |          |          | -                                   |              |              | -              |       |        |
| OUTDOOR                                      |  | MODEL                                     | -  |          |          | U-100PE1E8A                         |              |              | -              |       |        |
| Branch pipe                                  |  | MODEL                                     | -  |          |          | -                                   |              |              | -              |       |        |
| Performance test condition                   |  | ISO5151 / EN14511 / EN12102 / EN14825     |  |          |          |                                     |              |              |                |       |        |
| C<br>O<br>O<br>L<br>I<br>N<br>G              | Power supply                             |   | 1Ø 50Hz  |          |          | 3Ø 50Hz                             |              |              |                |       |        |
|  |  |   | Ø, Hz  |          |          |                                     |              |              |                |       |        |
|  |  |   | V  | 220V     | 230V     | 240V                                | 380V         | 400V         | 415V           | Min   | Max    |
|  | Capacity                                 |   | kW   | 10.0     | 10.0     | 10.0                                | -            | -            | -              | 3.3   | 12.5   |
|  |  |   | BTU/h  | 34100    | 34100    | 34100                               | -            | -            | -              | 11300 | 42700  |
|  | Current                                  |   | A  | 0.82     | 0.79     | 0.76                                | 3.60         | 3.45         | 3.35           | -     | -      |
|  | Input power                              |   | W  | 100      | 100      | 100                                 | 2.240k       | 2.240k       | 2.240k         | -     | -      |
|  |  |   | TOTAL W  | -        | -        | -                                   | 2.340k       | 2.340k       | 2.340k         | 770   | 3.700k |
|  | Annual consumption                       |   | TOTAL kWh *4   | -        | -        | -                                   | -            | 1170         | -              | -     | -      |
|  | EER/EER CLASS                            |   | TOTAL (W/W) <sup>7</sup> ("A"-G)                         | -        | -        | -                                   | 4.27         | 4.27/A       | 4.27           | 4.29  | 3.38   |
| E<br>r<br>p<br>*<br>6                        | Pdesign                                  |   | kW   | -        | -        | -                                   | 10.0         | -            | -              | -     |        |
|  | SEER                                     |   | (W/W)  | -        | -        | -                                   | 7.4          | -            | -              | -     |        |
|  | Annual consumption                       |   | kWh  | -        | -        | -                                   | 473          | -            | -              | -     |        |
|  | Class                                    |   |  | -        | -        | -                                   | A++          | -            | -              | -     |        |
|  | Power factor                             |   | %  | -        | -        | -                                   | 95           | 94           | 93             | -     | -      |
|  | Noise indoor                             |   | dB-A (H/M/L) *7  | 45/38/32 |          |                                     | -            |              |                | -     | -      |
|  |  | Power Level dB                            | 60/53/47   |          |          | -                                   |              |              | -              | -     |        |
| Noise outdoor                                |  | dB-A (H/L)                                | -  |          |          | 52/-                                |              |              | -              | -     |        |
|  |  | Power Level dB                            | -  |          |          | 69/-                                |              |              | -              | -     |        |
| H<br>E<br>A<br>T<br>I<br>N<br>G              | Capacity                                 |   | kW   | 11.2     | 11.2     | 11.2                                | -            | -            | -              | 4.1   | 14.0   |
|  |  |   | BTU/h  | 38200    | 38200    | 38200                               | -            | -            | -              | 14000 | 47800  |
|  | Current                                  |   | A  | 0.81     | 0.78     | 0.75                                | 3.45         | 3.30         | 3.20           | -     | -      |
|  | Input power                              |   | W  | 95       | 95       | 95                                  | 2.145k       | 2.145k       | 2.145k         | -     | -      |
|  |  |   | TOTAL W  | -        | -        | -                                   | 2.240k       | 2.240k       | 2.240k         | 790   | 4.400k |
|  | COP/COP CLASS                            |   | TOTAL (W/W) <sup>7</sup> ("A"-G)                         | -        | -        | -                                   | 5.00         | 5.00/A       | 5.00           | 5.19  | 3.18   |
|  | Pdesign at -10°C                         |   | kW   | -        | -        | -                                   | -            | 10.0         | -              | -     | -      |
|  | Tbivalent                                |   | °C   | -        | -        | -                                   | -            | -10          | -              | -     | -      |
|  | SCOP                                     |   | (W/W)  | -        | -        | -                                   | -            | 4.8          | -              | -     | -      |
|  | Annual consumption                       |   | kWh  | -        | -        | -                                   | -            | 2917         | -              | -     | -      |
| Class  |  |   | -  | -        | -        | -                                   | A++          | -            | -              | -     |        |
| Power factor                                 |  | %   | -  | -        | -        | 94                                  | 94           | 93           | -              | -     |        |
| Noise indoor                                 |  | dB-A (H/M/L) *7                           | 45/38/32   |          |          | -                                   |              |              | -              | -     |        |
|  |  | Power Level dB                            | 60/53/47   |          |          | -                                   |              |              | -              | -     |        |
| Noise outdoor                                |  | dB-A (H/L)                                | -  |          |          | 52/-                                |              |              | -              | -     |        |
|  |  | Power Level dB                            | -  |          |          | 69/-                                |              |              | -              | -     |        |
| EXTRA LOW TEMP                               |  | Total capacity(kW) / Input power(W) / COP | -  |          |          |                                     |              |              |                |       |        |
| Max Current(A) / Max Input power(W)          |  |   | 0.82/100   | 0.79/100 | 0.76/100 | 9.00 / 5.55k                        | 9.00 / 5.85k | 9.00 / 6.10k | -              |       |        |
| Starting current(A) / Comp output(W)         |  |   | -  | -        | -        | 3.60 / 3.0k                         | 3.45 / 3.0k  | 3.35 / 3.0k  | -              |       |        |
| Network Impedance(ΩMAX.)                     |  |   | -  |          |          |                                     |              |              |                |       |        |
| Fan motor output (Indoor/Outdoor) W          |  |   | 90   |          |          | 90 × 2                              |              |              | -              |       |        |
| Moisture removal volume                      |  | L/h(Pt/h)                                 | 2.7  |          |          | (5.7)                               |              |              | -              |       |        |
| External static pressure                     |  | Pa  | -  |          |          |                                     |              |              |                |       |        |
| Indoor Air flow *7                           | Cooling                                  | m³/min (ft³/min)                          | 36.0/26.0/18.0 (1271)/(918)/(636)                        |          |          | -                                   |              |              | -              | -     |        |
|  | Heating                                  | m³/min (ft³/min)                          | 36.0/26.0/18.0 (1271)/(918)/(636)                        |          |          | -                                   |              |              | -              | -     |        |
| Outdoor Air flow                             | Cooling                                  | m³/min (ft³/min)                          | -  |          |          | 110 (3885)                          |              |              | -              | -     |        |
|  | Heating                                  | m³/min (ft³/min)                          | -  |          |          | 95 (3355)                           |              |              | -              | -     |        |
| Refrigerant type / amount g(oz)              |  |   | -  |          |          | R410A 3.40k (119.9)                 |              |              | -              |       |        |
| Product dimension                            |  | Height mm(inch)                           | 319  |          |          | (12-9/16)                           |              |              | 1416 (55-3/4)  |       |        |
|  |  | Width mm(inch)                            | 840  |          |          | (33-5/64)                           |              |              | 940 (37-1/32)  |       |        |
|  |  | Depth mm(inch)                            | 840  |          |          | (33-5/64)                           |              |              | 340 (13-13/32) |       |        |
| Product dimension (Panel)                    |  | H×W×D mm, inch                            | 33.5×950×950   |          |          | 1-11/32 × 37-13/32 × 37-13/32       |              |              | -              |       |        |
| Packing dimension                            |  | Height mm(inch)                           | 365  |          |          | (14-3/8)                            |              |              | 1556           |       |        |
|  |  | Width mm(inch)                            | 898  |          |          | (35-3/8)                            |              |              | 1055           |       |        |
|  |  | Depth mm(inch)                            | 898  |          |          | (35-3/8)                            |              |              | 485            |       |        |
| Weight                                       |  | (NET) kg(lb)                              | 25   |          |          | (55)                                |              |              | 98 (216)       |       |        |
|  |  | (GROSS) kg(lb)                            | 32   |          |          | (71)                                |              |              | 108 (238)      |       |        |
|  |  | Panel (NET) kg(lb)                        | 5  |          |          | (11)                                |              |              | -              |       |        |
| Layers limit (actually)                      |  |   | 11 (12)  |          |          | 1 (2)                               |              |              | -              |       |        |
| Operation condition                          |  | Cool (DBT)                                | 18°C ~ 32°C  |          |          | -15°C ~ 46°C                        |              |              | -              |       |        |
|  |  | Heat (DBT)                                | 16°C ~ 30°C  |          |          | -20°C ~ 24°C                        |              |              | -              |       |        |
| P<br>I<br>P<br>I<br>N<br>G                   | Pipe diameter mm (inch)                  |   | (Liquid)Ø9.52(3/8) (Gas)Ø15.88(5/8)                      |          |          | (Liquid)Ø9.52(3/8) (Gas)Ø15.88(5/8) |              |              | -              |       |        |
|  | Connecting method, Standard length m(ft) |   | flared type, 5.0(16.4)                                   |          |          | flared type, 5.0(16.4)              |              |              | -              |       |        |
| Pipe length range                            |  | m (ft)                                    | 5 ~ 75m (16.4 ~ 246.1)                                   |          |          | -                                   |              |              | -              |       |        |
| Indoor unit & Outdoor unit height difference |  | m (ft)                                    | 15m(OD located lower)/30m(OD located higher) (49.2/98.4) |          |          | -                                   |              |              | -              |       |        |
| Add gas amount                               |  | g/m (oz/ft)                               | 50g (0.538)  |          |          | -                                   |              |              | -              |       |        |
| Pipe length for additional gas               |  | m (ft)                                    | 30m (98.4)   |          |          | -                                   |              |              | -              |       |        |

\*1 In case it is necessary to indicate the air flow volume in (l/s), the value in (m³/min.) shall be multiplied by 16.7 and rounded down the decimal point.

\*2 If the EUROVENT Certified models can be operated under the "extra-low" temperature condition, -7°C dry bulb and -8°C wet-bulb temperatures with rated voltage 230V shall be used.

\*3 Network Impedance shall be applicable for EUROPE and CHINA models.

\*4 The annual consumption is calculated by multiplying the input power at 230V(400V) by an average of 500 hours per year in cooling mode.

\*5 EER and COP classification is at 230V(400V) only in accordance with EU directive 2002/31/EC.

\*6 SEER and SCOP classification is at 230V(400V) only in accordance with EN-14825. For heating, SCOP indicates the value of only Average heating season, Other fiche data indicates in an attached sheet.

\*7 H: High at setting 5 stage (Level 5), M: Middle at setting 5 stage (Level 3), L: Low at setting 5 stage (Level 1)



# Single-Type

## 1-1. Unit Specifications

PE1

### 1. 4-Way Cassette Type S-125PU2E5A / U-125PE1E8A

| INDOOR  |                    | MODEL  | S-125PU2E5A                                 |           |                                     | -                             |                |        | -      |       |        |  |
|---|--------------------|--|---|-----------|-------------------------------------|-------------------------------|----------------|--------|--------|-------|--------|--|
| PANEL   |                    | MODEL  | Standard type:CZ-KPU3:ECONAVI type:CZ-KPU3A |           |                                     | -                             |                |        | -      |       |        |  |
| OUTDOOR   |                    | MODEL  | -   |           |                                     | U-125PE1E8A                   |                |        | -      |       |        |  |
| Branch pipe   |                    | MODEL  | -   |           |                                     | -                             |                |        | -      |       |        |  |
| Performance test condition                          |                    | ISO5151 / EN14511 / EN12102 / EN14825                    |   |           |                                     |                               |                |        |        |       |        |  |
| C<br>O<br>O<br>L<br>I<br>N<br>G                     | Power supply       |  | 1Ø 50Hz                                     |           |                                     | 3Ø 50Hz                       |                |        |        |       |        |  |
|   |                    |  | Ø, Hz                                       |           |                                     |                               |                |        |        |       |        |  |
|   |                    |  | V   | 220V      | 230V                                | 240V                          | 380V           | 400V   | 415V   | Min   | Max    |  |
|   | Capacity           |  | kW  | 12.5      | 12.5                                | 12.5                          | -              | -      | -      | 3.3   | 14.0   |  |
|   |                    |  | BTU/h                                       | 42700     | 42700                               | 42700                         | -              | -      | -      | 11300 | 47800  |  |
|   | Current            |  | A   | 0.91      | 0.88                                | 0.85                          | 5.25           | 5.00   | 4.80   | -     | -      |  |
|   | Input power        |  | W   | 110       | 110                                 | 110                           | 3.260k         | 3.260k | 3.260k | -     | -      |  |
|   |                    |  | TOTAL W                                     | -         | -                                   | -                             | 3.370k         | 3.370k | 3.370k | 770   | 4.600k |  |
|   | Annual consumption |  | TOTAL kWh *4                                | -         | -                                   | -                             | -              | 1685   | -      | -     | -      |  |
|   | EER/EER CLASS      |  | TOTAL (W/W) *5 / ("A"-G)                    | -         | -                                   | -                             | 3.70           | 3.70/A | 3.70   | 4.29  | 3.04   |  |
|   | E<br>r<br>p<br>*6  | Pdesign  |   | kW        | -                                   | -                             | -              | 12.5   | -      | -     | -      |  |
|   |                    | η <sub>s.c</sub>   |   | %         | -                                   | -                             | -              | 272.4  | -      | -     | -      |  |
|   |                    | Annual consumption                                       |   | kWh       | -                                   | -                             | -              | -      | -      | -     | -      |  |
|   |                    | Class  |   |           | -                                   | -                             | -              | -      | -      | -     | -      |  |
|   | Power factor       |  | %   | -         | -                                   | -                             | 95             | 94     | 94     | -     | -      |  |
| Noise indoor  |                    | dB-A (H/M/L) *7  |   | 46/39/33  |                                     |                               | -              |        |        | -     |        |  |
|   |                    | Power Level dB   |   | 61/54/48  |                                     |                               | -              |        |        | -     |        |  |
| Noise outdoor                                       |                    | dB-A (H/L)   |   | -         |                                     |                               | 53/-           |        |        | -     |        |  |
|   |                    | Power Level dB   |   | -         |                                     |                               | 70/-           |        |        | -     |        |  |
| H<br>E<br>A<br>T<br>I<br>N<br>G                     | Capacity           |  | kW  | 14.0      | 14.0                                | 14.0                          | -              | -      | -      | 4.1   | 16.0   |  |
|   |                    |  | BTU/h                                       | 47800     | 47800                               | 47800                         | -              | -      | -      | 14000 | 54600  |  |
|   | Current            |  | A   | 0.90      | 0.87                                | 0.84                          | 4.75           | 4.50   | 4.35   | -     | -      |  |
|   | Input power        |  | W   | 105       | 105                                 | 105                           | 2.935k         | 2.935k | 2.935k | -     | -      |  |
|   |                    |  | TOTAL W                                     | -         | -                                   | -                             | 3.040k         | 3.040k | 3.040k | 790   | 5.040k |  |
|   | COP/COP CLASS      |  | TOTAL (W/W) *5 / ("A"-G)                    | -         | -                                   | -                             | 4.60           | 4.60/A | 4.60   | 5.19  | 3.17   |  |
|   | E<br>r<br>p<br>*6  | Pdesign at -10°C   |   | kW        | -                                   | -                             | -              | 12.5   | -      | -     | -      |  |
|   |                    | Tbivalent  |   | °C        | -                                   | -                             | -              | -10    | -      | -     | -      |  |
|   |                    | η <sub>s.h</sub>   |   | %         | -                                   | -                             | -              | 160.9  | -      | -     | -      |  |
|   |                    | Annual consumption                                       |   | kWh       | -                                   | -                             | -              | -      | -      | -     | -      |  |
|   | Class              |  |   | -         | -                                   | -                             | -              | -      | -      | -     |        |  |
|   | Power factor       |  | %   | -         | -                                   | -                             | 94             | 94     | 94     | -     | -      |  |
|   | Noise indoor       |  | dB-A (H/M/L) *7                             |           | 46/39/33                            |                               |                | -      |        |       | -      |  |
|   |                    |  | Power Level dB                              |           | 61/54/48                            |                               |                | -      |        |       | -      |  |
|   | Noise outdoor      |  | dB-A (H/L)                                  |           | -                                   |                               |                | 53/-   |        |       | -      |  |
| Power Level dB                                      |                    |  | -   |           |                                     | 70/-                          |                |        | -      |       |        |  |
| EXTRA LOW TEMP                                      |                    | Total capacity(kW) / Input power(W) / COP                |   |           |                                     |                               |                |        |        |       |        |  |
| Max Current(A) / Max Input power(W)                 |                    | 0.91/110   | 0.88/110                                    | 0.85/110  | 10.0 / 6.20k                        | 10.0 / 6.50k                  | 10.0 / 6.75k   | -      |        |       |        |  |
| Starting current(A) / Comp output(W)                |                    | -  | -   | -         | 5.25 / 3.0k                         | 5.00 / 3.0k                   | 4.80 / 3.0k    | -      |        |       |        |  |
| Network Impedance(ΩMAX.)                            |                    | -  |   |           |                                     |                               |                |        |        |       |        |  |
| Fan motor output (Indoor/Outdoor) W                 |                    | 90   |   |           | 90 ×2                               |                               |                | -      |        |       |        |  |
| Moisture removal volume                             |                    | L/h(Pt/h)  | 4.8   | (10.1)    |                                     |                               | -              |        |        |       |        |  |
| External static pressure                            |                    | Pa   | -   |           |                                     | -                             |                |        | -      |       |        |  |
| Indoor Air flow *7                                  | Cooling            | m³/min (ft³/min)   | 37.0/27.0/19.0 (1307)/(953)/(671)           |           |                                     | -                             |                |        | -      |       |        |  |
|   | Heating            | m³/min (ft³/min)   | 37.0/27.0/19.0 (1307)/(953)/(671)           |           |                                     | -                             |                |        | -      |       |        |  |
| Outdoor Air flow                                    | Cooling            | m³/min (ft³/min)   | -   |           |                                     | 130 (4591)                    |                |        | -      |       |        |  |
|   | Heating            | m³/min (ft³/min)   | -   |           |                                     | 110 (3885)                    |                |        | -      |       |        |  |
| Refrigerant type / amount g(oz)                     |                    | -  |   |           | R410A 3.40k (119.9)                 |                               |                | -      |        |       |        |  |
| Product dimension                                   |                    | Height mm(inch)  | 319   | (12-9/16) |                                     |                               | 1416 (55-3/4)  |        |        | -     |        |  |
|   |                    | Width mm(inch)   | 840   | (33-5/64) |                                     |                               | 940 (37-1/32)  |        |        | -     |        |  |
|   |                    | Depth mm(inch)   | 840   | (33-5/64) |                                     |                               | 340 (13-13/32) |        |        | -     |        |  |
| Product dimension (Panel)                           |                    | H×W×D mm, inch   | 33.5×950×950                                |           |                                     | 1-11/32 × 37-13/32 × 37-13/32 |                |        | -      |       |        |  |
| Packing dimension                                   |                    | Height mm(inch)  | 365   | (14-3/8)  |                                     |                               | 1556           |        |        | -     |        |  |
|   |                    | Width mm(inch)   | 898   | (35-3/8)  |                                     |                               | 1055           |        |        | -     |        |  |
|   |                    | Depth mm(inch)   | 898   | (35-3/8)  |                                     |                               | 485            |        |        | -     |        |  |
| Weight  |                    | (NET) kg(lb)   | 25  | (55)      |                                     |                               | 98             | (216)  |        |       |        |  |
|   |                    | (GROSS) kg(lb)   | 32  | (71)      |                                     |                               | 108            | (238)  |        |       |        |  |
|   |                    | Panel (NET) kg(lb)                                       | 5   | (11)      |                                     |                               | -              |        |        | -     |        |  |
| Layers limit (actually)                             |                    | 11 (12)  |   |           | 1 (2)                               |                               |                | -      |        |       |        |  |
| Operation condition                                 |                    | Cool (DBT)   | 18°C ~ 32°C                                 |           |                                     | -15°C ~ 46°C                  |                |        | -      |       |        |  |
|   |                    | Heat (DBT)   | 16°C ~ 30°C                                 |           |                                     | -20°C ~ 24°C                  |                |        | -      |       |        |  |
| Pipe diameter mm (inch)                             |                    | (Liquid)Ø9.52(3/8) (Gas)Ø15.88(5/8)                      |   |           | (Liquid)Ø9.52(3/8) (Gas)Ø15.88(5/8) |                               |                | -      |        |       |        |  |
| Connecting method, Standard length m(ft)            |                    | flared type, 5.0(16.4)                                   |   |           | flared type, 5.0(16.4)              |                               |                | -      |        |       |        |  |
| Pipe length range m (ft)                            |                    | 5 ~ 75m (16.4 ~246.1)                                    |   |           | -                                   |                               |                | -      |        |       |        |  |
| Indoor unit & Outdoor unit height difference m (ft) |                    | 15m(OD located lower)/30m(OD located higher) (49.2/98.4) |   |           | -                                   |                               |                | -      |        |       |        |  |
| Add gas amount g/m (oz/ft)                          |                    | 50g (0.538)  |   |           | -                                   |                               |                | -      |        |       |        |  |
| Pipe length for additional gas m (ft)               |                    | 30m (98.4)   |   |           | -                                   |                               |                | -      |        |       |        |  |

\*1 In case it is necessary to indicate the air flow volume in (l/s), the value in (m³/min.) shall be multiplied by 16.7 and rounded down the decimal point.  
 \*2 If the EUROVENT Certified models can be operated under the "extra-low" temperature condition, -7°C dry bulb and -8°C wet-bulb temperatures with rated voltage 230V shall be used.  
 \*3 Network Impedance shall be applicable for EUROPE and CHINA models.  
 \*4 The annual consumption is calculated by multiplying the input power at 230V(400V) by an average of 500 hours per year in cooling mode.  
 \*5 EER and COP classification is at 230V(400V) only in accordance with EU directive 2002/31/EC.  
 \*6 SEER and SCOP classification is at 230V(400V) only in accordance with EN-14825. For heating, SCOP indicates the value of only Average heating season.  
 \*7 H: High at setting 5 stage (Level 5), M: Middle at setting 5 stage (Level 3), L: Low at setting 5 stage (Level 1)

# Single-Type

## 1-1. Unit Specifications

**PE1**

### 1. 4-Way Cassette Type S-140PU2E5A / U-140PE1E8A

| INDOOR   |  | MODEL                                 | S-140PU2E5A                                 |  |                                     | -              |              |        | -     |        |
|--|--|---------------------------------------|---|--|-------------------------------------|----------------|--------------|--------|-------|--------|
| PANEL  |  | MODEL                                 | Standard type:CZ-KPU3:ECONAVI type:CZ-KPU3A |  |                                     | -              |              |        | -     |        |
| OUTDOOR  |  | MODEL                                 | -   |  |                                     | U-140PE1E8A    |              |        | -     |        |
| Branch pipe  |  | MODEL                                 | -   |  |                                     | -              |              |        | -     |        |
| Performance test condition                                 |  | ISO5151 / EN14511 / EN12102 / EN14825 |   |  |                                     |                |              |        |       |        |
| C<br>O<br>O<br>L<br>I<br>N<br>G                            | Power supply                             | Ø, Hz                                 | 1Ø 50Hz                                     |  |                                     | 3Ø 50Hz        |              |        | Min   | Max    |
|  |  | V                                     | 220V  | 230V   | 240V                                | 380V           | 400V         | 415V   | -     | -      |
|  | Capacity                                 | kW                                    | 14.0  | 14.0   | 14.0                                | -              | -            | -      | 3.3   | 15.5   |
|  |  | BTU/h                                 | 47800                                       | 47800  | 47800                               | -              | -            | -      | 11300 | 52900  |
|  | Current                                  | A                                     | 0.97  | 0.94   | 0.91                                | 6.65           | 6.30         | 6.10   | -     | -      |
|  | Input power                              | W                                     | 120   | 120  | 120                                 | 4.120k         | 4.120k       | 4.120k | -     | -      |
|  |  | TOTAL W                               | -   | -  | -                                   | 4.240k         | 4.240k       | 4.240k | 770   | 5.740k |
|  | Annual consumption                       | TOTAL kWh *4                          | -   | -  | -                                   | -              | 2120         | -      | -     | -      |
|  | EER/EER CLASS                            | TOTAL (W/W) *5 / ("A"-G)              | -   | -  | -                                   | 3.30           | 3.30/A       | 3.30   | 4.29  | 2.70   |
|  | Erp *6                                   | Pdesign                               | kW  | -  | -                                   | -              | -            | 14.0   | -     | -      |
| η <sub>s.c</sub>   |  | %                                     | -   | -  | -                                   | -              | 256.9        | -      | -     |        |
| Annual consumption   |  | kWh                                   | -   | -  | -                                   | -              | -            | -      | -     |        |
| Class  |  | -                                     | -   | -  | -                                   | -              | -            | -      | -     |        |
| Power factor   | %  | -                                     | -   | -  | 94                                  | 94             | 94           | -      | -     |        |
| Noise indoor   | dB-A (H/M/L) *7                          | 47/40/34                              |   |  | -                                   |                |              | -      | -     |        |
|  | Power Level dB                           | 62/55/49                              |   |  | -                                   |                |              | -      | -     |        |
| Noise outdoor  | dB-A (H/L)                               | -                                     |   |  | 54/-                                |                |              | -      | -     |        |
|  | Power Level dB                           | -                                     |   |  | 71/-                                |                |              | -      | -     |        |
| H<br>E<br>A<br>T<br>I<br>N<br>G                            | Capacity                                 | kW                                    | 16.0  | 16.0   | 16.0                                | -              | -            | -      | 4.1   | 18.0   |
|  |  | BTU/h                                 | 54600                                       | 54600  | 54600                               | -              | -            | -      | 14000 | 61400  |
|  | Current                                  | A                                     | 0.96  | 0.93   | 0.90                                | 5.80           | 5.55         | 5.35   | -     | -      |
|  | Input power                              | W                                     | 115   | 115  | 115                                 | 3.605k         | 3.605k       | 3.605k | -     | -      |
|  |  | TOTAL W                               | -   | -  | -                                   | 3.720k         | 3.720k       | 3.720k | 790   | 5.720k |
|  | COP/COP CLASS                            | TOTAL (W/W) *5 / ("A"-G)              | -   | -  | -                                   | 4.30           | 4.30/A       | 4.30   | 5.19  | 3.15   |
|  | Erp *6                                   | Pdesign at -10°C                      | kW  | -  | -                                   | -              | -            | 14.0   | -     | -      |
|  |  | Tbivalent                             | °C  | -  | -                                   | -              | -            | -7     | -     | -      |
|  |  | η <sub>s.h</sub>                      | %   | -  | -                                   | -              | -            | 152.9  | -     | -      |
|  |  | Annual consumption                    | kWh   | -  | -                                   | -              | -            | -      | -     | -      |
| Class  | -  | -                                     | -   | -  | -                                   | -              | -            | -      | -     |        |
| Power factor   | %  | -                                     | -   | -  | 94                                  | 94             | 94           | -      | -     |        |
| Noise indoor   | dB-A (H/M/L) *7                          | 47/40/34                              |   |  | -                                   |                |              | -      | -     |        |
|  | Power Level dB                           | 62/55/49                              |   |  | -                                   |                |              | -      | -     |        |
| Noise outdoor  | dB-A (H/L)                               | -                                     |   |  | 55/-                                |                |              | -      | -     |        |
|  | Power Level dB                           | -                                     |   |  | 71/-                                |                |              | -      | -     |        |
| EXTRA LOW TEMP   Total capacity(kW) / Input power(W) / COP |  | -                                     |   |  |                                     |                |              |        |       |        |
| Max Current(A) / Max Input power(W)                        |  | 0.97/120                              | 0.94/120                                    | 0.91/120   | 11.0 / 6.80k                        | 11.0 / 7.15k   | 11.0 / 7.45k | -      |       |        |
| Starting current(A) / Comp output(W)                       |  | -                                     | -   | -  | 6.65 / 3.0k                         | 6.30 / 3.0k    | 6.10 / 3.0k  | -      |       |        |
| Network Impedance(ΩMAX.)                                   |  | -                                     |   |  |                                     |                |              |        |       |        |
| Fan motor output (Indoor/Outdoor) W                        |  | 90                                    |   |  | 90 × 2                              |                |              | -      |       |        |
| Moisture removal volume                                    |  | L/h(P/h)                              | 6.0   | (12.6)   |                                     | -              |              |        | -     |        |
| External static pressure                                   |  | Pa                                    | -   |  |                                     | -              |              |        | -     |        |
| Indoor Air flow *7   | Cooling                                  | m³/min (ft³/min)                      | 38.0 / 29.0/20.0 (1342)/(1024)/(706)        |  |                                     | -              |              |        | -     |        |
|  | Heating                                  | m³/min (ft³/min)                      | 38.0 / 29.0/20.0 (1342)/(1024)/(706)        |  |                                     | -              |              |        | -     |        |
| Outdoor Air flow   | Cooling                                  | m³/min (ft³/min)                      | -   |  |                                     | 135 (4767)     |              |        | -     |        |
|  | Heating                                  | m³/min (ft³/min)                      | -   |  |                                     | 120 (4238)     |              |        | -     |        |
| Refrigerant type / amount g(oz)                            |  | -                                     |   |  | R410A 3.40k (119.9)                 |                |              | -      |       |        |
| Product dimension  | Height                                   | mm(inch)                              | 319   | (12-9/16)  |                                     | 1416 (55-3/4)  |              |        | -     |        |
|  | Width                                    | mm(inch)                              | 840   | (33-5/64)  |                                     | 940 (37-1/32)  |              |        | -     |        |
|  | Depth                                    | mm(inch)                              | 840   | (33-5/64)  |                                     | 340 (13-13/32) |              |        | -     |        |
| Product dimension (Panel)                                  |  | H×W×D mm, inch                        | 33.5×950×950                                |  | 1-11/32 × 37-13/32 × 37-13/32       |                | -            |        |       |        |
| Packing dimension  | Height                                   | mm(inch)                              | 365   | (14-3/8)   |                                     | 1556           |              |        | -     |        |
|  | Width                                    | mm(inch)                              | 898   | (35-3/8)   |                                     | 1055           |              |        | -     |        |
|  | Depth                                    | mm(inch)                              | 898   | (35-3/8)   |                                     | 485            |              |        | -     |        |
| Weight   | (NET)                                    | kg(lb)                                | 25  | (55)   |                                     | 98             | (216)        |        | -     |        |
|  | (GROSS)                                  | kg(lb)                                | 32  | (71)   |                                     | 108            | (238)        |        | -     |        |
|  | Panel (NET)                              | kg(lb)                                | 5   | (11)   |                                     | -              |              |        | -     |        |
| Layers limit (actually)                                    |  | 11 (12)                               |   |  | 1 (2)                               |                |              | -      |       |        |
| Operation condition  | Cool (DBT)                               | 18°C ~ 32°C                           |   |  | -15°C ~ 46°C                        |                |              | -      |       |        |
|  | Heat (DBT)                               | 16°C ~ 30°C                           |   |  | -20°C ~ 24°C                        |                |              | -      |       |        |
| P<br>I<br>P<br>I<br>N<br>G                                 | Pipe diameter mm (inch)                  | (Liquid)Ø9.52(3/8) (Gas)Ø15.88(5/8)   |   |  | (Liquid)Ø9.52(3/8) (Gas)Ø15.88(5/8) |                |              | -      |       |        |
|  | Connecting method, Standard length m(ft) | flared type, 5.0(16.4)                |   |  | flared type, 5.0(16.4)              |                |              | -      |       |        |
| Pipe length range  |  | m (ft)                                |   | 5 ~ 75m (16.4 ~ 246.1)                                   |                                     |                |              |        |       |        |
| Indoor unit & Outdoor unit height difference               |  | m (ft)                                |   | 15m(OD located lower)/30m(OD located higher) (49.2/98.4) |                                     |                |              |        |       |        |
| Add gas amount   |  | g/m (oz/ft)                           |   | 50g (0.538)  |                                     |                |              |        |       |        |
| Pipe length for additional gas                             |  | m (ft)                                |   | 30m (98.4)   |                                     |                |              |        |       |        |

\*1 In case it is necessary to indicate the air flow volume in (l/s), the value in (m³/min.) shall be multiplied by 16.7 and rounded down the decimal point.

\*2 If the EUROVENT Certified models can be operated under the "extra-low" temperature condition, -7°C dry bulb and -8°C wet-bulb temperatures with rated voltage 230V shall be used.

\*3 Network Impedance shall be applicable for EUROPE and CHINA models.

\*4 The annual consumption is calculated by multiplying the input power at 230V(400V) by an average of 500 hours per year in cooling mode.

\*5 EER and COP classification is at 230V(400V) only in accordance with EU directive 2002/31/EC.

\*6 SEER and SCOP classification is at 230V(400V) only in accordance with EN-14825. For heating, SCOP indicates the value of only Average heating season.

\*7 H: High at setting 5 stage (Level 5), M: Middle at setting 5 stage (Level 3), L: Low at setting 5 stage (Level 1)

# Single -Type

## 1-1. Unit Specifications

PE2

### 2. Ceiling Type S-36PT2E5A / U-36PE2E5A

|   |  |  |  |                                       |                                    |              |              |        |      |        |      |
|---|--|--|--|---------------------------------------|------------------------------------|--------------|--------------|--------|------|--------|------|
| INDOOR  | MODEL                                    | S-36PT2E5A                                       |  |                                       | -                                  |              |              | -      |      |        |      |
| PANEL   | MODEL                                    | -  |  |                                       | -                                  |              |              | -      |      |        |      |
| OUTDOOR   | MODEL                                    | -  |  |                                       | U-36PE2E5A                         |              |              | -      |      |        |      |
| Branch pipe   | MODEL                                    |  |  |                                       |                                    |              |              |        |      |        |      |
| Performance test condition                          |  |  |  | ISO5151 / EN14511 / EN12102 / EN14825 |                                    |              |              |        |      |        |      |
| Power supply  |  | Ø, Hz  | 1ø 50Hz                                  |                                       |                                    | 1ø 50Hz      |              |        | Min  | Max    |      |
|   |  | V  | 220V                                     | 230V                                  | 240V                               | 220V         | 230V         | 240V   |      |        |      |
| C<br>O<br>O<br>L<br>I<br>N<br>G                     | Capacity                                 | kW   | 3.6                                      | 3.6                                   | 3.6                                | -            | -            | -      | 1.5  | 4.0    |      |
|   |  | BTU/h  | 12300                                    | 12300                                 | 12300                              | -            | -            | -      | 5100 | 13600  |      |
|   | Current                                  | A  | 0.37                                     | 0.36                                  | 0.35                               | 3.55         | 3.40         | 3.25   | -    | -      |      |
|   |  | W  | 35                                       | 35                                    | 35                                 | 0.715k       | 0.715k       | 0.715k | -    | -      |      |
|   | Input power                              | TOTAL W  | -  |                                       |                                    | 0.750k       | 0.750k       | 0.750k | 240  | 890    |      |
|   |  | Annual consumption                               | TOTAL kWh *4                             | -                                     |                                    |              | -            | 375    | -    | -      | -    |
|   | EER/EER CLASS                            | TOTAL (W/W) <sup>5</sup> ("A"~"G")               | -  | -                                     | -                                  | 4.80         | 4.80/A       | 4.80   | 6.25 | 4.49   |      |
|   | Erp <sup>6</sup>                         | Pdesign  | kW                                       | -                                     | -                                  | -            | -            | 3.6    | -    | -      | -    |
|   |  | SEER   | (W/W)                                    | -                                     | -                                  | -            | -            | 6.7    | -    | -      | -    |
|   |  | Annual consumption                               | kWh                                      | -                                     | -                                  | -            | -            | 188    | -    | -      | -    |
| Class   |  |  | -  | -                                     | -                                  | -            | A++          | -      | -    | -      |      |
| Power factor  | %  | -  | -  | -                                     | 91                                 | 91           | 91           | -      | -    |        |      |
| Noise indoor  | dB-A (H/M/L)                             | 36/32/29   |  |                                       | -                                  | -            | -            | -      | -    |        |      |
|   | Power Level dB                           | 54/50/47   |  |                                       | -                                  | -            | -            | -      | -    |        |      |
| Noise outdoor                                       | dB-A (H/L)                               | -  |  |                                       | 45/-                               |              |              | -      | -    |        |      |
|   | Power Level dB                           | -  |  |                                       | 64/-                               |              |              | -      | -    |        |      |
| H<br>E<br>A<br>T<br>I<br>N<br>G                     | Capacity                                 | kW   | 4.0                                      | 4.0                                   | 4.0                                | -            | -            | -      | 1.5  | 5.0    |      |
|   |  | BTU/h  | 13600                                    | 13600                                 | 13600                              | -            | -            | -      | 5100 | 17100  |      |
|   | Current                                  | A  | 0.37                                     | 0.36                                  | 0.35                               | 3.80         | 3.65         | 3.50   | -    | -      |      |
|   |  | W  | 35                                       | 35                                    | 35                                 | 0.765k       | 0.765k       | 0.765k | -    | -      |      |
|   | Input power                              | TOTAL W  | -  |                                       |                                    | 0.800k       | 0.800k       | 0.800k | 190  | 1.110k |      |
|   |  | COP/COP CLASS                                    | TOTAL (W/W) <sup>5</sup> ("A"~"G")       | -                                     | -                                  | -            | 5.00         | 5.00/A | 5.00 | 7.89   | 4.50 |
|   | Erp <sup>6</sup>                         | Pdesign at -10°C                                 | kW                                       | -                                     | -                                  | -            | -            | 3.6    | -    | -      | -    |
|   |  | Tbivalent  | °C                                       | -                                     | -                                  | -            | -            | -10    | -    | -      | -    |
|   |  | SCOP   | (W/W)                                    | -                                     | -                                  | -            | -            | 4.3    | -    | -      | -    |
|   |  | Annual consumption                               | kWh                                      | -                                     | -                                  | -            | -            | 1172   | -    | -      | -    |
| Class   |  | -  | -  | -                                     | -                                  | A+           | -            | -      | -    |        |      |
| Power factor  | %  | -  | -  | -                                     | 91                                 | 91           | 91           | -      | -    |        |      |
| Noise indoor  | dB-A (H/M/L)                             | 36/32/29   |  |                                       | -                                  | -            | -            | -      | -    |        |      |
|   | Power Level dB                           | 54/50/47   |  |                                       | -                                  | -            | -            | -      | -    |        |      |
| Noise outdoor                                       | dB-A (H/L)                               | -  |  |                                       | 46                                 |              |              | -      | -    |        |      |
|   | Power Level dB                           | -  |  |                                       | 66                                 |              |              | -      | -    |        |      |
| EXTRA LOW TEMP                                      |  | Total capacity(kW) / Input power(W) / COP        |  | -                                     |                                    | -            |              | -      |      |        |      |
| Max Current(A) / Max Input power(W)                 |  | 0.37 / 35  | 0.36 / 35                                | 0.35 / 35                             | 11.0 / 2.20k                       | 11.0 / 2.30k | 11.0 / 2.40k | -      |      |        |      |
| Starting current(A) / Comp output(W)                |  | -  | -  | -                                     | 3.80 / 1.1k                        | 3.65 / 1.1k  | 3.50 / 1.1k  | -      |      |        |      |
| Network Impedance(ΩMAX.)                            |  | -  |  | -                                     |                                    | -            |              | -      |      |        |      |
| Fan motor output (Indoor/Outdoor) W                 |  | 43   |  | 60                                    |                                    | -            |              | -      |      |        |      |
| Moisture removal volume                             |  | L/h(Pt/h)  | 2.1                                      | (4.4)                                 | -                                  |              | -            |        |      |        |      |
| External static pressure                            |  | Pa   | -  |                                       | -                                  |              | -            |        |      |        |      |
| Indoor Air flow                                     | Cooling                                  | m³/min (ft³/min)                                 | 14.0 / 12.0 / 10.5 (494) / (424) / (371) |                                       |                                    | -            |              |        | -    | -      |      |
|   | Heating                                  | m³/min (ft³/min)                                 | 14.0 / 12.0 / 10.5 (494) / (424) / (371) |                                       |                                    | -            |              |        | -    | -      |      |
| Outdoor Air flow                                    | Cooling                                  | m³/min (ft³/min)                                 | -  |                                       |                                    | 38           | (1342)       | -      | -    |        |      |
|   | Heating                                  | m³/min (ft³/min)                                 | -  |                                       |                                    | 38           | (1342)       | -      | -    |        |      |
| Refrigerant type / amount g(oz)                     |  | -  |  | R410A                                 |                                    | 1.40k        | (49.4)       | -      |      |        |      |
| Product dimension                                   | Height                                   | mm(inch)   | 235                                      | (9-1/4)                               | 619                                | (24-3/8)     | -            |        |      |        |      |
|   | Width                                    | mm(inch)   | 960                                      | (37-25/32)                            | 799                                | (31-29/64)   | -            |        |      |        |      |
|   | Depth                                    | mm(inch)   | 690                                      | (27-5/32)                             | 299                                | (11-49/64)   | -            |        |      |        |      |
| Product dimension (Panel)                           |  | H×W×D mm, inch                                   | -  |                                       | -                                  |              | -            |        |      |        |      |
| Packing dimension                                   | Height                                   | mm(inch)   | 360                                      |                                       | 688                                |              | -            |        |      |        |      |
|   | Width                                    | mm(inch)   | 1025                                     |                                       | 931                                |              | -            |        |      |        |      |
|   | Depth                                    | mm(inch)   | 820                                      |                                       | 422                                |              | -            |        |      |        |      |
| Weight  | (NET)                                    | kg(lb)   | 27                                       | (60)                                  | 39                                 | (86)         | -            |        |      |        |      |
|   | (GROSS)                                  | kg(lb)   | 34                                       | (75)                                  | 44                                 | (97)         | -            |        |      |        |      |
|   | Panel (NET)                              | kg(lb)   | -  |                                       | -                                  |              | -            |        |      |        |      |
| Layers limit (actually)                             |  | 9 (10)   |  | 5 (6)                                 |                                    | -            |              |        |      |        |      |
| Operation condition                                 | Cool (DBT)                               | 18°C ~ 32°C                                      |  | -15°C ~ 46°C                          |                                    | -            |              |        |      |        |      |
|   | Heat (DBT)                               | 16°C ~ 30°C                                      |  | -20°C ~ 24°C                          |                                    | -            |              |        |      |        |      |
| P I P E I N G                                       | Pipe diameter mm (inch)                  | (Liquid)ø6.35(1/4) (Gas)ø12.7(1/2)               |  |                                       | (Liquid)ø6.35(1/4) (Gas)ø12.7(1/2) |              |              | -      |      |        |      |
|   | Connecting method, Standard length m(ft) | flared type, 5.0(16.4)                           |  |                                       | flared type, 5.0(16.4)             |              |              | -      |      |        |      |
| Pipe length range m (ft)                            |  | 3 ~ 40m (9.8 ~ 131.2)                            |  | -                                     |                                    | -            |              |        |      |        |      |
| Indoor unit & Outdoor unit height difference m (ft) |  | 15m (OD located lower) / 30m (OD located higher) |  | (49.2/98.4)                           |                                    | -            |              |        |      |        |      |
| Add gas amount g/m (oz/ft)                          |  | 20g  |  | (0.215)                               |                                    | -            |              |        |      |        |      |
| Pipe length for additional gas m (ft)               |  | 30m  |  | (98.4)                                |                                    | -            |              |        |      |        |      |

\*1: In case it is necessary to indicate the air flow volume in (l/s), the value in (m³/min.) shall be multiplied by 16.7 and rounded down the decimal point.  
 \*2: If the EUROVENT Certified models can be operated under the "extra-low" temperature condition, -7°C dry bulb and -8°C wet-bulb temperatures with rated voltage 230 V shall be used.  
 \*3: Network Impedance shall be applicable for EUROPE and CHINA models.  
 \*4: The annual consumption is calculated by multiplying the input power at 230V (400V) by an average of 500 hours per year in cooling mode.  
 \*5: EER and COP classification is at 230V (400V) only in accordance with EU directive 2002/31/EC.  
 \*6: SEER and SCOP classification is at 230V(400V) only in accordance with EN-14825. For heating, SCOP indicates the value of only Average heating season, Other fiche data indicates in an attached sheet.

# Simultaneous (Twin) -Type

## 1-1. Unit Specifications

**PE1**

## 2. Ceiling Type S-36PT2E5A×2 / U-71PE1E5A

| INDOOR  |  | MODEL  | S-36PT2E5A×2                        |                     |                                     | -              |            |          | -    |        |      |
|---|--|--|-------------------------------------|---------------------|-------------------------------------|----------------|------------|----------|------|--------|------|
| PANEL   |  | MODEL  | -                                   |                     |                                     | -              |            |          | -    |        |      |
| OUTDOOR   |  | MODEL  | -                                   |                     |                                     | U-71PE1E5A     |            |          | -    |        |      |
| Branch pipe   |  | MODEL  | -                                   |                     |                                     | CZ-P155BK1     |            |          | -    |        |      |
| Performance test condition  |  | ISO5151 / EN14511 / EN14825 / EN12102          |                                     |                     |                                     |                |            |          |      |        |      |
| Power supply  |  | Ø, Hz  | 1ø 50Hz                             |                     |                                     | 1ø 50Hz        |            |          | Min  | Max    |      |
|   |  | V  | 220                                 | 230                 | 240                                 | 220            | 230        | 240      |      |        |      |
| C<br>O<br>O<br>L<br>I<br>N<br>G                                       | Capacity                                 | kW   | 7.1                                 | 7.1                 | 7.1                                 | -              | -          | -        | 2.5  | 8.0    |      |
|   |  | BTU/h  | 24200                               | 24200               | 24200                               | -              | -          | -        | 8500 | 27300  |      |
|   | Current                                  | A  | 0.37×2                              | 0.36×2              | 0.35×2                              | 9.00           | 8.70       | 8.40     | -    | -      |      |
|   |  | W  | 35×2                                | 35×2                | 35×2                                | 1.875k         | 1.875k     | 1.875k   | -    | -      |      |
|   | Input power                              | TOTAL W  | -                                   |                     |                                     | 1.945k         | 1.945k     | 1.945k   | 450  | 2.780k |      |
|   |  | Annual consumption                             | TOTAL kWh *4                        | -                   |                                     |                | -          | 973      | -    | -      | -    |
|   | EER/EER CLASS                            | TOTAL (W/W) <sup>*5</sup> ("A"~"G")            | -                                   | -                   | -                                   | 3.65           | 3.65 / A   | 3.65     | 5.56 | 2.88   |      |
|   | Erp <sup>*6</sup>                        | Pdesign  | kW                                  | -                   | -                                   | -              | -          | 7.1      | -    | -      | -    |
|   |  | SEER   | (W/W)                               | -                   | -                                   | -              | -          | 6.2      | -    | -      | -    |
|   |  | Annual consumption                             | kWh                                 | -                   | -                                   | -              | -          | 401      | -    | -      | -    |
| Class   |  |  | -                                   | -                   | -                                   | -              | A++        | -        | -    | -      |      |
| Power factor  | %  | -  | -                                   | -                   | 95                                  | 94             | 93         | -        | -    |        |      |
| Noise indoor  | dB-A (H/M/L)                             | 36/32/29                                       |                                     |                     | -                                   | -              | -          | -        | -    |        |      |
|   | Power Level dB                           | 54/50/47                                       |                                     |                     | -                                   | -              | -          | -        | -    |        |      |
| Noise outdoor   | dB-A (H/L)                               | -  |                                     |                     | 48/-                                |                |            | -        | -    |        |      |
|   | Power Level dB                           | -  |                                     |                     | 65/-                                |                |            | -        | -    |        |      |
| H<br>E<br>A<br>T<br>I<br>N<br>G                                       | Capacity                                 | kW   | 8.0                                 | 8.0                 | 8.0                                 | -              | -          | -        | 2.0  | 9.0    |      |
|   |  | BTU/h  | 27300                               | 27300               | 27300                               | -              | -          | -        | 6800 | 30700  |      |
|   | Current                                  | A  | 0.37×2                              | 0.36×2              | 0.36×2                              | 8.90           | 8.60       | 8.30     | -    | -      |      |
|   |  | W  | 35×2                                | 35×2                | 35×2                                | 1.875k         | 1.875k     | 1.875k   | -    | -      |      |
|   | Input power                              | TOTAL W  | -                                   |                     |                                     | 1.945k         | 1.945k     | 1.945k   | 400  | 2.900k |      |
|   |  | COP/COP CLASS                                  | TOTAL (W/W) <sup>*5</sup> ("A"~"G") | -                   | -                                   | -              | 4.11       | 4.11 / A | 4.11 | 5.00   | 3.10 |
|   | Erp <sup>*6</sup>                        | Pdesign at -10°C                               | kW                                  | -                   | -                                   | -              | -          | 7.1      | -    | -      | -    |
|   |  | Tbivalent                                      | °C                                  | -                   | -                                   | -              | -          | -9       | -    | -      | -    |
|   |  | SCOP   | (W/W)                               | -                   | -                                   | -              | -          | 4.0      | -    | -      | -    |
|   |  | Annual consumption                             | kWh                                 | -                   | -                                   | -              | -          | 2485     | -    | -      | -    |
| Class   |  | -  | -                                   | -                   | -                                   | A+             | -          | -        | -    |        |      |
| Power factor  | %  | -  | -                                   | -                   | 96                                  | 95             | 94         | -        | -    |        |      |
| Noise indoor  | dB-A (H/M/L)                             | 36/32/29                                       |                                     |                     | -                                   | -              | -          | -        | -    |        |      |
|   | Power Level dB                           | 54/50/47                                       |                                     |                     | -                                   | -              | -          | -        | -    |        |      |
| Noise outdoor   | dB-A (H/L)                               | -  |                                     |                     | 50/-                                |                |            | -        | -    |        |      |
|   | Power Level dB                           | -  |                                     |                     | 67/-                                |                |            | -        | -    |        |      |
| EXTRA LOW TEMP <sup>†</sup> Total capacity(kW) / Input power(W) / COP |  | -  |                                     |                     |                                     |                |            |          |      |        |      |
| Max Current(A) / Max Input power(W)                                   |  | 0.37×2/35×2                                    | 0.36×2/35×2                         | 0.35×2/35×2         | 18.0/3.76k                          | 18.0/3.89k     | 18.0/4.02k | -        |      |        |      |
| Starting current(A) / Comp output(W)                                  |  | -  | -                                   | -                   | 9.00/2.0k                           | 8.70/2.0k      | 8.40/2.0k  | -        |      |        |      |
| Network Impedance(ΩMAX.)  |  | -  |                                     |                     |                                     |                |            |          |      |        |      |
| Fan motor output (Indoor/Outdoor) W                                   |  | 43   |                                     |                     | 90                                  |                |            | -        |      |        |      |
| Moisture removal volume   |  | L/h(Pt/h)                                      | 4.2                                 | (2.1×2)             | (8.8)                               | -              |            |          | -    |        |      |
| External static pressure  |  | Pa   | -                                   |                     |                                     | -              |            |          | -    |        |      |
| Indoor Air flow   | Cooling                                  | m³/min (ft³/min)                               | [14/12/10.5 (494/424/371)]×2        |                     |                                     | -              |            |          | -    |        |      |
|   | Heating                                  | m³/min (ft³/min)                               | [14/12/10.5 (494/424/371)]×2        |                     |                                     | -              |            |          | -    |        |      |
| Outdoor Air flow  | Cooling                                  | m³/min (ft³/min)                               | -                                   |                     |                                     | 60             | (2119)     | -        |      |        |      |
|   | Heating                                  | m³/min (ft³/min)                               | -                                   |                     |                                     | 60             | (2119)     | -        |      |        |      |
| Refrigerant type / amount g(oz)                                       |  | -  |                                     |                     | R410A                               | 2.35k          | (82.9)     | -        |      |        |      |
| Product dimension   | Height                                   | mm(inch)                                       | 235 (9-1/4)                         |                     |                                     | 996 (39-7/32)  |            |          | -    |        |      |
|   | Width                                    | mm(inch)                                       | 960 (37-25/32)                      |                     |                                     | 940 (37-1/32)  |            |          | -    |        |      |
|   | Depth                                    | mm(inch)                                       | 690 (27-5/32)                       |                     |                                     | 340 (13-13/32) |            |          | -    |        |      |
| Packing dimension   | Height                                   | mm(inch)                                       | 360                                 |                     |                                     | 1136           |            |          | -    |        |      |
|   | Width                                    | mm(inch)                                       | 1025                                |                     |                                     | 1055           |            |          | -    |        |      |
|   | Depth                                    | mm(inch)                                       | 820                                 |                     |                                     | 485            |            |          | -    |        |      |
| Weight  | (NET)                                    | kg(lb)   | 27 (60)                             |                     |                                     | 69 (152)       |            |          | -    |        |      |
|   | (GROSS)                                  | kg(lb)   | 34 (75)                             |                     |                                     | 77 (170)       |            |          | -    |        |      |
| Layers limit (actually)   |  | 9 (10)   |                                     |                     | 2 (3)                               |                |            | -        |      |        |      |
| Operation condition   | Cool (DBT)                               | 18°C ~ 32°C                                    |                                     |                     | -15°C ~ 46°C                        |                |            | -        |      |        |      |
|   | Heat (DBT)                               | 16°C ~ 30°C                                    |                                     |                     | -20°C ~ 24°C                        |                |            | -        |      |        |      |
| P<br>I<br>P<br>I<br>N<br>G  | Pipe diameter mm (inch)                  | (Liquid)ø6.35(1/4) (Gas)ø12.7(1/2)             |                                     |                     | (Liquid)ø9.52(3/8) (Gas)ø15.88(5/8) |                |            | -        |      |        |      |
|   | Connecting method, Standard length m(ft) | flared type, 5.0(16.4)                         |                                     |                     | flared type, 5.0(16.4)              |                |            | -        |      |        |      |
| Pipe length range   |  | m (ft)   |                                     | 5 ~ 50 (16.4 ~ 164) |                                     | -              |            |          |      |        |      |
| Indoor unit & Outdoor unit height difference m (ft)                   |  | 15 (OD located lower) / 30 (OD located higher) |                                     |                     | (49.2/98.4)                         |                |            | -        |      |        |      |
| Add gas amount g/m (oz/ft)  |  | 50 (0.538)                                     |                                     |                     | -                                   |                |            | -        |      |        |      |
| Pipe length for additional gas  |  | m (ft)   |                                     | 30 (98.4)           |                                     | -              |            |          |      |        |      |

\*1: In case it is necessary to indicate the air flow volume in (l/s), the value in (m³/min.) shall be multiplied by 16.7 and rounded down the decimal point.

\*2: If the EUROVENT Certified models can be operated under the "extra-low" temperature condition, -7°C dry bulb and -8°C wet-bulb temperatures with rated voltage 230 V shall be used.

\*3: Network Impedance shall be applicable for EUROPE and CHINA models.

\*4: The annual consumption is calculated by multiplying the input power at 230 V (400 V) by an average of 500 hours per year in cooling mode.

\*5: EER and COP classification is at 230 V (400 V) only in accordance with EU directive 2002/31/EC.

\*6: SEER and SCOP classification is at 230V(400V) only in accordance with EN-14825. For heating, SCOP indicates the value of only Average heating season, Other fiche data indicates in an attached sheet.

# Simultaneous (Triple) -Type

## 1-1. Unit Specifications

**PE1**

### 2. Ceiling Type S-36PT2E5A×3 / U-100PE1E5A

| INDOOR  | MODEL                                    | S-36PT2E5A×3                                   |                                     |                       | -                                   |                |            | -        |       |        |
|---|--|--|-------------------------------------|-----------------------|-------------------------------------|----------------|------------|----------|-------|--------|
| PANEL   | MODEL                                    | -  |                                     |                       | -                                   |                |            | -        |       |        |
| OUTDOOR   | MODEL                                    | -  |                                     |                       | U-100PE1E5A                         |                |            | -        |       |        |
| Branch pipe   | MODEL                                    | -  |                                     |                       | CZ-P3HPC2                           |                |            | -        |       |        |
| Performance test condition  |  | ISO5151 / EN14511 / EN14825 / EN12102          |                                     |                       |                                     |                |            |          |       |        |
| Power supply  |  | Ø, Hz  | 1ø 50Hz                             |                       |                                     | 1ø 50Hz        |            |          | Min   | Max    |
|   |  | V  | 220                                 | 230                   | 240                                 | 220            | 230        | 240      |       |        |
| C<br>O<br>O<br>L<br>I<br>N<br>G                                       | Capacity                                 | kW   | 10.0                                | 10.0                  | 10.0                                | -              | -          | -        | 3.3   | 15.5   |
|   |  | BTU/h  | 34100                               | 34100                 | 34100                               | -              | -          | -        | 11300 | 42700  |
|   | Current                                  | A  | 0.37×3                              | 0.36×3                | 0.35×3                              | 11.5           | 11.1       | 10.6     | -     | -      |
|   |  | W  | 35×3                                | 35×3                  | 35×3                                | 2.450k         | 2.450k     | 2.450k   | -     | -      |
|   | Input power                              | TOTAL W  | -                                   |                       |                                     | 2.555k         | 2.555k     | 2.555k   | 840   | 3.850k |
|   |  | Annual consumption                             | TOTAL kWh *4                        | -                     |                                     |                | -          | 1278     | -     | -      |
|   | EER/EER CLASS                            | TOTAL (W/W) <sup>*5</sup> ("A"~"G")            | -                                   | -                     | -                                   | 3.91           | 3.91 / A   | 3.91     | 3.93  | 3.25   |
|   | Erp <sup>*6</sup>                        | Pdesign  | kW                                  | -                     | -                                   | -              | -          | 10.0     | -     | -      |
|   |  | SEER   | (W/W)                               | -                     | -                                   | -              | -          | 6.5      | -     | -      |
|   |  | Annual consumption                             | kWh                                 | -                     | -                                   | -              | -          | 539      | -     | -      |
| Class   |  |  | -                                   | -                     | -                                   | -              | A++        | -        | -     |        |
| Power factor  | %  | -  | -                                   | -                     | 97                                  | 96             | 96         | -        | -     |        |
| Noise indoor  | dB-A (H/M/L)                             | 36/32/29                                       |                                     |                       | -                                   | -              | -          | -        | -     |        |
|   | Power Level dB                           | 54/50/47                                       |                                     |                       | -                                   | -              | -          | -        | -     |        |
| Noise outdoor   | dB-A (H/L)                               | -  |                                     |                       | 52/-                                |                |            | -        | -     |        |
|   | Power Level dB                           | -  |                                     |                       | 69/-                                |                |            | -        | -     |        |
| H<br>E<br>A<br>T<br>I<br>N<br>G                                       | Capacity                                 | kW   | 11.2                                | 11.2                  | 11.2                                | -              | -          | -        | 4.1   | 14.0   |
|   |  | BTU/h  | 38200                               | 38200                 | 38200                               | -              | -          | -        | 14000 | 47800  |
|   | Current                                  | A  | 0.37×3                              | 0.36×3                | 0.35×3                              | 11.8           | 11.4       | 11.0     | -     | -      |
|   |  | W  | 35×3                                | 35×3                  | 35×3                                | 2.520k         | 2.520k     | 2.520k   | -     | -      |
|   | Input power                              | TOTAL W  | -                                   |                       |                                     | 2.625k         | 2.625k     | 2.625k   | 900   | 4.400k |
|   |  | COP/COP CLASS                                  | TOTAL (W/W) <sup>*5</sup> ("A"~"G") | -                     | -                                   | -              | 4.27       | 4.27 / A | 4.27  | 4.56   |
|   | Erp <sup>*6</sup>                        | Pdesign at -10°C                               | kW                                  | -                     | -                                   | -              | -          | 10.0     | -     | -      |
|   |  | Tbivalent                                      | °C                                  | -                     | -                                   | -              | -          | -10      | -     | -      |
|   |  | SCOP   | (W/W)                               | -                     | -                                   | -              | -          | 4.3      | -     | -      |
|   |  | Annual consumption                             | kWh                                 | -                     | -                                   | -              | -          | 3256     | -     | -      |
| Class   |  | -  | -                                   | -                     | -                                   | A+             | -          | -        |       |        |
| Power factor  | %  | -  | -                                   | -                     | 97                                  | 96             | 95         | -        | -     |        |
| Noise indoor  | dB-A (H/M/L)                             | 36/32/29                                       |                                     |                       | -                                   | -              | -          | -        | -     |        |
|   | Power Level dB                           | 54/50/47                                       |                                     |                       | -                                   | -              | -          | -        | -     |        |
| Noise outdoor   | dB-A (H/L)                               | -  |                                     |                       | 52/-                                |                |            | -        | -     |        |
|   | Power Level dB                           | -  |                                     |                       | 69/-                                |                |            | -        | -     |        |
| EXTRA LOW TEMP <sup>†</sup> Total capacity(kW) / Input power(W) / COP |  | -  |                                     |                       |                                     |                |            |          |       |        |
| Max Current(A) / Max Input power(W)                                   |  | 0.37×3/35×3                                    | 0.36×3/35×3                         | 0.35×3/35×3           | 25.0/5.34k                          | 25.0/5.52k     | 25.0/5.70k | -        |       |        |
| Starting current(A) / Comp output(W)                                  |  | -  | -                                   | -                     | 11.8/3.0k                           | 11.4/3.0k      | 11.0/3.0k  | -        |       |        |
| Network Impedance(ΩMAX.)  |  | -  |                                     |                       |                                     |                |            |          |       |        |
| Fan motor output (Indoor/Outdoor) W                                   |  | 43   |                                     |                       | 90×2                                |                |            | -        |       |        |
| Moisture removal volume   |  | L/h(Pt/h)                                      | 6.0                                 | (2.0×3)               | (12.6)                              | -              |            |          | -     |        |
| External static pressure  |  | Pa   | -                                   |                       |                                     | -              |            |          | -     |        |
| Indoor Air flow   | Cooling                                  | m³/min (ft³/min)                               | [14/12/10.5 (494/424/371)]×3        |                       |                                     | -              |            |          | -     |        |
|   | Heating                                  | m³/min (ft³/min)                               | [14/12/10.5 (494/424/371)]×3        |                       |                                     | -              |            |          | -     |        |
| Outdoor Air flow  | Cooling                                  | m³/min (ft³/min)                               | -                                   |                       |                                     | 110            | (3885)     | -        |       |        |
|   | Heating                                  | m³/min (ft³/min)                               | -                                   |                       |                                     | 95             | (3355)     | -        |       |        |
| Refrigerant type / amount g(oz)                                       |  | -  |                                     |                       | R410A                               | 3.40k          | (119.9)    | -        |       |        |
| Product dimension   | Height                                   | mm(inch)                                       | 235 (9-1/4)                         |                       |                                     | 1416 (55-3/4)  |            |          | -     |        |
|   | Width                                    | mm(inch)                                       | 960 (37-25/32)                      |                       |                                     | 940 (37-1/32)  |            |          | -     |        |
|   | Depth                                    | mm(inch)                                       | 690 (27-5/32)                       |                       |                                     | 340 (13-13/32) |            |          | -     |        |
| Packing dimension   | Height                                   | mm(inch)                                       | 360                                 |                       |                                     | 1556           |            |          | -     |        |
|   | Width                                    | mm(inch)                                       | 1025                                |                       |                                     | 1055           |            |          | -     |        |
|   | Depth                                    | mm(inch)                                       | 820                                 |                       |                                     | 485            |            |          | -     |        |
| Weight  | (NET)                                    | kg(lb)   | 27 (60)                             |                       |                                     | 98 (216)       |            |          | -     |        |
|   | (GROSS)                                  | kg(lb)   | 34 (75)                             |                       |                                     | 108 (238)      |            |          | -     |        |
| Layers limit (actually)   |  | 9 (10)   |                                     |                       | 1 (2)                               |                |            | -        |       |        |
| Operation condition   | Cool (DBT)                               | 18°C ~ 32°C                                    |                                     |                       | -15°C ~ 46°C                        |                |            | -        |       |        |
|   | Heat (DBT)                               | 16°C ~ 30°C                                    |                                     |                       | -20°C ~ 24°C                        |                |            | -        |       |        |
| P<br>I<br>P<br>I<br>N<br>G  | Pipe diameter mm (inch)                  | (Liquid)ø6.35(1/4) (Gas)ø12.7(1/2)             |                                     |                       | (Liquid)ø9.52(3/8) (Gas)ø15.88(5/8) |                |            | -        |       |        |
|   | Connecting method, Standard length m(ft) | flared type, 5.0(16.4)                         |                                     |                       | flared type, 5.0(16.4)              |                |            | -        |       |        |
| Pipe length range   |  | m (ft)   |                                     | 5 ~ 75 (16.4 ~ 246.1) |                                     | -              |            |          |       |        |
| Indoor unit & Outdoor unit height difference m (ft)                   |  | 15 (OD located lower) / 30 (OD located higher) |                                     |                       | (49.2/98.4)                         |                |            | -        |       |        |
| Add gas amount g/m (oz/ft)  |  | 50 (0.538)                                     |                                     |                       | -                                   |                |            | -        |       |        |
| Pipe length for additional gas m (ft)                                 |  | 20 (65.6)                                      |                                     |                       | -                                   |                |            | -        |       |        |

\*1: In case it is necessary to indicate the air flow volume in (l/s), the value in (m³/min.) shall be multiplied by 16.7 and rounded down the decimal point.

\*2: If the EUROVENT Certified models can be operated under the "extra-low" temperature condition, -7°C dry bulb and -8°C wet-bulb temperatures with rated voltage 230 V shall be used.

\*3: Network Impedance shall be applicable for EUROPE and CHINA models.

\*4: The annual consumption is calculated by multiplying the input power at 230 V (400 V) by an average of 500 hours per year in cooling mode.

\*5: EER and COP classification is at 230 V (400 V) only in accordance with EU directive 2002/31/EC.

\*6: SEER and SCOP classification is at 230V(400V) only in accordance with EN-14825. For heating, SCOP indicates the value of only Average heating season, Other fiche data indicates in an attached sheet.

# Simultaneous (Double-Twin) -Type

## 1-1. Unit Specifications

**PE1**

### 2. Ceiling Type S-36PT2E5A×4 / U-125PE1E5A

| INDOOR   |  | MODEL  | S-36PT2E5A×4                 |             |                                     | -              |            |          | -     |        |      |
|--|--|--|------------------------------|-------------|-------------------------------------|----------------|------------|----------|-------|--------|------|
| PANEL  |  | MODEL  | -                            |             |                                     | -              |            |          | -     |        |      |
| OUTDOOR  |  | MODEL  | -                            |             |                                     | U-125PE1E5A    |            |          | -     |        |      |
| Branch pipe  |  | MODEL  | -                            |             |                                     | CZ-P155BK1×3   |            |          | -     |        |      |
| Performance test condition                               |  | ISO5151 / EN14511 / EN12102 / EN14825          |                              |             |                                     |                |            |          |       |        |      |
| Power supply   |  | Ø, Hz  | 1ø 50Hz                      |             |                                     | 1ø 50Hz        |            |          |       |        |      |
|  |  | V  | 220                          | 230         | 240                                 | 220            | 230        | 240      | Min   | Max    |      |
| C<br>O<br>O<br>L<br>I<br>N<br>G                          | Capacity                                 | kW   | 12.5                         | 12.5        | 12.5                                | -              | -          | -        | 3.3   | 14.0   |      |
|  |  | BTU/h  | 42700                        | 42700       | 42700                               | -              | -          | -        | 11300 | 47800  |      |
|  | Current                                  | A  | 0.37×4                       | 0.36×4      | 0.35×4                              | 17.0           | 16.4       | 15.8     | -     | -      |      |
|  |  | W  | 35×4                         | 35×4        | 35×4                                | 3.620k         | 3.620k     | 3.620k   | -     | -      |      |
|  | Input power                              | TOTAL W  | -                            |             |                                     | 3.760k         | 3.760k     | 3.760k   | 840   | 4.860k |      |
|  |  | Annual consumption                             | TOTAL kWh *4                 | -           |                                     |                | -          | 1880     | -     | -      | -    |
|  | EER/EER CLASS                            | TOTAL (W/W) *5 ("A"~"G")                       | -                            | -           | -                                   | 3.32           | 3.32 / A   | 3.32     | 3.93  | 2.88   |      |
|  | Erp *6                                   | Pdesign  | kW                           | -           | -                                   | -              | -          | 12.5     | -     | -      | -    |
|  |  | η <sub>s,c</sub>                               | %                            | -           | -                                   | -              | -          | 241.1    | -     | -      | -    |
|  |  | Annual consumption                             | kWh                          | -           | -                                   | -              | -          | -        | -     | -      | -    |
| Class  |  |  | -                            | -           | -                                   | -              | -          | -        | -     | -      |      |
| Power factor   | %  | -  | -                            | -           | 97                                  | 96             | 95         | -        | -     |        |      |
| Noise indoor   | dB-A (H/M/L)                             | 36/32/29                                       |                              |             | -                                   | -              | -          | -        | -     |        |      |
|  | Power Level dB                           | 54/50/47                                       |                              |             | -                                   | -              | -          | -        | -     |        |      |
| Noise outdoor  | dB-A (H/L)                               | -  |                              |             | 53/-                                |                |            | -        | -     |        |      |
|  | Power Level dB                           | -  |                              |             | 70/-                                |                |            | -        | -     |        |      |
| H<br>E<br>A<br>T<br>I<br>N<br>G                          | Capacity                                 | kW   | 14.0                         | 14.0        | 14.0                                | -              | -          | -        | 4.1   | 16.0   |      |
|  |  | BTU/h  | 47800                        | 47800       | 47800                               | -              | -          | -        | 14000 | 54600  |      |
|  | Current                                  | A  | 0.37×4                       | 0.36×4      | 0.35×4                              | 16.0           | 15.4       | 14.9     | -     | -      |      |
|  |  | W  | 35×4                         | 35×4        | 35×4                                | 3.400k         | 3.400k     | 3.400k   | -     | -      |      |
|  | Input power                              | TOTAL W  | -                            |             |                                     | 3.540k         | 3.540k     | 3.540k   | 900   | 5.210k |      |
|  |  | COP/COP CLASS                                  | TOTAL (W/W) *5 ("A"~"G")     | -           | -                                   | -              | 3.95       | 3.95 / A | 3.95  | 4.56   | 3.07 |
|  | Erp *6                                   | Pdesign at -10°C                               | kW                           | -           | -                                   | -              | -          | 12.5     | -     | -      | -    |
|  |  | Tbivalent                                      | °C                           | -           | -                                   | -              | -          | -10      | -     | -      | -    |
|  |  | η <sub>s,h</sub>                               | %                            | -           | -                                   | -              | -          | 150.1    | -     | -      | -    |
|  |  | Annual consumption                             | kWh                          | -           | -                                   | -              | -          | -        | -     | -      | -    |
| Class  |  | -  | -                            | -           | -                                   | -              | -          | -        | -     |        |      |
| Power factor   | %  | -  | -                            | -           | 97                                  | 96             | 95         | -        | -     |        |      |
| Noise indoor   | dB-A (H/M/L)                             | 36/32/29                                       |                              |             | -                                   | -              | -          | -        | -     |        |      |
|  | Power Level dB                           | 54/50/47                                       |                              |             | -                                   | -              | -          | -        | -     |        |      |
| Noise outdoor  | dB-A (H/L)                               | -  |                              |             | 53/-                                |                |            | -        | -     |        |      |
|  | Power Level dB                           | -  |                              |             | 70/-                                |                |            | -        | -     |        |      |
| EXTRA LOW TEMP Total capacity(kW) / Input power(W) / COP |  | -  |                              |             |                                     |                |            |          |       |        |      |
| Max Current(A) / Max Input power(W)                      |  | 0.37×4/35×4                                    | 0.36×4/35×4                  | 0.35×4/35×4 | 28.0/5.98k                          | 28.0/6.18k     | 28.0/6.38k | -        |       |        |      |
| Starting current(A) / Comp output(W)                     |  | -  | -                            | -           | 17.0/3.0k                           | 16.4/3.0k      | 15.8/3.0k  | -        |       |        |      |
| Network Impedance(ΩMAX.)                                 |  | -  |                              |             |                                     |                |            |          |       |        |      |
| Fan motor output (Indoor/Outdoor) W                      |  | 43   |                              |             | 90×2                                |                |            | -        |       |        |      |
| Moisture removal volume                                  |  | L/h(Pt/h)                                      | 7.9                          | (1.975×4)   | (16.6)                              | -              |            |          | -     |        |      |
| External static pressure                                 |  | Pa   | -                            |             |                                     | -              |            |          | -     |        |      |
| Indoor Air flow  | Cooling                                  | m³/min (ft³/min)                               | [14/12/10.5 (494/424/371)]×4 |             |                                     | -              |            |          | -     |        |      |
|  | Heating                                  | m³/min (ft³/min)                               | [14/12/10.5 (494/424/371)]×4 |             |                                     | -              |            |          | -     |        |      |
| Outdoor Air flow   | Cooling                                  | m³/min (ft³/min)                               | -                            |             |                                     | 130            | (4591)     | -        |       |        |      |
|  | Heating                                  | m³/min (ft³/min)                               | -                            |             |                                     | 110            | (3885)     | -        |       |        |      |
| Refrigerant type / amount g(oz)                          |  | -  |                              |             | R410A                               | 3.40k          | (119.9)    | -        |       |        |      |
| Product dimension  | Height                                   | mm(inch)                                       | 235 (9-1/4)                  |             |                                     | 1416 (55-3/4)  |            |          | -     |        |      |
|  | Width                                    | mm(inch)                                       | 960 (37-25/32)               |             |                                     | 940 (37-1/32)  |            |          | -     |        |      |
|  | Depth                                    | mm(inch)                                       | 690 (27-5/32)                |             |                                     | 340 (13-13/32) |            |          | -     |        |      |
| Packing dimension  | Height                                   | mm(inch)                                       | 360                          |             |                                     | 1556           |            |          | -     |        |      |
|  | Width                                    | mm(inch)                                       | 1025                         |             |                                     | 1055           |            |          | -     |        |      |
|  | Depth                                    | mm(inch)                                       | 820                          |             |                                     | 485            |            |          | -     |        |      |
| Weight   | (NET)                                    | kg(lb)   | 27 (60)                      |             |                                     | 98 (216)       |            |          | -     |        |      |
|  | (GROSS)                                  | kg(lb)   | 34 (75)                      |             |                                     | 108 (238)      |            |          | -     |        |      |
| Layers limit (actually)                                  |  | 9 (10)   |                              |             | 1 (2)                               |                |            | -        |       |        |      |
| Operation condition                                      | Cool (DBT)                               | 18°C ~ 32°C                                    |                              |             | -15°C ~ 46°C                        |                |            | -        |       |        |      |
|  | Heat (DBT)                               | 16°C ~ 30°C                                    |                              |             | -20°C ~ 24°C                        |                |            | -        |       |        |      |
| P<br>I<br>P<br>I<br>N<br>G                               | Pipe diameter mm (inch)                  | (Liquid)ø6.35(1/4) (Gas)ø12.7(1/2)             |                              |             | (Liquid)ø9.52(3/8) (Gas)ø15.88(5/8) |                |            | -        |       |        |      |
|  | Connecting method, Standard length m(ft) | flared type, 5.0(16.4)                         |                              |             | flared type, 5.0(16.4)              |                |            | -        |       |        |      |
| Pipe length range  |  | m (ft)   |                              |             | 5 ~ 75 (16.4 ~ 246.1)               |                |            | -        |       |        |      |
| Indoor unit & Outdoor unit height difference m (ft)      |  | 15 (OD located lower) / 30 (OD located higher) |                              |             | (49.2/98.4)                         |                |            | -        |       |        |      |
| Add gas amount g/m (oz/ft)                               |  | 50   |                              |             | (0.538)                             |                |            | -        |       |        |      |
| Pipe length for additional gas                           |  | m (ft)   |                              |             | 20 (65.6)                           |                |            | -        |       |        |      |

\*1: In case it is necessary to indicate the air flow volume in (l/s), the value in (m³/min.) shall be multiplied by 16.7 and rounded down the decimal point.

\*2: If the EUROVENT Certified models can be operated under the "extra-low" temperature condition, -7°C dry bulb and -8°C wet-bulb temperatures with rated voltage 230 V shall be used.

\*3: Network Impedance shall be applicable for EUROPE and CHINA models.

\*4: The annual consumption is calculated by multiplying the input power at 230 V (400 V) by an average of 500 hours per year in cooling mode.

\*5: EER and COP classification is at 230V (400V) only in accordance with EU directive 2002/31/EC.

\*6: SEER and SCOP classification is at 230V (400V) only in accordance with EN-14825. For heating, SCOP indicates the value of only Average heating season.

# Simultaneous (Triple) -Type

## 1-1. Unit Specifications

PE1

### 2. Ceiling Type S-45PT2E5A×3 / U-125PE1E5A

|  |  |  |                                    |                       |                                     |                |            |          |       |        |
|--|--|--|------------------------------------|-----------------------|-------------------------------------|----------------|------------|----------|-------|--------|
| INDOOR   | MODEL                                    | S-45PT2E5A×3                                   |                                    |                       | -                                   |                |            | -        |       |        |
| PANEL  | MODEL                                    | -  |                                    |                       | -                                   |                |            | -        |       |        |
| OUTDOOR  | MODEL                                    | -  |                                    |                       | U-125PE1E5A                         |                |            | -        |       |        |
| Branch pipe  | MODEL                                    | -  |                                    |                       | CZ-P3HPC2                           |                |            | -        |       |        |
| Performance test condition                               |  | ISO5151 / EN14511 / EN12102 / EN14825          |                                    |                       |                                     |                |            |          |       |        |
| Power supply   |  | Ø, Hz  | 1ø 50Hz                            |                       |                                     | 1ø 50Hz        |            |          | Min   | Max    |
|  |  | V  | 220                                | 230                   | 240                                 | 220            | 230        | 240      |       |        |
| C<br>O<br>O<br>L<br>I<br>N<br>G                          | Capacity                                 | kW   | 12.5                               | 12.5                  | 12.5                                | -              | -          | -        | 3.3   | 14.0   |
|  |  | BTU/h  | 42700                              | 42700                 | 42700                               | -              | -          | -        | 11300 | 47800  |
|  | Current                                  | A  | 0.39×3                             | 0.38×3                | 0.37×3                              | 17.0           | 16.4       | 15.8     | -     | -      |
|  |  | W  | 40×3                               | 40×3                  | 40×3                                | 3.620k         | 3.620k     | 3.620k   | -     | -      |
|  | Input power                              | TOTAL W  | -                                  |                       |                                     | 3.740k         | 3.740k     | 3.740k   | 840   | 4.860k |
|  |  | Annual consumption                             | TOTAL kWh *4                       | -                     |                                     |                | -          | 1870     | -     | -      |
|  | EER/EER CLASS                            | TOTAL (W/W) <sup>5</sup> ("A"~"G")             | -                                  | -                     | -                                   | 3.34           | 3.34 / A   | 3.34     | 3.93  | 2.88   |
|  | E<br>r<br>p<br>*<br>6                    | Pdesign  | kW                                 | -                     | -                                   | -              | -          | 12.5     | -     | -      |
|  |  | η <sub>s,c</sub>                               | %                                  | -                     | -                                   | -              | -          | 241.1    | -     | -      |
|  |  | Annual consumption                             | kWh                                | -                     | -                                   | -              | -          | -        | -     | -      |
| Class  |  |  | -                                  | -                     | -                                   | -              | -          | -        | -     |        |
| Power factor   | %  | -  | -                                  | -                     | 97                                  | 96             | 95         | -        | -     |        |
| Noise indoor   | dB-A (H/M/L)                             | 37/33/29                                       |                                    |                       | -                                   | -              | -          | -        | -     |        |
|  | Power Level dB                           | 55/51/47                                       |                                    |                       | -                                   | -              | -          | -        | -     |        |
| Noise outdoor  | dB-A (H/L)                               | -  |                                    |                       | 53/-                                |                |            | -        | -     |        |
|  | Power Level dB                           | -  |                                    |                       | 70/-                                |                |            | -        | -     |        |
| H<br>E<br>A<br>T<br>I<br>N<br>G                          | Capacity                                 | kW   | 14.0                               | 14.0                  | 14.0                                | -              | -          | -        | 4.1   | 16.0   |
|  |  | BTU/h  | 47800                              | 47800                 | 47800                               | -              | -          | -        | 14000 | 54600  |
|  | Current                                  | A  | 0.39×3                             | 0.38×3                | 0.37×3                              | 16.0           | 15.4       | 14.9     | -     | -      |
|  |  | W  | 40×3                               | 40×3                  | 40×3                                | 3.400k         | 3.400k     | 3.400k   | -     | -      |
|  | Input power                              | TOTAL W  | -                                  |                       |                                     | 3.520k         | 3.520k     | 3.520k   | 900   | 5.210k |
|  |  | COP/COP CLASS                                  | TOTAL (W/W) <sup>5</sup> ("A"~"G") | -                     | -                                   | -              | 3.98       | 3.98 / A | 3.98  | 4.56   |
|  | E<br>r<br>p<br>*<br>6                    | Pdesign at -10°C                               | kW                                 | -                     | -                                   | -              | -          | 12.5     | -     | -      |
|  |  | Tbivalent                                      | °C                                 | -                     | -                                   | -              | -          | -10      | -     | -      |
|  |  | η <sub>s,h</sub>                               | %                                  | -                     | -                                   | -              | -          | 150.1    | -     | -      |
|  |  | Annual consumption                             | kWh                                | -                     | -                                   | -              | -          | -        | -     | -      |
| Class  |  | -  | -                                  | -                     | -                                   | -              | -          | -        |       |        |
| Power factor   | %  | -  | -                                  | -                     | 97                                  | 96             | 95         | -        | -     |        |
| Noise indoor   | dB-A (H/M/L)                             | 37/33/29                                       |                                    |                       | -                                   | -              | -          | -        | -     |        |
|  | Power Level dB                           | 55/51/47                                       |                                    |                       | -                                   | -              | -          | -        | -     |        |
| Noise outdoor  | dB-A (H/L)                               | -  |                                    |                       | 53/-                                |                |            | -        | -     |        |
|  | Power Level dB                           | -  |                                    |                       | 70/-                                |                |            | -        | -     |        |
| EXTRA LOW TEMP Total capacity(kW) / Input power(W) / COP |  | -  |                                    |                       |                                     |                |            |          |       |        |
| Max Current(A) / Max Input power(W)                      |  | 0.39×3/40×3                                    | 0.38×3/40×3                        | 0.37×3/40×3           | 28.0/5.98k                          | 28.0/6.18k     | 28.0/6.38k | -        |       |        |
| Starting current(A) / Comp output(W)                     |  | -  | -                                  | -                     | 17.0/3.0k                           | 16.4/3.0k      | 15.8/3.0k  | -        |       |        |
| Network Impedance(ΩMAX.)                                 |  | -  |                                    |                       |                                     |                |            |          |       |        |
| Fan motor output (Indoor/Outdoor) W                      |  | 43   |                                    |                       | 90×2                                |                |            | -        |       |        |
| Moisture removal volume                                  |  | L/h(Pt/h)                                      | 7.9                                | (2.63×3)              | (16.6)                              | -              |            |          | -     |        |
| External static pressure                                 |  | Pa   | -                                  |                       |                                     | -              |            |          | -     |        |
| Indoor Air flow  | Cooling                                  | m³/min (ft³/min)                               | [15/12.5/10.5 (530/441/371)]×3     |                       |                                     | -              |            |          | -     |        |
|  | Heating                                  | m³/min (ft³/min)                               | [15/12.5/10.5 (530/441/371)]×3     |                       |                                     | -              |            |          | -     |        |
| Outdoor Air flow   | Cooling                                  | m³/min (ft³/min)                               | -                                  |                       |                                     | 130            | (4591)     | -        |       |        |
|  | Heating                                  | m³/min (ft³/min)                               | -                                  |                       |                                     | 110            | (3885)     | -        |       |        |
| Refrigerant type / amount g(oz)                          |  | -  |                                    |                       | R410A                               | 3.40k          | (119.9)    | -        |       |        |
| Product dimension  | Height                                   | mm(inch)                                       | 235 (9-1/4)                        |                       |                                     | 1416 (55-3/4)  |            |          | -     |        |
|  | Width                                    | mm(inch)                                       | 960 (37-25/32)                     |                       |                                     | 940 (37-1/32)  |            |          | -     |        |
|  | Depth                                    | mm(inch)                                       | 690 (27-5/32)                      |                       |                                     | 340 (13-13/32) |            |          | -     |        |
| Packing dimension  | Height                                   | mm(inch)                                       | 360                                |                       |                                     | 1556           |            |          | -     |        |
|  | Width                                    | mm(inch)                                       | 1025                               |                       |                                     | 1055           |            |          | -     |        |
|  | Depth                                    | mm(inch)                                       | 820                                |                       |                                     | 485            |            |          | -     |        |
| Weight   | (NET)                                    | kg(lb)   | 27 (60)                            |                       |                                     | 98 (216)       |            |          | -     |        |
|  | (GROSS)                                  | kg(lb)   | 34 (75)                            |                       |                                     | 108 (238)      |            |          | -     |        |
| Layers limit (actually)                                  |  | 9 (10)   |                                    |                       | 1 (2)                               |                |            | -        |       |        |
| Operation condition                                      | Cool (DBT)                               | 18°C ~ 32°C                                    |                                    |                       | -15°C ~ 46°C                        |                |            | -        |       |        |
|  | Heat (DBT)                               | 16°C ~ 30°C                                    |                                    |                       | -20°C ~ 24°C                        |                |            | -        |       |        |
| P<br>I<br>P<br>I<br>N<br>G                               | Pipe diameter mm (inch)                  | (Liquid)ø6.35(1/4) (Gas)ø12.7(1/2)             |                                    |                       | (Liquid)ø9.52(3/8) (Gas)ø15.88(5/8) |                |            | -        |       |        |
|  | Connecting method, Standard length m(ft) | flared type, 5.0(16.4)                         |                                    |                       | flared type, 5.0(16.4)              |                |            | -        |       |        |
| Pipe length range  |  | m (ft)   |                                    | 5 ~ 75 (16.4 ~ 246.1) |                                     | -              |            |          |       |        |
| Indoor unit & Outdoor unit height difference m (ft)      |  | 15 (OD located lower) / 30 (OD located higher) |                                    |                       | (49.2/98.4)                         |                |            | -        |       |        |
| Add gas amount g/m (oz/ft)                               |  | 50 (0.538)                                     |                                    |                       | -                                   |                |            | -        |       |        |
| Pipe length for additional gas                           |  | m (ft)   |                                    | 20 (65.6)             |                                     | -              |            |          |       |        |

\*1: In case it is necessary to indicate the air flow volume in (l/s), the value in (m³/min.) shall be multiplied by 16.7 and rounded down the decimal point.

\*2: If the EUROVENT Certified models can be operated under the "extra-low" temperature condition, -7°C dry bulb and -8°C wet-bulb temperatures with rated voltage 230 V shall be used.

\*3: Network Impedance shall be applicable for EUROPE and CHINA models.

\*4: The annual consumption is calculated by multiplying the input power at 230 V (400 V) by an average of 500 hours per year in cooling mode.

\*5: EER and COP classification is at 230 V (400 V) only in accordance with EU directive 2002/31/EC.

\*6: SEER and SCOP classification is at 230V(400V) only in accordance with EN-14825. For heating, SCOP indicates the value of only Average heating season.

# Single -Type

## 1-1. Unit Specifications

**PE2**

## 2. Ceiling Type S-50PT2E5A / U-50PE2E5A

| INDOOR   |   | MODEL  | S-50PT2E5A                               |            |                                    | -          |            |        | -    |        |   |
|--|---|--|--|------------|------------------------------------|------------|------------|--------|------|--------|---|
| PANEL  |   | MODEL  | -  |            |                                    | -          |            |        | -    |        |   |
| OUTDOOR  |   | MODEL  | -  |            |                                    | U-50PE2E5A |            |        | -    |        |   |
| Branch pipe  |   | MODEL  | -  |            |                                    | -          |            |        | -    |        |   |
| Performance test condition                                 |   | ISO5151 / EN14511 / EN12102 / EN14825            |  |            |                                    |            |            |        |      |        |   |
| Power supply   |   | Ø, Hz  | 1ø 50Hz                                  |            |                                    | 1ø 50Hz    |            |        | Min  | Max    |   |
|  |   | V  | 220V                                     | 230V       | 240V                               | 220V       | 230V       | 240V   |      |        |   |
| C<br>O<br>O<br>L<br>I<br>N<br>G                            | Capacity  | kW   | 5.0                                      | 5.0        | 5.0                                | -          | -          | -      | 1.5  | 5.6    |   |
|  |   | BTU/h  | 17100                                    | 17100      | 17100                              | -          | -          | -      | 5100 | 19100  |   |
|  | Current   | A  | 0.39                                     | 0.38       | 0.37                               | 6.30       | 6.00       | 5.75   | -    | -      |   |
|  | Input power   | W  | 40                                       | 40         | 40                                 | 1.300k     | 1.300k     | 1.300k | -    | -      |   |
|  |   | TOTAL W  | -  | -          | -                                  | 1.340k     | 1.340k     | 1.340k | 240  | 1.640k |   |
|  | Annual consumption                                  | TOTAL kWh *4                                     | -  | -          | -                                  | -          | 670        | -      | -    | -      |   |
|  | EER/EER CLASS                                       | TOTAL (W/W) <sup>5</sup> ("A"~"G")               | -  | -          | -                                  | 3.73       | 3.73/A     | 3.73   | 6.25 | 3.41   |   |
|  | Erp <sup>6</sup>                                    | Pdesign  | kW                                       | -          | -                                  | -          | -          | 5.0    | -    | -      | - |
|  |   | SEER   | (W/W)                                    | -          | -                                  | -          | -          | 6.5    | -    | -      | - |
|  |   | Annual consumption                               | kWh                                      | -          | -                                  | -          | -          | 269    | -    | -      | - |
| Class  |   |  | -  | -          | -                                  | -          | A++        | -      | -    | -      |   |
| Power factor   | %   | -  | -  | -          | 94                                 | 94         | 94         | -      | -    |        |   |
| Noise indoor   | dB-A (H/M/L)  | 37/33/29   |  |            | -                                  | -          | -          | -      | -    |        |   |
|  | Power Level dB                                      | 55/51/47   |  |            | -                                  | -          | -          | -      | -    |        |   |
| Noise outdoor  | dB-A (H/L)  | -  |  |            | 46/-                               |            |            | -      | -    |        |   |
|  | Power Level dB                                      | -  |  |            | 65/-                               |            |            | -      | -    |        |   |
| H<br>E<br>A<br>T<br>I<br>N<br>G                            | Capacity  | kW   | 5.6                                      | 5.6        | 5.6                                | -          | -          | -      | 1.5  | 6.5    |   |
|  |   | BTU/h  | 19100                                    | 19100      | 19100                              | -          | -          | -      | 5100 | 22200  |   |
|  | Current   | A  | 0.39                                     | 0.38       | 0.37                               | 6.35       | 6.10       | 5.80   | -    | -      |   |
|  | Input power   | W  | 40                                       | 40         | 40                                 | 1.300k     | 1.300k     | 1.300k | -    | -      |   |
|  |   | TOTAL W  | -  | -          | -                                  | 1.340k     | 1.340k     | 1.340k | 190  | 1.720k |   |
|  | COP/COP CLASS                                       | TOTAL (W/W) <sup>5</sup> ("A"~"G")               | -  | -          | -                                  | 4.18       | 4.18/A     | 4.18   | 7.89 | 3.78   |   |
|  | Erp <sup>6</sup>                                    | Pdesign at -10°C                                 | kW                                       | -          | -                                  | -          | -          | 5.0    | -    | -      | - |
|  |   | Tbivalent  | °C                                       | -          | -                                  | -          | -          | -7     | -    | -      | - |
|  |   | SCOP   | (W/W)                                    | -          | -                                  | -          | -          | 4.1    | -    | -      | - |
|  |   | Annual consumption                               | kWh                                      | -          | -                                  | -          | -          | 1707   | -    | -      | - |
| Class  |   | -  | -  | -          | -                                  | A+         | -          | -      | -    |        |   |
| Power factor   | %   | -  | -  | -          | 93                                 | 93         | 93         | -      | -    |        |   |
| Noise indoor   | dB-A (H/M/L)  | 37/33/29   |  |            | -                                  | -          | -          | -      | -    |        |   |
|  | Power Level dB                                      | 55/51/47   |  |            | -                                  | -          | -          | -      | -    |        |   |
| Noise outdoor  | dB-A (H/L)  | -  |  |            | 48/-                               |            |            | -      | -    |        |   |
|  | Power Level dB                                      | -  |  |            | 68/-                               |            |            | -      | -    |        |   |
| EXTRA LOW TEMP   Total capacity(kW) / Input power(W) / COP |   | -  |  |            |                                    |            |            |        |      |        |   |
| Max Current(A) / Max Input power(W)                        |   | 0.39/40  | 0.38/40                                  | 0.37/40    | 12.0/2.46k                         | 12.0/2.57k | 12.0/2.68k | -      |      |        |   |
| Starting current(A) / Comp output(W)                       |   | -  | -  | -          | 6.35/1.5k                          | 6.10/1.5k  | 5.80/1.5k  | -      |      |        |   |
| Network Impedance(ΩMAX.)                                   |   | -  |  |            |                                    |            |            |        |      |        |   |
| Fan motor output (Indoor/Outdoor) W                        |   | 43   |  |            | 60                                 |            |            | -      |      |        |   |
| Moisture removal volume                                    |   | L/h(Pt/h)  | 2.8                                      | (5.9)      |                                    | -          |            |        | -    |        |   |
| External static pressure                                   |   | Pa   | -  |            |                                    | -          |            |        | -    |        |   |
| Indoor Air flow  | Cooling   | m³/min (ft³/min)                                 | 15.0 / 12.5 / 10.5 (530) / (441) / (371) |            |                                    | -          |            |        | -    |        |   |
|  | Heating   | m³/min (ft³/min)                                 | 15.0 / 12.5 / 10.5 (530) / (441) / (371) |            |                                    | -          |            |        | -    |        |   |
| Outdoor Air flow   | Cooling   | m³/min (ft³/min)                                 | -  |            |                                    | 38         |            | (1342) |      | -      |   |
|  | Heating   | m³/min (ft³/min)                                 | -  |            |                                    | 41         |            | (1448) |      | -      |   |
| Refrigerant type / amount g(oz)                            |   | -  |  |            | R410A                              | 1.40k      | (49.4)     |        | -    |        |   |
| Product dimension  | Height  | mm(inch)   | 235                                      | (9-1/4)    |                                    | 619        | (24-3/8)   |        | -    |        |   |
|  | Width   | mm(inch)   | 960                                      | (37-25/32) |                                    | 799        | (31-29/64) |        | -    |        |   |
|  | Depth   | mm(inch)   | 690                                      | (27-5/32)  |                                    | 299        | (11-49/64) |        | -    |        |   |
| Product dimension (Panel)                                  |   | H×W×D mm, inch                                   | -  |            |                                    | -          |            |        | -    |        |   |
| Packing dimension  | Height  | mm(inch)   | 360                                      |            |                                    | 688        |            |        | -    |        |   |
|  | Width   | mm(inch)   | 1025                                     |            |                                    | 931        |            |        | -    |        |   |
|  | Depth   | mm(inch)   | 820                                      |            |                                    | 422        |            |        | -    |        |   |
| Weight   | (NET)   | kg(lb)   | 27                                       | (60)       |                                    | 39         | (86)       |        | -    |        |   |
|  | (GROSS)   | kg(lb)   | 34                                       | (75)       |                                    | 44         | (97)       |        | -    |        |   |
|  | Panel (NET)   | kg(lb)   | -  |            |                                    | -          |            |        | -    |        |   |
| Layers limit (actually)                                    |   | 9 (10)   |  |            | 5 (6)                              |            |            | -      |      |        |   |
| Operation condition  | Cool (DBT)  | 18°C ~ 32°C                                      |  |            | -15°C ~ 46°C                       |            |            | -      |      |        |   |
|  | Heat (DBT)  | 16°C ~ 30°C                                      |  |            | -20°C ~ 24°C                       |            |            | -      |      |        |   |
| P<br>I<br>P<br>E   | Pipe diameter mm (inch)                             | (Liquid)ø6.35(1/4) (Gas)ø12.7(1/2)               |  |            | (Liquid)ø6.35(1/4) (Gas)ø12.7(1/2) |            |            | -      |      |        |   |
|  | Connecting method, Standard length m(ft)            | flared type, 5.0(16.4)                           |  |            | flared type, 5.0(16.4)             |            |            | -      |      |        |   |
| I<br>N<br>G  | Pipe length range                                   | m (ft)   |  |            | 3 ~ 40m (9.8 ~ 131.2)              |            |            | -      |      |        |   |
|  | Indoor unit & Outdoor unit height difference m (ft) | 15m (OD located lower) / 30m (OD located higher) |  |            | (49.2/98.4)                        |            |            | -      |      |        |   |
| G  | Add gas amount g/m (oz/ft)                          | 20g  |  |            | (0.215)                            |            |            | -      |      |        |   |
|  | Pipe length for additional gas                      | m (ft)   |  |            | 30m (98.4)                         |            |            | -      |      |        |   |

\*1: In case it is necessary to indicate the air flow volume in (l/s), the value in (m³/min.) shall be multiplied by 16.7 and rounded down the decimal point.

\*2: If the EUROVENT Certified models can be operated under the "extra-low" temperature condition, -7°C dry bulb and -8°C wet-bulb temperatures with rated voltage 230 V shall be used.

\*3: Network Impedance shall be applicable for EUROPE and CHINA models.

\*4: The annual consumption is calculated by multiplying the input power at 230 V (400 V) by an average of 500 hours per year in cooling mode.

\*5: EER and COP classification is at 230V (400V) only in accordance with EU directive 2002/31/EC.

\*6: SEER and SCOP classification is at 230V (400V) only in accordance with EN-14825. For heating, SCOP indicates the value of only Average heating season, Other fiche data indicates in an attached sheet.



# Simultaneous (Twin) -Type

## 1-1. Unit Specifications

**PE1**

### 2. Ceiling Type S-50PT2E5A×2 / U-100PE1E5A

| INDOOR  |  | MODEL  | S-50PT2E5A×2                        |                       |                                     | -              |            |          | -     |        |
|---|--|--|-------------------------------------|-----------------------|-------------------------------------|----------------|------------|----------|-------|--------|
| PANEL   |  | MODEL  | -                                   |                       |                                     | -              |            |          | -     |        |
| OUTDOOR   |  | MODEL  | -                                   |                       |                                     | U-100PE1E5A    |            |          | -     |        |
| Branch pipe   |  | MODEL  | -                                   |                       |                                     | CZ-P155BK1     |            |          | -     |        |
| Performance test condition  |  | ISO5151 / EN14511 / EN14825 / EN12102          |                                     |                       |                                     |                |            |          |       |        |
| Power supply  |  | Ø, Hz  | 1ø 50Hz                             |                       |                                     | 1ø 50Hz        |            |          | Min   | Max    |
|   |  | V  | 220                                 | 230                   | 240                                 | 220            | 230        | 240      |       |        |
| C<br>O<br>O<br>L<br>I<br>N<br>G                                       | Capacity                                 | kW   | 10.0                                | 10.0                  | 10.0                                | -              | -          | -        | 3.3   | 12.5   |
|   |  | BTU/h  | 34100                               | 34100                 | 34100                               | -              | -          | -        | 11300 | 42700  |
|   | Current                                  | A  | 0.39×2                              | 0.38×2                | 0.37×2                              | 11.5           | 11.1       | 10.6     | -     | -      |
|   |  | W  | 40×2                                | 40×2                  | 40×2                                | 2.450k         | 2.450k     | 2.450k   | -     | -      |
|   | Input power                              | TOTAL W  | -                                   |                       |                                     | 2.530k         | 2.530k     | 2.530k   | 840   | 3.850k |
|   |  | Annual consumption                             | TOTAL kWh *4                        | -                     |                                     |                | -          | 1265     | -     | -      |
|   | EER/EER CLASS                            | TOTAL (W/W) <sup>*5</sup> ("A"~"G")            | -                                   | -                     | -                                   | 3.95           | 3.95 / A   | 3.95     | 3.93  | 3.25   |
|   | Erp <sup>*6</sup>                        | Pdesign  | kW                                  | -                     | -                                   | -              | -          | 10.0     | -     | -      |
|   |  | SEER   | (W/W)                               | -                     | -                                   | -              | -          | 6.5      | -     | -      |
|   |  | Annual consumption                             | kWh                                 | -                     | -                                   | -              | -          | 539      | -     | -      |
| Class   |  |  | -                                   | -                     | -                                   | -              | A++        | -        | -     |        |
| Power factor  | %  | -  | -                                   | -                     | 97                                  | 96             | 96         | -        | -     |        |
| Noise indoor  | dB-A (H/M/L)                             | 37/33/29                                       |                                     |                       | -                                   | -              | -          | -        | -     |        |
|   | Power Level dB                           | 55/51/47                                       |                                     |                       | -                                   | -              | -          | -        | -     |        |
| Noise outdoor   | dB-A (H/L)                               | -  |                                     |                       | 52/-                                |                |            | -        | -     |        |
|   | Power Level dB                           | -  |                                     |                       | 69/-                                |                |            | -        | -     |        |
| H<br>E<br>A<br>T<br>I<br>N<br>G                                       | Capacity                                 | kW   | 11.2                                | 11.2                  | 11.2                                | -              | -          | -        | 4.1   | 14.0   |
|   |  | BTU/h  | 38200                               | 38200                 | 38200                               | -              | -          | -        | 14000 | 47800  |
|   | Current                                  | A  | 0.39×2                              | 0.38×2                | 0.37×2                              | 11.8           | 11.4       | 11.0     | -     | -      |
|   |  | W  | 40×2                                | 40×2                  | 40×2                                | 2.520k         | 2.520k     | 2.520k   | -     | -      |
|   | Input power                              | TOTAL W  | -                                   |                       |                                     | 2.600k         | 2.600k     | 2.600k   | 900   | 4.400k |
|   |  | COP/COP CLASS                                  | TOTAL (W/W) <sup>*5</sup> ("A"~"G") | -                     | -                                   | -              | 4.31       | 4.31 / A | 4.31  | 4.56   |
|   | Erp <sup>*6</sup>                        | Pdesign at -10°C                               | kW                                  | -                     | -                                   | -              | -          | 10.0     | -     | -      |
|   |  | Tbivalent                                      | °C                                  | -                     | -                                   | -              | -          | -10      | -     | -      |
|   |  | SCOP   | (W/W)                               | -                     | -                                   | -              | -          | 4.3      | -     | -      |
|   |  | Annual consumption                             | kWh                                 | -                     | -                                   | -              | -          | 3256     | -     | -      |
| Class   |  | -  | -                                   | -                     | -                                   | A+             | -          | -        |       |        |
| Power factor  | %  | -  | -                                   | -                     | 97                                  | 96             | 95         | -        | -     |        |
| Noise indoor  | dB-A (H/M/L)                             | 37/33/29                                       |                                     |                       | -                                   | -              | -          | -        | -     |        |
|   | Power Level dB                           | 55/51/47                                       |                                     |                       | -                                   | -              | -          | -        | -     |        |
| Noise outdoor   | dB-A (H/L)                               | -  |                                     |                       | 52/-                                |                |            | -        | -     |        |
|   | Power Level dB                           | -  |                                     |                       | 69/-                                |                |            | -        | -     |        |
| EXTRA LOW TEMP <sup>†</sup> Total capacity(kW) / Input power(W) / COP |  | -  |                                     |                       |                                     |                |            |          |       |        |
| Max Current(A) / Max Input power(W)                                   |  | 0.39×2/40×2                                    | 0.38×2/40×2                         | 0.37×2/40×2           | 25.0/5.34k                          | 25.0/5.52k     | 25.0/5.70k | -        |       |        |
| Starting current(A) / Comp output(W)                                  |  | -  | -                                   | -                     | 11.8/3.0k                           | 11.4/3.0k      | 11.0/3.0k  | -        |       |        |
| Network Impedance(ΩMAX.)  |  | -  |                                     |                       |                                     |                |            |          |       |        |
| Fan motor output (Indoor/Outdoor) W                                   |  | 43   |                                     |                       | 90×2                                |                |            | -        |       |        |
| Moisture removal volume   |  | L/h(Pt/h)                                      | 6.0                                 | (3.0×2)               | (12.6)                              | -              |            |          | -     |        |
| External static pressure  |  | Pa   | -                                   |                       |                                     | -              |            |          | -     |        |
| Indoor Air flow   | Cooling                                  | m³/min (ft³/min)                               | [15/12.5/10.5 (530/441/371)]×2      |                       |                                     | -              |            |          | -     |        |
|   | Heating                                  | m³/min (ft³/min)                               | [15/12.5/10.5 (530/441/371)]×2      |                       |                                     | -              |            |          | -     |        |
| Outdoor Air flow  | Cooling                                  | m³/min (ft³/min)                               | -                                   |                       |                                     | 110            | (3885)     | -        |       |        |
|   | Heating                                  | m³/min (ft³/min)                               | -                                   |                       |                                     | 95             | (3355)     | -        |       |        |
| Refrigerant type / amount g(oz)                                       |  | -  |                                     |                       | R410A                               | 3.40k          | (119.9)    | -        |       |        |
| Product dimension   | Height                                   | mm(inch)                                       | 235 (9-1/4)                         |                       |                                     | 1416 (55-3/4)  |            |          | -     |        |
|   | Width                                    | mm(inch)                                       | 960 (37-25/32)                      |                       |                                     | 940 (37-1/32)  |            |          | -     |        |
|   | Depth                                    | mm(inch)                                       | 690 (27-5/32)                       |                       |                                     | 340 (13-13/32) |            |          | -     |        |
| Packing dimension   | Height                                   | mm(inch)                                       | 360                                 |                       |                                     | 1556           |            |          | -     |        |
|   | Width                                    | mm(inch)                                       | 1025                                |                       |                                     | 1055           |            |          | -     |        |
|   | Depth                                    | mm(inch)                                       | 820                                 |                       |                                     | 485            |            |          | -     |        |
| Weight  | (NET)                                    | kg(lb)   | 27 (60)                             |                       |                                     | 98 (216)       |            |          | -     |        |
|   | (GROSS)                                  | kg(lb)   | 34 (75)                             |                       |                                     | 108 (238)      |            |          | -     |        |
| Layers limit (actually)   |  | 9 (10)   |                                     |                       | 1 (2)                               |                |            | -        |       |        |
| Operation condition   | Cool (DBT)                               | 18°C ~ 32°C                                    |                                     |                       | -15°C ~ 46°C                        |                |            | -        |       |        |
|   | Heat (DBT)                               | 16°C ~ 30°C                                    |                                     |                       | -20°C ~ 24°C                        |                |            | -        |       |        |
| P<br>I<br>P<br>I<br>N<br>G  | Pipe diameter mm (inch)                  | (Liquid)ø6.35(1/4) (Gas)ø12.7(1/2)             |                                     |                       | (Liquid)ø9.52(3/8) (Gas)ø15.88(5/8) |                |            | -        |       |        |
|   | Connecting method, Standard length m(ft) | flared type, 5.0(16.4)                         |                                     |                       | flared type, 5.0(16.4)              |                |            | -        |       |        |
| Pipe length range   |  | m (ft)   |                                     | 5 ~ 75 (16.4 ~ 246.1) |                                     | -              |            |          |       |        |
| Indoor unit & Outdoor unit height difference m (ft)                   |  | 15 (OD located lower) / 30 (OD located higher) |                                     |                       | (49.2/98.4)                         |                |            | -        |       |        |
| Add gas amount g/m (oz/ft)  |  | 50 (0.538)                                     |                                     |                       | -                                   |                |            | -        |       |        |
| Pipe length for additional gas  |  | m (ft)   |                                     | 30 (98.4)             |                                     | -              |            |          |       |        |

\*1: In case it is necessary to indicate the air flow volume in (l/s), the value in (m³/min.) shall be multiplied by 16.7 and rounded down the decimal point.

\*2: If the EUROVENT Certified models can be operated under the "extra-low" temperature condition, -7°C dry bulb and -8°C wet-bulb temperatures with rated voltage 230 V shall be used.

\*3: Network Impedance shall be applicable for EUROPE and CHINA models.

\*4: The annual consumption is calculated by multiplying the input power at 230 V (400 V) by an average of 500 hours per year in cooling mode.

\*5: EER and COP classification is at 230 V (400 V) only in accordance with EU directive 2002/31/EC.

\*6: SEER and SCOP classification is at 230V(400V) only in accordance with EN-14825. For heating, SCOP indicates the value of only Average heating season, Other fiche data indicates in an attached sheet.

# Simultaneous (Triple) -Type

## 1-1. Unit Specifications

**PE1**

### 2. Ceiling Type S-50PT2E5A×3 / U-140PE1E5A

| INDOOR  |  | MODEL  | S-50PT2E5A×3                       |             |                                     | -              |            |          | -     |        |      |
|---|--|--|------------------------------------|-------------|-------------------------------------|----------------|------------|----------|-------|--------|------|
| PANEL   |  | MODEL  | -                                  |             |                                     | -              |            |          | -     |        |      |
| OUTDOOR   |  | MODEL  | -                                  |             |                                     | U-140PE1E5A    |            |          | -     |        |      |
| Branch pipe   |  | MODEL  | -                                  |             |                                     | CZ-P3HPC2      |            |          | -     |        |      |
| Performance test condition  |  | ISO5151 / EN14511 / EN12102 / EN14825          |                                    |             |                                     |                |            |          |       |        |      |
| Power supply  |  | Ø, Hz  | 1ø 50Hz                            |             |                                     | 1ø 50Hz        |            |          | Min   | Max    |      |
|   |  | V  | 220                                | 230         | 240                                 | 220            | 230        | 240      |       |        |      |
| C<br>O<br>O<br>L<br>I<br>N<br>G                                       | Capacity                                 | kW   | 14.0                               | 14.0        | 14.0                                | -              | -          | -        | 3.3   | 15.5   |      |
|   |  | BTU/h  | 47800                              | 47800       | 47800                               | -              | -          | -        | 11300 | 51200  |      |
|   | Current                                  | A  | 0.39×3                             | 0.38×3      | 0.37×3                              | 21.2           | 20.5       | 19.8     | -     | -      |      |
|   |  | W  | 40×3                               | 40×3        | 40×3                                | 4.530k         | 4.530k     | 4.530k   | -     | -      |      |
|   | Input power                              | TOTAL W  | -                                  |             |                                     | 4.650k         | 4.650k     | 4.650k   | 840   | 5.650k |      |
|   |  | Annual consumption                             | TOTAL kWh *4                       | -           |                                     |                | -          | 2325     | -     | -      | -    |
|   | EER/EER CLASS                            | TOTAL (W/W) <sup>5</sup> ("A"~"G")             | -                                  | -           | -                                   | 3.01           | 3.01 / B   | 3.01     | 3.93  | 2.65   |      |
|   | Erp *6                                   | Pdesign  | kW                                 | -           | -                                   | -              | -          | 14.0     | -     | -      | -    |
|   |  | η <sub>s,c</sub>                               | %                                  | -           | -                                   | -              | -          | 222.2    | -     | -      | -    |
|   |  | Annual consumption                             | kWh                                | -           | -                                   | -              | -          | -        | -     | -      | -    |
| Class   |  |  | -                                  | -           | -                                   | -              | -          | -        | -     | -      |      |
| Power factor  | %  | -  | -                                  | -           | 97                                  | 96             | 95         | -        | -     |        |      |
| Noise indoor  | dB-A (H/M/L)                             | 37/33/29                                       |                                    |             | -                                   | -              | -          | -        | -     |        |      |
|   | Power Level dB                           | 55/51/47                                       |                                    |             | -                                   | -              | -          | -        | -     |        |      |
| Noise outdoor   | dB-A (H/L)                               | -  |                                    |             | 54/-                                |                |            | -        | -     |        |      |
|   | Power Level dB                           | -  |                                    |             | 71/-                                |                |            | -        | -     |        |      |
| H<br>E<br>A<br>T<br>I<br>N<br>G                                       | Capacity                                 | kW   | 16.0                               | 16.0        | 16.0                                | -              | -          | -        | 4.1   | 18.0   |      |
|   |  | BTU/h  | 54600                              | 54600       | 54600                               | -              | -          | -        | 14000 | 61400  |      |
|   | Current                                  | A  | 0.39×3                             | 0.38×3      | 0.37×3                              | 19.8           | 19.2       | 18.5     | -     | -      |      |
|   |  | W  | 40×3                               | 40×3        | 40×3                                | 4.240k         | 4.240k     | 4.240k   | -     | -      |      |
|   | Input power                              | TOTAL W  | -                                  |             |                                     | 4.360k         | 4.360k     | 4.360k   | 900   | 5.930k |      |
|   |  | COP/COP CLASS                                  | TOTAL (W/W) <sup>5</sup> ("A"~"G") | -           | -                                   | -              | 3.67       | 3.67 / A | 3.67  | 4.56   | 3.04 |
|   | Erp *6                                   | Pdesign at -10°C                               | kW                                 | -           | -                                   | -              | -          | 14.0     | -     | -      | -    |
|   |  | Tbivalent                                      | °C                                 | -           | -                                   | -              | -          | -7       | -     | -      | -    |
|   |  | η <sub>s,h</sub>                               | %                                  | -           | -                                   | -              | -          | 145.5    | -     | -      | -    |
|   |  | Annual consumption                             | kWh                                | -           | -                                   | -              | -          | -        | -     | -      | -    |
| Class   |  | -  | -                                  | -           | -                                   | -              | -          | -        | -     |        |      |
| Power factor  | %  | -  | -                                  | -           | 97                                  | 96             | 95         | -        | -     |        |      |
| Noise indoor  | dB-A (H/M/L)                             | 37/33/29                                       |                                    |             | -                                   | -              | -          | -        | -     |        |      |
|   | Power Level dB                           | 55/51/47                                       |                                    |             | -                                   | -              | -          | -        | -     |        |      |
| Noise outdoor   | dB-A (H/L)                               | -  |                                    |             | 55/-                                |                |            | -        | -     |        |      |
|   | Power Level dB                           | -  |                                    |             | 71/-                                |                |            | -        | -     |        |      |
| EXTRA LOW TEMP <sup>6</sup> Total capacity(kW) / Input power(W) / COP |  | -  |                                    |             |                                     |                |            |          |       |        |      |
| Max Current(A) / Max Input power(W)                                   |  | 0.39×3/40×3                                    | 0.38×3/40×3                        | 0.37×3/40×3 | 30.0/6.40k                          | 30.0/6.62k     | 30.0/6.84k | -        |       |        |      |
| Starting current(A) / Comp output(W)                                  |  | -  | -                                  | -           | 21.2/3.0k                           | 20.5/3.0k      | 19.8/3.0k  | -        |       |        |      |
| Network Impedance(ΩMAX.)  |  | -  |                                    |             |                                     |                |            |          |       |        |      |
| Fan motor output (Indoor/Outdoor) W                                   |  | 43   |                                    |             | 90×2                                |                |            | -        |       |        |      |
| Moisture removal volume   |  | L/h(Pt/h)                                      | 9.0                                | (3.0×3)     | (18.9)                              | -              |            |          | -     |        |      |
| External static pressure  |  | Pa   | -                                  |             |                                     | -              |            |          | -     |        |      |
| Indoor Air flow   | Cooling                                  | m³/min (ft³/min)                               | [15/12.5/10.5 (530/441/371)]×3     |             |                                     | -              |            |          | -     | -      |      |
|   | Heating                                  | m³/min (ft³/min)                               | [15/12.5/10.5 (530/441/371)]×3     |             |                                     | -              |            |          | -     | -      |      |
| Outdoor Air flow  | Cooling                                  | m³/min (ft³/min)                               | -                                  |             |                                     | 135            | (4767)     | -        |       |        |      |
|   | Heating                                  | m³/min (ft³/min)                               | -                                  |             |                                     | 120            | (4238)     | -        |       |        |      |
| Refrigerant type / amount g(oz)                                       |  | -  |                                    |             | R410A                               | 3.40k          | (119.9)    | -        |       |        |      |
| Product dimension   | Height                                   | mm(inch)                                       | 235 (9-1/4)                        |             |                                     | 1416 (55-3/4)  |            |          | -     |        |      |
|   | Width                                    | mm(inch)                                       | 960 (37-25/32)                     |             |                                     | 940 (37-1/32)  |            |          | -     |        |      |
|   | Depth                                    | mm(inch)                                       | 690 (27-5/32)                      |             |                                     | 340 (13-13/32) |            |          | -     |        |      |
| Packing dimension   | Height                                   | mm(inch)                                       | 360                                |             |                                     | 1556           |            |          | -     |        |      |
|   | Width                                    | mm(inch)                                       | 1025                               |             |                                     | 1055           |            |          | -     |        |      |
|   | Depth                                    | mm(inch)                                       | 820                                |             |                                     | 485            |            |          | -     |        |      |
| Weight  | (NET)                                    | kg(lb)   | 27 (60)                            |             |                                     | 98 (216)       |            |          | -     |        |      |
|   | (GROSS)                                  | kg(lb)   | 34 (75)                            |             |                                     | 108 (238)      |            |          | -     |        |      |
| Layers limit (actually)   |  | 9 (10)   |                                    |             | 1 (2)                               |                |            | -        |       |        |      |
| Operation condition   | Cool (DBT)                               | 18°C ~ 32°C                                    |                                    |             | -15°C ~ 46°C                        |                |            | -        |       |        |      |
|   | Heat (DBT)                               | 16°C ~ 30°C                                    |                                    |             | -20°C ~ 24°C                        |                |            | -        |       |        |      |
| P<br>I<br>P<br>I<br>N<br>G  | Pipe diameter mm (inch)                  | (Liquid)ø6.35(1/4) (Gas)ø12.7(1/2)             |                                    |             | (Liquid)ø9.52(3/8) (Gas)ø15.88(5/8) |                |            | -        |       |        |      |
|   | Connecting method, Standard length m(ft) | flared type, 5.0(16.4)                         |                                    |             | flared type, 5.0(16.4)              |                |            | -        |       |        |      |
| Pipe length range   |  | m (ft)   |                                    |             | 5 ~ 75 (16.4 ~ 246.1)               |                |            | -        |       |        |      |
| Indoor unit & Outdoor unit height difference m (ft)                   |  | 15 (OD located lower) / 30 (OD located higher) |                                    |             | (49.2/98.4)                         |                |            | -        |       |        |      |
| Add gas amount g/m (oz/ft)  |  | 50   |                                    |             | (0.538)                             |                |            | -        |       |        |      |
| Pipe length for additional gas  |  | m (ft)   |                                    |             | 20 (65.6)                           |                |            | -        |       |        |      |

\*1: In case it is necessary to indicate the air flow volume in (l/s), the value in (m³/min.) shall be multiplied by 16.7 and rounded down the decimal point.

\*2: If the EUROVENT Certified models can be operated under the "extra-low" temperature condition, -7°C dry bulb and -8°C wet-bulb temperatures with rated voltage 230 V shall be used.

\*3: Network Impedance shall be applicable for EUROPE and CHINA models.

\*4: The annual consumption is calculated by multiplying the input power at 230 V (400 V) by an average of 500 hours per year in cooling mode.

\*5: EER and COP classification is at 230 V (400 V) only in accordance with EU directive 2002/31/EC.

\*6: SEER and SCOP classification is at 230V(400V) only in accordance with EN-14825. For heating, SCOP indicates the value of only Average heating season.

# Single -Type

## 1-1. Unit Specifications

PE2

### 2. Ceiling Type S-60PT2E5A / U-60PE2E5A

|  |  |  |  |           |                                     |            |            |        |      |        |      |
|--|--|--|--|-----------|-------------------------------------|------------|------------|--------|------|--------|------|
| INDOOR   | MODEL                                    | S-60PT2E5A                                       |  |           | -                                   |            |            | -      | -    |        |      |
| PANEL  | MODEL                                    | -  |  |           | -                                   |            |            | -      | -    |        |      |
| OUTDOOR  | MODEL                                    | -  |  |           | U-60PE2E5A                          |            |            | -      | -    |        |      |
| Branch pipe  | MODEL                                    | -  |  |           | -                                   |            |            | -      | -    |        |      |
| Performance test condition                                 |  | ISO5151 / EN14511 / EN12102 / EN14825            |  |           |                                     |            |            |        |      |        |      |
| Power supply   |  | Ø, Hz  | 1ø 50Hz                                  |           |                                     | 1ø 50Hz    |            |        | Min  | Max    |      |
|  |  | V  | 220V                                     | 230V      | 240V                                | 220V       | 230V       | 240V   |      |        |      |
| C<br>O<br>O<br>L<br>I<br>N<br>G                            | Capacity                                 | kW   | 6.0                                      | 6.0       | 6.0                                 | -          | -          | -      | 2.0  | 7.1    |      |
|  |  | BTU/h  | 20500                                    | 20500     | 20500                               | -          | -          | -      | 6800 | 24200  |      |
|  | Current                                  | A  | 0.42                                     | 0.41      | 0.40                                | 7.90       | 7.50       | 7.20   | -    | -      |      |
|  |  | W  | 50                                       | 50        | 50                                  | 1.560k     | 1.560k     | 1.560k | -    | -      |      |
|  | Input power                              | TOTAL W  | -  |           |                                     | 1.610k     | 1.610k     | 1.610k | 250  | 2.250k |      |
|  |  | Annual consumption                               | TOTAL kWh *4                             | -         |                                     |            | -          | 805    | -    | -      | -    |
|  | EER/EER CLASS                            | TOTAL (W/W) <sup>5/6</sup> ("A"~"G")             | -  | -         | -                                   | 3.73       | 3.73/A     | 3.73   | 8.00 | 3.16   |      |
|  | Erp *6                                   | Pdesign  | kW                                       | -         | -                                   | -          | -          | 6.0    | -    | -      | -    |
|  |  | SEER   | (W/W)                                    | -         | -                                   | -          | -          | 6.8    | -    | -      | -    |
|  |  | Annual consumption                               | kWh                                      | -         | -                                   | -          | -          | 309    | -    | -      | -    |
| Class  |  |  | -  | -         | -                                   | -          | A++        | -      | -    | -      |      |
| Power factor   | %  | -  | -  | -         | 90                                  | 90         | 90         | -      | -    |        |      |
| Noise indoor   | dB-A (H/M/L)                             | 38/34/30   |  |           | -                                   | -          | -          | -      | -    |        |      |
|  | Power Level dB                           | 56/52/48   |  |           | -                                   | -          | -          | -      | -    |        |      |
| Noise outdoor  | dB-A (H/L)                               | -  |  |           | 46/-                                |            |            | -      | -    |        |      |
|  | Power Level dB                           | -  |  |           | 65/-                                |            |            | -      | -    |        |      |
| H<br>E<br>A<br>T<br>I<br>N<br>G                            | Capacity                                 | kW   | 7.0                                      | 7.0       | 7.0                                 | -          | -          | -      | 1.8  | 8.0    |      |
|  |  | BTU/h  | 23900                                    | 23900     | 23900                               | -          | -          | -      | 6100 | 27300  |      |
|  | Current                                  | A  | 0.42                                     | 0.41      | 0.40                                | 8.15       | 7.80       | 7.45   | -    | -      |      |
|  |  | W  | 50                                       | 50        | 50                                  | 1.610k     | 1.610k     | 1.610k | -    | -      |      |
|  | Input power                              | TOTAL W  | -  |           |                                     | 1.660k     | 1.660k     | 1.660k | 200  | 1.950k |      |
|  |  | COP/COP CLASS                                    | TOTAL (W/W) <sup>5/6</sup> ("A"~"G")     | -         | -                                   | -          | 4.22       | 4.22/A | 4.22 | 9.00   | 4.10 |
|  | Erp *6                                   | Pdesign at -10°C                                 | kW                                       | -         | -                                   | -          | -          | 6.0    | -    | -      | -    |
|  |  | Tbivalent  | °C                                       | -         | -                                   | -          | -          | -8     | -    | -      | -    |
|  |  | SCOP   | (W/W)                                    | -         | -                                   | -          | -          | 4.1    | -    | -      | -    |
|  |  | Annual consumption                               | kWh                                      | -         | -                                   | -          | -          | 2050   | -    | -      | -    |
| Class  |  | -  | -  | -         | -                                   | A+         | -          | -      | -    |        |      |
| Power factor   | %  | -  | -  | -         | 90                                  | 90         | 90         | -      | -    |        |      |
| Noise indoor   | dB-A (H/M/L)                             | 38/34/30   |  |           | -                                   | -          | -          | -      | -    |        |      |
|  | Power Level dB                           | 56/52/48   |  |           | -                                   | -          | -          | -      | -    |        |      |
| Noise outdoor  | dB-A (H/L)                               | -  |  |           | 49/-                                |            |            | -      | -    |        |      |
|  | Power Level dB                           | -  |  |           | 69/-                                |            |            | -      | -    |        |      |
| EXTRA LOW TEMP   Total capacity(kW) / Input power(W) / COP |  | -  |  |           |                                     |            |            |        |      |        |      |
| Max Current(A) / Max Input power(W)                        |  | 0.42/50  | 0.41/50                                  | 0.40/50   | 16.5/3.27k                          | 16.5/3.42k | 16.5/3.57k | -      |      |        |      |
| Starting current(A) / Comp output(W)                       |  | -  | -  | -         | 8.15/1.7k                           | 7.80/1.7k  | 7.45/1.7k  | -      |      |        |      |
| Network Impedance(ΩMAX.)                                   |  | -  |  |           |                                     |            |            |        |      |        |      |
| Fan motor output (Indoor/Outdoor) W                        |  | 74   |  |           | 60                                  |            |            | -      |      |        |      |
| Moisture removal volume                                    |  | L/h(Pt/h)  | 3.4                                      | (7.1)     | -                                   |            |            | -      |      |        |      |
| External static pressure                                   |  | Pa   | -  |           |                                     | -          |            |        | -    |        |      |
| Indoor Air flow  | Cooling                                  | m³/min (ft³/min)                                 | 20.0 / 17.0 / 14.5 (706) / (600) / (512) |           |                                     | -          |            |        | -    | -      |      |
|  | Heating                                  | m³/min (ft³/min)                                 | 20.0 / 17.0 / 14.5 (706) / (600) / (512) |           |                                     | -          |            |        | -    | -      |      |
| Outdoor Air flow   | Cooling                                  | m³/min (ft³/min)                                 | -  |           |                                     | 38         | (1342)     | -      | -    |        |      |
|  | Heating                                  | m³/min (ft³/min)                                 | -  |           |                                     | 41         | (1448)     | -      | -    |        |      |
| Refrigerant type / amount g(oz)                            |  | -  |  |           | R410A                               | 1.95k      | (68.8)     | -      |      |        |      |
| Product dimension  | Height                                   | mm(inch)   | 235                                      | (9-1/4)   | 619                                 | (24-3/8)   | -          |        |      |        |      |
|  | Width                                    | mm(inch)   | 1275                                     | (50-3/16) | 799                                 | (31-29/64) | -          |        |      |        |      |
|  | Depth                                    | mm(inch)   | 690                                      | (27-5/32) | 299                                 | (11-49/64) | -          |        |      |        |      |
| Product dimension (Panel)                                  |  | H×W×D mm, inch                                   | -  |           |                                     | -          |            |        | -    |        |      |
| Packing dimension  | Height                                   | mm(inch)   | 360                                      |           |                                     | 688        |            |        | -    |        |      |
|  | Width                                    | mm(inch)   | 1340                                     |           |                                     | 931        |            |        | -    |        |      |
|  | Depth                                    | mm(inch)   | 820                                      |           |                                     | 422        |            |        | -    |        |      |
| Weight   | (NET)                                    | kg(lb)   | 33                                       | (73)      | 40                                  | (88)       | -          |        |      |        |      |
|  | (GROSS)                                  | kg(lb)   | 42                                       | (93)      | 45                                  | (99)       | -          |        |      |        |      |
|  | Panel (NET)                              | kg(lb)   | -  |           |                                     | -          |            |        | -    |        |      |
| Layers limit (actually)                                    |  | 9 (10)   |  |           | 5 (6)                               |            |            | -      |      |        |      |
| Operation condition  | Cool (DBT)                               | 18°C ~ 32°C                                      |  |           | -15°C ~ 46°C                        |            |            | -      |      |        |      |
|  | Heat (DBT)                               | 16°C ~ 30°C                                      |  |           | -20°C ~ 24°C                        |            |            | -      |      |        |      |
| P I P I N G  | Pipe diameter mm (inch)                  | (Liquid)ø9.52(3/8) (Gas)ø15.88(5/8)              |  |           | (Liquid)ø9.52(3/8) (Gas)ø15.88(5/8) |            |            | -      |      |        |      |
|  | Connecting method, Standard length m(ft) | flared type, 5.0(16.4)                           |  |           | flared type, 5.0(16.4)              |            |            | -      |      |        |      |
| Pipe length range m (ft)                                   |  | 3 ~ 40m (9.8 ~ 131.2)                            |  |           | -                                   |            |            | -      |      |        |      |
| Indoor unit & Outdoor unit height difference m (ft)        |  | 15m (OD located lower) / 30m (OD located higher) |  |           | (49.2/98.4)                         |            |            | -      |      |        |      |
| Add gas amount g/m (oz/ft)                                 |  | 40g (0.430)                                      |  |           | -                                   |            |            | -      |      |        |      |
| Pipe length for additional gas m (ft)                      |  | 30m (98.4)                                       |  |           | -                                   |            |            | -      |      |        |      |

\*1: In case it is necessary to indicate the air flow volume in (l/s), the value in (m³/min.) shall be multiplied by 16.7 and rounded down the decimal point.  
 \*2: If the EUROVENT Certified models can be operated under the "extra-low" temperature condition, -7°C dry bulb and -8°C wet-bulb temperatures with rated voltage 230 V shall be used.  
 \*3: Network Impedance shall be applicable for EUROPE and CHINA models.  
 \*4: The annual consumption is calculated by multiplying the input power at 230V (400V) by an average of 500 hours per year in cooling mode.  
 \*5: EER and COP classification is at 230V (400V) only in accordance with EU directive 2002/31/EC.  
 \*6: SEER and SCOP classification is at 230V (400V) only in accordance with EN-14825. For heating, SCOP indicates the value of only Average heating season, Other fiche data indicates in an attached sheet.

# 1 Simultaneous (Twin) -Type

## 1-1. Unit Specifications

PE1

### 2. Ceiling Type S-60PT2E5A×2 / U-125PE1E5A

| INDOOR   |  | MODEL                                 | S-60PT2E5A×2                 |             |  | -              |            |        | -      |        |   |
|--|--|---------------------------------------|------------------------------|-------------|--|----------------|------------|--------|--------|--------|---|
| PANEL  |  | MODEL                                 | -                            |             |  | -              |            |        | -      |        |   |
| OUTDOOR  |  | MODEL                                 | -                            |             |  | U-125PE1E5A    |            |        | -      |        |   |
| Branch pipe  |  | MODEL                                 | -                            |             |  | CZ-P155BK1     |            |        | -      |        |   |
| Performance test condition                                 |  | ISO5151 / EN14511 / EN12102 / EN14825 |                              |             |  |                |            |        |        |        |   |
| Power supply   |  | Ø, Hz                                 | 1ø 50Hz                      |             |  | 1ø 50Hz        |            |        | Min    | Max    |   |
|  |  | V                                     | 220                          | 230         | 240  | 220            | 230        | 240    |        |        |   |
| C<br>O<br>O<br>L<br>I<br>N<br>G                            | Capacity                                 | kW                                    | 12.5                         | 12.5        | 12.5   | -              | -          | -      | 3.3    | 14.0   |   |
|  |  | BTU/h                                 | 42700                        | 42700       | 42700  | -              | -          | -      | 11300  | 47800  |   |
|  | Current                                  | A                                     | 0.42×2                       | 0.41×2      | 0.40×2   | 17.0           | 16.4       | 15.9   | -      | -      |   |
|  |  | W                                     | 50×2                         | 50×2        | 50×2   | 3.630k         | 3.630k     | 3.630k | -      | -      |   |
|  | Input power                              | TOTAL W                               | -                            |             |  | 3.730k         | 3.730k     | 3.730k | 840    | 4.860k |   |
|  |  | Annual consumption                    | TOTAL kWh *4                 | -           |  |                | -          | 1865   | -      | -      | - |
|  | EER/EER CLASS                            | TOTAL (W/W) <sup>5/6</sup> ("A"-~"G") | -                            | -           | -  | 3.35           | 3.35 / A   | 3.35   | 3.93   | 2.88   |   |
|  | Erp *6                                   | Pdesign                               | kW                           | -           | -  | -              | -          | 12.5   | -      | -      | - |
|  |  | η <sub>s,c</sub>                      | %                            | -           | -  | -              | -          | 240.8  | -      | -      | - |
|  |  | Annual consumption                    | kWh                          | -           | -  | -              | -          | -      | -      | -      | - |
| Class  |  |                                       | -                            | -           | -  | -              | -          | -      | -      | -      |   |
| Power factor   | %  | -                                     | -                            | -           | 97   | 96             | 95         | -      | -      |        |   |
| Noise indoor   | dB-A (H/M/L)                             | 38/34/30                              |                              |             | -  | -              | -          | -      | -      |        |   |
|  | Power Level dB                           | 56/52/48                              |                              |             | -  | -              | -          | -      | -      |        |   |
| Noise outdoor  | dB-A (H/L)                               | -                                     |                              |             | 53/-   |                |            | -      | -      |        |   |
|  | Power Level dB                           | -                                     |                              |             | 70/-   |                |            | -      | -      |        |   |
| Capacity   | kW                                       | 14.0                                  | 14.0                         | 14.0        | -  | -              | -          | 4.1    | 16.0   |        |   |
|  | BTU/h                                    | 47800                                 | 47800                        | 47800       | -  | -              | -          | 14000  | 54600  |        |   |
| Current  | A  | 0.42×2                                | 0.41×2                       | 0.40×2      | 16.0   | 15.4           | 14.9       | -      | -      |        |   |
|  | W  | 50×2                                  | 50×2                         | 50×2        | 3.410k   | 3.410k         | 3.410k     | -      | -      |        |   |
| Input power  | TOTAL W                                  | -                                     |                              |             | 3.510k   | 3.510k         | 3.510k     | 900    | 5.210k |        |   |
|  | COP/COP CLASS                            | TOTAL (W/W) <sup>5/6</sup> ("A"-~"G") | -                            | -           | -  | 3.99           | 3.99 / A   | 3.99   | 4.56   | 3.07   |   |
| Erp *6   | Pdesign at -10°C                         | kW                                    | -                            | -           | -  | -              | 12.5       | -      | -      |        |   |
|  | Tbivalent                                | °C                                    | -                            | -           | -  | -              | -10        | -      | -      |        |   |
|  | η <sub>s,h</sub>                         | %                                     | -                            | -           | -  | -              | 150.1      | -      | -      |        |   |
|  | Annual consumption                       | kWh                                   | -                            | -           | -  | -              | -          | -      | -      |        |   |
| Class  |  | -                                     | -                            | -           | -  | -              | -          | -      |        |        |   |
| Power factor   | %  | -                                     | -                            | -           | 97   | 96             | 95         | -      | -      |        |   |
| Noise indoor   | dB-A (H/M/L)                             | 38/34/30                              |                              |             | -  | -              | -          | -      | -      |        |   |
|  | Power Level dB                           | 56/52/48                              |                              |             | -  | -              | -          | -      | -      |        |   |
| Noise outdoor  | dB-A (H/L)                               | -                                     |                              |             | 53/-   |                |            | -      | -      |        |   |
|  | Power Level dB                           | -                                     |                              |             | 70/-   |                |            | -      | -      |        |   |
| EXTRA LOW TEMP   Total capacity(kW) / Input power(W) / COP |  | -                                     |                              |             |  |                |            |        |        |        |   |
| Max Current(A) / Max Input power(W)                        |  | 0.42×2/50×2                           | 0.41×2/50×2                  | 0.40×2/50×2 | 28.0/5.98k   | 28.0/6.18k     | 28.0/6.38k | -      |        |        |   |
| Starting current(A) / Comp output(W)                       |  | -                                     | -                            | -           | 17.0/3.0k  | 16.4/3.0k      | 15.8/3.0k  | -      |        |        |   |
| Network Impedance(ΩMAX.)                                   |  | -                                     |                              |             |  |                |            |        |        |        |   |
| Fan motor output (Indoor/Outdoor) W                        |  | 74                                    |                              |             | 90×2   |                |            | -      |        |        |   |
| Moisture removal volume                                    |  | L/h(Pt/h)                             | 7.9                          | (3.95×2)    | (16.6)   | -              |            |        | -      |        |   |
| External static pressure                                   |  | Pa                                    | -                            |             |  | -              |            |        | -      |        |   |
| Indoor Air flow  | Cooling                                  | m³/min (ft³/min)                      | [20/17/14.5 (706/600/512)]×2 |             |  | -              |            |        | -      |        |   |
|  | Heating                                  | m³/min (ft³/min)                      | [20/17/14.5 (706/600/512)]×2 |             |  | -              |            |        | -      |        |   |
| Outdoor Air flow   | Cooling                                  | m³/min (ft³/min)                      | -                            |             |  | 130            | (4591)     | -      |        |        |   |
|  | Heating                                  | m³/min (ft³/min)                      | -                            |             |  | 110            | (3885)     | -      |        |        |   |
| Refrigerant type / amount g(oz)                            |  | -                                     |                              |             | R410A  | 3.40k          | (119.9)    | -      |        |        |   |
| Product dimension  | Height                                   | mm(inch)                              | 235 (9-1/4)                  |             |  | 1416 (55-3/4)  |            |        | -      |        |   |
|  | Width                                    | mm(inch)                              | 1275 (50-3/16)               |             |  | 940 (37-1/32)  |            |        | -      |        |   |
|  | Depth                                    | mm(inch)                              | 690 (27-5/32)                |             |  | 340 (13-13/32) |            |        | -      |        |   |
| Packing dimension  | Height                                   | mm(inch)                              | 360                          |             |  | 1556           |            |        | -      |        |   |
|  | Width                                    | mm(inch)                              | 1340                         |             |  | 1055           |            |        | -      |        |   |
|  | Depth                                    | mm(inch)                              | 820                          |             |  | 485            |            |        | -      |        |   |
| Weight   | (NET)                                    | kg(lb)                                | 33 (73)                      |             |  | 98 (216)       |            |        | -      |        |   |
|  | (GROSS)                                  | kg(lb)                                | 42 (93)                      |             |  | 108 (238)      |            |        | -      |        |   |
| Layers limit (actually)                                    |  | 9 (10)                                |                              |             | 1 (2)  |                |            | -      |        |        |   |
| Operation condition  | Cool (DBT)                               | 18°C ~ 32°C                           |                              |             | -15°C ~ 46°C   |                |            | -      |        |        |   |
|  | Heat (DBT)                               | 16°C ~ 30°C                           |                              |             | -20°C ~ 24°C   |                |            | -      |        |        |   |
| P<br>I<br>P<br>I<br>N<br>G                                 | Pipe diameter mm (inch)                  | (Liquid)ø9.52(3/8) (Gas)ø15.88(5/8)   |                              |             | (Liquid)ø9.52(3/8) (Gas)ø15.88(5/8)                        |                |            | -      |        |        |   |
|  | Connecting method, Standard length m(ft) | flared type, 5.0(16.4)                |                              |             | flared type, 5.0(16.4)                                     |                |            | -      |        |        |   |
| Pipe length range  |  | m (ft)                                |                              |             | 5 ~ 75 (16.4 ~ 246.1)                                      |                |            | -      |        |        |   |
| Indoor unit & Outdoor unit height difference               |  | m (ft)                                |                              |             | 15 (OD located lower) / 30 (OD located higher) (49.2/98.4) |                |            | -      |        |        |   |
| Add gas amount   |  | g/m (oz/ft)                           |                              |             | 50 (0.538)   |                |            | -      |        |        |   |
| Pipe length for additional gas                             |  | m (ft)                                |                              |             | 30 (98.4)  |                |            | -      |        |        |   |

\*1: In case it is necessary to indicate the air flow volume in (l/s), the value in (m³/min.) shall be multiplied by 16.7 and rounded down the decimal point.

\*2: If the EUROVENT Certified models can be operated under the "extra-low" temperature condition, -7°C dry bulb and -8°C wet-bulb temperatures with rated voltage 230 V shall be used.

\*3: Network Impedance shall be applicable for EUROPE and CHINA models.

\*4: The annual consumption is calculated by multiplying the input power at 230 V (400 V) by an average of 500 hours per year in cooling mode.

\*5: EER and COP classification is at 230 V (400 V) only in accordance with EU directive 2002/31/EC.

\*6: SEER and SCOP classification is at 230V(400V) only in accordance with EN-14825. For heating, SCOP indicates the value of only Average heating season.

# Single -Type

## 1-1. Unit Specifications

PE1

### 2. Ceiling Type S-71PT2E5A / U-71PE1E5A

|   |   |                                     |  |                          |                                       |                                     |            |          |      |        |
|---|---|-------------------------------------|--|--------------------------|---------------------------------------|-------------------------------------|------------|----------|------|--------|
| INDOOR  |   | MODEL                               | S-71PT2E5A                                     |                          |                                       | -                                   |            |          | -    |        |
| PANEL   |   | MODEL                               | -  |                          |                                       | -                                   |            |          | -    |        |
| OUTDOOR   |   | MODEL                               | -  |                          |                                       | U-71PE1E5A                          |            |          | -    |        |
| Branch pipe   |   | MODEL                               | -  |                          |                                       | -                                   |            |          | -    |        |
| Performance test condition  |   |                                     |  |                          | ISO5151 / EN14511 / EN14825 / EN12102 |                                     |            |          |      |        |
| Power supply  |   | Ø, Hz                               | 1ø 50Hz  |                          |                                       | 1ø 50Hz                             |            |          |      |        |
|   |   | V                                   | 220  | 230                      | 240                                   | 220                                 | 230        | 240      | Min  | Max    |
| C<br>O<br>O<br>L<br>I<br>N<br>G                                       | Capacity  | kW                                  | 7.1  | 7.1                      | 7.1                                   | -                                   | -          | -        | 2.5  | 8.0    |
|   |   | BTU/h                               | 24200  | 24200                    | 24200                                 | -                                   | -          | -        | 8500 | 27300  |
|   | Current   | A                                   | 0.45   | 0.44                     | 0.43                                  | 9.00                                | 8.70       | 8.40     | -    | -      |
|   |   | W                                   | 55   | 55                       | 55                                    | 1.875k                              | 1.875k     | 1.875k   | -    | -      |
|   | Input power   | TOTAL W                             | -  | -                        | -                                     | 1.930k                              | 1.930k     | 1.930k   | 450  | 2.780k |
|   |   | Annual consumption                  | TOTAL kWh *4                                   | -                        | -                                     | -                                   | -          | 965      | -    | -      |
|   | EER/EER CLASS                                       | TOTAL (W/W) <sup>*5</sup> ("A"~"G") | -  | -                        | -                                     | 3.68                                | 3.68 / A   | 3.68     | 5.56 | 2.88   |
|   | Erp <sup>*6</sup>                                   | Pdesign                             | kW   | -                        | -                                     | -                                   | -          | 7.1      | -    | -      |
|   |   | SEER                                | (W/W)  | -                        | -                                     | -                                   | -          | 6.2      | -    | -      |
|   |   | Annual consumption                  | kWh  | -                        | -                                     | -                                   | -          | 401      | -    | -      |
| Class   |   |                                     | -  | -                        | -                                     | -                                   | A++        | -        | -    |        |
| Power factor  | %   | -                                   | -  | -                        | 95                                    | 94                                  | 93         | -        | -    |        |
| Noise indoor  | dB-A (H/M/L)  | 39/35/31                            |  |                          | -                                     | -                                   | -          | -        | -    |        |
|   | Power Level dB                                      | 57/53/49                            |  |                          | -                                     | -                                   | -          | -        | -    |        |
| Noise outdoor   | dB-A (H/L)  | -                                   |  |                          | 48/-                                  |                                     |            | -        | -    |        |
|   | Power Level dB                                      | -                                   |  |                          | 65/-                                  |                                     |            | -        | -    |        |
| H<br>E<br>A<br>T<br>I<br>N<br>G                                       | Capacity  | kW                                  | 8.0  | 8.0                      | 8.0                                   | -                                   | -          | -        | 2.0  | 9.0    |
|   |   | BTU/h                               | 27300  | 27300                    | 27300                                 | -                                   | -          | -        | 6800 | 30700  |
|   | Current   | A                                   | 0.45   | 0.44                     | 0.43                                  | 8.90                                | 8.60       | 8.30     | -    | -      |
|   |   | W                                   | 55   | 55                       | 55                                    | 1.875k                              | 1.875k     | 1.875k   | -    | -      |
|   | Input power   | TOTAL W                             | -  | -                        | -                                     | 1.930k                              | 1.930k     | 1.930k   | 400  | 2.900k |
|   |   | COP/COP CLASS                       | TOTAL (W/W) <sup>*5</sup> ("A"~"G")            | -                        | -                                     | -                                   | 4.15       | 4.15 / A | 4.15 | 5.00   |
|   | Erp <sup>*6</sup>                                   | Pdesign at -10°C                    | kW   | -                        | -                                     | -                                   | -          | 7.1      | -    | -      |
|   |   | Tbivalent                           | °C   | -                        | -                                     | -                                   | -          | -10      | -    | -      |
|   |   | SCOP                                | (W/W)  | -                        | -                                     | -                                   | -          | 4.0      | -    | -      |
|   |   | Annual consumption                  | kWh  | -                        | -                                     | -                                   | -          | 2485     | -    | -      |
| Class   |   | -                                   | -  | -                        | -                                     | A+                                  | -          | -        |      |        |
| Power factor  | %   | -                                   | -  | -                        | 96                                    | 95                                  | 94         | -        | -    |        |
| Noise indoor  | dB-A (H/M/L)  | 39/35/31                            |  |                          | -                                     | -                                   | -          | -        | -    |        |
|   | Power Level dB                                      | 57/53/49                            |  |                          | -                                     | -                                   | -          | -        | -    |        |
| Noise outdoor   | dB-A (H/L)  | -                                   |  |                          | 50/-                                  |                                     |            | -        | -    |        |
|   | Power Level dB                                      | -                                   |  |                          | 67/-                                  |                                     |            | -        | -    |        |
| EXTRA LOW TEMP <sup>†</sup> Total capacity(kW) / Input power(W) / COP |   |                                     |  |                          |                                       |                                     |            |          |      |        |
| Max Current(A) / Max Input power(W)                                   |   | 0.45/55                             | 0.44/55  | 0.43/55                  | 18.0/3.76k                            | 18.0/3.89k                          | 18.0/4.02k |          |      |        |
| Starting current(A) / Comp output(W)                                  |   | -                                   | -  | -                        | 9.00/2.0k                             | 8.70/2.0k                           | 8.40/2.0k  |          |      |        |
| Network Impedance(ΩMAX.)  |   |                                     |  |                          |                                       |                                     |            |          |      |        |
| Fan motor output (Indoor/Outdoor) W                                   |   |                                     |  | 74                       |                                       | 90                                  |            |          |      |        |
| Moisture removal volume   |   | L/h(Pt/h)                           |  | 4.2 (8.8)                |                                       |                                     |            |          |      |        |
| External static pressure  |   | Pa                                  |  | -                        |                                       |                                     |            |          |      |        |
| Indoor Air flow   | Cooling   | m³/min (ft³/min)                    |  | 21/18/15.5 (742/636/547) |                                       |                                     |            |          |      |        |
|   | Heating   | m³/min (ft³/min)                    |  | 21/18/15.5 (742/636/547) |                                       |                                     |            |          |      |        |
| Outdoor Air flow  | Cooling   | m³/min (ft³/min)                    |  | -                        |                                       | 60 (2119)                           |            |          |      |        |
|   | Heating   | m³/min (ft³/min)                    |  | -                        |                                       | 60 (2119)                           |            |          |      |        |
| Refrigerant type / amount g(oz)                                       |   |                                     |  |                          |                                       | R410A 2.35k (82.9)                  |            |          |      |        |
| Product dimension   | Height  | mm(inch)                            |  | 235 (9-1/4)              |                                       | 996 (39-7/32)                       |            |          |      |        |
|   | Width   | mm(inch)                            |  | 1275 (50-3/16)           |                                       | 940 (37-1/32)                       |            |          |      |        |
|   | Depth   | mm(inch)                            |  | 690 (27-5/32)            |                                       | 340 (13-13/32)                      |            |          |      |        |
| Packing dimension   | Height  | mm(inch)                            |  | 360                      |                                       | 1136                                |            |          |      |        |
|   | Width   | mm(inch)                            |  | 1340                     |                                       | 1055                                |            |          |      |        |
|   | Depth   | mm(inch)                            |  | 820                      |                                       | 485                                 |            |          |      |        |
| Weight  | (NET)   | kg(lb)                              |  | 33 (73)                  |                                       | 69 (152)                            |            |          |      |        |
|   | (GROSS)   | kg(lb)                              |  | 42 (93)                  |                                       | 77 (170)                            |            |          |      |        |
| Layers limit (actually)   |   |                                     |  | 9 (10)                   |                                       | 2 (3)                               |            |          |      |        |
| Operation condition   |   | Cool (DBT)                          |  | 18°C ~ 32°C              |                                       | -15°C ~ 46°C                        |            |          |      |        |
|   |   | Heat (DBT)                          |  | 16°C ~ 30°C              |                                       | -20°C ~ 24°C                        |            |          |      |        |
| P<br>I<br>P<br>I<br>N<br>G  | Pipe diameter mm (inch)                             |                                     | (Liquid)ø9.52(3/8) (Gas)ø15.88(5/8)            |                          |                                       | (Liquid)ø9.52(3/8) (Gas)ø15.88(5/8) |            |          |      |        |
|   | Connecting method, Standard length m(ft)            |                                     | flared type, 5.0(16.4)                         |                          |                                       | flared type, 5.0(16.4)              |            |          |      |        |
|   | Pipe length range m (ft)                            |                                     | 5 ~ 50 (16.4 ~ 164)                            |                          |                                       |                                     |            |          |      |        |
|   | Indoor unit & Outdoor unit height difference m (ft) |                                     | 15 (OD located lower) / 30 (OD located higher) |                          |                                       | (49.2/98.4)                         |            |          |      |        |
| Add gas amount g/m (oz/ft)  |   |                                     |  | 50 (0.538)               |                                       |                                     |            |          |      |        |
| Pipe length for additional gas m (ft)                                 |   |                                     |  | 30 (98.4)                |                                       |                                     |            |          |      |        |

\*1: In case it is necessary to indicate the air flow volume in (l/s), the value in (m³/min.) shall be multiplied by 16.7 and rounded down the decimal point.

\*2: If the EUROVENT Certified models can be operated under the "extra-low" temperature condition, -7°C dry bulb and -8°C wet-bulb temperatures with rated voltage 230 V shall be used.

\*3: Network Impedance shall be applicable for EUROPE and CHINA models.

\*4: The annual consumption is calculated by multiplying the input power at 230 V (400 V) by an average of 500 hours per year in cooling mode.

\*5: EER and COP classification is at 230 V (400 V) only in accordance with EU directive 2002/31/EC.

\*6: SEER and SCOP classification is at 230V(400V) only in accordance with EN-14825. For heating, SCOP indicates the value of only Average heating season, Other fiche data indicates in an attached sheet.

# Simultaneous (Twin) -Type

## 1-1. Unit Specifications

**PE1**

## 2. Ceiling Type S-71PT2E5A×2 / U-140PE1E5A

| INDOOR   |   | MODEL                                 | S-71PT2E5A×2                                   |             |              | -                                   |            |          | -     |        |      |
|--|---|---------------------------------------|--|-------------|--------------|-------------------------------------|------------|----------|-------|--------|------|
| PANEL  |   | MODEL                                 | -  |             |              | -                                   |            |          | -     |        |      |
| OUTDOOR  |   | MODEL                                 | -  |             |              | U-140PE1E5A                         |            |          | -     |        |      |
| Branch pipe  |   | MODEL                                 | -  |             |              | CZ-P155BK1                          |            |          | -     |        |      |
| Performance test condition                                 |   | ISO5151 / EN14511 / EN12102 / EN14825 |  |             |              |                                     |            |          |       |        |      |
| Power supply   |   | Ø, Hz                                 | 1ø 50Hz  |             |              | 1ø 50Hz                             |            |          |       |        |      |
|  |   | V                                     | 220  | 230         | 240          | 220                                 | 230        | 240      | Min   | Max    |      |
| C<br>O<br>O<br>L<br>I<br>N<br>G                            | Capacity  | kW                                    | 14.0   | 14.0        | 14.0         | -                                   | -          | -        | 3.3   | 15.0   |      |
|  |   | BTU/h                                 | 47800  | 47800       | 47800        | -                                   | -          | -        | 11300 | 51200  |      |
|  | Current   | A                                     | 0.45×2   | 0.44×2      | 0.43×2       | 21.2                                | 20.5       | 19.9     | -     | -      |      |
|  |   | W                                     | 55×2   | 55×2        | 55×2         | 4.540k                              | 4.540k     | 4.540k   | -     | -      |      |
|  | Input power   | TOTAL W                               | -  |             |              | 4.650k                              | 4.650k     | 4.650k   | 840   | 5.650k |      |
|  |   | Annual consumption                    | TOTAL kWh *4                                   | -           |              |                                     | -          | 2325     | -     | -      | -    |
|  | EER/EER CLASS                                       | TOTAL (W/W) <sup>5</sup> ("A"-G)      | -  | -           | -            | 3.01                                | 3.01 / B   | 3.01     | 3.93  | 2.65   |      |
|  | E <sub>rp</sub> <sup>*6</sup>                       | Pdesign                               | kW   | -           | -            | -                                   | -          | 14.0     | -     | -      | -    |
|  |   | η <sub>s.c</sub>                      | %  | -           | -            | -                                   | -          | 221.9    | -     | -      | -    |
|  |   | Annual consumption                    | kWh  | -           | -            | -                                   | -          | -        | -     | -      | -    |
| Class  |   |                                       | -  | -           | -            | -                                   | -          | -        | -     | -      |      |
| Power factor   | %   | -                                     | -  | -           | 97           | 96                                  | 95         | -        | -     |        |      |
| Noise indoor   | dB-A (H/M/L)  | 39/35/31                              |  |             | -            | -                                   | -          | -        | -     |        |      |
|  | Power Level dB                                      | 57/53/49                              |  |             | -            | -                                   | -          | -        | -     |        |      |
| Noise outdoor  | dB-A (H/L)  | -                                     |  |             | 54/-         |                                     |            | -        | -     |        |      |
|  | Power Level dB                                      | -                                     |  |             | 71/-         |                                     |            | -        | -     |        |      |
| H<br>E<br>A<br>T<br>I<br>N<br>G                            | Capacity  | kW                                    | 16.0   | 16.0        | 16.0         | -                                   | -          | -        | 4.1   | 18.0   |      |
|  |   | BTU/h                                 | 54600  | 54600       | 54600        | -                                   | -          | -        | 14000 | 61400  |      |
|  | Current   | A                                     | 0.45×2   | 0.44×2      | 0.43×2       | 19.9                                | 19.2       | 18.6     | -     | -      |      |
|  |   | W                                     | 55×2   | 55×2        | 55×2         | 4.250k                              | 4.250k     | 4.250k   | -     | -      |      |
|  | Input power   | TOTAL W                               | -  |             |              | 4.360k                              | 4.360k     | 4.360k   | 900   | 5.930k |      |
|  |   | COP/COP CLASS                         | TOTAL (W/W) <sup>5</sup> ("A"-G)               | -           | -            | -                                   | 3.67       | 3.67 / A | 3.67  | 4.56   | 3.04 |
|  | E <sub>rp</sub> <sup>*6</sup>                       | Pdesign at -10°C                      | kW   | -           | -            | -                                   | -          | 14.0     | -     | -      | -    |
|  |   | Tbivalent                             | °C   | -           | -            | -                                   | -          | -7       | -     | -      | -    |
|  |   | η <sub>s.h</sub>                      | %  | -           | -            | -                                   | -          | 145.5    | -     | -      | -    |
|  |   | Annual consumption                    | kWh  | -           | -            | -                                   | -          | -        | -     | -      | -    |
| Class  |   | -                                     | -  | -           | -            | -                                   | -          | -        | -     |        |      |
| Power factor   | %   | -                                     | -  | -           | 97           | 96                                  | 95         | -        | -     |        |      |
| Noise indoor   | dB-A (H/M/L)  | 39/35/31                              |  |             | -            | -                                   | -          | -        | -     |        |      |
|  | Power Level dB                                      | 57/53/49                              |  |             | -            | -                                   | -          | -        | -     |        |      |
| Noise outdoor  | dB-A (H/L)  | -                                     |  |             | 55/-         |                                     |            | -        | -     |        |      |
|  | Power Level dB                                      | -                                     |  |             | 71/-         |                                     |            | -        | -     |        |      |
| EXTRA LOW TEMP   Total capacity(kW) / Input power(W) / COP |   | -                                     |  |             |              |                                     |            |          |       |        |      |
| Max Current(A) / Max Input power(W)                        |   | 0.45×2/55×2                           | 0.44×2/55×2                                    | 0.43×2/55×2 | 30.0/6.40k   | 30.0/6.62k                          | 30.0/6.84k | -        |       |        |      |
| Starting current(A) / Comp output(W)                       |   | -                                     | -  | -           | 21.2/3.0k    | 20.5/3.0k                           | 19.8/3.0k  | -        |       |        |      |
| Network Impedance(ΩMAX.)                                   |   | -                                     |  |             |              |                                     |            |          |       |        |      |
| Fan motor output (Indoor/Outdoor) W                        |   | 74                                    |  |             | 90×2         |                                     |            | -        |       |        |      |
| Moisture removal volume                                    |   | L/h(Pt/h)                             | 9.0  | (4.5×2)     | (18.9)       | -                                   |            |          | -     |        |      |
| External static pressure                                   |   | Pa                                    | -  |             |              | -                                   |            |          | -     |        |      |
| Indoor Air flow  | Cooling   | m³/min (ft³/min)                      | [21/18/15.5 (742/636/547)]×2                   |             |              | -                                   |            |          | -     |        |      |
|  | Heating   | m³/min (ft³/min)                      | [21/18/15.5 (742/636/547)]×2                   |             |              | -                                   |            |          | -     |        |      |
| Outdoor Air flow   | Cooling   | m³/min (ft³/min)                      | -  |             |              | 135                                 | (4767)     | -        |       |        |      |
|  | Heating   | m³/min (ft³/min)                      | -  |             |              | 120                                 | (4238)     | -        |       |        |      |
| Refrigerant type / amount g(oz)                            |   | -                                     |  |             | R410A        | 3.40k                               | (119.9)    | -        |       |        |      |
| Product dimension  | Height  | mm(inch)                              | 235 (9-1/4)                                    |             |              | 1416 (55-3/4)                       |            |          | -     |        |      |
|  | Width   | mm(inch)                              | 1275 (50-3/16)                                 |             |              | 940 (37-1/32)                       |            |          | -     |        |      |
|  | Depth   | mm(inch)                              | 690 (27-5/32)                                  |             |              | 340 (13-13/32)                      |            |          | -     |        |      |
| Packing dimension  | Height  | mm(inch)                              | 360  |             |              | 1556                                |            |          | -     |        |      |
|  | Width   | mm(inch)                              | 1340   |             |              | 1055                                |            |          | -     |        |      |
|  | Depth   | mm(inch)                              | 820  |             |              | 485                                 |            |          | -     |        |      |
| Weight   | (NET)   | kg(lb)                                | 33 (73)  |             |              | 98 (216)                            |            |          | -     |        |      |
|  | (GROSS)   | kg(lb)                                | 42 (93)  |             |              | 108 (238)                           |            |          | -     |        |      |
| Layers limit (actually)                                    |   | 9 (10)                                |  |             | 1 (2)        |                                     |            | -        |       |        |      |
| Operation condition  | Cool (DBT)  | 18°C ~ 32°C                           |  |             | -15°C ~ 46°C |                                     |            | -        |       |        |      |
|  | Heat (DBT)  | 16°C ~ 30°C                           |  |             | -20°C ~ 24°C |                                     |            | -        |       |        |      |
| P<br>I<br>P<br>I<br>N<br>G                                 | Pipe diameter mm (inch)                             |                                       | (Liquid)ø9.52(3/8) (Gas)ø15.88(5/8)            |             |              | (Liquid)ø9.52(3/8) (Gas)ø15.88(5/8) |            |          | -     |        |      |
|  | Connecting method, Standard length m(ft)            |                                       | flared type, 5.0(16.4)                         |             |              | flared type, 5.0(16.4)              |            |          | -     |        |      |
|  | Pipe length range m (ft)                            |                                       | 5 ~ 75 (16.4 ~ 246.1)                          |             |              | -                                   |            |          | -     |        |      |
|  | Indoor unit & Outdoor unit height difference m (ft) |                                       | 15 (OD located lower) / 30 (OD located higher) |             |              | (49.2/98.4)                         |            |          | -     |        |      |
|  | Add gas amount g/m (oz/ft)                          |                                       | 50 (0.538)                                     |             |              | -                                   |            |          | -     |        |      |
| Pipe length for additional gas m (ft)                      |   | 30 (98.4)                             |  |             | -            |                                     |            | -        |       |        |      |

\*1: In case it is necessary to indicate the air flow volume in (l/s), the value in (m³/min.) shall be multiplied by 16.7 and rounded down the decimal point.

\*2: If the EUROVENT Certified models can be operated under the "extra-low" temperature condition, -7°C dry bulb and -8°C wet-bulb temperatures with rated voltage 230 V shall be used.

\*3: Network Impedance shall be applicable for EUROPE and CHINA models.

\*4: The annual consumption is calculated by multiplying the input power at 230 V (400 V) by an average of 500 hours per year in cooling mode.

\*5: EER and COP classification is at 230 V (400 V) only in accordance with EU directive 2002/31/EC.

\*6: SEER and SCOP classification is at 230V(400V) only in accordance with EN-14825. For heating, SCOP indicates the value of only Average heating season.

# Single -Type

## 1-1. Unit Specifications

PE1

### 2. Ceiling Type S-100PT2E5A / U-100PE1E5A

|   |   |                                     |                                     |  |                                       |                                     |            |          |       |        |
|---|---|-------------------------------------|-------------------------------------|--|---------------------------------------|-------------------------------------|------------|----------|-------|--------|
| INDOOR  |   | MODEL                               | S-100PT2E5A                         |  |                                       | -                                   |            |          | -     |        |
| PANEL   |   | MODEL                               | -                                   |  |                                       | -                                   |            |          | -     |        |
| OUTDOOR   |   | MODEL                               | -                                   |  |                                       | U-100PE1E5A                         |            |          | -     |        |
| Branch pipe   |   | MODEL                               | -                                   |  |                                       | -                                   |            |          | -     |        |
| Performance test condition  |   |                                     |                                     |  | ISO5151 / EN14511 / EN14825 / EN12102 |                                     |            |          |       |        |
| Power supply  |   | Ø, Hz                               | 1ø 50Hz                             |  |                                       | 1ø 50Hz                             |            |          |       |        |
|   |   | V                                   | 220                                 | 230  | 240                                   | 220                                 | 230        | 240      | Min   | Max    |
| C<br>O<br>O<br>L<br>I<br>N<br>G                                       | Capacity  | kW                                  | 10.0                                | 10.0   | 10.0                                  | -                                   | -          | -        | 3.3   | 12.5   |
|   |   | BTU/h                               | 34100                               | 34100  | 34100                                 | -                                   | -          | -        | 11300 | 42700  |
|   | Current   | A                                   | 0.69                                | 0.67   | 0.65                                  | 11.5                                | 11.1       | 10.6     | -     | -      |
|   |   | W                                   | 80                                  | 80   | 80                                    | 2.450k                              | 2.450k     | 2.450k   | -     | -      |
|   | Input power   | TOTAL W                             | -                                   | -  | -                                     | 2.530k                              | 2.530k     | 2.530k   | 840   | 3.850k |
|   |   | Annual consumption                  | TOTAL kWh *4                        | -  | -                                     | -                                   | -          | 1265     | -     | -      |
|   | EER/EER CLASS                                       | TOTAL (W/W) <sup>*5</sup> ("A"~"G") | -                                   | -  | -                                     | 3.95                                | 3.95 / A   | 3.95     | 3.93  | 3.25   |
|   | Erp <sup>*6</sup>                                   | Pdesign                             | kW                                  | -  | -                                     | -                                   | -          | 10.0     | -     | -      |
|   |   | SEER                                | (W/W)                               | -  | -                                     | -                                   | -          | 6.7      | -     | -      |
|   |   | Annual consumption                  | kWh                                 | -  | -                                     | -                                   | -          | 523      | -     | -      |
| Class   |   |                                     | -                                   | -  | -                                     | -                                   | A++        | -        | -     |        |
| Power factor  | %   | -                                   | -                                   | -  | 97                                    | 96                                  | 96         | -        | -     |        |
| Noise indoor  | dB-A (H/M/L)  | 42/37/35                            |                                     |  | -                                     | -                                   | -          | -        | -     |        |
|   | Power Level dB                                      | 60/55/53                            |                                     |  | -                                     | -                                   | -          | -        | -     |        |
| Noise outdoor   | dB-A (H/L)  | -                                   |                                     |  | 52/-                                  |                                     |            | -        | -     |        |
|   | Power Level dB                                      | -                                   |                                     |  | 69/-                                  |                                     |            | -        | -     |        |
| H<br>E<br>A<br>T<br>I<br>N<br>G                                       | Capacity  | kW                                  | 11.2                                | 11.2   | 11.2                                  | -                                   | -          | -        | 4.1   | 14.0   |
|   |   | BTU/h                               | 38200                               | 38200  | 38200                                 | -                                   | -          | -        | 14000 | 47800  |
|   | Current   | A                                   | 0.69                                | 0.67   | 0.65                                  | 11.8                                | 11.4       | 11.0     | -     | -      |
|   |   | W                                   | 80                                  | 80   | 80                                    | 2.520k                              | 2.520k     | 2.520k   | -     | -      |
|   | Input power   | TOTAL W                             | -                                   | -  | -                                     | 2.600k                              | 2.600k     | 2.600k   | 900   | 4.400k |
|   |   | COP/COP CLASS                       | TOTAL (W/W) <sup>*5</sup> ("A"~"G") | -  | -                                     | -                                   | 4.31       | 4.31 / A | 4.31  | 4.56   |
|   | Erp <sup>*6</sup>                                   | Pdesign at -10°C                    | kW                                  | -  | -                                     | -                                   | -          | 10.0     | -     | -      |
|   |   | Tbivalent                           | °C                                  | -  | -                                     | -                                   | -          | -10      | -     | -      |
|   |   | SCOP                                | (W/W)                               | -  | -                                     | -                                   | -          | 4.3      | -     | -      |
|   |   | Annual consumption                  | kWh                                 | -  | -                                     | -                                   | -          | 3256     | -     | -      |
| Class   |   | -                                   | -                                   | -  | -                                     | A+                                  | -          | -        |       |        |
| Power factor  | %   | -                                   | -                                   | -  | 97                                    | 96                                  | 95         | -        | -     |        |
| Noise indoor  | dB-A (H/M/L)  | 42/37/35                            |                                     |  | -                                     | -                                   | -          | -        | -     |        |
|   | Power Level dB                                      | 60/55/53                            |                                     |  | -                                     | -                                   | -          | -        | -     |        |
| Noise outdoor   | dB-A (H/L)  | -                                   |                                     |  | 52/-                                  |                                     |            | -        | -     |        |
|   | Power Level dB                                      | -                                   |                                     |  | 69/-                                  |                                     |            | -        | -     |        |
| EXTRA LOW TEMP <sup>†</sup> Total capacity(kW) / Input power(W) / COP |   |                                     |                                     |  |                                       |                                     |            |          |       |        |
| Max Current(A) / Max Input power(W)                                   |   | 0.69/80                             | 0.67/80                             | 0.65/80  | 25.0/5.34k                            | 25.0/5.52k                          | 25.0/5.70k |          |       |        |
| Starting current(A) / Comp output(W)                                  |   | -                                   | -                                   | -  | 11.8/3.0k                             | 11.4/3.0k                           | 11.0/3.0k  |          |       |        |
| Network Impedance(ΩMAX.)  |   |                                     |                                     |  |                                       |                                     |            |          |       |        |
| Fan motor output (Indoor/Outdoor) W                                   |   |                                     |                                     | 111  |                                       | 90×2                                |            |          |       |        |
| Moisture removal volume   |   | L/h(Pt/h)                           |                                     | 6.0 (12.6)                                     |                                       |                                     |            |          |       |        |
| External static pressure  |   | Pa                                  |                                     | -  |                                       |                                     |            |          |       |        |
| Indoor Air flow   | Cooling   | m³/min (ft³/min)                    |                                     | 30/25/23 (1059/883/812)                        |                                       |                                     |            |          |       |        |
|   | Heating   | m³/min (ft³/min)                    |                                     | 30/25/23 (1059/883/812)                        |                                       |                                     |            |          |       |        |
| Outdoor Air flow  | Cooling   | m³/min (ft³/min)                    |                                     | -  |                                       | 110 (3885)                          |            |          |       |        |
|   | Heating   | m³/min (ft³/min)                    |                                     | -  |                                       | 95 (3355)                           |            |          |       |        |
| Refrigerant type / amount g(oz)                                       |   |                                     |                                     |  |                                       | R410A 3.40k (119.9)                 |            |          |       |        |
| Product dimension   | Height  | mm(inch)                            |                                     | 235 (9-1/4)                                    |                                       | 1416 (55-3/4)                       |            |          |       |        |
|   | Width   | mm(inch)                            |                                     | 1590 (62-19/32)                                |                                       | 940 (37-1/32)                       |            |          |       |        |
|   | Depth   | mm(inch)                            |                                     | 690 (27-5/32)                                  |                                       | 340 (13-13/32)                      |            |          |       |        |
| Packing dimension   | Height  | mm(inch)                            |                                     | 360  |                                       | 1556                                |            |          |       |        |
|   | Width   | mm(inch)                            |                                     | 1655   |                                       | 1055                                |            |          |       |        |
|   | Depth   | mm(inch)                            |                                     | 820  |                                       | 485                                 |            |          |       |        |
| Weight  | (NET)   | kg(lb)                              |                                     | 40 (88)  |                                       | 98 (216)                            |            |          |       |        |
|   | (GROSS)   | kg(lb)                              |                                     | 49 (108)                                       |                                       | 108 (238)                           |            |          |       |        |
| Layers limit (actually)   |   |                                     |                                     | 9 (10)   |                                       | 1 (2)                               |            |          |       |        |
| Operation condition   | Cool (DBT)  |                                     |                                     | 18°C ~ 32°C                                    |                                       | -15°C ~ 46°C                        |            |          |       |        |
|   | Heat (DBT)  |                                     |                                     | 16°C ~ 30°C                                    |                                       | -20°C ~ 24°C                        |            |          |       |        |
| P<br>I<br>P<br>I<br>N<br>G  | Pipe diameter mm (inch)                             |                                     |                                     | (Liquid)ø9.52(3/8) (Gas)ø15.88(5/8)            |                                       | (Liquid)ø9.52(3/8) (Gas)ø15.88(5/8) |            |          |       |        |
|   | Connecting method, Standard length m(ft)            |                                     |                                     | flared type, 5.0(16.4)                         |                                       | flared type, 5.0(16.4)              |            |          |       |        |
|   | Pipe length range m (ft)                            |                                     |                                     | 5 ~ 75 (16.4 ~ 246.1)                          |                                       |                                     |            |          |       |        |
|   | Indoor unit & Outdoor unit height difference m (ft) |                                     |                                     | 15 (OD located lower) / 30 (OD located higher) |                                       | (49.2/98.4)                         |            |          |       |        |
| Add gas amount g/m (oz/ft)  |   |                                     |                                     | 50 (0.538)                                     |                                       |                                     |            |          |       |        |
| Pipe length for additional gas m (ft)                                 |   |                                     |                                     | 30 (98.4)                                      |                                       |                                     |            |          |       |        |

\*1: In case it is necessary to indicate the air flow volume in (l/s), the value in (m³/min.) shall be multiplied by 16.7 and rounded down the decimal point.

\*2: If the EUROVENT Certified models can be operated under the "extra-low" temperature condition, -7°C dry bulb and -8°C wet-bulb temperatures with rated voltage 230 V shall be used.

\*3: Network Impedance shall be applicable for EUROPE and CHINA models.

\*4: The annual consumption is calculated by multiplying the input power at 230 V (400 V) by an average of 500 hours per year in cooling mode.

\*5: EER and COP classification is at 230 V (400 V) only in accordance with EU directive 2002/31/EC.

\*6: SEER and SCOP classification is at 230V(400V) only in accordance with EN-14825. For heating, SCOP indicates the value of only Average heating season, Other fiche data indicates in an attached sheet.

# Single -Type

## 1-1. Unit Specifications

**PE1**

## 2. Ceiling Type S-125PT2E5A / U-125PE1E5A

| INDOOR   |   | MODEL                                 | S-125PT2E5A                                    |          |                                       | -                                   |            |          | -     |        |      |
|--|---|---------------------------------------|--|----------|---------------------------------------|-------------------------------------|------------|----------|-------|--------|------|
| PANEL  |   | MODEL                                 | -  |          |                                       | -                                   |            |          | -     |        |      |
| OUTDOOR  |   | MODEL                                 | -  |          |                                       | U-125PE1E5A                         |            |          | -     |        |      |
| Branch pipe  |   | MODEL                                 | -  |          |                                       | -                                   |            |          | -     |        |      |
| Performance test condition                                 |   |                                       |  |          | ISO5151 / EN14511 / EN12102 / EN14825 |                                     |            |          |       |        |      |
| Power supply   |   | Ø, Hz                                 | 1ø 50Hz  |          |                                       | 1ø 50Hz                             |            |          |       |        |      |
|  |   | V                                     | 220  | 230      | 240                                   | 220                                 | 230        | 240      | Min   | Max    |      |
| C<br>O<br>O<br>L<br>I<br>N<br>G                            | Capacity  | kW                                    | 12.5   | 12.5     | 12.5                                  | -                                   | -          | -        | 3.3   | 14.0   |      |
|  |   | BTU/h                                 | 42700  | 42700    | 42700                                 | -                                   | -          | -        | 11300 | 47800  |      |
|  | Current   | A                                     | 0.89   | 0.86     | 0.83                                  | 17.0                                | 16.4       | 15.8     | -     | -      |      |
|  |   | W                                     | 110  | 110      | 110                                   | 3.620k                              | 3.620k     | 3.620k   | -     | -      |      |
|  | Input power   | TOTAL W                               | -  |          |                                       | 3.730k                              | 3.730k     | 3.730k   | 840   | 4.860k |      |
|  |   | Annual consumption                    | TOTAL kWh *4                                   | -        |                                       |                                     | -          | 1865     | -     | -      | -    |
|  | EER/EER CLASS                                       | TOTAL (W/W) <sup>5/6</sup> ("A"-~"G") | -  | -        | -                                     | 3.35                                | 3.35 / A   | 3.35     | 3.93  | 2.88   |      |
|  | Erp *6  | Pdesign                               | kW   | -        | -                                     | -                                   | -          | 12.5     | -     | -      | -    |
|  |   | η <sub>s,c</sub>                      | %  | -        | -                                     | -                                   | -          | 227.4    | -     | -      | -    |
|  |   | Annual consumption                    | kWh  | -        | -                                     | -                                   | -          | -        | -     | -      | -    |
| Class  |   |                                       | -  | -        | -                                     | -                                   | -          | -        | -     | -      |      |
| Power factor   | %   | -                                     | -  | -        | 97                                    | 96                                  | 96         | -        | -     |        |      |
| Noise indoor   | dB-A (H/M/L)  | 46/40/36                              |  |          | -                                     | -                                   | -          | -        | -     |        |      |
|  | Power Level dB                                      | 64/58/54                              |  |          | -                                     | -                                   | -          | -        | -     |        |      |
| Noise outdoor  | dB-A (H/L)  | -                                     |  |          | 53/-                                  |                                     |            | -        | -     |        |      |
|  | Power Level dB                                      | -                                     |  |          | 70/-                                  |                                     |            | -        | -     |        |      |
| H<br>E<br>A<br>T<br>I<br>N<br>G                            | Capacity  | kW                                    | 14.0   | 14.0     | 14.0                                  | -                                   | -          | -        | 4.1   | 16.0   |      |
|  |   | BTU/h                                 | 47800  | 47800    | 47800                                 | -                                   | -          | -        | 14000 | 54600  |      |
|  | Current   | A                                     | 0.89   | 0.86     | 0.83                                  | 16.0                                | 15.4       | 14.9     | -     | -      |      |
|  |   | W                                     | 110  | 110      | 110                                   | 3.400k                              | 3.400k     | 3.400k   | -     | -      |      |
|  | Input power   | TOTAL W                               | -  |          |                                       | 3.510k                              | 3.510k     | 3.510k   | 900   | 5.210k |      |
|  |   | COP/COP CLASS                         | TOTAL (W/W) <sup>5/6</sup> ("A"-~"G")          | -        | -                                     | -                                   | 3.99       | 3.99 / A | 3.99  | 4.56   | 3.07 |
|  | Erp *6  | Pdesign at -10°C                      | kW   | -        | -                                     | -                                   | -          | 12.5     | -     | -      | -    |
|  |   | Tbivalent                             | °C   | -        | -                                     | -                                   | -          | -10      | -     | -      | -    |
|  |   | η <sub>s,h</sub>                      | %  | -        | -                                     | -                                   | -          | 149.5    | -     | -      | -    |
|  |   | Annual consumption                    | kWh  | -        | -                                     | -                                   | -          | -        | -     | -      | -    |
| Class  |   | -                                     | -  | -        | -                                     | -                                   | -          | -        | -     |        |      |
| Power factor   | %   | -                                     | -  | -        | 97                                    | 96                                  | 95         | -        | -     |        |      |
| Noise indoor   | dB-A (H/M/L)  | 46/40/36                              |  |          | -                                     | -                                   | -          | -        | -     |        |      |
|  | Power Level dB                                      | 64/58/54                              |  |          | -                                     | -                                   | -          | -        | -     |        |      |
| Noise outdoor  | dB-A (H/L)  | -                                     |  |          | 53/-                                  |                                     |            | -        | -     |        |      |
|  | Power Level dB                                      | -                                     |  |          | 70/-                                  |                                     |            | -        | -     |        |      |
| EXTRA LOW TEMP   Total capacity(kW) / Input power(W) / COP |   |                                       |  |          |                                       |                                     |            |          |       |        |      |
| Max Current(A) / Max Input power(W)                        |   | 0.89/110                              | 0.86/110                                       | 0.83/110 | 28.0/5.98k                            | 28.0/6.18k                          | 28.0/6.38k |          |       |        |      |
| Starting current(A) / Comp output(W)                       |   | -                                     | -  | -        | 17.0/3.0k                             | 16.4/3.0k                           | 15.8/3.0k  |          |       |        |      |
| Network Impedance(ΩMAX.)                                   |   |                                       |  |          |                                       |                                     |            |          |       |        |      |
| Fan motor output (Indoor/Outdoor) W                        |   |                                       |  | 111      |                                       | 90×2                                |            |          |       |        |      |
| Moisture removal volume                                    |   | L/h(Pt/h)                             | 7.9  | (16.6)   |                                       |                                     |            |          |       |        |      |
| External static pressure                                   |   | Pa                                    |  |          |                                       |                                     |            |          |       |        |      |
| Indoor Air flow  | Cooling   | m³/min (ft³/min)                      | 34/28/24 (1201/989/848)                        |          |                                       |                                     |            |          | -     | -      |      |
|  | Heating   | m³/min (ft³/min)                      | 34/28/24 (1201/989/848)                        |          |                                       |                                     |            |          | -     | -      |      |
| Outdoor Air flow   | Cooling   | m³/min (ft³/min)                      | -  |          |                                       | 130                                 | (4591)     |          |       |        |      |
|  | Heating   | m³/min (ft³/min)                      | -  |          |                                       | 110                                 | (3885)     |          |       |        |      |
| Refrigerant type / amount g(oz)                            |   |                                       |  |          |                                       | R410A                               | 3.40k      | (119.9)  | -     |        |      |
| Product dimension  | Height  | mm(inch)                              | 235 (9-1/4)                                    |          |                                       | 1416 (55-3/4)                       |            |          | -     | -      |      |
|  | Width   | mm(inch)                              | 1590 (62-19/32)                                |          |                                       | 940 (37-1/32)                       |            |          | -     | -      |      |
|  | Depth   | mm(inch)                              | 690 (27-5/32)                                  |          |                                       | 340 (13-13/32)                      |            |          | -     | -      |      |
| Packing dimension  | Height  | mm(inch)                              | 360  |          |                                       | 1556                                |            |          | -     | -      |      |
|  | Width   | mm(inch)                              | 1655   |          |                                       | 1055                                |            |          | -     | -      |      |
|  | Depth   | mm(inch)                              | 820  |          |                                       | 485                                 |            |          | -     | -      |      |
| Weight   | (NET)   | kg(lb)                                | 40 (88)  |          |                                       | 98 (216)                            |            |          | -     | -      |      |
|  | (GROSS)   | kg(lb)                                | 49 (108)                                       |          |                                       | 108 (238)                           |            |          | -     | -      |      |
| Layers limit (actually)                                    |   |                                       |  | 9 (10)   |                                       | 1 (2)                               |            |          |       |        |      |
| Operation condition  | Cool (DBT)  | 18°C ~ 32°C                           |  |          | -15°C ~ 46°C                          |                                     |            |          |       |        |      |
|  | Heat (DBT)  | 16°C ~ 30°C                           |  |          | -20°C ~ 24°C                          |                                     |            |          |       |        |      |
| P<br>I<br>P<br>E<br>I<br>N<br>G                            | Pipe diameter mm (inch)                             |                                       | (Liquid)ø9.52(3/8) (Gas)ø15.88(5/8)            |          |                                       | (Liquid)ø9.52(3/8) (Gas)ø15.88(5/8) |            |          |       |        |      |
|  | Connecting method, Standard length m(ft)            |                                       | flared type, 5.0(16.4)                         |          |                                       | flared type, 5.0(16.4)              |            |          |       |        |      |
|  | Pipe length range m (ft)                            |                                       | 5 ~ 75 (16.4 ~ 246.1)                          |          |                                       |                                     |            |          |       |        |      |
|  | Indoor unit & Outdoor unit height difference m (ft) |                                       | 15 (OD located lower) / 30 (OD located higher) |          |                                       | (49.2/98.4)                         |            |          |       |        |      |
|  | Add gas amount g/m (oz/ft)                          |                                       | 50 (0.538)                                     |          |                                       |                                     |            |          |       |        |      |
| Pipe length for additional gas m (ft)                      |   | 30 (98.4)                             |  |          |                                       |                                     |            |          |       |        |      |

\*1: In case it is necessary to indicate the air flow volume in (l/s), the value in (m³/min.) shall be multiplied by 16.7 and rounded down the decimal point.

\*2: If the EUROVENT Certified models can be operated under the "extra-low" temperature condition, -7°C dry bulb and -8°C wet-bulb temperatures with rated voltage 230 V shall be used.

\*3: Network Impedance shall be applicable for EUROPE and CHINA models.

\*4: The annual consumption is calculated by multiplying the input power at 230 V (400 V) by an average of 500 hours per year in cooling mode.

\*5: EER and COP classification is at 230 V (400 V) only in accordance with EU directive 2002/31/EC.

\*6: SEER and SCOP classification is at 230V(400V) only in accordance with EN-14825. For heating, SCOP indicates the value of only Average heating season.



# Single -Type

## 1-1. Unit Specifications

**PE1**

### 2. Ceiling Type S-140PT2E5A / U-140PE1E5A

| INDOOR  |                    | MODEL  | S-140PT2E5A              |          |                                       | -              |            |        | -     |        |   |
|---|--------------------|--|--------------------------|----------|---------------------------------------|----------------|------------|--------|-------|--------|---|
| PANEL   |                    | MODEL  | -                        |          |                                       | -              |            |        | -     |        |   |
| OUTDOOR   |                    | MODEL  | -                        |          |                                       | U-140PE1E5A    |            |        | -     |        |   |
| Branch pipe   |                    | MODEL  | -                        |          |                                       | -              |            |        | -     |        |   |
| Performance test condition  |                    |  |                          |          | ISO5151 / EN14511 / EN12102 / EN14825 |                |            |        |       |        |   |
| Power supply  |                    | Ø, Hz  | 1ø 50Hz                  |          |                                       | 1ø 50Hz        |            |        |       |        |   |
|   |                    | V  | 220                      | 230      | 240                                   | 220            | 230        | 240    | Min   | Max    |   |
| C<br>O<br>O<br>L<br>I<br>N<br>G                                       | Capacity           | kW   | 14.0                     | 14.0     | 14.0                                  | -              | -          | -      | 3.3   | 15.0   |   |
|   |                    | BTU/h  | 47800                    | 47800    | 47800                                 | -              | -          | -      | 11300 | 51200  |   |
|   | Current            | A  | 0.94                     | 0.91     | 0.88                                  | 21.2           | 20.5       | 19.8   | -     | -      |   |
|   | Input power        | W  | 120                      | 120      | 120                                   | 4.530k         | 4.530k     | 4.530k | -     | -      |   |
|   |                    | TOTAL W  | -                        | -        | -                                     | 4.650k         | 4.650k     | 4.650k | 840   | 5.650k |   |
|   | Annual consumption | TOTAL kWh *4                                   | -                        | -        | -                                     | -              | 2325       | -      | -     | -      |   |
|   | EER/EER CLASS      | TOTAL (W/W) <sup>5</sup> ("A"~"G")             | -                        | -        | -                                     | 3.01           | 3.01 / B   | 3.01   | 3.93  | 2.65   |   |
|   | Erp <sup>6</sup>   | Pdesign  | kW                       | -        | -                                     | -              | -          | 14.0   | -     | -      | - |
|   |                    | η <sub>s,c</sub>                               | %                        | -        | -                                     | -              | -          | 211.3  | -     | -      | - |
|   |                    | Annual consumption                             | kWh                      | -        | -                                     | -              | -          | -      | -     | -      | - |
| Class   |                    | -  | -                        | -        | -                                     | -              | -          | -      | -     | -      |   |
| Power factor  | %                  | -  | -                        | -        | 97                                    | 96             | 96         | -      | -     |        |   |
| Noise indoor  | dB-A (H/M/L)       | 47/41/37                                       |                          |          | -                                     | -              | -          | -      | -     |        |   |
|   | Power Level dB     | 65/59/55                                       |                          |          | -                                     | -              | -          | -      | -     |        |   |
| Noise outdoor   | dB-A (H/L)         | -  |                          |          | 54/-                                  |                |            | -      | -     |        |   |
|   | Power Level dB     | -  |                          |          | 71/-                                  |                |            | -      | -     |        |   |
| H<br>E<br>A<br>T<br>I<br>N<br>G                                       | Capacity           | kW   | 16.0                     | 16.0     | 16.0                                  | -              | -          | -      | 4.1   | 18.0   |   |
|   |                    | BTU/h  | 54600                    | 54600    | 54600                                 | -              | -          | -      | 14000 | 61400  |   |
|   | Current            | A  | 0.94                     | 0.91     | 0.88                                  | 19.8           | 19.2       | 18.5   | -     | -      |   |
|   | Input power        | W  | 120                      | 120      | 120                                   | 4.240k         | 4.240k     | 4.240k | -     | -      |   |
|   |                    | TOTAL W  | -                        | -        | -                                     | 4.360k         | 4.360k     | 4.360k | 900   | 5.930k |   |
|   | COP/COP CLASS      | TOTAL (W/W) <sup>5</sup> ("A"~"G")             | -                        | -        | -                                     | 3.67           | 3.67 / A   | 3.67   | 4.56  | 3.04   |   |
|   | Erp <sup>6</sup>   | Pdesign at -10°C                               | kW                       | -        | -                                     | -              | -          | 14.0   | -     | -      | - |
|   |                    | Tbivalent                                      | °C                       | -        | -                                     | -              | -          | -7     | -     | -      | - |
|   |                    | η <sub>s,h</sub>                               | %                        | -        | -                                     | -              | -          | 145.0  | -     | -      | - |
|   |                    | Annual consumption                             | kWh                      | -        | -                                     | -              | -          | -      | -     | -      | - |
| Class   | -                  | -  | -                        | -        | -                                     | -              | -          | -      | -     |        |   |
| Power factor  | %                  | -  | -                        | -        | 97                                    | 96             | 95         | -      | -     |        |   |
| Noise indoor  | dB-A (H/M/L)       | 47/41/37                                       |                          |          | -                                     | -              | -          | -      | -     |        |   |
|   | Power Level dB     | 65/59/55                                       |                          |          | -                                     | -              | -          | -      | -     |        |   |
| Noise outdoor   | dB-A (H/L)         | -  |                          |          | 55/-                                  |                |            | -      | -     |        |   |
|   | Power Level dB     | -  |                          |          | 71/-                                  |                |            | -      | -     |        |   |
| EXTRA LOW TEMP <sup>2</sup> Total capacity(kW) / Input power(W) / COP |                    | -  |                          | -        |                                       | -              |            | -      |       |        |   |
| Max Current(A) / Max Input power(W)                                   |                    | 0.94/120                                       | 0.91/120                 | 0.88/120 | 30.0/6.40k                            | 30.0/6.62k     | 30.0/6.84k | -      |       |        |   |
| Starting current(A) / Comp output(W)                                  |                    | -  | -                        | -        | 21.1/2.0k                             | 20.5/2.0k      | 19.8/2.0k  | -      |       |        |   |
| Network Impedance(ΩMAX.)  |                    | -  |                          | -        |                                       | -              |            | -      |       |        |   |
| Fan motor output (Indoor/Outdoor) W                                   |                    | 111  |                          | -        |                                       | 90×2           |            | -      |       |        |   |
| Moisture removal volume   |                    | L/h(Pt/h)                                      | 9.0                      | (18.9)   | -                                     |                | -          |        |       |        |   |
| External static pressure  |                    | Pa   | -                        |          | -                                     |                | -          |        |       |        |   |
| Indoor Air flow   | Cooling            | m³/min (ft³/min)                               | 35/29/25 (1236/1024/883) |          |                                       | -              |            |        | -     | -      |   |
|   | Heating            | m³/min (ft³/min)                               | 35/29/25 (1236/1024/883) |          |                                       | -              |            |        | -     | -      |   |
| Outdoor Air flow  | Cooling            | m³/min (ft³/min)                               | -                        |          |                                       | 135            | (4767)     | -      | -     |        |   |
|   | Heating            | m³/min (ft³/min)                               | -                        |          |                                       | 120            | (4238)     | -      | -     |        |   |
| Refrigerant type / amount g(oz)                                       |                    | -  |                          | R410A    |                                       | 3.40k          | (119.9)    | -      |       |        |   |
| Product dimension   | Height             | mm(inch)                                       | 235 (9-1/4)              |          |                                       | 1416 (55-3/4)  |            |        | -     |        |   |
|   | Width              | mm(inch)                                       | 1590 (62-19/32)          |          |                                       | 940 (37-1/32)  |            |        | -     |        |   |
|   | Depth              | mm(inch)                                       | 690 (27-5/32)            |          |                                       | 340 (13-13/32) |            |        | -     |        |   |
| Packing dimension   | Height             | mm(inch)                                       | 360                      |          |                                       | 1556           |            |        | -     |        |   |
|   | Width              | mm(inch)                                       | 1655                     |          |                                       | 1055           |            |        | -     |        |   |
|   | Depth              | mm(inch)                                       | 820                      |          |                                       | 485            |            |        | -     |        |   |
| Weight  | (NET)              | kg(lb)   | 40 (88)                  |          |                                       | 98 (216)       |            |        | -     |        |   |
|   | (GROSS)            | kg(lb)   | 49 (108)                 |          |                                       | 108 (238)      |            |        | -     |        |   |
| Layers limit (actually)   |                    | 9 (10)   |                          | 1 (2)    |                                       | -              |            | -      |       |        |   |
| Operation condition   |                    | Cool (DBT)                                     | 18°C ~ 32°C              |          |                                       | -15°C ~ 46°C   |            |        | -     |        |   |
|   |                    | Heat (DBT)                                     | 16°C ~ 30°C              |          |                                       | -20°C ~ 24°C   |            |        | -     |        |   |
| Pipe diameter mm (inch)   |                    | (Liquid)ø9.52(3/8) (Gas)ø15.88(5/8)            |                          |          | (Liquid)ø9.52(3/8) (Gas)ø15.88(5/8)   |                |            | -      |       |        |   |
| Connecting method, Standard length m(ft)                              |                    | flared type, 5.0(16.4)                         |                          |          | flared type, 5.0(16.4)                |                |            | -      |       |        |   |
| Pipe length range m (ft)  |                    | 5 ~ 75 (16.4 ~ 246.1)                          |                          |          | -                                     |                |            | -      |       |        |   |
| Indoor unit & Outdoor unit height difference m (ft)                   |                    | 15 (OD located lower) / 30 (OD located higher) |                          |          | (49.2/98.4)                           |                |            | -      |       |        |   |
| Add gas amount g/m (oz/ft)  |                    | 50 (0.538)                                     |                          |          | -                                     |                |            | -      |       |        |   |
| Pipe length for additional gas m (ft)                                 |                    | 30 (98.4)                                      |                          |          | -                                     |                |            | -      |       |        |   |

\*1: In case it is necessary to indicate the air flow volume in (l/s), the value in (m³/min.) shall be multiplied by 16.7 and rounded down the decimal point.

\*2: If the EUROVENT Certified models can be operated under the "extra-low" temperature condition, -7°C dry bulb and -8°C wet-bulb temperatures with rated voltage 230 V shall be used.

\*3: Network Impedance shall be applicable for EUROPE and CHINA models.

\*4: The annual consumption is calculated by multiplying the input power at 230 V (400 V) by an average of 500 hours per year in cooling mode.

\*5: EER and COP classification is at 230 V (400 V) only in accordance with EU directive 2002/31/EC.

\*6: SEER and SCOP classification is at 230V(400V) only in accordance with EN-14825. For heating, SCOP indicates the value of only Average heating season.

# Simultaneous (Twin) -Type

## 1-1. Unit Specifications

**PE1**

### 2. Ceiling Type S-36PT2E5A×2 / U-71PE1E8A

| INDOOR  |   | MODEL  | S-36PT2E5A×2                     |             |                                     | -              |           |          | -    |        |      |
|---|---|--|----------------------------------|-------------|-------------------------------------|----------------|-----------|----------|------|--------|------|
| PANEL   |   | MODEL  | -                                |             |                                     | -              |           |          | -    |        |      |
| OUTDOOR   |   | MODEL  | -                                |             |                                     | U-71PE1E8A     |           |          | -    |        |      |
| Branch pipe   |   | MODEL  | -                                |             |                                     | CZ-P155BK1     |           |          | -    |        |      |
| Performance test condition                          |   | ISO5151 / EN14511 / EN14825 / EN12102          |                                  |             |                                     |                |           |          |      |        |      |
| Power supply  |   | Ø, Hz  | 1ø 50Hz                          |             |                                     | 3ø 50Hz        |           |          |      |        |      |
|   |   | V  | 220                              | 230         | 240                                 | 380            | 400       | 415      | Min  | Max    |      |
| C<br>O<br>O<br>L<br>I<br>N<br>G                     | Capacity                                  | kW   | 7.1                              | 7.1         | 7.1                                 | -              | -         | -        | 2.5  | 8.0    |      |
|   |   | BTU/h  | 24200                            | 24200       | 24200                               | -              | -         | -        | 8500 | 27300  |      |
|   | Current                                   | A  | 0.37×2                           | 0.36×2      | 0.35×2                              | 3.00           | 2.90      | 2.80     | -    | -      |      |
|   |   | W  | 35×2                             | 35×2        | 35×2                                | 1.875k         | 1.875k    | 1.875k   | -    | -      |      |
|   | Input power                               | TOTAL W  | -                                |             |                                     | 1.945k         | 1.945k    | 1.945k   | 450  | 2.780k |      |
|   |   | Annual consumption                             | TOTAL kWh *4                     | -           |                                     |                | -         | 973      | -    | -      | -    |
|   | EER/EER CLASS                             | TOTAL (W/W) <sup>5</sup> ("A"-G)               | -                                | -           | -                                   | 3.65           | 3.65 / A  | 3.65     | 5.56 | 2.88   |      |
|   | Erp<br>*6                                 | Pdesign  | kW                               | -           | -                                   | -              | -         | 7.1      | -    | -      | -    |
|   |   | SEER   | (W/W)                            | -           | -                                   | -              | -         | 5.9      | -    | -      | -    |
|   |   | Annual consumption                             | kWh                              | -           | -                                   | -              | -         | 421      | -    | -      | -    |
| Class   |   |  | -                                | -           | -                                   | -              | A+        | -        | -    | -      |      |
| Power factor  | %   | -  | -                                | -           | 95                                  | 93             | 93        | -        | -    |        |      |
| Noise indoor  | dB-A (H/M/L)                              | 36/32/29                                       |                                  |             | -                                   | -              | -         | -        | -    |        |      |
|   | Power Level dB                            | 54/50/47                                       |                                  |             | -                                   | -              | -         | -        | -    |        |      |
| Noise outdoor                                       | dB-A (H/L)                                | -  |                                  |             | 48/-                                |                |           | -        | -    |        |      |
|   | Power Level dB                            | -  |                                  |             | 65/-                                |                |           | -        | -    |        |      |
| H<br>E<br>A<br>T<br>I<br>N<br>G                     | Capacity                                  | kW   | 8.0                              | 8.0         | 8.0                                 | -              | -         | -        | 2.0  | 9.0    |      |
|   |   | BTU/h  | 27300                            | 27300       | 27300                               | -              | -         | -        | 6800 | 30700  |      |
|   | Current                                   | A  | 0.37×2                           | 0.36×2      | 0.35×2                              | 3.00           | 2.90      | 2.80     | -    | -      |      |
|   |   | W  | 35×2                             | 35×2        | 35×2                                | 1.875k         | 1.875k    | 1.875k   | -    | -      |      |
|   | Input power                               | TOTAL W  | -                                |             |                                     | 1.945k         | 1.945k    | 1.945k   | 400  | 2.900k |      |
|   |   | COP/COP CLASS                                  | TOTAL (W/W) <sup>5</sup> ("A"-G) | -           | -                                   | -              | 4.11      | 4.11 / A | 4.11 | 5.00   | 3.10 |
|   | Erp<br>*6                                 | Pdesign at -10°C                               | kW                               | -           | -                                   | -              | -         | 7.1      | -    | -      | -    |
|   |   | Tbivalent                                      | °C                               | -           | -                                   | -              | -         | -9       | -    | -      | -    |
|   |   | SCOP   | (W/W)                            | -           | -                                   | -              | -         | 4.0      | -    | -      | -    |
|   |   | Annual consumption                             | kWh                              | -           | -                                   | -              | -         | 2485     | -    | -      | -    |
| Class   |   | -  | -                                | -           | -                                   | A+             | -         | -        | -    |        |      |
| Power factor  | %   | -  | -                                | -           | 95                                  | 93             | 93        | -        | -    |        |      |
| Noise indoor  | dB-A (H/M/L)                              | 36/32/29                                       |                                  |             | -                                   | -              | -         | -        | -    |        |      |
|   | Power Level dB                            | 54/50/47                                       |                                  |             | -                                   | -              | -         | -        | -    |        |      |
| Noise outdoor                                       | dB-A (H/L)                                | -  |                                  |             | 50/-                                |                |           | -        | -    |        |      |
|   | Power Level dB                            | -  |                                  |             | 67/-                                |                |           | -        | -    |        |      |
| EXTRA LOW TEMP                                      | Total capacity(kW) / Input power(W) / COP |  | -                                |             |                                     |                |           |          |      |        |      |
| Max Current(A) / Max Input power(W)                 |   | 0.37×2/35×2                                    | 0.36×2/35×2                      | 0.35×2/35×2 | 7.0/4.15k                           | 7.0/4.36k      | 7.0/4.53k | -        |      |        |      |
| Starting current(A) / Comp output(W)                |   | -  | -                                | -           | 3.00/3.0k                           | 2.90/3.0k      | 2.80/3.0k | -        |      |        |      |
| Network Impedance(ΩMAX.)                            |   | -  |                                  |             |                                     |                |           |          |      |        |      |
| Fan motor output (Indoor/Outdoor) W                 |   | 43   |                                  |             | 90                                  |                |           | -        |      |        |      |
| Moisture removal volume                             |   | L/h(Pt/h)                                      | 4.2                              | (2.1×2)     | (8.8)                               | -              |           |          | -    |        |      |
| External static pressure                            |   | Pa   | -                                |             |                                     | -              |           |          | -    |        |      |
| Indoor Air flow                                     | Cooling                                   | m³/min (ft³/min)                               | [14/12/10.5 (494/424/371)]×2     |             |                                     | -              |           |          | -    |        |      |
|   | Heating                                   | m³/min (ft³/min)                               | [14/12/10.5 (494/424/371)]×2     |             |                                     | -              |           |          | -    |        |      |
| Outdoor Air flow                                    | Cooling                                   | m³/min (ft³/min)                               | -                                |             |                                     | 60             | (2119)    | -        |      |        |      |
|   | Heating                                   | m³/min (ft³/min)                               | -                                |             |                                     | 60             | (2119)    | -        |      |        |      |
| Refrigerant type / amount g(oz)                     |   | -  |                                  |             | R410A                               | 2.35k          | (82.9)    | -        |      |        |      |
| Product dimension                                   | Height                                    | mm(inch)                                       | 235 (9-1/4)                      |             |                                     | 996 (39-7/32)  |           |          | -    |        |      |
|   | Width                                     | mm(inch)                                       | 960 (37-25/32)                   |             |                                     | 940 (37-1/32)  |           |          | -    |        |      |
|   | Depth                                     | mm(inch)                                       | 690 (27-5/32)                    |             |                                     | 340 (13-13/32) |           |          | -    |        |      |
| Packing dimension                                   | Height                                    | mm(inch)                                       | 360                              |             |                                     | 1136           |           |          | -    |        |      |
|   | Width                                     | mm(inch)                                       | 1025                             |             |                                     | 1055           |           |          | -    |        |      |
|   | Depth                                     | mm(inch)                                       | 820                              |             |                                     | 485            |           |          | -    |        |      |
| Weight  | (NET)                                     | kg(lb)   | 27 (60)                          |             |                                     | 71 (157)       |           |          | -    |        |      |
|   | (GROSS)                                   | kg(lb)   | 34 (75)                          |             |                                     | 79 (174)       |           |          | -    |        |      |
| Layers limit (actually)                             |   | 9 (10)   |                                  |             | 2 (3)                               |                |           | -        |      |        |      |
| Operation condition                                 | Cool (DBT)                                | 18°C ~ 32°C                                    |                                  |             | -15°C ~ 46°C                        |                |           | -        |      |        |      |
|   | Heat (DBT)                                | 16°C ~ 30°C                                    |                                  |             | -20°C ~ 24°C                        |                |           | -        |      |        |      |
| P<br>I<br>P<br>I<br>N<br>G                          | Pipe diameter mm (inch)                   | (Liquid)ø6.35(1/4) (Gas)ø12.7(1/2)             |                                  |             | (Liquid)ø9.52(3/8) (Gas)ø15.88(5/8) |                |           | -        |      |        |      |
|   | Connecting method, Standard length m(ft)  | flared type, 5.0(16.4)                         |                                  |             | flared type, 5.0(16.4)              |                |           | -        |      |        |      |
| Pipe length range                                   |   | m (ft)   |                                  |             | 5 ~ 50 (16.4 ~ 164)                 |                |           | -        |      |        |      |
| Indoor unit & Outdoor unit height difference m (ft) |   | 15 (OD located lower) / 30 (OD located higher) |                                  |             | (49.2/98.4)                         |                |           | -        |      |        |      |
| Add gas amount g/m (oz/ft)                          |   | 50   |                                  |             | (0.538)                             |                |           | -        |      |        |      |
| Pipe length for additional gas                      |   | m (ft)   |                                  |             | 30 (98.4)                           |                |           | -        |      |        |      |

\*1: In case it is necessary to indicate the air flow volume in (l/s), the value in (m³/min.) shall be multiplied by 16.7 and rounded down the decimal point.

\*2: If the EUROVENT Certified models can be operated under the "extra-low" temperature condition, -7°C dry bulb and -8°C wet-bulb temperatures with rated voltage 230 V shall be used.

\*3: Network Impedance shall be applicable for EUROPE and CHINA models.

\*4: The annual consumption is calculated by multiplying the input power at 230 V (400 V) by an average of 500 hours per year in cooling mode.

\*5: EER and COP classification is at 230 V (400 V) only in accordance with EU directive 2002/31/EC.

\*6: SEER and SCOP classification is at 230V(400V) only in accordance with EN-14825. For heating, SCOP indicates the value of only Average heating season, Other fiche data indicates in an attached sheet.

# Simultaneous (Triple) -Type

## 1-1. Unit Specifications

**PE1**

### 2. Ceiling Type S-36PT2E5A×3 / U-100PE1E8A

| INDOOR                               |   | MODEL                                     | S-36PT2E5A×3                                   |             |             | -                                   |           |           | -     |        |   |
|--------------------------------------|---|---|--|-------------|-------------|-------------------------------------|-----------|-----------|-------|--------|---|
| PANEL                                |   | MODEL                                     | -  |             |             | -                                   |           |           | -     |        |   |
| OUTDOOR                              |   | MODEL                                     | -  |             |             | U-100PE1E8A                         |           |           | -     |        |   |
| Branch pipe                          |   | MODEL                                     | -  |             |             | CZ-P3HPC2                           |           |           | -     |        |   |
| Performance test condition           |   | ISO5151 / EN14511 / EN14825 / EN12102     |  |             |             |                                     |           |           |       |        |   |
| Power supply                         |   | Ø, Hz                                     | 1ø 50Hz  |             |             | 3ø 50Hz                             |           |           | Min   | Max    |   |
|                                      |   | V   | 220  | 230         | 240         | 380                                 | 400       | 415       |       |        |   |
| Capacity                             |   | kW  | 10.0   | 10.0        | 10.0        | -                                   | -         | -         | 3.3   | 12.5   |   |
|                                      |   | BTU/h                                     | 34100  | 34100       | 34100       | -                                   | -         | -         | 11300 | 42700  |   |
| Current                              |   | A   | 0.37×3   | 0.36×3      | 0.35×3      | 3.95                                | 3.75      | 3.65      | -     | -      |   |
| Input power                          |   | W   | 35×3   | 35×3        | 35×3        | 2.450k                              | 2.450k    | 2.450k    | -     | -      |   |
|                                      |   | TOTAL W                                   | -  |             |             | 2.555k                              | 2.555k    | 2.555k    | 840   | 3.850k |   |
| Annual consumption                   |   | TOTAL kWh *4                              | -  |             |             | -                                   | 1278      | -         | -     | -      |   |
| EER/EER CLASS                        |   | TOTAL (W/W) <sup>5</sup> ("A"~"G")        | -  | -           | -           | 3.91                                | 3.91 / A  | 3.91      | 3.93  | 3.25   |   |
| COOLING                              | Erp *6  | Pdesign                                   | kW   | -           | -           | -                                   | 10.0      | -         | -     | -      |   |
|                                      |   | SEER                                      | (W/W)  | -           | -           | -                                   | 6.4       | -         | -     | -      |   |
|                                      |   | Annual consumption                        | kWh  | -           | -           | -                                   | -         | 547       | -     | -      | - |
|                                      |   | Class                                     |  | -           | -           | -                                   | -         | A++       | -     | -      | - |
| Power factor                         |   | %   | -  | -           | -           | 94                                  | 94        | 93        | -     | -      |   |
| Noise indoor                         |   | dB-A (H/M/L)                              | 36/32/29                                       |             |             | -                                   | -         | -         | -     | -      |   |
|                                      |   | Power Level dB                            | 54/50/47                                       |             |             | -                                   | -         | -         | -     | -      |   |
| Noise outdoor                        |   | dB-A (H/L)                                | -  |             |             | 52/-                                |           |           | -     | -      |   |
|                                      |   | Power Level dB                            | -  |             |             | 69/-                                |           |           | -     | -      |   |
| Capacity                             |   | kW  | 11.2   | 11.2        | 11.2        | -                                   | -         | -         | 4.1   | 14.0   |   |
|                                      |   | BTU/h                                     | 38200  | 38200       | 38200       | -                                   | -         | -         | 14000 | 47800  |   |
| Current                              |   | A   | 0.37×3   | 0.36×3      | 0.35×3      | 4.05                                | 3.85      | 3.75      | -     | -      |   |
| Input power                          |   | W   | 35×3   | 35×3        | 35×3        | 2.520k                              | 2.520k    | 2.520k    | -     | -      |   |
|                                      |   | TOTAL W                                   | -  |             |             | 2.625k                              | 2.625k    | 2.625k    | 900   | 4.400k |   |
| COP/COP CLASS                        |   | TOTAL (W/W) <sup>5</sup> ("A"~"G")        | -  | -           | -           | 4.27                                | 4.27 / A  | 4.27      | 4.56  | 3.18   |   |
| HEATING                              | Erp *6  | Pdesign at -10°C                          | kW   | -           | -           | -                                   | 10.0      | -         | -     | -      |   |
|                                      |   | Tbivalent                                 | °C   | -           | -           | -                                   | -10       | -         | -     | -      |   |
|                                      |   | SCOP                                      | (W/W)  | -           | -           | -                                   | -         | 4.3       | -     | -      | - |
|                                      |   | Annual consumption                        | kWh  | -           | -           | -                                   | -         | 3256      | -     | -      | - |
| Power factor                         |   | %   | -  | -           | -           | 95                                  | 94        | 93        | -     | -      |   |
| Noise indoor                         |   | dB-A (H/M/L)                              | 36/32/29                                       |             |             | -                                   | -         | -         | -     | -      |   |
|                                      |   | Power Level dB                            | 54/50/47                                       |             |             | -                                   | -         | -         | -     | -      |   |
| Noise outdoor                        |   | dB-A (H/L)                                | -  |             |             | 52/-                                |           |           | -     | -      |   |
|                                      |   | Power Level dB                            | -  |             |             | 69/-                                |           |           | -     | -      |   |
| EXTRA LOW TEMP                       |   | Total capacity(kW) / Input power(W) / COP | -  |             |             | -                                   |           |           | -     | -      |   |
| Max Current(A) / Max Input power(W)  |   |   | 0.37×3/35×3                                    | 0.36×3/35×3 | 0.35×3/35×3 | 9.0/5.63k                           | 9.0/5.86k | 9.0/6.02k | -     | -      |   |
| Starting current(A) / Comp output(W) |   |   | -  | -           | -           | 4.05/3.0k                           | 3.85/3.0k | 3.75/3.0k | -     | -      |   |
| Network Impedance(ΩMAX.)             |   |   | -  |             |             | -                                   |           |           | -     | -      |   |
| Fan motor output (Indoor/Outdoor) W  |   |   | 43   |             |             | 90×2                                |           |           | -     | -      |   |
| Moisture removal volume              |   | L/h(Pt/h)                                 | 6.0  | (2.0×3)     | (12.6)      | -                                   |           |           | -     | -      |   |
| External static pressure             |   | Pa  | -  |             |             | -                                   |           |           | -     | -      |   |
| Indoor Air flow                      | Cooling   | m³/min (ft³/min)                          | [14/12/10.5 (494/424/371)]×3                   |             |             | -                                   |           |           | -     | -      |   |
|                                      | Heating   | m³/min (ft³/min)                          | [14/12/10.5 (494/424/371)]×3                   |             |             | -                                   |           |           | -     | -      |   |
| Outdoor Air flow                     | Cooling   | m³/min (ft³/min)                          | -  |             |             | 110                                 | (3885)    | -         | -     |        |   |
|                                      | Heating   | m³/min (ft³/min)                          | -  |             |             | 95                                  | (3355)    | -         | -     |        |   |
| Refrigerant type / amount g(oz)      |   |   | -  |             |             | R410A                               | 3.40k     | (119.9)   | -     | -      |   |
| Product dimension                    |   | Height mm(inch)                           | 235 (9-1/4)                                    |             |             | 1416 (55-3/4)                       |           |           | -     | -      |   |
|                                      |   | Width mm(inch)                            | 960 (37-25/32)                                 |             |             | 940 (37-1/32)                       |           |           | -     | -      |   |
|                                      |   | Depth mm(inch)                            | 690 (27-5/32)                                  |             |             | 340 (13-13/32)                      |           |           | -     | -      |   |
| Packing dimension                    |   | Height mm(inch)                           | 360  |             |             | 1556                                |           |           | -     | -      |   |
|                                      |   | Width mm(inch)                            | 1025   |             |             | 1055                                |           |           | -     | -      |   |
|                                      |   | Depth mm(inch)                            | 820  |             |             | 485                                 |           |           | -     | -      |   |
| Weight                               |   | (NET) kg(lb)                              | 27 (60)  |             |             | 98 (216)                            |           |           | -     | -      |   |
|                                      |   | (GROSS) kg(lb)                            | 34 (75)  |             |             | 108 (238)                           |           |           | -     | -      |   |
| Layers limit (actually)              |   |   | 9 (10)   |             |             | 1 (2)                               |           |           | -     | -      |   |
| Operation condition                  |   | Cool (DBT)                                | 18°C ~ 32°C                                    |             |             | -15°C ~ 46°C                        |           |           | -     | -      |   |
|                                      |   | Heat (DBT)                                | 16°C ~ 30°C                                    |             |             | -20°C ~ 24°C                        |           |           | -     | -      |   |
| PIPE                                 | Pipe diameter mm (inch)                             |   | (Liquid)ø6.35(1/4) (Gas)ø12.7(1/2)             |             |             | (Liquid)ø9.52(3/8) (Gas)ø15.88(5/8) |           |           | -     | -      |   |
|                                      | Connecting method, Standard length m(ft)            |   | flared type, 5.0(16.4)                         |             |             | flared type, 5.0(16.4)              |           |           | -     | -      |   |
| INSTALLATION                         | Pipe length range m (ft)                            |   | 5 ~ 75 (16.4 ~ 246.1)                          |             |             | -                                   |           |           | -     | -      |   |
|                                      | Indoor unit & Outdoor unit height difference m (ft) |   | 15 (OD located lower) / 30 (OD located higher) |             |             | (49.2/98.4)                         |           |           | -     | -      |   |
| G                                    | Add gas amount g/m (oz/ft)                          |   | 50 (0.538)                                     |             |             | -                                   |           |           | -     | -      |   |
|                                      | Pipe length for additional gas m (ft)               |   | 20 (65.6)                                      |             |             | -                                   |           |           | -     | -      |   |

\*1: In case it is necessary to indicate the air flow volume in (l/s), the value in (m³/min.) shall be multiplied by 16.7 and rounded down the decimal point.

\*2: If the EUROVENT Certified models can be operated under the "extra-low" temperature condition, -7°C dry bulb and -8°C wet-bulb temperatures with rated voltage 230 V shall be used.

\*3: Network Impedance shall be applicable for EUROPE and CHINA models.

\*4: The annual consumption is calculated by multiplying the input power at 230 V (400 V) by an average of 500 hours per year in cooling mode.

\*5: EER and COP classification is at 230 V (400 V) only in accordance with EU directive 2002/31/EC.

\*6: SEER and SCOP classification is at 230V(400V) only in accordance with EN-14825. For heating, SCOP indicates the value of only Average heating season, Other fiche data indicates in an attached sheet.

# Simultaneous (Double-Twin) -Type

## 1-1. Unit Specifications

**PE1**

### 2. Ceiling Type S-36PT2E5A×4 / U-125PE1E8A

| INDOOR   |  | MODEL                                 | S-36PT2E5A×4                                   |             |            | -                                   |            |          | -     |        |      |
|--|--|---------------------------------------|--|-------------|------------|-------------------------------------|------------|----------|-------|--------|------|
| PANEL  |  | MODEL                                 | -  |             |            | -                                   |            |          | -     |        |      |
| OUTDOOR  |  | MODEL                                 | -  |             |            | U-125PE1E8A                         |            |          | -     |        |      |
| Branch pipe  |  | MODEL                                 | -  |             |            | CZ-P155BK1×3                        |            |          | -     |        |      |
| Performance test condition   |  | ISO5151 / EN14511 / EN12102 / EN14825 |  |             |            |                                     |            |          |       |        |      |
| Power supply   |  | Ø, Hz                                 | 1ø 50Hz  |             |            | 3ø 50Hz                             |            |          |       |        |      |
|  |  | V                                     | 220  | 230         | 240        | 380                                 | 400        | 415      | Min   | Max    |      |
| C<br>O<br>O<br>L<br>I<br>N<br>G  | Capacity                                 | kW                                    | 12.5   | 12.5        | 12.5       | -                                   | -          | -        | 3.3   | 14.0   |      |
|  |  | BTU/h                                 | 42700  | 42700       | 42700      | -                                   | -          | -        | 11300 | 47800  |      |
|  | Current                                  | A                                     | 0.37×4   | 0.36×4      | 0.35×4     | 5.85                                | 5.55       | 5.35     | -     | -      |      |
|  |  | W                                     | 35×4   | 35×4        | 35×4       | 3.620k                              | 3.620k     | 3.620k   | -     | -      |      |
|  | Input power                              | TOTAL W                               | -  |             |            | 3.760k                              | 3.760k     | 3.760k   | 840   | 4.860k |      |
|  |  | Annual consumption                    | TOTAL kWh *4                                   | -           |            |                                     | -          | 1880     | -     | -      | -    |
|  | EER/EER CLASS                            | TOTAL (W/W) <sup>5/</sup> ("A"~"G")   | -  | -           | -          | 3.32                                | 3.32 / A   | 3.32     | 3.93  | 2.88   |      |
|  | E <sub>rg</sub>                          | Pdesign                               | kW   | -           | -          | -                                   | -          | 12.5     | -     | -      | -    |
|  |  | η <sub>s,c</sub>                      | %  | -           | -          | -                                   | -          | 240.2    | -     | -      | -    |
|  |  | Annual consumption                    | kWh  | -           | -          | -                                   | -          | -        | -     | -      | -    |
| Class  |  |                                       | -  | -           | -          | -                                   | -          | -        | -     | -      |      |
| Power factor   | %  | -                                     | -  | -           | 94         | 94                                  | 94         | -        | -     |        |      |
| Noise indoor   | dB-A (H/M/L)                             | 36/32/29                              |  |             | -          | -                                   | -          | -        | -     |        |      |
|  | Power Level dB                           | 54/50/47                              |  |             | -          | -                                   | -          | -        | -     |        |      |
| Noise outdoor  | dB-A (H/L)                               | -                                     |  |             | 53/-       |                                     |            | -        | -     |        |      |
|  | Power Level dB                           | -                                     |  |             | 70/-       |                                     |            | -        | -     |        |      |
| H<br>E<br>A<br>T<br>I<br>N<br>G  | Capacity                                 | kW                                    | 14.0   | 14.0        | 14.0       | -                                   | -          | -        | 4.1   | 16.0   |      |
|  |  | BTU/h                                 | 47800  | 47800       | 47800      | -                                   | -          | -        | 14000 | 54600  |      |
|  | Current                                  | A                                     | 0.37×4   | 0.36×4      | 0.35×4     | 5.50                                | 5.20       | 5.05     | -     | -      |      |
|  |  | W                                     | 35×4   | 35×4        | 35×4       | 3.400k                              | 3.400k     | 3.400k   | -     | -      |      |
|  | Input power                              | TOTAL W                               | -  |             |            | 3.540k                              | 3.540k     | 3.540k   | 900   | 5.210k |      |
|  |  | COP/COP CLASS                         | TOTAL (W/W) <sup>5/</sup> ("A"~"G")            | -           | -          | -                                   | 3.95       | 3.95 / A | 3.95  | 4.56   | 3.07 |
|  | E <sub>rh</sub>                          | Pdesign at -10°C                      | kW   | -           | -          | -                                   | -          | 12.5     | -     | -      | -    |
|  |  | Tbivalent                             | °C   | -           | -          | -                                   | -          | -10      | -     | -      | -    |
|  |  | η <sub>s,h</sub>                      | %  | -           | -          | -                                   | -          | 150.1    | -     | -      | -    |
|  |  | Annual consumption                    | kWh  | -           | -          | -                                   | -          | -        | -     | -      | -    |
| Class  |  | -                                     | -  | -           | -          | -                                   | -          | -        | -     |        |      |
| Power factor   | %  | -                                     | -  | -           | 94         | 94                                  | 94         | -        | -     |        |      |
| Noise indoor   | dB-A (H/M/L)                             | 36/32/29                              |  |             | -          | -                                   | -          | -        | -     |        |      |
|  | Power Level dB                           | 54/50/47                              |  |             | -          | -                                   | -          | -        | -     |        |      |
| Noise outdoor  | dB-A (H/L)                               | -                                     |  |             | 53/-       |                                     |            | -        | -     |        |      |
|  | Power Level dB                           | -                                     |  |             | 70/-       |                                     |            | -        | -     |        |      |
| EXTRA LOW TEMP <sup>6/</sup> Total capacity(kW) / Input power(W) / COP |  | -                                     |  |             |            |                                     |            |          |       |        |      |
| Max Current(A) / Max Input power(W)                                    |  | 0.37×4/35×4                           | 0.36×4/35×4                                    | 0.35×4/35×4 | 10.0/6.19k | 10.0/6.51k                          | 10.0/6.75k | -        |       |        |      |
| Starting current(A) / Comp output(W)                                   |  | -                                     | -  | -           | 5.85/3.0k  | 5.55/3.0k                           | 5.35/3.0k  | -        |       |        |      |
| Network Impedance(ΩMAX.)   |  | -                                     |  |             |            |                                     |            |          |       |        |      |
| Fan motor output (Indoor/Outdoor) W                                    |  | 43                                    |  |             | 90×2       |                                     |            | -        |       |        |      |
| Moisture removal volume  |  | L/h(Pt/h)                             | 7.9  | (1.975×4)   | (16.6)     | -                                   |            |          | -     |        |      |
| External static pressure   |  | Pa                                    | -  |             |            | -                                   |            |          | -     |        |      |
| Indoor Air flow  | Cooling                                  | m³/min (ft³/min)                      | [14/12/10.5 (494/424/371)]×4                   |             |            | -                                   |            |          | -     | -      |      |
|  | Heating                                  | m³/min (ft³/min)                      | [14/12/10.5 (494/424/371)]×4                   |             |            | -                                   |            |          | -     | -      |      |
| Outdoor Air flow   | Cooling                                  | m³/min (ft³/min)                      | -  |             |            | 130                                 | (4591)     | -        |       |        |      |
|  | Heating                                  | m³/min (ft³/min)                      | -  |             |            | 110                                 | (3885)     | -        |       |        |      |
| Refrigerant type / amount g(oz)  |  | -                                     |  |             | R410A      | 3.40k                               | (119.9)    | -        |       |        |      |
| Product dimension  | Height                                   | mm(inch)                              | 235 (9-1/4)                                    |             |            | 1416 (55-3/4)                       |            |          | -     |        |      |
|  | Width                                    | mm(inch)                              | 960 (37-25/32)                                 |             |            | 940 (37-1/32)                       |            |          | -     |        |      |
|  | Depth                                    | mm(inch)                              | 690 (27-5/32)                                  |             |            | 340 (13-13/32)                      |            |          | -     |        |      |
| Packing dimension  | Height                                   | mm(inch)                              | 360  |             |            | 1556                                |            |          | -     |        |      |
|  | Width                                    | mm(inch)                              | 1025   |             |            | 1055                                |            |          | -     |        |      |
|  | Depth                                    | mm(inch)                              | 820  |             |            | 485                                 |            |          | -     |        |      |
| Weight   | (NET)                                    | kg(lb)                                | 27 (60)  |             |            | 98 (216)                            |            |          | -     |        |      |
|  | (GROSS)                                  | kg(lb)                                | 34 (75)  |             |            | 108 (238)                           |            |          | -     |        |      |
| Layers limit (actually)  |  |                                       | 9 (10)   |             |            | 1 (2)                               |            |          | -     |        |      |
| Operation condition  | Cool (DBT)                               |                                       | 18°C ~ 32°C                                    |             |            | -15°C ~ 46°C                        |            |          | -     |        |      |
|  | Heat (DBT)                               |                                       | 16°C ~ 30°C                                    |             |            | -20°C ~ 24°C                        |            |          | -     |        |      |
| P<br>I<br>P<br>I<br>N<br>G   | Pipe diameter mm (inch)                  |                                       | (Liquid)ø6.35(1/4) (Gas)ø12.7(1/2)             |             |            | (Liquid)ø9.52(3/8) (Gas)ø15.88(5/8) |            |          | -     |        |      |
|  | Connecting method, Standard length m(ft) |                                       | flared type, 5.0(16.4)                         |             |            | flared type, 5.0(16.4)              |            |          | -     |        |      |
| Pipe length range  |  | m (ft)                                | 5 ~ 75 (16.4 ~ 246.1)                          |             |            | -                                   |            |          | -     |        |      |
| Indoor unit & Outdoor unit height difference m (ft)                    |  |                                       | 15 (OD located lower) / 30 (OD located higher) |             |            | (49.2/98.4)                         |            |          | -     |        |      |
| Add gas amount g/m (oz/ft)   |  |                                       | 50 (0.538)                                     |             |            | -                                   |            |          | -     |        |      |
| Pipe length for additional gas   |  | m (ft)                                | 20 (65.6)                                      |             |            | -                                   |            |          | -     |        |      |

\*1: In case it is necessary to indicate the air flow volume in (l/s), the value in (m³/min.) shall be multiplied by 16.7 and rounded down the decimal point.

\*2: If the EUROVENT Certified models can be operated under the "extra-low" temperature condition, -7°C dry bulb and -8°C wet-bulb temperatures with rated voltage 230 V shall be used.

\*3: Network Impedance shall be applicable for EUROPE and CHINA models.

\*4: The annual consumption is calculated by multiplying the input power at 230 V (400 V) by an average of 500 hours per year in cooling mode.

\*5: EER and COP classification is at 230 V (400 V) only in accordance with EU directive 2002/31/EC.

\*6: SEER and SCOP classification is at 230V(400V) only in accordance with EN-14825. For heating, SCOP indicates the value of only Average heating season.

# Simultaneous (Triple) -Type

## 1-1. Unit Specifications

PE1

### 2. Ceiling Type S-45PT2E5A×3 / U-125PE1E8A

|   |  |  |                                    |             |                                     |                |            |          |       |        |      |
|---|--|--|------------------------------------|-------------|-------------------------------------|----------------|------------|----------|-------|--------|------|
| INDOOR  | MODEL                                    | S-45PT2E5A×3                                   |                                    |             | -                                   |                |            | -        |       |        |      |
| PANEL   | MODEL                                    | -  |                                    |             | -                                   |                |            | -        |       |        |      |
| OUTDOOR   | MODEL                                    | -  |                                    |             | U-125PE1E8A                         |                |            | -        |       |        |      |
| Branch pipe   | MODEL                                    | -  |                                    |             | CZ-P3HPC2                           |                |            | -        |       |        |      |
| Performance test condition  |  | ISO5151 / EN14511 / EN12102 / EN14825          |                                    |             |                                     |                |            |          |       |        |      |
| Power supply  |  | ∅, Hz  | 1∅ 50Hz                            |             |                                     | 3∅ 50Hz        |            |          |       |        |      |
|   |  | V  | 220                                | 230         | 240                                 | 380            | 400        | 415      | Min   | Max    |      |
| C<br>O<br>O<br>L<br>I<br>N<br>G                                       | Capacity                                 | kW   | 12.5                               | 12.5        | 12.5                                | -              | -          | -        | 3.3   | 14.0   |      |
|   |  | BTU/h  | 42700                              | 42700       | 42700                               | -              | -          | -        | 11300 | 47800  |      |
|   | Current                                  | A  | 0.39×3                             | 0.38×3      | 0.37×3                              | 5.85           | 5.55       | 5.53     | -     | -      |      |
|   |  | W  | 40×3                               | 40×3        | 40×3                                | 3.620k         | 3.620k     | 3.620k   | -     | -      |      |
|   | Input power                              | TOTAL W  | -                                  |             |                                     | 3.740k         | 3.740k     | 3.740k   | 840   | 4.860k |      |
|   |  | Annual consumption                             | TOTAL kWh *4                       | -           |                                     |                | -          | 1870     | -     | -      | -    |
|   | EER/EER CLASS                            | TOTAL (W/W) <sup>5</sup> ("A"~"G")             | -                                  | -           | -                                   | 3.34           | 3.34 / A   | 3.34     | 3.93  | 2.88   |      |
|   | E<br>r<br>p<br>*6                        | Pdesign  | kW                                 | -           | -                                   | -              | -          | 12.5     | -     | -      | -    |
|   |  | η <sub>s.c</sub>                               | %                                  | -           | -                                   | -              | -          | 240.2    | -     | -      | -    |
|   |  | Annual consumption                             | kWh                                | -           | -                                   | -              | -          | -        | -     | -      | -    |
| Class   |  |  | -                                  | -           | -                                   | -              | -          | -        | -     | -      |      |
| Power factor  | %  | -  | -                                  | -           | 94                                  | 94             | 94         | -        | -     |        |      |
| Noise indoor  | dB-A (H/M/L)                             | 37/33/29                                       |                                    |             | -                                   | -              | -          | -        | -     |        |      |
|   | Power Level dB                           | 55/51/47                                       |                                    |             | -                                   | -              | -          | -        | -     |        |      |
| Noise outdoor   | dB-A (H/L)                               | -  |                                    |             | 53/-                                |                |            | -        | -     |        |      |
|   | Power Level dB                           | -  |                                    |             | 70/-                                |                |            | -        | -     |        |      |
| H<br>E<br>A<br>T<br>I<br>N<br>G                                       | Capacity                                 | kW   | 14.0                               | 14.0        | 14.0                                | -              | -          | -        | 4.1   | 16.0   |      |
|   |  | BTU/h  | 47800                              | 47800       | 47800                               | -              | -          | -        | 14000 | 54600  |      |
|   | Current                                  | A  | 0.39×3                             | 0.38×3      | 0.37×3                              | 5.50           | 5.20       | 5.05     | -     | -      |      |
|   |  | W  | 40×3                               | 40×3        | 40×3                                | 3.400k         | 3.400k     | 3.400k   | -     | -      |      |
|   | Input power                              | TOTAL W  | -                                  |             |                                     | 3.520k         | 3.520k     | 3.520k   | 900   | 5.210k |      |
|   |  | COP/COP CLASS                                  | TOTAL (W/W) <sup>5</sup> ("A"~"G") | -           | -                                   | -              | 3.98       | 3.98 / A | 3.98  | 4.56   | 3.07 |
|   | E<br>r<br>p<br>*6                        | Pdesign at -10°C                               | kW                                 | -           | -                                   | -              | -          | 12.5     | -     | -      | -    |
|   |  | Tbivalent                                      | °C                                 | -           | -                                   | -              | -          | -10      | -     | -      | -    |
|   |  | η <sub>s.h</sub>                               | %                                  | -           | -                                   | -              | -          | 150.1    | -     | -      | -    |
|   |  | Annual consumption                             | kWh                                | -           | -                                   | -              | -          | -        | -     | -      | -    |
| Class   |  | -  | -                                  | -           | -                                   | -              | -          | -        | -     |        |      |
| Power factor  | %  | -  | -                                  | -           | 94                                  | 94             | 94         | -        | -     |        |      |
| Noise indoor  | dB-A (H/M/L)                             | 37/33/29                                       |                                    |             | -                                   | -              | -          | -        | -     |        |      |
|   | Power Level dB                           | 55/51/47                                       |                                    |             | -                                   | -              | -          | -        | -     |        |      |
| Noise outdoor   | dB-A (H/L)                               | -  |                                    |             | 53/-                                |                |            | -        | -     |        |      |
|   | Power Level dB                           | -  |                                    |             | 70/-                                |                |            | -        | -     |        |      |
| EXTRA LOW TEMP <sup>6</sup> Total capacity(kW) / Input power(W) / COP |  | -  |                                    |             |                                     |                |            |          |       |        |      |
| Max Current(A) / Max Input power(W)                                   |  | 0.39×3/40×3                                    | 0.38×3/40×3                        | 0.37×3/40×3 | 10.0/6.19k                          | 10.0/6.51k     | 10.0/6.75k | -        |       |        |      |
| Starting current(A) / Comp output(W)                                  |  | -  | -                                  | -           | 5.85/3.0k                           | 5.55/3.0k      | 5.35/3.0k  | -        |       |        |      |
| Network Impedance(ΩMAX.)  |  | -  |                                    |             |                                     |                |            |          |       |        |      |
| Fan motor output (Indoor/Outdoor) W                                   |  | 43   |                                    |             | 90×2                                |                |            | -        |       |        |      |
| Moisture removal volume   |  | L/h(Pt/h)                                      | 7.9                                | (2.63×3)    | (16.6)                              | -              |            |          | -     |        |      |
| External static pressure  |  | Pa   | -                                  |             |                                     | -              |            |          | -     |        |      |
| Indoor Air flow   | Cooling                                  | m³/min (ft³/min)                               | [15/12.5/10.5 (530/441/371)]×3     |             |                                     | -              |            |          | -     |        |      |
|   | Heating                                  | m³/min (ft³/min)                               | [15/12.5/10.5 (530/441/371)]×3     |             |                                     | -              |            |          | -     |        |      |
| Outdoor Air flow  | Cooling                                  | m³/min (ft³/min)                               | -                                  |             |                                     | 130            | (4591)     | -        |       |        |      |
|   | Heating                                  | m³/min (ft³/min)                               | -                                  |             |                                     | 110            | (3885)     | -        |       |        |      |
| Refrigerant type / amount g(oz)                                       |  | -  |                                    |             | R410A                               | 3.40k          | (119.9)    | -        |       |        |      |
| Product dimension   | Height                                   | mm(inch)                                       | 235 (9-1/4)                        |             |                                     | 1416 (55-3/4)  |            |          | -     |        |      |
|   | Width                                    | mm(inch)                                       | 960 (37-25/32)                     |             |                                     | 940 (37-1/32)  |            |          | -     |        |      |
|   | Depth                                    | mm(inch)                                       | 690 (27-5/32)                      |             |                                     | 340 (13-13/32) |            |          | -     |        |      |
| Packing dimension   | Height                                   | mm(inch)                                       | 360                                |             |                                     | 1556           |            |          | -     |        |      |
|   | Width                                    | mm(inch)                                       | 1025                               |             |                                     | 1055           |            |          | -     |        |      |
|   | Depth                                    | mm(inch)                                       | 820                                |             |                                     | 485            |            |          | -     |        |      |
| Weight  | (NET)                                    | kg(lb)   | 27 (60)                            |             |                                     | 98 (216)       |            |          | -     |        |      |
|   | (GROSS)                                  | kg(lb)   | 34 (75)                            |             |                                     | 108 (238)      |            |          | -     |        |      |
| Layers limit (actually)   |  | 9 (10)   |                                    |             | 1 (2)                               |                |            | -        |       |        |      |
| Operation condition   | Cool (DBT)                               | 18°C ~ 32°C                                    |                                    |             | -15°C ~ 46°C                        |                |            | -        |       |        |      |
|   | Heat (DBT)                               | 16°C ~ 30°C                                    |                                    |             | -20°C ~ 24°C                        |                |            | -        |       |        |      |
| P<br>I<br>P<br>I<br>N<br>G  | Pipe diameter mm (inch)                  | (Liquid)∅6.35(1/4) (Gas)∅12.7(1/2)             |                                    |             | (Liquid)∅9.52(3/8) (Gas)∅15.88(5/8) |                |            | -        |       |        |      |
|   | Connecting method, Standard length m(ft) | flared type, 5.0(16.4)                         |                                    |             | flared type, 5.0(16.4)              |                |            | -        |       |        |      |
| Pipe length range   |  | m (ft)   |                                    |             | 5 ~ 75 (16.4 ~ 246.1)               |                |            | -        |       |        |      |
| Indoor unit & Outdoor unit height difference m (ft)                   |  | 15 (OD located lower) / 30 (OD located higher) |                                    |             | (49.2/98.4)                         |                |            | -        |       |        |      |
| Add gas amount g/m (oz/ft)  |  | 50   |                                    |             | (0.538)                             |                |            | -        |       |        |      |
| Pipe length for additional gas  |  | m (ft)   |                                    |             | 20 (65.6)                           |                |            | -        |       |        |      |

\*1: In case it is necessary to indicate the air flow volume in (l/s), the value in (m³/min.) shall be multiplied by 16.7 and rounded down the decimal point.

\*2: If the EUROVENT Certified models can be operated under the "extra-low" temperature condition, -7°C dry bulb and -8°C wet-bulb temperatures with rated voltage 230 V shall be used.

\*3: Network Impedance shall be applicable for EUROPE and CHINA models.

\*4: The annual consumption is calculated by multiplying the input power at 230 V (400 V) by an average of 500 hours per year in cooling mode.

\*5: EER and COP classification is at 230 V (400 V) only in accordance with EU directive 2002/31/EC.

\*6: SEER and SCOP classification is at 230V(400V) only in accordance with EN-14825. For heating, SCOP indicates the value of only Average heating season.

# Simultaneous (Twin) -Type

## 1-1. Unit Specifications

**PE1**

### 2. Ceiling Type S-50PT2E5A×2 / U-100PE1E8A

| INDOOR   |   | MODEL  | S-50PT2E5A×2                       |             |                                     | -              |           |          | -     |        |      |
|--|---|--|------------------------------------|-------------|-------------------------------------|----------------|-----------|----------|-------|--------|------|
| PANEL  |   | MODEL  | -                                  |             |                                     | -              |           |          | -     |        |      |
| OUTDOOR  |   | MODEL  | -                                  |             |                                     | U-100PE1E8A    |           |          | -     |        |      |
| Branch pipe  |   | MODEL  | -                                  |             |                                     | CZ-P155BK1     |           |          | -     |        |      |
| Performance test condition                                 |   | ISO5151 / EN14511 / EN14825 / EN12102          |                                    |             |                                     |                |           |          |       |        |      |
| Power supply   |   | Ø, Hz  | 1ø 50Hz                            |             |                                     | 3ø 50Hz        |           |          |       |        |      |
|  |   | V  | 220                                | 230         | 240                                 | 380            | 400       | 415      | Min   | Max    |      |
| C<br>O<br>O<br>L<br>I<br>N<br>G                            | Capacity  | kW   | 10.0                               | 10.0        | 10.0                                | -              | -         | -        | 3.3   | 12.5   |      |
|  |   | BTU/h  | 34100                              | 34100       | 34100                               | -              | -         | -        | 11300 | 42700  |      |
|  | Current   | A  | 0.39×2                             | 0.38×2      | 0.37×2                              | 3.95           | 3.75      | 3.65     | -     | -      |      |
|  |   | W  | 40×2                               | 40×2        | 40×2                                | 2.450k         | 2.450k    | 2.450k   | -     | -      |      |
|  | Input power   | TOTAL W  | -                                  |             |                                     | 2.530k         | 2.530k    | 2.530k   | 840   | 3.850k |      |
|  |   | Annual consumption                             | TOTAL kWh *4                       | -           |                                     |                | -         | 1265     | -     | -      | -    |
|  | EER/EER CLASS                                       | TOTAL (W/W) <sup>5</sup> ("A"~"G")             | -                                  | -           | -                                   | 3.95           | 3.95 / A  | 3.95     | 3.93  | 3.25   |      |
|  | E <sub>rp</sub> <sup>6</sup>                        | Pdesign  | kW                                 | -           | -                                   | -              | -         | 10.0     | -     | -      | -    |
|  |   | SEER   | (W/W)                              | -           | -                                   | -              | -         | 6.4      | -     | -      | -    |
|  |   | Annual consumption                             | kWh                                | -           | -                                   | -              | -         | 547      | -     | -      | -    |
| Class  |   |  | -                                  | -           | -                                   | -              | A++       | -        | -     | -      |      |
| Power factor   | %   | -  | -                                  | -           | 94                                  | 94             | 93        | -        | -     |        |      |
| Noise indoor   | dB-A (H/M/L)  | 37/33/29                                       |                                    |             | -                                   | -              | -         | -        | -     |        |      |
|  | Power Level dB                                      | 55/51/47                                       |                                    |             | -                                   | -              | -         | -        | -     |        |      |
| Noise outdoor  | dB-A (H/L)  | -  |                                    |             | 52/-                                |                |           | -        | -     |        |      |
|  | Power Level dB                                      | -  |                                    |             | 69/-                                |                |           | -        | -     |        |      |
| H<br>E<br>A<br>T<br>I<br>N<br>G                            | Capacity  | kW   | 11.2                               | 11.2        | 11.2                                | -              | -         | -        | 4.1   | 14.0   |      |
|  |   | BTU/h  | 38200                              | 38200       | 38200                               | -              | -         | -        | 14000 | 47800  |      |
|  | Current   | A  | 0.39×2                             | 0.38×2      | 0.37×2                              | 4.05           | 3.85      | 3.75     | -     | -      |      |
|  |   | W  | 40×2                               | 40×2        | 40×2                                | 2.520k         | 2.520k    | 2.520k   | -     | -      |      |
|  | Input power   | TOTAL W  | -                                  |             |                                     | 2.600k         | 2.600k    | 2.600k   | 900   | 4.400k |      |
|  |   | COP/COP CLASS                                  | TOTAL (W/W) <sup>5</sup> ("A"~"G") | -           | -                                   | -              | 4.31      | 4.31 / A | 4.31  | 4.56   | 3.18 |
|  | E <sub>rp</sub> <sup>6</sup>                        | Pdesign at -10°C                               | kW                                 | -           | -                                   | -              | -         | 10.0     | -     | -      | -    |
|  |   | Tbivalent                                      | °C                                 | -           | -                                   | -              | -         | -10      | -     | -      | -    |
|  |   | SCOP   | (W/W)                              | -           | -                                   | -              | -         | 4.3      | -     | -      | -    |
|  |   | Annual consumption                             | kWh                                | -           | -                                   | -              | -         | 3256     | -     | -      | -    |
| Class  |   | -  | -                                  | -           | -                                   | A+             | -         | -        | -     |        |      |
| Power factor   | %   | -  | -                                  | -           | 95                                  | 94             | 93        | -        | -     |        |      |
| Noise indoor   | dB-A (H/M/L)  | 37/33/29                                       |                                    |             | -                                   | -              | -         | -        | -     |        |      |
|  | Power Level dB                                      | 55/51/47                                       |                                    |             | -                                   | -              | -         | -        | -     |        |      |
| Noise outdoor  | dB-A (H/L)  | -  |                                    |             | 52/-                                |                |           | -        | -     |        |      |
|  | Power Level dB                                      | -  |                                    |             | 69/-                                |                |           | -        | -     |        |      |
| EXTRA LOW TEMP   Total capacity(kW) / Input power(W) / COP |   | -  |                                    |             |                                     |                |           |          |       |        |      |
| Max Current(A) / Max Input power(W)                        |   | 0.39×2/40×2                                    | 0.38×2/40×2                        | 0.37×2/40×2 | 9.0/5.63k                           | 9.0/5.86k      | 9.0/6.02k | -        |       |        |      |
| Starting current(A) / Comp output(W)                       |   | -  | -                                  | -           | 4.05/3.0k                           | 3.85/3.0k      | 3.75/3.0k | -        |       |        |      |
| Network Impedance(ΩMAX.)                                   |   | -  |                                    |             |                                     |                |           |          |       |        |      |
| Fan motor output (Indoor/Outdoor) W                        |   | 43   |                                    |             | 90×2                                |                |           | -        |       |        |      |
| Moisture removal volume                                    |   | L/h(Pt/h)                                      | 6.0                                | (3.0×2)     | (12.6)                              | -              |           |          | -     |        |      |
| External static pressure                                   |   | Pa   | -                                  |             |                                     | -              |           |          | -     |        |      |
| Indoor Air flow  | Cooling   | m³/min (ft³/min)                               | [15/12.5/10.5 (530/441/371)]×2     |             |                                     | -              |           |          | -     |        |      |
|  | Heating   | m³/min (ft³/min)                               | [15/12.5/10.5 (530/441/371)]×2     |             |                                     | -              |           |          | -     |        |      |
| Outdoor Air flow   | Cooling   | m³/min (ft³/min)                               | -                                  |             |                                     | 110            | (3885)    | -        |       |        |      |
|  | Heating   | m³/min (ft³/min)                               | -                                  |             |                                     | 95             | (3355)    | -        |       |        |      |
| Refrigerant type / amount g(oz)                            |   | -  |                                    |             | R410A                               | 3.40k          | (119.9)   | -        |       |        |      |
| Product dimension  | Height  | mm(inch)                                       | 235 (9-1/4)                        |             |                                     | 1416 (55-3/4)  |           |          | -     |        |      |
|  | Width   | mm(inch)                                       | 960 (37-25/32)                     |             |                                     | 940 (37-1/32)  |           |          | -     |        |      |
|  | Depth   | mm(inch)                                       | 690 (27-5/32)                      |             |                                     | 340 (13-13/32) |           |          | -     |        |      |
| Packing dimension  | Height  | mm(inch)                                       | 360                                |             |                                     | 1556           |           |          | -     |        |      |
|  | Width   | mm(inch)                                       | 1025                               |             |                                     | 1055           |           |          | -     |        |      |
|  | Depth   | mm(inch)                                       | 820                                |             |                                     | 485            |           |          | -     |        |      |
| Weight   | (NET)   | kg(lb)   | 27 (60)                            |             |                                     | 98 (216)       |           |          | -     |        |      |
|  | (GROSS)   | kg(lb)   | 34 (75)                            |             |                                     | 108 (238)      |           |          | -     |        |      |
| Layers limit (actually)                                    |   | 9 (10)   |                                    |             | 1 (2)                               |                |           | -        |       |        |      |
| Operation condition  | Cool (DBT)  | 18°C ~ 32°C                                    |                                    |             | -15°C ~ 46°C                        |                |           | -        |       |        |      |
|  | Heat (DBT)  | 16°C ~ 30°C                                    |                                    |             | -20°C ~ 24°C                        |                |           | -        |       |        |      |
| P<br>I<br>P<br>E<br>I<br>N<br>G                            | Pipe diameter mm (inch)                             | (Liquid)ø6.35(1/4) (Gas)ø12.7(1/2)             |                                    |             | (Liquid)ø9.52(3/8) (Gas)ø15.88(5/8) |                |           | -        |       |        |      |
|  | Connecting method, Standard length m(ft)            | flared type, 5.0(16.4)                         |                                    |             | flared type, 5.0(16.4)              |                |           | -        |       |        |      |
|  | Pipe length range m (ft)                            | 5 ~ 75 (16.4 ~ 246.1)                          |                                    |             |                                     |                |           | -        |       |        |      |
|  | Indoor unit & Outdoor unit height difference m (ft) | 15 (OD located lower) / 30 (OD located higher) |                                    |             | (49.2/98.4)                         |                |           | -        |       |        |      |
| Add gas amount g/m (oz/ft)                                 |   | 50 (0.538)                                     |                                    |             |                                     |                |           | -        |       |        |      |
| Pipe length for additional gas m (ft)                      |   | 30 (98.4)                                      |                                    |             |                                     |                |           | -        |       |        |      |

\*1: In case it is necessary to indicate the air flow volume in (l/s), the value in (m³/min.) shall be multiplied by 16.7 and rounded down the decimal point.

\*2: If the EUROVENT Certified models can be operated under the "extra-low" temperature condition, -7°C dry bulb and -8°C wet-bulb temperatures with rated voltage 230 V shall be used.

\*3: Network Impedance shall be applicable for EUROPE and CHINA models.

\*4: The annual consumption is calculated by multiplying the input power at 230 V (400 V) by an average of 500 hours per year in cooling mode.

\*5: EER and COP classification is at 230 V (400 V) only in accordance with EU directive 2002/31/EC.

\*6: SEER and SCOP classification is at 230V(400V) only in accordance with EN-14825. For heating, SCOP indicates the value of only Average heating season, Other fiche data indicates in an attached sheet.

# Simultaneous (Triple) -Type

## 1-1. Unit Specifications

PE1

### 2. Ceiling Type S-50PT2E5A×3 / U-140PE1E8A

| INDOOR  |  | MODEL  | S-50PT2E5A×3                       |                       |                                     | -              |            |          | -     |        |      |
|---|--|--|------------------------------------|-----------------------|-------------------------------------|----------------|------------|----------|-------|--------|------|
| PANEL   |  | MODEL  | -                                  |                       |                                     | -              |            |          | -     |        |      |
| OUTDOOR   |  | MODEL  | -                                  |                       |                                     | U-140PE1E8A    |            |          | -     |        |      |
| Branch pipe   |  | MODEL  | -                                  |                       |                                     | CZ-P3HPC2      |            |          | -     |        |      |
| Performance test condition  |  | ISO5151 / EN14511 / EN12102 / EN14825          |                                    |                       |                                     |                |            |          |       |        |      |
| Power supply  |  | Ø, Hz  | 1ø 50Hz                            |                       |                                     | 3ø 50Hz        |            |          |       |        |      |
|   |  | V  | 220                                | 230                   | 240                                 | 380            | 400        | 415      | Min   | Max    |      |
| C<br>O<br>O<br>L<br>I<br>N<br>G                                       | Capacity                                 | kW   | 14.0                               | 14.0                  | 14.0                                | -              | -          | -        | 3.3   | 15.0   |      |
|   |  | BTU/h  | 47800                              | 47800                 | 47800                               | -              | -          | -        | 11300 | 51200  |      |
|   | Current                                  | A  | 0.39×3                             | 0.38×3                | 0.37×3                              | 7.30           | 6.95       | 6.70     | -     | -      |      |
|   |  | W  | 40×3                               | 40×3                  | 40×3                                | 4.530k         | 4.530k     | 4.530k   | -     | -      |      |
|   | Input power                              | TOTAL W  | -                                  |                       |                                     | 4.650k         | 4.650k     | 4.650k   | 840   | 5.650k |      |
|   |  | Annual consumption                             | TOTAL kWh *4                       | -                     |                                     |                | -          | 2325     | -     | -      | -    |
|   | EER/EER CLASS                            | TOTAL (W/W) <sup>5</sup> ("A"~"G")             | -                                  | -                     | -                                   | 3.01           | 3.01 / B   | 3.01     | 3.93  | 2.65   |      |
|   | Erp *6                                   | Pdesign  | kW                                 | -                     | -                                   | -              | -          | 14.0     | -     | -      | -    |
|   |  | η <sub>s,c</sub>                               | %                                  | -                     | -                                   | -              | -          | 221.5    | -     | -      | -    |
|   |  | Annual consumption                             | kWh                                | -                     | -                                   | -              | -          | -        | -     | -      | -    |
| Class   |  |  | -                                  | -                     | -                                   | -              | -          | -        | -     | -      |      |
| Power factor  | %  | -  | -                                  | -                     | 94                                  | 94             | 94         | -        | -     |        |      |
| Noise indoor  | dB-A (H/M/L)                             | 37/33/29                                       |                                    |                       | -                                   | -              | -          | -        | -     |        |      |
|   | Power Level dB                           | 55/51/47                                       |                                    |                       | -                                   | -              | -          | -        | -     |        |      |
| Noise outdoor   | dB-A (H/L)                               | -  |                                    |                       | 54/-                                |                |            | -        | -     |        |      |
|   | Power Level dB                           | -  |                                    |                       | 71/-                                |                |            | -        | -     |        |      |
| H<br>E<br>A<br>T<br>I<br>N<br>G                                       | Capacity                                 | kW   | 16.0                               | 16.0                  | 16.0                                | -              | -          | -        | 4.1   | 18.0   |      |
|   |  | BTU/h  | 54600                              | 54600                 | 54600                               | -              | -          | -        | 14000 | 61400  |      |
|   | Current                                  | A  | 0.39×3                             | 0.38×3                | 0.37×3                              | 6.85           | 6.50       | 6.25     | -     | -      |      |
|   |  | W  | 40×3                               | 40×3                  | 40×3                                | 4.240k         | 4.240k     | 4.240k   | -     | -      |      |
|   | Input power                              | TOTAL W  | -                                  |                       |                                     | 4.360k         | 4.360k     | 4.360k   | 900   | 5.930k |      |
|   |  | COP/COP CLASS                                  | TOTAL (W/W) <sup>5</sup> ("A"~"G") | -                     | -                                   | -              | 3.67       | 3.67 / A | 3.67  | 4.56   | 3.04 |
|   | Erp *6                                   | Pdesign at -10°C                               | kW                                 | -                     | -                                   | -              | -          | 14.0     | -     | -      | -    |
|   |  | Tbivalent                                      | °C                                 | -                     | -                                   | -              | -          | -7       | -     | -      | -    |
|   |  | η <sub>s,h</sub>                               | %                                  | -                     | -                                   | -              | -          | 145.5    | -     | -      | -    |
|   |  | Annual consumption                             | kWh                                | -                     | -                                   | -              | -          | -        | -     | -      | -    |
| Class   |  | -  | -                                  | -                     | -                                   | -              | -          | -        | -     |        |      |
| Power factor  | %  | -  | -                                  | -                     | 94                                  | 94             | 94         | -        | -     |        |      |
| Noise indoor  | dB-A (H/M/L)                             | 37/33/29                                       |                                    |                       | -                                   | -              | -          | -        | -     |        |      |
|   | Power Level dB                           | 55/51/47                                       |                                    |                       | -                                   | -              | -          | -        | -     |        |      |
| Noise outdoor   | dB-A (H/L)                               | -  |                                    |                       | 55/-                                |                |            | -        | -     |        |      |
|   | Power Level dB                           | -  |                                    |                       | 71/-                                |                |            | -        | -     |        |      |
| EXTRA LOW TEMP <sup>6</sup> Total capacity(kW) / Input power(W) / COP |  | -  |                                    |                       |                                     |                |            |          |       |        |      |
| Max Current(A) / Max Input power(W)                                   |  | 0.39×3/40×3                                    | 0.38×3/40×3                        | 0.37×3/40×3           | 11.0/6.81k                          | 11.0/7.16k     | 11.0/7.43k | -        |       |        |      |
| Starting current(A) / Comp output(W)                                  |  | -  | -                                  | -                     | 7.30/3.0k                           | 6.95/3.0k      | 6.70/3.0k  | -        |       |        |      |
| Network Impedance(ΩMAX.)  |  | -  |                                    |                       |                                     |                |            |          |       |        |      |
| Fan motor output (Indoor/Outdoor) W                                   |  | 43   |                                    |                       | 90×2                                |                |            | -        |       |        |      |
| Moisture removal volume   |  | L/h(Pt/h)                                      | 9.0                                | (3.0×3)               | (18.9)                              | -              |            |          | -     |        |      |
| External static pressure  |  | Pa   | -                                  |                       |                                     | -              |            |          | -     |        |      |
| Indoor Air flow   | Cooling                                  | m³/min (ft³/min)                               | [15/12.5/10.5 (530/441/371)]×3     |                       |                                     | -              |            |          | -     |        |      |
|   | Heating                                  | m³/min (ft³/min)                               | [15/12.5/10.5 (530/441/371)]×3     |                       |                                     | -              |            |          | -     |        |      |
| Outdoor Air flow  | Cooling                                  | m³/min (ft³/min)                               | -                                  |                       |                                     | 135            | (4767)     | -        |       |        |      |
|   | Heating                                  | m³/min (ft³/min)                               | -                                  |                       |                                     | 120            | (4238)     | -        |       |        |      |
| Refrigerant type / amount g(oz)                                       |  | -  |                                    |                       | R410A                               | 3.40k          | (119.9)    | -        |       |        |      |
| Product dimension   | Height                                   | mm(inch)                                       | 235 (9-1/4)                        |                       |                                     | 1416 (55-3/4)  |            |          | -     |        |      |
|   | Width                                    | mm(inch)                                       | 960 (37-25/32)                     |                       |                                     | 940 (37-1/32)  |            |          | -     |        |      |
|   | Depth                                    | mm(inch)                                       | 690 (27-5/32)                      |                       |                                     | 340 (13-13/32) |            |          | -     |        |      |
| Packing dimension   | Height                                   | mm(inch)                                       | 360                                |                       |                                     | 1556           |            |          | -     |        |      |
|   | Width                                    | mm(inch)                                       | 1025                               |                       |                                     | 1055           |            |          | -     |        |      |
|   | Depth                                    | mm(inch)                                       | 820                                |                       |                                     | 485            |            |          | -     |        |      |
| Weight  | (NET)                                    | kg(lb)   | 27 (60)                            |                       |                                     | 98 (216)       |            |          | -     |        |      |
|   | (GROSS)                                  | kg(lb)   | 34 (75)                            |                       |                                     | 108 (238)      |            |          | -     |        |      |
| Layers limit (actually)   |  | 9 (10)   |                                    |                       | 1 (2)                               |                |            | -        |       |        |      |
| Operation condition   | Cool (DBT)                               | 18°C ~ 32°C                                    |                                    |                       | -15°C ~ 46°C                        |                |            | -        |       |        |      |
|   | Heat (DBT)                               | 16°C ~ 30°C                                    |                                    |                       | -20°C ~ 24°C                        |                |            | -        |       |        |      |
| P<br>I<br>P<br>I<br>N<br>G  | Pipe diameter mm (inch)                  | (Liquid)ø6.35(1/4) (Gas)ø12.7(1/2)             |                                    |                       | (Liquid)ø9.52(3/8) (Gas)ø15.88(5/8) |                |            | -        |       |        |      |
|   | Connecting method, Standard length m(ft) | flared type, 5.0(16.4)                         |                                    |                       | flared type, 5.0(16.4)              |                |            | -        |       |        |      |
| Pipe length range   |  | m (ft)   |                                    | 5 ~ 75 (16.4 ~ 246.1) |                                     | -              |            |          |       |        |      |
| Indoor unit & Outdoor unit height difference m (ft)                   |  | 15 (OD located lower) / 30 (OD located higher) |                                    |                       | (49.2/98.4)                         |                |            | -        |       |        |      |
| Add gas amount g/m (oz/ft)  |  | 50 (0.538)                                     |                                    |                       | -                                   |                |            | -        |       |        |      |
| Pipe length for additional gas  |  | m (ft)   |                                    | 20 (65.6)             |                                     | -              |            |          |       |        |      |

\*1: In case it is necessary to indicate the air flow volume in (l/s), the value in (m³/min.) shall be multiplied by 16.7 and rounded down the decimal point.

\*2: If the EUROVENT Certified models can be operated under the "extra-low" temperature condition, -7°C dry bulb and -8°C wet-bulb temperatures with rated voltage 230 V shall be used.

\*3: Network Impedance shall be applicable for EUROPE and CHINA models.

\*4: The annual consumption is calculated by multiplying the input power at 230 V (400 V) by an average of 500 hours per year in cooling mode.

\*5: EER and COP classification is at 230 V (400 V) only in accordance with EU directive 2002/31/EC.

\*6: SEER and SCOP classification is at 230V(400V) only in accordance with EN-14825. For heating, SCOP indicates the value of only Average heating season.

# 1 Simultaneous (Twin) -Type

## 1-1. Unit Specifications

PE1

### 2. Ceiling Type S-60PT2E5A×2 / U-125PE1E8A

| INDOOR   |  | MODEL  | S-60PT2E5A×2                 |             |                                     | -              |            |        | -      |        |   |
|--|--|--|------------------------------|-------------|-------------------------------------|----------------|------------|--------|--------|--------|---|
| PANEL  |  | MODEL  | -                            |             |                                     | -              |            |        | -      |        |   |
| OUTDOOR  |  | MODEL  | -                            |             |                                     | U-125PE1E8A    |            |        | -      |        |   |
| Branch pipe  |  | MODEL  | -                            |             |                                     | CZ-P155BK1     |            |        | -      |        |   |
| Performance test condition                                 |  | ISO5151 / EN14511 / EN12102 / EN14825          |                              |             |                                     |                |            |        |        |        |   |
| Power supply   |  | Ø, Hz  | 1ø 50Hz                      |             |                                     | 3ø 50Hz        |            |        |        |        |   |
|  |  | V  | 220                          | 230         | 240                                 | 380            | 400        | 415    | Min    | Max    |   |
| C<br>O<br>O<br>L<br>I<br>N<br>G                            | Capacity                                 | kW   | 12.5                         | 12.5        | 12.5                                | -              | -          | -      | 3.3    | 14.0   |   |
|  |  | BTU/h  | 42700                        | 42700       | 42700                               | -              | -          | -      | 11300  | 47800  |   |
|  | Current                                  | A  | 0.42×2                       | 0.41×2      | 0.40×2                              | 5.85           | 5.55       | 5.35   | -      | -      |   |
|  |  | W  | 50×2                         | 50×2        | 50×2                                | 3.630k         | 3.630k     | 3.630k | -      | -      |   |
|  | Input power                              | TOTAL W  | -                            |             |                                     | 3.730k         | 3.730k     | 3.730k | 840    | 4.860k |   |
|  |  | Annual consumption                             | TOTAL kWh *4                 | -           |                                     |                | -          | 1865   | -      | -      | - |
|  | EER/EER CLASS                            | TOTAL (W/W) <sup>5/6</sup> ("A"-G)             | -                            | -           | -                                   | 3.35           | 3.35 / A   | 3.35   | 3.93   | 2.88   |   |
|  | Erp *6                                   | Pdesign  | kW                           | -           | -                                   | -              | -          | 12.5   | -      | -      | - |
|  |  | η <sub>s.c</sub>                               | %                            | -           | -                                   | -              | -          | 240.0  | -      | -      | - |
|  |  | Annual consumption                             | kWh                          | -           | -                                   | -              | -          | -      | -      | -      | - |
| Class  |  |  | -                            | -           | -                                   | -              | -          | -      | -      | -      |   |
| Power factor   | %  | -  | -                            | -           | 94                                  | 94             | 94         | -      | -      |        |   |
| Noise indoor   | dB-A (H/M/L)                             | 38/34/30                                       |                              |             | -                                   | -              | -          | -      | -      |        |   |
|  | Power Level dB                           | 56/52/48                                       |                              |             | -                                   | -              | -          | -      | -      |        |   |
| Noise outdoor  | dB-A (H/L)                               | -  |                              |             | 53/-                                |                |            | -      | -      |        |   |
|  | Power Level dB                           | -  |                              |             | 70/-                                |                |            | -      | -      |        |   |
| Capacity   | kW                                       | 14.0   | 14.0                         | 14.0        | -                                   | -              | -          | 4.1    | 14.0   |        |   |
|  | BTU/h                                    | 47800  | 47800                        | 47800       | -                                   | -              | -          | 14000  | 54600  |        |   |
| Current  | A  | 0.42×2   | 0.41×2                       | 0.40×2      | 5.50                                | 5.25           | 5.05       | -      | -      |        |   |
|  | W  | 50×2   | 50×2                         | 50×2        | 3.410k                              | 3.410k         | 3.410k     | -      | -      |        |   |
| Input power  | TOTAL W                                  | -  |                              |             | 3.510k                              | 3.510k         | 3.510k     | 900    | 5.210k |        |   |
|  | COP/COP CLASS                            | TOTAL (W/W) <sup>5/6</sup> ("A"-G)             | -                            | -           | -                                   | 3.99           | 3.99 / A   | 3.99   | 4.56   | 3.07   |   |
| Erp *6   | Pdesign at -10°C                         | kW   | -                            | -           | -                                   | -              | 12.5       | -      | -      | -      |   |
|  | Tbivalent                                | °C   | -                            | -           | -                                   | -              | -10        | -      | -      | -      |   |
|  | η <sub>s.h</sub>                         | %  | -                            | -           | -                                   | -              | 150.1      | -      | -      | -      |   |
|  | Annual consumption                       | kWh  | -                            | -           | -                                   | -              | -          | -      | -      | -      |   |
| Class  |  | -  | -                            | -           | -                                   | -              | -          | -      | -      |        |   |
| Power factor   | %  | -  | -                            | -           | 94                                  | 94             | 94         | -      | -      |        |   |
| Noise indoor   | dB-A (H/M/L)                             | 38/34/30                                       |                              |             | -                                   | -              | -          | -      | -      |        |   |
|  | Power Level dB                           | 56/52/48                                       |                              |             | -                                   | -              | -          | -      | -      |        |   |
| Noise outdoor  | dB-A (H/L)                               | -  |                              |             | 53/-                                |                |            | -      | -      |        |   |
|  | Power Level dB                           | -  |                              |             | 70/-                                |                |            | -      | -      |        |   |
| EXTRA LOW TEMP   Total capacity(kW) / Input power(W) / COP |  | -  |                              |             |                                     |                |            |        |        |        |   |
| Max Current(A) / Max Input power(W)                        |  | 0.42×2/50×2                                    | 0.41×2/50×2                  | 0.40×2/50×2 | 10.0/6.19k                          | 10.0/6.51k     | 10.0/6.75k | -      |        |        |   |
| Starting current(A) / Comp output(W)                       |  | -  | -                            | -           | 5.85/3.0k                           | 5.55/3.0k      | 5.35/3.0k  | -      |        |        |   |
| Network Impedance(ΩMAX.)                                   |  | -  |                              |             |                                     |                |            |        |        |        |   |
| Fan motor output (Indoor/Outdoor) W                        |  | 74   |                              |             | 90×2                                |                |            | -      |        |        |   |
| Moisture removal volume                                    |  | L/h(Pt/h)                                      | 7.9                          | (3.95×2)    | (16.6)                              | -              |            |        | -      |        |   |
| External static pressure                                   |  | Pa   | -                            |             |                                     | -              |            |        | -      |        |   |
| Indoor Air flow  | Cooling                                  | m³/min (ft³/min)                               | [20/17/14.5 (706/600/512)]×2 |             |                                     | -              |            |        | -      |        |   |
|  | Heating                                  | m³/min (ft³/min)                               | [20/17/14.5 (706/600/512)]×2 |             |                                     | -              |            |        | -      |        |   |
| Outdoor Air flow   | Cooling                                  | m³/min (ft³/min)                               | -                            |             |                                     | 130            | (4591)     | -      |        |        |   |
|  | Heating                                  | m³/min (ft³/min)                               | -                            |             |                                     | 110            | (3885)     | -      |        |        |   |
| Refrigerant type / amount g(oz)                            |  | -  |                              |             | R410A                               | 3.40k          | (119.9)    | -      |        |        |   |
| Product dimension  | Height                                   | mm(inch)                                       | 235 (9-1/4)                  |             |                                     | 1416 (55-3/4)  |            |        | -      |        |   |
|  | Width                                    | mm(inch)                                       | 1275 (50-3/16)               |             |                                     | 940 (37-1/32)  |            |        | -      |        |   |
|  | Depth                                    | mm(inch)                                       | 690 (27-5/32)                |             |                                     | 340 (13-13/32) |            |        | -      |        |   |
| Packing dimension  | Height                                   | mm(inch)                                       | 360                          |             |                                     | 1556           |            |        | -      |        |   |
|  | Width                                    | mm(inch)                                       | 1340                         |             |                                     | 1055           |            |        | -      |        |   |
|  | Depth                                    | mm(inch)                                       | 820                          |             |                                     | 485            |            |        | -      |        |   |
| Weight   | (NET)                                    | kg(lb)   | 33 (73)                      |             |                                     | 98 (216)       |            |        | -      |        |   |
|  | (GROSS)                                  | kg(lb)   | 42 (93)                      |             |                                     | 108 (238)      |            |        | -      |        |   |
| Layers limit (actually)                                    |  | 9 (10)   |                              |             | 1 (2)                               |                |            | -      |        |        |   |
| Operation condition  | Cool (DBT)                               | 18°C ~ 32°C                                    |                              |             | -15°C ~ 46°C                        |                |            | -      |        |        |   |
|  | Heat (DBT)                               | 16°C ~ 30°C                                    |                              |             | -20°C ~ 24°C                        |                |            | -      |        |        |   |
| P<br>I<br>P<br>I<br>N<br>G                                 | Pipe diameter mm (inch)                  | (Liquid)ø9.52(3/8) (Gas)ø15.88(5/8)            |                              |             | (Liquid)ø9.52(3/8) (Gas)ø15.88(5/8) |                |            | -      |        |        |   |
|  | Connecting method, Standard length m(ft) | flared type, 5.0(16.4)                         |                              |             | flared type, 5.0(16.4)              |                |            | -      |        |        |   |
| Pipe length range  |  | m (ft)   |                              |             | 5 ~ 75 (16.4 ~ 246.1)               |                |            | -      |        |        |   |
| Indoor unit & Outdoor unit height difference m (ft)        |  | 15 (OD located lower) / 30 (OD located higher) |                              |             | (49.2/98.4)                         |                |            | -      |        |        |   |
| Add gas amount g/m (oz/ft)                                 |  | 50   |                              |             | (0.538)                             |                |            | -      |        |        |   |
| Pipe length for additional gas                             |  | m (ft)   |                              |             | 30 (98.4)                           |                |            | -      |        |        |   |

\*1: In case it is necessary to indicate the air flow volume in (l/s), the value in (m³/min.) shall be multiplied by 16.7 and rounded down the decimal point.

\*2: If the EUROVENT Certified models can be operated under the "extra-low" temperature condition, -7°C dry bulb and -8°C wet-bulb temperatures with rated voltage 230 V shall be used.

\*3: Network Impedance shall be applicable for EUROPE and CHINA models.

\*4: The annual consumption is calculated by multiplying the input power at 230 V (400 V) by an average of 500 hours per year in cooling mode.

\*5: EER and COP classification is at 230 V (400 V) only in accordance with EU directive 2002/31/EC.

\*6: SEER and SCOP classification is at 230V(400V) only in accordance with EN-14825. For heating, SCOP indicates the value of only Average heating season.



# Single -Type

## 1-1. Unit Specifications

PE1

### 2. Ceiling Type S-71PT2E5A / U-71PE1E8A

|   |  |   |  |         |                                       |                                     |           |           |      |        |      |
|---|--|---|--|---------|---------------------------------------|-------------------------------------|-----------|-----------|------|--------|------|
| INDOOR  |  | MODEL                                     | S-71PT2E5A                                     |         |                                       | -                                   |           |           | -    |        |      |
| PANEL   |  | MODEL                                     | -  |         |                                       | -                                   |           |           | -    |        |      |
| OUTDOOR   |  | MODEL                                     | -  |         |                                       | U-71PE1E8A                          |           |           | -    |        |      |
| Branch pipe   |  | MODEL                                     | -  |         |                                       | -                                   |           |           | -    |        |      |
| Performance test condition                          |  |   |  |         | ISO5151 / EN14511 / EN14825 / EN12102 |                                     |           |           |      |        |      |
| Power supply  |  | Ø, Hz                                     | 1ø 50Hz  |         |                                       | 3ø 50Hz                             |           |           |      |        |      |
|   |  | V   | 220  | 230     | 240                                   | 380                                 | 400       | 415       | Min  | Max    |      |
| C<br>O<br>O<br>L<br>I<br>N<br>G                     | Capacity                                 | kW  | 7.1  | 7.1     | 7.1                                   | -                                   | -         | -         | 2.5  | 8.0    |      |
|   |  | BTU/h                                     | 24200  | 24200   | 24200                                 | -                                   | -         | -         | 8500 | 27300  |      |
|   | Current                                  | A   | 0.45   | 0.44    | 0.43                                  | 3.00                                | 2.90      | 2.80      | -    | -      |      |
|   |  | W   | 55   | 55      | 55                                    | 1.875k                              | 1.875k    | 1.875k    | -    | -      |      |
|   | Input power                              | TOTAL W                                   | -  |         |                                       | 1.930k                              | 1.930k    | 1.930k    | 450  | 2.780k |      |
|   |  | Annual consumption                        | TOTAL kWh *4                                   | -       |                                       |                                     | -         | 965       | -    | -      | -    |
|   | EER/EER CLASS                            | TOTAL (W/W) <sup>*5</sup> ("A"~"G")       | -  | -       | -                                     | 3.68                                | 3.68 / A  | 3.68      | 5.56 | 2.88   |      |
|   | Erp <sup>*6</sup>                        | Pdesign                                   | kW   | -       | -                                     | -                                   | -         | 7.1       | -    | -      | -    |
|   |  | SEER                                      | (W/W)  | -       | -                                     | -                                   | -         | 5.9       | -    | -      | -    |
|   |  | Annual consumption                        | kWh  | -       | -                                     | -                                   | -         | 421       | -    | -      | -    |
| Class   |  |   | -  | -       | -                                     | -                                   | A+        | -         | -    | -      |      |
| Power factor  | %  | -   | -  | -       | 95                                    | 93                                  | 93        | -         | -    |        |      |
| Noise indoor  | dB-A (H/M/L)                             | 39/35/31                                  |  |         | -                                     | -                                   | -         | -         | -    |        |      |
|   | Power Level dB                           | 57/53/49                                  |  |         | -                                     | -                                   | -         | -         | -    |        |      |
| Noise outdoor                                       | dB-A (H/L)                               | -   |  |         | 48/-                                  |                                     |           | -         | -    |        |      |
|   | Power Level dB                           | -   |  |         | 65/-                                  |                                     |           | -         | -    |        |      |
| H<br>E<br>A<br>T<br>I<br>N<br>G                     | Capacity                                 | kW  | 8.0  | 8.0     | 8.0                                   | -                                   | -         | -         | 2.0  | 9.0    |      |
|   |  | BTU/h                                     | 27300  | 27300   | 27300                                 | -                                   | -         | -         | 6800 | 30700  |      |
|   | Current                                  | A   | 0.45   | 0.44    | 0.43                                  | 3.00                                | 2.90      | 2.80      | -    | -      |      |
|   |  | W   | 55   | 55      | 55                                    | 1.875k                              | 1.875k    | 1.875k    | -    | -      |      |
|   | Input power                              | TOTAL W                                   | -  |         |                                       | 1.930k                              | 1.930k    | 1.930k    | 400  | 2.900k |      |
|   |  | COP/COP CLASS                             | TOTAL (W/W) <sup>*5</sup> ("A"~"G")            | -       | -                                     | -                                   | 4.15      | 4.15 / A  | 4.15 | 5.00   | 3.10 |
|   | Erp <sup>*6</sup>                        | Pdesign at -10°C                          | kW   | -       | -                                     | -                                   | -         | 7.1       | -    | -      | -    |
|   |  | Tbivalent                                 | °C   | -       | -                                     | -                                   | -         | -9        | -    | -      | -    |
|   |  | SCOP                                      | (W/W)  | -       | -                                     | -                                   | -         | 4.0       | -    | -      | -    |
|   |  | Annual consumption                        | kWh  | -       | -                                     | -                                   | -         | 2485      | -    | -      | -    |
| Class   |  | -   | -  | -       | -                                     | A+                                  | -         | -         | -    |        |      |
| Power factor  | %  | -   | -  | -       | 95                                    | 93                                  | 93        | -         | -    |        |      |
| Noise indoor  | dB-A (H/M/L)                             | 39/35/31                                  |  |         | -                                     | -                                   | -         | -         | -    |        |      |
|   | Power Level dB                           | 57/53/49                                  |  |         | -                                     | -                                   | -         | -         | -    |        |      |
| Noise outdoor                                       | dB-A (H/L)                               | -   |  |         | 50/-                                  |                                     |           | -         | -    |        |      |
|   | Power Level dB                           | -   |  |         | 67/-                                  |                                     |           | -         | -    |        |      |
| EXTRA LOW TEMP                                      |  | Total capacity(kW) / Input power(W) / COP | -  |         |                                       | -                                   |           |           | -    |        |      |
| Max Current(A) / Max Input power(W)                 |  |   | 0.45/55  | 0.44/55 | 0.43/55                               | 7.0/4.15k                           | 7.0/4.36k | 7.0/4.53k | -    |        |      |
| Starting current(A) / Comp output(W)                |  |   | -  | -       | -                                     | 3.00/2.0k                           | 2.90/2.0k | 2.80/2.0k | -    |        |      |
| Network Impedance(ΩMAX.)                            |  |   | -  |         |                                       | -                                   |           |           | -    |        |      |
| Fan motor output (Indoor/Outdoor) W                 |  |   | 74   |         |                                       | 90                                  |           |           | -    |        |      |
| Moisture removal volume                             |  | L/h(Pt/h)                                 | 4.2 (8.8)                                      |         |                                       | -                                   |           |           | -    |        |      |
| External static pressure                            |  | Pa  | -  |         |                                       | -                                   |           |           | -    |        |      |
| Indoor Air flow                                     | Cooling                                  | m³/min (ft³/min)                          | 21/18/15.5 (742/636/547)                       |         |                                       | -                                   |           |           | -    |        |      |
|   | Heating                                  | m³/min (ft³/min)                          | 21/18/15.5 (742/636/547)                       |         |                                       | -                                   |           |           | -    |        |      |
| Outdoor Air flow                                    | Cooling                                  | m³/min (ft³/min)                          | -  |         |                                       | 60 (2119)                           |           |           | -    |        |      |
|   | Heating                                  | m³/min (ft³/min)                          | -  |         |                                       | 60 (2119)                           |           |           | -    |        |      |
| Refrigerant type / amount g(oz)                     |  |   | -  |         |                                       | R410A                               | 2.35k     | (82.9)    | -    |        |      |
| Product dimension                                   | Height                                   | mm(inch)                                  | 235 (9-1/4)                                    |         |                                       | 996 (39-7/32)                       |           |           | -    |        |      |
|   | Width                                    | mm(inch)                                  | 1275 (50-3/16)                                 |         |                                       | 940 (37-1/32)                       |           |           | -    |        |      |
|   | Depth                                    | mm(inch)                                  | 690 (27-5/32)                                  |         |                                       | 340 (13-13/32)                      |           |           | -    |        |      |
| Packing dimension                                   | Height                                   | mm(inch)                                  | 360  |         |                                       | 1136                                |           |           | -    |        |      |
|   | Width                                    | mm(inch)                                  | 1340   |         |                                       | 1055                                |           |           | -    |        |      |
|   | Depth                                    | mm(inch)                                  | 820  |         |                                       | 485                                 |           |           | -    |        |      |
| Weight  | (NET)                                    | kg(lb)                                    | 33 (73)  |         |                                       | 71 (157)                            |           |           | -    |        |      |
|   | (GROSS)                                  | kg(lb)                                    | 42 (93)  |         |                                       | 79 (174)                            |           |           | -    |        |      |
| Layers limit (actually)                             |  |   | 9 (10)   |         |                                       | 2 (3)                               |           |           | -    |        |      |
| Operation condition                                 | Cool (DBT)                               |   | 18°C ~ 32°C                                    |         |                                       | -15°C ~ 46°C                        |           |           | -    |        |      |
|   | Heat (DBT)                               |   | 16°C ~ 30°C                                    |         |                                       | -20°C ~ 24°C                        |           |           | -    |        |      |
| P<br>I<br>P<br>I<br>N<br>G                          | Pipe diameter mm (inch)                  |   | (Liquid)ø9.52(3/8) (Gas)ø15.88(5/8)            |         |                                       | (Liquid)ø9.52(3/8) (Gas)ø15.88(5/8) |           |           | -    |        |      |
|   | Connecting method, Standard length m(ft) |   | flared type, 5.0(16.4)                         |         |                                       | flared type, 5.0(16.4)              |           |           | -    |        |      |
| Pipe length range                                   |  | m (ft)                                    | 5 ~ 50 (16.4 ~ 164)                            |         |                                       |                                     |           |           | -    |        |      |
| Indoor unit & Outdoor unit height difference m (ft) |  |   | 15 (OD located lower) / 30 (OD located higher) |         |                                       | (49.2/98.4)                         |           |           | -    |        |      |
| Add gas amount g/m (oz/ft)                          |  |   | 50 (0.538)                                     |         |                                       |                                     |           |           | -    |        |      |
| Pipe length for additional gas                      |  | m (ft)                                    | 30 (98.4)                                      |         |                                       |                                     |           |           | -    |        |      |

\*1: In case it is necessary to indicate the air flow volume in (l/s), the value in (m³/min.) shall be multiplied by 16.7 and rounded down the decimal point.

\*2: If the EUROVENT Certified models can be operated under the "extra-low" temperature condition, -7°C dry bulb and -8°C wet-bulb temperatures with rated voltage 230 V shall be used.

\*3: Network Impedance shall be applicable for EUROPE and CHINA models.

\*4: The annual consumption is calculated by multiplying the input power at 230 V (400 V) by an average of 500 hours per year in cooling mode.

\*5: EER and COP classification is at 230 V (400 V) only in accordance with EU directive 2002/31/EC.

\*6: SEER and SCOP classification is at 230V(400V) only in accordance with EN-14825. For heating, SCOP indicates the value of only Average heating season, Other fiche data indicates in an attached sheet.

# Simultaneous (Twin) -Type

## 1-1. Unit Specifications

**PE1**

### 2. Ceiling Type S-71PT2E5A×2 / U-140PE1E8A

| INDOOR   |   | MODEL                                 | S-71PT2E5A×2                                   |             |            | -                                   |            |          | -     |        |      |
|--|---|---------------------------------------|--|-------------|------------|-------------------------------------|------------|----------|-------|--------|------|
| PANEL  |   | MODEL                                 | -  |             |            | -                                   |            |          | -     |        |      |
| OUTDOOR  |   | MODEL                                 | -  |             |            | U-140PE1E8A                         |            |          | -     |        |      |
| Branch pipe  |   | MODEL                                 | -  |             |            | CZ-P155BK1                          |            |          | -     |        |      |
| Performance test condition                                 |   | ISO5151 / EN14511 / EN12102 / EN14825 |  |             |            |                                     |            |          |       |        |      |
| Power supply   |   | Ø, Hz                                 | 1ø 50Hz  |             |            | 3ø 50Hz                             |            |          |       |        |      |
|  |   | V                                     | 220  | 230         | 240        | 380                                 | 400        | 415      | Min   | Max    |      |
| C<br>O<br>O<br>L<br>I<br>N<br>G                            | Capacity  | kW                                    | 14.0   | 14.0        | 14.0       | -                                   | -          | -        | 3.3   | 15.0   |      |
|  |   | BTU/h                                 | 47800  | 47800       | 47800      | -                                   | -          | -        | 11300 | 51200  |      |
|  | Current   | A                                     | 0.45×2   | 0.44×2      | 0.43×2     | 7.30                                | 6.95       | 6.70     | -     | -      |      |
|  |   | W                                     | 55×2   | 55×2        | 55×2       | 4.540k                              | 4.540k     | 4.540k   | -     | -      |      |
|  | Input power   | TOTAL W                               | -  |             |            | 4.650k                              | 4.650k     | 4.650k   | 840   | 5.650k |      |
|  |   | Annual consumption                    | TOTAL kWh *4                                   | -           |            |                                     | -          | 2325     | -     | -      | -    |
|  | EER/EER CLASS                                       | TOTAL (W/W) <sup>5</sup> ("A"-G)      | -  | -           | -          | 3.01                                | 3.01 / B   | 3.01     | 3.93  | 2.65   |      |
|  | E <sub>rp</sub> <sup>*6</sup>                       | Pdesign                               | kW   | -           | -          | -                                   | -          | 14.0     | -     | -      | -    |
|  |   | η <sub>s.c</sub>                      | %  | -           | -          | -                                   | -          | 221.3    | -     | -      | -    |
|  |   | Annual consumption                    | kWh  | -           | -          | -                                   | -          | -        | -     | -      | -    |
| Class  |   |                                       | -  | -           | -          | -                                   | -          | -        | -     | -      |      |
| Power factor   | %   | -                                     | -  | -           | 94         | 94                                  | 94         | -        | -     |        |      |
| Noise indoor   | dB-A (H/M/L)  | 39/35/31                              |  |             | -          | -                                   | -          | -        | -     |        |      |
|  | Power Level dB                                      | 57/53/49                              |  |             | -          | -                                   | -          | -        | -     |        |      |
| Noise outdoor  | dB-A (H/L)  | -                                     |  |             | 54/-       |                                     |            | -        | -     |        |      |
|  | Power Level dB                                      | -                                     |  |             | 71/-       |                                     |            | -        | -     |        |      |
| H<br>E<br>A<br>T<br>I<br>N<br>G                            | Capacity  | kW                                    | 16.0   | 16.0        | 16.0       | -                                   | -          | -        | 4.1   | 18.0   |      |
|  |   | BTU/h                                 | 54600  | 54600       | 54600      | -                                   | -          | -        | 14000 | 61400  |      |
|  | Current   | A                                     | 0.45×2   | 0.44×2      | 0.43×2     | 6.85                                | 6.50       | 6.30     | -     | -      |      |
|  |   | W                                     | 55×2   | 55×2        | 55×2       | 4.250k                              | 4.250k     | 4.250k   | -     | -      |      |
|  | Input power   | TOTAL W                               | -  |             |            | 4.360k                              | 4.360k     | 4.360k   | 900   | 5.930k |      |
|  |   | COP/COP CLASS                         | TOTAL (W/W) <sup>5</sup> ("A"-G)               | -           | -          | -                                   | 3.67       | 3.67 / A | 3.67  | 4.56   | 3.04 |
|  | E <sub>rp</sub> <sup>*6</sup>                       | Pdesign at -10°C                      | kW   | -           | -          | -                                   | -          | 14.0     | -     | -      | -    |
|  |   | Tbivalent                             | °C   | -           | -          | -                                   | -          | -7       | -     | -      | -    |
|  |   | η <sub>s.h</sub>                      | %  | -           | -          | -                                   | -          | 145.5    | -     | -      | -    |
|  |   | Annual consumption                    | kWh  | -           | -          | -                                   | -          | -        | -     | -      | -    |
| Class  |   | -                                     | -  | -           | -          | -                                   | -          | -        | -     |        |      |
| Power factor   | %   | -                                     | -  | -           | 94         | 94                                  | 94         | -        | -     |        |      |
| Noise indoor   | dB-A (H/M/L)  | 39/35/31                              |  |             | -          | -                                   | -          | -        | -     |        |      |
|  | Power Level dB                                      | 57/53/49                              |  |             | -          | -                                   | -          | -        | -     |        |      |
| Noise outdoor  | dB-A (H/L)  | -                                     |  |             | 55/-       |                                     |            | -        | -     |        |      |
|  | Power Level dB                                      | -                                     |  |             | 71/-       |                                     |            | -        | -     |        |      |
| EXTRA LOW TEMP   Total capacity(kW) / Input power(W) / COP |   | -                                     |  |             |            |                                     |            |          |       |        |      |
| Max Current(A) / Max Input power(W)                        |   | 0.45×2/55×2                           | 0.44×2/55×2                                    | 0.43×2/55×2 | 11.0/6.81k | 11.0/7.16k                          | 11.0/7.43k | -        |       |        |      |
| Starting current(A) / Comp output(W)                       |   | -                                     | -  | -           | 7.30/3.0k  | 6.95/3.0k                           | 6.70/3.0k  | -        |       |        |      |
| Network Impedance(ΩMAX.)                                   |   | -                                     |  |             |            |                                     |            |          |       |        |      |
| Fan motor output (Indoor/Outdoor) W                        |   | 74                                    |  |             | 90×2       |                                     |            | -        |       |        |      |
| Moisture removal volume                                    |   | L/h(Pt/h)                             | 9.0  | (4.5×2)     | (18.9)     | -                                   |            |          | -     |        |      |
| External static pressure                                   |   | Pa                                    | -  |             |            | -                                   |            |          | -     |        |      |
| Indoor Air flow  | Cooling   | m³/min (ft³/min)                      | [21/18/15.5 (742/636/547)]×2                   |             |            | -                                   |            |          | -     |        |      |
|  | Heating   | m³/min (ft³/min)                      | [21/18/15.5 (742/636/547)]×2                   |             |            | -                                   |            |          | -     |        |      |
| Outdoor Air flow   | Cooling   | m³/min (ft³/min)                      | -  |             |            | 135                                 | (4767)     | -        |       |        |      |
|  | Heating   | m³/min (ft³/min)                      | -  |             |            | 120                                 | (4238)     | -        |       |        |      |
| Refrigerant type / amount g(oz)                            |   | -                                     |  |             | R410A      | 3.40k                               | (119.9)    | -        |       |        |      |
| Product dimension  | Height  | mm(inch)                              | 235 (9-1/4)                                    |             |            | 1416 (55-3/4)                       |            |          | -     |        |      |
|  | Width   | mm(inch)                              | 1275 (50-3/16)                                 |             |            | 940 (37-1/32)                       |            |          | -     |        |      |
|  | Depth   | mm(inch)                              | 690 (27-5/32)                                  |             |            | 340 (13-13/32)                      |            |          | -     |        |      |
| Packing dimension  | Height  | mm(inch)                              | 360  |             |            | 1556                                |            |          | -     |        |      |
|  | Width   | mm(inch)                              | 1340   |             |            | 1055                                |            |          | -     |        |      |
|  | Depth   | mm(inch)                              | 820  |             |            | 485                                 |            |          | -     |        |      |
| Weight   | (NET)   | kg(lb)                                | 33 (73)  |             |            | 98 (216)                            |            |          | -     |        |      |
|  | (GROSS)   | kg(lb)                                | 42 (93)  |             |            | 108 (238)                           |            |          | -     |        |      |
| Layers limit (actually)                                    |   |                                       | 9 (10)   |             |            | 1 (2)                               |            |          | -     |        |      |
| Operation condition  |   | Cool (DBT)                            | 18°C ~ 32°C                                    |             |            | -15°C ~ 46°C                        |            |          | -     |        |      |
|  |   | Heat (DBT)                            | 16°C ~ 30°C                                    |             |            | -20°C ~ 24°C                        |            |          | -     |        |      |
| P<br>I<br>P<br>I<br>N<br>G                                 | Pipe diameter mm (inch)                             |                                       | (Liquid)ø9.52(3/8) (Gas)ø15.88(5/8)            |             |            | (Liquid)ø9.52(3/8) (Gas)ø15.88(5/8) |            |          | -     |        |      |
|  | Connecting method, Standard length m(ft)            |                                       | flared type, 5.0(16.4)                         |             |            | flared type, 5.0(16.4)              |            |          | -     |        |      |
|  | Pipe length range m (ft)                            |                                       | 5 ~ 75 (16.4 ~ 246.1)                          |             |            |                                     |            |          | -     |        |      |
|  | Indoor unit & Outdoor unit height difference m (ft) |                                       | 15 (OD located lower) / 30 (OD located higher) |             |            | (49.2/98.4)                         |            |          | -     |        |      |
|  | Add gas amount g/m (oz/ft)                          |                                       | 50 (0.538)                                     |             |            |                                     |            |          | -     |        |      |
| Pipe length for additional gas m (ft)                      |   | 30 (98.4)                             |  |             |            |                                     |            | -        |       |        |      |

\*1: In case it is necessary to indicate the air flow volume in (l/s), the value in (m³/min.) shall be multiplied by 16.7 and rounded down the decimal point.

\*2: If the EUROVENT Certified models can be operated under the "extra-low" temperature condition, -7°C dry bulb and -8°C wet-bulb temperatures with rated voltage 230 V shall be used.

\*3: Network Impedance shall be applicable for EUROPE and CHINA models.

\*4: The annual consumption is calculated by multiplying the input power at 230 V (400 V) by an average of 500 hours per year in cooling mode.

\*5: EER and COP classification is at 230 V (400 V) only in accordance with EU directive 2002/31/EC.

\*6: SEER and SCOP classification is at 230V(400V) only in accordance with EN-14825. For heating, SCOP indicates the value of only Average heating season.

# Single -Type

## 1-1. Unit Specifications

PE1

### 2. Ceiling Type S-100PT2E5A / U-100PE1E8A

|                                       |   |   |  |         |                                       |                                     |           |          |       |        |
|---------------------------------------|---|---|--|---------|---------------------------------------|-------------------------------------|-----------|----------|-------|--------|
| INDOOR                                |   | MODEL                                     | S-100PT2E5A                                    |         |                                       |                                     |           |          | -     | -      |
| PANEL                                 |   | MODEL                                     | -  |         |                                       |                                     |           |          | -     | -      |
| OUTDOOR                               |   | MODEL                                     | -  |         |                                       | U-100PE1E8A                         |           |          | -     | -      |
| Branch pipe                           |   | MODEL                                     | -  |         |                                       |                                     |           |          | -     | -      |
| Performance test condition            |   |   |  |         | ISO5151 / EN14511 / EN14825 / EN12102 |                                     |           |          |       |        |
| Power supply                          |   | Ø, Hz                                     | 1ø 50Hz  |         |                                       | 3ø 50Hz                             |           |          | Min   | Max    |
|                                       |   | V   | 220  | 230     | 240                                   | 380                                 | 400       | 415      |       |        |
| C<br>O<br>O<br>L<br>I<br>N<br>G       | Capacity  | kW  | 10.0   | 10.0    | 10.0                                  | -                                   | -         | -        | 3.3   | 12.5   |
|                                       |   | BTU/h                                     | 34100  | 34100   | 34100                                 | -                                   | -         | -        | 11300 | 42700  |
|                                       | Current   | A   | 0.69   | 0.67    | 0.65                                  | 3.95                                | 3.75      | 3.65     | -     | -      |
|                                       |   | W   | 80   | 80      | 80                                    | 2.450k                              | 2.450k    | 2.450k   | -     | -      |
|                                       | Input power   | TOTAL W                                   | -  | -       | -                                     | 2.530k                              | 2.530k    | 2.530k   | 840   | 3.850k |
|                                       |   | Annual consumption                        | TOTAL kWh *4                                   | -       | -                                     | -                                   | -         | 1265     | -     | -      |
|                                       | EER/EER CLASS                                       | TOTAL (W/W) <sup>*5</sup> ("A"~"G")       | -  | -       | -                                     | 3.95                                | 3.95 / A  | 3.95     | 3.93  | 3.25   |
|                                       | Erp <sup>*6</sup>                                   | Pdesign                                   | kW   | -       | -                                     | -                                   | -         | 10.0     | -     | -      |
|                                       |   | SEER                                      | (W/W)  | -       | -                                     | -                                   | -         | 6.6      | -     | -      |
|                                       |   | Annual consumption                        | kWh  | -       | -                                     | -                                   | -         | 531      | -     | -      |
| Class                                 |   |   | -  | -       | -                                     | -                                   | A++       | -        | -     |        |
| Power factor                          | %   | -   | -  | -       | 94                                    | 94                                  | 93        | -        | -     |        |
| Noise indoor                          | dB-A (H/M/L)  | 42/37/35                                  |  |         | -                                     | -                                   | -         | -        | -     |        |
|                                       | Power Level dB                                      | 60/55/53                                  |  |         | -                                     | -                                   | -         | -        | -     |        |
| Noise outdoor                         | dB-A (H/L)  | -   |  |         | 52/-                                  |                                     |           | -        | -     |        |
|                                       | Power Level dB                                      | -   |  |         | 69/-                                  |                                     |           | -        | -     |        |
| H<br>E<br>A<br>T<br>I<br>N<br>G       | Capacity  | kW  | 11.2   | 11.2    | 11.2                                  | -                                   | -         | -        | 4.1   | 14.0   |
|                                       |   | BTU/h                                     | 38200  | 38200   | 38200                                 | -                                   | -         | -        | 14000 | 47800  |
|                                       | Current   | A   | 0.69   | 0.67    | 0.65                                  | 4.05                                | 3.85      | 3.75     | -     | -      |
|                                       |   | W   | 80   | 80      | 80                                    | 2.520k                              | 2.520k    | 2.520k   | -     | -      |
|                                       | Input power   | TOTAL W                                   | -  | -       | -                                     | 2.600k                              | 2.600k    | 2.600k   | 900   | 4.400k |
|                                       |   | COP/COP CLASS                             | TOTAL (W/W) <sup>*5</sup> ("A"~"G")            | -       | -                                     | -                                   | 4.31      | 4.31 / A | 4.31  | 4.56   |
|                                       | Erp <sup>*6</sup>                                   | Pdesign at -10°C                          | kW   | -       | -                                     | -                                   | -         | 10.0     | -     | -      |
|                                       |   | Tbivalent                                 | °C   | -       | -                                     | -                                   | -         | -10      | -     | -      |
|                                       |   | SCOP                                      | (W/W)  | -       | -                                     | -                                   | -         | 4.3      | -     | -      |
|                                       |   | Annual consumption                        | kWh  | -       | -                                     | -                                   | -         | 3256     | -     | -      |
| Class                                 |   | -   | -  | -       | -                                     | A+                                  | -         | -        |       |        |
| Power factor                          | %   | -   | -  | -       | 95                                    | 94                                  | 93        | -        | -     |        |
| Noise indoor                          | dB-A (H/M/L)  | 42/37/35                                  |  |         | -                                     | -                                   | -         | -        | -     |        |
|                                       | Power Level dB                                      | 60/55/53                                  |  |         | -                                     | -                                   | -         | -        | -     |        |
| Noise outdoor                         | dB-A (H/L)  | -   |  |         | 52/-                                  |                                     |           | -        | -     |        |
|                                       | Power Level dB                                      | -   |  |         | 69/-                                  |                                     |           | -        | -     |        |
| EXTRA LOW TEMP                        |   | Total capacity(kW) / Input power(W) / COP | -  |         |                                       | -                                   |           |          | -     | -      |
| Max Current(A) / Max Input power(W)   |   | 0.69/80                                   | 0.67/80  | 0.65/80 | 9.0/5.63k                             | 9.0/5.86k                           | 9.0/6.02k | -        | -     |        |
| Starting current(A) / Comp output(W)  |   | -   | -  | -       | 4.05/3.0k                             | 3.85/3.0k                           | 3.75/3.0k | -        | -     |        |
| Network Impedance(ΩMAX.)              |   | -   |  |         | -                                     |                                     |           | -        | -     |        |
| Fan motor output (Indoor/Outdoor) W   |   | 111                                       |  |         | 90×2                                  |                                     |           | -        | -     |        |
| Moisture removal volume               |   | L/h(Pt/h)                                 | 6.0  | (12.6)  | -                                     |                                     |           | -        | -     |        |
| External static pressure              |   | Pa  | -  |         |                                       | -                                   |           |          | -     | -      |
| Indoor Air flow                       | Cooling   | m³/min (ft³/min)                          | 30/25/23 (1059/883/812)                        |         |                                       | -                                   |           |          | -     | -      |
|                                       | Heating   | m³/min (ft³/min)                          | 30/25/23 (1059/883/812)                        |         |                                       | -                                   |           |          | -     | -      |
| Outdoor Air flow                      | Cooling   | m³/min (ft³/min)                          | -  |         |                                       | 110                                 | (3885)    | -        | -     |        |
|                                       | Heating   | m³/min (ft³/min)                          | -  |         |                                       | 95                                  | (3355)    | -        | -     |        |
| Refrigerant type / amount g(oz)       |   | -   |  |         | R410A                                 | 3.40k                               | (119.9)   | -        | -     |        |
| Product dimension                     | Height  | mm(inch)                                  | 235 (9-1/4)                                    |         |                                       | 1416 (55-3/4)                       |           |          | -     | -      |
|                                       | Width   | mm(inch)                                  | 1590 (62-19/32)                                |         |                                       | 940 (37-1/32)                       |           |          | -     | -      |
|                                       | Depth   | mm(inch)                                  | 690 (27-5/32)                                  |         |                                       | 340 (13-13/32)                      |           |          | -     | -      |
| Packing dimension                     | Height  | mm(inch)                                  | 360  |         |                                       | 1556                                |           |          | -     | -      |
|                                       | Width   | mm(inch)                                  | 1655   |         |                                       | 1055                                |           |          | -     | -      |
|                                       | Depth   | mm(inch)                                  | 820  |         |                                       | 485                                 |           |          | -     | -      |
| Weight                                | (NET)   | kg(lb)                                    | 40 (88)  |         |                                       | 98 (216)                            |           |          | -     | -      |
|                                       | (GROSS)   | kg(lb)                                    | 49 (108)                                       |         |                                       | 108 (238)                           |           |          | -     | -      |
| Layers limit (actually)               |   |   | 9 (10)   |         |                                       | 1 (2)                               |           |          | -     | -      |
| Operation condition                   |   | Cool (DBT)                                | 18°C ~ 32°C                                    |         |                                       | -15°C ~ 46°C                        |           |          | -     | -      |
|                                       |   | Heat (DBT)                                | 16°C ~ 30°C                                    |         |                                       | -20°C ~ 24°C                        |           |          | -     | -      |
| P<br>I<br>P<br>I<br>N<br>G            | Pipe diameter mm (inch)                             |   | (Liquid)ø9.52(3/8) (Gas)ø15.88(5/8)            |         |                                       | (Liquid)ø9.52(3/8) (Gas)ø15.88(5/8) |           |          | -     | -      |
|                                       | Connecting method, Standard length m(ft)            |   | flared type, 5.0(16.4)                         |         |                                       | flared type, 5.0(16.4)              |           |          | -     | -      |
|                                       | Pipe length range m (ft)                            |   | 5 ~ 75 (16.4 ~ 246.1)                          |         |                                       |                                     |           |          | -     | -      |
|                                       | Indoor unit & Outdoor unit height difference m (ft) |   | 15 (OD located lower) / 30 (OD located higher) |         |                                       | (49.2/98.4)                         |           |          | -     | -      |
|                                       | Add gas amount g/m (oz/ft)                          |   | 50 (0.538)                                     |         |                                       |                                     |           |          | -     | -      |
| Pipe length for additional gas m (ft) |   | 30 (98.4)                                 |  |         |                                       |                                     |           | -        | -     |        |

\*1: In case it is necessary to indicate the air flow volume in (l/s), the value in (m³/min.) shall be multiplied by 16.7 and rounded down the decimal point.

\*2: If the EUROVENT Certified models can be operated under the "extra-low" temperature condition, -7°C dry bulb and -8°C wet-bulb temperatures with rated voltage 230 V shall be used.

\*3: Network Impedance shall be applicable for EUROPE and CHINA models.

\*4: The annual consumption is calculated by multiplying the input power at 230 V (400 V) by an average of 500 hours per year in cooling mode.

\*5: EER and COP classification is at 230 V (400 V) only in accordance with EU directive 2002/31/EC.

\*6: SEER and SCOP classification is at 230V(400V) only in accordance with EN-14825. For heating, SCOP indicates the value of only Average heating season, Other fiche data indicates in an attached sheet.

# Single -Type

## 1-1. Unit Specifications

**PE1**

## 2. Ceiling Type S-125PT2E5A / U-125PE1E8A

| INDOOR  |  | MODEL  | S-125PT2E5A                         |                       |                                     | -              |            |          | -     |        |      |
|---|--|--|-------------------------------------|-----------------------|-------------------------------------|----------------|------------|----------|-------|--------|------|
| PANEL   |  | MODEL  | -                                   |                       |                                     | -              |            |          | -     |        |      |
| OUTDOOR   |  | MODEL  | -                                   |                       |                                     | U-125PE1E8A    |            |          | -     |        |      |
| Branch pipe   |  | MODEL  | -                                   |                       |                                     | -              |            |          | -     |        |      |
| Performance test condition  |  | ISO5151 / EN14511 / EN12102 / EN14825          |                                     |                       |                                     |                |            |          |       |        |      |
| Power supply  |  | Ø, Hz  | 1ø 50Hz                             |                       |                                     | 3ø 50Hz        |            |          |       |        |      |
|   |  | V  | 220                                 | 230                   | 240                                 | 380            | 400        | 415      | Min   | Max    |      |
| C<br>O<br>O<br>L<br>I<br>N<br>G                                       | Capacity                                 | kW   | 12.5                                | 12.5                  | 12.5                                | -              | -          | -        | 3.3   | 14.0   |      |
|   |  | BTU/h  | 42700                               | 42700                 | 42700                               | -              | -          | -        | 11300 | 47800  |      |
|   | Current                                  | A  | 0.89                                | 0.86                  | 0.83                                | 5.85           | 5.55       | 5.35     | -     | -      |      |
|   |  | W  | 110                                 | 110                   | 110                                 | 3.620k         | 3.620k     | 3.620k   | -     | -      |      |
|   | Input power                              | TOTAL W  | -                                   |                       |                                     | 3.730k         | 3.730k     | 3.730k   | 840   | 4.860k |      |
|   |  | Annual consumption                             | TOTAL kWh *4                        | -                     |                                     |                | -          | 1865     | -     | -      | -    |
|   | EER/EER CLASS                            | TOTAL (W/W) <sup>*5</sup> ("A"~"G")            | -                                   | -                     | -                                   | 3.35           | 3.35 / A   | 3.35     | 3.93  | 2.88   |      |
|   | Erp <sup>*6</sup>                        | Pdesign  | kW                                  | -                     | -                                   | -              | -          | 12.5     | -     | -      | -    |
|   |  | η <sub>s,c</sub>                               | %                                   | -                     | -                                   | -              | -          | 226.7    | -     | -      | -    |
|   |  | Annual consumption                             | kWh                                 | -                     | -                                   | -              | -          | -        | -     | -      | -    |
| Class   |  |  | -                                   | -                     | -                                   | -              | -          | -        | -     | -      |      |
| Power factor  | %  | -  | -                                   | -                     | 94                                  | 94             | 94         | -        | -     |        |      |
| Noise indoor  | dB-A (H/M/L)                             | 46/40/36                                       |                                     |                       | -                                   | -              | -          | -        | -     |        |      |
|   | Power Level dB                           | 64/58/54                                       |                                     |                       | -                                   | -              | -          | -        | -     |        |      |
| Noise outdoor   | dB-A (H/L)                               | -  |                                     |                       | 53/-                                |                |            | -        | -     |        |      |
|   | Power Level dB                           | -  |                                     |                       | 70/-                                |                |            | -        | -     |        |      |
| H<br>E<br>A<br>T<br>I<br>N<br>G                                       | Capacity                                 | kW   | 14.0                                | 14.0                  | 14.0                                | -              | -          | -        | 4.1   | 16.0   |      |
|   |  | BTU/h  | 47800                               | 47800                 | 47800                               | -              | -          | -        | 14000 | 54600  |      |
|   | Current                                  | A  | 0.89                                | 0.86                  | 0.83                                | 5.50           | 5.20       | 5.05     | -     | -      |      |
|   |  | W  | 110                                 | 110                   | 110                                 | 3.400k         | 3.400k     | 3.400k   | -     | -      |      |
|   | Input power                              | TOTAL W  | -                                   |                       |                                     | 3.510k         | 3.510k     | 3.510k   | 900   | 5.210k |      |
|   |  | COP/COP CLASS                                  | TOTAL (W/W) <sup>*5</sup> ("A"~"G") | -                     | -                                   | -              | 3.99       | 3.99 / A | 3.99  | 4.56   | 3.07 |
|   | Erp <sup>*6</sup>                        | Pdesign at -10°C                               | kW                                  | -                     | -                                   | -              | -          | 12.5     | -     | -      | -    |
|   |  | Tbivalent                                      | °C                                  | -                     | -                                   | -              | -          | -10      | -     | -      | -    |
|   |  | η <sub>s,h</sub>                               | %                                   | -                     | -                                   | -              | -          | 149.5    | -     | -      | -    |
|   |  | Annual consumption                             | kWh                                 | -                     | -                                   | -              | -          | -        | -     | -      | -    |
| Class   |  | -  | -                                   | -                     | -                                   | -              | -          | -        | -     |        |      |
| Power factor  | %  | -  | -                                   | -                     | 94                                  | 94             | 94         | -        | -     |        |      |
| Noise indoor  | dB-A (H/M/L)                             | 46/40/36                                       |                                     |                       | -                                   | -              | -          | -        | -     |        |      |
|   | Power Level dB                           | 64/58/54                                       |                                     |                       | -                                   | -              | -          | -        | -     |        |      |
| Noise outdoor   | dB-A (H/L)                               | -  |                                     |                       | 53/-                                |                |            | -        | -     |        |      |
|   | Power Level dB                           | -  |                                     |                       | 70/-                                |                |            | -        | -     |        |      |
| EXTRA LOW TEMP <sup>†</sup> Total capacity(kW) / Input power(W) / COP |  | -  |                                     |                       |                                     |                |            |          |       |        |      |
| Max Current(A) / Max Input power(W)                                   |  | 0.89/110                                       | 0.86/110                            | 0.83/110              | 10.0/6.19k                          | 10.0/6.51k     | 10.0/6.75k | -        |       |        |      |
| Starting current(A) / Comp output(W)                                  |  | -  | -                                   | -                     | 5.85/3.0k                           | 5.55/3.0k      | 5.35/3.0k  | -        |       |        |      |
| Network Impedance(ΩMAX.)  |  | -  |                                     |                       |                                     |                |            |          |       |        |      |
| Fan motor output (Indoor/Outdoor) W                                   |  | 111  |                                     |                       | 90×2                                |                |            | -        |       |        |      |
| Moisture removal volume   |  | L/h(Pt/h)                                      | 7.9                                 | (16.6)                |                                     | -              |            |          | -     |        |      |
| External static pressure  |  | Pa   | -                                   |                       |                                     | -              |            |          | -     |        |      |
| Indoor Air flow   | Cooling                                  | m³/min (ft³/min)                               | 34/28/24 (1201/989/848)             |                       |                                     | -              |            |          | -     |        |      |
|   | Heating                                  | m³/min (ft³/min)                               | 34/28/24 (1201/989/848)             |                       |                                     | -              |            |          | -     |        |      |
| Outdoor Air flow  | Cooling                                  | m³/min (ft³/min)                               | -                                   |                       |                                     | 130            | (4591)     |          | -     |        |      |
|   | Heating                                  | m³/min (ft³/min)                               | -                                   |                       |                                     | 110            | (3885)     |          | -     |        |      |
| Refrigerant type / amount g(oz)                                       |  | -  |                                     |                       | R410A                               | 3.40k          | (119.9)    |          | -     |        |      |
| Product dimension   | Height                                   | mm(inch)                                       | 235 (9-1/4)                         |                       |                                     | 1416 (55-3/4)  |            |          | -     |        |      |
|   | Width                                    | mm(inch)                                       | 1590 (62-19/32)                     |                       |                                     | 940 (37-1/32)  |            |          | -     |        |      |
|   | Depth                                    | mm(inch)                                       | 690 (27-5/32)                       |                       |                                     | 340 (13-13/32) |            |          | -     |        |      |
| Packing dimension   | Height                                   | mm(inch)                                       | 360                                 |                       |                                     | 1556           |            |          | -     |        |      |
|   | Width                                    | mm(inch)                                       | 1655                                |                       |                                     | 1055           |            |          | -     |        |      |
|   | Depth                                    | mm(inch)                                       | 820                                 |                       |                                     | 485            |            |          | -     |        |      |
| Weight  | (NET)                                    | kg(lb)   | 40 (88)                             |                       |                                     | 98 (216)       |            |          | -     |        |      |
|   | (GROSS)                                  | kg(lb)   | 49 (108)                            |                       |                                     | 108 (238)      |            |          | -     |        |      |
| Layers limit (actually)   |  | 9 (10)   |                                     |                       | 1 (2)                               |                |            | -        |       |        |      |
| Operation condition   | Cool (DBT)                               | 18°C ~ 32°C                                    |                                     |                       | -15°C ~ 46°C                        |                |            | -        |       |        |      |
|   | Heat (DBT)                               | 16°C ~ 30°C                                    |                                     |                       | -20°C ~ 24°C                        |                |            | -        |       |        |      |
| P<br>I<br>P<br>I<br>N<br>G  | Pipe diameter mm (inch)                  | (Liquid)ø9.52(3/8) (Gas)ø15.88(5/8)            |                                     |                       | (Liquid)ø9.52(3/8) (Gas)ø15.88(5/8) |                |            | -        |       |        |      |
|   | Connecting method, Standard length m(ft) | flared type, 5.0(16.4)                         |                                     |                       | flared type, 5.0(16.4)              |                |            | -        |       |        |      |
| Pipe length range   |  | m (ft)   |                                     | 5 ~ 75 (16.4 ~ 246.1) |                                     | -              |            |          |       |        |      |
| Indoor unit & Outdoor unit height difference m (ft)                   |  | 15 (OD located lower) / 30 (OD located higher) |                                     |                       | (49.2/98.4)                         |                |            | -        |       |        |      |
| Add gas amount g/m (oz/ft)  |  | 50 (0.538)                                     |                                     |                       | -                                   |                |            | -        |       |        |      |
| Pipe length for additional gas  |  | m (ft)   |                                     | 30 (98.4)             |                                     | -              |            |          |       |        |      |

\*1: In case it is necessary to indicate the air flow volume in (l/s), the value in (m³/min.) shall be multiplied by 16.7 and rounded down the decimal point.

\*2: If the EUROVENT Certified models can be operated under the "extra-low" temperature condition, -7°C dry bulb and -8°C wet-bulb temperatures with rated voltage 230 V shall be used.

\*3: Network Impedance shall be applicable for EUROPE and CHINA models.

\*4: The annual consumption is calculated by multiplying the input power at 230 V (400 V) by an average of 500 hours per year in cooling mode.

\*5: EER and COP classification is at 230 V (400 V) only in accordance with EU directive 2002/31/EC.

\*6: SEER and SCOP classification is at 230V(400V) only in accordance with EN-14825. For heating, SCOP indicates the value of only Average heating season.

# Single -Type

## 1-1. Unit Specifications

**PE1**

### 2. Ceiling Type S-140PT2E5A / U-140PE1E8A

| INDOOR  |  | MODEL  | S-140PT2E5A                        |                       |                                     | -              |            |          | -     |        |      |
|---|--|--|------------------------------------|-----------------------|-------------------------------------|----------------|------------|----------|-------|--------|------|
| PANEL   |  | MODEL  | -                                  |                       |                                     | -              |            |          | -     |        |      |
| OUTDOOR   |  | MODEL  | -                                  |                       |                                     | U-140PE1E8A    |            |          | -     |        |      |
| Branch pipe   |  | MODEL  | -                                  |                       |                                     | -              |            |          | -     |        |      |
| Performance test condition  |  | ISO5151 / EN14511 / EN12102 / EN14825          |                                    |                       |                                     |                |            |          |       |        |      |
| Power supply  |  | Ø, Hz  | 1ø 50Hz                            |                       |                                     | 3ø 50Hz        |            |          | Min   | Max    |      |
|   |  | V  | 220                                | 230                   | 240                                 | 380            | 400        | 415      |       |        |      |
| C<br>O<br>O<br>L<br>I<br>N<br>G                                       | Capacity                                 | kW   | 14.0                               | 14.0                  | 14.0                                | -              | -          | -        | 3.3   | 15.0   |      |
|   |  | BTU/h  | 47800                              | 47800                 | 47800                               | -              | -          | -        | 11300 | 51200  |      |
|   | Current                                  | A  | 0.94                               | 0.91                  | 0.88                                | 7.30           | 6.95       | 6.70     | -     | -      |      |
|   |  | W  | 120                                | 120                   | 120                                 | 4.530k         | 4.530k     | 4.530k   | -     | -      |      |
|   | Input power                              | TOTAL W  | -                                  |                       |                                     | 4.650k         | 4.650k     | 4.650k   | 840   | 5.650k |      |
|   |  | Annual consumption                             | TOTAL kWh *4                       | -                     |                                     |                | -          | 2325     | -     | -      | -    |
|   | EER/EER CLASS                            | TOTAL (W/W) <sup>5</sup> ("A"~"G")             | -                                  | -                     | -                                   | 3.01           | 3.01 / B   | 3.01     | 3.93  | 2.65   |      |
|   | Erp <sup>6</sup>                         | Pdesign  | kW                                 | -                     | -                                   | -              | -          | 14.0     | -     | -      | -    |
|   |  | η <sub>s,c</sub>                               | %                                  | -                     | -                                   | -              | -          | 210.7    | -     | -      | -    |
|   |  | Annual consumption                             | kWh                                | -                     | -                                   | -              | -          | -        | -     | -      | -    |
| Class   |  |  | -                                  | -                     | -                                   | -              | -          | -        | -     | -      |      |
| Power factor  | %  | -  | -                                  | -                     | 94                                  | 94             | 94         | -        | -     |        |      |
| Noise indoor  | dB-A (H/M/L)                             | 47/41/37                                       |                                    |                       | -                                   | -              | -          | -        | -     |        |      |
|   | Power Level dB                           | 65/59/55                                       |                                    |                       | -                                   | -              | -          | -        | -     |        |      |
| Noise outdoor   | dB-A (H/L)                               | -  |                                    |                       | 54/-                                |                |            | -        | -     |        |      |
|   | Power Level dB                           | -  |                                    |                       | 71/-                                |                |            | -        | -     |        |      |
| H<br>E<br>A<br>T<br>I<br>N<br>G                                       | Capacity                                 | kW   | 16.0                               | 16.0                  | 16.0                                | -              | -          | -        | 4.1   | 18.0   |      |
|   |  | BTU/h  | 54600                              | 54600                 | 54600                               | -              | -          | -        | 14000 | 61400  |      |
|   | Current                                  | A  | 0.94                               | 0.91                  | 0.88                                | 6.85           | 6.50       | 6.25     | -     | -      |      |
|   |  | W  | 120                                | 120                   | 120                                 | 4.240k         | 4.240k     | 4.240k   | -     | -      |      |
|   | Input power                              | TOTAL W  | -                                  |                       |                                     | 4.360k         | 4.360k     | 4.360k   | 900   | 5.930k |      |
|   |  | COP/COP CLASS                                  | TOTAL (W/W) <sup>5</sup> ("A"~"G") | -                     | -                                   | -              | 3.67       | 3.67 / A | 3.67  | 4.56   | 3.04 |
|   | Erp <sup>6</sup>                         | Pdesign at -10°C                               | kW                                 | -                     | -                                   | -              | -          | 14.0     | -     | -      | -    |
|   |  | Tbivalent                                      | °C                                 | -                     | -                                   | -              | -          | -7       | -     | -      | -    |
|   |  | η <sub>s,h</sub>                               | %                                  | -                     | -                                   | -              | -          | 145.0    | -     | -      | -    |
|   |  | Annual consumption                             | kWh                                | -                     | -                                   | -              | -          | -        | -     | -      | -    |
| Class   |  | -  | -                                  | -                     | -                                   | -              | -          | -        | -     |        |      |
| Power factor  | %  | -  | -                                  | -                     | 94                                  | 94             | 94         | -        | -     |        |      |
| Noise indoor  | dB-A (H/M/L)                             | 47/41/37                                       |                                    |                       | -                                   | -              | -          | -        | -     |        |      |
|   | Power Level dB                           | 65/59/55                                       |                                    |                       | -                                   | -              | -          | -        | -     |        |      |
| Noise outdoor   | dB-A (H/L)                               | -  |                                    |                       | 55/-                                |                |            | -        | -     |        |      |
|   | Power Level dB                           | -  |                                    |                       | 71/-                                |                |            | -        | -     |        |      |
| EXTRA LOW TEMP <sup>2</sup> Total capacity(kW) / Input power(W) / COP |  | -  |                                    |                       |                                     |                |            |          |       |        |      |
| Max Current(A) / Max Input power(W)                                   |  | 0.94/120                                       | 0.91/120                           | 0.88/120              | 11.0/6.81k                          | 11.0/7.16k     | 11.0/7.43k | -        |       |        |      |
| Starting current(A) / Comp output(W)                                  |  | -  | -                                  | -                     | 7.30/3.0k                           | 6.95/3.0k      | 6.70/3.0k  | -        |       |        |      |
| Network Impedance(ΩMAX.)  |  | -  |                                    |                       |                                     |                |            |          |       |        |      |
| Fan motor output (Indoor/Outdoor) W                                   |  | 111  |                                    |                       | 90×2                                |                |            | -        |       |        |      |
| Moisture removal volume   |  | L/h(Pt/h)                                      | 9.0                                | (18.9)                |                                     | -              |            |          | -     |        |      |
| External static pressure  |  | Pa   | -                                  |                       |                                     | -              |            |          | -     |        |      |
| Indoor Air flow   | Cooling                                  | m³/min (ft³/min)                               | 35/29/25 (1236/1024/883)           |                       |                                     | -              |            |          | -     |        |      |
|   | Heating                                  | m³/min (ft³/min)                               | 35/29/25 (1236/1024/883)           |                       |                                     | -              |            |          | -     |        |      |
| Outdoor Air flow  | Cooling                                  | m³/min (ft³/min)                               | -                                  |                       |                                     | 135            | (4767)     |          | -     |        |      |
|   | Heating                                  | m³/min (ft³/min)                               | -                                  |                       |                                     | 120            | (4238)     |          | -     |        |      |
| Refrigerant type / amount g(oz)                                       |  | -  |                                    |                       | R410A                               | 3.40k          | (119.9)    |          | -     |        |      |
| Product dimension   | Height                                   | mm(inch)                                       | 235 (9-1/4)                        |                       |                                     | 1416 (55-3/4)  |            |          | -     |        |      |
|   | Width                                    | mm(inch)                                       | 1590 (62-19/32)                    |                       |                                     | 940 (37-1/32)  |            |          | -     |        |      |
|   | Depth                                    | mm(inch)                                       | 690 (27-5/32)                      |                       |                                     | 340 (13-13/32) |            |          | -     |        |      |
| Packing dimension   | Height                                   | mm(inch)                                       | 360                                |                       |                                     | 1556           |            |          | -     |        |      |
|   | Width                                    | mm(inch)                                       | 1655                               |                       |                                     | 1055           |            |          | -     |        |      |
|   | Depth                                    | mm(inch)                                       | 820                                |                       |                                     | 485            |            |          | -     |        |      |
| Weight  | (NET)                                    | kg(lb)   | 40 (88)                            |                       |                                     | 98 (216)       |            |          | -     |        |      |
|   | (GROSS)                                  | kg(lb)   | 49 (108)                           |                       |                                     | 108 (238)      |            |          | -     |        |      |
| Layers limit (actually)   |  | 9 (10)   |                                    |                       | 1 (2)                               |                |            | -        |       |        |      |
| Operation condition   | Cool (DBT)                               | 18°C ~ 32°C                                    |                                    |                       | -15°C ~ 46°C                        |                |            | -        |       |        |      |
|   | Heat (DBT)                               | 16°C ~ 30°C                                    |                                    |                       | -20°C ~ 24°C                        |                |            | -        |       |        |      |
| P<br>I<br>P<br>I<br>N<br>G  | Pipe diameter mm (inch)                  | (Liquid)ø9.52(3/8) (Gas)ø15.88(5/8)            |                                    |                       | (Liquid)ø9.52(3/8) (Gas)ø15.88(5/8) |                |            | -        |       |        |      |
|   | Connecting method, Standard length m(ft) | flared type, 5.0(16.4)                         |                                    |                       | flared type, 5.0(16.4)              |                |            | -        |       |        |      |
| Pipe length range   |  | m (ft)   |                                    | 5 ~ 75 (16.4 ~ 246.1) |                                     | -              |            |          |       |        |      |
| Indoor unit & Outdoor unit height difference m (ft)                   |  | 15 (OD located lower) / 30 (OD located higher) |                                    |                       | (49.2/98.4)                         |                |            | -        |       |        |      |
| Add gas amount g/m (oz/ft)  |  | 50 (0.538)                                     |                                    |                       | -                                   |                |            | -        |       |        |      |
| Pipe length for additional gas  |  | m (ft)   |                                    | 30 (98.4)             |                                     | -              |            |          |       |        |      |

\*1: In case it is necessary to indicate the air flow volume in (l/s), the value in (m³/min.) shall be multiplied by 16.7 and rounded down the decimal point.

\*2: If the EUROVENT Certified models can be operated under the "extra-low" temperature condition, -7°C dry bulb and -8°C wet-bulb temperatures with rated voltage 230 V shall be used.

\*3: Network Impedance shall be applicable for EUROPE and CHINA models.

\*4: The annual consumption is calculated by multiplying the input power at 230 V (400 V) by an average of 500 hours per year in cooling mode.

\*5: EER and COP classification is at 230 V (400 V) only in accordance with EU directive 2002/31/EC.

\*6: SEER and SCOP classification is at 230V(400V) only in accordance with EN-14825. For heating, SCOP indicates the value of only Average heating season.

# Single -Type

## 1-1. Unit Specifications

**PE2**

### 3. Wall Mounted Type S-36PK1E5A / U-36PE2E5A

| INDOOR                               |   | MODEL  | S-36PK1E5A                             |            |                                       | -          |            |        | -    |        |      |
|--------------------------------------|---|--|--|------------|---------------------------------------|------------|------------|--------|------|--------|------|
| PANEL                                |   | MODEL  | -                                      |            |                                       | -          |            |        | -    |        |      |
| OUTDOOR                              |   | MODEL  | -                                      |            |                                       | U-36PE2E5A |            |        | -    |        |      |
| Branch pipe                          |   | MODEL  | -                                      |            |                                       | -          |            |        | -    |        |      |
| Performance test condition           |   |  |  |            | ISO5151 / EN14511 / EN12102 / EN14825 |            |            |        |      |        |      |
| Power supply                         |   | Ø, Hz  | 1ø 50Hz                                |            |                                       | 1ø 50Hz    |            |        | Min  | Max    |      |
|                                      |   | V  | 220V                                   | 230V       | 240V                                  | 220V       | 230V       | 240V   |      |        |      |
| C<br>O<br>O<br>L<br>I<br>N<br>G      | Capacity  | kW   | 3.6                                    | 3.6        | 3.6                                   | -          | -          | -      | 1.5  | 4.0    |      |
|                                      |   | BTU/h  | 12300                                  | 12300      | 12300                                 | -          | -          | -      | 5100 | 13600  |      |
|                                      | Current   | A  | 0.20                                   | 0.19       | 0.19                                  | 3.85       | 3.70       | 3.55   | -    | -      |      |
|                                      |   | W  | 16                                     | 17         | 17                                    | 0.774k     | 0.773k     | 0.773k | -    | -      |      |
|                                      | Input power   | TOTAL W  | -                                      |            |                                       | 0.790k     | 0.790k     | 0.790k | 240  | 930    |      |
|                                      |   | Annual consumption                               | TOTAL kWh *4                           | -          |                                       |            | -          | 395    | -    | -      | -    |
|                                      | EER/EER CLASS                                       | TOTAL (W/W) <sup>*5</sup> ("A"~"G")              | -                                      | -          | -                                     | 4.56       | 4.56/A     | 4.56   | 6.25 | 4.30   |      |
|                                      | Erp <sup>*6</sup>                                   | Pdesign  | kW                                     | -          | -                                     | -          | -          | 3.6    | -    | -      | -    |
|                                      |   | SEER   | (W/W)                                  | -          | -                                     | -          | -          | 6.3    | -    | -      | -    |
|                                      |   | Annual consumption                               | kWh                                    | -          | -                                     | -          | -          | 200    | -    | -      | -    |
| Class                                |   |  | -                                      | -          | -                                     | -          | A++        | -      | -    | -      |      |
| Power factor                         | %   | -  | -                                      | -          | 91                                    | 91         | 91         | -      | -    |        |      |
| Noise indoor                         | dB-A (H/M/L)  | 35/31/27   |  |            | -                                     | -          | -          | -      | -    |        |      |
|                                      | Power Level dB                                      | 52/46/41   |  |            | -                                     | -          | -          | -      | -    |        |      |
| Noise outdoor                        | dB-A (H/L)  | -  |  |            | 45/-                                  |            |            | -      | -    |        |      |
|                                      | Power Level dB                                      | -  |  |            | 64/-                                  |            |            | -      | -    |        |      |
| H<br>E<br>A<br>T<br>I<br>N<br>G      | Capacity  | kW   | 4.0                                    | 4.0        | 4.0                                   | -          | -          | -      | 1.5  | 5.0    |      |
|                                      |   | BTU/h  | 13600                                  | 13600      | 13600                                 | -          | -          | -      | 5100 | 17100  |      |
|                                      | Current   | A  | 0.20                                   | 0.19       | 0.19                                  | 4.20       | 4.05       | 3.85   | -    | -      |      |
|                                      |   | W  | 16                                     | 17         | 17                                    | 0.844k     | 0.843k     | 0.843k | -    | -      |      |
|                                      | Input power   | TOTAL W  | -                                      |            |                                       | 0.860k     | 0.860k     | 0.860k | 190  | 1.190k |      |
|                                      |   | COP/COP CLASS                                    | TOTAL (W/W) <sup>*5</sup> ("A"~"G")    | -          | -                                     | -          | 4.65       | 4.65/A | 4.65 | 7.89   | 4.20 |
|                                      | Erp <sup>*6</sup>                                   | Pdesign at -10°C                                 | kW                                     | -          | -                                     | -          | -          | 3.6    | -    | -      | -    |
|                                      |   | Tbivalent  | °C                                     | -          | -                                     | -          | -          | -10    | -    | -      | -    |
|                                      |   | SCOP   | (W/W)                                  | -          | -                                     | -          | -          | 4.2    | -    | -      | -    |
|                                      |   | Annual consumption                               | kWh                                    | -          | -                                     | -          | -          | 1200   | -    | -      | -    |
| Class                                |   | -  | -                                      | -          | -                                     | A+         | -          | -      | -    |        |      |
| Power factor                         | %   | -  | -                                      | -          | 91                                    | 91         | 91         | -      | -    |        |      |
| Noise indoor                         | dB-A (H/M/L)  | 35/31/27   |  |            | -                                     | -          | -          | -      | -    |        |      |
|                                      | Power Level dB                                      | 52/46/41   |  |            | -                                     | -          | -          | -      | -    |        |      |
| Noise outdoor                        | dB-A (H/L)  | -  |  |            | 46/-                                  |            |            | -      | -    |        |      |
|                                      | Power Level dB                                      | -  |  |            | 66/-                                  |            |            | -      | -    |        |      |
| EXTRA LOW TEMP                       |   | Total capacity(kW) / Input power(W) / COP        |  | -          |                                       | -          |            | -      |      |        |      |
| Max Current(A) / Max Input power(W)  |   | 0.20/16  | 0.19/17                                | 0.19/17    | 11.0/2.20k                            | 11.0/2.30k | 11.0/2.40k | -      |      |        |      |
| Starting current(A) / Comp output(W) |   | -  | -                                      | -          | 4.20/1.1k                             | 4.05/1.1k  | 3.85/1.1k  | -      |      |        |      |
| Network Impedance(ΩMAX.)             |   | -  |  | -          |                                       | -          |            | -      |      |        |      |
| Fan motor output (Indoor/Outdoor) W  |   | 47   |  | 60         |                                       | -          |            | -      |      |        |      |
| Moisture removal volume              |   | L/h(Pt/h)  | 2.1                                    | (4.4)      | -                                     |            | -          |        |      |        |      |
| External static pressure             |   | Pa   | -                                      |            | -                                     |            | -          |        |      |        |      |
| Indoor Air flow                      | Cooling   | m³/min (ft³/min)                                 | 11.0 / 9.5 / 7.5 (388) / (335) / (265) |            |                                       | -          |            | -      |      |        |      |
|                                      | Heating   | m³/min (ft³/min)                                 | 11.0 / 9.5 / 7.5 (388) / (335) / 265   |            |                                       | -          |            | -      |      |        |      |
| Outdoor Air flow                     | Cooling   | m³/min (ft³/min)                                 | -                                      |            |                                       | 38         | (1342)     | -      |      |        |      |
|                                      | Heating   | m³/min (ft³/min)                                 | -                                      |            |                                       | 38         | (1342)     | -      |      |        |      |
| Refrigerant type / amount g(oz)      |   | -  |  | R410A      |                                       | 1.40k      | (49.4)     | -      |      |        |      |
| Product dimension                    | Height  | mm(inch)   | 300                                    | (11-1/32)  | 619                                   | (24-3/8)   | -          |        |      |        |      |
|                                      | Width   | mm(inch)   | 1065                                   | (41-15/16) | 799                                   | (31-29/64) | -          |        |      |        |      |
|                                      | Depth   | mm(inch)   | 230                                    | (9-1/32)   | 299                                   | (11-49/64) | -          |        |      |        |      |
| Product dimension (Panel)            |   | H×W×D mm, inch                                   | -                                      |            | -                                     |            | -          |        |      |        |      |
| Packing dimension                    | Height  | mm(inch)   | 310                                    |            | 688                                   |            | -          |        |      |        |      |
|                                      | Width   | mm(inch)   | 1140                                   |            | 931                                   |            | -          |        |      |        |      |
|                                      | Depth   | mm(inch)   | 380                                    |            | 422                                   |            | -          |        |      |        |      |
| Weight                               | (NET)   | kg(lb)   | 13                                     | (29)       | 39                                    | (86)       | -          |        |      |        |      |
|                                      | (GROSS)   | kg(lb)   | 17                                     | (38)       | 44                                    | (97)       | -          |        |      |        |      |
|                                      | Panel (NET)   | kg(lb)   | -                                      |            | -                                     |            | -          |        |      |        |      |
| Layers limit (actually)              |   | 15 (16)  |  | 5 (6)      |                                       | -          |            |        |      |        |      |
| Operation condition                  | Cool (DBT)  | 18°C ~ 32°C                                      |  |            | -15°C ~ 46°C                          |            |            | -      |      |        |      |
|                                      | Heat (DBT)  | 16°C ~ 30°C                                      |  |            | -20°C ~ 24°C                          |            |            | -      |      |        |      |
| P<br>I<br>P<br>E                     | Pipe diameter mm (inch)                             | (Liquid)ø6.35(1/4) (Gas)ø12.7(1/2)               |  |            | (Liquid)ø6.35(1/4) (Gas)ø12.7(1/2)    |            |            | -      |      |        |      |
|                                      | Connecting method, Standard length m(ft)            | flared type, 5.0(16.4)                           |  |            | flared type, 5.0(16.4)                |            |            | -      |      |        |      |
| I<br>N<br>G                          | Pipe length range m (ft)                            | 3 ~ 40m (9.8 ~ 131.2)                            |  |            | -                                     |            |            | -      |      |        |      |
|                                      | Indoor unit & Outdoor unit height difference m (ft) | 15m (OD located lower) / 30m (OD located higher) |  |            | (49.2/98.4)                           |            |            | -      |      |        |      |
| G                                    | Add gas amount g/m (oz/ft)                          | 20g (0.215)                                      |  |            | -                                     |            |            | -      |      |        |      |
|                                      | Pipe length for additional gas m (ft)               | 30m (98.4)                                       |  |            | -                                     |            |            | -      |      |        |      |

\*1: In case it is necessary to indicate the air flow volume in (l/s), the value in (m³/min.) shall be multiplied by 16.7 and rounded down the decimal point.

\*2: If the EUROVENT Certified models can be operated under the "extra-low" temperature condition, -7°C dry bulb and -8°C wet-bulb temperatures with rated voltage 230 V shall be used.

\*3: Network Impedance shall be applicable for EUROPE and CHINA models.

\*4: The annual consumption is calculated by multiplying the input power at 230 V (400 V) by an average of 500 hours per year in cooling mode.

\*5: EER and COP classification is at 230 V (400 V) only in accordance with EU directive 2002/31/EC.

\*6: SEER and SCOP classification is at 230V(400V) only in accordance with EN-14825. For heating, SCOP indicates the value of only Average heating season, Other fiche data indicates in an attached sheet.

# Simultaneous (Twin) -Type

## 1-1. Unit Specifications

PE1

### 3. Wall Mounted Type S-36PK1E5A×2 / U-71PE1E5A

|  |  |  |                                     |             |                                     |                |             |          |      |        |
|--|--|--|-------------------------------------|-------------|-------------------------------------|----------------|-------------|----------|------|--------|
| INDOOR   | MODEL                                    | S-36PK1E5A×2                                   |                                     |             | -                                   |                |             | -        |      |        |
| PANEL  | MODEL                                    | -  |                                     |             | -                                   |                |             | -        |      |        |
| OUTDOOR  | MODEL                                    | -  |                                     |             | U-71PE1E5A                          |                |             | -        |      |        |
| Branch pipe  | MODEL                                    | -  |                                     |             | CZ-P155BK1                          |                |             | -        |      |        |
| Performance test condition                               |  | ISO5151 / EN14511 / EN14825 / EN12102          |                                     |             |                                     |                |             |          |      |        |
| Power supply   |  | Ø, Hz  | 1ø 50Hz                             |             |                                     | 1ø 50Hz        |             |          | Min  | Max    |
|  |  | V  | 220                                 | 230         | 240                                 | 220            | 230         | 240      |      |        |
| C<br>O<br>O<br>L<br>I<br>N<br>G                          | Capacity                                 | kW   | 7.1                                 | 7.1         | 7.1                                 | -              | -           | -        | 2.5  | 8.0    |
|  |  | BTU/h  | 24200                               | 24200       | 24200                               | -              | -           | -        | 8500 | 27300  |
|  | Current                                  | A  | 0.20×2                              | 0.19×2      | 0.19×2                              | 9.75           | 9.40        | 9.10     | -    | -      |
|  |  | W  | 16×2                                | 17×2        | 17×2                                | 2.055k         | 2.055k      | 2.055k   | -    | -      |
|  | Input power                              | TOTAL W  | -                                   |             |                                     | 2.090k         | 2.090k      | 2.090k   | 450  | 2.650k |
|  |  | Annual consumption                             | TOTAL kWh *4                        | -           |                                     |                | -           | 1032.5   | -    | -      |
|  | EER/EER CLASS                            | TOTAL (W/W) <sup>*5</sup> ("A"~"G")            | -                                   | -           | -                                   | 3.40           | 3.40 / A    | 3.40     | 5.56 | 3.02   |
|  | E <sub>rp</sub> <sup>*6</sup>            | Pdesign  | kW                                  | -           | -                                   | -              | -           | 7.1      | -    | -      |
|  |  | SEER   | (W/W)                               | -           | -                                   | -              | -           | 6.6      | -    | -      |
|  |  | Annual consumption                             | kWh                                 | -           | -                                   | -              | -           | 376      | -    | -      |
| Class  |  |  | -                                   | -           | -                                   | -              | A++         | -        | -    |        |
| Power factor   | %  | -  | -                                   | -           | 96                                  | 95             | 94          | -        | -    |        |
| Noise indoor   | dB-A (H/M/L)                             | 35/31/27                                       |                                     |             | -                                   | -              | -           | -        | -    |        |
|  | Power Level dB                           | 52/46/41                                       |                                     |             | -                                   | -              | -           | -        | -    |        |
| Noise outdoor  | dB-A (H/L)                               | -  |                                     |             | 48/-                                |                |             | -        | -    |        |
|  | Power Level dB                           | -  |                                     |             | 65/-                                |                |             | -        | -    |        |
| H<br>E<br>A<br>T<br>I<br>N<br>G                          | Capacity                                 | kW   | 8.0                                 | 8.0         | 8.0                                 | -              | -           | -        | 2.0  | 9.0    |
|  |  | BTU/h  | 27300                               | 27300       | 27300                               | -              | -           | -        | 6800 | 30700  |
|  | Current                                  | A  | 0.20×2                              | 0.19×2      | 0.19×2                              | 9.85           | 9.50        | 9.20     | -    | -      |
|  |  | W  | 16×2                                | 17×2        | 17×2                                | 2.095k         | 2.095k      | 2.095k   | -    | -      |
|  | Input power                              | TOTAL W  | -                                   |             |                                     | 2.130k         | 2.130k      | 2.130k   | 400  | 2.900k |
|  |  | COP/COP CLASS                                  | TOTAL (W/W) <sup>*5</sup> ("A"~"G") | -           | -                                   | -              | 3.76        | 3.76 / A | 3.76 | 5.00   |
|  | E <sub>rp</sub> <sup>*6</sup>            | Pdesign at -10°C                               | kW                                  | -           | -                                   | -              | -           | 7.1      | -    | -      |
|  |  | Tbivalent                                      | °C                                  | -           | -                                   | -              | -           | -8       | -    | -      |
|  |  | SCOP   | (W/W)                               | -           | -                                   | -              | -           | 3.9      | -    | -      |
|  |  | Annual consumption                             | kWh                                 | -           | -                                   | -              | -           | 2548     | -    | -      |
| Class  |  | -  | -                                   | -           | -                                   | A              | -           | -        |      |        |
| Power factor   | %  | -  | -                                   | -           | 97                                  | 96             | 95          | -        | -    |        |
| Noise indoor   | dB-A (H/M/L)                             | 35/31/27                                       |                                     |             | -                                   | -              | -           | -        | -    |        |
|  | Power Level dB                           | 52/46/41                                       |                                     |             | -                                   | -              | -           | -        | -    |        |
| Noise outdoor  | dB-A (H/L)                               | -  |                                     |             | 50/-                                |                |             | -        | -    |        |
|  | Power Level dB                           | -  |                                     |             | 67/-                                |                |             | -        | -    |        |
| EXTRA LOW TEMP Total capacity(kW) / Input power(W) / COP |  | -  |                                     |             |                                     |                |             |          |      |        |
| Max Current(A) / Max Input power(W)                      |  | 0.20×2/16×2                                    | 0.19×2/17×2                         | 0.19×2/17×2 | 18.0/3.800k                         | 18.0/3.930k    | 18.0/4.060k |          |      |        |
| Starting current(A) / Comp output(W)                     |  | -  | -                                   | -           | 9.85/2.0k                           | 9.50/2.0k      | 9.20/2.0k   |          |      |        |
| Network Impedance(ΩMAX.)                                 |  | -  |                                     |             |                                     |                |             |          |      |        |
| Fan motor output (Indoor/Outdoor) W                      |  | 47×2   |                                     |             | 90                                  |                |             |          |      |        |
| Moisture removal volume                                  |  | L/h(Pt/h)                                      | 4.2 (2.1×2)                         |             | (8.8)                               |                |             |          |      |        |
| External static pressure                                 |  | Pa   | -                                   |             |                                     |                |             |          |      |        |
| Indoor Air flow  | Cooling                                  | m³/min (ft³/min)                               | [11/9.5/7.5 (388/335/265)]×2        |             |                                     | -              |             |          | -    | -      |
|  | Heating                                  | m³/min (ft³/min)                               | [11/9.5/7.5 (388/335/265)]×2        |             |                                     | -              |             |          | -    | -      |
| Outdoor Air flow   | Cooling                                  | m³/min (ft³/min)                               | -                                   |             |                                     | 60 (2119)      |             | -        | -    |        |
|  | Heating                                  | m³/min (ft³/min)                               | -                                   |             |                                     | 60 (2119)      |             | -        | -    |        |
| Refrigerant type / amount g(oz)                          |  | -  |                                     |             | R410A                               | 2.35k          | (82.9)      |          |      |        |
| Product dimension  | Height                                   | mm(inch)                                       | 300 (11-1/32)                       |             |                                     | 996 (39-7/32)  |             |          |      |        |
|  | Width                                    | mm(inch)                                       | 1065 (41-15/16)                     |             |                                     | 940 (37-1/32)  |             |          |      |        |
|  | Depth                                    | mm(inch)                                       | 230 (9-1/32)                        |             |                                     | 340 (13-13/32) |             |          |      |        |
| Packing dimension  | Height                                   | mm(inch)                                       | 310                                 |             |                                     | 1136           |             |          |      |        |
|  | Width                                    | mm(inch)                                       | 1140                                |             |                                     | 1055           |             |          |      |        |
|  | Depth                                    | mm(inch)                                       | 380                                 |             |                                     | 485            |             |          |      |        |
| Weight   | (NET)                                    | kg(lb)   | 13 (29)                             |             |                                     | 69 (152)       |             |          |      |        |
|  | (GROSS)                                  | kg(lb)   | 17 (37)                             |             |                                     | 77 (170)       |             |          |      |        |
| Layers limit (actually)                                  |  | 15 (16)  |                                     |             | 2 (3)                               |                |             |          |      |        |
| Operation condition                                      | Cool (DBT)                               | 18°C ~ 32°C                                    |                                     |             | -15°C ~ 46°C                        |                |             |          |      |        |
|  | Heat (DBT)                               | 16°C ~ 30°C                                    |                                     |             | -20°C ~ 24°C                        |                |             |          |      |        |
| P<br>I<br>P<br>I<br>N<br>G                               | Pipe diameter mm (inch)                  | (Liquid)ø6.35(1/4) (Gas)ø12.7(1/2)             |                                     |             | (Liquid)ø9.52(3/8) (Gas)ø15.88(5/8) |                |             |          |      |        |
|  | Connecting method, Standard length m(ft) | flared type, 5.0(16.4)                         |                                     |             | flared type, 5.0(16.4)              |                |             |          |      |        |
| Pipe length range  |  | m (ft)   |                                     |             | 5 ~ 50 (16.4 ~ 164.0)               |                |             |          |      |        |
| Indoor unit & Outdoor unit height difference m (ft)      |  | 15 (OD located lower) / 30 (OD located higher) |                                     |             | (49.2/98.4)                         |                |             |          |      |        |
| Add gas amount g/m (oz/ft)                               |  | 50 (0.538)                                     |                                     |             |                                     |                |             |          |      |        |
| Pipe length for additional gas                           |  | m (ft)   |                                     |             | 30 (98.4)                           |                |             |          |      |        |

\*1: In case it is necessary to indicate the air flow volume in (l/s), the value in (m³/min.) shall be multiplied by 16.7 and rounded down the decimal point.

\*2: If the EUROVENT Certified models can be operated under the "extra-low" temperature condition, -7°C dry bulb and -8°C wet-bulb temperatures with rated voltage 230 V shall be used.

\*3: Network Impedance shall be applicable for EUROPE and CHINA models.

\*4: The annual consumption is calculated by multiplying the input power at 230 V (400 V) by an average of 500 hours per year in cooling mode.

\*5: EER and COP classification is at 230V (400V) only in accordance with EU directive 2002/31/EC.

\*6: SEER and SCOP classification is at 230V (400V) only in accordance with EN-14825. For heating, SCOP indicates the value of only Average heating season, Other fiche data indicates in an attached sheet.

# Simultaneous (Triple) -Type

## 1-1. Unit Specifications

**PE1**

### 3. Wall Mounted Type S-36PK1E5A×3 / U-100PE1E5A

| INDOOR  |   | MODEL  | S-36PK1E5A×3                        |           |                                     |                |             |          |       |        |      |
|---|---|--|-------------------------------------|-----------|-------------------------------------|----------------|-------------|----------|-------|--------|------|
| PANEL   |   | MODEL  |                                     |           |                                     |                |             |          |       |        |      |
| OUTDOOR   |   | MODEL  |                                     |           |                                     | U-100PE1E5A    |             |          |       |        |      |
| Branch pipe   |   | MODEL  |                                     |           |                                     | CZ-P3HPC2      |             |          |       |        |      |
| Performance test condition  |   | ISO5151 / EN14511 / EN14825 / EN12102          |                                     |           |                                     |                |             |          |       |        |      |
| Power supply  |   | Ø, Hz  | 1ø 50Hz                             |           |                                     | 1ø 50Hz        |             |          | Min   | Max    |      |
|   |   | V  | 220                                 | 230       | 240                                 | 220            | 230         | 240      |       |        |      |
| C<br>O<br>O<br>L<br>I<br>N<br>G                                       | Capacity  | kW   | 10.0                                | 10.0      | 10.0                                | -              | -           | -        | 3.3   | 12.5   |      |
|   |   | BTU/h  | 34100                               | 34100     | 34100                               | -              | -           | -        | 11300 | 42700  |      |
|   | Current   | A  | 0.20×3                              | 0.19×3    | 0.19×3                              | 12.0           | 11.4        | 10.9     | -     | -      |      |
|   |   | W  | 16×3                                | 17×3      | 17×3                                | 2.525k         | 2.525k      | 2.520k   | -     | -      |      |
|   | Input power   | TOTAL W  |                                     |           |                                     | 2.575k         | 2.580k      | 2.575k   | 840   | 3.700k |      |
|   |   | Annual consumption                             | TOTAL kWh *4                        |           |                                     |                | -           | 1290     | -     | -      | -    |
|   | EER/EER CLASS                                       | TOTAL (W/W) <sup>*5</sup> ("A"~"G")            | -                                   | -         | -                                   | 3.88           | 3.88 / A    | 3.88     | 3.93  | 3.38   |      |
|   | Erp <sup>*6</sup>                                   | Pdesign  | kW                                  | -         | -                                   | -              | -           | 10.0     | -     | -      | -    |
|   |   | SEER   | (W/W)                               | -         | -                                   | -              | -           | 6.2      | -     | -      | -    |
|   |   | Annual consumption                             | kWh                                 | -         | -                                   | -              | -           | 564      | -     | -      | -    |
| Class   |   |  | -                                   | -         | -                                   | -              | A++         | -        | -     | -      |      |
| Power factor  | %   | -  | -                                   | -         | 96                                  | 96             | 96          | -        | -     |        |      |
| Noise indoor  | dB-A (H/M/L)  | 35/31/27                                       |                                     |           | -                                   | -              | -           | -        | -     |        |      |
|   | Power Level dB                                      | 52/46/41                                       |                                     |           | -                                   | -              | -           | -        | -     |        |      |
| Noise outdoor   | dB-A (H/L)  |  |                                     |           | 52/-                                |                |             | -        | -     |        |      |
|   | Power Level dB                                      |  |                                     |           | 69/-                                |                |             | -        | -     |        |      |
| H<br>E<br>A<br>T<br>I<br>N<br>G                                       | Capacity  | kW   | 11.2                                | 11.2      | 11.2                                | -              | -           | -        | 4.1   | 14.0   |      |
|   |   | BTU/h  | 38200                               | 38200     | 38200                               | -              | -           | -        | 14000 | 47800  |      |
|   | Current   | A  | 0.20×3                              | 0.19×3    | 0.19×3                              | 13.1           | 12.5        | 12.0     | -     | -      |      |
|   |   | W  | 16×3                                | 17×3      | 17×3                                | 2.705k         | 2.705k      | 2.700k   | -     | -      |      |
|   | Input power   | TOTAL W  |                                     |           |                                     | 2.755k         | 2.760k      | 2.755k   | 900   | 4.400k |      |
|   |   | COP/COP CLASS                                  | TOTAL (W/W) <sup>*5</sup> ("A"~"G") | -         | -                                   | -              | 4.07        | 4.06 / A | 4.07  | 4.56   | 3.18 |
|   | Erp <sup>*6</sup>                                   | Pdesign at -10°C                               | kW                                  | -         | -                                   | -              | -           | 10.0     | -     | -      | -    |
|   |   | Tbivalent                                      | °C                                  | -         | -                                   | -              | -           | -10      | -     | -      | -    |
|   |   | SCOP   | (W/W)                               | -         | -                                   | -              | -           | 4.0      | -     | -      | -    |
|   |   | Annual consumption                             | kWh                                 | -         | -                                   | -              | -           | 3500     | -     | -      | -    |
| Class   |   | -  | -                                   | -         | -                                   | A+             | -           | -        | -     |        |      |
| Power factor  | %   | -  | -                                   | -         | 94                                  | 94             | 94          | -        | -     |        |      |
| Noise indoor  | dB-A (H/M/L)  | 35/31/27                                       |                                     |           | -                                   | -              | -           | -        | -     |        |      |
|   | Power Level dB                                      | 52/46/41                                       |                                     |           | -                                   | -              | -           | -        | -     |        |      |
| Noise outdoor   | dB-A (H/L)  |  |                                     |           | 52/-                                |                |             | -        | -     |        |      |
|   | Power Level dB                                      |  |                                     |           | 69/-                                |                |             | -        | -     |        |      |
| EXTRA LOW TEMP <sup>†</sup> Total capacity(kW) / Input power(W) / COP |   |  |                                     |           |                                     |                |             |          |       |        |      |
| Max Current(A) / Max Input power(W)                                   |   | 0.20/16×3                                      | 0.19/17×3                           | 0.19/17×3 | 25.0/5.350k                         | 25.0/5.550k    | 25.0/5.750k |          |       |        |      |
| Starting current(A) / Comp output(W)                                  |   | -  | -                                   | -         | 13.1/3.0k                           | 12.5/3.0k      | 12.0/3.0k   |          |       |        |      |
| Network Impedance(ΩMAX.)  |   |  |                                     |           |                                     |                |             |          |       |        |      |
| Fan motor output (Indoor/Outdoor) W                                   |   | 47×3   |                                     |           | 90×2                                |                |             |          |       |        |      |
| Moisture removal volume   |   | L/h(Pt/h)                                      | 6.0 (2.0×3)                         |           |                                     | (12.6)         |             |          |       |        |      |
| External static pressure  |   | Pa   |                                     |           |                                     |                |             |          |       |        |      |
| Indoor Air flow   | Cooling   | m³/min (ft³/min)                               | [11/9.5/7.5 (388/335/265)]×3        |           |                                     |                |             |          | -     | -      |      |
|   | Heating   | m³/min (ft³/min)                               | [11/9.5/7.5 (388/335/265)]×3        |           |                                     |                |             |          | -     | -      |      |
| Outdoor Air flow  | Cooling   | m³/min (ft³/min)                               |                                     |           |                                     | 110 (3885)     |             | -        | -     |        |      |
|   | Heating   | m³/min (ft³/min)                               |                                     |           |                                     | 95 (3355)      |             | -        | -     |        |      |
| Refrigerant type / amount g(oz)                                       |   |  |                                     |           | R410A                               | 3.40k          | (119.9)     |          |       |        |      |
| Product dimension   | Height  | mm(inch)                                       | 300 (11-1/32)                       |           |                                     | 1416 (55-3/4)  |             |          |       |        |      |
|   | Width   | mm(inch)                                       | 1065 (41-15/16)                     |           |                                     | 940 (37-1/32)  |             |          |       |        |      |
|   | Depth   | mm(inch)                                       | 230 (9-1/32)                        |           |                                     | 340 (13-13/32) |             |          |       |        |      |
| Packing dimension   | Height  | mm(inch)                                       | 310                                 |           |                                     | 1556           |             |          |       |        |      |
|   | Width   | mm(inch)                                       | 1140                                |           |                                     | 1055           |             |          |       |        |      |
|   | Depth   | mm(inch)                                       | 380                                 |           |                                     | 485            |             |          |       |        |      |
| Weight  | (NET)   | kg(lb)   | 13 (29)                             |           |                                     | 98 (216)       |             |          |       |        |      |
|   | (GROSS)   | kg(lb)   | 17 (37)                             |           |                                     | 108 (238)      |             |          |       |        |      |
| Layers limit (actually)   |   | 15 (16)  |                                     |           | 1 (2)                               |                |             |          |       |        |      |
| Operation condition   | Cool (DBT)  | 18°C ~ 32°C                                    |                                     |           | -15°C ~ 46°C                        |                |             |          |       |        |      |
|   | Heat (DBT)  | 16°C ~ 30°C                                    |                                     |           | -20°C ~ 24°C                        |                |             |          |       |        |      |
| P<br>I<br>P<br>I<br>N<br>G  | Pipe diameter mm (inch)                             | (Liquid)ø6.35(1/4) (Gas)ø12.7(1/2)             |                                     |           | (Liquid)ø9.52(3/8) (Gas)ø15.88(5/8) |                |             |          |       |        |      |
|   | Connecting method, Standard length m(ft)            | flared type, 5.0(16.4)                         |                                     |           | flared type, 5.0(16.4)              |                |             |          |       |        |      |
|   | Pipe length range                                   | m (ft)   |                                     |           | 5 ~ 75 (16.4 ~ 246.1)               |                |             |          |       |        |      |
|   | Indoor unit & Outdoor unit height difference m (ft) | 15 (OD located lower) / 30 (OD located higher) |                                     |           | (49.2/98.4)                         |                |             |          |       |        |      |
|   | Add gas amount g/m (oz/ft)                          | 50 (0.538)                                     |                                     |           |                                     |                |             |          |       |        |      |
|   | Pipe length for additional gas                      | m (ft)   |                                     |           | 30 (98.4)                           |                |             |          |       |        |      |

\*1: In case it is necessary to indicate the air flow volume in (l/s), the value in (m³/min.) shall be multiplied by 16.7 and rounded down the decimal point.

\*2: If the EUROVENT Certified models can be operated under the "extra-low" temperature condition, -7°C dry bulb and -8°C wet-bulb temperatures with rated voltage 230 V shall be used.

\*3: Network Impedance shall be applicable for EUROPE and CHINA models.

\*4: The annual consumption is calculated by multiplying the input power at 230 V (400 V) by an average of 500 hours per year in cooling mode.

\*5: EER and COP classification is at 230 V (400 V) only in accordance with EU directive 2002/31/EC.

\*6: SEER and SCOP classification is at 230V(400V) only in accordance with EN-14825. For heating, SCOP indicates the value of only Average heating season, Other fiche data indicates in an attached sheet.



# Single -Type

## 1-1. Unit Specifications

PE2

### 3. Wall Mounted Type S-50PK1E5A / U-50PE2E5A

|                                       |   |   |   |            |                                       |                                    |            |        |            |           |
|---------------------------------------|---|---|---|------------|---------------------------------------|------------------------------------|------------|--------|------------|-----------|
| INDOOR                                |   | MODEL                                     | S-50PK1E5A                                      |            |                                       | -                                  |            |        | -          |           |
| PANEL                                 |   | MODEL                                     | -   |            |                                       | -                                  |            |        | -          |           |
| OUTDOOR                               |   | MODEL                                     | -   |            |                                       | U-50PE2E5A                         |            |        | -          |           |
| Branch pipe                           |   | MODEL                                     | -   |            |                                       | -                                  |            |        | -          |           |
| Performance test condition            |   |   |   |            | ISO5151 / EN14511 / EN12102 / EN14825 |                                    |            |        |            |           |
| Power supply                          |   | Ø, Hz                                     | 1ø 50Hz   |            |                                       | 1ø 50Hz                            |            |        |            |           |
|                                       |   | V   | 220V  | 230V       | 240V                                  | 220V                               | 230V       | 240V   | Min Max    |           |
| C<br>O<br>O<br>L<br>I<br>N<br>G       | Capacity  | kW  | 5.0   | 5.0        | 5.0                                   | -                                  | -          | -      | 1.5 5.6    |           |
|                                       |   | BTU/h                                     | 17100   | 17100      | 17100                                 | -                                  | -          | -      | 5100 19100 |           |
|                                       | Current   | A   | 0.27  | 0.27       | 0.27                                  | 6.65                               | 6.35       | 6.10   | - -        |           |
|                                       |   | W   | 26  | 27         | 28                                    | 1.374k                             | 1.373k     | 1.372k | - -        |           |
|                                       | Input power   | TOTAL W                                   | -   |            |                                       | 1.400k                             | 1.400k     | 1.400k | 240 1.720k |           |
|                                       |   | Annual consumption                        | TOTAL kWh *4                                    | -          |                                       |                                    | -          | 700    | -          | - -       |
|                                       | EER/EER CLASS                                       | TOTAL (W/W) <sup>15</sup> ("A"-G)         | -   | -          | -                                     | 3.57                               | 3.57/A     | 3.57   | 6.25 3.26  |           |
|                                       | E <sub>rp</sub> <sup>*6</sup>                       | Pdesign                                   | kW  | -          | -                                     | -                                  | -          | 5.0    | -          | - -       |
|                                       |   | SEER                                      | (W/W)   | -          | -                                     | -                                  | -          | 6.1    | -          | - -       |
|                                       |   | Annual consumption                        | kWh   | -          | -                                     | -                                  | -          | 287    | -          | - -       |
| Class                                 |   |   | -   | -          | -                                     | -                                  | A++        | -      | - -        |           |
| Power factor                          | %   | -   | -   | -          | 94                                    | 94                                 | 94         | - -    |            |           |
| Noise indoor                          | dB-A (H/M/L)  | 40/36/32                                  |   |            | -                                     | -                                  | -          | - -    |            |           |
|                                       | Power Level dB                                      | 57/51/46                                  |   |            | -                                     | -                                  | -          | - -    |            |           |
| Noise outdoor                         | dB-A (H/L)  | -   |   |            | 46/-                                  |                                    |            | - -    |            |           |
|                                       | Power Level dB                                      | -   |   |            | 65/-                                  |                                    |            | - -    |            |           |
| H<br>E<br>A<br>T<br>I<br>N<br>G       | Capacity  | kW  | 5.6   | 5.6        | 5.6                                   | -                                  | -          | -      | 1.5 6.5    |           |
|                                       |   | BTU/h                                     | 19100   | 19100      | 19100                                 | -                                  | -          | -      | 5100 22200 |           |
|                                       | Current   | A   | 0.27  | 0.27       | 0.27                                  | 7.15                               | 6.85       | 6.55   | - -        |           |
|                                       |   | W   | 26  | 27         | 28                                    | 1.464k                             | 1.463k     | 1.462k | - -        |           |
|                                       | Input power   | TOTAL W                                   | -   |            |                                       | 1.490k                             | 1.490k     | 1.490k | 190 1.920k |           |
|                                       |   | COP/COP CLASS                             | TOTAL (W/W) <sup>15</sup> ("A"-G)               | -          | -                                     | -                                  | 3.76       | 3.76/A | 3.76       | 7.89 3.39 |
|                                       | E <sub>rp</sub> <sup>*6</sup>                       | Pdesign at -10°C                          | kW  | -          | -                                     | -                                  | -          | 5.0    | -          | - -       |
|                                       |   | Tbivalent                                 | °C  | -          | -                                     | -                                  | -          | -7     | -          | - -       |
|                                       |   | SCOP                                      | (W/W)   | -          | -                                     | -                                  | -          | 4.0    | -          | - -       |
|                                       |   | Annual consumption                        | kWh   | -          | -                                     | -                                  | -          | 1749   | -          | - -       |
| Class                                 |   | -   | -   | -          | -                                     | A+                                 | -          | - -    |            |           |
| Power factor                          | %   | -   | -   | -          | 93                                    | 93                                 | 93         | - -    |            |           |
| Noise indoor                          | dB-A (H/M/L)  | 40/36/32                                  |   |            | -                                     | -                                  | -          | - -    |            |           |
|                                       | Power Level dB                                      | 57/51/46                                  |   |            | -                                     | -                                  | -          | - -    |            |           |
| Noise outdoor                         | dB-A (H/L)  | -   |   |            | 48/-                                  |                                    |            | - -    |            |           |
|                                       | Power Level dB                                      | -   |   |            | 68/-                                  |                                    |            | - -    |            |           |
| EXTRA LOW TEMP                        |   | Total capacity(kW) / Input power(W) / COP | -   |            |                                       | -                                  |            |        | -          |           |
| Max Current(A) / Max Input power(W)   |   | 0.27/26                                   | 0.27/27   | 0.27/28    | 12.0/2.46k                            | 12.0/2.57k                         | 12.0/2.68k | -      |            |           |
| Starting current(A) / Comp output(W)  |   | -   | -   | -          | 7.15/1.5k                             | 6.85/1.5k                          | 6.55/1.5k  | -      |            |           |
| Network Impedance(ΩMAX.)              |   | -   |   |            | -                                     |                                    |            | -      |            |           |
| Fan motor output (Indoor/Outdoor) W   |   | 47  |   |            | 60                                    |                                    |            | -      |            |           |
| Moisture removal volume               |   | L/h(Pt/h)                                 | 2.8   | (5.9)      | -                                     |                                    |            | -      |            |           |
| External static pressure              |   | Pa  | -   |            |                                       | -                                  |            |        | -          |           |
| Indoor Air flow                       | Cooling   | m³/min (ft³/min)                          | 14.0 / 12.0 / 10.5 (494) / (424) / (371)        |            |                                       | -                                  |            |        | - -        |           |
|                                       | Heating   | m³/min (ft³/min)                          | 14.0 / 12.0 / 10.5 (494) / (424) / (371)        |            |                                       | -                                  |            |        | - -        |           |
| Outdoor Air flow                      | Cooling   | m³/min (ft³/min)                          | -   |            |                                       | 38                                 | (1342)     | - -    |            |           |
|                                       | Heating   | m³/min (ft³/min)                          | -   |            |                                       | 41                                 | (1448)     | - -    |            |           |
| Refrigerant type / amount g(oz)       |   | -   |   |            | R410A                                 | 1.40k                              | (49.4)     | -      |            |           |
| Product dimension                     | Height  | mm(inch)                                  | 300   | (11-1/32)  | 619                                   | (24-3/8)                           | -          | -      |            |           |
|                                       | Width   | mm(inch)                                  | 1065  | (41-15/16) | 799                                   | (31-29/64)                         | -          | -      |            |           |
|                                       | Depth   | mm(inch)                                  | 230   | (9-1/32)   | 299                                   | (11-49/64)                         | -          | -      |            |           |
| Product dimension (Panel)             |   | HxWxD mm, inch                            | -   |            |                                       | -                                  |            |        | -          |           |
| Packing dimension                     | Height  | mm(inch)                                  | 310   |            |                                       | 688                                |            |        | -          |           |
|                                       | Width   | mm(inch)                                  | 1140  |            |                                       | 931                                |            |        | -          |           |
|                                       | Depth   | mm(inch)                                  | 380   |            |                                       | 422                                |            |        | -          |           |
| Weight                                | (NET)   | kg(lb)                                    | 13  | (29)       | 39                                    | (86)                               | -          | -      |            |           |
|                                       | (GROSS)   | kg(lb)                                    | 17  | (37)       | 44                                    | (97)                               | -          | -      |            |           |
|                                       | Panel (NET)   | kg(lb)                                    | -   |            |                                       | -                                  |            |        | -          |           |
|                                       | Layers limit (actually)                             |   | 15 (16)   |            |                                       | 5 (6)                              |            |        | -          |           |
| Operation condition                   | Cool (DBT)  | 18°C ~ 32°C                               |   |            | -15°C ~ 46°C                          |                                    |            | -      |            |           |
|                                       | Heat (DBT)  | 16°C ~ 30°C                               |   |            | -20°C ~ 24°C                          |                                    |            | -      |            |           |
| P<br>I<br>P<br>E<br>I<br>N<br>G       | Pipe diameter mm (inch)                             |   | (Liquid)ø6.35(1/4) (Gas)ø12.7(1/2)              |            |                                       | (Liquid)ø6.35(1/4) (Gas)ø12.7(1/2) |            |        | -          |           |
|                                       | Connecting method, Standard length m(ft)            |   | flared type, 5.0(16.4)                          |            |                                       | flared type, 5.0(16.4)             |            |        | -          |           |
|                                       | Pipe length range m (ft)                            |   | 3 ~ 40m (9.8 ~ 131.2)                           |            |                                       | -                                  |            |        | -          |           |
|                                       | Indoor unit & Outdoor unit height difference m (ft) |   | 15m (OD located lower) /30m (OD located higher) |            |                                       | (49.2/98.4)                        |            |        | -          |           |
|                                       | Add gas amount g/m (oz/ft)                          |   | 20g (0.215)                                     |            |                                       | -                                  |            |        | -          |           |
| Pipe length for additional gas m (ft) |   | 30m (98.4)                                |   |            | -                                     |                                    |            | -      |            |           |

\*1: In case it is necessary to indicate the air flow volume in (l/s), the value in (m³/min.) shall be multiplied by 16.7 and rounded down the decimal point.  
 \*2: If the EUROVENT Certified models can be operated under the "extra-low" temperature condition, -7°C dry bulb and -8°C wet-bulb temperatures with rated voltage 230 V shall be used.  
 \*3: Network Impedance shall be applicable for EUROPE and CHINA models.  
 \*4: The annual consumption is calculated by multiplying the input power at 230 V (400 V) by an average of 500 hours per year in cooling mode.  
 \*5: EER and COP classification is at 230 V (400 V) only in accordance with EU directive 2002/31/EC.  
 \*6: SEER and SCOP classification is at 230V(400V) only in accordance with EN-14825. For heating, SCOP indicates the value of only Average heating season, Other fiche data indicates in an attached sheet.

# Simultaneous (Twin) -Type

## 1-1. Unit Specifications

**PE1**

### 3. Wall Mounted Type S-50PK1E5A×2 / U-100PE1E5A

| INDOOR  |  | MODEL  | S-50PK1E5A×2                        |                       |                                     | -              |             |          | -     |        |
|---|--|--|-------------------------------------|-----------------------|-------------------------------------|----------------|-------------|----------|-------|--------|
| PANEL   |  | MODEL  | -                                   |                       |                                     | -              |             |          | -     |        |
| OUTDOOR   |  | MODEL  | -                                   |                       |                                     | U-100PE1E5A    |             |          | -     |        |
| Branch pipe   |  | MODEL  | -                                   |                       |                                     | CZ-P155BK1     |             |          | -     |        |
| Performance test condition  |  | ISO5151 / EN14511 / EN14825 / EN12102          |                                     |                       |                                     |                |             |          |       |        |
| Power supply  |  | Ø, Hz  | 1ø 50Hz                             |                       |                                     | 1ø 50Hz        |             |          | Min   | Max    |
|   |  | V  | 220                                 | 230                   | 240                                 | 220            | 230         | 240      |       |        |
| C<br>O<br>O<br>L<br>I<br>N<br>G                                       | Capacity                                 | kW   | 10.0                                | 10.0                  | 10.0                                | -              | -           | -        | 3.3   | 12.5   |
|   |  | BTU/h  | 34100                               | 34100                 | 34100                               | -              | -           | -        | 11300 | 42700  |
|   | Current                                  | A  | 0.27×2                              | 0.27×2                | 0.27×2                              | 12.0           | 11.4        | 10.9     | -     | -      |
|   |  | W  | 26×2                                | 27×2                  | 28×2                                | 2.525k         | 2.525k      | 2.525k   | -     | -      |
|   | Input power                              | TOTAL W  | -                                   |                       |                                     | 2.580k         | 2.580k      | 2.580k   | 840   | 3.700k |
|   |  | Annual consumption                             | TOTAL kWh *4                        | -                     |                                     |                | -           | 1290     | -     | -      |
|   | EER/EER CLASS                            | TOTAL (W/W) <sup>*5</sup> ("A"~"G")            | -                                   | -                     | -                                   | 3.88           | 3.88 / A    | 3.88     | 3.93  | 3.38   |
|   | Erp <sup>*6</sup>                        | Pdesign  | kW                                  | -                     | -                                   | -              | -           | 10.0     | -     | -      |
|   |  | SEER   | (W/W)                               | -                     | -                                   | -              | -           | 6.2      | -     | -      |
|   |  | Annual consumption                             | kWh                                 | -                     | -                                   | -              | -           | 564      | -     | -      |
| Class   |  |  | -                                   | -                     | -                                   | -              | A++         | -        | -     |        |
| Power factor  | %  | -  | -                                   | -                     | 96                                  | 96             | 96          | -        | -     |        |
| Noise indoor  | dB-A (H/M/L)                             | 40/36/32                                       |                                     |                       | -                                   | -              | -           | -        | -     |        |
|   | Power Level dB                           | 57/51/46                                       |                                     |                       | -                                   | -              | -           | -        | -     |        |
| Noise outdoor   | dB-A (H/L)                               | -  |                                     |                       | 52/-                                |                |             | -        | -     |        |
|   | Power Level dB                           | -  |                                     |                       | 69/-                                |                |             | -        | -     |        |
| H<br>E<br>A<br>T<br>I<br>N<br>G                                       | Capacity                                 | kW   | 11.2                                | 11.2                  | 11.2                                | -              | -           | -        | 4.1   | 14.0   |
|   |  | BTU/h  | 38200                               | 38200                 | 38200                               | -              | -           | -        | 14000 | 47800  |
|   | Current                                  | A  | 0.27×2                              | 0.27×2                | 0.27×2                              | 13.1           | 12.5        | 12.0     | -     | -      |
|   |  | W  | 26×2                                | 27×2                  | 28×2                                | 2.705k         | 2.705k      | 2.705k   | -     | -      |
|   | Input power                              | TOTAL W  | -                                   |                       |                                     | 2.760k         | 2.760k      | 2.760k   | 900   | 4.400k |
|   |  | COP/COP CLASS                                  | TOTAL (W/W) <sup>*5</sup> ("A"~"G") | -                     | -                                   | -              | 4.06        | 4.06 / A | 4.06  | 4.56   |
|   | Erp <sup>*6</sup>                        | Pdesign at -10°C                               | kW                                  | -                     | -                                   | -              | -           | 10.0     | -     | -      |
|   |  | Tbivalent                                      | °C                                  | -                     | -                                   | -              | -           | -10      | -     | -      |
|   |  | SCOP   | (W/W)                               | -                     | -                                   | -              | -           | 4.0      | -     | -      |
|   |  | Annual consumption                             | kWh                                 | -                     | -                                   | -              | -           | 3500     | -     | -      |
| Class   |  | -  | -                                   | -                     | -                                   | A+             | -           | -        |       |        |
| Power factor  | %  | -  | -                                   | -                     | 94                                  | 94             | 94          | -        | -     |        |
| Noise indoor  | dB-A (H/M/L)                             | 40/36/32                                       |                                     |                       | -                                   | -              | -           | -        | -     |        |
|   | Power Level dB                           | 57/51/46                                       |                                     |                       | -                                   | -              | -           | -        | -     |        |
| Noise outdoor   | dB-A (H/L)                               | -  |                                     |                       | 52/-                                |                |             | -        | -     |        |
|   | Power Level dB                           | -  |                                     |                       | 69/-                                |                |             | -        | -     |        |
| EXTRA LOW TEMP <sup>†</sup> Total capacity(kW) / Input power(W) / COP |  | -  |                                     |                       |                                     |                |             |          |       |        |
| Max Current(A) / Max Input power(W)                                   |  | 0.27×2/26×2                                    | 0.27×2/27×2                         | 0.27×2/28×2           | 25.0/5.350k                         | 25.0/5.550k    | 25.0/5.570k | -        |       |        |
| Starting current(A) / Comp output(W)                                  |  | -  | -                                   | -                     | 13.1/3.0k                           | 12.5/3.0k      | 12.0/3.0k   | -        |       |        |
| Network Impedance(ΩMAX.)  |  | -  |                                     |                       |                                     |                |             |          |       |        |
| Fan motor output (Indoor/Outdoor) W                                   |  | 47×2   |                                     |                       | 90×2                                |                |             | -        |       |        |
| Moisture removal volume   |  | L/h(Pt/h)                                      | 6.0 (3.0×2)                         |                       |                                     | (12.6)         |             |          | -     |        |
| External static pressure  |  | Pa   | -                                   |                       |                                     | -              |             |          | -     |        |
| Indoor Air flow   | Cooling                                  | m³/min (ft³/min)                               | [14/12/10.5 (494/424/371)]×2        |                       |                                     | -              |             |          | -     | -      |
|   | Heating                                  | m³/min (ft³/min)                               | [14/12/10.5 (494/424/371)]×2        |                       |                                     | -              |             |          | -     | -      |
| Outdoor Air flow  | Cooling                                  | m³/min (ft³/min)                               | -                                   |                       |                                     | 110 (3885)     |             |          | -     | -      |
|   | Heating                                  | m³/min (ft³/min)                               | -                                   |                       |                                     | 95 (3355)      |             |          | -     | -      |
| Refrigerant type / amount g(oz)                                       |  | -  |                                     |                       | R410A                               |                | 3.40k       | (119.9)  | -     |        |
| Product dimension   | Height                                   | mm(inch)                                       | 300 (11-1/32)                       |                       |                                     | 1416 (55-3/4)  |             |          | -     | -      |
|   | Width                                    | mm(inch)                                       | 1065 (41-15/16)                     |                       |                                     | 940 (37-1/32)  |             |          | -     | -      |
|   | Depth                                    | mm(inch)                                       | 230 (9-1/32)                        |                       |                                     | 340 (13-13/32) |             |          | -     | -      |
| Packing dimension   | Height                                   | mm(inch)                                       | 310                                 |                       |                                     | 1556           |             |          | -     | -      |
|   | Width                                    | mm(inch)                                       | 1140                                |                       |                                     | 1055           |             |          | -     | -      |
|   | Depth                                    | mm(inch)                                       | 380                                 |                       |                                     | 485            |             |          | -     | -      |
| Weight  | (NET)                                    | kg(lb)   | 13 (29)                             |                       |                                     | 98 (216)       |             |          | -     | -      |
|   | (GROSS)                                  | kg(lb)   | 17 (37)                             |                       |                                     | 108 (238)      |             |          | -     | -      |
| Layers limit (actually)   |  | 15 (16)  |                                     |                       | 1 (2)                               |                |             | -        |       |        |
| Operation condition   | Cool (DBT)                               | 18°C ~ 32°C                                    |                                     |                       | -15°C ~ 46°C                        |                |             | -        |       |        |
|   | Heat (DBT)                               | 16°C ~ 30°C                                    |                                     |                       | -20°C ~ 24°C                        |                |             | -        |       |        |
| P<br>I<br>P<br>I<br>N<br>G  | Pipe diameter mm (inch)                  | (Liquid)ø6.35(1/4) (Gas)ø12.7(1/2)             |                                     |                       | (Liquid)ø9.52(3/8) (Gas)ø15.88(5/8) |                |             | -        |       |        |
|   | Connecting method, Standard length m(ft) | flared type, 5.0(16.4)                         |                                     |                       | flared type, 5.0(16.4)              |                |             | -        |       |        |
| Pipe length range   |  | m (ft)   |                                     | 5 ~ 75 (16.4 ~ 246.1) |                                     | -              |             |          |       |        |
| Indoor unit & Outdoor unit height difference m (ft)                   |  | 15 (OD located lower) / 30 (OD located higher) |                                     |                       | (49.2/98.4)                         |                |             | -        |       |        |
| Add gas amount g/m (oz/ft)  |  | 50 (0.538)                                     |                                     |                       | -                                   |                |             | -        |       |        |
| Pipe length for additional gas  |  | m (ft)   |                                     | 30 (98.4)             |                                     | -              |             |          |       |        |

\*1: In case it is necessary to indicate the air flow volume in (l/s), the value in (m³/min.) shall be multiplied by 16.7 and rounded down the decimal point.

\*2: If the EUROVENT Certified models can be operated under the "extra-low" temperature condition, -7°C dry bulb and -8°C wet-bulb temperatures with rated voltage 230 V shall be used.

\*3: Network Impedance shall be applicable for EUROPE and CHINA models.

\*4: The annual consumption is calculated by multiplying the input power at 230 V (400 V) by an average of 500 hours per year in cooling mode.

\*5: EER and COP classification is at 230 V (400 V) only in accordance with EU directive 2002/31/EC.

\*6: SEER and SCOP classification is at 230V(400V) only in accordance with EN-14825. For heating, SCOP indicates the value of only Average heating season, Other fiche data indicates in an attached sheet.

# Single -Type

## 1-1. Unit Specifications

**PE2**

### 3. Wall Mounted Type S-60PK1E5A / U-60PE2E5A

|                                      |   |  |  |         |                                     |            |            |      |        |
|--------------------------------------|---|--|--|---------|-------------------------------------|------------|------------|------|--------|
| INDOOR                               | MODEL   | S-60PK1E5A                                       |  |         | -                                   |            |            | -    | -      |
| PANEL                                | MODEL   | -  |  |         | -                                   |            |            | -    | -      |
| OUTDOOR                              | MODEL   | -  |  |         | U-60PE2E5A                          |            |            | -    | -      |
| Branch pipe                          | MODEL   | -  |  |         | -                                   |            |            | -    | -      |
| Performance test condition           |   | ISO5151 / EN14511 / EN12102 / EN14825            |  |         |                                     |            |            |      |        |
| Power supply                         | Ø, Hz   | 1ø 50Hz  |  |         | 1ø 50Hz                             |            |            | -    | -      |
|                                      | V   | 220V   | 230V                                     | 240V    | 220V                                | 230V       | 240V       | Min  | Max    |
| Capacity                             | kW  | 6.0  | 6.0                                      | 6.0     | -                                   | -          | -          | 2.0  | 7.1    |
|                                      | BTU/h   | 20500  | 20500                                    | 20500   | -                                   | -          | -          | 6800 | 24200  |
| Current                              | A   | 0.59   | 0.58                                     | 0.52    | 8.20                                | 7.80       | 7.50       | -    | -      |
| Input power                          | W   | 57   | 57                                       | 57      | 1.623k                              | 1.623k     | 1.623k     | -    | -      |
|                                      | TOTAL W   | -  |  |         | 1.680k                              | 1.680k     | 1.680k     | 300  | 2.350k |
| Annual consumption                   | TOTAL kWh *4  | -  |  |         | -                                   | 840        | -          | -    | -      |
| EER/EER CLASS                        | TOTAL (W/W) <sup>5</sup> ("A"~"G")                  | -  | -  | -       | 3.57                                | 3.57/A     | 3.57       | 6.67 | 3.02   |
| Erp *6                               | Pdesign   | kW   | -  | -       | -                                   | 6.0        | -          | -    | -      |
|                                      | SEER  | (W/W)  | -  | -       | -                                   | 6.6        | -          | -    | -      |
|                                      | Annual consumption                                  | kWh  | -  | -       | -                                   | 318        | -          | -    | -      |
|                                      | Class   |  | -  | -       | -                                   | -          | A++        | -    | -      |
| Power factor                         | %   | -  | -  | -       | 90                                  | 90         | 90         | -    | -      |
| Noise indoor                         | dB-A (H/M/L)  | 47/44/40   |  |         | -                                   | -          | -          | -    | -      |
|                                      | Power Level dB                                      | 64/59/54   |  |         | -                                   | -          | -          | -    | -      |
| Noise outdoor                        | dB-A (H/L)  | -  |  |         | 46/-                                |            |            | -    | -      |
|                                      | Power Level dB                                      | -  |  |         | 65/-                                |            |            | -    | -      |
| Capacity                             | kW  | 7.0  | 7.0                                      | 7.0     | -                                   | -          | -          | 1.8  | 8.0    |
|                                      | BTU/h   | 23900  | 23900                                    | 23900   | -                                   | -          | -          | 6100 | 27300  |
| Current                              | A   | 0.59   | 0.58                                     | 0.52    | 8.50                                | 8.15       | 7.80       | -    | -      |
| Input power                          | W   | 57   | 57                                       | 57      | 1.683k                              | 1.683k     | 1.683k     | -    | -      |
|                                      | TOTAL W   | -  |  |         | 1.740k                              | 1.740k     | 1.740k     | 200  | 2.050k |
| COP/COP CLASS                        | TOTAL (W/W) <sup>5</sup> ("A"~"G")                  | -  | -  | -       | 4.02                                | 4.02/A     | 4.02       | 9.00 | 3.90   |
| Erp *6                               | Pdesign at -10°C                                    | kW   | -  | -       | -                                   | 6.0        | -          | -    | -      |
|                                      | Tbivalent   | °C   | -  | -       | -                                   | -8         | -          | -    | -      |
|                                      | SCOP  | (W/W)  | -  | -       | -                                   | 4.0        | -          | -    | -      |
|                                      | Annual consumption                                  | kWh  | -  | -       | -                                   | -          | 2100       | -    | -      |
| Class                                |   | -  | -  | -       | -                                   | A+         | -          | -    |        |
| Power factor                         | %   | -  | -  | -       | 90                                  | 90         | 90         | -    | -      |
| Noise indoor                         | dB-A (H/M/L)  | 47/44/40   |  |         | -                                   | -          | -          | -    | -      |
|                                      | Power Level dB                                      | 64/59/54   |  |         | -                                   | -          | -          | -    | -      |
| Noise outdoor                        | dB-A (H/L)  | -  |  |         | 49/-                                |            |            | -    | -      |
|                                      | Power Level dB                                      | -  |  |         | 69/-                                |            |            | -    | -      |
| EXTRA LOW TEMP                       | Total capacity(kW) / Input power(W) / COP           | -  |  |         | -                                   |            |            | -    | -      |
| Max Current(A) / Max Input power(W)  |   | 0.59/57  | 0.58/57                                  | 0.52/57 | 16.5/3.27k                          | 16.5/3.42k | 16.5/3.57k | -    | -      |
| Starting current(A) / Comp output(W) |   | -  | -  | -       | 8.50/1.7k                           | 8.15/1.7k  | 7.80/1.7k  | -    | -      |
| Network Impedance(ΩMAX.)             |   | -  |  |         | -                                   |            |            | -    | -      |
| Fan motor output (Indoor/Outdoor) W  |   | 47   |  |         | 60                                  |            |            | -    | -      |
| Moisture removal volume              |   | L/h(Pt/h)  | 3.4                                      | (7.1)   | -                                   |            |            | -    | -      |
| External static pressure             |   | Pa   | -  |         |                                     | -          |            |      | -      |
| Indoor Air flow                      | Cooling   | m³/min (ft³/min)                                 | 18.0 / 14.5 / 11.5 (636) / (512) / (406) |         |                                     | -          |            |      | -      |
|                                      | Heating   | m³/min (ft³/min)                                 | 18.0 / 14.5 / 11.5 (636) / (512) / (406) |         |                                     | -          |            |      | -      |
| Outdoor Air flow                     | Cooling   | m³/min (ft³/min)                                 | -  |         |                                     | 38         | (1342)     | -    | -      |
|                                      | Heating   | m³/min (ft³/min)                                 | -  |         |                                     | 41         | (1448)     | -    | -      |
| Refrigerant type / amount g(oz)      |   | -  |  |         | R410A                               | 1.95k      | (68.8)     | -    | -      |
| Product dimension                    | Height mm(inch)                                     | 300  | (11-1/32)                                |         | 619                                 | (24-3/8)   |            | -    | -      |
|                                      | Width mm(inch)                                      | 1065   | (41-15/16)                               |         | 799                                 | (31-29/64) |            | -    | -      |
|                                      | Depth mm(inch)                                      | 230  | (9-1/32)                                 |         | 299                                 | (11-49/64) |            | -    | -      |
| Product dimension (Panel)            |   | H×W×D mm, inch                                   | -  |         |                                     | -          |            |      | -      |
| Packing dimension                    | Height mm(inch)                                     | 310  |  |         | 688                                 |            |            | -    | -      |
|                                      | Width mm(inch)                                      | 1140   |  |         | 931                                 |            |            | -    | -      |
|                                      | Depth mm(inch)                                      | 380  |  |         | 422                                 |            |            | -    | -      |
| Weight                               | (NET) kg(lb)  | 14.5   | (32)                                     |         | 40                                  | (88)       |            | -    | -      |
|                                      | (GROSS) kg(lb)                                      | 18   | (40)                                     |         | 45                                  | (99)       |            | -    | -      |
|                                      | Panel (NET) kg(lb)                                  | -  |  |         | -                                   |            |            | -    | -      |
| Layers limit (actually)              |   | 15 (16)  |  |         | 5 (6)                               |            |            | -    | -      |
| Operation condition                  | Cool (DBT)  | 18°C ~ 32°C                                      |  |         | -15°C ~ 46°C                        |            |            | -    | -      |
|                                      | Heat (DBT)  | 16°C ~ 30°C                                      |  |         | -20°C ~ 24°C                        |            |            | -    | -      |
| P I P I N G                          | Pipe diameter mm (inch)                             | (Liquid)ø9.52(3/8) (Gas)ø15.88(5/8)              |  |         | (Liquid)ø9.52(3/8) (Gas)ø15.88(5/8) |            |            | -    | -      |
|                                      | Connecting method, Standard length m(ft)            | flared type, 5.0(16.4)                           |  |         | flared type, 5.0(16.4)              |            |            | -    | -      |
| P I P I N G                          | Pipe length range m (ft)                            | 3 ~ 40m (9.8 ~ 131.2)                            |  |         | -                                   |            |            | -    | -      |
|                                      | Indoor unit & Outdoor unit height difference m (ft) | 15m (OD located lower) / 30m (OD located higher) |  |         | (49.2/98.4)                         |            |            | -    | -      |
| P I P I N G                          | Add gas amount g/m (oz/ft)                          | 40g (0.430)                                      |  |         | -                                   |            |            | -    | -      |
|                                      | Pipe length for additional gas m (ft)               | 30m (98.4)                                       |  |         | -                                   |            |            | -    | -      |

\*1: In case it is necessary to indicate the air flow volume in (l/s), the value in (m³/min.) shall be multiplied by 16.7 and rounded down the decimal point.  
 \*2: If the EUROVENT Certified models can be operated under the "extra-low" temperature condition, -7°C dry bulb and -8°C wet-bulb temperatures with rated voltage 230 V shall be used.  
 \*3: Network Impedance shall be applicable for EUROPE and CHINA models.  
 \*4: The annual consumption is calculated by multiplying the input power at 230V (400V) by an average of 500 hours per year in cooling mode.  
 \*5: EER and COP classification is at 230V (400V) only in accordance with EU directive 2002/31/EC.  
 \*6: SEER and SCOP classification is at 230V (400V) only in accordance with EN-14825. For heating, SCOP indicates the value of only Average heating season, Other fiche data indicates in an attached sheet.

# Single -Type

## 1-1. Unit Specifications

**PE1**

### 3. Wall Mounted Type S-71PK1E5A / U-71PE1E5A

| INDOOR  |   | MODEL                              | S-71PK1E5A                                     |         |             | -                                   |             |          | -    |        |      |
|---|---|------------------------------------|--|---------|-------------|-------------------------------------|-------------|----------|------|--------|------|
| PANEL   |   | MODEL                              | -  |         |             | -                                   |             |          | -    |        |      |
| OUTDOOR   |   | MODEL                              | -  |         |             | U-71PE1E5A                          |             |          | -    |        |      |
| Branch pipe   |   | MODEL                              | -  |         |             | -                                   |             |          | -    |        |      |
| Performance test condition  |   |                                    | ISO5151 / EN14511 / EN14825 / EN12102          |         |             |                                     |             |          |      |        |      |
| Power supply  |   | Ø, Hz                              | 1ø 50Hz  |         |             | 1ø 50Hz                             |             |          |      |        |      |
|   |   | V                                  | 220  | 230     | 240         | 220                                 | 230         | 240      | Min  | Max    |      |
| C<br>O<br>O<br>L<br>I<br>N<br>G                                       | Capacity  | kW                                 | 7.1  | 7.1     | 7.1         | -                                   | -           | -        | 2.5  | 8.0    |      |
|   |   | BTU/h                              | 24200  | 24200   | 24200       | -                                   | -           | -        | 8500 | 27300  |      |
|   | Current   | A                                  | 0.59   | 0.58    | 0.52        | 9.75                                | 9.40        | 9.10     | -    | -      |      |
|   |   | W                                  | 57   | 57      | 57          | 2.030k                              | 2.030k      | 2.030k   | -    | -      |      |
|   | Input power   | TOTAL W                            | -  |         |             | 2.090k                              | 2.090k      | 2.090k   | 450  | 2.650k |      |
|   |   | Annual consumption                 | TOTAL kWh *4                                   | -       |             |                                     | -           | 1045     | -    | -      | -    |
|   | EER/EER CLASS                                       | TOTAL (W/W) <sup>5</sup> ("A"~"G") | -  | -       | -           | 3.40                                | 3.40 / A    | 3.40     | 5.56 | 3.02   |      |
|   | Erp <sup>6</sup>                                    | Pdesign                            | kW   | -       | -           | -                                   | -           | 7.1      | -    | -      | -    |
|   |   | SEER                               | (W/W)  | -       | -           | -                                   | -           | 6.6      | -    | -      | -    |
|   |   | Annual consumption                 | kWh  | -       | -           | -                                   | -           | 376      | -    | -      | -    |
| Class   |   |                                    | -  | -       | -           | -                                   | A++         | -        | -    | -      |      |
| Power factor  | %   | -                                  | -  | -       | 95          | 94                                  | 93          | -        | -    |        |      |
| Noise indoor  | dB-A (H/M/L)  | 47/44/40                           |  |         | -           | -                                   | -           | -        | -    |        |      |
|   | Power Level dB                                      | 64/59/54                           |  |         | -           | -                                   | -           | -        | -    |        |      |
| Noise outdoor   | dB-A (H/L)  | -                                  |  |         | 48/-        |                                     |             | -        | -    |        |      |
|   | Power Level dB                                      | -                                  |  |         | 65/-        |                                     |             | -        | -    |        |      |
| H<br>E<br>A<br>T<br>I<br>N<br>G                                       | Capacity  | kW                                 | 8.0  | 8.0     | 8.0         | -                                   | -           | -        | 2.0  | 9.0    |      |
|   |   | BTU/h                              | 27300  | 27300   | 27300       | -                                   | -           | -        | 6800 | 30700  |      |
|   | Current   | A                                  | 0.59   | 0.58    | 0.52        | 9.85                                | 9.50        | 9.20     | -    | -      |      |
|   |   | W                                  | 57   | 57      | 57          | 2.070k                              | 2.070k      | 2.070k   | -    | -      |      |
|   | Input power   | TOTAL W                            | -  |         |             | 2.130k                              | 2.130k      | 2.130k   | 400  | 2.900k |      |
|   |   | COP/COP CLASS                      | TOTAL (W/W) <sup>5</sup> ("A"~"G")             | -       | -           | -                                   | 3.76        | 3.76 / A | 3.76 | 5.00   | 3.10 |
|   | Erp <sup>6</sup>                                    | Pdesign at -10°C                   | kW   | -       | -           | -                                   | -           | 7.1      | -    | -      | -    |
|   |   | Tbivalent                          | °C   | -       | -           | -                                   | -           | -9       | -    | -      | -    |
|   |   | SCOP                               | (W/W)  | -       | -           | -                                   | -           | 3.9      | -    | -      | -    |
|   |   | Annual consumption                 | kWh  | -       | -           | -                                   | -           | 2548     | -    | -      | -    |
| Class   |   | -                                  | -  | -       | -           | A                                   | -           | -        | -    |        |      |
| Power factor  | %   | -                                  | -  | -       | 96          | 95                                  | 94          | -        | -    |        |      |
| Noise indoor  | dB-A (H/M/L)  | 47/44/40                           |  |         | -           | -                                   | -           | -        | -    |        |      |
|   | Power Level dB                                      | 64/59/54                           |  |         | -           | -                                   | -           | -        | -    |        |      |
| Noise outdoor   | dB-A (H/L)  | -                                  |  |         | 50/-        |                                     |             | -        | -    |        |      |
|   | Power Level dB                                      | -                                  |  |         | 67/-        |                                     |             | -        | -    |        |      |
| EXTRA LOW TEMP <sup>2</sup> Total capacity(kW) / Input power(W) / COP |   |                                    |  |         |             |                                     |             |          |      |        |      |
| Max Current(A) / Max Input power(W)                                   |   | 0.59/57                            | 0.58/57  | 0.52/57 | 18.0/3.800k | 18.0/3.930k                         | 18.0/4.060k |          |      |        |      |
| Starting current(A) / Comp output(W)                                  |   | -                                  | -  | -       | 9.85/2.0k   | 9.50/2.0k                           | 9.20/2.0k   |          |      |        |      |
| Network Impedance(ΩMAX.)  |   |                                    |  |         |             |                                     |             |          |      |        |      |
| Fan motor output (Indoor/Outdoor) W                                   |   |                                    |  | 47      |             | 90                                  |             |          |      |        |      |
| Moisture removal volume   |   | L/h(Pt/h)                          | 4.2  | (8.8)   |             |                                     |             |          |      |        |      |
| External static pressure  |   | Pa                                 |  |         |             |                                     |             |          |      |        |      |
| Indoor Air flow   | Cooling   | m³/min (ft³/min)                   | 18/14.5/11.5 (636/512/406)                     |         |             |                                     |             |          | -    | -      |      |
|   | Heating   | m³/min (ft³/min)                   | 18/14.5/11.5 (636/512/406)                     |         |             |                                     |             |          | -    | -      |      |
| Outdoor Air flow  | Cooling   | m³/min (ft³/min)                   | -  |         |             | 60                                  | (2119)      |          | -    | -      |      |
|   | Heating   | m³/min (ft³/min)                   | -  |         |             | 60                                  | (2119)      |          | -    | -      |      |
| Refrigerant type / amount g(oz)                                       |   |                                    |  |         |             | R410A                               | 2.35k       | (82.9)   |      |        |      |
| Product dimension   | Height  | mm(inch)                           | 300 (11-1/32)                                  |         |             | 996 (39-7/32)                       |             |          |      |        |      |
|   | Width   | mm(inch)                           | 1065 (41-15/16)                                |         |             | 940 (37-1/32)                       |             |          |      |        |      |
|   | Depth   | mm(inch)                           | 230 (9-1/32)                                   |         |             | 340 (13-13/32)                      |             |          |      |        |      |
| Packing dimension   | Height  | mm(inch)                           | 310  |         |             | 1136                                |             |          |      |        |      |
|   | Width   | mm(inch)                           | 1140   |         |             | 1055                                |             |          |      |        |      |
|   | Depth   | mm(inch)                           | 380  |         |             | 485                                 |             |          |      |        |      |
| Weight  | (NET)   | kg(lb)                             | 14.5 (32)                                      |         |             | 69 (152)                            |             |          |      |        |      |
|   | (GROSS)   | kg(lb)                             | 18 (40)  |         |             | 77 (170)                            |             |          |      |        |      |
| Layers limit (actually)   |   |                                    |  | 15 (16) |             | 2 (3)                               |             |          |      |        |      |
| Operation condition   |   | Cool (DBT)                         | 18°C ~ 32°C                                    |         |             | -15°C ~ 46°C                        |             |          |      |        |      |
|   |   | Heat (DBT)                         | 16°C ~ 30°C                                    |         |             | -20°C ~ 24°C                        |             |          |      |        |      |
| P<br>I<br>P<br>I<br>N<br>G  | Pipe diameter mm (inch)                             |                                    | (Liquid)ø9.52(3/8) (Gas)ø15.88(5/8)            |         |             | (Liquid)ø9.52(3/8) (Gas)ø15.88(5/8) |             |          |      |        |      |
|   | Connecting method, Standard length m(ft)            |                                    | flared type, 5.0(16.4)                         |         |             | flared type, 5.0(16.4)              |             |          |      |        |      |
|   | Pipe length range m (ft)                            |                                    | 5 ~ 50 (16.4 ~ 164.0)                          |         |             |                                     |             |          |      |        |      |
|   | Indoor unit & Outdoor unit height difference m (ft) |                                    | 15 (OD located lower) / 30 (OD located higher) |         |             | (49.2/98.4)                         |             |          |      |        |      |
|   | Add gas amount g/m (oz/ft)                          |                                    | 50 (0.538)                                     |         |             |                                     |             |          |      |        |      |
| Pipe length for additional gas m (ft)                                 |   | 30 (98.4)                          |  |         |             |                                     |             |          |      |        |      |

\*1: In case it is necessary to indicate the air flow volume in (l/s), the value in (m³/min.) shall be multiplied by 16.7 and rounded down the decimal point.

\*2: If the EUROVENT Certified models can be operated under the "extra-low" temperature condition, -7°C dry bulb and -8°C wet-bulb temperatures with rated voltage 230 V shall be used.

\*3: Network Impedance shall be applicable for EUROPE and CHINA models.

\*4: The annual consumption is calculated by multiplying the input power at 230 V (400 V) by an average of 500 hours per year in cooling mode.

\*5: EER and COP classification is at 230 V (400 V) only in accordance with EU directive 2002/31/EC.

\*6: SEER and SCOP classification is at 230V(400V) only in accordance with EN-14825. For heating, SCOP indicates the value of only Average heating season, Other fiche data indicates in an attached sheet.

# Single -Type

## 1-1. Unit Specifications

PE1

### 3. Wall Mounted Type S-100PK1E5A / U-100PE1E5A

|  |  |  |                                     |         |                                     |                |             |          |       |        |      |
|--|--|--|-------------------------------------|---------|-------------------------------------|----------------|-------------|----------|-------|--------|------|
| INDOOR   | MODEL                                    | S-100PK1E5A                                    |                                     |         | -                                   |                |             | -        | -     |        |      |
| PANEL  | MODEL                                    | -  |                                     |         | -                                   |                |             | -        | -     |        |      |
| OUTDOOR  | MODEL                                    | -  |                                     |         | U-100PE1E5A                         |                |             | -        | -     |        |      |
| Branch pipe  | MODEL                                    | -  |                                     |         | -                                   |                |             | -        | -     |        |      |
| Performance test condition                                 |  | ISO5151 / EN14511 / EN14825 / EN12102          |                                     |         |                                     |                |             |          |       |        |      |
| Power supply   |  | Ø, Hz  | 1ø 50Hz                             |         |                                     | 1ø 50Hz        |             |          | Min   | Max    |      |
|  |  | V  | 220                                 | 230     | 240                                 | 220            | 230         | 240      |       |        |      |
| C<br>O<br>O<br>L<br>I<br>N<br>G                            | Capacity                                 | kW   | 9.5                                 | 9.5     | 9.5                                 | -              | -           | -        | 3.3   | 10.5   |      |
|  |  | BTU/h  | 32400                               | 32400   | 32400                               | -              | -           | -        | 11300 | 35800  |      |
|  | Current                                  | A  | 0.61                                | 0.59    | 0.55                                | 13.4           | 12.9        | 12.4     | -     | -      |      |
|  |  | W  | 65                                  | 65      | 65                                  | 2.855k         | 2.855k      | 2.855k   | -     | -      |      |
|  | Input power                              | TOTAL W  | -                                   |         |                                     | 2.920k         | 2.920k      | 2.920k   | 840   | 3.400k |      |
|  |  | Annual consumption                             | TOTAL kWh *4                        | -       |                                     |                | -           | 1460     | -     | -      | -    |
|  | EER/EER CLASS                            | TOTAL (W/W) <sup>*5</sup> ("A"~"G")            | -                                   | -       | -                                   | 3.25           | 3.25 / A    | 3.25     | 3.93  | 3.09   |      |
|  | Erp<br>*6                                | Pdesign  | kW                                  | -       | -                                   | -              | -           | 9.5      | -     | -      | -    |
|  |  | SEER   | (W/W)                               | -       | -                                   | -              | -           | 6.2      | -     | -      | -    |
|  |  | Annual consumption                             | kWh                                 | -       | -                                   | -              | -           | 536      | -     | -      | -    |
| Class  |  |  | -                                   | -       | -                                   | -              | A++         | -        | -     | -      |      |
| Power factor   | %  | -  | -                                   | -       | 97                                  | 96             | 96          | -        | -     |        |      |
| Noise indoor   | dB-A (H/M/L)                             | 49/45/41                                       |                                     |         | -                                   | -              | -           | -        | -     |        |      |
|  | Power Level dB                           | 65/60/55                                       |                                     |         | -                                   | -              | -           | -        | -     |        |      |
| Noise outdoor  | dB-A (H/L)                               | -  |                                     |         | 52/-                                |                |             | -        | -     |        |      |
|  | Power Level dB                           | -  |                                     |         | 69/-                                |                |             | -        | -     |        |      |
| H<br>E<br>A<br>T<br>I<br>N<br>G                            | Capacity                                 | kW   | 9.5                                 | 9.5     | 9.5                                 | -              | -           | -        | 4.1   | 11.5   |      |
|  |  | BTU/h  | 32400                               | 32400   | 32400                               | -              | -           | -        | 14000 | 39200  |      |
|  | Current                                  | A  | 0.62                                | 0.60    | 0.56                                | 11.3           | 10.9        | 10.6     | -     | -      |      |
|  |  | W  | 65                                  | 65      | 65                                  | 2.405k         | 2.405k      | 2.405k   | -     | -      |      |
|  | Input power                              | TOTAL W  | -                                   |         |                                     | 2.470k         | 2.470k      | 2.470k   | 900   | 3.350k |      |
|  |  | COP/COP CLASS                                  | TOTAL (W/W) <sup>*5</sup> ("A"~"G") | -       | -                                   | -              | 3.85        | 3.85 / A | 3.85  | 4.56   | 3.43 |
|  | Erp<br>*6                                | Pdesign at -10°C                               | kW                                  | -       | -                                   | -              | -           | 9.5      | -     | -      | -    |
|  |  | Tbivalent                                      | °C                                  | -       | -                                   | -              | -           | -10      | -     | -      | -    |
|  |  | SCOP   | (W/W)                               | -       | -                                   | -              | -           | 3.8      | -     | -      | -    |
|  |  | Annual consumption                             | kWh                                 | -       | -                                   | -              | -           | 3500     | -     | -      | -    |
| Class  |  | -  | -                                   | -       | -                                   | A              | -           | -        | -     |        |      |
| Power factor   | %  | -  | -                                   | -       | 97                                  | 96             | 95          | -        | -     |        |      |
| Noise indoor   | dB-A (H/M/L)                             | 49/45/41                                       |                                     |         | -                                   | -              | -           | -        | -     |        |      |
|  | Power Level dB                           | 65/60/55                                       |                                     |         | -                                   | -              | -           | -        | -     |        |      |
| Noise outdoor  | dB-A (H/L)                               | -  |                                     |         | 52/-                                |                |             | -        | -     |        |      |
|  | Power Level dB                           | -  |                                     |         | 69/-                                |                |             | -        | -     |        |      |
| EXTRA LOW TEMP   Total capacity(kW) / Input power(W) / COP |  | -  |                                     |         |                                     |                |             |          |       |        |      |
| Max Current(A) / Max Input power(W)                        |  | 0.62/65  | 0.60/65                             | 0.56/65 | 25.0/5.340k                         | 25.0/5.520k    | 25.0/5.700k | -        |       |        |      |
| Starting current(A) / Comp output(W)                       |  | -  | -                                   | -       | 13.4/3.0k                           | 12.9/3.0k      | 12.4/3.0k   | -        |       |        |      |
| Network Impedance(ΩMAX.)                                   |  | -  |                                     |         |                                     |                |             |          |       |        |      |
| Fan motor output (Indoor/Outdoor) W                        |  | 47   |                                     |         | 90×2                                |                |             | -        |       |        |      |
| Moisture removal volume                                    |  | L/h(Pt/h)                                      | 5.7                                 | (12.0)  | -                                   |                |             | -        |       |        |      |
| External static pressure                                   |  | Pa   | -                                   |         |                                     | -              |             |          | -     |        |      |
| Indoor Air flow  | Cooling                                  | m³/min (ft³/min)                               | 19/16.5/13 (671/583/459)            |         |                                     | -              |             |          | -     | -      |      |
|  | Heating                                  | m³/min (ft³/min)                               | 19/16.5/13 (671/583/459)            |         |                                     | -              |             |          | -     | -      |      |
| Outdoor Air flow   | Cooling                                  | m³/min (ft³/min)                               | -                                   |         |                                     | 110            | (3885)      | -        |       |        |      |
|  | Heating                                  | m³/min (ft³/min)                               | -                                   |         |                                     | 95             | (3355)      | -        |       |        |      |
| Refrigerant type / amount g(oz)                            |  | -  |                                     |         | R410A                               | 3.40k          | (119.9)     | -        |       |        |      |
| Product dimension  | Height                                   | mm(inch)                                       | 300 (11-1/32)                       |         |                                     | 1416 (55-3/4)  |             |          | -     |        |      |
|  | Width                                    | mm(inch)                                       | 1065 (41-15/16)                     |         |                                     | 940 (37-1/32)  |             |          | -     |        |      |
|  | Depth                                    | mm(inch)                                       | 230 (9-1/32)                        |         |                                     | 340 (13-13/32) |             |          | -     |        |      |
| Packing dimension  | Height                                   | mm(inch)                                       | 310                                 |         |                                     | 1556           |             |          | -     |        |      |
|  | Width                                    | mm(inch)                                       | 1140                                |         |                                     | 1055           |             |          | -     |        |      |
|  | Depth                                    | mm(inch)                                       | 380                                 |         |                                     | 485            |             |          | -     |        |      |
| Weight   | (NET)                                    | kg(lb)   | 14.5 (32)                           |         |                                     | 98 (216)       |             |          | -     |        |      |
|  | (GROSS)                                  | kg(lb)   | 18 (40)                             |         |                                     | 108 (238)      |             |          | -     |        |      |
| Layers limit (actually)                                    |  | 15 (16)  |                                     |         | 1 (2)                               |                |             | -        |       |        |      |
| Operation condition  | Cool (DBT)                               | 18°C ~ 32°C                                    |                                     |         | -15°C ~ 46°C                        |                |             | -        |       |        |      |
|  | Heat (DBT)                               | 16°C ~ 30°C                                    |                                     |         | -20°C ~ 24°C                        |                |             | -        |       |        |      |
| P<br>I<br>P<br>I<br>N<br>G                                 | Pipe diameter mm (inch)                  | (Liquid)ø9.52(3/8) (Gas)ø15.88(5/8)            |                                     |         | (Liquid)ø9.52(3/8) (Gas)ø15.88(5/8) |                |             | -        |       |        |      |
|  | Connecting method, Standard length m(ft) | flared type, 5.0(16.4)                         |                                     |         | flared type, 5.0(16.4)              |                |             | -        |       |        |      |
| Pipe length range  |  | m (ft)   |                                     |         | 5 ~ 75 (16.4 ~ 246.1)               |                |             | -        |       |        |      |
| Indoor unit & Outdoor unit height difference m (ft)        |  | 15 (OD located lower) / 30 (OD located higher) |                                     |         | (49.2/98.4)                         |                |             | -        |       |        |      |
| Add gas amount g/m (oz/ft)                                 |  | 50   |                                     |         | (0.538)                             |                |             | -        |       |        |      |
| Pipe length for additional gas                             |  | m (ft)   |                                     |         | 30 (98.4)                           |                |             | -        |       |        |      |

\*1: In case it is necessary to indicate the air flow volume in (l/s), the value in (m³/min.) shall be multiplied by 16.7 and rounded down the decimal point.  
 \*2: If the EUROVENT Certified models can be operated under the "extra-low" temperature condition, -7°C dry bulb and -8°C wet-bulb temperatures with rated voltage 230 V shall be used.  
 \*3: Network Impedance shall be applicable for EUROPE and CHINA models.  
 \*4: The annual consumption is calculated by multiplying the input power at 230 V (400 V) by an average of 500 hours per year in cooling mode.  
 \*5: EER and COP classification is at 230 V (400 V) only in accordance with EU directive 2002/31/EC.  
 \*6: SEER and SCOP classification is at 230V(400V) only in accordance with EN-14825. For heating, SCOP indicates the value of only Average heating season, Other fiche data indicates in an attached sheet.

# Simultaneous (Twin) -Type

## 1-1. Unit Specifications

**PE1**

### 3. Wall Mounted Type S-36PK1E5A×2 / U-71PE1E8A

| INDOOR                                |   | MODEL                                     | S-36PK1E5A×2                                   |             |             | -                                   |            |            | -     |        |   |
|---------------------------------------|---|---|--|-------------|-------------|-------------------------------------|------------|------------|-------|--------|---|
| PANEL                                 |   | MODEL                                     | -  |             |             | -                                   |            |            | -     |        |   |
| OUTDOOR                               |   | MODEL                                     | -  |             |             | U-71PE1E8A                          |            |            | -     |        |   |
| Branch pipe                           |   | MODEL                                     | -  |             |             | CZ-P155BK1                          |            |            | -     |        |   |
| Performance test condition            |   | ISO5151 / EN14511 / EN14825 / EN12102     |  |             |             |                                     |            |            |       |        |   |
| Power supply                          |   | Ø, Hz                                     | 1ø 50Hz  |             |             | 3ø 50Hz                             |            |            | Min   | Max    |   |
|                                       |   | V   | 220  | 230         | 240         | 380                                 | 400        | 415        |       |        |   |
| Capacity                              |   | kW  | 7.1  | 7.1         | 7.1         | -                                   | -          | -          | 3.2   | 8.0    |   |
|                                       |   | BTU/h                                     | 24200  | 24200       | 24200       | -                                   | -          | -          | 10900 | 27300  |   |
| Current                               |   | A   | 0.20×2   | 0.19×2      | 0.19×2      | 3.30                                | 3.20       | 3.10       | -     | -      |   |
| Input power                           |   | W   | 16×2   | 17×2        | 17×2        | 2.055k                              | 2.055k     | 2.055k     | -     | -      |   |
|                                       |   | TOTAL W                                   | -  |             |             | 2.090k                              | 2.090k     | 3.070k     | 560   | 2.650k |   |
| Annual consumption                    |   | TOTAL kWh *4                              | -  |             |             | -                                   | 1045       | -          | -     | -      |   |
| EER/EER CLASS                         |   | TOTAL (W/W) <sup>5</sup> ("A"~"G")        | -  | -           | -           | 3.40                                | 3.40 / A   | 3.40       | 5.71  | 3.02   |   |
| COOLING                               | E <sub>rp</sub> <sup>6</sup>                        | Pdesign                                   | kW   | -           | -           | -                                   | 7.1        | -          | -     | -      |   |
|                                       |   | SEER                                      | (W/W)  | -           | -           | -                                   | 6.1        | -          | -     | -      |   |
|                                       |   | Annual consumption                        | kWh  | -           | -           | -                                   | -          | 407        | -     | -      | - |
|                                       |   | Class                                     |  | -           | -           | -                                   | -          | A++        | -     | -      | - |
| Power factor                          |   | %   | -  | -           | -           | 95                                  | 93         | 92         | -     | -      |   |
| Noise indoor                          |   | dB-A (H/M/L)                              | 35/31/27                                       |             |             | -                                   | -          | -          | -     | -      |   |
|                                       |   | Power Level dB                            | 52/46/41                                       |             |             | -                                   | -          | -          | -     | -      |   |
| Noise outdoor                         |   | dB-A (H/L)                                | -  |             |             | 48/-                                |            |            | -     | -      |   |
|                                       |   | Power Level dB                            | -  |             |             | 65/-                                |            |            | -     | -      |   |
| Capacity                              |   | kW  | 8.0  | 8.0         | 8.0         | -                                   | -          | -          | 2.8   | 9.0    |   |
|                                       |   | BTU/h                                     | 27300  | 27300       | 27300       | -                                   | -          | -          | 9600  | 30700  |   |
| Current                               |   | A   | 0.20×2   | 0.19×2      | 0.19×2      | 3.35                                | 3.25       | 3.15       | -     | -      |   |
| Input power                           |   | W   | 16×2   | 17×2        | 17×2        | 2.095k                              | 2.095k     | 2.095k     | -     | -      |   |
|                                       |   | TOTAL W                                   | -  |             |             | 2.130k                              | 2.130k     | 2.130k     | 500   | 2.900k |   |
| COP/COP CLASS                         |   | TOTAL (W/W) <sup>5</sup> ("A"~"G")        | -  | -           | -           | 3.76                                | 3.76 / A   | 3.76       | 5.60  | 3.10   |   |
| HEATING                               | E <sub>rp</sub> <sup>6</sup>                        | Pdesign at -10°C                          | kW   | -           | -           | -                                   | 7.1        | -          | -     | -      |   |
|                                       |   | Tbivalent                                 | °C   | -           | -           | -                                   | -8         | -          | -     | -      |   |
|                                       |   | SCOP                                      | (W/W)  | -           | -           | -                                   | -          | 3.8        | -     | -      | - |
|                                       |   | Annual consumption                        | kWh  | -           | -           | -                                   | -          | 2616       | -     | -      | - |
| Power factor                          |   | %   | -  | -           | -           | 95                                  | 93         | 93         | -     | -      |   |
| Noise indoor                          |   | dB-A (H/M/L)                              | 35/31/27                                       |             |             | -                                   | -          | -          | -     | -      |   |
|                                       |   | Power Level dB                            | 52/46/41                                       |             |             | -                                   | -          | -          | -     | -      |   |
| Noise outdoor                         |   | dB-A (H/L)                                | -  |             |             | 50/-                                |            |            | -     | -      |   |
|                                       |   | Power Level dB                            | -  |             |             | 67/-                                |            |            | -     | -      |   |
| EXTRA LOW TEMP                        |   | Total capacity(kW) / Input power(W) / COP | -  |             |             | -                                   |            |            | -     | -      |   |
| Max Current(A) / Max Input power(W)   |   |   | 0.20×2/16×2                                    | 0.19×2/17×2 | 0.19×2/17×2 | 7.0/4.150k                          | 7.0/4.360k | 7.0/4.530k | -     | -      |   |
| Starting current(A) / Comp output(W)  |   |   | -  | -           | -           | 3.35/2.0k                           | 3.25/2.0k  | 3.15/2.0k  | -     | -      |   |
| Network Impedance(ΩMAX.)              |   |   | -  |             |             | -                                   |            |            | -     | -      |   |
| Fan motor output (Indoor/Outdoor) W   |   |   | 47×2   |             |             | 90                                  |            |            | -     | -      |   |
| Moisture removal volume               |   | L/h(Pt/h)                                 | 4.2 (2.1×2)                                    |             |             | (8.8)                               |            |            | -     | -      |   |
| External static pressure              |   | Pa  | -  |             |             | -                                   |            |            | -     | -      |   |
| Indoor Air flow                       | Cooling   | m³/min (ft³/min)                          | [11/9.5/7.5 (388/335/265)]×2                   |             |             | -                                   |            |            | -     | -      |   |
|                                       | Heating   | m³/min (ft³/min)                          | [11/9.5/7.5 (388/335/265)]×2                   |             |             | -                                   |            |            | -     | -      |   |
| Outdoor Air flow                      | Cooling   | m³/min (ft³/min)                          | -  |             |             | 60 (2119)                           |            |            | -     | -      |   |
|                                       | Heating   | m³/min (ft³/min)                          | -  |             |             | 60 (2119)                           |            |            | -     | -      |   |
| Refrigerant type / amount g(oz)       |   |   | -  |             |             | R410A                               | 2.35k      | (82.9)     | -     | -      |   |
| Product dimension                     |   | Height mm(inch)                           | 300 (11-1/32)                                  |             |             | 996 (39-7/32)                       |            |            | -     | -      |   |
|                                       |   | Width mm(inch)                            | 1065 (41-15/16)                                |             |             | 940 (37-1/32)                       |            |            | -     | -      |   |
|                                       |   | Depth mm(inch)                            | 230 (9-1/32)                                   |             |             | 340 (13-13/32)                      |            |            | -     | -      |   |
| Packing dimension                     |   | Height mm(inch)                           | 310  |             |             | 1136                                |            |            | -     | -      |   |
|                                       |   | Width mm(inch)                            | 1140   |             |             | 1055                                |            |            | -     | -      |   |
|                                       |   | Depth mm(inch)                            | 380  |             |             | 485                                 |            |            | -     | -      |   |
| Weight                                |   | (NET) kg(lb)                              | 13 (29)  |             |             | 71 (157)                            |            |            | -     | -      |   |
|                                       |   | (GROSS) kg(lb)                            | 17 (37)  |             |             | 79 (174)                            |            |            | -     | -      |   |
| Layers limit (actually)               |   |   | 15 (16)  |             |             | 2 (3)                               |            |            | -     | -      |   |
| Operation condition                   |   | Cool (DBT)                                | 18°C ~ 32°C                                    |             |             | -15°C ~ 46°C                        |            |            | -     | -      |   |
|                                       |   | Heat (DBT)                                | 16°C ~ 30°C                                    |             |             | -20°C ~ 24°C                        |            |            | -     | -      |   |
| PIPELINE                              | Pipe diameter mm (inch)                             |   | (Liquid)ø6.35(1/4) (Gas)ø12.7(1/2)             |             |             | (Liquid)ø9.52(3/8) (Gas)ø15.88(5/8) |            |            | -     | -      |   |
|                                       | Connecting method, Standard length m(ft)            |   | flared type, 5.0(16.4)                         |             |             | flared type, 5.0(16.4)              |            |            | -     | -      |   |
|                                       | Pipe length range m (ft)                            |   | 5 ~ 50 (16.4 ~ 164.0)                          |             |             | -                                   |            |            | -     | -      |   |
|                                       | Indoor unit & Outdoor unit height difference m (ft) |   | 15 (OD located lower) / 30 (OD located higher) |             |             | (49.2/98.4)                         |            |            | -     | -      |   |
| Add gas amount g/m (oz/ft)            |   | 50 (0.538)                                |  |             | -           |                                     |            | -          | -     |        |   |
| Pipe length for additional gas m (ft) |   | 30 (98.4)                                 |  |             | -           |                                     |            | -          | -     |        |   |

\*1: In case it is necessary to indicate the air flow volume in (l/s), the value in (m³/min.) shall be multiplied by 16.7 and rounded down the decimal point.

\*2: If the EUROVENT Certified models can be operated under the "extra-low" temperature condition, -7°C dry bulb and -8°C wet-bulb temperatures with rated voltage 230 V shall be used.

\*3: Network Impedance shall be applicable for EUROPE and CHINA models.

\*4: The annual consumption is calculated by multiplying the input power at 230 V (400 V) by an average of 500 hours per year in cooling mode.

\*5: EER and COP classification is at 230 V (400 V) only in accordance with EU directive 2002/31/EC.

\*6: SEER and SCOP classification is at 230V(400V) only in accordance with EN-14825. For heating, SCOP indicates the value of only Average heating season, Other fiche data indicates in an attached sheet.

# Simultaneous (Triple) -Type

## 1-1. Unit Specifications

PE1

### 3. Wall Mounted Type S-36PK1E5A×3 / U-100PE1E8A

|   |  |  |                                     |             |                                     |                |            |          |       |        |
|---|--|--|-------------------------------------|-------------|-------------------------------------|----------------|------------|----------|-------|--------|
| INDOOR  | MODEL                                    | S-36PK1E5A×3                                   |                                     |             | -                                   |                |            | -        |       |        |
| PANEL   | MODEL                                    | -  |                                     |             | -                                   |                |            | -        |       |        |
| OUTDOOR   | MODEL                                    | -  |                                     |             | U-100PE1E8A                         |                |            | -        |       |        |
| Branch pipe   | MODEL                                    | -  |                                     |             | CZ-P3HPC2                           |                |            | -        |       |        |
| Performance test condition  |  | ISO5151 / EN14511 / EN14825 / EN12102          |                                     |             |                                     |                |            |          |       |        |
| Power supply  |  | Ø, Hz  | 1ø 50Hz                             |             |                                     | 3ø 50Hz        |            |          | Min   | Max    |
|   |  | V  | 220                                 | 230         | 240                                 | 380            | 400        | 415      |       |        |
| C<br>O<br>O<br>L<br>I<br>N<br>G                                       | Capacity                                 | kW   | 10.0                                | 10.0        | 10.0                                | -              | -          | -        | 3.3   | 12.5   |
|   |  | BTU/h  | 34100                               | 34100       | 34100                               | -              | -          | -        | 11300 | 42700  |
|   | Current                                  | A  | 0.20×3                              | 0.19×3      | 0.19×3                              | 3.98           | 3.78       | 3.64     | -     | -      |
|   |  | W  | 16×3                                | 17×3        | 17×3                                | 2.525k         | 2.525k     | 2.520k   | -     | -      |
|   | Input power                              | TOTAL W  | -                                   |             |                                     | 2.575k         | 2.580k     | 2.575k   | 840   | 3.700k |
|   |  | Annual consumption                             | TOTAL kWh *4                        | -           |                                     |                | -          | 1290     | -     | -      |
|   | EER/EER CLASS                            | TOTAL (W/W) <sup>*5</sup> ("A"~"G")            | -                                   | -           | -                                   | 3.88           | 3.88 / A   | 3.88     | 3.93  | 3.38   |
|   | E <sub>rp</sub> <sup>*6</sup>            | Pdesign  | kW                                  | -           | -                                   | -              | -          | 10.0     | -     | -      |
|   |  | SEER   | (W/W)                               | -           | -                                   | -              | -          | 6.1      | -     | -      |
|   |  | Annual consumption                             | kWh                                 | -           | -                                   | -              | -          | 574      | -     | -      |
| Class   |  |  | -                                   | -           | -                                   | -              | A++        | -        | -     |        |
| Power factor  | %  | -  | -                                   | -           | 96                                  | 96             | 96         | -        | -     |        |
| Noise indoor  | dB-A (H/M/L)                             | 35/31/27                                       |                                     |             | -                                   | -              | -          | -        | -     |        |
|   | Power Level dB                           | 52/46/41                                       |                                     |             | -                                   | -              | -          | -        | -     |        |
| Noise outdoor   | dB-A (H/L)                               | -  |                                     |             | 52/-                                |                |            | -        | -     |        |
|   | Power Level dB                           | -  |                                     |             | 69/-                                |                |            | -        | -     |        |
| H<br>E<br>A<br>T<br>I<br>N<br>G                                       | Capacity                                 | kW   | 11.2                                | 11.2        | 11.2                                | -              | -          | -        | 4.1   | 14.0   |
|   |  | BTU/h  | 38200                               | 38200       | 38200                               | -              | -          | -        | 14000 | 47800  |
|   | Current                                  | A  | 0.20×3                              | 0.19×3      | 0.19×3                              | 4.35           | 4.14       | 3.98     | -     | -      |
|   |  | W  | 16×3                                | 17×3        | 17×3                                | 2.705k         | 2.705k     | 2.700k   | -     | -      |
|   | Input power                              | TOTAL W  | -                                   |             |                                     | 2.755k         | 2.760k     | 2.755k   | 900   | 4.400k |
|   |  | COP/COP CLASS                                  | TOTAL (W/W) <sup>*5</sup> ("A"~"G") | -           | -                                   | -              | 4.07       | 4.06 / A | 4.07  | 4.56   |
|   | E <sub>rp</sub> <sup>*6</sup>            | Pdesign at -10°C                               | kW                                  | -           | -                                   | -              | -          | 10.0     | -     | -      |
|   |  | Tbivalent                                      | °C                                  | -           | -                                   | -              | -          | -10      | -     | -      |
|   |  | SCOP   | (W/W)                               | -           | -                                   | -              | -          | 4.0      | -     | -      |
|   |  | Annual consumption                             | kWh                                 | -           | -                                   | -              | -          | 3500     | -     | -      |
| Class   |  | -  | -                                   | -           | -                                   | A+             | -          | -        |       |        |
| Power factor  | %  | -  | -                                   | -           | 94                                  | 94             | 94         | -        | -     |        |
| Noise indoor  | dB-A (H/M/L)                             | 35/31/27                                       |                                     |             | -                                   | -              | -          | -        | -     |        |
|   | Power Level dB                           | 52/46/41                                       |                                     |             | -                                   | -              | -          | -        | -     |        |
| Noise outdoor   | dB-A (H/L)                               | -  |                                     |             | 52/-                                |                |            | -        | -     |        |
|   | Power Level dB                           | -  |                                     |             | 69/-                                |                |            | -        | -     |        |
| EXTRA LOW TEMP <sup>†</sup> Total capacity(kW) / Input power(W) / COP |  | -  |                                     |             |                                     |                |            |          |       |        |
| Max Current(A) / Max Input power(W)                                   |  | 0.20×3/16×3                                    | 0.19×3/17×3                         | 0.19×3/17×3 | 9.0/5.550k                          | 9.0/5.850k     | 9.0/6.100k | -        |       |        |
| Starting current(A) / Comp output(W)                                  |  | -  | -                                   | -           | 4.35/3.0k                           | 4.14/3.0k      | 3.98/3.0k  | -        |       |        |
| Network Impedance(ΩMAX.)  |  | -  |                                     |             |                                     |                |            |          |       |        |
| Fan motor output (Indoor/Outdoor) W                                   |  | 47×3   |                                     |             | 90×2                                |                |            | -        |       |        |
| Moisture removal volume   |  | L/h(Pt/h)                                      | 6.0 (2.0×3)                         |             |                                     | (12.6)         |            |          | -     |        |
| External static pressure  |  | Pa   | -                                   |             |                                     | -              |            |          | -     |        |
| Indoor Air flow   | Cooling                                  | m³/min (ft³/min)                               | [11/9.5/7.5 (388/335/265)]×3        |             |                                     | -              |            |          | -     | -      |
|   | Heating                                  | m³/min (ft³/min)                               | [11/9.5/7.5 (388/335/265)]×3        |             |                                     | -              |            |          | -     | -      |
| Outdoor Air flow  | Cooling                                  | m³/min (ft³/min)                               | -                                   |             |                                     | 110 (3885)     |            | -        | -     |        |
|   | Heating                                  | m³/min (ft³/min)                               | -                                   |             |                                     | 95 (3355)      |            | -        | -     |        |
| Refrigerant type / amount g(oz)                                       |  | -  |                                     |             | R410A                               | 3.40k          | (119.9)    | -        |       |        |
| Product dimension   | Height                                   | mm(inch)                                       | 300 (11-1/32)                       |             |                                     | 1416 (55-3/4)  |            |          | -     |        |
|   | Width                                    | mm(inch)                                       | 1065 (41-15/16)                     |             |                                     | 940 (37-1/32)  |            |          | -     |        |
|   | Depth                                    | mm(inch)                                       | 230 (9-1/32)                        |             |                                     | 340 (13-13/32) |            |          | -     |        |
| Packing dimension   | Height                                   | mm(inch)                                       | 310                                 |             |                                     | 1556           |            |          | -     |        |
|   | Width                                    | mm(inch)                                       | 1140                                |             |                                     | 1055           |            |          | -     |        |
|   | Depth                                    | mm(inch)                                       | 380                                 |             |                                     | 485            |            |          | -     |        |
| Weight  | (NET)                                    | kg(lb)   | 13 (29)                             |             |                                     | 98 (216)       |            |          | -     |        |
|   | (GROSS)                                  | kg(lb)   | 17 (37)                             |             |                                     | 108 (238)      |            |          | -     |        |
| Layers limit (actually)   |  | 15 (16)  |                                     |             | 1 (2)                               |                |            | -        |       |        |
| Operation condition   | Cool (DBT)                               | 18°C ~ 32°C                                    |                                     |             | -15°C ~ 46°C                        |                |            | -        |       |        |
|   | Heat (DBT)                               | 16°C ~ 30°C                                    |                                     |             | -20°C ~ 24°C                        |                |            | -        |       |        |
| P<br>I<br>P<br>I<br>N<br>G  | Pipe diameter mm (inch)                  | (Liquid)ø6.35(1/4) (Gas)ø12.7(1/2)             |                                     |             | (Liquid)ø9.52(3/8) (Gas)ø15.88(5/8) |                |            | -        |       |        |
|   | Connecting method, Standard length m(ft) | flared type, 5.0(16.4)                         |                                     |             | flared type, 5.0(16.4)              |                |            | -        |       |        |
| Pipe length range   |  | m (ft)   |                                     |             | 5 ~ 75 (16.4 ~ 246.1)               |                |            | -        |       |        |
| Indoor unit & Outdoor unit height difference m (ft)                   |  | 15 (OD located lower) / 30 (OD located higher) |                                     |             | (49.2/98.4)                         |                |            | -        |       |        |
| Add gas amount g/m (oz/ft)  |  | 50 (0.538)                                     |                                     |             | -                                   |                |            | -        |       |        |
| Pipe length for additional gas m (ft)                                 |  | 20 (65.6)                                      |                                     |             | -                                   |                |            | -        |       |        |

\*1: In case it is necessary to indicate the air flow volume in (l/s), the value in (m³/min.) shall be multiplied by 16.7 and rounded down the decimal point.

\*2: If the EUROVENT Certified models can be operated under the "extra-low" temperature condition, -7°C dry bulb and -8°C wet-bulb temperatures with rated voltage 230 V shall be used.

\*3: Network Impedance shall be applicable for EUROPE and CHINA models.

\*4: The annual consumption is calculated by multiplying the input power at 230 V (400 V) by an average of 500 hours per year in cooling mode.

\*5: EER and COP classification is at 230 V (400 V) only in accordance with EU directive 2002/31/EC.

\*6: SEER and SCOP classification is at 230V(400V) only in accordance with EN-14825. For heating, SCOP indicates the value of only Average heating season, Other fiche data indicates in an attached sheet.

# Simultaneous (Twin) -Type

## 1-1. Unit Specifications

**PE1**

### 3. Wall Mounted Type S-50PK1E5A×2 / U-100PE1E8A

| INDOOR  |  | MODEL  | S-50PK1E5A×2                        |                       |                                     | -              |            |          | -     |        |      |
|---|--|--|-------------------------------------|-----------------------|-------------------------------------|----------------|------------|----------|-------|--------|------|
| PANEL   |  | MODEL  | -                                   |                       |                                     | -              |            |          | -     |        |      |
| OUTDOOR   |  | MODEL  | -                                   |                       |                                     | U-100PE1E8A    |            |          | -     |        |      |
| Branch pipe   |  | MODEL  | -                                   |                       |                                     | CZ-P155BK1     |            |          | -     |        |      |
| Performance test condition  |  | ISO5151 / EN14511 / EN14825 / EN12102          |                                     |                       |                                     |                |            |          |       |        |      |
| Power supply  |  | Ø, Hz  | 1ø 50Hz                             |                       |                                     | 3ø 50Hz        |            |          | Min   | Max    |      |
|   |  | V  | 220                                 | 230                   | 240                                 | 380            | 400        | 415      |       |        |      |
| C<br>O<br>O<br>L<br>I<br>N<br>G                                       | Capacity                                 | kW   | 10.0                                | 10.0                  | 10.0                                | -              | -          | -        | 3.3   | 12.5   |      |
|   |  | BTU/h  | 34100                               | 34100                 | 34100                               | -              | -          | -        | 11300 | 42700  |      |
|   | Current                                  | A  | 0.27×2                              | 0.27×2                | 0.27×2                              | 3.98           | 3.78       | 3.64     | -     | -      |      |
|   |  | W  | 26×2                                | 27×2                  | 28×2                                | 2.525k         | 2.525k     | 2.520k   | -     | -      |      |
|   | Input power                              | TOTAL W  | -                                   |                       |                                     | 2.580k         | 2.580k     | 2.580k   | 840   | 3.700k |      |
|   |  | Annual consumption                             | TOTAL kWh *4                        | -                     |                                     |                | -          | 1290     | -     | -      | -    |
|   | EER/EER CLASS                            | TOTAL (W/W) <sup>*5</sup> ("A"~"G")            | -                                   | -                     | -                                   | 3.88           | 3.88 / A   | 3.88     | 3.93  | 3.38   |      |
|   | Erp <sup>*6</sup>                        | Pdesign  | kW                                  | -                     | -                                   | -              | -          | 10.0     | -     | -      | -    |
|   |  | SEER   | (W/W)                               | -                     | -                                   | -              | -          | 6.1      | -     | -      | -    |
|   |  | Annual consumption                             | kWh                                 | -                     | -                                   | -              | -          | 574      | -     | -      | -    |
| Class   |  |  | -                                   | -                     | -                                   | -              | A++        | -        | -     | -      |      |
| Power factor  | %  | -  | -                                   | -                     | 96                                  | 96             | 96         | -        | -     |        |      |
| Noise indoor  | dB-A (H/M/L)                             | 40/36/32                                       |                                     |                       | -                                   | -              | -          | -        | -     |        |      |
|   | Power Level dB                           | 57/51/46                                       |                                     |                       | -                                   | -              | -          | -        | -     |        |      |
| Noise outdoor   | dB-A (H/L)                               | -  |                                     |                       | 52/-                                |                |            | -        | -     |        |      |
|   | Power Level dB                           | -  |                                     |                       | 69/-                                |                |            | -        | -     |        |      |
| H<br>E<br>A<br>T<br>I<br>N<br>G                                       | Capacity                                 | kW   | 11.2                                | 11.2                  | 11.2                                | -              | -          | -        | 4.1   | 14.0   |      |
|   |  | BTU/h  | 38200                               | 38200                 | 38200                               | -              | -          | -        | 14000 | 47800  |      |
|   | Current                                  | A  | 0.27×2                              | 0.27×2                | 0.27×2                              | 4.35           | 4.14       | 3.98     | -     | -      |      |
|   |  | W  | 26×2                                | 27×2                  | 28×2                                | 2.705k         | 2.705k     | 2.700k   | -     | -      |      |
|   | Input power                              | TOTAL W  | -                                   |                       |                                     | 2.760k         | 2.760k     | 2.760k   | 900   | 4.400k |      |
|   |  | COP/COP CLASS                                  | TOTAL (W/W) <sup>*5</sup> ("A"~"G") | -                     | -                                   | -              | 4.06       | 4.06 / A | 4.06  | 4.56   | 3.18 |
|   | Erp <sup>*6</sup>                        | Pdesign at -10°C                               | kW                                  | -                     | -                                   | -              | -          | 10.0     | -     | -      | -    |
|   |  | Tbivalent                                      | °C                                  | -                     | -                                   | -              | -          | -10      | -     | -      | -    |
|   |  | SCOP   | (W/W)                               | -                     | -                                   | -              | -          | 4.0      | -     | -      | -    |
|   |  | Annual consumption                             | kWh                                 | -                     | -                                   | -              | -          | 3500     | -     | -      | -    |
| Class   |  | -  | -                                   | -                     | -                                   | A+             | -          | -        | -     |        |      |
| Power factor  | %  | -  | -                                   | -                     | 94                                  | 94             | 94         | -        | -     |        |      |
| Noise indoor  | dB-A (H/M/L)                             | 40/36/32                                       |                                     |                       | -                                   | -              | -          | -        | -     |        |      |
|   | Power Level dB                           | 57/51/46                                       |                                     |                       | -                                   | -              | -          | -        | -     |        |      |
| Noise outdoor   | dB-A (H/L)                               | -  |                                     |                       | 52/-                                |                |            | -        | -     |        |      |
|   | Power Level dB                           | -  |                                     |                       | 69/-                                |                |            | -        | -     |        |      |
| EXTRA LOW TEMP <sup>†</sup> Total capacity(kW) / Input power(W) / COP |  | -  |                                     |                       |                                     |                |            |          |       |        |      |
| Max Current(A) / Max Input power(W)                                   |  | 0.27×2/26×2                                    | 0.27×2/27×2                         | 0.27×2/28×2           | 9.0/5.550k                          | 9.0/5.850k     | 9.0/6.100k |          |       |        |      |
| Starting current(A) / Comp output(W)                                  |  | -  | -                                   | -                     | 4.35/3.0k                           | 4.14/3.0k      | 3.98/3.0k  |          |       |        |      |
| Network Impedance(ΩMAX.)  |  | -  |                                     |                       |                                     |                |            |          |       |        |      |
| Fan motor output (Indoor/Outdoor) W                                   |  | 47×2   |                                     |                       | 90×2                                |                |            |          |       |        |      |
| Moisture removal volume   |  | L/h(Pt/h)                                      | 6.0 (3.0×2)                         |                       |                                     | (12.6)         |            |          |       |        |      |
| External static pressure  |  | Pa   | -                                   |                       |                                     |                |            |          |       |        |      |
| Indoor Air flow   | Cooling                                  | m³/min (ft³/min)                               | [14/12/10.5 (494/424/371)]×2        |                       |                                     | -              |            |          | -     | -      |      |
|   | Heating                                  | m³/min (ft³/min)                               | [14/12/10.5 (494/424/371)]×2        |                       |                                     | -              |            |          | -     | -      |      |
| Outdoor Air flow  | Cooling                                  | m³/min (ft³/min)                               | -                                   |                       |                                     | 110 (3885)     |            |          | -     | -      |      |
|   | Heating                                  | m³/min (ft³/min)                               | -                                   |                       |                                     | 95 (3355)      |            |          | -     | -      |      |
| Refrigerant type / amount g(oz)                                       |  | -  |                                     |                       | R410A                               |                | 3.40k      | (119.9)  | -     |        |      |
| Product dimension   | Height                                   | mm(inch)                                       | 300 (11-1/32)                       |                       |                                     | 1416 (55-3/4)  |            |          | -     | -      |      |
|   | Width                                    | mm(inch)                                       | 1065 (41-15/16)                     |                       |                                     | 940 (37-1/32)  |            |          | -     | -      |      |
|   | Depth                                    | mm(inch)                                       | 230 (9-1/32)                        |                       |                                     | 340 (13-13/32) |            |          | -     | -      |      |
| Packing dimension   | Height                                   | mm(inch)                                       | 310                                 |                       |                                     | 1556           |            |          | -     | -      |      |
|   | Width                                    | mm(inch)                                       | 1140                                |                       |                                     | 1055           |            |          | -     | -      |      |
|   | Depth                                    | mm(inch)                                       | 380                                 |                       |                                     | 485            |            |          | -     | -      |      |
| Weight  | (NET)                                    | kg(lb)   | 13 (29)                             |                       |                                     | 98 (216)       |            |          | -     | -      |      |
|   | (GROSS)                                  | kg(lb)   | 17 (37)                             |                       |                                     | 108 (238)      |            |          | -     | -      |      |
| Layers limit (actually)   |  | 15 (16)  |                                     |                       | 1 (2)                               |                |            |          |       |        |      |
| Operation condition   | Cool (DBT)                               | 18°C ~ 32°C                                    |                                     |                       | -15°C ~ 46°C                        |                |            |          |       |        |      |
|   | Heat (DBT)                               | 16°C ~ 30°C                                    |                                     |                       | -20°C ~ 24°C                        |                |            |          |       |        |      |
| P<br>I<br>P<br>I<br>N<br>G  | Pipe diameter mm (inch)                  | (Liquid)ø6.35(1/4) (Gas)ø12.7(1/2)             |                                     |                       | (Liquid)ø9.52(3/8) (Gas)ø15.88(5/8) |                |            |          |       |        |      |
|   | Connecting method, Standard length m(ft) | flared type, 5.0(16.4)                         |                                     |                       | flared type, 5.0(16.4)              |                |            |          |       |        |      |
| Pipe length range   |  | m (ft)   |                                     | 5 ~ 75 (16.4 ~ 246.1) |                                     |                |            |          |       |        |      |
| Indoor unit & Outdoor unit height difference m (ft)                   |  | 15 (OD located lower) / 30 (OD located higher) |                                     |                       | (49.2/98.4)                         |                |            |          |       |        |      |
| Add gas amount g/m (oz/ft)  |  | 50 (0.538)                                     |                                     |                       |                                     |                |            |          |       |        |      |
| Pipe length for additional gas m (ft)                                 |  | 30 (98.4)                                      |                                     |                       |                                     |                |            |          |       |        |      |

\*1: In case it is necessary to indicate the air flow volume in (l/s), the value in (m³/min.) shall be multiplied by 16.7 and rounded down the decimal point.

\*2: If the EUROVENT Certified models can be operated under the "extra-low" temperature condition, -7°C dry bulb and -8°C wet-bulb temperatures with rated voltage 230 V shall be used.

\*3: Network Impedance shall be applicable for EUROPE and CHINA models.

\*4: The annual consumption is calculated by multiplying the input power at 230 V (400 V) by an average of 500 hours per year in cooling mode.

\*5: EER and COP classification is at 230 V (400 V) only in accordance with EU directive 2002/31/EC.

\*6: SEER and SCOP classification is at 230V(400V) only in accordance with EN-14825. For heating, SCOP indicates the value of only Average heating season, Other fiche data indicates in an attached sheet.



# Single -Type

## 1-1. Unit Specifications

PE1

### 3. Wall Mounted Type S-71PK1E5A / U-71PE1E8A

|  |  |  |                                    |                       |                                     |                |            |          |       |        |      |
|--|--|--|------------------------------------|-----------------------|-------------------------------------|----------------|------------|----------|-------|--------|------|
| INDOOR   | MODEL                                    | S-71PK1E5A                                     |                                    |                       | -                                   |                |            | -        |       |        |      |
| PANEL  | MODEL                                    | -  |                                    |                       | -                                   |                |            | -        |       |        |      |
| OUTDOOR  | MODEL                                    | -  |                                    |                       | U-71PE1E8A                          |                |            | -        |       |        |      |
| Branch pipe  | MODEL                                    | -  |                                    |                       | -                                   |                |            | -        |       |        |      |
| Performance test condition                               |  | ISO5151 / EN14511 / EN14825 / EN12102          |                                    |                       |                                     |                |            |          |       |        |      |
| Power supply   |  | Ø, Hz  | 1ø 50Hz                            |                       |                                     | 3ø 50Hz        |            |          | Min   | Max    |      |
|  |  | V  | 220                                | 230                   | 240                                 | 380            | 400        | 415      |       |        |      |
| C<br>O<br>O<br>L<br>I<br>N<br>G                          | Capacity                                 | kW   | 7.1                                | 7.1                   | 7.1                                 | -              | -          | -        | 3.2   | 8.0    |      |
|  |  | BTU/h  | 24200                              | 24200                 | 24200                               | -              | -          | -        | 10900 | 27300  |      |
|  | Current                                  | A  | 0.59                               | 0.58                  | 0.52                                | 3.25           | 3.15       | 3.05     | -     | -      |      |
|  |  | W  | 57                                 | 57                    | 57                                  | 2.030k         | 2.030k     | 2.030k   | -     | -      |      |
|  | Input power                              | TOTAL W  | -                                  |                       |                                     | 2.090k         | 2.090k     | 2.090k   | 560   | 2.650k |      |
|  |  | Annual consumption                             | TOTAL kWh *4                       | -                     |                                     |                | -          | 1045     | -     | -      | -    |
|  | EER/EER CLASS                            | TOTAL (W/W) <sup>5</sup> ("A"~"G")             | -                                  | -                     | -                                   | 3.40           | 3.40 / A   | 3.40     | 5.71  | 3.02   |      |
|  | Erp *6                                   | Pdesign  | kW                                 | -                     | -                                   | -              | -          | 7.1      | -     | -      | -    |
|  |  | SEER   | (W/W)                              | -                     | -                                   | -              | -          | 6.1      | -     | -      | -    |
|  |  | Annual consumption                             | kWh                                | -                     | -                                   | -              | -          | 407      | -     | -      | -    |
| Class  |  |  | -                                  | -                     | -                                   | -              | A++        | -        | -     | -      |      |
| Power factor   | %  | -  | -                                  | -                     | 95                                  | 93             | 93         | -        | -     |        |      |
| Noise indoor   | dB-A (H/M/L)                             | 47/44/40                                       |                                    |                       | -                                   | -              | -          | -        | -     |        |      |
|  | Power Level dB                           | 64/59/54                                       |                                    |                       | -                                   | -              | -          | -        | -     |        |      |
| Noise outdoor  | dB-A (H/L)                               | -  |                                    |                       | 48/-                                |                |            | -        | -     |        |      |
|  | Power Level dB                           | -  |                                    |                       | 65/-                                |                |            | -        | -     |        |      |
| H<br>E<br>A<br>T<br>I<br>N<br>G                          | Capacity                                 | kW   | 8.0                                | 8.0                   | 8.0                                 | -              | -          | -        | 2.8   | 9.0    |      |
|  |  | BTU/h  | 27300                              | 27300                 | 27300                               | -              | -          | -        | 9600  | 30700  |      |
|  | Current                                  | A  | 0.59                               | 0.58                  | 0.52                                | 3.30           | 3.20       | 3.10     | -     | -      |      |
|  |  | W  | 57                                 | 57                    | 57                                  | 2.070k         | 2.070k     | 2.070k   | -     | -      |      |
|  | Input power                              | TOTAL W  | -                                  |                       |                                     | 2.130k         | 2.130k     | 2.130k   | 500   | 2.900k |      |
|  |  | COP/COP CLASS                                  | TOTAL (W/W) <sup>5</sup> ("A"~"G") | -                     | -                                   | -              | 3.76       | 3.76 / A | 3.76  | 5.60   | 3.10 |
|  | Erp *6                                   | Pdesign at -10°C                               | kW                                 | -                     | -                                   | -              | -          | 7.1      | -     | -      | -    |
|  |  | Tbivalent                                      | °C                                 | -                     | -                                   | -              | -          | -9       | -     | -      | -    |
|  |  | SCOP   | (W/W)                              | -                     | -                                   | -              | -          | 3.8      | -     | -      | -    |
|  |  | Annual consumption                             | kWh                                | -                     | -                                   | -              | -          | 2616     | -     | -      | -    |
| Class  |  | -  | -                                  | -                     | -                                   | A              | -          | -        | -     |        |      |
| Power factor   | %  | -  | -                                  | -                     | 95                                  | 93             | 93         | -        | -     |        |      |
| Noise indoor   | dB-A (H/M/L)                             | 47/44/40                                       |                                    |                       | -                                   | -              | -          | -        | -     |        |      |
|  | Power Level dB                           | 64/59/54                                       |                                    |                       | -                                   | -              | -          | -        | -     |        |      |
| Noise outdoor  | dB-A (H/L)                               | -  |                                    |                       | 50/-                                |                |            | -        | -     |        |      |
|  | Power Level dB                           | -  |                                    |                       | 67/-                                |                |            | -        | -     |        |      |
| EXTRA LOW TEMP Total capacity(kW) / Input power(W) / COP |  | -  |                                    |                       |                                     |                |            |          |       |        |      |
| Max Current(A) / Max Input power(W)                      |  | 0.59/57  | 0.58/57                            | 0.52/57               | 7.0/4.150k                          | 7.0/4.360k     | 7.0/4.530k | -        |       |        |      |
| Starting current(A) / Comp output(W)                     |  | -  | -                                  | -                     | 3.30/2.0k                           | 3.20/2.0k      | 3.10/2.0k  | -        |       |        |      |
| Network Impedance(ΩMAX.)                                 |  | -  |                                    |                       |                                     |                |            |          |       |        |      |
| Fan motor output (Indoor/Outdoor) W                      |  | 47   |                                    |                       | 90                                  |                |            | -        |       |        |      |
| Moisture removal volume                                  |  | L/h(Pt/h)                                      | 4.2                                | (8.8)                 |                                     | -              |            |          | -     |        |      |
| External static pressure                                 |  | Pa   | -                                  |                       |                                     | -              |            |          | -     |        |      |
| Indoor Air flow  | Cooling                                  | m³/min (ft³/min)                               | 18/14.5/11.5 (636/512/406)         |                       |                                     | -              |            |          | -     |        |      |
|  | Heating                                  | m³/min (ft³/min)                               | 18/14.5/11.5 (636/512/406)         |                       |                                     | -              |            |          | -     |        |      |
| Outdoor Air flow   | Cooling                                  | m³/min (ft³/min)                               | -                                  |                       |                                     | 60             | (2119)     |          | -     |        |      |
|  | Heating                                  | m³/min (ft³/min)                               | -                                  |                       |                                     | 60             | (2119)     |          | -     |        |      |
| Refrigerant type / amount g(oz)                          |  | -  |                                    |                       | R410A                               | 2.35k          | (82.9)     |          | -     |        |      |
| Product dimension  | Height                                   | mm(inch)                                       | 300 (11-1/32)                      |                       |                                     | 996 (39-7/32)  |            |          | -     |        |      |
|  | Width                                    | mm(inch)                                       | 1065 (41-15/16)                    |                       |                                     | 940 (37-1/32)  |            |          | -     |        |      |
|  | Depth                                    | mm(inch)                                       | 230 (9-1/32)                       |                       |                                     | 340 (13-13/32) |            |          | -     |        |      |
| Packing dimension  | Height                                   | mm(inch)                                       | 310                                |                       |                                     | 1136           |            |          | -     |        |      |
|  | Width                                    | mm(inch)                                       | 1140                               |                       |                                     | 1055           |            |          | -     |        |      |
|  | Depth                                    | mm(inch)                                       | 380                                |                       |                                     | 485            |            |          | -     |        |      |
| Weight   | (NET)                                    | kg(lb)   | 14.5 (32)                          |                       |                                     | 71 (157)       |            |          | -     |        |      |
|  | (GROSS)                                  | kg(lb)   | 18 (40)                            |                       |                                     | 79 (174)       |            |          | -     |        |      |
| Layers limit (actually)                                  |  | 15 (16)  |                                    |                       | 2 (3)                               |                |            | -        |       |        |      |
| Operation condition                                      | Cool (DBT)                               | 18°C ~ 32°C                                    |                                    |                       | -15°C ~ 46°C                        |                |            | -        |       |        |      |
|  | Heat (DBT)                               | 16°C ~ 30°C                                    |                                    |                       | -20°C ~ 24°C                        |                |            | -        |       |        |      |
| P<br>I<br>P<br>I<br>N<br>G                               | Pipe diameter mm (inch)                  | (Liquid)ø9.52(3/8) (Gas)ø15.88(5/8)            |                                    |                       | (Liquid)ø9.52(3/8) (Gas)ø15.88(5/8) |                |            | -        |       |        |      |
|  | Connecting method, Standard length m(ft) | flared type, 5.0(16.4)                         |                                    |                       | flared type, 5.0(16.4)              |                |            | -        |       |        |      |
| Pipe length range  |  | m (ft)   |                                    | 5 ~ 50 (16.4 ~ 164.0) |                                     | -              |            |          |       |        |      |
| Indoor unit & Outdoor unit height difference m (ft)      |  | 15 (OD located lower) / 30 (OD located higher) |                                    |                       | (49.2/98.4)                         |                |            | -        |       |        |      |
| Add gas amount g/m (oz/ft)                               |  | 50 (0.538)                                     |                                    |                       | -                                   |                |            | -        |       |        |      |
| Pipe length for additional gas                           |  | m (ft)   |                                    | 30 (98.4)             |                                     | -              |            |          |       |        |      |

\*1: In case it is necessary to indicate the air flow volume in (l/s), the value in (m³/min.) shall be multiplied by 16.7 and rounded down the decimal point.  
 \*2: If the EUROVENT Certified models can be operated under the "extra-low" temperature condition, -7°C dry bulb and -8°C wet-bulb temperatures with rated voltage 230 V shall be used.  
 \*3: Network Impedance shall be applicable for EUROPE and CHINA models.  
 \*4: The annual consumption is calculated by multiplying the input power at 230 V (400 V) by an average of 500 hours per year in cooling mode.  
 \*5: EER and COP classification is at 230 V (400 V) only in accordance with EU directive 2002/31/EC.  
 \*6: SEER and SCOP classification is at 230V(400V) only in accordance with EN-14825. For heating, SCOP indicates the value of only Average heating season, Other fiche data indicates in an attached sheet.

# Single -Type

## 1-1. Unit Specifications

**PE1**

### 3. Wall Mounted Type S-100PK1E5A / U-100PE1E8A

| INDOOR   |  | MODEL                               | S-100PK1E5A                         |  |                                       | -                                   |             |          | -     |        |      |
|--|--|-------------------------------------|-------------------------------------|--|---------------------------------------|-------------------------------------|-------------|----------|-------|--------|------|
| PANEL  |  | MODEL                               | -                                   |  |                                       | -                                   |             |          | -     |        |      |
| OUTDOOR  |  | MODEL                               | -                                   |  |                                       | U-100PE1E8A                         |             |          | -     |        |      |
| Branch pipe  |  | MODEL                               | -                                   |  |                                       | -                                   |             |          | -     |        |      |
| Performance test condition                                 |  |                                     |                                     |  | ISO5151 / EN14511 / EN14825 / EN12102 |                                     |             |          |       |        |      |
| Power supply   |  | Ø, Hz                               | 1ø 50Hz                             |  |                                       | 3ø 50Hz                             |             |          |       |        |      |
|  |  | V                                   | 220                                 | 230  | 240                                   | 380                                 | 400         | 415      | Min   | Max    |      |
| C<br>O<br>O<br>L<br>I<br>N<br>G                            | Capacity                                 | kW                                  | 9.5                                 | 9.5  | 9.5                                   | -                                   | -           | -        | 3.3   | 10.5   |      |
|  |  | BTU/h                               | 32400                               | 32400  | 32400                                 | -                                   | -           | -        | 11300 | 35800  |      |
|  | Current                                  | A                                   | 0.61                                | 0.59   | 0.55                                  | 4.60                                | 4.40        | 4.30     | -     | -      |      |
|  |  | W                                   | 65                                  | 65   | 65                                    | 2.855k                              | 2.855k      | 2.855k   | -     | -      |      |
|  | Input power                              | TOTAL W                             |                                     |  |                                       | 2.920k                              | 2.920k      | 2.920k   | 840   | 3.400k |      |
|  |  | Annual consumption                  | TOTAL kWh *4                        |  |                                       |                                     | -           | 1460     | -     | -      | -    |
|  | EER/EER CLASS                            | TOTAL (W/W) <sup>*5</sup> ("A"~"G") | -                                   | -  | -                                     | 3.25                                | 3.25 / A    | 3.25     | 3.93  | 3.09   |      |
|  | Erp <sup>*6</sup>                        | Pdesign                             | kW                                  | -  | -                                     | -                                   | -           | 9.5      | -     | -      | -    |
|  |  | SEER                                | (W/W)                               | -  | -                                     | -                                   | -           | 6.0      | -     | -      | -    |
|  |  | Annual consumption                  | kWh                                 | -  | -                                     | -                                   | -           | 554      | -     | -      | -    |
| Class  |  |                                     | -                                   | -  | -                                     | -                                   | A+          | -        | -     | -      |      |
| Power factor   | %  | -                                   | -                                   | -  | 94                                    | 94                                  | 92          | -        | -     |        |      |
| Noise indoor   | dB-A (H/M/L)                             | 49/45/41                            |                                     |  | -                                     | -                                   | -           | -        | -     |        |      |
|  | Power Level dB                           | 65/60/55                            |                                     |  | -                                     | -                                   | -           | -        | -     |        |      |
| Noise outdoor  | dB-A (H/L)                               | -                                   |                                     |  | 52/-                                  |                                     |             | -        | -     |        |      |
|  | Power Level dB                           | -                                   |                                     |  | 69/-                                  |                                     |             | -        | -     |        |      |
| H<br>E<br>A<br>T<br>I<br>N<br>G                            | Capacity                                 | kW                                  | 9.5                                 | 9.5  | 9.5                                   | -                                   | -           | -        | 4.1   | 11.5   |      |
|  |  | BTU/h                               | 32400                               | 32400  | 32400                                 | -                                   | -           | -        | 14000 | 39200  |      |
|  | Current                                  | A                                   | 0.62                                | 0.60   | 0.56                                  | 3.85                                | 3.70        | 3.60     | -     | -      |      |
|  |  | W                                   | 65                                  | 65   | 65                                    | 2.405k                              | 2.405k      | 2.405k   | -     | -      |      |
|  | Input power                              | TOTAL W                             |                                     |  |                                       | 2.470k                              | 2.470k      | 2.470k   | 900   | 3.350k |      |
|  |  | COP/COP CLASS                       | TOTAL (W/W) <sup>*5</sup> ("A"~"G") | -  | -                                     | -                                   | 3.85        | 3.85 / A | 3.85  | 4.56   | 3.43 |
|  | Erp <sup>*6</sup>                        | Pdesign at -10°C                    | kW                                  | -  | -                                     | -                                   | -           | 9.5      | -     | -      | -    |
|  |  | Tbivalent                           | °C                                  | -  | -                                     | -                                   | -           | -10      | -     | -      | -    |
|  |  | SCOP                                | (W/W)                               | -  | -                                     | -                                   | -           | 3.8      | -     | -      | -    |
|  |  | Annual consumption                  | kWh                                 | -  | -                                     | -                                   | -           | 3500     | -     | -      | -    |
| Class  |  | -                                   | -                                   | -  | -                                     | A                                   | -           | -        | -     |        |      |
| Power factor   | %  | -                                   | -                                   | -  | 95                                    | 94                                  | 93          | -        | -     |        |      |
| Noise indoor   | dB-A (H/M/L)                             | 49/45/41                            |                                     |  | -                                     | -                                   | -           | -        | -     |        |      |
|  | Power Level dB                           | 65/60/55                            |                                     |  | -                                     | -                                   | -           | -        | -     |        |      |
| Noise outdoor  | dB-A (H/L)                               | -                                   |                                     |  | 52/-                                  |                                     |             | -        | -     |        |      |
|  | Power Level dB                           | -                                   |                                     |  | 69/-                                  |                                     |             | -        | -     |        |      |
| EXTRA LOW TEMP   Total capacity(kW) / Input power(W) / COP |  |                                     |                                     |  |                                       |                                     |             |          |       |        |      |
| Max Current(A) / Max Input power(W)                        |  | 0.62/65                             | 0.60/65                             | 0.56/65  | 9.0/5.630 k                           | 9.0/5.860 k                         | 9.0/6.020 k |          |       |        |      |
| Starting current(A) / Comp output(W)                       |  | -                                   | -                                   | -  | 4.60/3.0k                             | 4.40/3.0k                           | 4.30/3.0k   |          |       |        |      |
| Network Impedance(ΩMAX.)                                   |  |                                     |                                     |  |                                       |                                     |             |          |       |        |      |
| Fan motor output (Indoor/Outdoor) W                        |  |                                     |                                     | 47   |                                       | 90×2                                |             |          |       |        |      |
| Moisture removal volume                                    |  | L/h(Pt/h)                           |                                     | 5.7 (12.0)                                     |                                       |                                     |             |          |       |        |      |
| External static pressure                                   |  | Pa                                  |                                     |  |                                       |                                     |             |          |       |        |      |
| Indoor Air flow  | Cooling                                  | m³/min (ft³/min)                    |                                     | 19/16.5/13 (671/583/459)                       |                                       |                                     |             |          |       |        |      |
|  | Heating                                  | m³/min (ft³/min)                    |                                     | 19/16.5/13 (671/583/459)                       |                                       |                                     |             |          |       |        |      |
| Outdoor Air flow   | Cooling                                  | m³/min (ft³/min)                    |                                     |  |                                       | 110 (3885)                          |             |          |       |        |      |
|  | Heating                                  | m³/min (ft³/min)                    |                                     |  |                                       | 95 (3355)                           |             |          |       |        |      |
| Refrigerant type / amount g(oz)                            |  |                                     |                                     |  |                                       | R410A 3.40k (119.9)                 |             |          |       |        |      |
| Product dimension  | Height                                   | mm(inch)                            |                                     | 300 (11-1/32)                                  |                                       | 1416 (55-3/4)                       |             |          |       |        |      |
|  | Width                                    | mm(inch)                            |                                     | 1065 (41-15/16)                                |                                       | 940 (37-1/32)                       |             |          |       |        |      |
|  | Depth                                    | mm(inch)                            |                                     | 230 (9-1/32)                                   |                                       | 340 (13-13/32)                      |             |          |       |        |      |
| Packing dimension  | Height                                   | mm(inch)                            |                                     | 310  |                                       | 1556                                |             |          |       |        |      |
|  | Width                                    | mm(inch)                            |                                     | 1140   |                                       | 1055                                |             |          |       |        |      |
|  | Depth                                    | mm(inch)                            |                                     | 380  |                                       | 485                                 |             |          |       |        |      |
| Weight   | (NET)                                    | kg(lb)                              |                                     | 14.5 (32)                                      |                                       | 98 (216)                            |             |          |       |        |      |
|  | (GROSS)                                  | kg(lb)                              |                                     | 18 (40)  |                                       | 108 (238)                           |             |          |       |        |      |
| Layers limit (actually)                                    |  |                                     |                                     | 15 (16)  |                                       | 1 (2)                               |             |          |       |        |      |
| Operation condition  | Cool (DBT)                               |                                     |                                     | 18°C ~ 32°C                                    |                                       | -15°C ~ 46°C                        |             |          |       |        |      |
|  | Heat (DBT)                               |                                     |                                     | 16°C ~ 30°C                                    |                                       | -20°C ~ 24°C                        |             |          |       |        |      |
| P<br>I<br>P<br>I<br>N<br>G                                 | Pipe diameter mm (inch)                  |                                     |                                     | (Liquid)ø9.52(3/8) (Gas)ø15.88(5/8)            |                                       | (Liquid)ø9.52(3/8) (Gas)ø15.88(5/8) |             |          |       |        |      |
|  | Connecting method, Standard length m(ft) |                                     |                                     | flared type, 5.0(16.4)                         |                                       | flared type, 5.0(16.4)              |             |          |       |        |      |
| Pipe length range  |  | m (ft)                              |                                     | 5 ~ 75 (16.4 ~ 246.1)                          |                                       |                                     |             |          |       |        |      |
| Indoor unit & Outdoor unit height difference m (ft)        |  |                                     |                                     | 15 (OD located lower) / 30 (OD located higher) |                                       | (49.2/98.4)                         |             |          |       |        |      |
| Add gas amount g/m (oz/ft)                                 |  |                                     |                                     | 50 (0.538)                                     |                                       |                                     |             |          |       |        |      |
| Pipe length for additional gas                             |  | m (ft)                              |                                     | 30 (98.4)                                      |                                       |                                     |             |          |       |        |      |

\*1: In case it is necessary to indicate the air flow volume in (l/s), the value in (m³/min.) shall be multiplied by 16.7 and rounded down the decimal point.

\*2: If the EUROVENT Certified models can be operated under the "extra-low" temperature condition, -7°C dry bulb and -8°C wet-bulb temperatures with rated voltage 230 V shall be used.

\*3: Network Impedance shall be applicable for EUROPE and CHINA models.

\*4: The annual consumption is calculated by multiplying the input power at 230 V (400 V) by an average of 500 hours per year in cooling mode.

\*5: EER and COP classification is at 230 V (400 V) only in accordance with EU directive 2002/31/EC.

\*6: SEER and SCOP classification is at 230V(400V) only in accordance with EN-14825. For heating, SCOP indicates the value of only Average heating season, Other fiche data indicates in an attached sheet.

# Single -Type

## 1-1. Unit Specifications

**PE2**

### 4. Low Silhouette Ducted Type S-36PF1E5A / U-36PE2E5A

| INDOOR   |   | MODEL  | S-36PF1E5A                               |                       |                                    | -          |            |        | -    |        |      |
|--|---|--|--|-----------------------|------------------------------------|------------|------------|--------|------|--------|------|
| OUTDOOR  |   | MODEL  | -  |                       |                                    | U-36PE2E5A |            |        | -    |        |      |
| Branch pipe  |   | MODEL  | -  |                       |                                    | -          |            |        | -    |        |      |
| Performance test condition                               |   | ISO13253 / EN14511 / EN12102 / EN14825           |  |                       |                                    |            |            |        |      |        |      |
| Power supply   |   | Ø, Hz  | 1ø 50Hz                                  |                       |                                    | 1ø 50Hz    |            |        |      |        |      |
|  |   | V  | 220V                                     | 230V                  | 240V                               | 220V       | 230V       | 240V   | Min  | Max    |      |
| C<br>O<br>O<br>L<br>I<br>N<br>G                          | Capacity  | kW   | 3.6                                      | 3.6                   | 3.6                                | -          | -          | -      | 1.5  | 4.0    |      |
|  |   | BTU/h  | 12300                                    | 12300                 | 12300                              | -          | -          | -      | 5100 | 13600  |      |
|  | Current   | A  | 0.60                                     | 0.57                  | 0.56                               | 3.70       | 3.50       | 3.40   | -    | -      |      |
|  |   | W  | 70                                       | 70                    | 70                                 | 0.740k     | 0.740k     | 0.740k | -    | -      |      |
|  | Input power   | TOTAL W  | -  |                       |                                    | 0.810k     | 0.810k     | 0.810k | 290  | 1.000k |      |
|  |   | Annual consumption                               | TOTAL kWh *4                             | -                     |                                    |            | -          | 405    | -    | -      | -    |
|  | EER/EER CLASS                                       | TOTAL (W/W) *5 / ("A"-*G)                        | -  | -                     | -                                  | 4.44       | 4.44/A     | 4.44   | 5.17 | 4.00   |      |
|  | Erp *6  | Pdesign  | kW                                       | -                     | -                                  | -          | -          | 3.6    | -    | -      | -    |
|  |   | SEER   | (W/W)                                    | -                     | -                                  | -          | -          | 5.7    | -    | -      | -    |
|  |   | Annual consumption                               | kWh                                      | -                     | -                                  | -          | -          | 221    | -    | -      | -    |
| Class  |   |  | -  | -                     | -                                  | -          | A+         | -      | -    | -      |      |
| Power factor   | %   | -  | -  | -                     | 91                                 | 91         | 91         | -      | -    |        |      |
| Noise indoor   | dB-A (H/M/L)  | 33/29/25   |  |                       | -                                  | -          | -          | -      | -    |        |      |
|  | Power Level dB                                      | 55/51/47   |  |                       | -                                  | -          | -          | -      | -    |        |      |
| Noise outdoor  | dB-A (H/L)  | -  |  |                       | -                                  | 45/-       | -          | -      | -    |        |      |
|  | Power Level dB                                      | -  |  |                       | -                                  | 64/-       | -          | -      | -    |        |      |
| H<br>E<br>A<br>T<br>I<br>N<br>G                          | Capacity  | kW   | 4.0                                      | 4.0                   | 4.0                                | -          | -          | -      | 1.5  | 5.0    |      |
|  |   | BTU/h  | 13600                                    | 13600                 | 13600                              | -          | -          | -      | 5100 | 17100  |      |
|  | Current   | A  | 0.60                                     | 0.57                  | 0.56                               | 4.05       | 3.85       | 3.70   | -    | -      |      |
|  |   | W  | 70                                       | 70                    | 70                                 | 0.810k     | 0.810k     | 0.810k | -    | -      |      |
|  | Input power   | TOTAL W  | -  |                       |                                    | 0.880k     | 0.880k     | 0.880k | 240  | 1.200k |      |
|  |   | COP/COP CLASS                                    | TOTAL (W/W) *7 / ("A"-*G)                | -                     | -                                  | -          | 4.55       | 4.55/A | 4.55 | 6.25   | 4.17 |
|  | Erp *6  | Pdesign at -10°C                                 | kW                                       | -                     | -                                  | -          | -          | 3.6    | -    | -      | -    |
|  |   | Tbivalent  | °C                                       | -                     | -                                  | -          | -          | -10    | -    | -      | -    |
|  |   | SCOP   | (W/W)                                    | -                     | -                                  | -          | -          | 3.9    | -    | -      | -    |
|  |   | Annual consumption                               | kWh                                      | -                     | -                                  | -          | -          | 1292   | -    | -      | -    |
| Class  |   | -  | -  | -                     | -                                  | A          | -          | -      | -    |        |      |
| Power factor   | %   | -  | -  | -                     | 91                                 | 91         | 91         | -      | -    |        |      |
| Noise indoor   | dB-A (H/M/L)  | 33/29/25   |  |                       | -                                  | -          | -          | -      | -    |        |      |
|  | Power Level dB                                      | 55/51/47   |  |                       | -                                  | -          | -          | -      | -    |        |      |
| Noise outdoor  | dB-A (H/L)  | -  |  |                       | -                                  | 46/-       | -          | -      | -    |        |      |
|  | Power Level dB                                      | -  |  |                       | -                                  | 66/-       | -          | -      | -    |        |      |
| EXTRA LOW TEMP Total capacity(kW) / Input power(W) / COP |   | -  |  |                       |                                    |            |            |        |      |        |      |
| Max Current(A) / Max Input power(W)                      |   | 0.86/105   | 0.82/105                                 | 0.79/105              | 11.0/2.20k                         | 11.0/2.30k | 11.0/2.40k | -      |      |        |      |
| Starting current(A) / Comp output(W)                     |   | -  | -  | -                     | 4.05/1.1k                          | 3.85/1.1k  | 3.70/1.1k  | -      |      |        |      |
| Network Impedance(ΩMAX.)                                 |   | -  |  |                       |                                    |            |            |        |      |        |      |
| Fan motor output (Indoor/Outdoor) W                      |   | 120  |  |                       | 60                                 |            |            | -      |      |        |      |
| Moisture removal volume                                  |   | L/h(Pt/h)  | 2.1                                      | (4.4)                 |                                    | -          |            |        | -    |        |      |
| External static pressure                                 |   | Pa   | 70 (MIN10 - MAX150)                      |                       |                                    | -          |            |        | -    |        |      |
| Indoor Air flow  | Cooling   | m³/min (ft³/min)                                 | 14.0 / 13.0 / 10.0 (494) / (459) / (353) |                       |                                    | -          |            |        | -    |        |      |
|  | Heating   | m³/min (ft³/min)                                 | 14.0 / 13.0 / 10.0 (494) / (459) / (353) |                       |                                    | -          |            |        | -    |        |      |
| Outdoor Air flow   | Cooling   | m³/min (ft³/min)                                 | -  |                       |                                    | 38         | (1342)     |        | -    |        |      |
|  | Heating   | m³/min (ft³/min)                                 | -  |                       |                                    | 38         | (1342)     |        | -    |        |      |
| Refrigerant type / amount g(oz)                          |   | -  |  |                       | R410A                              | 1.40k      | (49.4)     |        | -    |        |      |
| Product dimension  | Height  | mm(inch)   | 290                                      | (11-13/32)            |                                    | 619        | (24-3/8)   |        | -    |        |      |
|  | Width   | mm(inch)   | 800                                      | (31-1/2)              |                                    | 799        | (31-29/64) |        | -    |        |      |
|  | Depth   | mm(inch)   | 700                                      | (27-9/16)             |                                    | 299        | (11-49/64) |        | -    |        |      |
| Product dimension (Panel)                                |   | H×W×D mm, inch                                   | -  |                       |                                    | -          |            |        | -    |        |      |
| Packing dimension  | Height  | mm(inch)   | 355                                      | (13-31/32)            |                                    | 688        |            |        | -    |        |      |
|  | Width   | mm(inch)   | 1014                                     | (39-15/16)            |                                    | 931        |            |        | -    |        |      |
|  | Depth   | mm(inch)   | 850                                      | (33-15/32)            |                                    | 422        |            |        | -    |        |      |
| Weight   | (NET)   | kg(lb)   | 28                                       | (62)                  |                                    | 39         | (86)       |        | -    |        |      |
|  | (GROSS)   | kg(lb)   | 35                                       | (77)                  |                                    | 44         | (97)       |        | -    |        |      |
|  | Panel (NET)   | kg(lb)   | -  |                       |                                    | -          |            |        | -    |        |      |
| Layers limit (actually)                                  |   | 9 (10)   |  |                       | 5 (6)                              |            |            | -      |      |        |      |
| Operation condition                                      | Cool (DBT)  | 18°C ~ 32°C                                      |  |                       | -15°C ~ 46°C                       |            |            | -      |      |        |      |
|  | Heat (DBT)  | 16°C ~ 30°C                                      |  |                       | -20°C ~ 24°C                       |            |            | -      |      |        |      |
| P<br>I<br>P<br>E<br>N<br>G                               | Pipe diameter mm (inch)                             | (Liquid)ø6.35(1/4) (Gas)ø12.7(1/2)               |  |                       | (Liquid)ø6.35(1/4) (Gas)ø12.7(1/2) |            |            | -      |      |        |      |
|  | Connecting method, Standard length m(ft)            | flared type, 5.0(16.4)                           |  |                       | flared type, 5.0(16.4)             |            |            | -      |      |        |      |
| I<br>N<br>G  | Pipe length range                                   | m (ft)   |  | 3 ~ 40m (9.8 ~ 131.2) |                                    |            | -          |        |      |        |      |
|  | Indoor unit & Outdoor unit height difference m (ft) | 15m (OD located lower) / 30m (OD located higher) |  |                       | (49.2/98.4)                        |            |            | -      |      |        |      |
|  | Add gas amount g/m (oz/ft)                          | 20g  |  |                       | (0.215)                            |            |            | -      |      |        |      |
|  | Pipe length for additional gas                      | m (ft)   |  | 30m (98.4)            |                                    |            | -          |        |      |        |      |

\*1: In case it is necessary to indicate the air flow volume in (l/s), the value in (m³/min.) shall be multiplied by 16.7 and rounded down the decimal point.  
 \*2: If the EUROVENT Certified models can be operated under the "extra-low" temperature condition, -7°C dry bulb and -8°C wet-bulb temperatures with rated voltage 230 V shall be used.  
 \*3: Network Impedance shall be applicable for EUROPE and CHINA models.  
 \*4: The annual consumption is calculated by multiplying the input power at 230 V (400 V) by an average of 500 hours per year in cooling mode.  
 \*5: EER and COP classification is at 230 V (400 V) only in accordance with EU directive 2002/31/EC.  
 \*6: SEER and SCOP classification is at 230V(400V) only in accordance with EN-14825. For heating, SCOP indicates the value of only Average heating season, Other fiche data indicates in an attached sheet.

# Simultaneous (Twin) -Type

## 1-1. Unit Specifications

**PE1**

### 4. Low Silhouette Ducted Type S-36PF1E5A×2 / U-71PE1E5A

| INDOOR   |  | MODEL  | S-36PF1E5A×2               |              |                                     | -              |             |          | -    |        |      |
|--|--|--|----------------------------|--------------|-------------------------------------|----------------|-------------|----------|------|--------|------|
| OUTDOOR  |  | MODEL  | -                          |              |                                     | U-71PE1E5A     |             |          | -    |        |      |
| Branch pipe  |  | MODEL  | CZ-P155BK1                 |              |                                     |                |             |          |      |        |      |
| Performance test condition                               |  | ISO13253 / EN14511 / EN14825 / EN12102         |                            |              |                                     |                |             |          |      |        |      |
| Power supply   |  | ∅, Hz  | 1∅ 50Hz                    |              |                                     | 1∅ 50Hz        |             |          |      |        |      |
|  |  | V  | 220                        | 230          | 240                                 | 220            | 230         | 240      | Min  | Max    |      |
| C<br>O<br>O<br>L<br>I<br>N<br>G                          | Capacity                                 | kW   | 7.10                       | 7.10         | 7.10                                | -              | -           | -        | 2.5  | 8.0    |      |
|  |  | BTU/h  | 24200                      | 24200        | 24200                               | -              | -           | -        | 8500 | 27300  |      |
|  | Current                                  | A  | 0.60×2                     | 0.57×2       | 0.56×2                              | 8.90           | 8.60        | 8.30     | -    | -      |      |
|  |  | W  | 70×2                       | 70×2         | 70×2                                | 1.730k         | 1.730k      | 1.730k   | -    | -      |      |
|  | Input power                              | TOTAL W  | -                          |              |                                     | 1.870k         | 1.870k      | 1.870k   | 530  | 2.650k |      |
|  |  | Annual consumption                             | TOTAL kWh *4               | -            |                                     |                | -           | 935      | -    | -      | -    |
|  | EER/EER CLASS                            | TOTAL (W/W) *5 / ("A"-*G)                      | -                          | -            | -                                   | 3.80           | 3.80 / A    | 3.80     | 4.72 | 3.02   |      |
|  | Erp *6                                   | Pdesign  | kW                         | -            | -                                   | -              | -           | 7.1      | -    | -      | -    |
|  |  | SEER   | (W/W)                      | -            | -                                   | -              | -           | 6.2      | -    | -      | -    |
|  |  | Annual consumption                             | kWh                        | -            | -                                   | -              | -           | 401      | -    | -      | -    |
|  |  | Class  |                            | -            | -                                   | -              | -           | A++      | -    | -      | -    |
|  | Power factor                             | %  | -                          | -            | -                                   | 96             | 95          | 94       | -    | -      |      |
|  | Noise indoor                             | dB-A (H/M/L)                                   | 33/29/25                   |              |                                     | -              | -           | -        | -    | -      |      |
|  |  | Power Level dB                                 | 55/51/47                   |              |                                     | -              | -           | -        | -    | -      |      |
| Noise outdoor  | dB-A (H/L)                               | -  |                            |              | -                                   | 48/-           | -           | -        | -    |        |      |
|  | Power Level dB                           | -  |                            |              | -                                   | 65/-           | -           | -        | -    |        |      |
| H<br>E<br>A<br>T<br>I<br>N<br>G                          | Capacity                                 | kW   | 8.0                        | 8.0          | 8.0                                 | -              | -           | -        | 2.0  | 9.0    |      |
|  |  | BTU/h  | 27300                      | 27300        | 27300                               | -              | -           | -        | 6800 | 30700  |      |
|  | Current                                  | A  | 0.60×2                     | 0.57×2       | 0.56×2                              | 9.90           | 9.50        | 9.20     | -    | -      |      |
|  |  | W  | 70×2                       | 70×2         | 70×2                                | 1.960k         | 1.960k      | 1.960k   | -    | -      |      |
|  | Input power                              | TOTAL W  | -                          |              |                                     | 2.100k         | 2.100k      | 2.100k   | 480  | 2.900k |      |
|  |  | COP/COP CLASS                                  | TOTAL (W/W) *5 / ("A"-*G)  | -            | -                                   | -              | 3.81        | 3.81 / A | 3.81 | 4.17   | 3.10 |
|  | Erp *6                                   | Pdesign at -10°C                               | kW                         | -            | -                                   | -              | -           | 7.1      | -    | -      | -    |
|  |  | Tbivalent                                      | °C                         | -            | -                                   | -              | -           | -9       | -    | -      | -    |
|  |  | SCOP   | (W/W)                      | -            | -                                   | -              | -           | 4.0      | -    | -      | -    |
|  |  | Annual consumption                             | kWh                        | -            | -                                   | -              | -           | 2485     | -    | -      | -    |
|  | Class                                    |  | -                          | -            | -                                   | -              | A+          | -        | -    | -      |      |
|  | Power factor                             | %  | -                          | -            | -                                   | 96             | 96          | 95       | -    | -      |      |
|  | Noise indoor                             | dB-A (H/M/L)                                   | 33/29/25                   |              |                                     | -              | -           | -        | -    | -      |      |
|  |  | Power Level dB                                 | 55/51/47                   |              |                                     | -              | -           | -        | -    | -      |      |
| Noise outdoor  | dB-A (H/L)                               | -  |                            |              | -                                   | 50/-           | -           | -        | -    |        |      |
|  | Power Level dB                           | -  |                            |              | -                                   | 67/-           | -           | -        | -    |        |      |
| EXTRA LOW TEMP Total capacity(kW) / Input power(W) / COP |  | -  |                            |              |                                     |                |             |          |      |        |      |
| Max Current(A) / Max Input power(W)                      |  | 0.86×2/105×2                                   | 0.82×2/105×2               | 0.79×2/105×2 | 18.0/3.800k                         | 18.0/3.930k    | 18.0/4.060k | -        |      |        |      |
| Starting current(A) / Comp output(W)                     |  | -  | -                          | -            | 9.90/2.0k                           | 9.50/2.0k      | 9.20/2.0k   | -        |      |        |      |
| Network Impedance(ΩMAX.)                                 |  | -  |                            |              |                                     |                |             |          |      |        |      |
| Fan motor output (Indoor/Outdoor) W                      |  | 120  |                            |              | 90                                  |                |             | -        |      |        |      |
| Moisture removal volume                                  |  | L/h(Pt/h)                                      | 4.2                        | (2.1×2)      | (8.8)                               | -              |             |          | -    |        |      |
| External static pressure                                 |  | Pa   | 70 (MIN10 - MAX150)        |              |                                     | -              |             |          | -    |        |      |
| Indoor Air flow  | Cooling                                  | m³/min (ft³/min)                               | [14/13/10 (494/459/353)]×2 |              |                                     | -              |             |          | -    |        |      |
|  | Heating                                  | m³/min (ft³/min)                               | [14/13/10 (494/459/353)]×2 |              |                                     | -              |             |          | -    |        |      |
| Outdoor Air flow   | Cooling                                  | m³/min (ft³/min)                               | -                          |              |                                     | 60             | (2119)      | -        |      |        |      |
|  | Heating                                  | m³/min (ft³/min)                               | -                          |              |                                     | 60             | (2119)      | -        |      |        |      |
| Refrigerant type / amount g(oz)                          |  | -  |                            |              | R410A                               | 2.35k          | (82.9)      | -        |      |        |      |
| Product dimension  | Height                                   | mm(inch)                                       | 290 (11-13/32)             |              |                                     | 996 (39-7/32)  |             |          | -    |        |      |
|  | Width                                    | mm(inch)                                       | 800 (31-1/2)               |              |                                     | 940 (37-1/32)  |             |          | -    |        |      |
|  | Depth                                    | mm(inch)                                       | 700 (27-9/16)              |              |                                     | 340 (13-13/32) |             |          | -    |        |      |
| Packing dimension  | Height                                   | mm(inch)                                       | 355                        |              |                                     | 1136           |             |          | -    |        |      |
|  | Width                                    | mm(inch)                                       | 1014                       |              |                                     | 1055           |             |          | -    |        |      |
|  | Depth                                    | mm(inch)                                       | 850                        |              |                                     | 485            |             |          | -    |        |      |
| Weight   | (NET)                                    | kg(lb)   | 28 (62)                    |              |                                     | 69 (152)       |             |          | -    |        |      |
|  | (GROSS)                                  | kg(lb)   | 35 (78)                    |              |                                     | 77 (170)       |             |          | -    |        |      |
| Layers limit (actually)                                  |  | 9 (10)   |                            |              | 2 (3)                               |                |             | -        |      |        |      |
| Operation condition                                      | Cool (DBT)                               | 18°C ~ 32°C                                    |                            |              | -15°C ~ 46°C                        |                |             | -        |      |        |      |
|  | Heat (DBT)                               | 16°C ~ 30°C                                    |                            |              | -20°C ~ 24°C                        |                |             | -        |      |        |      |
| P<br>I<br>P<br>I<br>N<br>G                               | Pipe diameter mm (inch)                  | (Liquid)∅6.35(1/4) (Gas)∅12.7(1/2)             |                            |              | (Liquid)∅9.52(3/8) (Gas)∅15.88(5/8) |                |             | -        |      |        |      |
|  | Connecting method, Standard length m(ft) | flared type, 5.0(16.4)                         |                            |              | flared type, 5.0(16.4)              |                |             | -        |      |        |      |
| Pipe length range m (ft)                                 |  | 5 ~ 50 (16.4 ~ 164.0)                          |                            |              | -                                   |                |             | -        |      |        |      |
| Indoor unit & Outdoor unit height difference m (ft)      |  | 15 (OD located lower) / 30 (OD located higher) |                            |              | (49.2/98.4)                         |                |             | -        |      |        |      |
| Add gas amount g/m (oz/ft)                               |  | 50   |                            |              | (0.538)                             |                |             | -        |      |        |      |
| Pipe length for additional gas m (ft)                    |  | 30   |                            |              | (98.4)                              |                |             | -        |      |        |      |

\*1: In case it is necessary to indicate the air flow volume in (l/s), the value in (m³/min.) shall be multiplied by 16.7 and rounded down the decimal point.

\*2: If the EUROVENT Certified models can be operated under the "extra-low" temperature condition, -7°C dry bulb and -8°C wet-bulb temperatures with rated voltage 230 V shall be used.

\*3: Network Impedance shall be applicable for EUROPE and CHINA models.

\*4: The annual consumption is calculated by multiplying the input power at 230 V (400 V) by an average of 500 hours per year in cooling mode.

\*5: EER and COP classification is at 230 V (400 V) only in accordance with EU directive 2002/31/EC.

\*6: SEER and SCOP classification is at 230V(400V) only in accordance with EN-14825. For heating, SCOP indicates the value of only Average heating season, Other fiche data indicates in an attached sheet.

# Simultaneous (Triple) -Type

## 1-1. Unit Specifications

PE1

### 4. Low Silhouette Ducted Type S-36PF1E5A×3 / U-100PE1E5A

| INDOOR   |  | MODEL  | S-36PF1E5A×3               |              |                                     | -              |             |          | -     |        |      |
|--|--|--|----------------------------|--------------|-------------------------------------|----------------|-------------|----------|-------|--------|------|
| OUTDOOR  |  | MODEL  | -                          |              |                                     | U-100PE1E5A    |             |          | -     |        |      |
| Branch pipe  |  | MODEL  | CZ-P3HPC2                  |              |                                     |                |             |          |       |        |      |
| Performance test condition                               |  | ISO13253 / EN14511 / EN14825 / EN12102         |                            |              |                                     |                |             |          |       |        |      |
| Power supply   |  | ∅, Hz  | 1∅ 50Hz                    |              |                                     | 1∅ 50Hz        |             |          |       |        |      |
|  |  | V  | 220                        | 230          | 240                                 | 220            | 230         | 240      | Min   | Max    |      |
| C<br>O<br>O<br>L<br>I<br>N<br>G                          | Capacity                                 | kW   | 10.0                       | 10.0         | 10.0                                | -              | -           | -        | 3.3   | 12.5   |      |
|  |  | BTU/h  | 34100                      | 34100        | 34100                               | -              | -           | -        | 11300 | 42700  |      |
|  | Current                                  | A  | 0.6×3                      | 0.57×3       | 0.56×3                              | 11.0           | 10.6        | 10.3     | -     | -      |      |
|  |  | W  | 70×3                       | 70×3         | 70×3                                | 2.245k         | 2.245k      | 2.245k   | -     | -      |      |
|  | Input power                              | TOTAL W  | -                          |              |                                     | 2.455k         | 2.455k      | 2.455k   | 840   | 3.700k |      |
|  |  | Annual consumption                             | TOTAL kWh *4               | -            |                                     |                | -           | 1227.5   | -     | -      | -    |
|  | EER/EER CLASS                            | TOTAL (W/W) *5 / ("A"-*G)                      | -                          | -            | -                                   | 4.07           | 4.07 / A    | 4.07     | 3.93  | 3.38   |      |
|  | Erp *6                                   | Pdesign  | kW                         | -            | -                                   | -              | -           | 10.0     | -     | -      | -    |
|  |  | SEER   | (W/W)                      | -            | -                                   | -              | -           | 5.8      | -     | -      | -    |
|  |  | Annual consumption                             | kWh                        | -            | -                                   | -              | -           | 603      | -     | -      | -    |
| Class  |  |  | -                          | -            | -                                   | -              | A+          | -        | -     | -      |      |
| Power factor   | %  | -  | -                          | -            | 93                                  | 92             | 91          | -        | -     |        |      |
| Noise indoor   | dB-A (H/M/L)                             | 33/29/25                                       |                            |              | -                                   | -              | -           | -        | -     |        |      |
|  | Power Level dB                           | 55/51/47                                       |                            |              | -                                   | -              | -           | -        | -     |        |      |
| Noise outdoor  | dB-A (H/L)                               | -  |                            |              | -                                   | 52/-           |             | -        | -     |        |      |
|  | Power Level dB                           | -  |                            |              | -                                   | 69/-           |             | -        | -     |        |      |
| H<br>E<br>A<br>T<br>I<br>N<br>G                          | Capacity                                 | kW   | 11.2                       | 11.2         | 11.2                                | -              | -           | -        | 4.1   | 14.0   |      |
|  |  | BTU/h  | 38200                      | 38200        | 38200                               | -              | -           | -        | 14000 | 47800  |      |
|  | Current                                  | A  | 0.6×3                      | 0.57×3       | 0.56×3                              | 11.6           | 11.2        | 10.7     | -     | -      |      |
|  |  | W  | 70×3                       | 70×3         | 70×3                                | 2.400k         | 2.400k      | 2.400k   | -     | -      |      |
|  | Input power                              | TOTAL W  | -                          |              |                                     | 2.610k         | 2.610k      | 2.610k   | 900   | 4.400k |      |
|  |  | COP/COP CLASS                                  | TOTAL (W/W) *5 / ("A"-*G)  | -            | -                                   | -              | 4.29        | 4.29 / A | 4.29  | 4.56   | 3.18 |
|  | Erp *6                                   | Pdesign at -10°C                               | kW                         | -            | -                                   | -              | -           | 10.0     | -     | -      | -    |
|  |  | Tbivalent                                      | °C                         | -            | -                                   | -              | -           | -10      | -     | -      | -    |
|  |  | SCOP   | (W/W)                      | -            | -                                   | -              | -           | 3.8      | -     | -      | -    |
|  |  | Annual consumption                             | kWh                        | -            | -                                   | -              | -           | 3684     | -     | -      | -    |
| Class  |  | -  | -                          | -            | -                                   | A              | -           | -        | -     |        |      |
| Power factor   | %  | -  | -                          | -            | 94                                  | 94             | 93          | -        | -     |        |      |
| Noise indoor   | dB-A (H/M/L)                             | 33/29/25                                       |                            |              | -                                   | -              | -           | -        | -     |        |      |
|  | Power Level dB                           | 55/51/47                                       |                            |              | -                                   | -              | -           | -        | -     |        |      |
| Noise outdoor  | dB-A (H/L)                               | -  |                            |              | -                                   | 52/-           |             | -        | -     |        |      |
|  | Power Level dB                           | -  |                            |              | -                                   | 69/-           |             | -        | -     |        |      |
| EXTRA LOW TEMP Total capacity(kW) / Input power(W) / COP |  | -  |                            |              |                                     |                |             |          |       |        |      |
| Max Current(A) / Max Input power(W)                      |  | 0.86×3/105×3                                   | 0.82×3/105×3               | 0.79×3/105×3 | 25.0/5.350k                         | 25.0/5.550k    | 25.0/5.750k | -        |       |        |      |
| Starting current(A) / Comp output(W)                     |  | -  | -                          | -            | 11.6/3.0k                           | 11.2/3.0k      | 10.7/3.0k   | -        |       |        |      |
| Network Impedance(ΩMAX.)                                 |  | -  |                            |              |                                     |                |             |          |       |        |      |
| Fan motor output (Indoor/Outdoor) W                      |  | 120  |                            |              | 90x2                                |                |             | -        |       |        |      |
| Moisture removal volume                                  |  | L/h(Pt/h)                                      | 6.0                        | (2.0×3)      | (12.6)                              | -              |             |          | -     |        |      |
| External static pressure                                 |  | Pa   | 70 (MIN10 - MAX150)        |              |                                     | -              |             |          | -     |        |      |
| Indoor Air flow  | Cooling                                  | m³/min (ft³/min)                               | [14/13/10 (494/459/353)]×3 |              |                                     | -              |             |          | -     |        |      |
|  | Heating                                  | m³/min (ft³/min)                               | [14/13/10 (494/459/353)]×3 |              |                                     | -              |             |          | -     |        |      |
| Outdoor Air flow   | Cooling                                  | m³/min (ft³/min)                               | -                          |              |                                     | 110            | (3885)      | -        |       |        |      |
|  | Heating                                  | m³/min (ft³/min)                               | -                          |              |                                     | 95             | (3355)      | -        |       |        |      |
| Refrigerant type / amount g(oz)                          |  | -  |                            |              | R410A                               | 3.40k          | (119.9)     | -        |       |        |      |
| Product dimension  | Height                                   | mm(inch)                                       | 290 (11-13/32)             |              |                                     | 1416 (55-3/4)  |             |          | -     |        |      |
|  | Width                                    | mm(inch)                                       | 800 (31-1/2)               |              |                                     | 940 (37-1/32)  |             |          | -     |        |      |
|  | Depth                                    | mm(inch)                                       | 700 (27-9/16)              |              |                                     | 340 (13-13/32) |             |          | -     |        |      |
| Packing dimension  | Height                                   | mm(inch)                                       | 355                        |              |                                     | 1556           |             |          | -     |        |      |
|  | Width                                    | mm(inch)                                       | 1014                       |              |                                     | 1055           |             |          | -     |        |      |
|  | Depth                                    | mm(inch)                                       | 850                        |              |                                     | 485            |             |          | -     |        |      |
| Weight   | (NET)                                    | kg(lb)   | 28 (62)                    |              |                                     | 98 (216)       |             |          | -     |        |      |
|  | (GROSS)                                  | kg(lb)   | 35 (78)                    |              |                                     | 108 (238)      |             |          | -     |        |      |
| Layers limit (actually)                                  |  | 9 (10)   |                            |              | 1 (2)                               |                |             | -        |       |        |      |
| Operation condition                                      | Cool (DBT)                               | 18°C ~ 32°C                                    |                            |              | -15°C ~ 46°C                        |                |             | -        |       |        |      |
|  | Heat (DBT)                               | 16°C ~ 30°C                                    |                            |              | -20°C ~ 24°C                        |                |             | -        |       |        |      |
| P I P I N G  | Pipe diameter mm (inch)                  | (Liquid)∅6.35(1/4) (Gas)∅12.7(1/2)             |                            |              | (Liquid)∅9.52(3/8) (Gas)∅15.88(5/8) |                |             | -        |       |        |      |
|  | Connecting method, Standard length m(ft) | flared type, 5.0(16.4)                         |                            |              | flared type, 5.0(16.4)              |                |             | -        |       |        |      |
| Pipe length range m (ft)                                 |  | 5 ~ 75 (16.4 ~ 246.1)                          |                            |              | -                                   |                |             | -        |       |        |      |
| Indoor unit & Outdoor unit height difference m (ft)      |  | 15 (OD located lower) / 30 (OD located higher) |                            |              | (49.2/98.4)                         |                |             | -        |       |        |      |
| Add gas amount g/m (oz/ft)                               |  | 50   |                            |              | (0.538)                             |                |             | -        |       |        |      |
| Pipe length for additional gas m (ft)                    |  | 20   |                            |              | (65.6)                              |                |             | -        |       |        |      |

\*1: In case it is necessary to indicate the air flow volume in (l/s), the value in (m³/min.) shall be multiplied by 16.7 and rounded down the decimal point.  
 \*2: If the EUROVENT Certified models can be operated under the "extra-low" temperature condition, -7°C dry bulb and -8°C wet-bulb temperatures with rated voltage 230 V shall be used.  
 \*3: Network Impedance shall be applicable for EUROPE and CHINA models.  
 \*4: The annual consumption is calculated by multiplying the input power at 230 V (400 V) by an average of 500 hours per year in cooling mode.  
 \*5: EER and COP classification is at 230 V (400 V) only in accordance with EU directive 2002/31/EC.  
 \*6: SEER and SCOP classification is at 230V(400V) only in accordance with EN-14825. For heating, SCOP indicates the value of only Average heating season, Other fiche data indicates in an attached sheet.

# Simultaneous (Double-Twin) -Type

## 1-1. Unit Specifications

**PE1**

### 4. Low Silhouette Ducted Type S-36PF1E5A×4 / U-125PE1E5A

| INDOOR   |  | MODEL  | S-36PF1E5A×4               |              |                                     | -              |             |          | -     |        |      |
|--|--|--|----------------------------|--------------|-------------------------------------|----------------|-------------|----------|-------|--------|------|
| OUTDOOR  |  | MODEL  | -                          |              |                                     | U-125PE1E5A    |             |          | -     |        |      |
| Branch pipe  |  | MODEL  | CZ-P155BK1×3               |              |                                     |                |             |          |       | -      |      |
| Performance test condition                               |  | ISO13253 / EN14511 / EN12102 / EN14825         |                            |              |                                     |                |             |          |       |        |      |
| Power supply   |  | Ø, Hz  | 1ø 50Hz                    |              |                                     | 1ø 50Hz        |             |          |       |        |      |
|  |  | V  | 220                        | 230          | 240                                 | 220            | 230         | 240      | Min   | Max    |      |
| C<br>O<br>O<br>L<br>I<br>N<br>G                          | Capacity                                 | kW   | 12.5                       | 12.5         | 12.5                                | -              | -           | -        | 3.3   | 14.0   |      |
|  |  | BTU/h  | 42700                      | 42700        | 42700                               | -              | -           | -        | 11300 | 47800  |      |
|  | Current                                  | A  | 0.6×4                      | 0.57×4       | 0.56×4                              | 16.6           | 15.9        | 15.3     | -     | -      |      |
|  |  | W  | 70×4                       | 70×4         | 70×4                                | 3.355k         | 3.355k      | 3.355k   | -     | -      |      |
|  | Input power                              | TOTAL W  | -                          |              |                                     | 3.635k         | 3.635k      | 3.635k   | 840   | 4.600k |      |
|  |  | Annual consumption                             | TOTAL kWh *4               | -            |                                     |                | -           | 1817.5   | -     | -      | -    |
|  | EER/EER CLASS                            | TOTAL (W/W) *5 / ("A"-*G)                      | -                          | -            | -                                   | 3.44           | 3.44 / A    | 3.44     | 3.93  | 3.04   |      |
|  | Erp *6                                   | Pdesign  | kW                         | -            | -                                   | -              | -           | 12.5     | -     | -      | -    |
|  |  | η <sub>s.c</sub>                               | %                          | -            | -                                   | -              | -           | 234.1    | -     | -      | -    |
|  |  | Annual consumption                             | kWh                        | -            | -                                   | -              | -           | -        | -     | -      | -    |
|  |  | Class  |                            | -            | -                                   | -              | -           | -        | -     | -      | -    |
|  | Power factor                             | %  | -                          | -            | -                                   | 92             | 92          | 91       | -     | -      |      |
|  | Noise indoor                             | dB-A (H/M/L)                                   | 33/29/25                   |              |                                     | -              | -           | -        | -     | -      |      |
|  |  | Power Level dB                                 | 55/51/47                   |              |                                     | -              | -           | -        | -     | -      |      |
| Noise outdoor  | dB-A (H/L)                               | -  |                            |              | 53/-                                |                |             | -        | -     |        |      |
|  | Power Level dB                           | -  |                            |              | 70/-                                |                |             | -        | -     |        |      |
| H<br>E<br>A<br>T<br>I<br>N<br>G                          | Capacity                                 | kW   | 14.0                       | 14.0         | 14.0                                | -              | -           | -        | 4.1   | 16.0   |      |
|  |  | BTU/h  | 47800                      | 47800        | 47800                               | -              | -           | -        | 14000 | 54600  |      |
|  | Current                                  | A  | 0.6×4                      | 0.57×4       | 0.56×4                              | 16.3           | 15.8        | 15.1     | -     | -      |      |
|  |  | W  | 70×4                       | 70×4         | 70×4                                | 3.270k         | 3.270k      | 3.270k   | -     | -      |      |
|  | Input power                              | TOTAL W  | -                          |              |                                     | 3.550k         | 3.550k      | 3.550k   | 900   | 5.200k |      |
|  |  | COP/COP CLASS                                  | TOTAL (W/W) *5 / ("A"-*G)  | -            | -                                   | -              | 3.94        | 3.94 / A | 3.94  | 4.56   | 3.08 |
|  | Erp *6                                   | Pdesign at -10°C                               | kW                         | -            | -                                   | -              | -           | 12.5     | -     | -      | -    |
|  |  | Tbivalent                                      | °C                         | -            | -                                   | -              | -           | -9       | -     | -      | -    |
|  |  | η <sub>s.h</sub>                               | %                          | -            | -                                   | -              | -           | 146.6    | -     | -      | -    |
|  |  | Annual consumption                             | kWh                        | -            | -                                   | -              | -           | -        | -     | -      | -    |
|  | Class                                    |  | -                          | -            | -                                   | -              | -           | -        | -     | -      |      |
|  | Power factor                             | %  | -                          | -            | -                                   | 91             | 90          | 90       | -     | -      |      |
|  | Noise indoor                             | dB-A (H/M/L)                                   | 33/29/25                   |              |                                     | -              | -           | -        | -     | -      |      |
|  |  | Power Level dB                                 | 55/51/47                   |              |                                     | -              | -           | -        | -     | -      |      |
| Noise outdoor  | dB-A (H/L)                               | -  |                            |              | 53/-                                |                |             | -        | -     |        |      |
|  | Power Level dB                           | -  |                            |              | 70/-                                |                |             | -        | -     |        |      |
| EXTRA LOW TEMP Total capacity(kW) / Input power(W) / COP |  | -  |                            |              |                                     |                |             |          |       |        |      |
| Max Current(A) / Max Input power(W)                      |  | 0.86×4/105×4                                   | 0.82×4/105×4               | 0.79×4/105×4 | 28.0/6.000k                         | 28.0/6.200k    | 28.0/6.400k | -        |       |        |      |
| Starting current(A) / Comp output(W)                     |  | -  | -                          | -            | 16.6/3.0k                           | 15.9/3.0k      | 15.3/3.0k   | -        |       |        |      |
| Network Impedance(ΩMAX.)                                 |  | -  |                            |              |                                     |                |             |          |       |        |      |
| Fan motor output (Indoor/Outdoor) W                      |  | 120  |                            |              | 90x2                                |                |             | -        |       |        |      |
| Moisture removal volume                                  |  | L/h(Pt/h)                                      | 7.9                        | (1.98×4)     | (16.6)                              | -              |             |          | -     |        |      |
| External static pressure                                 |  | Pa   | 70 (MIN10 - MAX150)        |              |                                     | -              |             |          | -     |        |      |
| Indoor Air flow  | Cooling                                  | m³/min (ft³/min)                               | [14/13/10 (494/459/353)]×4 |              |                                     | -              |             |          | -     |        |      |
|  | Heating                                  | m³/min (ft³/min)                               | [14/13/10 (494/459/353)]×4 |              |                                     | -              |             |          | -     |        |      |
| Outdoor Air flow   | Cooling                                  | m³/min (ft³/min)                               | -                          |              |                                     | 130            | (4591)      | -        |       |        |      |
|  | Heating                                  | m³/min (ft³/min)                               | -                          |              |                                     | 110            | (3885)      | -        |       |        |      |
| Refrigerant type / amount g(oz)                          |  | -  |                            |              | R410A                               | 3.40k          | (119.9)     | -        |       |        |      |
| Product dimension  | Height                                   | mm(inch)                                       | 290 (11-13/32)             |              |                                     | 1416 (55-3/4)  |             |          | -     |        |      |
|  | Width                                    | mm(inch)                                       | 800 (31-1/2)               |              |                                     | 940 (37-1/32)  |             |          | -     |        |      |
|  | Depth                                    | mm(inch)                                       | 700 (27-9/16)              |              |                                     | 340 (13-13/32) |             |          | -     |        |      |
| Packing dimension  | Height                                   | mm(inch)                                       | 355                        |              |                                     | 1556           |             |          | -     |        |      |
|  | Width                                    | mm(inch)                                       | 1014                       |              |                                     | 1055           |             |          | -     |        |      |
|  | Depth                                    | mm(inch)                                       | 850                        |              |                                     | 485            |             |          | -     |        |      |
| Weight   | (NET)                                    | kg(lb)   | 28 (62)                    |              |                                     | 98 (216)       |             |          | -     |        |      |
|  | (GROSS)                                  | kg(lb)   | 35 (78)                    |              |                                     | 108 (238)      |             |          | -     |        |      |
| Layers limit (actually)                                  |  | 9 (10)   |                            |              | 1 (2)                               |                |             | -        |       |        |      |
| Operation condition                                      | Cool (DBT)                               | 18°C ~ 32°C                                    |                            |              | -15°C ~ 46°C                        |                |             | -        |       |        |      |
|  | Heat (DBT)                               | 16°C ~ 30°C                                    |                            |              | -20°C ~ 24°C                        |                |             | -        |       |        |      |
| P I P I N G  | Pipe diameter mm (inch)                  | (Liquid)ø6.35(1/4) (Gas)ø12.7(1/2)             |                            |              | (Liquid)ø9.52(3/8) (Gas)ø15.88(5/8) |                |             | -        |       |        |      |
|  | Connecting method, Standard length m(ft) | flared type, 5.0(16.4)                         |                            |              | flared type, 5.0(16.4)              |                |             | -        |       |        |      |
| Pipe length range  | m (ft)                                   | 5 ~ 75 (16.4 ~ 246.1)                          |                            |              | -                                   |                |             | -        |       |        |      |
| Indoor unit & Outdoor unit height difference             | m (ft)                                   | 15 (OD located lower) / 30 (OD located higher) |                            |              | (49.2/98.4)                         |                |             | -        |       |        |      |
| Add gas amount   | g/m (oz/ft)                              | 50   |                            |              | (0.538)                             |                |             | -        |       |        |      |
| Pipe length for additional gas                           | m (ft)                                   | 20   |                            |              | (65.6)                              |                |             | -        |       |        |      |

\*1: In case it is necessary to indicate the air flow volume in (l/s), the value in (m³/min.) shall be multiplied by 16.7 and rounded down the decimal point.

\*2: If the EUROVENT Certified models can be operated under the "extra-low" temperature condition, -7°C dry bulb and -8°C wet-bulb temperatures with rated voltage 230 V shall be used.

\*3: Network Impedance shall be applicable for EUROPE and CHINA models.

\*4: The annual consumption is calculated by multiplying the input power at 230 V (400 V) by an average of 500 hours per year in cooling mode.

\*5: EER and COP classification is at 230 V (400 V) only in accordance with EU directive 2002/31/EC.

\*6: SEER and SCOP classification is at 230V(400V) only in accordance with EN-14825. For heating, SCOP indicates the value of only Average heating season.

# Simultaneous (Triple) -Type

## 1-1. Unit Specifications

**PE1**

### 4. Low Silhouette Ducted Type S-45PF1E5A×3 / U-125PE1E5A

| INDOOR   |  | MODEL                                  | S-45PF1E5A×3                       |  |              | -                                   |             |          | -     |        |      |
|--|--|--|------------------------------------|--|--------------|-------------------------------------|-------------|----------|-------|--------|------|
| OUTDOOR  |  | MODEL                                  | -                                  |  |              | U-125PE1E5A                         |             |          | -     |        |      |
| Branch pipe  |  | MODEL                                  | CZ-P3HPC2                          |  |              |                                     |             |          |       |        |      |
| Performance test condition                               |  | ISO13253 / EN14511 / EN12102 / EN14825 |                                    |  |              |                                     |             |          |       |        |      |
| Power supply   |  | Ø, Hz                                  | 1ø 50Hz                            |  |              | 1ø 50Hz                             |             |          |       |        |      |
|  |  | V                                      | 220                                | 230  | 240          | 220                                 | 230         | 240      | Min   | Max    |      |
| C<br>O<br>O<br>L<br>I<br>N<br>G                          | Capacity                                 | kW                                     | 12.5                               | 12.5   | 12.5         | -                                   | -           | -        | 3.3   | 14.0   |      |
|  |  | BTU/h                                  | 42700                              | 42700  | 42700        | -                                   | -           | -        | 11300 | 47800  |      |
|  | Current                                  | A                                      | 0.60×3                             | 0.57×3   | 0.56×3       | 16.6                                | 15.9        | 15.4     | -     | -      |      |
|  |  | W                                      | 70×3                               | 70×3   | 70×3         | 3.360k                              | 3.360k      | 3.360k   | -     | -      |      |
|  | Input power                              | TOTAL W                                | -                                  |  |              | 3.570k                              | 3.570k      | 3.570k   | 840   | 4.600k |      |
|  |  | Annual consumption                     | TOTAL kWh *4                       | -  |              |                                     | -           | 1785     | -     | -      | -    |
|  | EER/EER CLASS                            |  | TOTAL (W/W) *5 / ("A"-*G)          | -  | -            | -                                   | 3.50        | 3.50 / A | 3.50  | 3.93   | 3.04 |
|  | Erp *6                                   | Pdesign                                | kW                                 | -  | -            | -                                   | -           | 12.5     | -     | -      | -    |
|  |  | η <sub>s.c</sub>                       | %                                  | -  | -            | -                                   | -           | 234.1    | -     | -      | -    |
|  |  | Annual consumption                     | kWh                                | -  | -            | -                                   | -           | -        | -     | -      | -    |
|  |  | Class                                  |                                    | -  | -            | -                                   | -           | -        | -     | -      | -    |
|  | Power factor                             |  | %                                  | -  | -            | -                                   | 92          | 92       | 91    | -      | -    |
| Noise indoor   | dB-A (H/M/L)                             | 34/30/26                               |                                    |  | -            | -                                   | -           | -        | -     |        |      |
|  | Power Level dB                           | 56/52/48                               |                                    |  | -            | -                                   | -           | -        | -     |        |      |
| Noise outdoor  | dB-A (H/L)                               | -                                      |                                    |  | -            | 53/-                                |             | -        | -     |        |      |
|  | Power Level dB                           | -                                      |                                    |  | -            | 70/-                                |             | -        | -     |        |      |
| H<br>E<br>A<br>T<br>I<br>N<br>G                          | Capacity                                 | kW                                     | 14.0                               | 14.0   | 14.0         | -                                   | -           | -        | 4.1   | 16.0   |      |
|  |  | BTU/h                                  | 47800                              | 47800  | 47800        | -                                   | -           | -        | 14000 | 54600  |      |
|  | Current                                  | A                                      | 0.60×3                             | 0.57×3   | 0.56×3       | 16.3                                | 15.8        | 15.1     | -     | -      |      |
|  |  | W                                      | 70×3                               | 70×3   | 70×3         | 3.270k                              | 3.270k      | 3.270k   | -     | -      |      |
|  | Input power                              | TOTAL W                                | -                                  |  |              | 3.480k                              | 3.480k      | 3.480k   | 900   | 5.200k |      |
|  |  | COP/COP CLASS                          | TOTAL (W/W) *5 / ("A"-*G)          | -  | -            | -                                   | 4.02        | 4.02 / A | 4.02  | 4.56   | 3.08 |
|  | Erp *6                                   | Pdesign at -10°C                       | kW                                 | -  | -            | -                                   | -           | 12.5     | -     | -      | -    |
|  |  | Tbivalent                              | °C                                 | -  | -            | -                                   | -           | -9       | -     | -      | -    |
|  |  | η <sub>s.h</sub>                       | %                                  | -  | -            | -                                   | -           | 146.6    | -     | -      | -    |
|  |  | Annual consumption                     | kWh                                | -  | -            | -                                   | -           | -        | -     | -      | -    |
|  | Power factor                             |  | %                                  | -  | -            | -                                   | 91          | 90       | 90    | -      | -    |
|  | Noise indoor                             | dB-A (H/M/L)                           | 34/30/26                           |  |              | -                                   | -           | -        | -     | -      |      |
| Power Level dB   |  | 56/52/48                               |                                    |  | -            | -                                   | -           | -        | -     |        |      |
| Noise outdoor  | dB-A (H/L)                               | -                                      |                                    |  | -            | 53/-                                |             | -        | -     |        |      |
|  | Power Level dB                           | -                                      |                                    |  | -            | 70/-                                |             | -        | -     |        |      |
| EXTRA LOW TEMP Total capacity(kW) / Input power(W) / COP |  | -                                      |                                    |  |              |                                     |             |          |       |        |      |
| Max Current(A) / Max Input power(W)                      |  | 0.86×3/105×3                           | 0.82×3/105×3                       | 0.79×3/105×3                                   | 28.0/6.000k  | 28.0/6.200k                         | 28.0/6.400k | -        |       |        |      |
| Starting current(A) / Comp output(W)                     |  | -                                      | -                                  | -  | 16.6/3.0k    | 15.9/3.0k                           | 15.3/3.0k   | -        |       |        |      |
| Network Impedance(ΩMAX.)                                 |  | -                                      |                                    |  |              |                                     |             |          |       |        |      |
| Fan motor output (Indoor/Outdoor) W                      |  | 120                                    |                                    |  | 90x2         |                                     |             | -        |       |        |      |
| Moisture removal volume                                  |  | L/h(Pt/h)                              | 7.9                                | (2.63×3)                                       | (16.6)       | -                                   |             |          | -     |        |      |
| External static pressure                                 |  | Pa                                     | 70 (MIN10 - MAX150)                |  |              | -                                   |             |          | -     |        |      |
| Indoor Air flow  | Cooling                                  | m³/min (ft³/min)                       | [14/13/10 (494/459/353)]×3         |  |              | -                                   |             |          | -     |        |      |
|  | Heating                                  | m³/min (ft³/min)                       | [14/13/10 (494/459/353)]×3         |  |              | -                                   |             |          | -     |        |      |
| Outdoor Air flow   | Cooling                                  | m³/min (ft³/min)                       | -                                  |  |              | 130                                 | (4591)      | -        |       |        |      |
|  | Heating                                  | m³/min (ft³/min)                       | -                                  |  |              | 110                                 | (3885)      | -        |       |        |      |
| Refrigerant type / amount g(oz)                          |  | -                                      |                                    |  | R410A        | 3.40k                               | (119.9)     | -        |       |        |      |
| Product dimension  | Height                                   | mm(inch)                               | 290 (11-13/32)                     |  |              | 1416 (55-3/4)                       |             |          | -     |        |      |
|  | Width                                    | mm(inch)                               | 800 (31-1/2)                       |  |              | 940 (37-1/32)                       |             |          | -     |        |      |
|  | Depth                                    | mm(inch)                               | 700 (27-9/16)                      |  |              | 340 (13-13/32)                      |             |          | -     |        |      |
| Packing dimension  | Height                                   | mm(inch)                               | 355                                |  |              | 1556                                |             |          | -     |        |      |
|  | Width                                    | mm(inch)                               | 1014                               |  |              | 1055                                |             |          | -     |        |      |
|  | Depth                                    | mm(inch)                               | 850                                |  |              | 485                                 |             |          | -     |        |      |
| Weight   | (NET)                                    | kg(lb)                                 | 28 (62)                            |  |              | 98 (216)                            |             |          | -     |        |      |
|  | (GROSS)                                  | kg(lb)                                 | 35 (78)                            |  |              | 108 (238)                           |             |          | -     |        |      |
| Layers limit (actually)                                  |  | 9 (10)                                 |                                    |  | 1 (2)        |                                     |             | -        |       |        |      |
| Operation condition                                      | Cool (DBT)                               | 18°C ~ 32°C                            |                                    |  | -15°C ~ 46°C |                                     |             | -        |       |        |      |
|  | Heat (DBT)                               | 16°C ~ 30°C                            |                                    |  | -20°C ~ 24°C |                                     |             | -        |       |        |      |
| P<br>I<br>P<br>I<br>N<br>G                               | Pipe diameter mm (inch)                  |  | (Liquid)ø6.35(1/4) (Gas)ø12.7(1/2) |  |              | (Liquid)ø9.52(3/8) (Gas)ø15.88(5/8) |             |          | -     |        |      |
|  | Connecting method, Standard length m(ft) |  | flared type, 5.0(16.4)             |  |              | flared type, 5.0(16.4)              |             |          | -     |        |      |
| Pipe length range  |  | m (ft)                                 |                                    | 5 ~ 75 (16.4 ~ 246.1)                          |              | -                                   |             |          |       |        |      |
| Indoor unit & Outdoor unit height difference             |  | m (ft)                                 |                                    | 15 (OD located lower) / 30 (OD located higher) |              | (49.2/98.4)                         |             | -        |       |        |      |
| Add gas amount   |  | g/m (oz/ft)                            |                                    | 50 (0.538)                                     |              | -                                   |             |          |       |        |      |
| Pipe length for additional gas                           |  | m (ft)                                 |                                    | 20 (65.6)                                      |              | -                                   |             |          |       |        |      |

\*1: In case it is necessary to indicate the air flow volume in (l/s), the value in (m³/min.) shall be multiplied by 16.7 and rounded down the decimal point.

\*2: If the EUROVENT Certified models can be operated under the "extra-low" temperature condition, -7°C dry bulb and -8°C wet-bulb temperatures with rated voltage 230 V shall be used.

\*3: Network Impedance shall be applicable for EUROPE and CHINA models.

\*4: The annual consumption is calculated by multiplying the input power at 230 V (400 V) by an average of 500 hours per year in cooling mode.

\*5: EER and COP classification is at 230 V (400 V) only in accordance with EU directive 2002/31/EC.

\*6: SEER and SCOP classification is at 230V(400V) only in accordance with EN-14825. For heating, SCOP indicates the value of only Average heating season.

# Single -Type

## 1-1. Unit Specifications

**PE2**

### 4. Low Silhouette Ducted Type S-50PF1E5A / U-50PE2E5A

| INDOOR   |   | MODEL                                  | S-50PF1E5A                                       |          |              | -                                  |            |        | -          |        |
|--|---|--|--|----------|--------------|------------------------------------|------------|--------|------------|--------|
| OUTDOOR  |   | MODEL                                  | -  |          |              | U-50PE2E5A                         |            |        | -          |        |
| Branch pipe  |   | MODEL                                  | -  |          |              | -                                  |            |        | -          |        |
| Performance test condition                               |   | ISO13253 / EN14511 / EN12102 / EN14825 |  |          |              |                                    |            |        |            |        |
| Power supply   |   | Ø, Hz                                  | 1ø 50Hz  |          |              | 1ø 50Hz                            |            |        | Min        | Max    |
|  |   | V                                      | 220V   | 230V     | 240V         | 220V                               | 230V       | 240V   |            |        |
| C<br>O<br>O<br>L<br>I<br>N<br>G                          | Capacity  | kW                                     | 5.0  | 5.0      | 5.0          | -                                  | -          | -      | 1.5        | 5.6    |
|  |   | BTU/h                                  | 17100  | 17100    | 17100        | -                                  | -          | -      | 5100       | 19100  |
|  | Current   | A                                      | 0.77   | 0.74     | 0.71         | 5.80                               | 5.60       | 5.30   | -          | -      |
|  |   | W                                      | 100  | 100      | 100          | 1.200k                             | 1.200k     | 1.200k | -          | -      |
|  | Input power   | TOTAL W                                | -  | -        | -            | 1.300k                             | 1.300k     | 1.300k | 290        | 1.600k |
|  |   | Annual consumption                     | TOTAL kWh *4                                     | -        | -            | -                                  | -          | 650    | -          | -      |
|  | EER/EER CLASS                                       | TOTAL (W/W) *5 / ("A"-*G)              | -  | -        | -            | 3.85                               | 3.85/A     | 3.85   | 5.17       | 3.50   |
|  | Erp *6  | Pdesign                                | kW   | -        | -            | -                                  | -          | 5.0    | -          | -      |
|  |   | SEER                                   | (W/W)  | -        | -            | -                                  | -          | 5.7    | -          | -      |
|  |   | Annual consumption                     | kWh  | -        | -            | -                                  | -          | 307    | -          | -      |
|  |   | Class                                  |  | -        | -            | -                                  | -          | A+     | -          | -      |
|  | Power factor  | %                                      | -  | -        | -            | 94                                 | 94         | 94     | -          | -      |
|  | Noise indoor  | dB-A (H/M/L)                           | 34/30/26   |          |              | -                                  | -          | -      | -          | -      |
|  |   | Power Level dB                         | 56/52/48   |          |              | -                                  | -          | -      | -          | -      |
| Noise outdoor  | dB-A (H/L)  | -                                      |  |          | -            | 46/-                               |            | -      | -          |        |
|  | Power Level dB                                      | -                                      |  |          | -            | 65/-                               |            | -      | -          |        |
| H<br>E<br>A<br>T<br>I<br>N<br>G                          | Capacity  | kW                                     | 5.6  | 5.6      | 5.6          | -                                  | -          | -      | 1.5        | 6.5    |
|  |   | BTU/h                                  | 19100  | 19100    | 19100        | -                                  | -          | -      | 5100       | 22200  |
|  | Current   | A                                      | 0.77   | 0.74     | 0.71         | 6.30                               | 6.05       | 5.80   | -          | -      |
|  |   | W                                      | 100  | 100      | 100          | 1.290k                             | 1.290k     | 1.290k | -          | -      |
|  | Input power   | TOTAL W                                | -  | -        | -            | 1.390k                             | 1.390k     | 1.390k | 240        | 1.750k |
|  |   | COP/COP CLASS                          | TOTAL (W/W) *5 / ("A"-*G)                        | -        | -            | -                                  | 4.03       | 4.03/A | 4.03       | 6.25   |
|  | Erp *6  | Pdesign at -10°C                       | kW   | -        | -            | -                                  | -          | 4.0    | -          | -      |
|  |   | Tbivalent                              | °C   | -        | -            | -                                  | -          | -10    | -          | -      |
|  |   | SCOP                                   | (W/W)  | -        | -            | -                                  | -          | 3.9    | -          | -      |
|  |   | Annual consumption                     | kWh  | -        | -            | -                                  | -          | 1436   | -          | -      |
|  | Class   |  | -  | -        | -            | -                                  | A          | -      | -          |        |
|  | Power factor  | %                                      | -  | -        | -            | 93                                 | 93         | 93     | -          | -      |
|  | Noise indoor  | dB-A (H/M/L)                           | 34/30/26   |          |              | -                                  | -          | -      | -          | -      |
|  |   | Power Level dB                         | 56/52/48   |          |              | -                                  | -          | -      | -          | -      |
| Noise outdoor  | dB-A (H/L)  | -                                      |  |          | -            | 48/-                               |            | -      | -          |        |
|  | Power Level dB                                      | -                                      |  |          | -            | 68/-                               |            | -      | -          |        |
| EXTRA LOW TEMP Total capacity(kW) / Input power(W) / COP |   | -                                      |  |          |              |                                    |            |        |            |        |
| Max Current(A) / Max Input power(W)                      |   | 1.00/125                               | 0.96/125   | 0.92/125 | 12.0/2.46k   | 12.0/2.57k                         | 12.0/2.68k | -      |            |        |
| Starting current(A) / Comp output(W)                     |   | -                                      | -  | -        | 6.30/1.5k    | 6.05/1.5k                          | 5.80/1.5k  | -      |            |        |
| Network Impedance(ΩMAX.)                                 |   | -                                      |  |          |              |                                    |            |        |            |        |
| Fan motor output (Indoor/Outdoor) W                      |   | 120                                    |  |          | 60           |                                    |            | -      |            |        |
| Moisture removal volume                                  |   | L/h(Pt/h)                              | 2.8  |          | (5.9)        |                                    | -          |        |            |        |
| External static pressure                                 |   | Pa                                     | 70 (MIN10 - MAX150)                              |          |              | -                                  |            |        |            |        |
| Indoor Air flow  | Cooling   | m³/min (ft³/min)                       | 16.0 / 15.0 / 12.0 (565) / (530) / (424)         |          |              | -                                  |            |        |            |        |
|  | Heating   | m³/min (ft³/min)                       | 16.0 / 15.0 / 12.0 (565) / (530) / (424)         |          |              | -                                  |            |        |            |        |
| Outdoor Air flow   | Cooling   | m³/min (ft³/min)                       | -  |          |              | 38                                 |            | (1342) |            | -      |
|  | Heating   | m³/min (ft³/min)                       | -  |          |              | 41                                 |            | (1448) |            | -      |
| Refrigerant type / amount g(oz)                          |   | -                                      |  |          | R410A        | 1.40k                              | (49.4)     |        | -          |        |
| Product dimension  | Height  | mm(inch)                               | 290  |          | (11-13/32)   |                                    | 619        |        | (24-3/8)   |        |
|  | Width   | mm(inch)                               | 800  |          | (31-1/2)     |                                    | 799        |        | (31-29/64) |        |
|  | Depth   | mm(inch)                               | 700  |          | (27-9/16)    |                                    | 299        |        | (11-49/64) |        |
| Product dimension (Panel)                                |   | H×W×D mm, inch                         | -  |          |              | -                                  |            |        |            |        |
| Packing dimension  | Height  | mm(inch)                               | 355  |          | (13-31/32)   |                                    | 688        |        |            |        |
|  | Width   | mm(inch)                               | 1014   |          | (39-15/16)   |                                    | 931        |        |            |        |
|  | Depth   | mm(inch)                               | 850  |          | (33-15/32)   |                                    | 422        |        |            |        |
| Weight   | (NET)   | kg(lb)                                 | 28   |          | (62)         |                                    | 39         |        | (86)       |        |
|  | (GROSS)   | kg(lb)                                 | 35   |          | (78)         |                                    | 44         |        | (97)       |        |
|  | Panel (NET)   | kg(lb)                                 | -  |          |              | -                                  |            |        |            |        |
| Layers limit (actually)                                  |   | 9 (10)                                 |  |          | 5 (6)        |                                    |            |        |            |        |
| Operation condition                                      | Cool (DBT)  | 18°C ~ 32°C                            |  |          | -15°C ~ 46°C |                                    |            |        |            |        |
|  | Heat (DBT)  | 16°C ~ 30°C                            |  |          | -20°C ~ 24°C |                                    |            |        |            |        |
| P<br>I<br>P<br>I<br>N<br>G                               | Pipe diameter mm (inch)                             |  | (Liquid)ø6.35(1/4) (Gas)ø12.7(1/2)               |          |              | (Liquid)ø6.35(1/4) (Gas)ø12.7(1/2) |            |        |            |        |
|  | Connecting method, Standard length m(ft)            |  | flared type, 5.0(16.4)                           |          |              | flared type, 5.0(16.4)             |            |        |            |        |
|  | Pipe length range m (ft)                            |  | 3 ~ 40m (9.8 ~ 131.2)                            |          |              | -                                  |            |        |            |        |
|  | Indoor unit & Outdoor unit height difference m (ft) |  | 15m (OD located lower) / 30m (OD located higher) |          |              | (49.2/98.4)                        |            |        |            |        |
|  | Add gas amount g/m (oz/ft)                          |  | 20g (0.715)                                      |          |              | -                                  |            |        |            |        |
| Pipe length for additional gas m (ft)                    |   | 30m (98.4)                             |  |          | -            |                                    |            |        |            |        |

\*1: In case it is necessary to indicate the air flow volume in (l/s), the value in (m³/min.) shall be multiplied by 16.7 and rounded down the decimal point.

\*2: If the EUROVENT Certified models can be operated under the "extra-low" temperature condition, -7°C dry bulb and -8°C wet-bulb temperatures with rated voltage 230 V shall be used.

\*3: Network Impedance shall be applicable for EUROPE and CHINA models.

\*4: The annual consumption is calculated by multiplying the input power at 230V (400V) by an average of 500 hours per year in cooling mode.

\*5: EER and COP classification is at 230V (400V) only in accordance with EU directive 2002/31/EC.

\*6: SEER and SCOP classification is at 230V (400V) only in accordance with EN-14825. For heating, SCOP indicates the value of only Average heating season, Other fiche data indicates in an attached sheet.



# Simultaneous (Twin) -Type

## 1-1. Unit Specifications

**PE1**

### 4. Low Silhouette Ducted Type S-50PF1E5A×2 / U-100PE1E5A

| INDOOR   |  | MODEL  | S-50PF1E5A×2               |              |                                     | -              |             |          | -     |        |      |
|--|--|--|----------------------------|--------------|-------------------------------------|----------------|-------------|----------|-------|--------|------|
| OUTDOOR  |  | MODEL  | -                          |              |                                     | U-100PE1E5A    |             |          | -     |        |      |
| Branch pipe  |  | MODEL  | CZ-P155BK1                 |              |                                     |                |             |          |       | -      |      |
| Performance test condition                               |  | ISO13253 / EN14511 / EN14825 / EN12102         |                            |              |                                     |                |             |          |       |        |      |
| Power supply   |  | ∅, Hz  | 1∅ 50Hz                    |              |                                     | 1∅ 50Hz        |             |          |       |        |      |
|  |  | V  | 220                        | 230          | 240                                 | 220            | 230         | 240      | Min   | Max    |      |
| C<br>O<br>O<br>L<br>I<br>N<br>G                          | Capacity                                 | kW   | 10.0                       | 10.0         | 10.0                                | -              | -           | -        | 3.3   | 12.5   |      |
|  |  | BTU/h  | 34100                      | 34100        | 34100                               | -              | -           | -        | 11300 | 42700  |      |
|  | Current                                  | A  | 0.77×2                     | 0.74×2       | 0.71×2                              | 11.0           | 10.6        | 10.3     | -     | -      |      |
|  |  | W  | 100×2                      | 100×2        | 100×2                               | 2.245k         | 2.245k      | 2.245k   | -     | -      |      |
|  | Input power                              | TOTAL W  | -                          |              |                                     | 2.445k         | 2.445k      | 2.445k   | 840   | 3.700k |      |
|  |  | Annual consumption                             | TOTAL kWh *4               | -            |                                     |                | -           | 1222.5   | -     | -      | -    |
|  | EER/EER CLASS                            | TOTAL (W/W) *5 / ("A"-*G)                      | -                          | -            | -                                   | 4.09           | 4.09 / A    | 4.09     | 3.93  | 3.38   |      |
|  | Erp *6                                   | Pdesign  | kW                         | -            | -                                   | -              | -           | 10.0     | -     | -      | -    |
|  |  | SEER   | (W/W)                      | -            | -                                   | -              | -           | 5.8      | -     | -      | -    |
|  |  | Annual consumption                             | kWh                        | -            | -                                   | -              | -           | 603      | -     | -      | -    |
|  |  | Class  |                            | -            | -                                   | -              | -           | A+       | -     | -      | -    |
|  | Power factor                             | %  | -                          | -            | -                                   | 93             | 92          | 91       | -     | -      |      |
|  | Noise indoor                             | dB-A (H/M/L)                                   | 34/30/26                   |              |                                     | -              | -           | -        | -     | -      |      |
|  |  | Power Level dB                                 | 56/52/48                   |              |                                     | -              | -           | -        | -     | -      |      |
| Noise outdoor  | dB-A (H/L)                               | -  |                            |              | -                                   | 52/-           | -           | -        | -     |        |      |
|  | Power Level dB                           | -  |                            |              | -                                   | 69/-           | -           | -        | -     |        |      |
| H<br>E<br>A<br>T<br>I<br>N<br>G                          | Capacity                                 | kW   | 11.2                       | 11.2         | 11.2                                | -              | -           | -        | 4.1   | 14.0   |      |
|  |  | BTU/h  | 38200                      | 38200        | 38200                               | -              | -           | -        | 14000 | 47800  |      |
|  | Current                                  | A  | 0.77×2                     | 0.74×2       | 0.71×2                              | 11.6           | 11.2        | 10.7     | -     | -      |      |
|  |  | W  | 100×2                      | 100×2        | 100×2                               | 2.400k         | 2.400k      | 2.400k   | -     | -      |      |
|  | Input power                              | TOTAL W  | -                          |              |                                     | 2.600k         | 2.600k      | 2.600k   | 900   | 4.400k |      |
|  |  | COP/COP CLASS                                  | TOTAL (W/W) *5 / ("A"-*G)  | -            | -                                   | -              | 4.31        | 4.31 / A | 4.31  | 4.56   | 3.18 |
|  | Erp *6                                   | Pdesign at -10°C                               | kW                         | -            | -                                   | -              | -           | 10.0     | -     | -      | -    |
|  |  | Tbivalent                                      | °C                         | -            | -                                   | -              | -           | -10      | -     | -      | -    |
|  |  | SCOP   | (W/W)                      | -            | -                                   | -              | -           | 3.8      | -     | -      | -    |
|  |  | Annual consumption                             | kWh                        | -            | -                                   | -              | -           | 3684     | -     | -      | -    |
|  | Class                                    |  | -                          | -            | -                                   | -              | A           | -        | -     | -      |      |
|  | Power factor                             | %  | -                          | -            | -                                   | 94             | 94          | 93       | -     | -      |      |
|  | Noise indoor                             | dB-A (H/M/L)                                   | 34/30/26                   |              |                                     | -              | -           | -        | -     | -      |      |
|  |  | Power Level dB                                 | 56/52/48                   |              |                                     | -              | -           | -        | -     | -      |      |
| Noise outdoor  | dB-A (H/L)                               | -  |                            |              | -                                   | 52/-           | -           | -        | -     |        |      |
|  | Power Level dB                           | -  |                            |              | -                                   | 69/-           | -           | -        | -     |        |      |
| EXTRA LOW TEMP Total capacity(kW) / Input power(W) / COP |  | -  |                            |              |                                     |                |             |          |       |        |      |
| Max Current(A) / Max Input power(W)                      |  | 1.00×2/125×2                                   | 0.96×2/125×2               | 0.92×2/125×2 | 25.0/5.350k                         | 25.0/5.550k    | 25.0/5.750k | -        |       |        |      |
| Starting current(A) / Comp output(W)                     |  | -  | -                          | -            | 11.6/3.0k                           | 11.2/3.0k      | 10.7/3.0k   | -        |       |        |      |
| Network Impedance(ΩMAX.)                                 |  | -  |                            |              |                                     |                |             |          |       |        |      |
| Fan motor output (Indoor/Outdoor) W                      |  | 120  |                            |              | 90×2                                |                |             | -        |       |        |      |
| Moisture removal volume                                  |  | L/h(Pt/h)                                      | 6.0                        | (3.0×2)      | (12.6)                              | -              |             |          | -     |        |      |
| External static pressure                                 |  | Pa   | 70 (MIN10 - MAX150)        |              |                                     | -              |             |          | -     |        |      |
| Indoor Air flow  | Cooling                                  | m³/min (ft³/min)                               | [16/15/12 (565/530/424)]×2 |              |                                     | -              |             |          | -     |        |      |
|  | Heating                                  | m³/min (ft³/min)                               | [16/15/12 (565/530/424)]×2 |              |                                     | -              |             |          | -     |        |      |
| Outdoor Air flow   | Cooling                                  | m³/min (ft³/min)                               | -                          |              |                                     | 110            | (3885)      | -        |       |        |      |
|  | Heating                                  | m³/min (ft³/min)                               | -                          |              |                                     | 95             | (3355)      | -        |       |        |      |
| Refrigerant type / amount g(oz)                          |  | -  |                            |              | R410A                               | 3.40k          | (119.9)     | -        |       |        |      |
| Product dimension  | Height                                   | mm(inch)                                       | 290 (11-13/32)             |              |                                     | 1416 (55-3/4)  |             |          | -     |        |      |
|  | Width                                    | mm(inch)                                       | 800 (31-1/2)               |              |                                     | 940 (37-1/32)  |             |          | -     |        |      |
|  | Depth                                    | mm(inch)                                       | 700 (27-9/16)              |              |                                     | 340 (13-13/32) |             |          | -     |        |      |
| Packing dimension  | Height                                   | mm(inch)                                       | 355                        |              |                                     | 1556           |             |          | -     |        |      |
|  | Width                                    | mm(inch)                                       | 1014                       |              |                                     | 1055           |             |          | -     |        |      |
|  | Depth                                    | mm(inch)                                       | 850                        |              |                                     | 485            |             |          | -     |        |      |
| Weight   | (NET)                                    | kg(lb)   | 28 (62)                    |              |                                     | 98 (216)       |             |          | -     |        |      |
|  | (GROSS)                                  | kg(lb)   | 35 (78)                    |              |                                     | 108 (238)      |             |          | -     |        |      |
| Layers limit (actually)                                  |  | 9 (10)   |                            |              | 1 (2)                               |                |             | -        |       |        |      |
| Operation condition                                      | Cool (DBT)                               | 18°C ~ 32°C                                    |                            |              | -15°C ~ 46°C                        |                |             | -        |       |        |      |
|  | Heat (DBT)                               | 16°C ~ 30°C                                    |                            |              | -20°C ~ 24°C                        |                |             | -        |       |        |      |
| P<br>I<br>P<br>I<br>N<br>G                               | Pipe diameter mm (inch)                  | (Liquid)∅6.35(1/4) (Gas)∅12.7(1/2)             |                            |              | (Liquid)∅9.52(3/8) (Gas)∅15.88(5/8) |                |             | -        |       |        |      |
|  | Connecting method, Standard length m(ft) | flared type, 5.0(16.4)                         |                            |              | flared type, 5.0(16.4)              |                |             | -        |       |        |      |
| Pipe length range m (ft)                                 |  | 5 ~ 75 (16.4 ~ 246.1)                          |                            |              | -                                   |                |             | -        |       |        |      |
| Indoor unit & Outdoor unit height difference m (ft)      |  | 15 (OD located lower) / 30 (OD located higher) |                            |              | (49.2/98.4)                         |                |             | -        |       |        |      |
| Add gas amount g/m (oz/ft)                               |  | 50   |                            |              | (0.538)                             |                |             | -        |       |        |      |
| Pipe length for additional gas m (ft)                    |  | 30   |                            |              | (98.4)                              |                |             | -        |       |        |      |

\*1: In case it is necessary to indicate the air flow volume in (l/s), the value in (m³/min.) shall be multiplied by 16.7 and rounded down the decimal point.

\*2: If the EUROVENT Certified models can be operated under the "extra-low" temperature condition, -7°C dry bulb and -8°C wet-bulb temperatures with rated voltage 230 V shall be used.

\*3: Network Impedance shall be applicable for EUROPE and CHINA models.

\*4: The annual consumption is calculated by multiplying the input power at 230 V (400 V) by an average of 500 hours per year in cooling mode.

\*5: EER and COP classification is at 230 V (400 V) only in accordance with EU directive 2002/31/EC.

\*6: SEER and SCOP classification is at 230V(400V) only in accordance with EN-14825. For heating, SCOP indicates the value of only Average heating season, Other fiche data indicates in an attached sheet.

# Simultaneous (Triple) -Type

## 1-1. Unit Specifications

**PE1**

### 4. Low Silhouette Ducted Type S-50PF1E5A×3 / U-140PE1E5A

| INDOOR   |  | MODEL                                  | S-50PF1E5A×3                       |  |              | -                                   |             |          | -     |        |      |
|--|--|--|------------------------------------|--|--------------|-------------------------------------|-------------|----------|-------|--------|------|
| OUTDOOR  |  | MODEL                                  | -                                  |  |              | U-140PE1E5A                         |             |          | -     |        |      |
| Branch pipe  |  | MODEL                                  | CZ-P3HPC2                          |  |              |                                     |             |          |       |        |      |
| Performance test condition                               |  | ISO13253 / EN14511 / EN12102 / EN14825 |                                    |  |              |                                     |             |          |       |        |      |
| Power supply   |  | Ø, Hz                                  | 1ø 50Hz                            |  |              | 1ø 50Hz                             |             |          |       |        |      |
|  |  | V                                      | 220                                | 230  | 240          | 220                                 | 230         | 240      | Min   | Max    |      |
| C<br>O<br>O<br>L<br>I<br>N<br>G                          | Capacity                                 | kW                                     | 14.0                               | 14.0   | 14.0         | -                                   | -           | -        | 3.3   | 15.5   |      |
|  |  | BTU/h                                  | 47800                              | 47800  | 47800        | -                                   | -           | -        | 11300 | 52900  |      |
|  | Current                                  | A                                      | 0.77×3                             | 0.74×3   | 0.71×3       | 20.1                                | 19.3        | 18.6     | -     | -      |      |
|  |  | W                                      | 100×3                              | 100×3  | 100×3        | 4.085k                              | 4.085k      | 4.085k   | -     | -      |      |
|  | Input power                              | TOTAL W                                | -                                  |  |              | 4.385k                              | 4.385k      | 4.385k   | 840   | 6.000k |      |
|  |  | Annual consumption                     | TOTAL kWh **4                      | -  |              |                                     | -           | 2192.5   | -     | -      | -    |
|  | EER/EER CLASS                            |  | TOTAL (W/W) **5 / ("A"-*G)         | -  | -            | -                                   | 3.19        | 3.19 / A | 3.19  | 3.93   | 2.58 |
|  | Erp<br>*6                                | Pdesign                                | kW                                 | -  | -            | -                                   | -           | 14.0     | -     | -      | -    |
|  |  | η <sub>s.c</sub>                       | %                                  | -  | -            | -                                   | -           | 226.3    | -     | -      | -    |
|  |  | Annual consumption                     | kWh                                | -  | -            | -                                   | -           | -        | -     | -      | -    |
|  |  | Class                                  |                                    | -  | -            | -                                   | -           | -        | -     | -      | -    |
|  | Power factor                             |  | %                                  | -  | -            | -                                   | 93          | 92       | 92    | -      | -    |
| Noise indoor   | dB-A (H/M/L)                             | 34/30/26                               |                                    |  | -            | -                                   | -           | -        | -     |        |      |
|  | Power Level dB                           | 56/52/48                               |                                    |  | -            | -                                   | -           | -        | -     |        |      |
| Noise outdoor  | dB-A (H/L)                               | -                                      |                                    |  | -            | 54/-                                |             | -        | -     |        |      |
|  | Power Level dB                           | -                                      |                                    |  | -            | 71/-                                |             | -        | -     |        |      |
| H<br>E<br>A<br>T<br>I<br>N<br>G                          | Capacity                                 | kW                                     | 16.0                               | 16.0   | 16.0         | -                                   | -           | -        | 4.1   | 18.0   |      |
|  |  | BTU/h                                  | 54600                              | 54600  | 54600        | -                                   | -           | -        | 14000 | 61400  |      |
|  | Current                                  | A                                      | 0.77×3                             | 0.74×3   | 0.71×3       | 19.9                                | 19.1        | 18.4     | -     | -      |      |
|  |  | W                                      | 100×3                              | 100×3  | 100×3        | 4.215k                              | 4.215k      | 4.215k   | -     | -      |      |
|  | Input power                              | TOTAL W                                | -                                  |  |              | 4.515k                              | 4.515k      | 4.515k   | 900   | 5.900k |      |
|  |  | COP/COP CLASS                          | TOTAL (W/W) **5 / ("A"-*G)         | -  | -            | -                                   | 3.54        | 3.54 / A | 3.54  | 4.56   | 3.05 |
|  | Erp<br>*6                                | Pdesign at -10°C                       | kW                                 | -  | -            | -                                   | -           | 14.0     | -     | -      | -    |
|  |  | Tbivalent                              | °C                                 | -  | -            | -                                   | -           | -7       | -     | -      | -    |
|  |  | η <sub>s.h</sub>                       | %                                  | -  | -            | -                                   | -           | 143.0    | -     | -      | -    |
|  |  | Annual consumption                     | kWh                                | -  | -            | -                                   | -           | -        | -     | -      | -    |
|  | Power factor                             |  | %                                  | -  | -            | -                                   | 96          | 96       | 95    | -      | -    |
|  | Noise indoor                             | dB-A (H/M/L)                           | 34/30/26                           |  |              | -                                   | -           | -        | -     | -      |      |
| Power Level dB   |  | 56/52/48                               |                                    |  | -            | -                                   | -           | -        | -     |        |      |
| Noise outdoor  | dB-A (H/L)                               | -                                      |                                    |  | -            | 55/-                                |             | -        | -     |        |      |
|  | Power Level dB                           | -                                      |                                    |  | -            | 71/-                                |             | -        | -     |        |      |
| EXTRA LOW TEMP Total capacity(kW) / Input power(W) / COP |  | -                                      |                                    |  |              |                                     |             |          |       |        |      |
| Max Current(A) / Max Input power(W)                      |  | 1.00×3/125×3                           | 0.96×3/125×3                       | 0.92×3/125×3                                   | 30.0/6.450k  | 30.0/6.650k                         | 30.0/6.850k | -        |       |        |      |
| Starting current(A) / Comp output(W)                     |  | -                                      | -                                  | -  | 20.1/3.0k    | 19.3/3.0k                           | 18.6/3.0k   | -        |       |        |      |
| Network Impedance(ΩMAX.)                                 |  | -                                      |                                    |  |              |                                     |             |          |       |        |      |
| Fan motor output (Indoor/Outdoor) W                      |  | 120                                    |                                    |  | 90x2         |                                     |             | -        |       |        |      |
| Moisture removal volume                                  |  | L/h(Pt/h)                              | 9.0                                | (3.0×3)  | (18.9)       | -                                   |             |          | -     |        |      |
| External static pressure                                 |  | Pa                                     | 70 (MIN10 - MAX150)                |  |              | -                                   |             |          | -     |        |      |
| Indoor Air flow  | Cooling                                  | m³/min (ft³/min)                       | [16/15/12 (565/530/424)]×3         |  |              | -                                   |             |          | -     |        |      |
|  | Heating                                  | m³/min (ft³/min)                       | [16/15/12 (565/530/424)]×3         |  |              | -                                   |             |          | -     |        |      |
| Outdoor Air flow   | Cooling                                  | m³/min (ft³/min)                       | -                                  |  |              | 135                                 | (4767)      | -        |       |        |      |
|  | Heating                                  | m³/min (ft³/min)                       | -                                  |  |              | 120                                 | (4238)      | -        |       |        |      |
| Refrigerant type / amount g(oz)                          |  | -                                      |                                    |  | R410A        | 3.40k                               | (119.9)     | -        |       |        |      |
| Product dimension  | Height                                   | mm(inch)                               | 290 (11-13/32)                     |  |              | 1416 (55-3/4)                       |             |          | -     |        |      |
|  | Width                                    | mm(inch)                               | 800 (31-1/2)                       |  |              | 940 (37-1/32)                       |             |          | -     |        |      |
|  | Depth                                    | mm(inch)                               | 700 (27-9/16)                      |  |              | 340 (13-13/32)                      |             |          | -     |        |      |
| Packing dimension  | Height                                   | mm(inch)                               | 355                                |  |              | 1556                                |             |          | -     |        |      |
|  | Width                                    | mm(inch)                               | 1014                               |  |              | 1055                                |             |          | -     |        |      |
|  | Depth                                    | mm(inch)                               | 850                                |  |              | 485                                 |             |          | -     |        |      |
| Weight   | (NET)                                    | kg(lb)                                 | 28 (62)                            |  |              | 98 (216)                            |             |          | -     |        |      |
|  | (GROSS)                                  | kg(lb)                                 | 35 (78)                            |  |              | 108 (238)                           |             |          | -     |        |      |
| Layers limit (actually)                                  |  | 9 (10)                                 |                                    |  | 1 (2)        |                                     |             | -        |       |        |      |
| Operation condition                                      | Cool (DBT)                               | 18°C ~ 32°C                            |                                    |  | -15°C ~ 46°C |                                     |             | -        |       |        |      |
|  | Heat (DBT)                               | 16°C ~ 30°C                            |                                    |  | -20°C ~ 24°C |                                     |             | -        |       |        |      |
| P<br>I<br>P<br>I<br>N<br>G                               | Pipe diameter mm (inch)                  |  | (Liquid)ø6.35(1/4) (Gas)ø12.7(1/2) |  |              | (Liquid)ø9.52(3/8) (Gas)ø15.88(5/8) |             |          | -     |        |      |
|  | Connecting method, Standard length m(ft) |  | flared type, 5.0(16.4)             |  |              | flared type, 5.0(16.4)              |             |          | -     |        |      |
| Pipe length range  |  | m (ft)                                 |                                    | 5 ~ 75 (16.4 ~ 246.1)                          |              | -                                   |             |          |       |        |      |
| Indoor unit & Outdoor unit height difference             |  | m (ft)                                 |                                    | 15 (OD located lower) / 30 (OD located higher) |              | (49.2/98.4)                         |             | -        |       |        |      |
| Add gas amount   |  | g/m (oz/ft)                            |                                    | 50 (0.538)                                     |              | -                                   |             |          |       |        |      |
| Pipe length for additional gas                           |  | m (ft)                                 |                                    | 20 (65.6)                                      |              | -                                   |             |          |       |        |      |

\*1: In case it is necessary to indicate the air flow volume in (l/s), the value in (m³/min.) shall be multiplied by 16.7 and rounded down the decimal point.

\*2: If the EUROVENT Certified models can be operated under the "extra-low" temperature condition, -7°C dry bulb and -8°C wet-bulb temperatures with rated voltage 230 V shall be used.

\*3: Network Impedance shall be applicable for EUROPE and CHINA models.

\*4: The annual consumption is calculated by multiplying the input power at 230 V (400 V) by an average of 500 hours per year in cooling mode.

\*5: EER and COP classification is at 230 V (400 V) only in accordance with EU directive 2002/31/EC.

\*6: SEER and SCOP classification is at 230V(400V) only in accordance with EN-14825. For heating, SCOP indicates the value of only Average heating season.

# Single -Type

## 1-1. Unit Specifications

PE2

### 4. Low Silhouette Ducted Type S-60PF1E5A / U-60PE2E5A

| INDOOR   |   | MODEL  | S-60PF1E5A                               |            |                                     | -          |            |      | -      |      |
|--|---|--|--|------------|-------------------------------------|------------|------------|------|--------|------|
| OUTDOOR  |   | MODEL  | -  |            |                                     | U-60PE2E5A |            |      | -      |      |
| Branch pipe  |   | MODEL  | -  |            |                                     | -          |            |      | -      |      |
| Performance test condition                               |   | ISO13253 / EN14511 / EN12102 / EN14825           |  |            |                                     |            |            |      |        |      |
| Power supply   | Ø, Hz   | 1ø 50Hz  |  |            | 1ø 50Hz                             |            |            |      |        |      |
|  | V   | 220V   | 230V                                     | 240V       | 220V                                | 230V       | 240V       | Min  | Max    |      |
| Capacity   | kW  | 6.00   | 6.00                                     | 6.00       | -                                   | -          | -          | 2.0  | 7.1    |      |
|  | BTU/h   | 20500  | 20500                                    | 20500      | -                                   | -          | -          | 6800 | 24200  |      |
| Current  | A   | 0.91   | 0.89                                     | 0.87       | 7.70                                | 7.40       | 7.10       | -    | -      |      |
|  | W   | 120  | 120                                      | 120        | 1.530k                              | 1.530k     | 1.530k     | -    | -      |      |
| Input power  | TOTAL W   | -  |  |            | 1.650k                              | 1.650k     | 1.650k     | 335  | 2.350k |      |
|  | Annual consumption                                  | TOTAL kWh **                                     | -  |            |                                     | -          | 825        | -    | -      |      |
| EER/EER CLASS  | TOTAL (W/W) <sup>1)</sup> ("A"-G)                   | -  | -  | -          | 3.64                                | 3.64/A     | 3.64       | 5.97 | 3.02   |      |
| Erp <sup>6)</sup>  | Pdesign   | kW   | -  | -          | -                                   | -          | 6.0        | -    | -      |      |
|  | SEER  | (W/W)  | -  | -          | -                                   | -          | 6.1        | -    | -      |      |
|  | Annual consumption                                  | kWh  | -  | -          | -                                   | -          | 344        | -    | -      |      |
|  | Class   |  | -  | -          | -                                   | -          | A++        | -    | -      |      |
| Power factor   | %   | -  | -  | -          | 90                                  | 90         | 90         | -    | -      |      |
| Noise indoor   | dB-A (H/M/L)  | 35/32/26   |  |            | -                                   |            |            | -    | -      |      |
|  | Power Level dB                                      | 57/54/48   |  |            | -                                   |            |            | -    | -      |      |
| Noise outdoor  | dB-A (H/L)  | -  |  |            | 46/-                                |            |            | -    | -      |      |
|  | Power Level dB                                      | -  |  |            | 65/-                                |            |            | -    | -      |      |
| Capacity   | kW  | 7.00   | 7.00                                     | 7.00       | -                                   | -          | -          | 1.8  | 8.0    |      |
|  | BTU/h   | 23900  | 23900                                    | 23900      | -                                   | -          | -          | 6100 | 27300  |      |
| Current  | A   | 0.91   | 0.89                                     | 0.87       | 8.25                                | 7.85       | 7.55       | -    | -      |      |
|  | W   | 120  | 120                                      | 120        | 1.630k                              | 1.630k     | 1.630k     | -    | -      |      |
| Input power  | TOTAL W   | -  |  |            | 1.750k                              | 1.750k     | 1.750k     | 285  | 2.100k |      |
|  | COP/COP CLASS                                       | TOTAL (W/W) <sup>1)</sup> ("A"-G)                | -  | -          | -                                   | 4.00       | 4.00/A     | 4.00 | 6.32   | 3.81 |
| Erp <sup>6)</sup>  | Pdesign at -10°C                                    | kW   | -  | -          | -                                   | -          | 6.0        | -    | -      |      |
|  | Tbivalent   | °C   | -  | -          | -                                   | -          | -8         | -    | -      |      |
|  | SCOP  | (W/W)  | -  | -          | -                                   | -          | 4.0        | -    | -      |      |
|  | Annual consumption                                  | kWh  | -  | -          | -                                   | -          | 2100       | -    | -      |      |
| Class  |   | -  | -  | -          | -                                   | A+         | -          | -    |        |      |
| Power factor   | %   | -  | -  | -          | 90                                  | 90         | 90         | -    | -      |      |
| Noise indoor   | dB-A (H/M/L)  | 35/32/26   |  |            | -                                   |            |            | -    | -      |      |
|  | Power Level dB                                      | 57/54/48   |  |            | -                                   |            |            | -    | -      |      |
| Noise outdoor  | dB-A (H/L)  | -  |  |            | 49/-                                |            |            | -    | -      |      |
|  | Power Level dB                                      | -  |  |            | 69/-                                |            |            | -    | -      |      |
| EXTRA LOW TEMP Total capacity(kW) / Input power(W) / COP |   | -  |  |            |                                     |            |            |      |        |      |
| Max Current(A) / Max Input power(W)                      |   | 1.26/160   | 1.20/160                                 | 1.15/160   | 16.5/3.27k                          | 16.5/3.42k | 16.5/3.57k | -    |        |      |
| Starting current(A) / Comp output(W)                     |   | -  | -  | -          | 8.25/1.7k                           | 7.85/1.7k  | 7.55/1.7k  | -    |        |      |
| Network Impedance(ΩMAX.)                                 |   | -  |  |            |                                     |            |            |      |        |      |
| Fan motor output (Indoor/Outdoor) W                      |   | 120  |  |            | 60                                  |            |            | -    |        |      |
| Moisture removal volume                                  |   | L/h(Pt/h)  | 3.4                                      | (7.1)      |                                     | -          |            |      | -      |      |
| External static pressure                                 |   | Pa   | 70 (MIN10 - MAX150)                      |            |                                     | -          |            |      | -      |      |
| Indoor Air flow  | Cooling   | m³/min (ft³/min)                                 | 21.0 / 19.0 / 15.0 (742) / (671) / (530) |            |                                     | -          |            |      | -      |      |
|  | Heating   | m³/min (ft³/min)                                 | 21.0 / 19.0 / 15.0 (742) / (671) / (530) |            |                                     | -          |            |      | -      |      |
| Outdoor Air flow   | Cooling   | m³/min (ft³/min)                                 | -  |            |                                     | 38         | (1342)     | -    |        |      |
|  | Heating   | m³/min (ft³/min)                                 | -  |            |                                     | 41         | (1448)     | -    |        |      |
| Refrigerant type / amount g(oz)                          |   | -  |  |            | R410A                               | 1.95k      | (68.8)     | -    |        |      |
| Product dimension  | Height  | mm(inch)   | 290                                      | (11-13/32) |                                     | 619        | (24-3/8)   | -    |        |      |
|  | Width   | mm(inch)   | 1000                                     | (39-3/8)   |                                     | 799        | (31-29/64) | -    |        |      |
|  | Depth   | mm(inch)   | 700                                      | (27-9/16)  |                                     | 299        | (11-49/64) | -    |        |      |
| Product dimension (Panel)                                |   | H×W×D mm, inch                                   | -  |            |                                     | -          |            |      | -      |      |
| Packing dimension  | Height  | mm(inch)   | 355                                      | (13-31/32) |                                     | 688        |            |      | -      |      |
|  | Width   | mm(inch)   | 1214                                     | (47-13/16) |                                     | 931        |            |      | -      |      |
|  | Depth   | mm(inch)   | 850                                      | (33-15/32) |                                     | 422        |            |      | -      |      |
| Weight   | (NET)   | kg(lb)   | 33                                       | (73)       |                                     | 40         | (88)       | -    |        |      |
|  | (GROSS)   | kg(lb)   | 41                                       | (91)       |                                     | 45         | (99)       | -    |        |      |
|  | Panel (NET)   | kg(lb)   | -  |            |                                     | -          |            |      | -      |      |
| Layers limit (actually)                                  |   | 9 (10)   |  |            | 5 (6)                               |            |            | -    |        |      |
| Operation condition                                      | Cool (DBT)  | 18°C ~ 32°C                                      |  |            | -15°C ~ 46°C                        |            |            | -    |        |      |
|  | Heat (DBT)  | 16°C ~ 30°C                                      |  |            | -20°C ~ 24°C                        |            |            | -    |        |      |
| P I P I N G  | Pipe diameter mm (inch)                             | (Liquid)ø9.52(3/8) (Gas)ø15.88(5/8)              |  |            | (Liquid)ø9.52(3/8) (Gas)ø15.88(5/8) |            |            | -    |        |      |
|  | Connecting method, Standard length m(ft)            | flared type, 5.0(16.4)                           |  |            | flared type, 5.0(16.4)              |            |            | -    |        |      |
| P I N G  | Pipe length range m (ft)                            | 3 ~ 40m (9.8 ~ 131.2)                            |  |            | -                                   |            |            | -    |        |      |
|  | Indoor unit & Outdoor unit height difference m (ft) | 15m (OD located lower) / 30m (OD located higher) |  |            | (49.2/98.4)                         |            |            | -    |        |      |
| N G  | Add gas amount g/m (oz/ft)                          | 40g (0.430)                                      |  |            | -                                   |            |            | -    |        |      |
|  | Pipe length for additional gas m (ft)               | 30m (98.4)                                       |  |            | -                                   |            |            | -    |        |      |

\*1: In case it is necessary to indicate the air flow volume in (l/s), the value in (m³/min.) shall be multiplied by 16.7 and rounded down the decimal point.  
 \*2: If the EUROVENT Certified models can be operated under the "extra-low" temperature condition, -7°C dry bulb and -8°C wet-bulb temperatures with rated voltage 230 V shall be used.  
 \*3: Network Impedance shall be applicable for EUROPE and CHINA models.  
 \*4: The annual consumption is calculated by multiplying the input power at 230V (400V) by an average of 500 hours per year in cooling mode.  
 \*5: EER and COP classification is at 230V (400 V) only in accordance with EU directive 2002/31/EC.  
 \*6: SEER and SCOP classification is at 230V (400V) only in accordance with EN-14825. For heating, SCOP indicates the value of only Average heating season, Other fiche data indicates in an attached sheet.

# Simultaneous (Twin) -Type

## 1-1. Unit Specifications

**PE1**

### 4. Low Silhouette Ducted Type S-60PF1E5A×2 / U-125PE1E5A

| INDOOR   |  | MODEL  | S-60PF1E5A×2               |              |                                     | -              |             |          | -     |        |      |
|--|--|--|----------------------------|--------------|-------------------------------------|----------------|-------------|----------|-------|--------|------|
| OUTDOOR  |  | MODEL  | -                          |              |                                     | U-125PE1E5A    |             |          | -     |        |      |
| Branch pipe  |  | MODEL  | CZ-P155BK1                 |              |                                     |                |             |          |       | -      |      |
| Performance test condition                               |  | ISO13253 / EN14511 / EN12102 / EN14825         |                            |              |                                     |                |             |          |       |        |      |
| Power supply   |  | Ø, Hz  | 1ø 50Hz                    |              |                                     | 1ø 50Hz        |             |          |       |        |      |
|  |  | V  | 220                        | 230          | 240                                 | 220            | 230         | 240      | Min   | Max    |      |
| C<br>O<br>O<br>L<br>I<br>N<br>G                          | Capacity                                 | kW   | 12.5                       | 12.5         | 12.5                                | -              | -           | -        | 3.3   | 14.0   |      |
|  |  | BTU/h  | 42700                      | 42700        | 42700                               | -              | -           | -        | 11300 | 47800  |      |
|  | Current                                  | A  | 0.91×2                     | 0.89×2       | 0.87×2                              | 16.6           | 15.9        | 15.3     | -     | -      |      |
|  |  | W  | 120×2                      | 120×2        | 120×2                               | 3.355k         | 3.355k      | 3.355k   | -     | -      |      |
|  | Input power                              | TOTAL W  | -                          |              |                                     | 3.595k         | 3.595k      | 3.595k   | 840   | 4.600k |      |
|  |  | Annual consumption                             | TOTAL kWh **4              | -            |                                     |                | -           | 1797.5   | -     | -      | -    |
|  | EER/EER CLASS                            | TOTAL (W/W) **5 / ("A"-*G)                     | -                          | -            | -                                   | 3.48           | 3.48 / A    | 3.48     | 3.93  | 3.04   |      |
|  | Erp<br>*6                                | Pdesign  | kW                         | -            | -                                   | -              | -           | 12.5     | -     | -      | -    |
|  |  | η <sub>s.c</sub>                               | %                          | -            | -                                   | -              | -           | 234.1    | -     | -      | -    |
|  |  | Annual consumption                             | kWh                        | -            | -                                   | -              | -           | -        | -     | -      | -    |
|  |  | Class  |                            | -            | -                                   | -              | -           | -        | -     | -      | -    |
|  | Power factor                             | %  | -                          | -            | -                                   | 92             | 92          | 91       | -     | -      |      |
|  | Noise indoor                             | dB-A (H/M/L)                                   | 35/32/26                   |              |                                     | -              | -           | -        | -     | -      |      |
|  |  | Power Level dB                                 | 57/54/48                   |              |                                     | -              | -           | -        | -     | -      |      |
| Noise outdoor  | dB-A (H/L)                               | -  |                            |              | 53/-                                |                |             | -        | -     |        |      |
|  | Power Level dB                           | -  |                            |              | 70/-                                |                |             | -        | -     |        |      |
| H<br>E<br>A<br>T<br>I<br>N<br>G                          | Capacity                                 | kW   | 14.0                       | 14.0         | 14.0                                | -              | -           | -        | 4.1   | 16.0   |      |
|  |  | BTU/h  | 47800                      | 47800        | 47800                               | -              | -           | -        | 14000 | 54600  |      |
|  | Current                                  | A  | 0.91×2                     | 0.89×2       | 0.87×2                              | 16.3           | 15.8        | 15.1     | -     | -      |      |
|  |  | W  | 120×2                      | 120×2        | 120×2                               | 3.270k         | 3.270k      | 3.270k   | -     | -      |      |
|  | Input power                              | TOTAL W  | -                          |              |                                     | 3.510k         | 3.510k      | 3.510k   | 900   | 5.200k |      |
|  |  | COP/COP CLASS                                  | TOTAL (W/W) **5 / ("A"-*G) | -            | -                                   | -              | 3.99        | 3.99 / A | 3.99  | 4.56   | 3.08 |
|  | Erp<br>*6                                | Pdesign at -10°C                               | kW                         | -            | -                                   | -              | -           | 12.5     | -     | -      | -    |
|  |  | Tbivalent                                      | °C                         | -            | -                                   | -              | -           | -9       | -     | -      | -    |
|  |  | η <sub>s.h</sub>                               | %                          | -            | -                                   | -              | -           | 146.6    | -     | -      | -    |
|  |  | Annual consumption                             | kWh                        | -            | -                                   | -              | -           | -        | -     | -      | -    |
|  | Class                                    |  | -                          | -            | -                                   | -              | -           | -        | -     | -      |      |
|  | Power factor                             | %  | -                          | -            | -                                   | 91             | 90          | 90       | -     | -      |      |
|  | Noise indoor                             | dB-A (H/M/L)                                   | 35/32/26                   |              |                                     | -              | -           | -        | -     | -      |      |
|  |  | Power Level dB                                 | 57/54/48                   |              |                                     | -              | -           | -        | -     | -      |      |
| Noise outdoor  | dB-A (H/L)                               | -  |                            |              | 53/-                                |                |             | -        | -     |        |      |
|  | Power Level dB                           | -  |                            |              | 70/-                                |                |             | -        | -     |        |      |
| EXTRA LOW TEMP Total capacity(kW) / Input power(W) / COP |  | -  |                            |              |                                     |                |             |          |       |        |      |
| Max Current(A) / Max Input power(W)                      |  | 1.26×2/160×2                                   | 1.20×2/160×2               | 1.15×2/160×2 | 28.0/6.000k                         | 28.0/6.200k    | 28.0/6.400k | -        |       |        |      |
| Starting current(A) / Comp output(W)                     |  | -  | -                          | -            | 16.6/3.0k                           | 15.9/3.0k      | 15.3/3.0k   | -        |       |        |      |
| Network Impedance(ΩMAX.)                                 |  | -  |                            |              |                                     |                |             |          |       |        |      |
| Fan motor output (Indoor/Outdoor) W                      |  | 120  |                            |              | 90×2                                |                |             | -        |       |        |      |
| Moisture removal volume                                  |  | L/h(Pt/h)                                      | 7.9                        | (3.95×2)     | (16.6)                              | -              |             |          | -     |        |      |
| External static pressure                                 |  | Pa   | 70 (MIN10 - MAX150)        |              |                                     | -              |             |          | -     |        |      |
| Indoor Air flow  | Cooling                                  | m³/min (ft³/min)                               | [21/19/15 (742/671/530)]×2 |              |                                     | -              |             |          | -     |        |      |
|  | Heating                                  | m³/min (ft³/min)                               | [21/19/15 (742/671/530)]×2 |              |                                     | -              |             |          | -     |        |      |
| Outdoor Air flow   | Cooling                                  | m³/min (ft³/min)                               | -                          |              |                                     | 130            | (4591)      | -        |       |        |      |
|  | Heating                                  | m³/min (ft³/min)                               | -                          |              |                                     | 110            | (3885)      | -        |       |        |      |
| Refrigerant type / amount g(oz)                          |  | -  |                            |              | R410A                               | 3.40k          | (119.9)     | -        |       |        |      |
| Product dimension  | Height                                   | mm(inch)                                       | 290 (11-13/32)             |              |                                     | 1416 (55-3/4)  |             |          | -     |        |      |
|  | Width                                    | mm(inch)                                       | 1000 (39-3/8)              |              |                                     | 940 (37-1/32)  |             |          | -     |        |      |
|  | Depth                                    | mm(inch)                                       | 700 (27-9/16)              |              |                                     | 340 (13-13/32) |             |          | -     |        |      |
| Packing dimension  | Height                                   | mm(inch)                                       | 355                        |              |                                     | 1556           |             |          | -     |        |      |
|  | Width                                    | mm(inch)                                       | 1214                       |              |                                     | 1055           |             |          | -     |        |      |
|  | Depth                                    | mm(inch)                                       | 850                        |              |                                     | 485            |             |          | -     |        |      |
| Weight   | (NET)                                    | kg(lb)   | 33 (73)                    |              |                                     | 98 (216)       |             |          | -     |        |      |
|  | (GROSS)                                  | kg(lb)   | 41 (91)                    |              |                                     | 108 (238)      |             |          | -     |        |      |
| Layers limit (actually)                                  |  | 9 (10)   |                            |              | 1 (2)                               |                |             | -        |       |        |      |
| Operation condition                                      | Cool (DBT)                               | 18°C ~ 32°C                                    |                            |              | -15°C ~ 46°C                        |                |             | -        |       |        |      |
|  | Heat (DBT)                               | 16°C ~ 30°C                                    |                            |              | -20°C ~ 24°C                        |                |             | -        |       |        |      |
| P<br>I<br>P<br>I<br>N<br>G                               | Pipe diameter mm (inch)                  | (Liquid)ø9.52(3/8) (Gas)ø15.88(5/8)            |                            |              | (Liquid)ø9.52(3/8) (Gas)ø15.88(5/8) |                |             | -        |       |        |      |
|  | Connecting method, Standard length m(ft) | flared type, 5.0(16.4)                         |                            |              | flared type, 5.0(16.4)              |                |             | -        |       |        |      |
| Pipe length range m (ft)                                 |  | 5 ~ 75 (16.4 ~ 246.1)                          |                            |              | -                                   |                |             | -        |       |        |      |
| Indoor unit & Outdoor unit height difference m (ft)      |  | 15 (OD located lower) / 30 (OD located higher) |                            |              | (49.2/98.4)                         |                |             | -        |       |        |      |
| Add gas amount g/m (oz/ft)                               |  | 50   |                            |              | (0.538)                             |                |             | -        |       |        |      |
| Pipe length for additional gas m (ft)                    |  | 30   |                            |              | (98.4)                              |                |             | -        |       |        |      |

\*1: In case it is necessary to indicate the air flow volume in (l/s), the value in (m³/min.) shall be multiplied by 16.7 and rounded down the decimal point.

\*2: If the EUROVENT Certified models can be operated under the "extra-low" temperature condition, -7°C dry bulb and -8°C wet-bulb temperatures with rated voltage 230 V shall be used.

\*3: Network Impedance shall be applicable for EUROPE and CHINA models.

\*4: The annual consumption is calculated by multiplying the input power at 230 V (400 V) by an average of 500 hours per year in cooling mode.

\*5: EER and COP classification is at 230 V (400 V) only in accordance with EU directive 2002/31/EC.

\*6: SEER and SCOP classification is at 230V(400V) only in accordance with EN-14825. For heating, SCOP indicates the value of only Average heating season.

# Single -Type

## 1-1. Unit Specifications

PE1

### 4. Low Silhouette Ducted Type S-71PF1E5A / U-71PE1E5A

| INDOOR   |  | MODEL  | S-71PF1E5A              |          |                                     | -              |             |          | -        |        |      |
|--|--|--|-------------------------|----------|-------------------------------------|----------------|-------------|----------|----------|--------|------|
| OUTDOOR  |  | MODEL  | -                       |          |                                     | U-71PE1E5A     |             |          | -        |        |      |
| Branch pipe  |  | MODEL  | -                       |          |                                     | -              |             |          | -        |        |      |
| Performance test condition                               |  | ISO13253 / EN14511 / EN14825 / EN12102         |                         |          |                                     |                |             |          |          |        |      |
| Power supply   |  | Ø, Hz  | 1ø 50Hz                 |          |                                     | 1ø 50Hz        |             |          |          |        |      |
|  |  | V  | 220                     | 230      | 240                                 | 220            | 230         | 240      | Min      | Max    |      |
| C<br>O<br>O<br>L<br>I<br>N<br>G                          | Capacity                                 | kW   | 7.10                    | 7.10     | 7.10                                | -              | -           | -        | 2.5      | 8.0    |      |
|  |  | BTU/h  | 24200                   | 24200    | 24200                               | -              | -           | -        | 8500     | 27300  |      |
|  | Current                                  | A  | 0.91                    | 0.89     | 0.87                                | 8.90           | 8.60        | 8.30     | -        | -      |      |
|  |  | W  | 120                     | 120      | 120                                 | 1.730k         | 1.730k      | 1.730k   | -        | -      |      |
|  | Input power                              | TOTAL W  | -                       |          |                                     | 1.850k         | 1.850k      | 1.850k   | 530      | 2.650k |      |
|  |  | Annual consumption                             | TOTAL kWh *4            | -        |                                     |                | -           | 925      | -        | -      | -    |
|  | EER/EER CLASS                            | TOTAL (W/W) *5 ("A"-*G)                        | -                       | -        | -                                   | 3.84 / A       | 3.84 / A    | 3.84 / A | 4.72     | 3.02   |      |
|  | Erp *6                                   | Pdesign  | kW                      | -        | -                                   | -              | -           | 7.1      | -        | -      | -    |
|  |  | SEER   | (W/W)                   | -        | -                                   | -              | -           | 6.4      | -        | -      | -    |
|  |  | Annual consumption                             | kWh                     | -        | -                                   | -              | -           | 388      | -        | -      | -    |
| Class  |  |  | -                       | -        | -                                   | -              | A++         | -        | -        | -      |      |
| Power factor   | %  | -  | -                       | -        | 94                                  | 94             | 93          | -        | -        |        |      |
| Noise indoor   | dB-A (H/M/L)                             | 35/32/26                                       |                         |          | -                                   |                |             | -        | -        |        |      |
|  | Power Level dB                           | 57/54/48                                       |                         |          | -                                   |                |             | -        | -        |        |      |
| Noise outdoor  | dB-A (H/L)                               | -  |                         |          | 48                                  |                |             | -        | -        |        |      |
|  | Power Level dB                           | -  |                         |          | 65                                  |                |             | -        | -        |        |      |
| H<br>E<br>A<br>T<br>I<br>N<br>G                          | Capacity                                 | kW   | 8.00                    | 8.00     | 8.00                                | -              | -           | -        | 2.0      | 9.0    |      |
|  |  | BTU/h  | 27300                   | 27300    | 27300                               | -              | -           | -        | 6800     | 30700  |      |
|  | Current                                  | A  | 0.91                    | 0.89     | 0.87                                | 9.90           | 9.50        | 9.20     | -        | -      |      |
|  |  | W  | 120                     | 120      | 120                                 | 1.960k         | 1.960k      | 1.960k   | -        | -      |      |
|  | Input power                              | TOTAL W  | -                       |          |                                     | 2.080k         | 2.080k      | 2.080k   | 480      | 2.900k |      |
|  |  | COP/COP CLASS                                  | TOTAL (W/W) *5 ("A"-*G) | -        | -                                   | -              | 3.85 / A    | 3.85 / A | 3.85 / A | 4.17   | 3.10 |
|  | Erp *6                                   | Pdesign at -10°C                               | kW                      | -        | -                                   | -              | -           | 7.1      | -        | -      | -    |
|  |  | Tbivalent                                      | °C                      | -        | -                                   | -              | -           | -9       | -        | -      | -    |
|  |  | SCOP   | (W/W)                   | -        | -                                   | -              | -           | 4.0      | -        | -      | -    |
|  |  | Annual consumption                             | kWh                     | -        | -                                   | -              | -           | 2485     | -        | -      | -    |
| Class  |  | -  | -                       | -        | -                                   | A+             | -           | -        | -        |        |      |
| Power factor   | %  | -  | -                       | -        | 96                                  | 95             | 94          | -        | -        |        |      |
| Noise indoor   | dB-A (H/M/L)                             | 35/32/26                                       |                         |          | -                                   |                |             | -        | -        |        |      |
|  | Power Level dB                           | 57/54/48                                       |                         |          | -                                   |                |             | -        | -        |        |      |
| Noise outdoor  | dB-A (H/L)                               | -  |                         |          | 50                                  |                |             | -        | -        |        |      |
|  | Power Level dB                           | -  |                         |          | 67                                  |                |             | -        | -        |        |      |
| EXTRA LOW TEMP Total capacity(kW) / Input power(W) / COP |  | -  |                         |          |                                     |                |             |          |          |        |      |
| Max Current(A) / Max Input power(W)                      |  | 1.26/160                                       | 1.20/160                | 1.15/160 | 18.0/3.800k                         | 18.0/3.930k    | 18.0/4.060k | -        |          |        |      |
| Starting current(A) / Comp output(W)                     |  | -  | -                       | -        | 9.90/2.000k                         | 9.50/2.000k    | 9.20/2.000k | -        |          |        |      |
| Network Impedance(ΩMAX.)                                 |  | -  |                         |          |                                     |                |             |          |          |        |      |
| Fan motor output (Indoor/Outdoor) W                      |  | 120  |                         |          | 90                                  |                |             | -        |          |        |      |
| Moisture removal volume                                  |  | L/h(Pt/h)                                      | 4.2                     | (8.8)    |                                     | -              |             |          | -        |        |      |
| External static pressure                                 |  | Pa   | 70 (MIN10 - MAX150)     |          |                                     | -              |             |          | -        |        |      |
| Indoor Air flow  | Cooling                                  | m³/min (ft³/min)                               | 21/19/15 (742/671/530)  |          |                                     | -              |             |          | -        |        |      |
|  | Heating                                  | m³/min (ft³/min)                               | 21/19/15 (742/671/530)  |          |                                     | -              |             |          | -        |        |      |
| Outdoor Air flow   | Cooling                                  | m³/min (ft³/min)                               | -                       |          |                                     | 60             | (2119)      |          | -        |        |      |
|  | Heating                                  | m³/min (ft³/min)                               | -                       |          |                                     | 60             | (2119)      |          | -        |        |      |
| Refrigerant type / amount g(oz)                          |  | -  |                         |          | R410A                               | 2.35k          | (82.9)      |          | -        |        |      |
| Product dimension  | Height                                   | mm(inch)                                       | 290 (11-13/32)          |          |                                     | 996 (39-7/32)  |             |          | -        |        |      |
|  | Width                                    | mm(inch)                                       | 1000 (39-3/8)           |          |                                     | 940 (37-1/32)  |             |          | -        |        |      |
|  | Depth                                    | mm(inch)                                       | 700 (27-9/16)           |          |                                     | 340 (13-13/32) |             |          | -        |        |      |
| Packing dimension  | Height                                   | mm(inch)                                       | 355                     |          |                                     | 1136           |             |          | -        |        |      |
|  | Width                                    | mm(inch)                                       | 1214                    |          |                                     | 1055           |             |          | -        |        |      |
|  | Depth                                    | mm(inch)                                       | 850                     |          |                                     | 485            |             |          | -        |        |      |
| Weight   | (NET)                                    | kg(lb)   | 33 (73)                 |          |                                     | 69 (152)       |             |          | -        |        |      |
|  | (GROSS)                                  | kg(lb)   | 41 (91)                 |          |                                     | 77 (170)       |             |          | -        |        |      |
| Layers limit (actually)                                  |  | 9 (10)   |                         |          | 2 (3)                               |                |             | -        |          |        |      |
| Operation condition                                      | Cool (DBT)                               | 18°C ~ 32°C                                    |                         |          | -15°C ~ 46°C                        |                |             | -        |          |        |      |
|  | Heat (DBT)                               | 16°C ~ 30°C                                    |                         |          | -20°C ~ 24°C                        |                |             | -        |          |        |      |
| P<br>I<br>P<br>I<br>N<br>G                               | Pipe diameter mm (inch)                  | (Liquid)ø9.52(3/8) (Gas)ø15.88(5/8)            |                         |          | (Liquid)ø9.52(3/8) (Gas)ø15.88(5/8) |                |             | -        |          |        |      |
|  | Connecting method, Standard length m(ft) | flared type, 5.0(16.4)                         |                         |          | flared type, 5.0(16.4)              |                |             | -        |          |        |      |
| Pipe length range m (ft)                                 |  | 5 ~ 50 (16.4 ~ 164.0)                          |                         |          | -                                   |                |             | -        |          |        |      |
| Indoor unit & Outdoor unit height difference m (ft)      |  | 15 (OD located lower) / 30 (OD located higher) |                         |          | (49.2/98.4)                         |                |             | -        |          |        |      |
| Add gas amount g/m (oz/ft)                               |  | 50   |                         |          | (0.538)                             |                |             | -        |          |        |      |
| Pipe length for additional gas m (ft)                    |  | 30   |                         |          | (98.4)                              |                |             | -        |          |        |      |

\*1: In case it is necessary to indicate the air flow volume in (l/s), the value in (m³/min.) shall be multiplied by 16.7 and rounded down the decimal point.  
 \*2: If the EUROVENT Certified models can be operated under the "extra-low" temperature condition, -7°C dry bulb and -8°C wet-bulb temperatures with rated voltage 230 V shall be used.  
 \*3: Network Impedance shall be applicable for EUROPE and CHINA models.  
 \*4: The annual consumption is calculated by multiplying the input power at 230 V (400 V) by an average of 500 hours per year in cooling mode.  
 \*5: EER and COP classification is at 230 V (400 V) only in accordance with EU directive 2002/31/EC.  
 \*6: SEER and SCOP classification is at 230V(400V) only in accordance with EN-14825. For heating, SCOP indicates the value of only Average heating season, Other fiche data indicates in an attached sheet.

# Simultaneous (Twin) -Type

## 1-1. Unit Specifications

**PE1**

### 4. Low Silhouette Ducted Type S-71PF1E5A×2 / U-140PE1E5A

| INDOOR   |  | MODEL                                  | S-71PF1E5A×2                        |  |              | -                                   |             |          | -     |        |      |
|--|--|--|-------------------------------------|--|--------------|-------------------------------------|-------------|----------|-------|--------|------|
| OUTDOOR  |  | MODEL                                  | -                                   |  |              | U-140PE1E5A                         |             |          | -     |        |      |
| Branch pipe  |  | MODEL                                  | CZ-P155BK1                          |  |              |                                     |             |          |       |        |      |
| Performance test condition                               |  | ISO13253 / EN14511 / EN12102 / EN14825 |                                     |  |              |                                     |             |          |       |        |      |
| Power supply   |  | Ø, Hz                                  | 1ø 50Hz                             |  |              | 1ø 50Hz                             |             |          |       |        |      |
|  |  | V                                      | 220                                 | 230  | 240          | 220                                 | 230         | 240      | Min   | Max    |      |
| C<br>O<br>O<br>L<br>I<br>N<br>G                          | Capacity                                 | kW                                     | 14.0                                | 14.0   | 14.0         | -                                   | -           | -        | 3.3   | 15.5   |      |
|  |  | BTU/h                                  | 47800                               | 47800  | 47800        | -                                   | -           | -        | 11300 | 52900  |      |
|  | Current                                  | A                                      | 0.91×2                              | 0.89×2   | 0.87×2       | 20.1                                | 19.3        | 18.6     | -     | -      |      |
|  |  | W                                      | 120×2                               | 120×2  | 120×2        | 4.085k                              | 4.085k      | 4.085k   | -     | -      |      |
|  | Input power                              | TOTAL W                                | -                                   |  |              | 4.325k                              | 4.325k      | 4.325k   | 840   | 6.000k |      |
|  |  | Annual consumption                     | TOTAL kWh **4                       | -  |              |                                     | -           | 2162.5   | -     | -      | -    |
|  | EER/EER CLASS                            |  | TOTAL (W/W) **5 / ("A"-*G)          | -  | -            | -                                   | 3.24        | 3.24 / A | 3.24  | 3.93   | 2.58 |
|  | Erp<br>*6                                | Pdesign                                | kW                                  | -  | -            | -                                   | -           | 14.0     | -     | -      | -    |
|  |  | η <sub>s.c</sub>                       | %                                   | -  | -            | -                                   | -           | 226.3    | -     | -      | -    |
|  |  | Annual consumption                     | kWh                                 | -  | -            | -                                   | -           | -        | -     | -      | -    |
| Class  |  |  | -                                   | -  | -            | -                                   | -           | -        | -     | -      |      |
| Power factor   |  | %                                      | -                                   | -  | -            | 93                                  | 92          | 92       | -     | -      |      |
| Noise indoor   | dB-A (H/M/L)                             | 35/32/26                               |                                     |  | -            | -                                   | -           | -        | -     |        |      |
|  | Power Level dB                           | 57/54/48                               |                                     |  | -            | -                                   | -           | -        | -     |        |      |
| Noise outdoor  | dB-A (H/L)                               | -                                      |                                     |  | 54/-         |                                     |             | -        | -     |        |      |
|  | Power Level dB                           | -                                      |                                     |  | 71/-         |                                     |             | -        | -     |        |      |
| H<br>E<br>A<br>T<br>I<br>N<br>G                          | Capacity                                 | kW                                     | 16.0                                | 16.0   | 16.0         | -                                   | -           | -        | 4.1   | 18.0   |      |
|  |  | BTU/h                                  | 54600                               | 54600  | 54600        | -                                   | -           | -        | 14000 | 61400  |      |
|  | Current                                  | A                                      | 0.91×2                              | 0.89×2   | 0.87×2       | 19.9                                | 19.1        | 18.4     | -     | -      |      |
|  |  | W                                      | 120×2                               | 120×2  | 120×2        | 4.215k                              | 4.215k      | 4.215k   | -     | -      |      |
|  | Input power                              | TOTAL W                                | -                                   |  |              | 4.455k                              | 4.455k      | 4.455k   | 900   | 5.900k |      |
|  |  | COP/COP CLASS                          | TOTAL (W/W) **5 / ("A"-*G)          | -  | -            | -                                   | 3.59        | 3.59 / A | 3.59  | 4.56   | 3.05 |
|  | Erp<br>*6                                | Pdesign at -10°C                       | kW                                  | -  | -            | -                                   | -           | 14.0     | -     | -      | -    |
|  |  | Tbivalent                              | °C                                  | -  | -            | -                                   | -           | -7       | -     | -      | -    |
|  |  | η <sub>s.h</sub>                       | %                                   | -  | -            | -                                   | -           | 143.0    | -     | -      | -    |
|  |  | Annual consumption                     | kWh                                 | -  | -            | -                                   | -           | -        | -     | -      | -    |
| Power factor   |  | %                                      | -                                   | -  | -            | 96                                  | 96          | 95       | -     | -      |      |
| Noise indoor   | dB-A (H/M/L)                             | 35/32/26                               |                                     |  | -            | -                                   | -           | -        | -     |        |      |
|  | Power Level dB                           | 57/54/48                               |                                     |  | -            | -                                   | -           | -        | -     |        |      |
| Noise outdoor  | dB-A (H/L)                               | -                                      |                                     |  | 55/-         |                                     |             | -        | -     |        |      |
|  | Power Level dB                           | -                                      |                                     |  | 71/-         |                                     |             | -        | -     |        |      |
| EXTRA LOW TEMP Total capacity(kW) / Input power(W) / COP |  | -                                      |                                     |  |              |                                     |             |          |       |        |      |
| Max Current(A) / Max Input power(W)                      |  | 1.26×2/160×2                           | 1.20×2/160×2                        | 1.15×2/160×2                                   | 30.0/6.450k  | 30.0/6.650k                         | 30.0/6.850k | -        |       |        |      |
| Starting current(A) / Comp output(W)                     |  | -                                      | -                                   | -  | 20.1/3.0k    | 19.3/3.0k                           | 18.6/3.0k   | -        |       |        |      |
| Network Impedance(ΩMAX.)                                 |  | -                                      |                                     |  |              |                                     |             |          |       |        |      |
| Fan motor output (Indoor/Outdoor) W                      |  | 120                                    |                                     |  | 90×2         |                                     |             | -        |       |        |      |
| Moisture removal volume                                  |  | L/h(Pt/h)                              | 9.0                                 | (4.5×2)  | (18.9)       | -                                   |             |          | -     |        |      |
| External static pressure                                 |  | Pa                                     | 70 (MIN10 - MAX150)                 |  |              | -                                   |             |          | -     |        |      |
| Indoor Air flow  | Cooling                                  | m³/min (ft³/min)                       | [21/19/15 (742/671/530)]×2          |  |              | -                                   |             |          | -     |        |      |
|  | Heating                                  | m³/min (ft³/min)                       | [21/19/15 (742/671/530)]×2          |  |              | -                                   |             |          | -     |        |      |
| Outdoor Air flow   | Cooling                                  | m³/min (ft³/min)                       | -                                   |  |              | 135                                 | (4767)      | -        |       |        |      |
|  | Heating                                  | m³/min (ft³/min)                       | -                                   |  |              | 120                                 | (4238)      | -        |       |        |      |
| Refrigerant type / amount g(oz)                          |  | -                                      |                                     |  | R410A        | 3.40k                               | (119.9)     | -        |       |        |      |
| Product dimension  | Height                                   | mm(inch)                               | 290 (11-13/32)                      |  |              | 1416 (55-3/4)                       |             |          | -     |        |      |
|  | Width                                    | mm(inch)                               | 1000 (39-3/8)                       |  |              | 940 (37-1/32)                       |             |          | -     |        |      |
|  | Depth                                    | mm(inch)                               | 700 (27-9/16)                       |  |              | 340 (13-13/32)                      |             |          | -     |        |      |
| Packing dimension  | Height                                   | mm(inch)                               | 355                                 |  |              | 1556                                |             |          | -     |        |      |
|  | Width                                    | mm(inch)                               | 1214                                |  |              | 1055                                |             |          | -     |        |      |
|  | Depth                                    | mm(inch)                               | 850                                 |  |              | 485                                 |             |          | -     |        |      |
| Weight   | (NET)                                    | kg(lb)                                 | 33 (73)                             |  |              | 98 (216)                            |             |          | -     |        |      |
|  | (GROSS)                                  | kg(lb)                                 | 41 (91)                             |  |              | 108 (238)                           |             |          | -     |        |      |
| Layers limit (actually)                                  |  | 9 (10)                                 |                                     |  | 1 (2)        |                                     |             | -        |       |        |      |
| Operation condition                                      | Cool (DBT)                               | 18°C ~ 32°C                            |                                     |  | -15°C ~ 46°C |                                     |             | -        |       |        |      |
|  | Heat (DBT)                               | 16°C ~ 30°C                            |                                     |  | -20°C ~ 24°C |                                     |             | -        |       |        |      |
| P<br>I<br>P<br>I<br>N<br>G                               | Pipe diameter mm (inch)                  |  | (Liquid)ø9.52(3/8) (Gas)ø15.88(5/8) |  |              | (Liquid)ø9.52(3/8) (Gas)ø15.88(5/8) |             |          | -     |        |      |
|  | Connecting method, Standard length m(ft) |  | flared type, 5.0(16.4)              |  |              | flared type, 5.0(16.4)              |             |          | -     |        |      |
| Pipe length range  |  | m (ft)                                 |                                     | 5 ~ 75 (16.4 ~ 246.1)                          |              | -                                   |             |          |       |        |      |
| Indoor unit & Outdoor unit height difference             |  | m (ft)                                 |                                     | 15 (OD located lower) / 30 (OD located higher) |              | (49.2/98.4)                         |             | -        |       |        |      |
| Add gas amount   |  | g/m (oz/ft)                            |                                     | 50 (0.538)                                     |              | -                                   |             |          |       |        |      |
| Pipe length for additional gas                           |  | m (ft)                                 |                                     | 30 (98.4)                                      |              | -                                   |             |          |       |        |      |

\*1: In case it is necessary to indicate the air flow volume in (l/s), the value in (m³/min.) shall be multiplied by 16.7 and rounded down the decimal point.

\*2: If the EUROVENT Certified models can be operated under the "extra-low" temperature condition, -7°C dry bulb and -8°C wet-bulb temperatures with rated voltage 230 V shall be used.

\*3: Network Impedance shall be applicable for EUROPE and CHINA models.

\*4: The annual consumption is calculated by multiplying the input power at 230 V (400 V) by an average of 500 hours per year in cooling mode.

\*5: EER and COP classification is at 230 V (400 V) only in accordance with EU directive 2002/31/EC.

\*6: SEER and SCOP classification is at 230V(400V) only in accordance with EN-14825. For heating, SCOP indicates the value of only Average heating season.

# Single -Type

## 1-1. Unit Specifications

PE1

### 4. Low Silhouette Ducted Type S-100PF1E5A / U-100PE1E5A

| INDOOR   |  | MODEL  | S-100PF1E5A              |          |                                     | -              |             |          | -     |        |      |
|--|--|--|--------------------------|----------|-------------------------------------|----------------|-------------|----------|-------|--------|------|
| OUTDOOR  |  | MODEL  | -                        |          |                                     | U-100PE1E5A    |             |          | -     |        |      |
| Branch pipe  |  | MODEL  | -                        |          |                                     | -              |             |          | -     |        |      |
| Performance test condition                               |  | ISO13253 / EN14511 / EN14825 / EN12102         |                          |          |                                     |                |             |          |       |        |      |
| Power supply   |  | Ø, Hz  | 1ø 50Hz                  |          |                                     | 1ø 50Hz        |             |          |       |        |      |
|  |  | V  | 220                      | 230      | 240                                 | 220            | 230         | 240      | Min   | Max    |      |
| C<br>O<br>O<br>L<br>I<br>N<br>G                          | Capacity                                 | kW   | 10.0                     | 10.0     | 10.0                                | -              | -           | -        | 3.3   | 12.5   |      |
|  |  | BTU/h  | 34100                    | 34100    | 34100                               | -              | -           | -        | 11300 | 42700  |      |
|  | Current                                  | A  | 1.35                     | 1.30     | 1.27                                | 11.0           | 10.6        | 10.3     | -     | -      |      |
|  |  | W  | 195                      | 195      | 195                                 | 2,245k         | 2,245k      | 2,245k   | -     | -      |      |
|  | Input power                              | TOTAL W  | -                        |          |                                     | 2,440k         | 2,440k      | 2,440k   | 840   | 3,700k |      |
|  |  | Annual consumption                             | TOTAL kWh *4             | -        |                                     |                | -           | 1220     | -     | -      | -    |
|  | EER/EER CLASS                            | TOTAL (W/W) *5 / ("A"-G)                       | -                        | -        | -                                   | 4.10           | 4.10 / A    | 4.10     | 3.93  | 3.38   |      |
|  | Erp *6                                   | Pdesign  | kW                       | -        | -                                   | -              | -           | 10.0     | -     | -      | -    |
|  |  | SEER   | (W/W)                    | -        | -                                   | -              | -           | 5.8      | -     | -      | -    |
|  |  | Annual consumption                             | kWh                      | -        | -                                   | -              | -           | 603      | -     | -      | -    |
|  |  | Class  |                          | -        | -                                   | -              | -           | A+       | -     | -      | -    |
|  | Power factor                             | %  | -                        | -        | -                                   | 93             | 92          | 91       | -     | -      |      |
|  | Noise indoor                             | dB-A (H/M/L)                                   | 38/34/31                 |          |                                     | -              |             |          | -     | -      |      |
|  |  | Power Level dB                                 | 60/56/53                 |          |                                     | -              |             |          | -     | -      |      |
| Noise outdoor  | dB-A (H/L)                               | -  |                          |          | 52/-                                |                |             | -        | -     |        |      |
|  | Power Level dB                           | -  |                          |          | 69/-                                |                |             | -        | -     |        |      |
| H<br>E<br>A<br>T<br>I<br>N<br>G                          | Capacity                                 | kW   | 11.2                     | 11.2     | 11.2                                | -              | -           | -        | 4.1   | 14.0   |      |
|  |  | BTU/h  | 38200                    | 38200    | 38200                               | -              | -           | -        | 14000 | 47800  |      |
|  | Current                                  | A  | 1.37                     | 1.34     | 1.29                                | 11.6           | 11.2        | 10.7     | -     | -      |      |
|  |  | W  | 200                      | 200      | 200                                 | 2,400k         | 2,400k      | 2,400k   | -     | -      |      |
|  | Input power                              | TOTAL W  | -                        |          |                                     | 2,600k         | 2,600k      | 2,600k   | 900   | 4,400k |      |
|  |  | COP/COP CLASS                                  | TOTAL (W/W) *5 / ("A"-G) | -        | -                                   | -              | 4.31        | 4.31 / A | 4.31  | 4.56   | 3.18 |
|  | Erp *6                                   | Pdesign at -10°C                               | kW                       | -        | -                                   | -              | -           | 10.0     | -     | -      | -    |
|  |  | Tbivalent                                      | °C                       | -        | -                                   | -              | -           | -10      | -     | -      | -    |
|  |  | SCOP   | (W/W)                    | -        | -                                   | -              | -           | 3.8      | -     | -      | -    |
|  |  | Annual consumption                             | kWh                      | -        | -                                   | -              | -           | 3684     | -     | -      | -    |
|  | Class                                    |  | -                        | -        | -                                   | -              | A           | -        | -     | -      |      |
|  | Power factor                             | %  | -                        | -        | -                                   | 94             | 94          | 93       | -     | -      |      |
|  | Noise indoor                             | dB-A (H/M/L)                                   | 38/34/31                 |          |                                     | -              |             |          | -     | -      |      |
|  |  | Power Level dB                                 | 60/56/53                 |          |                                     | -              |             |          | -     | -      |      |
| Noise outdoor  | dB-A (H/L)                               | -  |                          |          | 52/-                                |                |             | -        | -     |        |      |
|  | Power Level dB                           | -  |                          |          | 69/-                                |                |             | -        | -     |        |      |
| EXTRA LOW TEMP Total capacity(kW) / Input power(W) / COP |  | -  |                          |          |                                     |                |             |          |       |        |      |
| Max Current(A) / Max Input power(W)                      |  | 1.80/265                                       | 1.75/265                 | 1.70/265 | 25.0/5.350k                         | 25.0/5.550k    | 25.0/5.750k | -        |       |        |      |
| Starting current(A) / Comp output(W)                     |  | -  | -                        | -        | 11.6/3.0k                           | 11.2/3.0k      | 10.7/3.0k   | -        |       |        |      |
| Network Impedance(ΩMAX.)                                 |  | -  |                          |          |                                     |                |             |          |       |        |      |
| Fan motor output (Indoor/Outdoor) W                      |  | 200  |                          |          | 90×2                                |                |             | -        |       |        |      |
| Moisture removal volume                                  |  | L/h(Pt/h)                                      | 6.0 (12.6)               |          |                                     | -              |             |          | -     |        |      |
| External static pressure                                 |  | Pa   | 100 (MIN10 - MAX150)     |          |                                     | -              |             |          | -     |        |      |
| Indoor Air flow  | Cooling                                  | m³/min (ft³/min)                               | 32/26/21 (1130/918/742)  |          |                                     | -              |             |          | -     |        |      |
|  | Heating                                  | m³/min (ft³/min)                               | 32/26/21 (1130/918/742)  |          |                                     | -              |             |          | -     |        |      |
| Outdoor Air flow   | Cooling                                  | m³/min (ft³/min)                               | -                        |          |                                     | 110 (3885)     |             | -        |       |        |      |
|  | Heating                                  | m³/min (ft³/min)                               | -                        |          |                                     | 95 (3355)      |             | -        |       |        |      |
| Refrigerant type / amount g(oz)                          |  | -  |                          |          | R410A                               | 3.40k          | (119.9)     | -        |       |        |      |
| Product dimension  | Height                                   | mm(inch)                                       | 290 (11-13/32)           |          |                                     | 1416 (55-3/4)  |             |          | -     |        |      |
|  | Width                                    | mm(inch)                                       | 1400 (55-1/8)            |          |                                     | 940 (37-1/32)  |             |          | -     |        |      |
|  | Depth                                    | mm(inch)                                       | 700 (27-9/16)            |          |                                     | 340 (13-13/32) |             |          | -     |        |      |
| Packing dimension  | Height                                   | mm(inch)                                       | 355                      |          |                                     | 1556           |             |          | -     |        |      |
|  | Width                                    | mm(inch)                                       | 1614                     |          |                                     | 1055           |             |          | -     |        |      |
|  | Depth                                    | mm(inch)                                       | 850                      |          |                                     | 485            |             |          | -     |        |      |
| Weight   | (NET)                                    | kg(lb)   | 45 (99)                  |          |                                     | 98 (216)       |             |          | -     |        |      |
|  | (GROSS)                                  | kg(lb)   | 54 (119)                 |          |                                     | 108 (238)      |             |          | -     |        |      |
| Layers limit (actually)                                  |  | 9 (10)   |                          |          | 1 (2)                               |                |             | -        |       |        |      |
| Operation condition                                      | Cool (DBT)                               | 18°C ~ 32°C                                    |                          |          | -15°C ~ 46°C                        |                |             | -        |       |        |      |
|  | Heat (DBT)                               | 16°C ~ 30°C                                    |                          |          | -20°C ~ 24°C                        |                |             | -        |       |        |      |
| P I P I N G  | Pipe diameter mm (inch)                  | (Liquid)ø9.52(3/8) (Gas)ø15.88(5/8)            |                          |          | (Liquid)ø9.52(3/8) (Gas)ø15.88(5/8) |                |             | -        |       |        |      |
|  | Connecting method, Standard length m(ft) | flared type, 5.0(16.4)                         |                          |          | flared type, 5.0(16.4)              |                |             | -        |       |        |      |
| Pipe length range m (ft)                                 |  | 5 ~ 75 (16.4 ~ 246.1)                          |                          |          | -                                   |                |             | -        |       |        |      |
| Indoor unit & Outdoor unit height difference m (ft)      |  | 15 (OD located lower) / 30 (OD located higher) |                          |          | (49.2/98.4)                         |                |             | -        |       |        |      |
| Add gas amount g/m (oz/ft)                               |  | 50 (0.538)                                     |                          |          | -                                   |                |             | -        |       |        |      |
| Pipe length for additional gas m (ft)                    |  | 30 (98.4)                                      |                          |          | -                                   |                |             | -        |       |        |      |

\*1: In case it is necessary to indicate the air flow volume in (l/s), the value in (m³/min.) shall be multiplied by 16.7 and rounded down the decimal point.  
 \*2: If the EUROVENT Certified models can be operated under the "extra-low" temperature condition, -7°C dry bulb and -8°C wet-bulb temperatures with rated voltage 230 V shall be used.  
 \*3: Network Impedance shall be applicable for EUROPE and CHINA models.  
 \*4: The annual consumption is calculated by multiplying the input power at 230 V (400 V) by an average of 500 hours per year in cooling mode.  
 \*5: EER and COP classification is at 230 V (400 V) only in accordance with EU directive 2002/31/EC.  
 \*6: SEER and SCOP classification is at 230V(400V) only in accordance with EN-14825. For heating, SCOP indicates the value of only Average heating season, Other fiche data indicates in an attached sheet.

# Single -Type

## 1-1. Unit Specifications

**PE1**

### 4. Low Silhouette Ducted Type S-125PF1E5A / U-125PE1E5A

| INDOOR   |  | MODEL                                  | S-125PF1E5A                                    |          |             | -                                   |             |          | -     |        |      |
|--|--|--|--|----------|-------------|-------------------------------------|-------------|----------|-------|--------|------|
| OUTDOOR  |  | MODEL                                  | -  |          |             | U-125PE1E5A                         |             |          | -     |        |      |
| Branch pipe  |  | MODEL                                  | -  |          |             | -                                   |             |          | -     |        |      |
| Performance test condition                               |  | ISO13253 / EN14511 / EN12102 / EN14825 |  |          |             |                                     |             |          |       |        |      |
| Power supply   |  | Ø, Hz                                  | 1ø 50Hz  |          |             | 1ø 50Hz                             |             |          |       |        |      |
|  |  | V                                      | 220  | 230      | 240         | 220                                 | 230         | 240      | Min   | Max    |      |
| C<br>O<br>O<br>L<br>I<br>N<br>G                          | Capacity                                 | kW                                     | 12.5   | 12.5     | 12.5        | -                                   | -           | -        | 3.3   | 14.0   |      |
|  |  | BTU/h                                  | 42700  | 42700    | 42700       | -                                   | -           | -        | 11300 | 47800  |      |
|  | Current                                  | A                                      | 1.48   | 1.44     | 1.39        | 16.6                                | 15.9        | 15.3     | -     | -      |      |
|  |  | W                                      | 215  | 215      | 215         | 3.355k                              | 3.355k      | 3.355k   | -     | -      |      |
|  | Input power                              | TOTAL W                                | -  |          |             | 3.570k                              | 3.570k      | 3.570k   | 840   | 4.600k |      |
|  |  | Annual consumption                     | TOTAL kWh *4                                   | -        |             |                                     | -           | 1785     | -     | -      | -    |
|  | EER/EER CLASS                            |  | TOTAL (W/W) *5 / ("A"-°G)                      | -        | -           | -                                   | 3.50        | 3.50 / A | 3.50  | 3.93   | 3.04 |
|  | Erp *6                                   | Pdesign                                | kW   | -        | -           | -                                   | -           | 12.5     | -     | -      | -    |
|  |  | η <sub>s.c</sub>                       | %  | -        | -           | -                                   | -           | 219.6    | -     | -      | -    |
|  |  | Annual consumption                     | kWh  | -        | -           | -                                   | -           | -        | -     | -      | -    |
| Class  |  |  | -  | -        | -           | -                                   | -           | -        | -     | -      |      |
| Power factor   |  | %                                      | -  | -        | -           | 92                                  | 92          | 91       | -     | -      |      |
| Noise indoor   | dB-A (H/M/L)                             | 39/35/32                               |  |          | -           |                                     |             | -        | -     | -      |      |
|  | Power Level dB                           | 61/57/54                               |  |          | -           |                                     |             | -        | -     | -      |      |
| Noise outdoor  | dB-A (H/L)                               | -                                      |  |          | 53/-        |                                     |             | -        | -     | -      |      |
|  | Power Level dB                           | -                                      |  |          | 70/-        |                                     |             | -        | -     | -      |      |
| H<br>E<br>A<br>T<br>I<br>N<br>G                          | Capacity                                 | kW                                     | 14.0   | 14.0     | 14.0        | -                                   | -           | -        | 4.1   | 16.0   |      |
|  |  | BTU/h                                  | 47800  | 47800    | 47800       | -                                   | -           | -        | 14000 | 54600  |      |
|  | Current                                  | A                                      | 1.46   | 1.42     | 1.38        | 16.3                                | 15.8        | 15.1     | -     | -      |      |
|  |  | W                                      | 210  | 210      | 210         | 3.270k                              | 3.270k      | 3.270k   | -     | -      |      |
|  | Input power                              | TOTAL W                                | -  |          |             | 3.480k                              | 3.480k      | 3.480k   | 900   | 5.200k |      |
|  |  | COP/COP CLASS                          | TOTAL (W/W) *7 / ("A"-°G)                      | -        | -           | -                                   | 4.02        | 4.02 / A | 4.02  | 4.56   | 3.08 |
|  | Erp *6                                   | Pdesign at -10°C                       | kW   | -        | -           | -                                   | -           | 12.5     | -     | -      | -    |
|  |  | Tbivalent                              | °C   | -        | -           | -                                   | -           | -9       | -     | -      | -    |
|  |  | η <sub>s.h</sub>                       | %  | -        | -           | -                                   | -           | 145.9    | -     | -      | -    |
|  |  | Annual consumption                     | kWh  | -        | -           | -                                   | -           | -        | -     | -      | -    |
| Power factor   |  | %                                      | -  | -        | -           | 91                                  | 90          | 90       | -     | -      |      |
| Noise indoor   | dB-A (H/M/L)                             | 39/35/32                               |  |          | -           |                                     |             | -        | -     | -      |      |
|  | Power Level dB                           | 61/57/54                               |  |          | -           |                                     |             | -        | -     | -      |      |
| Noise outdoor  | dB-A (H/L)                               | -                                      |  |          | 53/-        |                                     |             | -        | -     | -      |      |
|  | Power Level dB                           | -                                      |  |          | 70/-        |                                     |             | -        | -     | -      |      |
| EXTRA LOW TEMP Total capacity(kW) / Input power(W) / COP |  | -                                      |  |          |             |                                     |             |          |       |        |      |
| Max Current(A) / Max Input power(W)                      |  | 1.80/265                               | 1.75/265                                       | 1.70/265 | 28.0/6.000k | 28.0/6.200k                         | 28.0/6.400k | -        |       |        |      |
| Starting current(A) / Comp output(W)                     |  | -                                      | -  | -        | 16.6/3.0k   | 15.9/3.0k                           | 15.3/3.0k   | -        |       |        |      |
| Network Impedance(ΩMAX.)                                 |  | -                                      |  |          |             |                                     |             |          |       |        |      |
| Fan motor output (Indoor/Outdoor) W                      |  | 200                                    |  |          | 90×2        |                                     |             | -        |       |        |      |
| Moisture removal volume                                  |  | L/h(Pt/h)                              | 7.9  | (16.6)   |             | -                                   |             |          | -     |        |      |
| External static pressure                                 |  | Pa                                     | 100 (MIN10 - MAX150)                           |          |             | -                                   |             |          | -     |        |      |
| Indoor Air flow  | Cooling                                  | m³/min (ft³/min)                       | 34/29/23 (1201/1024/812)                       |          |             | -                                   |             |          | -     |        |      |
|  | Heating                                  | m³/min (ft³/min)                       | 34/29/23 (1201/1024/812)                       |          |             | -                                   |             |          | -     |        |      |
| Outdoor Air flow   | Cooling                                  | m³/min (ft³/min)                       | -  |          |             | 130                                 | (4591)      | -        |       |        |      |
|  | Heating                                  | m³/min (ft³/min)                       | -  |          |             | 110                                 | (3885)      | -        |       |        |      |
| Refrigerant type / amount g(oz)                          |  |  | -  |          |             | R410A                               | 3.40k       | (119.9)  | -     |        |      |
| Product dimension  | Height                                   | mm(inch)                               | 290 (11-13/32)                                 |          |             | 1416 (55-3/4)                       |             |          | -     |        |      |
|  | Width                                    | mm(inch)                               | 1400 (55-1/8)                                  |          |             | 940 (37-1/32)                       |             |          | -     |        |      |
|  | Depth                                    | mm(inch)                               | 700 (27-9/16)                                  |          |             | 340 (13-13/32)                      |             |          | -     |        |      |
| Packing dimension  | Height                                   | mm(inch)                               | 355  |          |             | 1556                                |             |          | -     |        |      |
|  | Width                                    | mm(inch)                               | 1614   |          |             | 1055                                |             |          | -     |        |      |
|  | Depth                                    | mm(inch)                               | 850  |          |             | 485                                 |             |          | -     |        |      |
| Weight   | (NET)                                    | kg(lb)                                 | 45 (99)  |          |             | 98 (216)                            |             |          | -     |        |      |
|  | (GROSS)                                  | kg(lb)                                 | 54 (119)                                       |          |             | 108 (238)                           |             |          | -     |        |      |
| Layers limit (actually)                                  |  |  | 9 (10)   |          |             | 1 (2)                               |             |          | -     |        |      |
| Operation condition                                      | Cool (DBT)                               |  | 18°C ~ 32°C                                    |          |             | -15°C ~ 46°C                        |             |          | -     |        |      |
|  | Heat (DBT)                               |  | 16°C ~ 30°C                                    |          |             | -20°C ~ 24°C                        |             |          | -     |        |      |
| P<br>I<br>P<br>E<br>I<br>N<br>G                          | Pipe diameter mm (inch)                  |  | (Liquid)ø9.52(3/8) (Gas)ø15.88(5/8)            |          |             | (Liquid)ø9.52(3/8) (Gas)ø15.88(5/8) |             |          | -     |        |      |
|  | Connecting method, Standard length m(ft) |  | flared type, 5.0(16.4)                         |          |             | flared type, 5.0(16.4)              |             |          | -     |        |      |
| Pipe length range  |  | m (ft)                                 | 5 ~ 75 (16.4 ~ 246.1)                          |          |             | -                                   |             |          | -     |        |      |
| Indoor unit & Outdoor unit height difference             |  | m (ft)                                 | 15 (OD located lower) / 30 (OD located higher) |          |             | (49.2/98.4)                         |             |          | -     |        |      |
| Add gas amount   |  | g/m (oz/ft)                            | 50   |          |             | (0.538)                             |             |          | -     |        |      |
| Pipe length for additional gas                           |  | m (ft)                                 | 30   |          |             | (98.4)                              |             |          | -     |        |      |

\*1: In case it is necessary to indicate the air flow volume in (l/s), the value in (m³/min.) shall be multiplied by 16.7 and rounded down the decimal point.

\*2: If the EUROVENT Certified models can be operated under the "extra-low" temperature condition, -7°C dry bulb and -8°C wet-bulb temperatures with rated voltage 230 V shall be used.

\*3: Network Impedance shall be applicable for EUROPE and CHINA models.

\*4: The annual consumption is calculated by multiplying the input power at 230 V (400 V) by an average of 500 hours per year in cooling mode.

\*5: EER and COP classification is at 230 V (400 V) only in accordance with EU directive 2002/31/EC.

\*6: SEER and SCOP classification is at 230V(400V) only in accordance with EN-14825. For heating, SCOP indicates the value of only Average heating season.



# Single -Type

## 1-1. Unit Specifications

PE1

### 4. Low Silhouette Ducted Type S-140PF1E5A / U-140PE1E5A

| INDOOR   |  | MODEL                                  | S-140PF1E5A                                    |          |                | -                                   |             |          | -     |        |      |
|--|--|--|--|----------|----------------|-------------------------------------|-------------|----------|-------|--------|------|
| OUTDOOR  |  | MODEL                                  | -  |          |                | U-140PE1E5A                         |             |          | -     |        |      |
| Branch pipe  |  | MODEL                                  | -  |          |                | -                                   |             |          | -     |        |      |
| Performance test condition                               |  | ISO13253 / EN14511 / EN12102 / EN14825 |  |          |                |                                     |             |          |       |        |      |
| Power supply   |  | Ø, Hz                                  | 1ø 50Hz  |          |                | 1ø 50Hz                             |             |          | Min   | Max    |      |
|  |  | V                                      | 220  | 230      | 240            | 220                                 | 230         | 240      |       |        |      |
| C<br>O<br>O<br>L<br>I<br>N<br>G                          | Capacity                                 | kW                                     | 14.0   | 14.0     | 14.0           | -                                   | -           | -        | 3.3   | 15.5   |      |
|  |  | BTU/h                                  | 47800  | 47800    | 47800          | -                                   | -           | -        | 11300 | 52900  |      |
|  | Current                                  | A                                      | 1.55   | 1.50     | 1.47           | 20.1                                | 19.3        | 18.6     | -     | -      |      |
|  |  | W                                      | 225  | 225      | 225            | 4.085k                              | 4.085k      | 4.085k   | -     | -      |      |
|  | Input power                              | TOTAL W                                | -  |          |                | 4.310k                              | 4.310k      | 4.310k   | 840   | 6.000k |      |
|  |  | Annual consumption                     | TOTAL kWh *4                                   | -        |                |                                     | -           | 2155     | -     | -      | -    |
|  | EER/EER CLASS                            |  | TOTAL (W/W) *5 / ("A"-*G)                      | -        | -              | -                                   | 3.25        | 3.25 / A | 3.25  | 3.93   | 2.58 |
|  | Erp *6                                   | Pdesign                                | kW   | -        | -              | -                                   | -           | 14.0     | -     | -      | -    |
|  |  | η s.c                                  | %  | -        | -              | -                                   | -           | 213.4    | -     | -      | -    |
|  |  | Annual consumption                     | kWh  | -        | -              | -                                   | -           | -        | -     | -      | -    |
|  |  | Class                                  |  | -        | -              | -                                   | -           | -        | -     | -      | -    |
|  | Power factor                             |  | %  | -        | -              | -                                   | 93          | 92       | 92    | -      | -    |
| Noise indoor   | dB-A (H/M/L)                             | 40/36/33                               |  |          | -              |                                     |             | -        | -     |        |      |
|  | Power Level dB                           | 62/58/55                               |  |          | -              |                                     |             | -        | -     |        |      |
| Noise outdoor  | dB-A (H/L)                               | -                                      |  |          | 54/-           |                                     |             | -        | -     |        |      |
|  | Power Level dB                           | -                                      |  |          | 71/-           |                                     |             | -        | -     |        |      |
| H<br>E<br>A<br>T<br>I<br>N<br>G                          | Capacity                                 | kW                                     | 16.0   | 16.0     | 16.0           | -                                   | -           | -        | 4.1   | 18.0   |      |
|  |  | BTU/h                                  | 54600  | 54600    | 54600          | -                                   | -           | -        | 14000 | 61400  |      |
|  | Current                                  | A                                      | 1.55   | 1.50     | 1.46           | 19.9                                | 19.1        | 18.4     | -     | -      |      |
|  |  | W                                      | 225  | 225      | 225            | 4.215k                              | 4.215k      | 4.215k   | -     | -      |      |
|  | Input power                              | TOTAL W                                | -  |          |                | 4.440k                              | 4.440k      | 4.440k   | 900   | 5.900k |      |
|  |  | COP/COP CLASS                          | TOTAL (W/W) *5 / ("A"-*G)                      | -        | -              | -                                   | 3.60        | 3.60 / A | 3.60  | 4.56   | 3.05 |
|  | Erp *6                                   | Pdesign at -10°C                       | kW   | -        | -              | -                                   | -           | 14.0     | -     | -      | -    |
|  |  | Tbivalent                              | °C   | -        | -              | -                                   | -           | -7       | -     | -      | -    |
|  |  | η s.h                                  | %  | -        | -              | -                                   | -           | 142.3    | -     | -      | -    |
|  |  | Annual consumption                     | kWh  | -        | -              | -                                   | -           | -        | -     | -      | -    |
|  | Power factor                             |  | %  | -        | -              | -                                   | 96          | 96       | 95    | -      | -    |
|  | Noise indoor                             | dB-A (H/M/L)                           | 40/36/33                                       |          |                | -                                   |             |          | -     | -      |      |
| Power Level dB   |  | 62/58/55                               |  |          | -              |                                     |             | -        | -     |        |      |
| Noise outdoor  | dB-A (H/L)                               | -                                      |  |          | 55/-           |                                     |             | -        | -     |        |      |
|  | Power Level dB                           | -                                      |  |          | 71/-           |                                     |             | -        | -     |        |      |
| EXTRA LOW TEMP Total capacity(kW) / Input power(W) / COP |  | -                                      |  |          |                |                                     |             |          |       |        |      |
| Max Current(A) / Max Input power(W)                      |  | 1.91/285                               | 1.86/285                                       | 1.81/285 | 30.0/6.450k    | 30.0/6.650k                         | 30.0/6.850k | -        |       |        |      |
| Starting current(A) / Comp output(W)                     |  | -                                      | -  | -        | 20.1/3.0k      | 19.3/3.0k                           | 18.6/3.0k   | -        |       |        |      |
| Network Impedance(ΩMAX.)                                 |  | -                                      |  |          |                |                                     |             |          |       |        |      |
| Fan motor output (Indoor/Outdoor) W                      |  | 200                                    |  |          | 90×2           |                                     |             | -        |       |        |      |
| Moisture removal volume                                  |  | L/h(Pt/h)                              | 9.0  | (18.9)   |                | -                                   |             |          | -     |        |      |
| External static pressure                                 |  | Pa                                     | 100 (MIN10 - MAX150)                           |          |                | -                                   |             |          | -     |        |      |
| Indoor Air flow  | Cooling                                  | m³/min (ft³/min)                       | 36/32/25 (1271/1130/883)                       |          |                | -                                   |             |          | -     |        |      |
|  | Heating                                  | m³/min (ft³/min)                       | 36/32/25 (1271/1130/883)                       |          |                | -                                   |             |          | -     |        |      |
| Outdoor Air flow   | Cooling                                  | m³/min (ft³/min)                       | -  |          |                | 135                                 | (4767)      | -        |       |        |      |
|  | Heating                                  | m³/min (ft³/min)                       | -  |          |                | 120                                 | (4238)      | -        |       |        |      |
| Refrigerant type / amount g(oz)                          |  | -                                      |  |          | R410A          | 3.40k                               | (119.9)     | -        |       |        |      |
| Product dimension  | Height                                   | mm(inch)                               | 290 (11-13/32)                                 |          |                | 1416 (55-3/4)                       |             |          | -     |        |      |
|  | Width                                    | mm(inch)                               | 1400 (55-1/8)                                  |          |                | 940 (37-1/32)                       |             |          | -     |        |      |
|  | Depth                                    | mm(inch)                               | 700 (27-9/16)                                  |          |                | 340 (13-13/32)                      |             |          | -     |        |      |
| Packing dimension  | Height                                   | mm(inch)                               | 355  |          |                | 1556                                |             |          | -     |        |      |
|  | Width                                    | mm(inch)                               | 1614   |          |                | 1055                                |             |          | -     |        |      |
|  | Depth                                    | mm(inch)                               | 850  |          |                | 485                                 |             |          | -     |        |      |
| Weight   | (NET)                                    | kg(lb)                                 | 45 (99)  |          |                | 98 (216)                            |             |          | -     |        |      |
|  | (GROSS)                                  | kg(lb)                                 | 54 (119)                                       |          |                | 108 (238)                           |             |          | -     |        |      |
| Layers limit (actually)                                  |  | 9 (10)                                 |  |          | 1 (2)          |                                     |             | -        |       |        |      |
| Operation condition                                      | Cool (DBT)                               | 18°C ~ 32°C                            |  |          | -15°C ~ 46°C   |                                     |             | -        |       |        |      |
|  | Heat (DBT)                               | 16°C ~ 30°C                            |  |          | -20°C ~ 24°C   |                                     |             | -        |       |        |      |
| P<br>I<br>P<br>I<br>N<br>G                               | Pipe diameter mm (inch)                  |  | (Liquid)ø9.52(3/8) (Gas)ø15.88(5/8)            |          |                | (Liquid)ø9.52(3/8) (Gas)ø15.88(5/8) |             |          | -     |        |      |
|  | Connecting method, Standard length m(ft) |  | flared type, 5.0(16.4)                         |          |                | flared type, 5.0(16.4)              |             |          | -     |        |      |
| Pipe length range  |  | m (ft)                                 | 5 ~ 75   |          | (16.4 ~ 246.1) |                                     | -           |          |       |        |      |
| Indoor unit & Outdoor unit height difference             |  | m (ft)                                 | 15 (OD located lower) / 30 (OD located higher) |          |                | (49.2/98.4)                         |             |          | -     |        |      |
| Add gas amount   |  | g/m (oz/ft)                            | 50   |          |                | (0.538)                             |             |          | -     |        |      |
| Pipe length for additional gas                           |  | m (ft)                                 | 30   |          |                | (98.4)                              |             |          | -     |        |      |

\*1: In case it is necessary to indicate the air flow volume in (l/s), the value in (m³/min.) shall be multiplied by 16.7 and rounded down the decimal point.  
 \*2: If the EUROVENT Certified models can be operated under the "extra-low" temperature condition, -7°C dry bulb and -8°C wet-bulb temperatures with rated voltage 230 V shall be used.  
 \*3: Network Impedance shall be applicable for EUROPE and CHINA models.  
 \*4: The annual consumption is calculated by multiplying the input power at 230 V (400 V) by an average of 500 hours per year in cooling mode.  
 \*5: EER and COP classification is at 230 V (400 V) only in accordance with EU directive 2002/31/EC.  
 \*6: SEER and SCOP classification is at 230V(400V) only in accordance with EN-14825. For heating, SCOP indicates the value of only Average heating season.

# Simultaneous (Twin) -Type

## 1-1. Unit Specifications

**PE1**

### 4. Low Silhouette Ducted Type S-36PF1E5A×2 / U-71PE1E8A

| INDOOR   |  | MODEL  | S-36PF1E5A×2               |              |                                     | -              |            |          | -     |        |      |
|--|--|--|----------------------------|--------------|-------------------------------------|----------------|------------|----------|-------|--------|------|
| OUTDOOR  |  | MODEL  | -                          |              |                                     | U-71PE1E8A     |            |          | -     |        |      |
| Branch pipe  |  | MODEL  | CZ-P155BK1                 |              |                                     |                |            |          |       |        |      |
| Performance test condition                               |  | ISO13253 / EN14511 / EN14825 / EN12102         |                            |              |                                     |                |            |          |       |        |      |
| Power supply   |  | ∅, Hz  | 1∅ 50Hz                    |              |                                     | 3∅ 50Hz        |            |          |       |        |      |
|  |  | V  | 220                        | 230          | 240                                 | 380            | 400        | 415      | Min   | Max    |      |
| C<br>O<br>O<br>L<br>I<br>N<br>G                          | Capacity                                 | kW   | 7.10                       | 7.10         | 7.10                                | -              | -          | -        | 3.2   | 8.0    |      |
|  |  | BTU/h  | 24200                      | 24200        | 24200                               | -              | -          | -        | 10900 | 27300  |      |
|  | Current                                  | A  | 0.60×2                     | 0.57×2       | 0.56×2                              | 2.75           | 2.65       | 2.60     | -     | -      |      |
|  |  | W  | 70×2                       | 70×2         | 70×2                                | 1.730k         | 1.730k     | 1.730k   | -     | -      |      |
|  | Input power                              | TOTAL W  | -                          |              |                                     | 1.870k         | 1.870k     | 1.870k   | 640   | 2.650k |      |
|  |  | Annual consumption                             | TOTAL kWh *4               | -            |                                     |                | -          | 935      | -     | -      | -    |
|  | EER/EER CLASS                            | TOTAL (W/W) *5 / ("A"-*G)                      | -                          | -            | -                                   | 3.80           | 3.80 / A   | 3.80     | 5.00  | 3.02   |      |
|  | Erp *6                                   | Pdesign  | kW                         | -            | -                                   | -              | -          | 7.1      | -     | -      | -    |
|  |  | SEER   | (W/W)                      | -            | -                                   | -              | -          | 5.8      | -     | -      | -    |
|  |  | Annual consumption                             | kWh                        | -            | -                                   | -              | -          | 428      | -     | -      | -    |
|  |  | Class  |                            | -            | -                                   | -              | -          | A+       | -     | -      | -    |
|  | Power factor                             | %  | -                          | -            | -                                   | 96             | 94         | 93       | -     | -      |      |
|  | Noise indoor                             | dB-A (H/M/L)                                   | 33/29/25                   |              |                                     | -              | -          | -        | -     | -      |      |
|  |  | Power Level dB                                 | 55/51/47                   |              |                                     | -              | -          | -        | -     | -      |      |
| Noise outdoor  | dB-A (H/L)                               | -  |                            |              | -                                   | 48/-           | -          | -        | -     |        |      |
|  | Power Level dB                           | -  |                            |              | -                                   | 65/-           | -          | -        | -     |        |      |
| H<br>E<br>A<br>T<br>I<br>N<br>G                          | Capacity                                 | kW   | 8.0                        | 8.0          | 8.0                                 | -              | -          | -        | 2.8   | 9.0    |      |
|  |  | BTU/h  | 27300                      | 27300        | 27300                               | -              | -          | -        | 9600  | 30700  |      |
|  | Current                                  | A  | 0.60×2                     | 0.57×2       | 0.56×2                              | 3.10           | 3.00       | 2.90     | -     | -      |      |
|  |  | W  | 70×2                       | 70×2         | 70×2                                | 1.960k         | 1.960k     | 1.960k   | -     | -      |      |
|  | Input power                              | TOTAL W  | -                          |              |                                     | 2.100k         | 2.100k     | 2.100k   | 580   | 2.900k |      |
|  |  | COP/COP CLASS                                  | TOTAL (W/W) *5 / ("A"-*G)  | -            | -                                   | -              | 3.81       | 3.81 / A | 3.81  | 4.83   | 3.10 |
|  | Erp *6                                   | Pdesign at -10°C                               | kW                         | -            | -                                   | -              | -          | 7.1      | -     | -      | -    |
|  |  | Tbivalent                                      | °C                         | -            | -                                   | -              | -          | -9       | -     | -      | -    |
|  |  | SCOP   | (W/W)                      | -            | -                                   | -              | -          | 3.9      | -     | -      | -    |
|  |  | Annual consumption                             | kWh                        | -            | -                                   | -              | -          | 2548     | -     | -      | -    |
|  | Class                                    |  | -                          | -            | -                                   | -              | A          | -        | -     | -      |      |
|  | Power factor                             | %  | -                          | -            | -                                   | 96             | 94         | 94       | -     | -      |      |
|  | Noise indoor                             | dB-A (H/M/L)                                   | 33/29/25                   |              |                                     | -              | -          | -        | -     | -      |      |
|  |  | Power Level dB                                 | 55/51/47                   |              |                                     | -              | -          | -        | -     | -      |      |
| Noise outdoor  | dB-A (H/L)                               | -  |                            |              | -                                   | 50/-           | -          | -        | -     |        |      |
|  | Power Level dB                           | -  |                            |              | -                                   | 67/-           | -          | -        | -     |        |      |
| EXTRA LOW TEMP Total capacity(kW) / Input power(W) / COP |  | -  |                            |              |                                     |                |            |          |       |        |      |
| Max Current(A) / Max Input power(W)                      |  | 0.86×2/105×2                                   | 0.82×2/105×2               | 0.79×2/105×2 | 7.0/4.150k                          | 7.0/4.360k     | 7.0/4.530k | -        |       |        |      |
| Starting current(A) / Comp output(W)                     |  | -  | -                          | -            | 3.10/2.0k                           | 3.00/2.0k      | 2.90/2.0k  | -        |       |        |      |
| Network Impedance(ΩMAX.)                                 |  | -  |                            |              |                                     |                |            |          |       |        |      |
| Fan motor output (Indoor/Outdoor) W                      |  | 120  |                            |              | 90                                  |                |            | -        |       |        |      |
| Moisture removal volume                                  |  | L/h(Pt/h)                                      | 4.2                        | (2.1×2)      | (8.8)                               | -              |            |          | -     |        |      |
| External static pressure                                 |  | Pa   | 70 (MIN10 - MAX150)        |              |                                     | -              |            |          | -     |        |      |
| Indoor Air flow  | Cooling                                  | m³/min (ft³/min)                               | [14/13/10 (494/459/353)]×2 |              |                                     | -              |            |          | -     |        |      |
|  | Heating                                  | m³/min (ft³/min)                               | [14/13/10 (494/459/353)]×2 |              |                                     | -              |            |          | -     |        |      |
| Outdoor Air flow   | Cooling                                  | m³/min (ft³/min)                               | -                          |              |                                     | 60             | (2119)     | -        |       |        |      |
|  | Heating                                  | m³/min (ft³/min)                               | -                          |              |                                     | 60             | (2119)     | -        |       |        |      |
| Refrigerant type / amount g(oz)                          |  | -  |                            |              | R410A                               | 2.35k          | (82.9)     | -        |       |        |      |
| Product dimension  | Height                                   | mm(inch)                                       | 290 (11-13/32)             |              |                                     | 996 (39-7/32)  |            |          | -     |        |      |
|  | Width                                    | mm(inch)                                       | 800 (31-1/2)               |              |                                     | 940 (37-1/32)  |            |          | -     |        |      |
|  | Depth                                    | mm(inch)                                       | 700 (27-9/16)              |              |                                     | 340 (13-13/32) |            |          | -     |        |      |
| Packing dimension  | Height                                   | mm(inch)                                       | 355                        |              |                                     | 1136           |            |          | -     |        |      |
|  | Width                                    | mm(inch)                                       | 1014                       |              |                                     | 1055           |            |          | -     |        |      |
|  | Depth                                    | mm(inch)                                       | 850                        |              |                                     | 485            |            |          | -     |        |      |
| Weight   | (NET)                                    | kg(lb)   | 28 (62)                    |              |                                     | 71 (157)       |            |          | -     |        |      |
|  | (GROSS)                                  | kg(lb)   | 35 (78)                    |              |                                     | 79 (174)       |            |          | -     |        |      |
| Layers limit (actually)                                  |  | 9 (10)   |                            |              | 2 (3)                               |                |            | -        |       |        |      |
| Operation condition                                      | Cool (DBT)                               | 18°C ~ 32°C                                    |                            |              | -15°C ~ 46°C                        |                |            | -        |       |        |      |
|  | Heat (DBT)                               | 16°C ~ 30°C                                    |                            |              | -20°C ~ 24°C                        |                |            | -        |       |        |      |
| P<br>I<br>P<br>I<br>N<br>G                               | Pipe diameter mm (inch)                  | (Liquid)∅6.35(1/4) (Gas)∅12.7(1/2)             |                            |              | (Liquid)∅9.52(3/8) (Gas)∅15.88(5/8) |                |            | -        |       |        |      |
|  | Connecting method, Standard length m(ft) | flared type, 5.0(16.4)                         |                            |              | flared type, 5.0(16.4)              |                |            | -        |       |        |      |
| Pipe length range m (ft)                                 |  | 5 ~ 50 (16.4 ~ 164.0)                          |                            |              | -                                   |                |            | -        |       |        |      |
| Indoor unit & Outdoor unit height difference m (ft)      |  | 15 (OD located lower) / 30 (OD located higher) |                            |              | (49.2/98.4)                         |                |            | -        |       |        |      |
| Add gas amount g/m (oz/ft)                               |  | 50   |                            |              | (0.538)                             |                |            | -        |       |        |      |
| Pipe length for additional gas m (ft)                    |  | 30   |                            |              | (98.4)                              |                |            | -        |       |        |      |

\*1: In case it is necessary to indicate the air flow volume in (l/s), the value in (m³/min.) shall be multiplied by 16.7 and rounded down the decimal point.

\*2: If the EUROVENT Certified models can be operated under the "extra-low" temperature condition, -7°C dry bulb and -8°C wet-bulb temperatures with rated voltage 230 V shall be used.

\*3: Network Impedance shall be applicable for EUROPE and CHINA models.

\*4: The annual consumption is calculated by multiplying the input power at 230 V (400 V) by an average of 500 hours per year in cooling mode.

\*5: EER and COP classification is at 230 V (400 V) only in accordance with EU directive 2002/31/EC.

\*6: SEER and SCOP classification is at 230V(400V) only in accordance with EN-14825. For heating, SCOP indicates the value of only Average heating season, Other fiche data indicates in an attached sheet.

# Simultaneous (Triple) -Type

## 1-1. Unit Specifications

PE1

### 4. Low Silhouette Ducted Type S-36PF1E5A×3 / U-100PE1E8A

| INDOOR   |  | MODEL                                  | S-36PF1E5A×3                       |  |              | -                                   |            |          | -     |        |      |
|--|--|--|------------------------------------|--|--------------|-------------------------------------|------------|----------|-------|--------|------|
| OUTDOOR  |  | MODEL                                  | -                                  |  |              | U-100PE1E8A                         |            |          | -     |        |      |
| Branch pipe  |  | MODEL                                  | CZ-P3HPC2                          |  |              |                                     |            |          |       |        |      |
| Performance test condition                               |  | ISO13253 / EN14511 / EN14825 / EN12102 |                                    |  |              |                                     |            |          |       |        |      |
| Power supply   |  | ∅, Hz                                  | 1∅ 50Hz                            |  |              | 3∅ 50Hz                             |            |          |       |        |      |
|  |  | V                                      | 220                                | 230  | 240          | 380                                 | 400        | 415      | Min   | Max    |      |
| C<br>O<br>O<br>L<br>I<br>N<br>G                          | Capacity                                 | kW                                     | 10.0                               | 10.0   | 10.0         | -                                   | -          | -        | 3.3   | 12.5   |      |
|  |  | BTU/h                                  | 34100                              | 34100  | 34100        | -                                   | -          | -        | 11300 | 42700  |      |
|  | Current                                  | A                                      | 0.6×3                              | 0.57×3   | 0.56×3       | 3.68                                | 3.53       | 3.43     | -     | -      |      |
|  |  | W                                      | 70×3                               | 70×3   | 70×3         | 2.245k                              | 2.245k     | 2.245k   | -     | -      |      |
|  | Input power                              | TOTAL W                                | -                                  |  |              | 2.455k                              | 2.455k     | 2.455k   | 840   | 3.700k |      |
|  |  | Annual consumption                     | TOTAL kWh *4                       | -  |              |                                     | -          | 1227.5   | -     | -      | -    |
|  | EER/EER CLASS                            |  | TOTAL (W/W) *5 / ("A"-*G)          | -  | -            | -                                   | 4.07       | 4.07 / A | 4.07  | 3.93   | 3.38 |
|  | Erp<br>*6                                | Pdesign                                | kW                                 | -  | -            | -                                   | -          | 10.0     | -     | -      | -    |
|  |  | SEER                                   | (W/W)                              | -  | -            | -                                   | -          | 5.7      | -     | -      | -    |
|  |  | Annual consumption                     | kWh                                | -  | -            | -                                   | -          | 614      | -     | -      | -    |
| Class  |  |  | -                                  | -  | -            | -                                   | A+         | -        | -     | -      |      |
| Power factor   |  | %                                      | -                                  | -  | -            | 93                                  | 92         | 91       | -     | -      |      |
| Noise indoor   | dB-A (H/M/L)                             | 33/29/25                               |                                    |  | -            | -                                   | -          | -        | -     |        |      |
|  | Power Level dB                           | 55/51/47                               |                                    |  | -            | -                                   | -          | -        | -     |        |      |
| Noise outdoor  | dB-A (H/L)                               | -                                      |                                    |  | -            | 52/-                                |            | -        | -     |        |      |
|  | Power Level dB                           | -                                      |                                    |  | -            | 69/-                                |            | -        | -     |        |      |
| H<br>E<br>A<br>T<br>I<br>N<br>G                          | Capacity                                 | kW                                     | 11.2                               | 11.2   | 11.2         | -                                   | -          | -        | 4.1   | 14.0   |      |
|  |  | BTU/h                                  | 38200                              | 38200  | 38200        | -                                   | -          | -        | 14000 | 47800  |      |
|  | Current                                  | A                                      | 0.6×3                              | 0.57×3   | 0.56×3       | 3.86                                | 3.70       | 3.58     | -     | -      |      |
|  |  | W                                      | 70×3                               | 70×3   | 70×3         | 2.400k                              | 2.400k     | 2.400k   | -     | -      |      |
|  | Input power                              | TOTAL W                                | -                                  |  |              | 2.610k                              | 2.610k     | 2.610k   | 900   | 4.400k |      |
|  |  | COP/COP CLASS                          | TOTAL (W/W) *5 / ("A"-*G)          | -  | -            | -                                   | 4.29       | 4.29 / A | 4.29  | 4.56   | 3.18 |
|  | Erp<br>*6                                | Pdesign at -10°C                       | kW                                 | -  | -            | -                                   | -          | 10.0     | -     | -      | -    |
|  |  | Tbivalent                              | °C                                 | -  | -            | -                                   | -          | -10      | -     | -      | -    |
|  |  | SCOP                                   | (W/W)                              | -  | -            | -                                   | -          | 3.8      | -     | -      | -    |
|  |  | Annual consumption                     | kWh                                | -  | -            | -                                   | -          | 3684     | -     | -      | -    |
| Power factor   |  | %                                      | -                                  | -  | -            | 94                                  | 94         | 93       | -     | -      |      |
| Noise indoor   | dB-A (H/M/L)                             | 33/29/25                               |                                    |  | -            | -                                   | -          | -        | -     |        |      |
|  | Power Level dB                           | 55/51/47                               |                                    |  | -            | -                                   | -          | -        | -     |        |      |
| Noise outdoor  | dB-A (H/L)                               | -                                      |                                    |  | -            | 52/-                                |            | -        | -     |        |      |
|  | Power Level dB                           | -                                      |                                    |  | -            | 69/-                                |            | -        | -     |        |      |
| EXTRA LOW TEMP Total capacity(kW) / Input power(W) / COP |  | -                                      |                                    |  |              |                                     |            |          |       |        |      |
| Max Current(A) / Max Input power(W)                      |  | 0.86×3/105×3                           | 0.82×3/105×3                       | 0.79×3/105×3                                   | 9.0/5.550k   | 9.0/5.850k                          | 9.0/6.100k | -        |       |        |      |
| Starting current(A) / Comp output(W)                     |  | -                                      | -                                  | -  | 3.86/3.0k    | 3.70/3.0k                           | 3.58/3.0k  | -        |       |        |      |
| Network Impedance(ΩMAX.)                                 |  | -                                      |                                    |  |              |                                     |            |          |       |        |      |
| Fan motor output (Indoor/Outdoor) W                      |  | 120                                    |                                    |  | 90x2         |                                     |            | -        |       |        |      |
| Moisture removal volume                                  |  | L/h(Pt/h)                              | 6.0                                | (2.0×3)  | (12.6)       | -                                   |            |          | -     |        |      |
| External static pressure                                 |  | Pa                                     | 70 (MIN10 - MAX150)                |  |              | -                                   |            |          | -     |        |      |
| Indoor Air flow  | Cooling                                  | m³/min (ft³/min)                       | [14/13/10 (494/459/353)]×3         |  |              | -                                   |            |          | -     |        |      |
|  | Heating                                  | m³/min (ft³/min)                       | [14/13/10 (494/459/353)]×3         |  |              | -                                   |            |          | -     |        |      |
| Outdoor Air flow   | Cooling                                  | m³/min (ft³/min)                       | -                                  |  |              | 110                                 | (3885)     | -        |       |        |      |
|  | Heating                                  | m³/min (ft³/min)                       | -                                  |  |              | 95                                  | (3355)     | -        |       |        |      |
| Refrigerant type / amount g(oz)                          |  | -                                      |                                    |  | R410A        | 3.40k                               | (119.9)    | -        |       |        |      |
| Product dimension  | Height                                   | mm(inch)                               | 290 (11-13/32)                     |  |              | 1416 (55-3/4)                       |            |          | -     |        |      |
|  | Width                                    | mm(inch)                               | 800 (31-1/2)                       |  |              | 940 (37-1/32)                       |            |          | -     |        |      |
|  | Depth                                    | mm(inch)                               | 700 (27-9/16)                      |  |              | 340 (13-13/32)                      |            |          | -     |        |      |
| Packing dimension  | Height                                   | mm(inch)                               | 355                                |  |              | 1556                                |            |          | -     |        |      |
|  | Width                                    | mm(inch)                               | 1014                               |  |              | 1055                                |            |          | -     |        |      |
|  | Depth                                    | mm(inch)                               | 850                                |  |              | 485                                 |            |          | -     |        |      |
| Weight   | (NET)                                    | kg(lb)                                 | 28 (62)                            |  |              | 98 (216)                            |            |          | -     |        |      |
|  | (GROSS)                                  | kg(lb)                                 | 35 (78)                            |  |              | 108 (238)                           |            |          | -     |        |      |
| Layers limit (actually)                                  |  | 9 (10)                                 |                                    |  | 1 (2)        |                                     |            | -        |       |        |      |
| Operation condition                                      | Cool (DBT)                               | 18°C ~ 32°C                            |                                    |  | -15°C ~ 46°C |                                     |            | -        |       |        |      |
|  | Heat (DBT)                               | 16°C ~ 30°C                            |                                    |  | -20°C ~ 24°C |                                     |            | -        |       |        |      |
| P<br>I<br>P<br>I<br>N<br>G                               | Pipe diameter mm (inch)                  |  | (Liquid)∅6.35(1/4) (Gas)∅12.7(1/2) |  |              | (Liquid)∅9.52(3/8) (Gas)∅15.88(5/8) |            |          | -     |        |      |
|  | Connecting method, Standard length m(ft) |  | flared type, 5.0(16.4)             |  |              | flared type, 5.0(16.4)              |            |          | -     |        |      |
| Pipe length range  |  | m (ft)                                 |                                    | 5 ~ 75 (16.4 ~ 246.1)                          |              | -                                   |            |          |       |        |      |
| Indoor unit & Outdoor unit height difference             |  | m (ft)                                 |                                    | 15 (OD located lower) / 30 (OD located higher) |              | (49.2/98.4)                         |            | -        |       |        |      |
| Add gas amount   |  | g/m (oz/ft)                            |                                    | 50 (0.538)                                     |              | -                                   |            |          |       |        |      |
| Pipe length for additional gas                           |  | m (ft)                                 |                                    | 20 (65.6)                                      |              | -                                   |            |          |       |        |      |

\*1: In case it is necessary to indicate the air flow volume in (l/s), the value in (m³/min.) shall be multiplied by 16.7 and rounded down the decimal point.  
 \*2: If the EUROVENT Certified models can be operated under the "extra-low" temperature condition, -7°C dry bulb and -8°C wet-bulb temperatures with rated voltage 230 V shall be used.  
 \*3: Network Impedance shall be applicable for EUROPE and CHINA models.  
 \*4: The annual consumption is calculated by multiplying the input power at 230 V (400 V) by an average of 500 hours per year in cooling mode.  
 \*5: EER and COP classification is at 230 V (400 V) only in accordance with EU directive 2002/31/EC.  
 \*6: SEER and SCOP classification is at 230V(400V) only in accordance with EN-14825. For heating, SCOP indicates the value of only Average heating season, Other fiche data indicates in an attached sheet.

# Simultaneous (Double-Twin) -Type

## 1-1. Unit Specifications

**PE1**

### 4. Low Silhouette Ducted Type S-36PF1E5A×4 / U-125PE1E8A

| INDOOR   |  | MODEL  | S-36PF1E5A×4               |              |                                     | -              |             |          | -     |        |      |
|--|--|--|----------------------------|--------------|-------------------------------------|----------------|-------------|----------|-------|--------|------|
| OUTDOOR  |  | MODEL  | -                          |              |                                     | U-125PE1E8A    |             |          | -     |        |      |
| Branch pipe  |  | MODEL  | CZ-P155BK1×3               |              |                                     |                |             |          |       | -      |      |
| Performance test condition                               |  | ISO13253 / EN14511 / EN12102 / EN14825         |                            |              |                                     |                |             |          |       |        |      |
| Power supply   |  | Ø, Hz  | 1ø 50Hz                    |              |                                     | 3ø 50Hz        |             |          |       |        |      |
|  |  | V  | 220                        | 230          | 240                                 | 380            | 400         | 415      | Min   | Max    |      |
| C<br>O<br>O<br>L<br>I<br>N<br>G                          | Capacity                                 | kW   | 12.5                       | 12.5         | 12.5                                | -              | -           | -        | 3.3   | 14.0   |      |
|  |  | BTU/h  | 42700                      | 42700        | 42700                               | -              | -           | -        | 11300 | 47800  |      |
|  | Current                                  | A  | 0.6×4                      | 0.57×4       | 0.56×4                              | 5.52           | 5.29        | 5.12     | -     | -      |      |
|  |  | W  | 70×4                       | 70×4         | 70×4                                | 3.355k         | 3.355k      | 3.355k   | -     | -      |      |
|  | Input power                              | TOTAL W  | -                          |              |                                     | 3.635k         | 3.635k      | 3.635k   | 840   | 4.600k |      |
|  |  | Annual consumption                             | TOTAL kWh *4               | -            |                                     |                | -           | 1817.5   | -     | -      | -    |
|  | EER/EER CLASS                            | TOTAL (W/W) *5 / ("A"-*G)                      | -                          | -            | -                                   | 3.44           | 3.44 / A    | 3.44     | 3.93  | 3.04   |      |
|  | Erp *6                                   | Pdesign  | kW                         | -            | -                                   | -              | -           | 12.5     | -     | -      | -    |
|  |  | η <sub>s.c</sub>                               | %                          | -            | -                                   | -              | -           | 233.4    | -     | -      | -    |
|  |  | Annual consumption                             | kWh                        | -            | -                                   | -              | -           | -        | -     | -      | -    |
|  |  | Class  |                            | -            | -                                   | -              | -           | -        | -     | -      | -    |
|  | Power factor                             | %  | -                          | -            | -                                   | 92             | 92          | 91       | -     | -      |      |
|  | Noise indoor                             | dB-A (H/M/L)                                   | 33/29/25                   |              |                                     | -              | -           | -        | -     | -      |      |
|  |  | Power Level dB                                 | 55/51/47                   |              |                                     | -              | -           | -        | -     | -      |      |
| Noise outdoor  | dB-A (H/L)                               | -  |                            |              | 53/-                                |                |             | -        | -     |        |      |
|  | Power Level dB                           | -  |                            |              | 70/-                                |                |             | -        | -     |        |      |
| H<br>E<br>A<br>T<br>I<br>N<br>G                          | Capacity                                 | kW   | 14.0                       | 14.0         | 14.0                                | -              | -           | -        | 4.1   | 16.0   |      |
|  |  | BTU/h  | 47800                      | 47800        | 47800                               | -              | -           | -        | 14000 | 54600  |      |
|  | Current                                  | A  | 0.6×4                      | 0.57×4       | 0.56×4                              | 5.44           | 5.26        | 5.05     | -     | -      |      |
|  |  | W  | 70×4                       | 70×4         | 70×4                                | 3.270k         | 3.270k      | 3.270k   | -     | -      |      |
|  | Input power                              | TOTAL W  | -                          |              |                                     | 3.550k         | 3.550k      | 3.550k   | 900   | 5.200k |      |
|  |  | COP/COP CLASS                                  | TOTAL (W/W) *5 / ("A"-*G)  | -            | -                                   | -              | 3.94        | 3.94 / A | 3.94  | 4.56   | 3.08 |
|  | Erp *6                                   | Pdesign at -10°C                               | kW                         | -            | -                                   | -              | -           | 12.5     | -     | -      | -    |
|  |  | Tbivalent                                      | °C                         | -            | -                                   | -              | -           | -9       | -     | -      | -    |
|  |  | η <sub>s.h</sub>                               | %                          | -            | -                                   | -              | -           | 146.6    | -     | -      | -    |
|  |  | Annual consumption                             | kWh                        | -            | -                                   | -              | -           | -        | -     | -      | -    |
|  | Class                                    |  | -                          | -            | -                                   | -              | -           | -        | -     | -      |      |
|  | Power factor                             | %  | -                          | -            | -                                   | 91             | 90          | 90       | -     | -      |      |
|  | Noise indoor                             | dB-A (H/M/L)                                   | 33/29/25                   |              |                                     | -              | -           | -        | -     | -      |      |
|  |  | Power Level dB                                 | 55/51/47                   |              |                                     | -              | -           | -        | -     | -      |      |
| Noise outdoor  | dB-A (H/L)                               | -  |                            |              | 53/-                                |                |             | -        | -     |        |      |
|  | Power Level dB                           | -  |                            |              | 70/-                                |                |             | -        | -     |        |      |
| EXTRA LOW TEMP Total capacity(kW) / Input power(W) / COP |  | -  |                            |              |                                     |                |             |          |       |        |      |
| Max Current(A) / Max Input power(W)                      |  | 0.86×4/105×4                                   | 0.82×4/105×4               | 0.79×4/105×4 | 10.0/6.200k                         | 10.0/6.500k    | 10.0/6.750k | -        |       |        |      |
| Starting current(A) / Comp output(W)                     |  | -  | -                          | -            | 5.52/3.0k                           | 5.29/3.0k      | 5.12/3.0k   | -        |       |        |      |
| Network Impedance(ΩMAX.)                                 |  | -  |                            |              |                                     |                |             |          |       |        |      |
| Fan motor output (Indoor/Outdoor) W                      |  | 120  |                            |              | 90x2                                |                |             | -        |       |        |      |
| Moisture removal volume                                  |  | L/h(Pt/h)                                      | 7.9                        | (1.98×4)     | (16.6)                              | -              |             |          | -     |        |      |
| External static pressure                                 |  | Pa   | 70 (MIN10 - MAX150)        |              |                                     | -              |             |          | -     |        |      |
| Indoor Air flow  | Cooling                                  | m³/min (ft³/min)                               | [14/13/10 (494/459/353)]×4 |              |                                     | -              |             |          | -     |        |      |
|  | Heating                                  | m³/min (ft³/min)                               | [14/13/10 (494/459/353)]×4 |              |                                     | -              |             |          | -     |        |      |
| Outdoor Air flow   | Cooling                                  | m³/min (ft³/min)                               | -                          |              |                                     | 130            | (4591)      | -        |       |        |      |
|  | Heating                                  | m³/min (ft³/min)                               | -                          |              |                                     | 110            | (3885)      | -        |       |        |      |
| Refrigerant type / amount g(oz)                          |  | -  |                            |              | R410A                               | 3.40k          | (119.9)     | -        |       |        |      |
| Product dimension  | Height                                   | mm(inch)                                       | 290 (11-13/32)             |              |                                     | 1416 (55-3/4)  |             |          | -     |        |      |
|  | Width                                    | mm(inch)                                       | 800 (31-1/2)               |              |                                     | 940 (37-1/32)  |             |          | -     |        |      |
|  | Depth                                    | mm(inch)                                       | 700 (27-9/16)              |              |                                     | 340 (13-13/32) |             |          | -     |        |      |
| Packing dimension  | Height                                   | mm(inch)                                       | 355                        |              |                                     | 1556           |             |          | -     |        |      |
|  | Width                                    | mm(inch)                                       | 1014                       |              |                                     | 1055           |             |          | -     |        |      |
|  | Depth                                    | mm(inch)                                       | 850                        |              |                                     | 485            |             |          | -     |        |      |
| Weight   | (NET)                                    | kg(lb)   | 28 (62)                    |              |                                     | 98 (216)       |             |          | -     |        |      |
|  | (GROSS)                                  | kg(lb)   | 35 (78)                    |              |                                     | 108 (238)      |             |          | -     |        |      |
| Layers limit (actually)                                  |  | 9 (10)   |                            |              | 1 (2)                               |                |             | -        |       |        |      |
| Operation condition                                      | Cool (DBT)                               | 18°C ~ 32°C                                    |                            |              | -15°C ~ 46°C                        |                |             | -        |       |        |      |
|  | Heat (DBT)                               | 16°C ~ 30°C                                    |                            |              | -20°C ~ 24°C                        |                |             | -        |       |        |      |
| P<br>I<br>P<br>I<br>N<br>G                               | Pipe diameter mm (inch)                  | (Liquid)ø6.35(1/4) (Gas)ø12.7(1/2)             |                            |              | (Liquid)ø9.52(3/8) (Gas)ø15.88(5/8) |                |             | -        |       |        |      |
|  | Connecting method, Standard length m(ft) | flared type, 5.0(16.4)                         |                            |              | flared type, 5.0(16.4)              |                |             | -        |       |        |      |
| Pipe length range m (ft)                                 |  | 5 ~ 75 (16.4 ~ 246.1)                          |                            |              | -                                   |                |             | -        |       |        |      |
| Indoor unit & Outdoor unit height difference m (ft)      |  | 15 (OD located lower) / 30 (OD located higher) |                            |              | (49.2/98.4)                         |                |             | -        |       |        |      |
| Add gas amount g/m (oz/ft)                               |  | 50   |                            |              | (0.538)                             |                |             | -        |       |        |      |
| Pipe length for additional gas m (ft)                    |  | 20   |                            |              | (65.6)                              |                |             | -        |       |        |      |

\*1: In case it is necessary to indicate the air flow volume in (l/s), the value in (m³/min.) shall be multiplied by 16.7 and rounded down the decimal point.

\*2: If the EUROVENT Certified models can be operated under the "extra-low" temperature condition, -7°C dry bulb and -8°C wet-bulb temperatures with rated voltage 230 V shall be used.

\*3: Network Impedance shall be applicable for EUROPE and CHINA models.

\*4: The annual consumption is calculated by multiplying the input power at 230 V (400 V) by an average of 500 hours per year in cooling mode.

\*5: EER and COP classification is at 230 V (400 V) only in accordance with EU directive 2002/31/EC.

\*6: SEER and SCOP classification is at 230V(400V) only in accordance with EN-14825. For heating, SCOP indicates the value of only Average heating season.

# Simultaneous (Triple) -Type

## 1-1. Unit Specifications

**PE1**

### 4. Low Silhouette Ducted Type S-45PF1E5A×3 / U-125PE1E8A

| INDOOR   |  | MODEL                                  | S-45PF1E5A×3               |  |                                     | -              |             |          | -     |        |      |
|--|--|--|----------------------------|--|-------------------------------------|----------------|-------------|----------|-------|--------|------|
| OUTDOOR  |  | MODEL                                  | -                          |  |                                     | U-125PE1E8A    |             |          | -     |        |      |
| Branch pipe  |  | MODEL                                  | CZ-P3HPC2                  |  |                                     |                |             |          |       |        |      |
| Performance test condition                               |  | ISO13253 / EN14511 / EN12102 / EN14825 |                            |  |                                     |                |             |          |       |        |      |
| Power supply   |  | Ø, Hz                                  | 1ø 50Hz                    |  |                                     | 3ø 50Hz        |             |          |       |        |      |
|  |  | V                                      | 220                        | 230  | 240                                 | 380            | 400         | 415      | Min   | Max    |      |
| C<br>O<br>O<br>L<br>I<br>N<br>G                          | Capacity                                 | kW                                     | 12.5                       | 12.5   | 12.5                                | -              | -           | -        | 3.3   | 14.0   |      |
|  |  | BTU/h                                  | 42700                      | 42700  | 42700                               | -              | -           | -        | 11300 | 47800  |      |
|  | Current                                  | A                                      | 0.60×3                     | 0.57×3   | 0.56×3                              | 5.52           | 5.29        | 5.12     | -     | -      |      |
|  |  | W                                      | 70×3                       | 70×3   | 70×3                                | 3.360k         | 3.360k      | 3.360k   | -     | -      |      |
|  | Input power                              | TOTAL W                                | -                          |  |                                     | 3.570k         | 3.570k      | 3.570k   | 840   | 4.600k |      |
|  |  | Annual consumption                     | TOTAL kWh *4               | -  |                                     |                | -           | 1785     | -     | -      | -    |
|  | EER/EER CLASS                            | TOTAL (W/W) *5 / ("A"-*G)              | -                          | -  | -                                   | 3.50           | 3.50 / A    | 3.50     | 3.93  | 3.04   |      |
|  | Erp *6                                   | Pdesign                                | kW                         | -  | -                                   | -              | -           | 12.5     | -     | -      | -    |
|  |  | η <sub>s.c</sub>                       | %                          | -  | -                                   | -              | -           | 233.4    | -     | -      | -    |
|  |  | Annual consumption                     | kWh                        | -  | -                                   | -              | -           | -        | -     | -      | -    |
|  |  | Class                                  |                            | -  | -                                   | -              | -           | -        | -     | -      | -    |
|  | Power factor                             | %                                      | -                          | -  | -                                   | 92             | 92          | 91       | -     | -      |      |
|  | Noise indoor                             | dB-A (H/M/L)                           | 34/30/26                   |  |                                     | -              | -           | -        | -     | -      |      |
|  |  | Power Level dB                         | 56/52/48                   |  |                                     | -              | -           | -        | -     | -      |      |
| Noise outdoor  | dB-A (H/L)                               | -                                      |                            |  | 53/-                                |                |             | -        | -     |        |      |
|  | Power Level dB                           | -                                      |                            |  | 70/-                                |                |             | -        | -     |        |      |
| H<br>E<br>A<br>T<br>I<br>N<br>G                          | Capacity                                 | kW                                     | 14.0                       | 14.0   | 14.0                                | -              | -           | -        | 4.1   | 16.0   |      |
|  |  | BTU/h                                  | 47800                      | 47800  | 47800                               | -              | -           | -        | 14000 | 54600  |      |
|  | Current                                  | A                                      | 0.60×3                     | 0.57×3   | 0.56×3                              | 5.44           | 5.26        | 5.05     | -     | -      |      |
|  |  | W                                      | 70×3                       | 70×3   | 70×3                                | 3.270k         | 3.270k      | 3.270k   | -     | -      |      |
|  | Input power                              | TOTAL W                                | -                          |  |                                     | 3.480k         | 3.480k      | 3.480k   | 900   | 5.200k |      |
|  |  | COP/COP CLASS                          | TOTAL (W/W) *5 / ("A"-*G)  | -  | -                                   | -              | 4.02        | 4.02 / A | 4.02  | 4.56   | 3.08 |
|  | Erp *6                                   | Pdesign at -10°C                       | kW                         | -  | -                                   | -              | -           | 12.5     | -     | -      | -    |
|  |  | Tbivalent                              | °C                         | -  | -                                   | -              | -           | -9       | -     | -      | -    |
|  |  | η <sub>s.h</sub>                       | %                          | -  | -                                   | -              | -           | 146.6    | -     | -      | -    |
|  |  | Annual consumption                     | kWh                        | -  | -                                   | -              | -           | -        | -     | -      | -    |
|  | Class                                    |  | -                          | -  | -                                   | -              | -           | -        | -     | -      |      |
|  | Power factor                             | %                                      | -                          | -  | -                                   | 91             | 90          | 90       | -     | -      |      |
|  | Noise indoor                             | dB-A (H/M/L)                           | 34/30/26                   |  |                                     | -              |             |          | -     | -      |      |
|  |  | Power Level dB                         | 56/52/48                   |  |                                     | -              |             |          | -     | -      |      |
| Noise outdoor  | dB-A (H/L)                               | -                                      |                            |  | 53/-                                |                |             | -        | -     |        |      |
|  | Power Level dB                           | -                                      |                            |  | 70/-                                |                |             | -        | -     |        |      |
| EXTRA LOW TEMP Total capacity(kW) / Input power(W) / COP |  | -                                      |                            |  |                                     |                |             |          |       |        |      |
| Max Current(A) / Max Input power(W)                      |  | 0.86×3/105×3                           | 0.82×3/105×3               | 0.79×3/105×3                                   | 10.0/6.200k                         | 10.0/6.500k    | 10.0/6.750k | -        |       |        |      |
| Starting current(A) / Comp output(W)                     |  | -                                      | -                          | -  | 5.52/3.0k                           | 5.29/3.0k      | 5.12/3.0k   | -        |       |        |      |
| Network Impedance(ΩMAX.)                                 |  | -                                      |                            |  |                                     |                |             |          |       |        |      |
| Fan motor output (Indoor/Outdoor) W                      |  | 120                                    |                            |  | 90x2                                |                |             | -        |       |        |      |
| Moisture removal volume                                  |  | L/h(Pt/h)                              | 7.9                        | (2.63×3)                                       | (16.6)                              | -              |             |          | -     |        |      |
| External static pressure                                 |  | Pa                                     | 70 (MIN10 - MAX150)        |  |                                     | -              |             |          | -     |        |      |
| Indoor Air flow  | Cooling                                  | m³/min (ft³/min)                       | [14/13/10 (494/459/353)]×3 |  |                                     | -              |             |          | -     |        |      |
|  | Heating                                  | m³/min (ft³/min)                       | [14/13/10 (494/459/353)]×3 |  |                                     | -              |             |          | -     |        |      |
| Outdoor Air flow   | Cooling                                  | m³/min (ft³/min)                       | -                          |  |                                     | 130            | (4591)      | -        |       |        |      |
|  | Heating                                  | m³/min (ft³/min)                       | -                          |  |                                     | 110            | (3885)      | -        |       |        |      |
| Refrigerant type / amount g(oz)                          |  | -                                      |                            |  | R410A                               | 3.40k          | (119.9)     | -        |       |        |      |
| Product dimension  | Height                                   | mm(inch)                               | 290 (11-13/32)             |  |                                     | 1416 (55-3/4)  |             |          | -     |        |      |
|  | Width                                    | mm(inch)                               | 800 (31-1/2)               |  |                                     | 940 (37-1/32)  |             |          | -     |        |      |
|  | Depth                                    | mm(inch)                               | 700 (27-9/16)              |  |                                     | 340 (13-13/32) |             |          | -     |        |      |
| Packing dimension  | Height                                   | mm(inch)                               | 355                        |  |                                     | 1556           |             |          | -     |        |      |
|  | Width                                    | mm(inch)                               | 1014                       |  |                                     | 1055           |             |          | -     |        |      |
|  | Depth                                    | mm(inch)                               | 850                        |  |                                     | 485            |             |          | -     |        |      |
| Weight   | (NET)                                    | kg(lb)                                 | 28 (62)                    |  |                                     | 98 (216)       |             |          | -     |        |      |
|  | (GROSS)                                  | kg(lb)                                 | 35 (78)                    |  |                                     | 108 (238)      |             |          | -     |        |      |
| Layers limit (actually)                                  |  | 9 (10)                                 |                            |  | 1 (2)                               |                |             | -        |       |        |      |
| Operation condition                                      | Cool (DBT)                               | 18°C ~ 32°C                            |                            |  | -15°C ~ 46°C                        |                |             | -        |       |        |      |
|  | Heat (DBT)                               | 16°C ~ 30°C                            |                            |  | -20°C ~ 24°C                        |                |             | -        |       |        |      |
| P<br>I<br>P<br>I<br>N<br>G                               | Pipe diameter mm (inch)                  | (Liquid)ø6.35(1/4) (Gas)ø12.7(1/2)     |                            |  | (Liquid)ø9.52(3/8) (Gas)ø15.88(5/8) |                |             | -        |       |        |      |
|  | Connecting method, Standard length m(ft) | flared type, 5.0(16.4)                 |                            |  | flared type, 5.0(16.4)              |                |             | -        |       |        |      |
| Pipe length range  |  | m (ft)                                 |                            | 5 ~ 75   | (16.4 ~ 246.1)                      |                | -           |          |       |        |      |
| Indoor unit & Outdoor unit height difference             |  | m (ft)                                 |                            | 15 (OD located lower) / 30 (OD located higher) |                                     |                | (49.2/98.4) |          |       |        |      |
| Add gas amount   |  | g/m (oz/ft)                            |                            | 50   |                                     |                | (0.538)     |          |       |        |      |
| Pipe length for additional gas                           |  | m (ft)                                 |                            | 20   |                                     |                | (65.6)      |          |       |        |      |

\*1: In case it is necessary to indicate the air flow volume in (l/s), the value in (m³/min.) shall be multiplied by 16.7 and rounded down the decimal point.

\*2: If the EUROVENT Certified models can be operated under the "extra-low" temperature condition, -7°C dry bulb and -8°C wet-bulb temperatures with rated voltage 230 V shall be used.

\*3: Network Impedance shall be applicable for EUROPE and CHINA models.

\*4: The annual consumption is calculated by multiplying the input power at 230 V (400 V) by an average of 500 hours per year in cooling mode.

\*5: EER and COP classification is at 230 V (400 V) only in accordance with EU directive 2002/31/EC.

\*6: SEER and SCOP classification is at 230V(400V) only in accordance with EN-14825. For heating, SCOP indicates the value of only Average heating season.

# Simultaneous (Twin) -Type

## 1-1. Unit Specifications

**PE1**

### 4. Low Silhouette Ducted Type S-50PF1E5A×2 / U-100PE1E8A

| INDOOR   |  | MODEL  | S-50PF1E5A×2               |              |                                     | -              |            |          | -     |        |      |
|--|--|--|----------------------------|--------------|-------------------------------------|----------------|------------|----------|-------|--------|------|
| OUTDOOR  |  | MODEL  | -                          |              |                                     | U-100PE1E8A    |            |          | -     |        |      |
| Branch pipe  |  | MODEL  | CZ-P155BK1                 |              |                                     |                |            |          |       | -      |      |
| Performance test condition                               |  | ISO13253 / EN14511 / EN14825 / EN12102         |                            |              |                                     |                |            |          |       |        |      |
| Power supply   |  | Ø, Hz  | 1ø 50Hz                    |              |                                     | 3ø 50Hz        |            |          |       |        |      |
|  |  | V  | 220                        | 230          | 240                                 | 380            | 400        | 415      | Min   | Max    |      |
| C<br>O<br>O<br>L<br>I<br>N<br>G                          | Capacity                                 | kW   | 10.0                       | 10.0         | 10.0                                | -              | -          | -        | 3.3   | 12.5   |      |
|  |  | BTU/h  | 34100                      | 34100        | 34100                               | -              | -          | -        | 11300 | 42700  |      |
|  | Current                                  | A  | 0.77×2                     | 0.74×2       | 0.71×2                              | 3.68           | 3.53       | 3.43     | -     | -      |      |
|  |  | W  | 100×2                      | 100×2        | 100×2                               | 2.245k         | 2.245k     | 2.245k   | -     | -      |      |
|  | Input power                              | TOTAL W  | -                          |              |                                     | 2.445k         | 2.445k     | 2.445k   | 840   | 3.700k |      |
|  |  | Annual consumption                             | TOTAL kWh **4              | -            |                                     |                | -          | 1222.5   | -     | -      | -    |
|  | EER/EER CLASS                            | TOTAL (W/W) **5 / ("A"-*G)                     | -                          | -            | -                                   | 4.09           | 4.09 / A   | 4.09     | 3.93  | 3.38   |      |
|  | Erp<br>*6                                | Pdesign  | kW                         | -            | -                                   | -              | -          | 10.0     | -     | -      | -    |
|  |  | SEER   | (W/W)                      | -            | -                                   | -              | -          | 5.7      | -     | -      | -    |
|  |  | Annual consumption                             | kWh                        | -            | -                                   | -              | -          | 614      | -     | -      | -    |
|  |  | Class  |                            | -            | -                                   | -              | -          | A+       | -     | -      | -    |
|  | Power factor                             | %  | -                          | -            | -                                   | 93             | 92         | 91       | -     | -      |      |
| Noise indoor   | dB-A (H/M/L)                             | 34/30/26                                       |                            |              | -                                   | -              | -          | -        | -     |        |      |
|  | Power Level dB                           | 56/52/48                                       |                            |              | -                                   | -              | -          | -        | -     |        |      |
| Noise outdoor  | dB-A (H/L)                               | -  |                            |              | -                                   | 52/-           | -          | -        | -     |        |      |
|  | Power Level dB                           | -  |                            |              | -                                   | 69/-           | -          | -        | -     |        |      |
| H<br>E<br>A<br>T<br>I<br>N<br>G                          | Capacity                                 | kW   | 11.2                       | 11.2         | 11.2                                | -              | -          | -        | 4.1   | 14.0   |      |
|  |  | BTU/h  | 38200                      | 38200        | 38200                               | -              | -          | -        | 14000 | 47800  |      |
|  | Current                                  | A  | 0.77×2                     | 0.74×2       | 0.71×2                              | 3.86           | 3.70       | 3.58     | -     | -      |      |
|  |  | W  | 100×2                      | 100×2        | 100×2                               | 2.400k         | 2.400k     | 2.400k   | -     | -      |      |
|  | Input power                              | TOTAL W  | -                          |              |                                     | 2.600k         | 2.600k     | 2.600k   | 900   | 4.400k |      |
|  |  | COP/COP CLASS                                  | TOTAL (W/W) **5 / ("A"-*G) | -            | -                                   | -              | 4.31       | 4.31 / A | 4.31  | 4.56   | 3.18 |
|  | Erp<br>*6                                | Pdesign at -10°C                               | kW                         | -            | -                                   | -              | -          | 10.0     | -     | -      | -    |
|  |  | Tbivalent                                      | °C                         | -            | -                                   | -              | -          | -10      | -     | -      | -    |
|  |  | SCOP   | (W/W)                      | -            | -                                   | -              | -          | 3.8      | -     | -      | -    |
|  |  | Annual consumption                             | kWh                        | -            | -                                   | -              | -          | 3684     | -     | -      | -    |
|  | Class                                    |  | -                          | -            | -                                   | -              | A          | -        | -     | -      |      |
|  | Power factor                             | %  | -                          | -            | -                                   | 94             | 94         | 93       | -     | -      |      |
| Noise indoor   | dB-A (H/M/L)                             | 34/30/26                                       |                            |              | -                                   | -              | -          | -        | -     |        |      |
|  | Power Level dB                           | 56/52/48                                       |                            |              | -                                   | -              | -          | -        | -     |        |      |
| Noise outdoor  | dB-A (H/L)                               | -  |                            |              | -                                   | 52/-           | -          | -        | -     |        |      |
|  | Power Level dB                           | -  |                            |              | -                                   | 69/-           | -          | -        | -     |        |      |
| EXTRA LOW TEMP Total capacity(kW) / Input power(W) / COP |  | -  |                            |              |                                     |                |            |          |       |        |      |
| Max Current(A) / Max Input power(W)                      |  | 1.00×2/125×2                                   | 0.96×2/125×2               | 0.92×2/125×2 | 9.0/5.550k                          | 9.0/5.850k     | 9.0/6.100k | -        |       |        |      |
| Starting current(A) / Comp output(W)                     |  | -  | -                          | -            | 3.86/3.0k                           | 3.70/3.0k      | 3.58/3.0k  | -        |       |        |      |
| Network Impedance(ΩMAX.)                                 |  | -  |                            |              |                                     |                |            |          |       |        |      |
| Fan motor output (Indoor/Outdoor) W                      |  | 120  |                            |              | 90×2                                |                |            | -        |       |        |      |
| Moisture removal volume                                  |  | L/h(Pt/h)                                      | 6.0                        | (3.0×2)      | (12.6)                              | -              |            |          | -     |        |      |
| External static pressure                                 |  | Pa   | 70 (MIN10 - MAX150)        |              |                                     | -              |            |          | -     |        |      |
| Indoor Air flow  | Cooling                                  | m³/min (ft³/min)                               | [16/15/12 (565/530/424)]×2 |              |                                     | -              |            |          | -     |        |      |
|  | Heating                                  | m³/min (ft³/min)                               | [16/15/12 (565/530/424)]×2 |              |                                     | -              |            |          | -     |        |      |
| Outdoor Air flow   | Cooling                                  | m³/min (ft³/min)                               | -                          |              |                                     | 110            | (3885)     | -        |       |        |      |
|  | Heating                                  | m³/min (ft³/min)                               | -                          |              |                                     | 95             | (3355)     | -        |       |        |      |
| Refrigerant type / amount g(oz)                          |  | -  |                            |              | R410A                               | 3.40k          | (119.9)    | -        |       |        |      |
| Product dimension  | Height                                   | mm(inch)                                       | 290 (11-13/32)             |              |                                     | 1416 (55-3/4)  |            |          | -     |        |      |
|  | Width                                    | mm(inch)                                       | 800 (31-1/2)               |              |                                     | 940 (37-1/32)  |            |          | -     |        |      |
|  | Depth                                    | mm(inch)                                       | 700 (27-9/16)              |              |                                     | 340 (13-13/32) |            |          | -     |        |      |
| Packing dimension  | Height                                   | mm(inch)                                       | 355                        |              |                                     | 1556           |            |          | -     |        |      |
|  | Width                                    | mm(inch)                                       | 1014                       |              |                                     | 1055           |            |          | -     |        |      |
|  | Depth                                    | mm(inch)                                       | 850                        |              |                                     | 485            |            |          | -     |        |      |
| Weight   | (NET)                                    | kg(lb)   | 28 (62)                    |              |                                     | 98 (216)       |            |          | -     |        |      |
|  | (GROSS)                                  | kg(lb)   | 35 (78)                    |              |                                     | 108 (238)      |            |          | -     |        |      |
| Layers limit (actually)                                  |  | 9 (10)   |                            |              | 1 (2)                               |                |            | -        |       |        |      |
| Operation condition                                      | Cool (DBT)                               | 18°C ~ 32°C                                    |                            |              | -15°C ~ 46°C                        |                |            | -        |       |        |      |
|  | Heat (DBT)                               | 16°C ~ 30°C                                    |                            |              | -20°C ~ 24°C                        |                |            | -        |       |        |      |
| P<br>I<br>P<br>I<br>N<br>G                               | Pipe diameter mm (inch)                  | (Liquid)ø6.35(1/4) (Gas)ø12.7(1/2)             |                            |              | (Liquid)ø9.52(3/8) (Gas)ø15.88(5/8) |                |            | -        |       |        |      |
|  | Connecting method, Standard length m(ft) | flared type, 5.0(16.4)                         |                            |              | flared type, 5.0(16.4)              |                |            | -        |       |        |      |
| Pipe length range m (ft)                                 |  | 5 ~ 75 (16.4 ~ 246.1)                          |                            |              | -                                   |                |            | -        |       |        |      |
| Indoor unit & Outdoor unit height difference m (ft)      |  | 15 (OD located lower) / 30 (OD located higher) |                            |              | (49.2/98.4)                         |                |            | -        |       |        |      |
| Add gas amount g/m (oz/ft)                               |  | 50   |                            |              | (0.538)                             |                |            | -        |       |        |      |
| Pipe length for additional gas m (ft)                    |  | 30   |                            |              | (98.4)                              |                |            | -        |       |        |      |

\*1: In case it is necessary to indicate the air flow volume in (l/s), the value in (m³/min.) shall be multiplied by 16.7 and rounded down the decimal point.

\*2: If the EUROVENT Certified models can be operated under the "extra-low" temperature condition, -7°C dry bulb and -8°C wet-bulb temperatures with rated voltage 230 V shall be used.

\*3: Network Impedance shall be applicable for EUROPE and CHINA models.

\*4: The annual consumption is calculated by multiplying the input power at 230 V (400 V) by an average of 500 hours per year in cooling mode.

\*5: EER and COP classification is at 230 V (400 V) only in accordance with EU directive 2002/31/EC.

\*6: SEER and SCOP classification is at 230V(400V) only in accordance with EN-14825. For heating, SCOP indicates the value of only Average heating season, Other fiche data indicates in an attached sheet.

# Simultaneous (Triple) -Type

## 1-1. Unit Specifications

**PE1**

### 4. Low Silhouette Ducted Type S-50PF1E5A×3 / U-140PE1E8A

| INDOOR   |  | MODEL                                      | S-50PF1E5A×3                        |  |              | -                                   |             |          | -     |        |      |
|--|--|--|-------------------------------------|--|--------------|-------------------------------------|-------------|----------|-------|--------|------|
| OUTDOOR  |  | MODEL                                      | -                                   |  |              | U-140PE1E8A                         |             |          | -     |        |      |
| Branch pipe  |  | MODEL                                      | CZ-P3HPC2                           |  |              |                                     |             |          |       |        |      |
| Performance test condition                               |  | ISO13253 / EN14511 / EN12102 / EN14825     |                                     |  |              |                                     |             |          |       |        |      |
| Power supply   |  | Ø, Hz                                      | 1ø 50Hz                             |  |              | 3ø 50Hz                             |             |          |       |        |      |
|  |  | V  | 220                                 | 230  | 240          | 380                                 | 400         | 415      | Min   | Max    |      |
| C<br>O<br>O<br>L<br>I<br>N<br>G                          | Capacity                                 | kW   | 14.0                                | 14.0   | 14.0         | -                                   | -           | -        | 3.3   | 15.5   |      |
|  |  | BTU/h                                      | 47800                               | 47800  | 47800        | -                                   | -           | -        | 11300 | 52900  |      |
|  | Current                                  | A  | 0.77×3                              | 0.74×3   | 0.71×3       | 6.69                                | 6.42        | 6.18     | -     | -      |      |
|  |  | W  | 100×3                               | 100×3  | 100×3        | 4.085k                              | 4.085k      | 4.085k   | -     | -      |      |
|  | Input power                              | TOTAL W                                    | -                                   |  |              | 4.385k                              | 4.385k      | 4.385k   | 840   | 6.000k |      |
|  |  | Annual consumption                         | TOTAL kWh **                        | -  |              |                                     | -           | 2192.5   | -     | -      | -    |
|  | EER/EER CLASS                            |  | TOTAL (W/W) <sup>1)</sup> / ("A"-G) | -  | -            | -                                   | 3.19        | 3.19 / B | 3.19  | 3.93   | 2.58 |
|  | Erp <sub>*6</sub>                        | Pdesign                                    | kW                                  | -  | -            | -                                   | -           | 14.0     | -     | -      | -    |
|  |  | η <sub>s.c</sub>                           | %                                   | -  | -            | -                                   | -           | 225.7    | -     | -      | -    |
|  |  | Annual consumption                         | kWh                                 | -  | -            | -                                   | -           | -        | -     | -      | -    |
|  |  | Class                                      |                                     | -  | -            | -                                   | -           | -        | -     | -      | -    |
|  | Power factor                             |  | %                                   | -  | -            | -                                   | 93          | 92       | 92    | -      | -    |
|  | Noise indoor                             | dB-A (H/M/L)                               | 34/30/26                            |  |              | -                                   | -           | -        | -     | -      |      |
|  |  | Power Level dB                             | 56/52/48                            |  |              | -                                   | -           | -        | -     | -      |      |
| Noise outdoor  | dB-A (H/L)                               | -  |                                     |  | -            | -                                   | 54/-        | -        | -     |        |      |
|  | Power Level dB                           | -  |                                     |  | -            | -                                   | 71/-        | -        | -     |        |      |
| H<br>E<br>A<br>T<br>I<br>N<br>G                          | Capacity                                 | kW   | 16.0                                | 16.0   | 16.0         | -                                   | -           | -        | 4.1   | 18.0   |      |
|  |  | BTU/h                                      | 54600                               | 54600  | 54600        | -                                   | -           | -        | 14000 | 61400  |      |
|  | Current                                  | A  | 0.77×3                              | 0.74×3   | 0.71×3       | 6.64                                | 6.35        | 6.15     | -     | -      |      |
|  |  | W  | 100×3                               | 100×3  | 100×3        | 4.215k                              | 4.215k      | 4.215k   | -     | -      |      |
|  | Input power                              | TOTAL W                                    | -                                   |  |              | 4.515k                              | 4.515k      | 4.515k   | 900   | 5.900k |      |
|  |  | COP/COP CLASS                              | TOTAL (W/W) <sup>2)</sup> / ("A"-G) | -  | -            | -                                   | 3.54        | 3.54 / B | 3.54  | 4.56   | 3.05 |
|  | Erp <sub>*6</sub>                        | Pdesign at -10°C                           | kW                                  | -  | -            | -                                   | -           | 14.0     | -     | -      | -    |
|  |  | Tbivalent                                  | °C                                  | -  | -            | -                                   | -           | -7       | -     | -      | -    |
|  |  | η <sub>s.h</sub>                           | %                                   | -  | -            | -                                   | -           | 143.0    | -     | -      | -    |
|  |  | Annual consumption                         | kWh                                 | -  | -            | -                                   | -           | -        | -     | -      | -    |
|  | Power factor                             |  | %                                   | -  | -            | -                                   | 96          | 96       | 95    | -      | -    |
|  | Noise indoor                             | dB-A (H/M/L)                               | 34/30/26                            |  |              | -                                   | -           | -        | -     | -      |      |
|  |  | Power Level dB                             | 56/52/48                            |  |              | -                                   | -           | -        | -     | -      |      |
|  | Noise outdoor                            | dB-A (H/L)                                 | -                                   |  |              | -                                   | -           | 55/-     | -     | -      |      |
| Power Level dB   |  | -  |                                     |  | -            | -                                   | 71/-        | -        | -     |        |      |
| EXTRA LOW TEMP Total capacity(kW) / Input power(W) / COP |  | -  |                                     |  |              |                                     |             |          |       |        |      |
| Max Current(A) / Max Input power(W)                      |  | 1.00×3/125×3                               | 0.96×3/125×3                        | 0.92×3/125×3                                   | 11.0/6.800k  | 11.0/7.150k                         | 11.0/7.450k | -        |       |        |      |
| Starting current(A) / Comp output(W)                     |  | -  | -                                   | -  | 6.69/3.0k    | 6.42/3.0k                           | 6.18/3.0k   | -        |       |        |      |
| Network Impedance(ΩMAX.)                                 |  | -  |                                     |  |              |                                     |             |          |       |        |      |
| Fan motor output (Indoor/Outdoor) W                      |  | 120  |                                     |  | 90x2         |                                     |             | -        |       |        |      |
| Moisture removal volume                                  |  | L/h(Pt/h)                                  | 9.0                                 | (3.0×3)  | (18.9)       | -                                   |             |          | -     |        |      |
| External static pressure                                 |  | Pa   | 70 (MIN10 - MAX150)                 |  |              | -                                   |             |          | -     |        |      |
| Indoor Air flow  | Cooling                                  | m <sup>3</sup> /min (ft <sup>3</sup> /min) | [16/15/12 (565/530/424)]×3          |  |              | -                                   |             |          | -     |        |      |
|  | Heating                                  | m <sup>3</sup> /min (ft <sup>3</sup> /min) | [16/15/12 (565/530/424)]×3          |  |              | -                                   |             |          | -     |        |      |
| Outdoor Air flow   | Cooling                                  | m <sup>3</sup> /min (ft <sup>3</sup> /min) | -                                   |  |              | 135                                 | (4767)      | -        |       |        |      |
|  | Heating                                  | m <sup>3</sup> /min (ft <sup>3</sup> /min) | -                                   |  |              | 120                                 | (4238)      | -        |       |        |      |
| Refrigerant type / amount g(oz)                          |  | -  |                                     |  | R410A        | 3.40k                               | (119.9)     | -        |       |        |      |
| Product dimension  | Height                                   | mm(inch)                                   | 290 (11-13/32)                      |  |              | 1416 (55-3/4)                       |             |          | -     |        |      |
|  | Width                                    | mm(inch)                                   | 800 (31-1/2)                        |  |              | 940 (37-1/32)                       |             |          | -     |        |      |
|  | Depth                                    | mm(inch)                                   | 700 (27-9/16)                       |  |              | 340 (13-13/32)                      |             |          | -     |        |      |
| Packing dimension  | Height                                   | mm(inch)                                   | 355                                 |  |              | 1556                                |             |          | -     |        |      |
|  | Width                                    | mm(inch)                                   | 1014                                |  |              | 1055                                |             |          | -     |        |      |
|  | Depth                                    | mm(inch)                                   | 850                                 |  |              | 485                                 |             |          | -     |        |      |
| Weight   | (NET)                                    | kg(lb)                                     | 28 (62)                             |  |              | 98 (216)                            |             |          | -     |        |      |
|  | (GROSS)                                  | kg(lb)                                     | 35 (78)                             |  |              | 108 (238)                           |             |          | -     |        |      |
| Layers limit (actually)                                  |  | 9 (10)                                     |                                     |  | 1 (2)        |                                     |             | -        |       |        |      |
| Operation condition                                      | Cool (DBT)                               | 18°C ~ 32°C                                |                                     |  | -15°C ~ 46°C |                                     |             | -        |       |        |      |
|  | Heat (DBT)                               | 16°C ~ 30°C                                |                                     |  | -20°C ~ 24°C |                                     |             | -        |       |        |      |
| P<br>I<br>P<br>I<br>N<br>G                               | Pipe diameter mm (inch)                  |  | (Liquid)ø6.35(1/4) (Gas)ø12.7(1/2)  |  |              | (Liquid)ø9.52(3/8) (Gas)ø15.88(5/8) |             |          | -     |        |      |
|  | Connecting method, Standard length m(ft) |  | flared type, 5.0(16.4)              |  |              | flared type, 5.0(16.4)              |             |          | -     |        |      |
| Pipe length range  |  | m (ft)                                     |                                     | 5 ~ 75 (16.4 ~ 246.1)                          |              | -                                   |             |          |       |        |      |
| Indoor unit & Outdoor unit height difference             |  | m (ft)                                     |                                     | 15 (OD located lower) / 30 (OD located higher) |              | (49.2/98.4)                         |             | -        |       |        |      |
| Add gas amount   |  | g/m (oz/ft)                                |                                     | 50 (0.538)                                     |              | -                                   |             |          |       |        |      |
| Pipe length for additional gas                           |  | m (ft)                                     |                                     | 20 (65.6)                                      |              | -                                   |             |          |       |        |      |

\*1: In case it is necessary to indicate the air flow volume in (l/s), the value in (m<sup>3</sup>/min.) shall be multiplied by 16.7 and rounded down the decimal point.

\*2: If the EUROVENT Certified models can be operated under the "extra-low" temperature condition, -7°C dry bulb and -8°C wet-bulb temperatures with rated voltage 230 V shall be used.

\*3: Network Impedance shall be applicable for EUROPE and CHINA models.

\*4: The annual consumption is calculated by multiplying the input power at 230 V (400 V) by an average of 500 hours per year in cooling mode.

\*5: EER and COP classification is at 230 V (400 V) only in accordance with EU directive 2002/31/EC.

\*6: SEER and SCOP classification is at 230V(400V) only in accordance with EN-14825. For heating, SCOP indicates the value of only Average heating season.

# Simultaneous (Twin) -Type

## 1-1. Unit Specifications

**PE1**

### 4. Low Silhouette Ducted Type S-60PF1E5A×2 / U-125PE1E8A

| INDOOR   |  | MODEL                                  | S-60PF1E5A×2                        |  |              | -                                   |             |          | -     |        |      |
|--|--|--|-------------------------------------|--|--------------|-------------------------------------|-------------|----------|-------|--------|------|
| OUTDOOR  |  | MODEL                                  | -                                   |  |              | U-125PE1E8A                         |             |          | -     |        |      |
| Branch pipe  |  | MODEL                                  | CZ-P155BK1                          |  |              |                                     |             |          |       | -      |      |
| Performance test condition                               |  | ISO13253 / EN14511 / EN12102 / EN14825 |                                     |  |              |                                     |             |          |       |        |      |
| Power supply   |  | Ø, Hz                                  | 1ø 50Hz                             |  |              | 3ø 50Hz                             |             |          | Min   | Max    |      |
|  |  | V                                      | 220                                 | 230  | 240          | 380                                 | 400         | 415      | -     | -      |      |
| C<br>O<br>O<br>L<br>I<br>N<br>G                          | Capacity                                 | kW                                     | 12.5                                | 12.5   | 12.5         | -                                   | -           | -        | 3.3   | 14.0   |      |
|  |  | BTU/h                                  | 42700                               | 42700  | 42700        | -                                   | -           | -        | 11300 | 47800  |      |
|  | Current                                  | A                                      | 0.91×2                              | 0.89×2   | 0.87×2       | 5.52                                | 5.29        | 5.12     | -     | -      |      |
|  |  | W                                      | 120×2                               | 120×2  | 120×2        | 3.355k                              | 3.355k      | 3.355k   | -     | -      |      |
|  | Input power                              | TOTAL W                                | -                                   |  |              | 3.595k                              | 3.595k      | 3.595k   | 840   | 4.600k |      |
|  |  | Annual consumption                     | TOTAL kWh **4                       | -  |              |                                     | -           | 1797.5   | -     | -      | -    |
|  | EER/EER CLASS                            |  | TOTAL (W/W) **5 / ("A"-*G)          | -  | -            | -                                   | 3.48        | 3.48 / A | 3.48  | 3.93   | 3.04 |
|  | Erp<br>*6                                | Pdesign                                | kW                                  | -  | -            | -                                   | -           | 12.5     | -     | -      | -    |
|  |  | η <sub>s.c</sub>                       | %                                   | -  | -            | -                                   | -           | 233.4    | -     | -      | -    |
|  |  | Annual consumption                     | kWh                                 | -  | -            | -                                   | -           | -        | -     | -      | -    |
| Class  |  |  | -                                   | -  | -            | -                                   | -           | -        | -     | -      |      |
| Power factor   |  | %                                      | -                                   | -  | -            | 92                                  | 92          | 91       | -     | -      |      |
| Noise indoor   | dB-A (H/M/L)                             | 35/32/26                               |                                     |  | -            | -                                   | -           | -        | -     |        |      |
|  | Power Level dB                           | 57/54/48                               |                                     |  | -            | -                                   | -           | -        | -     |        |      |
| Noise outdoor  | dB-A (H/L)                               | -                                      |                                     |  | -            | 53/-                                |             | -        | -     |        |      |
|  | Power Level dB                           | -                                      |                                     |  | -            | 70/-                                |             | -        | -     |        |      |
| H<br>E<br>A<br>T<br>I<br>N<br>G                          | Capacity                                 | kW                                     | 14.0                                | 14.0   | 14.0         | -                                   | -           | -        | 4.1   | 16.0   |      |
|  |  | BTU/h                                  | 47800                               | 47800  | 47800        | -                                   | -           | -        | 14000 | 54600  |      |
|  | Current                                  | A                                      | 0.91×2                              | 0.89×2   | 0.87×2       | 5.44                                | 5.26        | 5.05     | -     | -      |      |
|  |  | W                                      | 120×2                               | 120×2  | 120×2        | 3.270k                              | 3.270k      | 3.270k   | -     | -      |      |
|  | Input power                              | TOTAL W                                | -                                   |  |              | 3.510k                              | 3.510k      | 3.510k   | 900   | 5.200k |      |
|  |  | COP/COP CLASS                          | TOTAL (W/W) **5 / ("A"-*G)          | -  | -            | -                                   | 3.99        | 3.99 / A | 3.99  | 4.56   | 3.08 |
|  | Erp<br>*6                                | Pdesign at -10°C                       | kW                                  | -  | -            | -                                   | -           | 12.5     | -     | -      | -    |
|  |  | Tbivalent                              | °C                                  | -  | -            | -                                   | -           | -9       | -     | -      | -    |
|  |  | η <sub>s.h</sub>                       | %                                   | -  | -            | -                                   | -           | 146.6    | -     | -      | -    |
|  |  | Annual consumption                     | kWh                                 | -  | -            | -                                   | -           | -        | -     | -      | -    |
| Power factor   |  | %                                      | -                                   | -  | -            | 91                                  | 90          | 90       | -     | -      |      |
| Noise indoor   | dB-A (H/M/L)                             | 35/32/26                               |                                     |  | -            | -                                   | -           | -        | -     |        |      |
|  | Power Level dB                           | 57/54/48                               |                                     |  | -            | -                                   | -           | -        | -     |        |      |
| Noise outdoor  | dB-A (H/L)                               | -                                      |                                     |  | -            | 53/-                                |             | -        | -     |        |      |
|  | Power Level dB                           | -                                      |                                     |  | -            | 70/-                                |             | -        | -     |        |      |
| EXTRA LOW TEMP Total capacity(kW) / Input power(W) / COP |  | -                                      |                                     |  |              |                                     |             |          |       |        |      |
| Max Current(A) / Max Input power(W)                      |  | 1.26×2/160×2                           | 1.20×2/160×2                        | 1.15×2/160×2                                   | 10.0/6.200k  | 10.0/6.500k                         | 10.0/6.750k | -        |       |        |      |
| Starting current(A) / Comp output(W)                     |  | -                                      | -                                   | -  | 5.52/3.0k    | 5.29/3.0k                           | 5.12/3.0k   | -        |       |        |      |
| Network Impedance(ΩMAX.)                                 |  | -                                      |                                     |  |              |                                     |             |          |       |        |      |
| Fan motor output (Indoor/Outdoor) W                      |  | 120                                    |                                     |  | 90x2         |                                     |             | -        |       |        |      |
| Moisture removal volume                                  |  | L/h(Pt/h)                              | 7.9                                 | (3.95×2)                                       | (16.6)       | -                                   |             |          | -     |        |      |
| External static pressure                                 |  | Pa                                     | 70 (MIN10 - MAX150)                 |  |              | -                                   |             |          | -     |        |      |
| Indoor Air flow  | Cooling                                  | m³/min (ft³/min)                       | [21/19/15 (742/671/530)]×2          |  |              | -                                   |             |          | -     |        |      |
|  | Heating                                  | m³/min (ft³/min)                       | [21/19/15 (742/671/530)]×2          |  |              | -                                   |             |          | -     |        |      |
| Outdoor Air flow   | Cooling                                  | m³/min (ft³/min)                       | -                                   |  |              | 130                                 | (4591)      | -        |       |        |      |
|  | Heating                                  | m³/min (ft³/min)                       | -                                   |  |              | 110                                 | (3885)      | -        |       |        |      |
| Refrigerant type / amount g(oz)                          |  | -                                      |                                     |  | R410A        | 3.40k                               | (119.9)     | -        |       |        |      |
| Product dimension  | Height                                   | mm(inch)                               | 290 (11-13/32)                      |  |              | 1416 (55-3/4)                       |             |          | -     |        |      |
|  | Width                                    | mm(inch)                               | 1000 (39-3/8)                       |  |              | 940 (37-1/32)                       |             |          | -     |        |      |
|  | Depth                                    | mm(inch)                               | 700 (27-9/16)                       |  |              | 340 (13-13/32)                      |             |          | -     |        |      |
| Packing dimension  | Height                                   | mm(inch)                               | 355                                 |  |              | 1556                                |             |          | -     |        |      |
|  | Width                                    | mm(inch)                               | 1214                                |  |              | 1055                                |             |          | -     |        |      |
|  | Depth                                    | mm(inch)                               | 850                                 |  |              | 485                                 |             |          | -     |        |      |
| Weight   | (NET)                                    | kg(lb)                                 | 33 (73)                             |  |              | 98 (216)                            |             |          | -     |        |      |
|  | (GROSS)                                  | kg(lb)                                 | 41 (91)                             |  |              | 108 (238)                           |             |          | -     |        |      |
| Layers limit (actually)                                  |  | 9 (10)                                 |                                     |  | 1 (2)        |                                     |             | -        |       |        |      |
| Operation condition                                      | Cool (DBT)                               | 18°C ~ 32°C                            |                                     |  | -15°C ~ 46°C |                                     |             | -        |       |        |      |
|  | Heat (DBT)                               | 16°C ~ 30°C                            |                                     |  | -20°C ~ 24°C |                                     |             | -        |       |        |      |
| P<br>I<br>P<br>I<br>N<br>G                               | Pipe diameter mm (inch)                  |  | (Liquid)ø9.52(3/8) (Gas)ø15.88(5/8) |  |              | (Liquid)ø9.52(3/8) (Gas)ø15.88(5/8) |             |          | -     |        |      |
|  | Connecting method, Standard length m(ft) |  | flared type, 5.0(16.4)              |  |              | flared type, 5.0(16.4)              |             |          | -     |        |      |
| Pipe length range  |  | m (ft)                                 |                                     | 5 ~ 75 (16.4 ~ 246.1)                          |              | -                                   |             |          |       |        |      |
| Indoor unit & Outdoor unit height difference             |  | m (ft)                                 |                                     | 15 (OD located lower) / 30 (OD located higher) |              | (49.2/98.4)                         |             | -        |       |        |      |
| Add gas amount   |  | g/m (oz/ft)                            |                                     | 50 (0.538)                                     |              | -                                   |             |          |       |        |      |
| Pipe length for additional gas                           |  | m (ft)                                 |                                     | 30 (98.4)                                      |              | -                                   |             |          |       |        |      |

\*1: In case it is necessary to indicate the air flow volume in (l/s), the value in (m³/min.) shall be multiplied by 16.7 and rounded down the decimal point.

\*2: If the EUROVENT Certified models can be operated under the "extra-low" temperature condition, -7°C dry bulb and -8°C wet-bulb temperatures with rated voltage 230 V shall be used.

\*3: Network Impedance shall be applicable for EUROPE and CHINA models.

\*4: The annual consumption is calculated by multiplying the input power at 230 V (400 V) by an average of 500 hours per year in cooling mode.

\*5: EER and COP classification is at 230 V (400 V) only in accordance with EU directive 2002/31/EC.

\*6: SEER and SCOP classification is at 230V(400V) only in accordance with EN-14825. For heating, SCOP indicates the value of only Average heating season.



# Single -Type

## 1-1. Unit Specifications

PE1

### 4. Low Silhouette Ducted Type S-71PF1E5A / U-71PE1E8A

| INDOOR   |  | MODEL                                  | S-71PF1E5A                                     |          |              | -                                   |            |          | -      |       |
|--|--|--|--|----------|--------------|-------------------------------------|------------|----------|--------|-------|
| OUTDOOR  |  | MODEL                                  | -  |          |              | U-71PE1E8A                          |            |          | -      |       |
| Branch pipe  |  | MODEL                                  | -  |          |              | -                                   |            |          | -      |       |
| Performance test condition                               |  | ISO13253 / EN14511 / EN14825 / EN12102 |  |          |              |                                     |            |          |        |       |
| Power supply   |  | Ø, Hz                                  | 1ø 50Hz  |          |              | 3ø 50Hz                             |            |          | Min    | Max   |
|  |  | V                                      | 220  | 230      | 240          | 380                                 | 400        | 415      |        |       |
| Capacity   | kW                                       | 7.10                                   | 7.10   | 7.10     | -            | -                                   | -          | -        | 3.2    | 8.0   |
|  | BTU/h                                    | 24200                                  | 24200  | 24200    | -            | -                                   | -          | -        | 10900  | 27300 |
| Current  | A  | 0.91                                   | 0.89   | 0.87     | 2.75         | 2.65                                | 2.60       | -        | -      | -     |
|  | W  | 120                                    | 120  | 120      | 1.730k       | 1.730k                              | 1.730k     | -        | -      | -     |
| Input power  | TOTAL W                                  | -                                      |  |          | 1.850k       | 1.850k                              | 1.850k     | 640      | 2.650k | -     |
|  | Annual consumption                       | TOTAL kWh *4                           | -  |          |              | -                                   | 925        | -        | -      | -     |
| EER/EER CLASS  |  | TOTAL (W/W) *5 ("A"-*G)                | -  | -        | -            | 3.84 / A                            | 3.84 / A   | 3.84 / A | 5.00   | 3.02  |
| Erp *6   | Pdesign                                  | kW                                     | -  | -        | -            | -                                   | 7.1        | -        | -      | -     |
|  | SEER                                     | (W/W)                                  | -  | -        | -            | -                                   | 6.0        | -        | -      | -     |
|  | Annual consumption                       | kWh                                    | -  | -        | -            | -                                   | 414        | -        | -      | -     |
|  | Class                                    | -                                      | -  | -        | -            | -                                   | A+         | -        | -      | -     |
| Power factor   |  | %                                      | -  | -        | -            | 96                                  | 94         | 93       | -      | -     |
| Noise indoor   | dB-A (H/M/L)                             | 35/32/26                               |  |          | -            |                                     |            | -        | -      | -     |
|  | Power Level dB                           | 57/54/48                               |  |          | -            |                                     |            | -        | -      | -     |
| Noise outdoor  | dB-A (H/L)                               | -                                      |  |          | 48/-         |                                     |            | -        | -      | -     |
|  | Power Level dB                           | -                                      |  |          | 65/-         |                                     |            | -        | -      | -     |
| Capacity   | kW                                       | 8.00                                   | 8.00   | 8.00     | -            | -                                   | -          | -        | 2.8    | 9.0   |
|  | BTU/h                                    | 27300                                  | 27300  | 27300    | -            | -                                   | -          | -        | 9600   | 30700 |
| Current  | A  | 0.91                                   | 0.89   | 0.87     | 3.10         | 3.00                                | 2.90       | -        | -      | -     |
|  | W  | 120                                    | 120  | 120      | 1.960k       | 1.960k                              | 1.960k     | -        | -      | -     |
| Input power  | TOTAL W                                  | -                                      |  |          | 2.080k       | 2.080k                              | 2.080k     | 580      | 2.900k | -     |
|  | COP/COP CLASS                            | TOTAL (W/W) *7 ("A"-*G)                | -  | -        | -            | 3.85 / A                            | 3.85 / A   | 3.85 / A | 4.83   | 3.10  |
| Erp *6   | Pdesign at -10°C                         | kW                                     | -  | -        | -            | -                                   | 7.1        | -        | -      | -     |
|  | Tbivalent                                | °C                                     | -  | -        | -            | -                                   | -9         | -        | -      | -     |
|  | SCOP                                     | (W/W)                                  | -  | -        | -            | -                                   | 3.9        | -        | -      | -     |
|  | Annual consumption                       | kWh                                    | -  | -        | -            | -                                   | 2548       | -        | -      | -     |
| Power factor   |  | %                                      | -  | -        | -            | 96                                  | 94         | 94       | -      | -     |
| Noise indoor   | dB-A (H/M/L)                             | 35/32/26                               |  |          | -            |                                     |            | -        | -      | -     |
|  | Power Level dB                           | 57/54/48                               |  |          | -            |                                     |            | -        | -      | -     |
| Noise outdoor  | dB-A (H/L)                               | -                                      |  |          | 50/-         |                                     |            | -        | -      | -     |
|  | Power Level dB                           | -                                      |  |          | 67/-         |                                     |            | -        | -      | -     |
| EXTRA LOW TEMP Total capacity(kW) / Input power(W) / COP |  | -                                      |  |          |              |                                     |            |          |        |       |
| Max Current(A) / Max Input power(W)                      |  | 1.26/160                               | 1.20/160                                       | 1.15/160 | 7.0/4.150k   | 7.0/4.360k                          | 7.0/4.530k | -        |        |       |
| Starting current(A) / Comp output(W)                     |  | -                                      | -  | -        | 3.10/2.0k    | 3.00/2.0k                           | 2.90/2.0k  | -        |        |       |
| Network Impedance(ΩMAX.)                                 |  | -                                      |  |          |              |                                     |            |          |        |       |
| Fan motor output (Indoor/Outdoor) W                      |  | 120                                    |  |          | 90           |                                     |            | -        |        |       |
| Moisture removal volume                                  |  | L/h(Pt/h)                              | 4.2  | (8.8)    |              | -                                   |            |          | -      |       |
| External static pressure                                 |  | Pa                                     | 70 (MIN10 - MAX150)                            |          |              | -                                   |            |          | -      |       |
| Indoor Air flow  | Cooling                                  | m³/min (ft³/min)                       | 21/19/15 (742/671/530)                         |          |              | -                                   |            |          | -      |       |
|  | Heating                                  | m³/min (ft³/min)                       | 21/19/15 (742/671/530)                         |          |              | -                                   |            |          | -      |       |
| Outdoor Air flow   | Cooling                                  | m³/min (ft³/min)                       | -  |          |              | 60                                  | (2119)     |          | -      |       |
|  | Heating                                  | m³/min (ft³/min)                       | -  |          |              | 60                                  | (2119)     |          | -      |       |
| Refrigerant type / amount g(oz)                          |  | -                                      |  |          | R410A        | 2.35k                               | (82.9)     |          | -      |       |
| Product dimension  | Height                                   | mm(inch)                               | 290 (11-13/32)                                 |          |              | 996 (39-7/32)                       |            |          | -      |       |
|  | Width                                    | mm(inch)                               | 1000 (39-3/8)                                  |          |              | 940 (37-1/32)                       |            |          | -      |       |
|  | Depth                                    | mm(inch)                               | 700 (27-9/16)                                  |          |              | 340 (13-13/32)                      |            |          | -      |       |
| Packing dimension  | Height                                   | mm(inch)                               | 355  |          |              | 1136                                |            |          | -      |       |
|  | Width                                    | mm(inch)                               | 1214   |          |              | 1055                                |            |          | -      |       |
|  | Depth                                    | mm(inch)                               | 850  |          |              | 485                                 |            |          | -      |       |
| Weight   | (NET)                                    | kg(lb)                                 | 33 (73)  |          |              | 71 (157)                            |            |          | -      |       |
|  | (GROSS)                                  | kg(lb)                                 | 41 (91)  |          |              | 79 (174)                            |            |          | -      |       |
| Layers limit (actually)                                  |  | 9 (10)                                 |  |          | 2 (3)        |                                     |            | -        |        |       |
| Operation condition                                      | Cool (DBT)                               | 18°C ~ 32°C                            |  |          | -15°C ~ 46°C |                                     |            | -        |        |       |
|  | Heat (DBT)                               | 16°C ~ 30°C                            |  |          | -20°C ~ 24°C |                                     |            | -        |        |       |
| P I P I N G  | Pipe diameter mm (inch)                  |  | (Liquid)ø9.52(3/8) (Gas)ø15.88(5/8)            |          |              | (Liquid)ø9.52(3/8) (Gas)ø15.88(5/8) |            |          | -      |       |
|  | Connecting method, Standard length m(ft) |  | flared type, 5.0(16.4)                         |          |              | flared type, 5.0(16.4)              |            |          | -      |       |
| Pipe length range  |  | m (ft)                                 | 5 ~ 50 (16.4 ~ 164.0)                          |          |              | -                                   |            |          | -      |       |
| Indoor unit & Outdoor unit height difference             |  | m (ft)                                 | 15 (OD located lower) / 30 (OD located higher) |          |              | (49.2/98.4)                         |            |          | -      |       |
| Add gas amount   |  | g/m (oz/ft)                            | 50   |          |              | (0.538)                             |            |          | -      |       |
| Pipe length for additional gas                           |  | m (ft)                                 | 30   |          |              | (98.4)                              |            |          | -      |       |

\*1: In case it is necessary to indicate the air flow volume in (l/s), the value in (m³/min.) shall be multiplied by 16.7 and rounded down the decimal point.  
 \*2: If the EUROVENT Certified models can be operated under the "extra-low" temperature condition, -7°C dry bulb and -8°C wet-bulb temperatures with rated voltage 230 V shall be used.  
 \*3: Network Impedance shall be applicable for EUROPE and CHINA models.  
 \*4: The annual consumption is calculated by multiplying the input power at 230 V (400 V) by an average of 500 hours per year in cooling mode.  
 \*5: EER and COP classification is at 230 V (400 V) only in accordance with EU directive 2002/31/EC.  
 \*6: SEER and SCOP classification is at 230V(400V) only in accordance with EN-14825. For heating, SCOP indicates the value of only Average heating season, Other fiche data indicates in an attached sheet.

# Simultaneous (Twin) -Type

## 1-1. Unit Specifications

**PE1**

### 4. Low Silhouette Ducted Type S-71PF1E5A×2 / U-140PE1E8A

| INDOOR   |  | MODEL                                  | S-71PF1E5A×2                        |  |              | -                                   |             |          | -     |        |      |
|--|--|--|-------------------------------------|--|--------------|-------------------------------------|-------------|----------|-------|--------|------|
| OUTDOOR  |  | MODEL                                  | -                                   |  |              | U-140PE1E8A                         |             |          | -     |        |      |
| Branch pipe  |  | MODEL                                  | CZ-P155BK1                          |  |              |                                     |             |          |       | -      |      |
| Performance test condition                               |  | ISO13253 / EN14511 / EN12102 / EN14825 |                                     |  |              |                                     |             |          |       |        |      |
| Power supply   |  | Ø, Hz                                  | 1ø 50Hz                             |  |              | 3ø 50Hz                             |             |          | -     |        |      |
|  |  | V                                      | 220                                 | 230  | 240          | 380                                 | 400         | 415      | Min   | Max    |      |
| C<br>O<br>O<br>L<br>I<br>N<br>G                          | Capacity                                 | kW                                     | 14.0                                | 14.0   | 14.0         | -                                   | -           | -        | 3.3   | 15.5   |      |
|  |  | BTU/h                                  | 47800                               | 47800  | 47800        | -                                   | -           | -        | 11300 | 52900  |      |
|  | Current                                  | A                                      | 0.91×2                              | 0.89×2   | 0.87×2       | 6.69                                | 6.42        | 6.18     | -     | -      |      |
|  |  | W                                      | 120×2                               | 120×2  | 120×2        | 4.085k                              | 4.085k      | 4.085k   | -     | -      |      |
|  | Input power                              | TOTAL W                                | -                                   |  |              | 4.325k                              | 4.325k      | 4.325k   | 840   | 6.000k |      |
|  |  | Annual consumption                     | TOTAL kWh **4                       | -  |              |                                     | -           | 2162.5   | -     | -      | -    |
|  | EER/EER CLASS                            |  | TOTAL (W/W) **5 / ("A"-*G)          | -  | -            | -                                   | 3.24        | 3.24 / A | 3.24  | 3.93   | 2.58 |
|  | Erp<br>*6                                | Pdesign                                | kW                                  | -  | -            | -                                   | -           | 14.0     | -     | -      | -    |
|  |  | η <sub>s.c</sub>                       | %                                   | -  | -            | -                                   | -           | 225.7    | -     | -      | -    |
|  |  | Annual consumption                     | kWh                                 | -  | -            | -                                   | -           | -        | -     | -      | -    |
|  |  | Class                                  |                                     | -  | -            | -                                   | -           | -        | -     | -      | -    |
|  | Power factor                             |  | %                                   | -  | -            | -                                   | 93          | 92       | 92    | -      | -    |
|  | Noise indoor                             | dB-A (H/M/L)                           | 35/32/26                            |  |              | -                                   | -           | -        | -     | -      |      |
|  |  | Power Level dB                         | 57/54/48                            |  |              | -                                   | -           | -        | -     | -      |      |
| Noise outdoor  | dB-A (H/L)                               | -                                      |                                     |  | 54/-         |                                     |             | -        | -     |        |      |
|  | Power Level dB                           | -                                      |                                     |  | 71/-         |                                     |             | -        | -     |        |      |
| H<br>E<br>A<br>T<br>I<br>N<br>G                          | Capacity                                 | kW                                     | 16.0                                | 16.0   | 16.0         | -                                   | -           | -        | 4.1   | 18.0   |      |
|  |  | BTU/h                                  | 54600                               | 54600  | 54600        | -                                   | -           | -        | 14000 | 61400  |      |
|  | Current                                  | A                                      | 0.91×2                              | 0.89×2   | 0.87×2       | 6.64                                | 6.35        | 6.15     | -     | -      |      |
|  |  | W                                      | 120×2                               | 120×2  | 120×2        | 4.215k                              | 4.215k      | 4.215k   | -     | -      |      |
|  | Input power                              | TOTAL W                                | -                                   |  |              | 4.455k                              | 4.455k      | 4.455k   | 900   | 5.900k |      |
|  |  | COP/COP CLASS                          | TOTAL (W/W) **7 / ("A"-*G)          | -  | -            | -                                   | 3.59        | 3.59 / A | 3.59  | 4.56   | 3.05 |
|  | Erp<br>*6                                | Pdesign at -10°C                       | kW                                  | -  | -            | -                                   | -           | 14.0     | -     | -      | -    |
|  |  | Tbivalent                              | °C                                  | -  | -            | -                                   | -           | -7       | -     | -      | -    |
|  |  | η <sub>s.h</sub>                       | %                                   | -  | -            | -                                   | -           | 143.0    | -     | -      | -    |
|  |  | Annual consumption                     | kWh                                 | -  | -            | -                                   | -           | -        | -     | -      | -    |
|  | Power factor                             |  | %                                   | -  | -            | -                                   | 96          | 96       | 95    | -      | -    |
|  | Noise indoor                             | dB-A (H/M/L)                           | 35/32/26                            |  |              | -                                   | -           | -        | -     | -      |      |
|  |  | Power Level dB                         | 57/54/48                            |  |              | -                                   | -           | -        | -     | -      |      |
|  | Noise outdoor                            | dB-A (H/L)                             | -                                   |  |              | 55/-                                |             |          | -     | -      |      |
| Power Level dB   |  | -                                      |                                     |  | 71/-         |                                     |             | -        | -     |        |      |
| EXTRA LOW TEMP Total capacity(kW) / Input power(W) / COP |  | -                                      |                                     |  |              |                                     |             |          |       |        |      |
| Max Current(A) / Max Input power(W)                      |  | 1.26×2/160×2                           | 1.20×2/160×2                        | 1.15×2/160×2                                   | 11.0/6.800k  | 11.0/7.150k                         | 11.0/7.450k | -        |       |        |      |
| Starting current(A) / Comp output(W)                     |  | -                                      | -                                   | -  | 6.69/3.0k    | 6.42/3.0k                           | 6.18/3.0k   | -        |       |        |      |
| Network Impedance(ΩMAX.)                                 |  | -                                      |                                     |  |              |                                     |             |          |       |        |      |
| Fan motor output (Indoor/Outdoor) W                      |  | 120                                    |                                     |  | 90×2         |                                     |             | -        |       |        |      |
| Moisture removal volume                                  |  | L/h(Pt/h)                              | 9.0                                 | (4.5×2)  | (18.9)       | -                                   |             |          | -     |        |      |
| External static pressure                                 |  | Pa                                     | 70 (MIN10 - MAX150)                 |  |              | -                                   |             |          | -     |        |      |
| Indoor Air flow  | Cooling                                  | m³/min (ft³/min)                       | [21/19/15 (742/671/530)]×2          |  |              | -                                   |             |          | -     |        |      |
|  | Heating                                  | m³/min (ft³/min)                       | [21/19/15 (742/671/530)]×2          |  |              | -                                   |             |          | -     |        |      |
| Outdoor Air flow   | Cooling                                  | m³/min (ft³/min)                       | -                                   |  |              | 135                                 | (4767)      | -        |       |        |      |
|  | Heating                                  | m³/min (ft³/min)                       | -                                   |  |              | 120                                 | (4238)      | -        |       |        |      |
| Refrigerant type / amount g(oz)                          |  | -                                      |                                     |  | R410A        | 3.40k                               | (119.9)     | -        |       |        |      |
| Product dimension  | Height                                   | mm(inch)                               | 290 (11-13/32)                      |  |              | 1416 (55-3/4)                       |             |          | -     |        |      |
|  | Width                                    | mm(inch)                               | 1000 (39-3/8)                       |  |              | 940 (37-1/32)                       |             |          | -     |        |      |
|  | Depth                                    | mm(inch)                               | 700 (27-9/16)                       |  |              | 340 (13-13/32)                      |             |          | -     |        |      |
| Packing dimension  | Height                                   | mm(inch)                               | 355                                 |  |              | 1556                                |             |          | -     |        |      |
|  | Width                                    | mm(inch)                               | 1214                                |  |              | 1055                                |             |          | -     |        |      |
|  | Depth                                    | mm(inch)                               | 850                                 |  |              | 485                                 |             |          | -     |        |      |
| Weight   | (NET)                                    | kg(lb)                                 | 33 (73)                             |  |              | 98 (216)                            |             |          | -     |        |      |
|  | (GROSS)                                  | kg(lb)                                 | 41 (91)                             |  |              | 108 (238)                           |             |          | -     |        |      |
| Layers limit (actually)                                  |  | 9 (10)                                 |                                     |  | 1 (2)        |                                     |             | -        |       |        |      |
| Operation condition                                      | Cool (DBT)                               | 18°C ~ 32°C                            |                                     |  | -15°C ~ 46°C |                                     |             | -        |       |        |      |
|  | Heat (DBT)                               | 16°C ~ 30°C                            |                                     |  | -20°C ~ 24°C |                                     |             | -        |       |        |      |
| P<br>I<br>P<br>I<br>N<br>G                               | Pipe diameter mm (inch)                  |  | (Liquid)ø9.52(3/8) (Gas)ø15.88(5/8) |  |              | (Liquid)ø9.52(3/8) (Gas)ø15.88(5/8) |             |          | -     |        |      |
|  | Connecting method, Standard length m(ft) |  | flared type, 5.0(16.4)              |  |              | flared type, 5.0(16.4)              |             |          | -     |        |      |
| Pipe length range  |  | m (ft)                                 |                                     | 5 ~ 75 (16.4 ~ 246.1)                          |              | -                                   |             |          |       |        |      |
| Indoor unit & Outdoor unit height difference             |  | m (ft)                                 |                                     | 15 (OD located lower) / 30 (OD located higher) |              | (49.2/98.4)                         |             | -        |       |        |      |
| Add gas amount   |  | g/m (oz/ft)                            |                                     | 50 (0.538)                                     |              | -                                   |             |          |       |        |      |
| Pipe length for additional gas                           |  | m (ft)                                 |                                     | 30 (98.4)                                      |              | -                                   |             |          |       |        |      |

\*1: In case it is necessary to indicate the air flow volume in (l/s), the value in (m³/min.) shall be multiplied by 16.7 and rounded down the decimal point.

\*2: If the EUROVENT Certified models can be operated under the "extra-low" temperature condition, -7°C dry bulb and -8°C wet-bulb temperatures with rated voltage 230 V shall be used.

\*3: Network Impedance shall be applicable for EUROPE and CHINA models.

\*4: The annual consumption is calculated by multiplying the input power at 230 V (400 V) by an average of 500 hours per year in cooling mode.

\*5: EER and COP classification is at 230 V (400 V) only in accordance with EU directive 2002/31/EC.

\*6: SEER and SCOP classification is at 230V(400V) only in accordance with EN-14825. For heating, SCOP indicates the value of only Average heating season.

# Single -Type

## 1-1. Unit Specifications

PE1

### 4. Low Silhouette Ducted Type S-100PF1E5A / U-100PE1E8A

| INDOOR   |  | MODEL  | S-100PF1E5A                         |          |              | -                                   |            |          | -     |        |      |
|--|--|--|-------------------------------------|----------|--------------|-------------------------------------|------------|----------|-------|--------|------|
| OUTDOOR  |  | MODEL  | -                                   |          |              | U-100PE1E8A                         |            |          | -     |        |      |
| Branch pipe  |  | MODEL  | -                                   |          |              | -                                   |            |          | -     |        |      |
| Performance test condition                               |  | ISO13253 / EN14511 / EN14825 / EN12102         |                                     |          |              |                                     |            |          |       |        |      |
| Power supply   |  | Ø, Hz  | 1ø 50Hz                             |          |              | 3ø 50Hz                             |            |          | Min   | Max    |      |
|  |  | V  | 220                                 | 230      | 240          | 380                                 | 400        | 415      |       |        |      |
| C<br>O<br>O<br>L<br>I<br>N<br>G                          | Capacity                                 | kW   | 10.0                                | 10.0     | 10.0         | -                                   | -          | -        | 3.3   | 12.5   |      |
|  |  | BTU/h  | 34100                               | 34100    | 34100        | -                                   | -          | -        | 11300 | 42700  |      |
|  | Current                                  | A  | 1.35                                | 1.30     | 1.27         | 3.68                                | 3.53       | 3.43     | -     | -      |      |
|  |  | W  | 195                                 | 195      | 195          | 2.245k                              | 2.245k     | 2.245k   | -     | -      |      |
|  | Input power                              | TOTAL W  | -                                   |          |              | 2.440k                              | 2.440k     | 2.440k   | 840   | 3.700k |      |
|  |  | Annual consumption                             | TOTAL kWh **4                       | -        |              |                                     | -          | 1220     | -     | -      | -    |
|  | EER/EER CLASS                            |  | TOTAL (W/W) **5 / ("A"-*G)          | -        | -            | -                                   | 4.10       | 4.10 / A | 4.10  | 3.93   | 3.38 |
|  | Erp<br>*6                                | Pdesign  | kW                                  | -        | -            | -                                   | -          | 10.0     | -     | -      | -    |
|  |  | SEER   | (W/W)                               | -        | -            | -                                   | -          | 5.7      | -     | -      | -    |
|  |  | Annual consumption                             | kWh                                 | -        | -            | -                                   | -          | 614      | -     | -      | -    |
| Class  |  |  | -                                   | -        | -            | -                                   | A+         | -        | -     | -      |      |
| Power factor   |  | %  | -                                   | -        | -            | 93                                  | 92         | 91       | -     | -      |      |
| Noise indoor   | dB-A (H/M/L)                             | 38/34/31                                       |                                     |          | -            |                                     |            | -        | -     |        |      |
|  | Power Level dB                           | 60/56/53                                       |                                     |          | -            |                                     |            | -        | -     |        |      |
| Noise outdoor  | dB-A (H/L)                               | -  |                                     |          | 52/-         |                                     |            | -        | -     |        |      |
|  | Power Level dB                           | -  |                                     |          | 69/-         |                                     |            | -        | -     |        |      |
| H<br>E<br>A<br>T<br>I<br>N<br>G                          | Capacity                                 | kW   | 11.2                                | 11.2     | 11.2         | -                                   | -          | -        | 4.1   | 14.0   |      |
|  |  | BTU/h  | 38200                               | 38200    | 38200        | -                                   | -          | -        | 14000 | 47800  |      |
|  | Current                                  | A  | 1.37                                | 1.34     | 1.29         | 3.86                                | 3.70       | 3.58     | -     | -      |      |
|  |  | W  | 200                                 | 200      | 200          | 2.400k                              | 2.400k     | 2.400k   | -     | -      |      |
|  | Input power                              | TOTAL W  | -                                   |          |              | 2.600k                              | 2.600k     | 2.600k   | 900   | 4.400k |      |
|  |  | COP/COP CLASS                                  | TOTAL (W/W) **7 / ("A"-*G)          | -        | -            | -                                   | 4.31       | 4.31 / A | 4.31  | 4.56   | 3.18 |
|  | Erp<br>*6                                | Pdesign at -10°C                               | kW                                  | -        | -            | -                                   | -          | 10.0     | -     | -      | -    |
|  |  | Tbivalent                                      | °C                                  | -        | -            | -                                   | -          | -10      | -     | -      | -    |
|  |  | SCOP   | (W/W)                               | -        | -            | -                                   | -          | 3.8      | -     | -      | -    |
|  |  | Annual consumption                             | kWh                                 | -        | -            | -                                   | -          | 3684     | -     | -      | -    |
| Power factor   |  | %  | -                                   | -        | -            | 94                                  | 94         | 93       | -     | -      |      |
| Noise indoor   | dB-A (H/M/L)                             | 38/34/31                                       |                                     |          | -            |                                     |            | -        | -     |        |      |
|  | Power Level dB                           | 60/56/53                                       |                                     |          | -            |                                     |            | -        | -     |        |      |
| Noise outdoor  | dB-A (H/L)                               | -  |                                     |          | 52/-         |                                     |            | -        | -     |        |      |
|  | Power Level dB                           | -  |                                     |          | 69/-         |                                     |            | -        | -     |        |      |
| EXTRA LOW TEMP Total capacity(kW) / Input power(W) / COP |  | (Q8.8kW/W4.200kW/COP2.10)                      |                                     |          |              |                                     |            |          |       |        |      |
| Max Current(A) / Max Input power(W)                      |  | 1.80/265                                       | 1.75/265                            | 1.70/265 | 9.0/5.550k   | 9.0/5.850k                          | 9.0/6.100k | -        |       |        |      |
| Starting current(A) / Comp output(W)                     |  | -  | -                                   | -        | 3.86/3.0k    | 3.70/3.0k                           | 3.58/3.0k  | -        |       |        |      |
| Network Impedance(ΩMAX.)                                 |  | -  |                                     |          |              |                                     |            |          |       |        |      |
| Fan motor output (Indoor/Outdoor) W                      |  | 200  |                                     |          | 90×2         |                                     |            | -        |       |        |      |
| Moisture removal volume                                  |  | L/h(Pt/h)                                      | 6.0 (12.6)                          |          |              | -                                   |            |          | -     |        |      |
| External static pressure                                 |  | Pa   | 100 (MIN10 - MAX150)                |          |              | -                                   |            |          | -     |        |      |
| Indoor Air flow  | Cooling                                  | m³/min (ft³/min)                               | 32/26/21 (1130/918/742)             |          |              | -                                   |            |          | -     |        |      |
|  | Heating                                  | m³/min (ft³/min)                               | 32/26/21 (1130/918/742)             |          |              | -                                   |            |          | -     |        |      |
| Outdoor Air flow   | Cooling                                  | m³/min (ft³/min)                               | -                                   |          |              | 110 (3885)                          |            | -        |       |        |      |
|  | Heating                                  | m³/min (ft³/min)                               | -                                   |          |              | 95 (3355)                           |            | -        |       |        |      |
| Refrigerant type / amount g(oz)                          |  | -  |                                     |          | R410A        | 3.40k                               | (119.9)    | -        |       |        |      |
| Product dimension  | Height                                   | mm(inch)                                       | 290 (11-13/32)                      |          |              | 1416 (55-3/4)                       |            |          | -     |        |      |
|  | Width                                    | mm(inch)                                       | 1400 (55-1/8)                       |          |              | 940 (37-1/32)                       |            |          | -     |        |      |
|  | Depth                                    | mm(inch)                                       | 700 (27-9/16)                       |          |              | 340 (13-13/32)                      |            |          | -     |        |      |
| Packing dimension  | Height                                   | mm(inch)                                       | 355                                 |          |              | 1556                                |            |          | -     |        |      |
|  | Width                                    | mm(inch)                                       | 1614                                |          |              | 1055                                |            |          | -     |        |      |
|  | Depth                                    | mm(inch)                                       | 850                                 |          |              | 485                                 |            |          | -     |        |      |
| Weight   | (NET)                                    | kg(lb)   | 45 (99)                             |          |              | 98 (216)                            |            |          | -     |        |      |
|  | (GROSS)                                  | kg(lb)   | 54 (119)                            |          |              | 108 (238)                           |            |          | -     |        |      |
| Layers limit (actually)                                  |  | 9 (10)   |                                     |          | 1 (2)        |                                     |            | -        |       |        |      |
| Operation condition                                      | Cool (DBT)                               | 18°C ~ 32°C                                    |                                     |          | -15°C ~ 46°C |                                     |            | -        |       |        |      |
|  | Heat (DBT)                               | 16°C ~ 30°C                                    |                                     |          | -20°C ~ 24°C |                                     |            | -        |       |        |      |
| P<br>I<br>P<br>I<br>N<br>G                               | Pipe diameter mm (inch)                  |  | (Liquid)ø9.52(3/8) (Gas)ø15.88(5/8) |          |              | (Liquid)ø9.52(3/8) (Gas)ø15.88(5/8) |            |          | -     |        |      |
|  | Connecting method, Standard length m(ft) |  | flared type, 5.0(16.4)              |          |              | flared type, 5.0(16.4)              |            |          | -     |        |      |
| Pipe length range m (ft)                                 |  | 5 ~ 75 (16.4 ~ 246.1)                          |                                     |          | -            |                                     |            | -        |       |        |      |
| Indoor unit & Outdoor unit height difference m (ft)      |  | 15 (OD located lower) / 30 (OD located higher) |                                     |          | (49.2/98.4)  |                                     |            | -        |       |        |      |
| Add gas amount g/m (oz/ft)                               |  | 50 (0.538)                                     |                                     |          | -            |                                     |            | -        |       |        |      |
| Pipe length for additional gas m (ft)                    |  | 30 (98.4)                                      |                                     |          | -            |                                     |            | -        |       |        |      |

\*1: In case it is necessary to indicate the air flow volume in (l/s), the value in (m³/min.) shall be multiplied by 16.7 and rounded down the decimal point.  
 \*2: If the EUROVENT Certified models can be operated under the "extra-low" temperature condition, -7°C dry bulb and -8°C wet-bulb temperatures with rated voltage 230 V shall be used.  
 \*3: Network Impedance shall be applicable for EUROPE and CHINA models.  
 \*4: The annual consumption is calculated by multiplying the input power at 230 V (400 V) by an average of 500 hours per year in cooling mode.  
 \*5: EER and COP classification is at 230 V (400 V) only in accordance with EU directive 2002/31/EC.  
 \*6: SEER and SCOP classification is at 230V(400V) only in accordance with EN-14825. For heating, SCOP indicates the value of only Average heating season, Other fiche data indicates in an attached sheet.

# Single -Type

## 1-1. Unit Specifications

**PE1**

### 4. Low Silhouette Ducted Type S-125PF1E5A / U-125PE1E8A

| INDOOR   |  | MODEL                                  | S-125PF1E5A                                    |          |             | -                                   |             |          | -     |        |      |
|--|--|--|--|----------|-------------|-------------------------------------|-------------|----------|-------|--------|------|
| OUTDOOR  |  | MODEL                                  | -  |          |             | U-125PE1E8A                         |             |          | -     |        |      |
| Branch pipe  |  | MODEL                                  | -  |          |             | -                                   |             |          | -     |        |      |
| Performance test condition                               |  | ISO13253 / EN14511 / EN12102 / EN14825 |  |          |             |                                     |             |          |       |        |      |
| Power supply   |  | Ø, Hz                                  | 1ø 50Hz  |          |             | 3ø 50Hz                             |             |          | Min   | Max    |      |
|  |  | V                                      | 220  | 230      | 240         | 380                                 | 400         | 415      | -     | -      |      |
| C<br>O<br>O<br>L<br>I<br>N<br>G                          | Capacity                                 | kW                                     | 12.5   | 12.5     | 12.5        | -                                   | -           | -        | 3.3   | 14.0   |      |
|  |  | BTU/h                                  | 42700  | 42700    | 42700       | -                                   | -           | -        | 11300 | 47800  |      |
|  | Current                                  | A                                      | 1.48   | 1.44     | 1.39        | 5.52                                | 5.29        | 5.12     | -     | -      |      |
|  |  | W                                      | 215  | 215      | 215         | 3.355k                              | 3.355k      | 3.355k   | -     | -      |      |
|  | Input power                              | TOTAL W                                | -  |          |             | 3.570k                              | 3.570k      | 3.570k   | 840   | 4.600k |      |
|  |  | Annual consumption                     | TOTAL kWh *4                                   | -        |             |                                     | -           | 1785     | -     | -      | -    |
|  | EER/EER CLASS                            |  | TOTAL (W/W) <sup>5</sup> / ("A"-°G)            | -        | -           | -                                   | 3.50        | 3.50 / A | 3.50  | 3.93   | 3.04 |
|  | Erp<br>*6                                | Pdesign                                | kW   | -        | -           | -                                   | -           | 12.5     | -     | -      | -    |
|  |  | η <sub>s.c</sub>                       | %  | -        | -           | -                                   | -           | 219.0    | -     | -      | -    |
|  |  | Annual consumption                     | kWh  | -        | -           | -                                   | -           | -        | -     | -      | -    |
| Class  |  |  | -  | -        | -           | -                                   | -           | -        | -     | -      |      |
| Power factor   |  | %                                      | -  | -        | -           | 92                                  | 92          | 91       | -     | -      |      |
| Noise indoor   | dB-A (H/M/L)                             | 39/35/32                               |  |          | -           |                                     |             | -        | -     |        |      |
|  | Power Level dB                           | 61/57/54                               |  |          | -           |                                     |             | -        | -     |        |      |
| Noise outdoor  | dB-A (H/L)                               | -                                      |  |          | 53/-        |                                     |             | -        | -     |        |      |
|  | Power Level dB                           | -                                      |  |          | 70/-        |                                     |             | -        | -     |        |      |
| H<br>E<br>A<br>T<br>I<br>N<br>G                          | Capacity                                 | kW                                     | 14.0   | 14.0     | 14.0        | -                                   | -           | -        | 4.1   | 16.0   |      |
|  |  | BTU/h                                  | 47800  | 47800    | 47800       | -                                   | -           | -        | 14000 | 54600  |      |
|  | Current                                  | A                                      | 1.46   | 1.42     | 1.38        | 5.44                                | 5.26        | 5.05     | -     | -      |      |
|  |  | W                                      | 210  | 210      | 210         | 3.270k                              | 3.270k      | 3.270k   | -     | -      |      |
|  | Input power                              | TOTAL W                                | -  |          |             | 3.480k                              | 3.480k      | 3.480k   | 900   | 5.200k |      |
|  |  | COP/COP CLASS                          | TOTAL (W/W) <sup>7</sup> / ("A"-°G)            | -        | -           | -                                   | 4.02        | 4.02 / A | 4.02  | 4.56   | 3.08 |
|  | Erp<br>*6                                | Pdesign at -10°C                       | kW   | -        | -           | -                                   | -           | 12.5     | -     | -      | -    |
|  |  | Tbivalent                              | °C   | -        | -           | -                                   | -           | -9       | -     | -      | -    |
|  |  | η <sub>s.h</sub>                       | %  | -        | -           | -                                   | -           | 145.9    | -     | -      | -    |
|  |  | Annual consumption                     | kWh  | -        | -           | -                                   | -           | -        | -     | -      | -    |
| Class  |  |  | -  | -        | -           | -                                   | -           | -        | -     | -      |      |
| Power factor   |  | %                                      | -  | -        | -           | 91                                  | 90          | 90       | -     | -      |      |
| Noise indoor   | dB-A (H/M/L)                             | 39/35/32                               |  |          | -           |                                     |             | -        | -     |        |      |
|  | Power Level dB                           | 61/57/54                               |  |          | -           |                                     |             | -        | -     |        |      |
| Noise outdoor  | dB-A (H/L)                               | -                                      |  |          | 53/-        |                                     |             | -        | -     |        |      |
|  | Power Level dB                           | -                                      |  |          | 70/-        |                                     |             | -        | -     |        |      |
| EXTRA LOW TEMP Total capacity(kW) / Input power(W) / COP |  | (Q10.5kW/W5.200kW/COP2.02)             |  |          |             |                                     |             |          |       |        |      |
| Max Current(A) / Max Input power(W)                      |  | 1.80/265                               | 1.75/265                                       | 1.70/265 | 10.0/6.200k | 10.0/6.500k                         | 10.0/6.750k | -        |       |        |      |
| Starting current(A) / Comp output(W)                     |  | -                                      | -  | -        | 5.52/3.0k   | 5.29/3.0k                           | 5.12/3.0k   | -        |       |        |      |
| Network Impedance(ΩMAX.)                                 |  | -                                      |  |          |             |                                     |             |          |       |        |      |
| Fan motor output (Indoor/Outdoor) W                      |  | 200                                    |  |          | 90×2        |                                     |             | -        |       |        |      |
| Moisture removal volume                                  |  | L/h(Pt/h)                              | 7.9  | (16.6)   |             | -                                   |             |          | -     |        |      |
| External static pressure                                 |  | Pa                                     | 100 (MIN10 - MAX150)                           |          |             | -                                   |             |          | -     |        |      |
| Indoor Air flow  | Cooling                                  | m³/min (ft³/min)                       | 34/29/23 (1201/1024/812)                       |          |             | -                                   |             |          | -     |        |      |
|  | Heating                                  | m³/min (ft³/min)                       | 34/29/23 (1201/1024/812)                       |          |             | -                                   |             |          | -     |        |      |
| Outdoor Air flow   | Cooling                                  | m³/min (ft³/min)                       | -  |          |             | 130                                 | (4591)      | -        |       |        |      |
|  | Heating                                  | m³/min (ft³/min)                       | -  |          |             | 110                                 | (3885)      | -        |       |        |      |
| Refrigerant type / amount g(oz)                          |  |  | -  |          |             | R410A                               | 3.40k       | (119.9)  | -     |        |      |
| Product dimension  | Height                                   | mm(inch)                               | 290 (11-13/32)                                 |          |             | 1416 (55-3/4)                       |             |          | -     |        |      |
|  | Width                                    | mm(inch)                               | 1400 (55-1/8)                                  |          |             | 940 (37-1/32)                       |             |          | -     |        |      |
|  | Depth                                    | mm(inch)                               | 700 (27-9/16)                                  |          |             | 340 (13-13/32)                      |             |          | -     |        |      |
| Packing dimension  | Height                                   | mm(inch)                               | 355  |          |             | 1556                                |             |          | -     |        |      |
|  | Width                                    | mm(inch)                               | 1614   |          |             | 1055                                |             |          | -     |        |      |
|  | Depth                                    | mm(inch)                               | 850  |          |             | 485                                 |             |          | -     |        |      |
| Weight   | (NET)                                    | kg(lb)                                 | 45 (99)  |          |             | 98 (216)                            |             |          | -     |        |      |
|  | (GROSS)                                  | kg(lb)                                 | 54 (119)                                       |          |             | 108 (238)                           |             |          | -     |        |      |
| Layers limit (actually)                                  |  |  | 9 (10)   |          |             | 1 (2)                               |             |          | -     |        |      |
| Operation condition                                      | Cool (DBT)                               |  | 18°C ~ 32°C                                    |          |             | -15°C ~ 46°C                        |             |          | -     |        |      |
|  | Heat (DBT)                               |  | 16°C ~ 30°C                                    |          |             | -20°C ~ 24°C                        |             |          | -     |        |      |
| P<br>I<br>P<br>E<br>I<br>N<br>G                          | Pipe diameter mm (inch)                  |  | (Liquid)ø9.52(3/8) (Gas)ø15.88(5/8)            |          |             | (Liquid)ø9.52(3/8) (Gas)ø15.88(5/8) |             |          | -     |        |      |
|  | Connecting method, Standard length m(ft) |  | flared type, 5.0(16.4)                         |          |             | flared type, 5.0(16.4)              |             |          | -     |        |      |
| Pipe length range  |  | m (ft)                                 | 5 ~ 75 (16.4 ~ 246.1)                          |          |             | -                                   |             |          | -     |        |      |
| Indoor unit & Outdoor unit height difference             |  | m (ft)                                 | 15 (OD located lower) / 30 (OD located higher) |          |             | (49.2/98.4)                         |             |          | -     |        |      |
| Add gas amount   |  | g/m (oz/ft)                            | 50   |          |             | (0.538)                             |             |          | -     |        |      |
| Pipe length for additional gas                           |  | m (ft)                                 | 30   |          |             | (98.4)                              |             |          | -     |        |      |

\*1: In case it is necessary to indicate the air flow volume in (l/s), the value in (m³/min.) shall be multiplied by 16.7 and rounded down the decimal point.

\*2: If the EUROVENT Certified models can be operated under the "extra-low" temperature condition, -7°C dry bulb and -8°C wet-bulb temperatures with rated voltage 230 V shall be used.

\*3: Network Impedance shall be applicable for EUROPE and CHINA models.

\*4: The annual consumption is calculated by multiplying the input power at 230 V (400 V) by an average of 500 hours per year in cooling mode.

\*5: EER and COP classification is at 230 V (400 V) only in accordance with EU directive 2002/31/EC.

\*6: SEER and SCOP classification is at 230V(400V) only in accordance with EN-14825. For heating, SCOP indicates the value of only Average heating season.

# Single -Type

## 1-1. Unit Specifications

PE1

### 4. Low Silhouette Ducted Type S-140PF1E5A / U-140PE1E8A

| INDOOR   |  | MODEL                                  | S-140PF1E5A                         |  |              | -                                   |             |          | -     |        |      |
|--|--|--|-------------------------------------|--|--------------|-------------------------------------|-------------|----------|-------|--------|------|
| OUTDOOR  |  | MODEL                                  | -                                   |  |              | U-140PE1E8A                         |             |          | -     |        |      |
| Branch pipe  |  | MODEL                                  | -                                   |  |              | -                                   |             |          | -     |        |      |
| Performance test condition                               |  | ISO13253 / EN14511 / EN12102 / EN14825 |                                     |  |              |                                     |             |          |       |        |      |
| Power supply   |  | Ø, Hz                                  | 1ø 50Hz                             |  |              | 3ø 50Hz                             |             |          | Min   | Max    |      |
|  |  | V                                      | 220                                 | 230  | 240          | 380                                 | 400         | 415      | -     | -      |      |
| C<br>O<br>O<br>L<br>I<br>N<br>G                          | Capacity                                 | kW                                     | 14.0                                | 14.0   | 14.0         | -                                   | -           | -        | 3.3   | 15.5   |      |
|  |  | BTU/h                                  | 47800                               | 47800  | 47800        | -                                   | -           | -        | 11300 | 52900  |      |
|  | Current                                  | A                                      | 1.55                                | 1.50   | 1.47         | 6.69                                | 6.42        | 6.18     | -     | -      |      |
|  |  | W                                      | 225                                 | 225  | 225          | 4.085k                              | 4.085k      | 4.085k   | -     | -      |      |
|  | Input power                              | TOTAL W                                | -                                   |  |              | 4.310k                              | 4.310k      | 4.310k   | 840   | 6.000k |      |
|  |  | Annual consumption                     | TOTAL kWh *4                        | -  |              |                                     | -           | 2155     | -     | -      | -    |
|  | EER/EER CLASS                            |  | TOTAL (W/W) *5 / ("A"-*G)           | -  | -            | -                                   | 3.25        | 3.25 / A | 3.25  | 3.93   | 2.58 |
|  | Erp *6                                   | Pdesign                                | kW                                  | -  | -            | -                                   | -           | 14.0     | -     | -      | -    |
|  |  | η <sub>s.c</sub>                       | %                                   | -  | -            | -                                   | -           | 212.8    | -     | -      | -    |
|  |  | Annual consumption                     | kWh                                 | -  | -            | -                                   | -           | -        | -     | -      | -    |
|  |  | Class                                  |                                     | -  | -            | -                                   | -           | -        | -     | -      | -    |
|  | Power factor                             |  | %                                   | -  | -            | -                                   | 93          | 92       | 92    | -      | -    |
| Noise indoor   | dB-A (H/M/L)                             | 40/36/33                               |                                     |  | -            |                                     |             | -        | -     |        |      |
|  | Power Level dB                           | 62/58/55                               |                                     |  | -            |                                     |             | -        | -     |        |      |
| Noise outdoor  | dB-A (H/L)                               | -                                      |                                     |  | 54/-         |                                     |             | -        | -     |        |      |
|  | Power Level dB                           | -                                      |                                     |  | 71/-         |                                     |             | -        | -     |        |      |
| H<br>E<br>A<br>T<br>I<br>N<br>G                          | Capacity                                 | kW                                     | 16.0                                | 16.0   | 16.0         | -                                   | -           | -        | 4.1   | 18.0   |      |
|  |  | BTU/h                                  | 54600                               | 54600  | 54600        | -                                   | -           | -        | 14000 | 61400  |      |
|  | Current                                  | A                                      | 1.55                                | 1.50   | 1.46         | 6.64                                | 6.35        | 6.15     | -     | -      |      |
|  |  | W                                      | 225                                 | 225  | 225          | 4.215k                              | 4.215k      | 4.215k   | -     | -      |      |
|  | Input power                              | TOTAL W                                | -                                   |  |              | 4.440k                              | 4.440k      | 4.440k   | 900   | 5.900k |      |
|  |  | COP/COP CLASS                          | TOTAL (W/W) *5 / ("A"-*G)           | -  | -            | -                                   | 3.60        | 3.60 / A | 3.60  | 4.56   | 3.05 |
|  | Erp *6                                   | Pdesign at -10°C                       | kW                                  | -  | -            | -                                   | -           | 14.0     | -     | -      | -    |
|  |  | Tbivalent                              | °C                                  | -  | -            | -                                   | -           | -7       | -     | -      | -    |
|  |  | η <sub>s.h</sub>                       | %                                   | -  | -            | -                                   | -           | 142.3    | -     | -      | -    |
|  |  | Annual consumption                     | kWh                                 | -  | -            | -                                   | -           | -        | -     | -      | -    |
|  | Power factor                             |  | %                                   | -  | -            | -                                   | 96          | 96       | 95    | -      | -    |
|  | Noise indoor                             | dB-A (H/M/L)                           | 40/36/33                            |  |              | -                                   |             |          | -     | -      |      |
| Power Level dB   |  | 62/58/55                               |                                     |  | -            |                                     |             | -        | -     |        |      |
| Noise outdoor  | dB-A (H/L)                               | -                                      |                                     |  | 55/-         |                                     |             | -        | -     |        |      |
|  | Power Level dB                           | -                                      |                                     |  | 71/-         |                                     |             | -        | -     |        |      |
| EXTRA LOW TEMP Total capacity(kW) / Input power(W) / COP |  | (Q11.5kW/W5.800kW/COP1.98)             |                                     |  |              |                                     |             |          |       |        |      |
| Max Current(A) / Max Input power(W)                      |  | 1.91/285                               | 1.86/285                            | 1.81/285                                       | 11.0/6.800k  | 11.0/7.150k                         | 11.0/7.450k | -        |       |        |      |
| Starting current(A) / Comp output(W)                     |  | -                                      | -                                   | -  | 6.69/3.0k    | 6.42/3.0k                           | 6.18/3.0k   | -        |       |        |      |
| Network Impedance(ΩMAX.)                                 |  | -                                      |                                     |  |              |                                     |             |          |       |        |      |
| Fan motor output (Indoor/Outdoor) W                      |  | 200                                    |                                     |  | 90×2         |                                     |             | -        |       |        |      |
| Moisture removal volume                                  |  | L/h(P/h)                               | 9.0                                 | (18.9)   |              |                                     | -           |          |       |        |      |
| External static pressure                                 |  | Pa                                     | 100 (MIN10 - MAX150)                |  |              | -                                   |             |          | -     |        |      |
| Indoor Air flow  | Cooling                                  | m³/min (ft³/min)                       | 36/32/25 (1271/1130/883)            |  |              | -                                   |             |          | -     | -      |      |
|  | Heating                                  | m³/min (ft³/min)                       | 36/32/25 (1271/1130/883)            |  |              | -                                   |             |          | -     | -      |      |
| Outdoor Air flow   | Cooling                                  | m³/min (ft³/min)                       | -                                   |  |              | 135                                 | (4767)      | -        | -     |        |      |
|  | Heating                                  | m³/min (ft³/min)                       | -                                   |  |              | 120                                 | (4238)      | -        | -     |        |      |
| Refrigerant type / amount g(oz)                          |  | -                                      |                                     |  | R410A        | 3.40k                               | (119.9)     | -        |       |        |      |
| Product dimension  | Height                                   | mm(inch)                               | 290 (11-13/32)                      |  |              | 1416 (55-3/4)                       |             |          | -     |        |      |
|  | Width                                    | mm(inch)                               | 1400 (55-1/8)                       |  |              | 940 (37-1/32)                       |             |          | -     |        |      |
|  | Depth                                    | mm(inch)                               | 700 (27-9/16)                       |  |              | 340 (13-13/32)                      |             |          | -     |        |      |
| Packing dimension  | Height                                   | mm(inch)                               | 355                                 |  |              | 1556                                |             |          | -     |        |      |
|  | Width                                    | mm(inch)                               | 1614                                |  |              | 1055                                |             |          | -     |        |      |
|  | Depth                                    | mm(inch)                               | 850                                 |  |              | 485                                 |             |          | -     |        |      |
| Weight   | (NET)                                    | kg(lb)                                 | 45 (99)                             |  |              | 98 (216)                            |             |          | -     |        |      |
|  | (GROSS)                                  | kg(lb)                                 | 54 (119)                            |  |              | 108 (238)                           |             |          | -     |        |      |
| Layers limit (actually)                                  |  | 9 (10)                                 |                                     |  | 1 (2)        |                                     |             | -        |       |        |      |
| Operation condition                                      | Cool (DBT)                               | 18°C ~ 32°C                            |                                     |  | -15°C ~ 46°C |                                     |             | -        |       |        |      |
|  | Heat (DBT)                               | 16°C ~ 30°C                            |                                     |  | -20°C ~ 24°C |                                     |             | -        |       |        |      |
| P<br>I<br>P<br>I<br>N<br>G                               | Pipe diameter mm (inch)                  |  | (Liquid)ø9.52(3/8) (Gas)ø15.88(5/8) |  |              | (Liquid)ø9.52(3/8) (Gas)ø15.88(5/8) |             |          | -     |        |      |
|  | Connecting method, Standard length m(ft) |  | flared type, 5.0(16.4)              |  |              | flared type, 5.0(16.4)              |             |          | -     |        |      |
| Pipe length range  |  | m (ft)                                 |                                     | 5 ~ 75 (16.4 ~ 246.1)                          |              |                                     | -           |          |       |        |      |
| Indoor unit & Outdoor unit height difference             |  | m (ft)                                 |                                     | 15 (OD located lower) / 30 (OD located higher) |              |                                     | (49.2/98.4) |          |       |        |      |
| Add gas amount   |  | g/m (oz/ft)                            |                                     | 50 (0.538)                                     |              |                                     | -           |          |       |        |      |
| Pipe length for additional gas                           |  | m (ft)                                 |                                     | 30 (98.4)                                      |              |                                     | -           |          |       |        |      |

\*1: In case it is necessary to indicate the air flow volume in (l/s), the value in (m³/min.) shall be multiplied by 16.7 and rounded down the decimal point.  
 \*2: If the EUROVENT Certified models can be operated under the "extra-low" temperature condition, -7°C dry bulb and -8°C wet-bulb temperatures with rated voltage 230 V shall be used.  
 \*3: Network Impedance shall be applicable for EUROPE and CHINA models.  
 \*4: The annual consumption is calculated by multiplying the input power at 230 V (400 V) by an average of 500 hours per year in cooling mode.  
 \*5: EER and COP classification is at 230 V (400 V) only in accordance with EU directive 2002/31/EC.  
 \*6: SEER and SCOP classification is at 230V(400V) only in accordance with EN-14825. For heating, SCOP indicates the value of only Average heating season.

# Single -Type

## 1-1. Unit Specifications

**PE2**

### 5. Ducted Type S-36PN1E5A / U-36PE2E5A

| INDOOR   |   | MODEL                                  | S-36PN1E5A                                       |                       |              | -                                  |            |        | -    |        |   |
|--|---|--|--|-----------------------|--------------|------------------------------------|------------|--------|------|--------|---|
| OUTDOOR  |   | MODEL                                  | -  |                       |              | U-36PE2E5A                         |            |        | -    |        |   |
| Branch pipe  |   | MODEL                                  | -  |                       |              | -                                  |            |        | -    |        |   |
| Performance test condition                                 |   | ISO13253 / EN14511 / EN12102 / EN14825 |  |                       |              |                                    |            |        |      |        |   |
| Power supply   |   | Ø, Hz                                  | 1ø 50Hz  |                       |              | 1ø 50Hz                            |            |        |      |        |   |
|  |   | V                                      | 220V   | 230V                  | 240V         | 220V                               | 230V       | 240V   | Min  | Max    |   |
| C<br>O<br>O<br>L<br>I<br>N<br>G                            | Capacity  | kW                                     | 3.6  | 3.6                   | 3.6          | -                                  | -          | -      | 1.5  | 4.0    |   |
|  |   | BTU/h                                  | 12300  | 12300                 | 12300        | -                                  | -          | -      | 5100 | 13600  |   |
|  | Current   | A                                      | 0.42   | 0.43                  | 0.44         | 4.35                               | 4.15       | 3.95   | -    | -      |   |
|  |   | W                                      | 90   | 95                    | 100          | 0.870k                             | 0.865k     | 0.860k | -    | -      |   |
|  | Input power   | TOTAL W                                | -  |                       |              | 0.960k                             | 0.960k     | 0.960k | 340  | 1.120k |   |
|  |   | TOTAL kWh *4                           | -  |                       |              | -                                  | 480        | -      | -    | -      |   |
|  | Annual consumption                                  | TOTAL (W/W) *5 / ("A"-°G)              | -  | -                     | -            | 3.75                               | 3.75/A     | 3.75   | 4.41 | 3.57   |   |
|  | E <sub>rp</sub> *6                                  | Pdesign                                | kW   | -                     | -            | -                                  | -          | 3.6    | -    | -      | - |
|  |   | SEER                                   | (W/W)  | -                     | -            | -                                  | -          | 4.6    | -    | -      | - |
|  |   | Annual consumption                     | kWh  | -                     | -            | -                                  | -          | 274    | -    | -      | - |
|  |   | Class                                  |  | -                     | -            | -                                  | -          | B      | -    | -      | - |
|  | Power factor  | %                                      | -  | -                     | -            | 91                                 | 91         | 91     | -    | -      |   |
|  | Noise indoor  | dB-A (H/M/L)                           | 40/38/35   |                       |              | -                                  | -          | -      | -    | -      |   |
| Power Level dB   |   | 57/55/52                               |  |                       | -            | -                                  | -          | -      | -    |        |   |
| Noise outdoor  | dB-A (H/L)  | -                                      |  |                       | -            | 45/-                               | -          | -      | -    |        |   |
|  | Power Level dB                                      | -                                      |  |                       | -            | 64/-                               | -          | -      | -    |        |   |
| H<br>E<br>A<br>T<br>I<br>N<br>G                            | Capacity  | kW                                     | 4.0  | 4.0                   | 4.0          | -                                  | -          | -      | 1.5  | 5.0    |   |
|  |   | BTU/h                                  | 13600  | 13600                 | 13600        | -                                  | -          | -      | 5100 | 17100  |   |
|  | Current   | A                                      | 0.42   | 0.43                  | 0.44         | 4.20                               | 4.00       | 3.80   | -    | -      |   |
|  |   | W                                      | 90   | 95                    | 100          | 0.840k                             | 0.835k     | 0.830k | -    | -      |   |
|  | Input power   | TOTAL W                                | -  |                       |              | 0.930k                             | 0.930k     | 0.930k | 290  | 1.250k |   |
|  |   | TOTAL (W/W) *5 / ("A"-°G)              | -  | -                     | -            | 4.30                               | 4.30/A     | 4.30   | 5.17 | 4.00   |   |
|  | E <sub>rp</sub> *6                                  | Pdesign at -10°C                       | kW   | -                     | -            | -                                  | -          | 3.6    | -    | -      | - |
|  |   | Tbivalent                              | °C   | -                     | -            | -                                  | -          | -10    | -    | -      | - |
|  |   | SCOP                                   | (W/W)  | -                     | -            | -                                  | -          | 3.8    | -    | -      | - |
|  |   | Annual consumption                     | kWh  | -                     | -            | -                                  | -          | 1326   | -    | -      | - |
|  | Class   |  | -  | -                     | -            | -                                  | A          | -      | -    | -      |   |
|  | Power factor  | %                                      | -  | -                     | -            | 91                                 | 91         | 91     | -    | -      |   |
|  | Noise indoor  | dB-A (H/M/L)                           | 40/38/35   |                       |              | -                                  | -          | -      | -    | -      |   |
| Power Level dB   |   | 57/55/52                               |  |                       | -            | -                                  | -          | -      | -    |        |   |
| Noise outdoor  | dB-A (H/L)  | -                                      |  |                       | -            | 46/-                               | -          | -      | -    |        |   |
|  | Power Level dB                                      | -                                      |  |                       | -            | 66/-                               | -          | -      | -    |        |   |
| EXTRA LOW TEMP   Total capacity(kW) / Input power(W) / COP |   | -                                      |  |                       |              |                                    |            |        |      |        |   |
| Max Current(A) / Max Input power(W)                        |   | 0.60/130                               | 0.62/140   | 0.63/150              | 11.0/2.20k   | 11.0/2.30k                         | 11.0/2.40k | -      |      |        |   |
| Starting current(A) / Comp output(W)                       |   | -                                      | -  | -                     | 4.35/1.1k    | 4.15/1.1k                          | 3.95/1.1k  | -      |      |        |   |
| Network Impedance(ΩMAX.)                                   |   | -                                      |  |                       |              |                                    |            |        |      |        |   |
| Fan motor output (Indoor/Outdoor) W                        |   | 60                                     |  |                       | 60           |                                    |            | -      |      |        |   |
| Moisture removal volume                                    |   | L/h(Pt/h)                              | 2.1  | (4.4)                 |              | -                                  |            |        | -    |        |   |
| External static pressure                                   |   | Pa                                     | 50 (MIN10 - MAX80)                               |                       |              | -                                  |            |        | -    |        |   |
| Indoor Air flow  | Cooling   | m³/min (ft³/min)                       | 14.0 / 12.0 / 10.0 (494) / (424) / (353)         |                       |              | -                                  |            |        | -    |        |   |
|  | Heating   | m³/min (ft³/min)                       | 14.0 / 12.0 / 10.0 (494) / (424) / (353)         |                       |              | -                                  |            |        | -    |        |   |
| Outdoor Air flow   | Cooling   | m³/min (ft³/min)                       | -  |                       |              | 38                                 | (1342)     |        | -    |        |   |
|  | Heating   | m³/min (ft³/min)                       | -  |                       |              | 38                                 | (1342)     |        | -    |        |   |
| Refrigerant type / amount g(oz)                            |   | -                                      |  |                       | R410A        | 1.40k                              | (49.4)     |        | -    |        |   |
| Product dimension  | Height  | mm(inch)                               | 250  | (9-27/32)             |              | 619                                | (24-3/8)   |        | -    |        |   |
|  | Width   | mm(inch)                               | 780 [+100]                                       | (30-23/32 [+3-15/16]) |              | 799                                | (31-29/64) |        | -    |        |   |
|  | Depth   | mm(inch)                               | 650  | (25-19/32)            |              | 299                                | (11-49/64) |        | -    |        |   |
| Product dimension (Panel)                                  |   | H×W×D mm, inch                         | -  |                       |              | -                                  |            |        | -    |        |   |
| Packing dimension  | Height  | mm(inch)                               | 345  |                       |              | 688                                |            |        | -    |        |   |
|  | Width   | mm(inch)                               | 1007   |                       |              | 931                                |            |        | -    |        |   |
|  | Depth   | mm(inch)                               | 777  |                       |              | 422                                |            |        | -    |        |   |
| Weight   | (NET)   | kg(lb)                                 | 29   | (64)                  |              | 39                                 | (86)       |        | -    |        |   |
|  | (GROSS)   | kg(lb)                                 | 34   | (75)                  |              | 44                                 | (97)       |        | -    |        |   |
|  | Panel (NET)   | kg(lb)                                 | -  |                       |              | -                                  |            |        | -    |        |   |
| Layers limit (actually)                                    |   | 8 (9)                                  |  |                       | 5 (6)        |                                    |            | -      |      |        |   |
| Operation condition  | Cool (DBT)  | 18°C ~ 32°C                            |  |                       | -15°C ~ 46°C |                                    |            | -      |      |        |   |
|  | Heat (DBT)  | 16°C ~ 30°C                            |  |                       | -20°C ~ 24°C |                                    |            | -      |      |        |   |
| P<br>I<br>P<br>I<br>N<br>G                                 | Pipe diameter mm (inch)                             |  | (Liquid)ø6.35(1/4) (Gas)ø12.7(1/2)               |                       |              | (Liquid)ø6.35(1/4) (Gas)ø12.7(1/2) |            |        | -    |        |   |
|  | Connecting method, Standard length m(ft)            |  | flared type, 5.0(16.4)                           |                       |              | flared type, 5.0(16.4)             |            |        | -    |        |   |
|  | Pipe length range m (ft)                            |  | 3 ~ 40m (9.8 ~ 131.2)                            |                       |              | -                                  |            |        | -    |        |   |
|  | Indoor unit & Outdoor unit height difference m (ft) |  | 15m (OD located lower) / 30m (OD located higher) |                       |              | (49.2/98.4)                        |            |        | -    |        |   |
|  | Add gas amount g/m (oz/ft)                          |  | 20g (0.215)                                      |                       |              | -                                  |            |        | -    |        |   |
| Pipe length for additional gas m (ft)                      |   | 30m (98.4)                             |  |                       | -            |                                    |            | -      |      |        |   |

\*1: In case it is necessary to indicate the air flow volume in (l/s), the value in (m³/min.) shall be multiplied by 16.7 and rounded down the decimal point.

\*2: If the EUROVENT Certified models can be operated under the "extra-low" temperature condition, -7°C dry bulb and -8°C wet-bulb temperatures with rated voltage 230 V shall be used.

\*3: Network Impedance shall be applicable for EUROPE and CHINA models.

\*4: The annual consumption is calculated by multiplying the input power at 230V (400V) by an average of 500 hours per year in cooling mode.

\*5: EER and COP classification is at 230V (400V) only in accordance with EU directive 2002/31/EC.

\*6: SEER and SCOP classification is at 230V (400V) only in accordance with EN-14825. For heating, SCOP indicates the value of only Average heating season, Other fiche data indicates in an attached sheet.

# Simultaneous (Twin) -Type

## 1-1. Unit Specifications

**PE1**

### 5. Ducted Type S-36PN1E5A×2 / U-71PE1E5A

| INDOOR   |   | MODEL  | S-36PN1E5A×2                     |              |                                     | -              |             |          | -    |        |      |
|--|---|--|----------------------------------|--------------|-------------------------------------|----------------|-------------|----------|------|--------|------|
| OUTDOOR  |   | MODEL  | -                                |              |                                     | U-71PE1E5A     |             |          | -    |        |      |
| Branch pipe  |   | MODEL  | CZ-P155BK1                       |              |                                     |                |             |          |      |        |      |
| Performance test condition                               |   | ISO13253 / EN14511 / EN14825 / EN12102         |                                  |              |                                     |                |             |          |      |        |      |
| Power supply   |   | Ø, Hz  | 1ø 50Hz                          |              |                                     | 1ø 50Hz        |             |          |      |        |      |
|  |   | V  | 220                              | 230          | 240                                 | 220            | 230         | 240      | Min  | Max    |      |
| C<br>O<br>O<br>L<br>I<br>N<br>G                          | Capacity  | kW   | 7.1                              | 7.1          | 7.1                                 | -              | -           | -        | 2.5  | 8.0    |      |
|  |   | BTU/h  | 24200                            | 24200        | 24200                               | -              | -           | -        | 8500 | 27300  |      |
|  | Current   | A  | 0.42×2                           | 0.43×2       | 0.44×2                              | 9.70           | 9.40        | 9.20     | -    | -      |      |
|  |   | W  | 90×2                             | 94×2         | 98×2                                | 2.010k         | 2.012k      | 2.014k   | -    | -      |      |
|  | Input power   | TOTAL W  | -                                |              |                                     | 2.190k         | 2.200k      | 2.210k   | 550  | 2.750k |      |
|  |   | Annual consumption                             | TOTAL kWh *4                     | -            |                                     |                | -           | 1100     | -    | -      | -    |
|  | EER/EER CLASS                                       | TOTAL (W/W) *5 / ("A"-*G)                      | -                                | -            | -                                   | 3.24           | 3.23 / A    | 3.21     | 4.55 | 2.91   |      |
|  | Erp *6  | Pdesign  | kW                               | -            | -                                   | -              | -           | 7.1      | -    | -      | -    |
|  |   | SEER   | (W/W)                            | -            | -                                   | -              | -           | 4.8      | -    | -      | -    |
|  |   | Annual consumption                             | kWh                              | -            | -                                   | -              | -           | 516      | -    | -      | -    |
|  |   | Class  |                                  | -            | -                                   | -              | -           | B        | -    | -      | -    |
|  | Power factor  | %  | -                                | -            | -                                   | 94             | 93          | 91       | -    | -      |      |
|  | Noise indoor  | dB-A (H/M/L)                                   | 40/38/35                         |              |                                     | -              | -           | -        | -    | -      |      |
|  |   | Power Level dB                                 | 57/55/52                         |              |                                     | -              | -           | -        | -    | -      |      |
| Noise outdoor  | dB-A (H/L)  | -  |                                  |              | -                                   | 48/-           | -           | -        | -    |        |      |
|  | Power Level dB                                      | -  |                                  |              | -                                   | 65/-           | -           | -        | -    |        |      |
| H<br>E<br>A<br>T<br>I<br>N<br>G                          | Capacity  | kW   | 8.0                              | 8.0          | 8.0                                 | -              | -           | -        | 2.0  | 9.0    |      |
|  |   | BTU/h  | 27300                            | 27300        | 27300                               | -              | -           | -        | 6800 | 30700  |      |
|  | Current   | A  | 0.42×2                           | 0.43×2       | 0.44×2                              | 10.2           | 9.9         | 9.7      | -    | -      |      |
|  |   | W  | 90×2                             | 94×2         | 98×2                                | 2.120k         | 2.122k      | 2.124k   | -    | -      |      |
|  | Input power   | TOTAL W  | -                                |              |                                     | 2.300k         | 2.310k      | 2.320k   | 500  | 2.920k |      |
|  |   | COP/COP CLASS                                  | TOTAL (W/W) *5 / ("A"-*G)        | -            | -                                   | -              | 3.48        | 3.46 / B | 3.45 | 4.00   | 3.08 |
|  | Erp *6  | Pdesign at -10°C                               | kW                               | -            | -                                   | -              | -           | 6.1      | -    | -      | -    |
|  |   | Tbivalent                                      | °C                               | -            | -                                   | -              | -           | -9       | -    | -      | -    |
|  |   | SCOP   | (W/W)                            | -            | -                                   | -              | -           | 3.8      | -    | -      | -    |
|  |   | Annual consumption                             | kWh                              | -            | -                                   | -              | -           | 2245     | -    | -      | -    |
|  | Class   |  | -                                | -            | -                                   | -              | A           | -        | -    | -      |      |
|  | Power factor  | %  | -                                | -            | -                                   | 94             | 93          | 91       | -    | -      |      |
|  | Noise indoor  | dB-A (H/M/L)                                   | 40/38/35                         |              |                                     | -              | -           | -        | -    | -      |      |
|  |   | Power Level dB                                 | 57/55/52                         |              |                                     | -              | -           | -        | -    | -      |      |
| Noise outdoor  | dB-A (H/L)  | -  |                                  |              | -                                   | 50/-           | -           | -        | -    |        |      |
|  | Power Level dB                                      | -  |                                  |              | -                                   | 67/-           | -           | -        | -    |        |      |
| EXTRA LOW TEMP Total capacity(kW) / Input power(W) / COP |   | -  |                                  |              |                                     |                |             |          |      |        |      |
| Max Current(A) / Max Input power(W)                      |   | 0.60×2/130×2                                   | 0.62×2/140×2                     | 0.63×2/150×2 | 18.0/3.800k                         | 18.0/3.930k    | 18.0/4.060k | -        |      |        |      |
| Starting current(A) / Comp output(W)                     |   | -  | -                                | -            | 10.2/2.0k                           | 9.9/2.0k       | 9.7/2.0k    | -        |      |        |      |
| Network Impedance(ΩMAX.)                                 |   | -  |                                  |              |                                     |                |             |          |      |        |      |
| Fan motor output (Indoor/Outdoor) W                      |   | 60×2   |                                  |              | 90                                  |                |             | -        |      |        |      |
| Moisture removal volume                                  |   | L/h(Pt/h)                                      | 4.2                              | (2.1×2)      | (8.8)                               | -              |             |          | -    |        |      |
| External static pressure                                 |   | Pa   | 50 (MIN10 - MAX80)               |              |                                     | -              |             |          | -    |        |      |
| Indoor Air flow  | Cooling   | m³/min (ft³/min)                               | [14/12/10 (494/424/353)]×2       |              |                                     | -              |             |          | -    |        |      |
|  | Heating   | m³/min (ft³/min)                               | [14/12/10 (494/424/353)]×2       |              |                                     | -              |             |          | -    |        |      |
| Outdoor Air flow   | Cooling   | m³/min (ft³/min)                               | -                                |              |                                     | 60             | (2119)      | -        |      |        |      |
|  | Heating   | m³/min (ft³/min)                               | -                                |              |                                     | 60             | (2119)      | -        |      |        |      |
| Refrigerant type / amount g(oz)                          |   | -  |                                  |              | R410A                               | 2.35k          | (82.9)      | -        |      |        |      |
| Product dimension  | Height  | mm(inch)                                       | 250 (9-27/32)                    |              |                                     | 996 (39-77/32) |             |          | -    |        |      |
|  | Width   | mm(inch)                                       | 780 (+100) (30-23/32) (+3-15/16) |              |                                     | 940 (37-11/32) |             |          | -    |        |      |
|  | Depth   | mm(inch)                                       | 650 (25-19/32)                   |              |                                     | 340 (13-13/32) |             |          | -    |        |      |
| Packing dimension  | Height  | mm(inch)                                       | 345                              |              |                                     | 1136           |             |          | -    |        |      |
|  | Width   | mm(inch)                                       | 1007                             |              |                                     | 1055           |             |          | -    |        |      |
|  | Depth   | mm(inch)                                       | 777                              |              |                                     | 485            |             |          | -    |        |      |
| Weight   | (NET)   | kg(lb)   | 29 (64)                          |              |                                     | 69 (152)       |             |          | -    |        |      |
|  | (GROSS)   | kg(lb)   | 34 (75)                          |              |                                     | 77 (170)       |             |          | -    |        |      |
| Layers limit (actually)                                  |   | 8 (9)  |                                  |              | 2 (3)                               |                |             | -        |      |        |      |
| Operation condition                                      | Cool (DBT)  | 18°C ~ 32°C                                    |                                  |              | -15°C ~ 46°C                        |                |             | -        |      |        |      |
|  | Heat (DBT)  | 16°C ~ 30°C                                    |                                  |              | -20°C ~ 24°C                        |                |             | -        |      |        |      |
| P<br>I<br>P<br>E   | Pipe diameter mm (inch)                             | (Liquid)ø6.35(1/4) (Gas)ø12.7(1/2)             |                                  |              | (Liquid)ø9.52(3/8) (Gas)ø15.88(5/8) |                |             | -        |      |        |      |
|  | Connecting method, Standard length m(ft)            | flared type, 5.0(16.4)                         |                                  |              | flared type, 5.0(16.4)              |                |             | -        |      |        |      |
| I<br>N<br>G  | Pipe length range m (ft)                            | 5 ~ 50 (16.4 ~ 164.0)                          |                                  |              | -                                   |                |             | -        |      |        |      |
|  | Indoor unit & Outdoor unit height difference m (ft) | 15 (OD located lower) / 30 (OD located higher) |                                  |              | (49.2/98.4)                         |                |             | -        |      |        |      |
| G  | Add gas amount g/m (oz/ft)                          | 50   |                                  |              | (0.538)                             |                |             | -        |      |        |      |
|  | Pipe length for additional gas m (ft)               | 30   |                                  |              | (98.4)                              |                |             | -        |      |        |      |

\*1: In case it is necessary to indicate the air flow volume in (l/s), the value in (m³/min.) shall be multiplied by 16.7 and rounded down the decimal point.

\*2: If the EUROVENT Certified models can be operated under the "extra-low" temperature condition, -7°C dry bulb and -8°C wet-bulb temperatures with rated voltage 230 V shall be used.

\*3: Network Impedance shall be applicable for EUROPE and CHINA models.

\*4: The annual consumption is calculated by multiplying the input power at 230 V (400 V) by an average of 500 hours per year in cooling mode.

\*5: EER and COP classification is at 230 V (400 V) only in accordance with EU directive 2002/31/EC.

\*6: SEER and SCOP classification is at 230V(400V) only in accordance with EN-14825. For heating, SCOP indicates the value of only Average heating season, Other fiche data indicates in an attached sheet.

# Simultaneous (Triple) -Type

## 1-1. Unit Specifications

**PE1**

### 5. Ducted Type S-36PN1E5A×3 / U-100PE1E5A

| INDOOR   |   | MODEL  | S-36PN1E5A×3                     |              |                                     | -              |             |          | -     |        |      |
|--|---|--|----------------------------------|--------------|-------------------------------------|----------------|-------------|----------|-------|--------|------|
| OUTDOOR  |   | MODEL  | -                                |              |                                     | U-100PE1E5A    |             |          | -     |        |      |
| Branch pipe  |   | MODEL  | CZ-P3HPC2                        |              |                                     |                |             |          |       |        |      |
| Performance test condition                               |   | ISO13253 / EN14511 / EN14825 / EN12102         |                                  |              |                                     |                |             |          |       |        |      |
| Power supply   |   | Ø, Hz  | 1ø 50Hz                          |              |                                     | 1ø 50Hz        |             |          |       |        |      |
|  |   | V  | 220                              | 230          | 240                                 | 220            | 230         | 240      | Min   | Max    |      |
| C<br>O<br>O<br>L<br>I<br>N<br>G                          | Capacity  | kW   | 10.0                             | 10.0         | 10.0                                | -              | -           | -        | 3.3   | 12.5   |      |
|  |   | BTU/h  | 34100                            | 34100        | 34100                               | -              | -           | -        | 11300 | 42700  |      |
|  | Current   | A  | 0.42×3                           | 0.43×3       | 0.44×3                              | 11.6           | 11.2        | 10.9     | -     | -      |      |
|  |   | W  | 90×3                             | 94×3         | 98×3                                | 2.465k         | 2.468k      | 2.471k   | -     | -      |      |
|  | Input power   | TOTAL W  | -                                |              |                                     | 2.735k         | 2.750k      | 2.765k   | 870   | 3.800k |      |
|  |   | Annual consumption                             | TOTAL kWh *4                     | -            |                                     |                | -           | 1375     | -     | -      | -    |
|  | EER/EER CLASS                                       | TOTAL (W/W) *5 / ("A"-*G)                      | -                                | -            | -                                   | 3.66           | 3.64 / A    | 3.62     | 3.79  | 3.29   |      |
|  | Erp *6  | Pdesign  | kW                               | -            | -                                   | -              | -           | 10.0     | -     | -      | -    |
|  |   | SEER   | (W/W)                            | -            | -                                   | -              | -           | 5.2      | -     | -      | -    |
|  |   | Annual consumption                             | kWh                              | -            | -                                   | -              | -           | 673      | -     | -      | -    |
| Class  |   |  | -                                | -            | -                                   | -              | A           | -        | -     | -      |      |
| Power factor   | %   | -  | -                                | -            | 97                                  | 96             | 94          | -        | -     |        |      |
| Noise indoor   | dB-A (H/M/L)  | 40/38/35                                       |                                  |              | -                                   | -              | -           | -        | -     |        |      |
|  | Power Level dB                                      | 57/55/52                                       |                                  |              | -                                   | -              | -           | -        | -     |        |      |
| Noise outdoor  | dB-A (H/L)  | -  |                                  |              | -                                   | 52/-           | -           | -        | -     |        |      |
|  | Power Level dB                                      | -  |                                  |              | -                                   | 69/-           | -           | -        | -     |        |      |
| H<br>E<br>A<br>T<br>I<br>N<br>G                          | Capacity  | kW   | 11.2                             | 11.2         | 11.2                                | -              | -           | -        | 4.1   | 14.0   |      |
|  |   | BTU/h  | 38200                            | 38200        | 38200                               | -              | -           | -        | 14000 | 47800  |      |
|  | Current   | A  | 0.42×3                           | 0.43×3       | 0.44×3                              | 12.8           | 12.5        | 12.2     | -     | -      |      |
|  |   | W  | 90×3                             | 94×3         | 98×3                                | 2.745k         | 2.748k      | 2.751k   | -     | -      |      |
|  | Input power   | TOTAL W  | -                                |              |                                     | 3.015k         | 3.030k      | 3.045k   | 980   | 4.500k |      |
|  |   | COP/COP CLASS                                  | TOTAL (W/W) *5 / ("A"-*G)        | -            | -                                   | -              | 3.71        | 3.70 / A | 3.68  | 4.18   | 3.11 |
|  | Erp *6  | Pdesign at -10°C                               | kW                               | -            | -                                   | -              | -           | 10.0     | -     | -      | -    |
|  |   | Tbivalent                                      | °C                               | -            | -                                   | -              | -           | -10      | -     | -      | -    |
|  |   | SCOP   | (W/W)                            | -            | -                                   | -              | -           | 3.8      | -     | -      | -    |
|  |   | Annual consumption                             | kWh                              | -            | -                                   | -              | -           | 3670     | -     | -      | -    |
| Class  |   | -  | -                                | -            | -                                   | A              | -           | -        | -     |        |      |
| Power factor   | %   | -  | -                                | -            | 97                                  | 96             | 94          | -        | -     |        |      |
| Noise indoor   | dB-A (H/M/L)  | 40/38/35                                       |                                  |              | -                                   | -              | -           | -        | -     |        |      |
|  | Power Level dB                                      | 57/55/52                                       |                                  |              | -                                   | -              | -           | -        | -     |        |      |
| Noise outdoor  | dB-A (H/L)  | -  |                                  |              | -                                   | 52/-           | -           | -        | -     |        |      |
|  | Power Level dB                                      | -  |                                  |              | -                                   | 69/-           | -           | -        | -     |        |      |
| EXTRA LOW TEMP Total capacity(kW) / Input power(W) / COP |   | -  |                                  |              |                                     |                |             |          |       |        |      |
| Max Current(A) / Max Input power(W)                      |   | 0.60×3/130×3                                   | 0.62×3/140×3                     | 0.63×3/150×3 | 25.0/5.350k                         | 25.0/5.550k    | 25.0/5.750k | -        |       |        |      |
| Starting current(A) / Comp output(W)                     |   | -  | -                                | -            | 12.8/3.0k                           | 12.5/3.0k      | 12.2/3.0k   | -        |       |        |      |
| Network Impedance(ΩMAX.)                                 |   | -  |                                  |              |                                     |                |             |          |       |        |      |
| Fan motor output (Indoor/Outdoor) W                      |   | 60×3   |                                  |              | 90×2                                |                |             | -        |       |        |      |
| Moisture removal volume                                  |   | L/h(Pt/h)                                      | 6.0                              | (2.0×3)      | (12.6)                              | -              |             |          | -     |        |      |
| External static pressure                                 |   | Pa   | 50 (MIN10 - MAX80)               |              |                                     | -              |             |          | -     |        |      |
| Indoor Air flow  | Cooling   | m³/min (ft³/min)                               | [14/12/10 (494/424/353)]×3       |              |                                     | -              |             |          | -     |        |      |
|  | Heating   | m³/min (ft³/min)                               | [14/12/10 (494/424/353)]×3       |              |                                     | -              |             |          | -     |        |      |
| Outdoor Air flow   | Cooling   | m³/min (ft³/min)                               | -                                |              |                                     | 110            | (3885)      | -        |       |        |      |
|  | Heating   | m³/min (ft³/min)                               | -                                |              |                                     | 95             | (3355)      | -        |       |        |      |
| Refrigerant type / amount g(oz)                          |   | -  |                                  |              | R410A                               | 3.40k          | (119.9)     | -        |       |        |      |
| Product dimension  | Height  | mm(inch)                                       | 250 (9-27/32)                    |              |                                     | 1416 (55-3/4)  |             |          | -     |        |      |
|  | Width   | mm(inch)                                       | 780 (+100) (30-23/32) (+3-15/16) |              |                                     | 940 (37-1/32)  |             |          | -     |        |      |
|  | Depth   | mm(inch)                                       | 650 (25-19/32)                   |              |                                     | 340 (13-13/32) |             |          | -     |        |      |
| Packing dimension  | Height  | mm(inch)                                       | 345                              |              |                                     | 1556           |             |          | -     |        |      |
|  | Width   | mm(inch)                                       | 1007                             |              |                                     | 1055           |             |          | -     |        |      |
|  | Depth   | mm(inch)                                       | 777                              |              |                                     | 485            |             |          | -     |        |      |
| Weight   | (NET)   | kg(lb)   | 29 (64)                          |              |                                     | 98 (216)       |             |          | -     |        |      |
|  | (GROSS)   | kg(lb)   | 34 (75)                          |              |                                     | 108 (238)      |             |          | -     |        |      |
| Layers limit (actually)                                  |   | 8 (9)  |                                  |              | 1 (2)                               |                |             | -        |       |        |      |
| Operation condition                                      | Cool (DBT)  | 18°C ~ 32°C                                    |                                  |              | -15°C ~ 46°C                        |                |             | -        |       |        |      |
|  | Heat (DBT)  | 16°C ~ 30°C                                    |                                  |              | -20°C ~ 24°C                        |                |             | -        |       |        |      |
| P<br>I<br>P<br>E   | Pipe diameter mm (inch)                             | (Liquid)ø6.35(1/4) (Gas)ø12.7(1/2)             |                                  |              | (Liquid)ø9.52(3/8) (Gas)ø15.88(5/8) |                |             | -        |       |        |      |
|  | Connecting method, Standard length m(ft)            | flared type, 5.0(16.4)                         |                                  |              | flared type, 5.0(16.4)              |                |             | -        |       |        |      |
| I<br>N<br>G  | Pipe length range m (ft)                            | 5 ~ 75 (16.4 ~ 246.1)                          |                                  |              | -                                   |                |             | -        |       |        |      |
|  | Indoor unit & Outdoor unit height difference m (ft) | 15 (OD located lower) / 30 (OD located higher) |                                  |              | (49.2/98.4)                         |                |             | -        |       |        |      |
| G  | Add gas amount g/m (oz/ft)                          | 50   |                                  |              | (0.538)                             |                |             | -        |       |        |      |
|  | Pipe length for additional gas m (ft)               | 20   |                                  |              | (65.6)                              |                |             | -        |       |        |      |

\*1: In case it is necessary to indicate the air flow volume in (l/s), the value in (m³/min.) shall be multiplied by 16.7 and rounded down the decimal point.

\*2: If the EUROVENT Certified models can be operated under the "extra-low" temperature condition, -7°C dry bulb and -8°C wet-bulb temperatures with rated voltage 230 V shall be used.

\*3: Network Impedance shall be applicable for EUROPE and CHINA models.

\*4: The annual consumption is calculated by multiplying the input power at 230 V (400 V) by an average of 500 hours per year in cooling mode.

\*5: EER and COP classification is at 230 V (400 V) only in accordance with EU directive 2002/31/EC.

\*6: SEER and SCOP classification is at 230V(400V) only in accordance with EN-14825. For heating, SCOP indicates the value of only Average heating season, Other fiche data indicates in an attached sheet.



# Simultaneous (Double-Twin) -Type

## 1-1. Unit Specifications

**PE1**

### 5. Ducted Type S-36PN1E5A×4 / U-125PE1E5A

| INDOOR   |  | MODEL                                  | S-36PN1E5A×4                       |  |              | -                                   |             |          | -     |        |      |
|--|--|--|------------------------------------|--|--------------|-------------------------------------|-------------|----------|-------|--------|------|
| OUTDOOR  |  | MODEL                                  | -                                  |  |              | U-125PE1E5A                         |             |          | -     |        |      |
| Branch pipe  |  | MODEL                                  | CZ-P155BK1×3                       |  |              |                                     |             |          |       |        |      |
| Performance test condition                               |  | ISO13253 / EN14511 / EN12102 / EN14825 |                                    |  |              |                                     |             |          |       |        |      |
| Power supply   |  | Ø, Hz                                  | 1ø 50Hz                            |  |              | 1ø 50Hz                             |             |          |       |        |      |
|  |  | V                                      | 220                                | 230  | 240          | 220                                 | 230         | 240      | Min   | Max    |      |
| C<br>O<br>O<br>L<br>I<br>N<br>G                          | Capacity                                 | kW                                     | 12.5                               | 12.5   | 12.5         | -                                   | -           | -        | 3.3   | 14.0   |      |
|  |  | BTU/h                                  | 42700                              | 42700  | 42700        | -                                   | -           | -        | 11300 | 47800  |      |
|  | Current                                  | A                                      | 0.42×4                             | 0.43×4   | 0.44×4       | 17.4                                | 16.9        | 16.4     | -     | -      |      |
|  |  | W                                      | 90×4                               | 94×4   | 98×4         | 3.665k                              | 3.669k      | 3.673k   | -     | -      |      |
|  | Input power                              | TOTAL W                                | -                                  |  |              | 4.025k                              | 4.045k      | 4.065k   | 1000  | 4.800k |      |
|  |  | Annual consumption                     | TOTAL kWh *4                       | -  |              |                                     | -           | 2025     | -     | -      | -    |
|  | EER/EER CLASS                            |  | TOTAL (W/W) *5 / ("A"-*G)          | -  | -            | -                                   | 3.11        | 3.09 / B | 3.08  | 3.30   | 2.92 |
|  | Erp *6                                   | Pdesign                                | kW                                 | -  | -            | -                                   | -           | 12.5     | -     | -      | -    |
|  |  | η <sub>s.c</sub>                       | %                                  | -  | -            | -                                   | -           | 229.0    | -     | -      | -    |
|  |  | Annual consumption                     | kWh                                | -  | -            | -                                   | -           | -        | -     | -      | -    |
| Class  |  |  | -                                  | -  | -            | -                                   | -           | -        | -     | -      |      |
| Power factor   |  | %                                      | -                                  | -  | -            | 96                                  | 94          | 93       | -     | -      |      |
| Noise indoor   | dB-A (H/M/L)                             | 40/38/35                               |                                    |  | -            | -                                   | -           | -        | -     |        |      |
|  | Power Level dB                           | 57/55/52                               |                                    |  | -            | -                                   | -           | -        | -     |        |      |
| Noise outdoor  | dB-A (H/L)                               | -                                      |                                    |  | -            | 53/-                                |             | -        | -     |        |      |
|  | Power Level dB                           | -                                      |                                    |  | -            | 70/-                                |             | -        | -     |        |      |
| H<br>E<br>A<br>T<br>I<br>N<br>G                          | Capacity                                 | kW                                     | 14.0                               | 14.0   | 14.0         | -                                   | -           | -        | 4.1   | 16.0   |      |
|  |  | BTU/h                                  | 47800                              | 47800  | 47800        | -                                   | -           | -        | 14000 | 54600  |      |
|  | Current                                  | A                                      | 0.42×4                             | 0.43×4   | 0.44×4       | 17.3                                | 16.8        | 16.3     | -     | -      |      |
|  |  | W                                      | 90×4                               | 94×4   | 98×4         | 3.655k                              | 3.659k      | 3.663k   | -     | -      |      |
|  | Input power                              | TOTAL W                                | -                                  |  |              | 4.015k                              | 4.035k      | 4.055k   | 1050  | 5.400k |      |
|  |  | COP/COP CLASS                          | TOTAL (W/W) *5 / ("A"-*G)          | -  | -            | -                                   | 3.49        | 3.47 / B | 3.45  | 3.90   | 2.96 |
|  | Erp *6                                   | Pdesign at -10°C                       | kW                                 | -  | -            | -                                   | -           | 12.5     | -     | -      | -    |
|  |  | Tbivalent                              | °C                                 | -  | -            | -                                   | -           | -7       | -     | -      | -    |
|  |  | η <sub>s.h</sub>                       | %                                  | -  | -            | -                                   | -           | 144.1    | -     | -      | -    |
|  |  | Annual consumption                     | kWh                                | -  | -            | -                                   | -           | -        | -     | -      | -    |
| Power factor   |  | %                                      | -                                  | -  | -            | 96                                  | 95          | 93       | -     | -      |      |
| Noise indoor   | dB-A (H/M/L)                             | 40/38/35                               |                                    |  | -            | -                                   | -           | -        | -     |        |      |
|  | Power Level dB                           | 57/55/52                               |                                    |  | -            | -                                   | -           | -        | -     |        |      |
| Noise outdoor  | dB-A (H/L)                               | -                                      |                                    |  | -            | 53/-                                |             | -        | -     |        |      |
|  | Power Level dB                           | -                                      |                                    |  | -            | 70/-                                |             | -        | -     |        |      |
| EXTRA LOW TEMP Total capacity(kW) / Input power(W) / COP |  | -                                      |                                    |  |              |                                     |             |          |       |        |      |
| Max Current(A) / Max Input power(W)                      |  | 0.60×4/130×4                           | 0.62×4/140×4                       | 0.63×4/150×4                                   | 28.0/6.000k  | 28.0/6.200k                         | 28.0/6.400k | -        |       |        |      |
| Starting current(A) / Comp output(W)                     |  | -                                      | -                                  | -  | 17.4/3.0k    | 16.9/3.0k                           | 16.4/3.0k   | -        |       |        |      |
| Network Impedance(ΩMAX.)                                 |  | -                                      |                                    |  |              |                                     |             |          |       |        |      |
| Fan motor output (Indoor/Outdoor) W                      |  | 60×4                                   |                                    |  | 90×2         |                                     |             | -        |       |        |      |
| Moisture removal volume                                  |  | L/h(Pt/h)                              | 7.9                                | (1.98×4)                                       | (16.6)       | -                                   |             |          | -     |        |      |
| External static pressure                                 |  | Pa                                     | 50 (MIN10 - MAX80)                 |  |              | -                                   |             |          | -     |        |      |
| Indoor Air flow  | Cooling                                  | m³/min (ft³/min)                       | [14/12/10 (494/424/353)]×4         |  |              | -                                   |             |          | -     |        |      |
|  | Heating                                  | m³/min (ft³/min)                       | [14/12/10 (494/424/353)]×4         |  |              | -                                   |             |          | -     |        |      |
| Outdoor Air flow   | Cooling                                  | m³/min (ft³/min)                       | -                                  |  |              | 130                                 | (4591)      | -        |       |        |      |
|  | Heating                                  | m³/min (ft³/min)                       | -                                  |  |              | 110                                 | (3885)      | -        |       |        |      |
| Refrigerant type / amount g(oz)                          |  | -                                      |                                    |  | R410A        | 3.40k                               | (119.9)     | -        |       |        |      |
| Product dimension  | Height                                   | mm(inch)                               | 250 (9-27/32)                      |  |              | 1416 (55-3/4)                       |             |          | -     |        |      |
|  | Width                                    | mm(inch)                               | 780 (+100) (30-23/32) (+3-15/16)   |  |              | 940 (37-1/32)                       |             |          | -     |        |      |
|  | Depth                                    | mm(inch)                               | 650 (25-19/32)                     |  |              | 340 (13-13/32)                      |             |          | -     |        |      |
| Packing dimension  | Height                                   | mm(inch)                               | 345                                |  |              | 1556                                |             |          | -     |        |      |
|  | Width                                    | mm(inch)                               | 1007                               |  |              | 1055                                |             |          | -     |        |      |
|  | Depth                                    | mm(inch)                               | 777                                |  |              | 485                                 |             |          | -     |        |      |
| Weight   | (NET)                                    | kg(lb)                                 | 29 (64)                            |  |              | 98 (216)                            |             |          | -     |        |      |
|  | (GROSS)                                  | kg(lb)                                 | 34 (75)                            |  |              | 108 (238)                           |             |          | -     |        |      |
| Layers limit (actually)                                  |  | 8 (9)                                  |                                    |  | 1 (2)        |                                     |             | -        |       |        |      |
| Operation condition                                      | Cool (DBT)                               | 18°C ~ 32°C                            |                                    |  | -15°C ~ 46°C |                                     |             | -        |       |        |      |
|  | Heat (DBT)                               | 16°C ~ 30°C                            |                                    |  | -20°C ~ 24°C |                                     |             | -        |       |        |      |
| P<br>I<br>P<br>I<br>N<br>G                               | Pipe diameter mm (inch)                  |  | (Liquid)ø6.35(1/4) (Gas)ø12.7(1/2) |  |              | (Liquid)ø9.52(3/8) (Gas)ø15.88(5/8) |             |          | -     |        |      |
|  | Connecting method, Standard length m(ft) |  | flared type, 5.0(16.4)             |  |              | flared type, 5.0(16.4)              |             |          | -     |        |      |
| Pipe length range  |  | m (ft)                                 |                                    | 5 ~ 75 (16.4 ~ 246.1)                          |              | -                                   |             |          |       |        |      |
| Indoor unit & Outdoor unit height difference             |  | m (ft)                                 |                                    | 15 (OD located lower) / 30 (OD located higher) |              | (49.2/98.4)                         |             | -        |       |        |      |
| Add gas amount   |  | g/m (oz/ft)                            |                                    | 50 (0.538)                                     |              | -                                   |             |          |       |        |      |
| Pipe length for additional gas                           |  | m (ft)                                 |                                    | 20 (65.6)                                      |              | -                                   |             |          |       |        |      |

\*1: In case it is necessary to indicate the air flow volume in (l/s), the value in (m³/min.) shall be multiplied by 16.7 and rounded down the decimal point.

\*2: If the EUROVENT Certified models can be operated under the "extra-low" temperature condition, -7°C dry bulb and -8°C wet-bulb temperatures with rated voltage 230 V shall be used.

\*3: Network Impedance shall be applicable for EUROPE and CHINA models.

\*4: The annual consumption is calculated by multiplying the input power at 230 V (400 V) by an average of 500 hours per year in cooling mode.

\*5: EER and COP classification is at 230 V (400 V) only in accordance with EU directive 2002/31/EC.

\*6: SEER and SCOP classification is at 230V(400V) only in accordance with EN-14825. For heating, SCOP indicates the value of only Average heating season.

# Simultaneous (Triple) -Type

## 1-1. Unit Specifications

**PE1**

### 5. Ducted Type S-45PN1E5A×3 / U-125PE1E5A

| INDOOR   |  | MODEL  | S-45PN1E5A×3                     |              |                                     | -              |             |          | -     |        |      |
|--|--|--|----------------------------------|--------------|-------------------------------------|----------------|-------------|----------|-------|--------|------|
| OUTDOOR  |  | MODEL  | -                                |              |                                     | U-125PE1E5A    |             |          | -     |        |      |
| Branch pipe  |  | MODEL  | CZ-P3HPC2                        |              |                                     |                |             |          |       |        |      |
| Performance test condition                               |  | ISO13253 / EN14511 / EN12102 / EN14825         |                                  |              |                                     |                |             |          |       |        |      |
| Power supply   |  | Ø, Hz  | 1ø 50Hz                          |              |                                     | 1ø 50Hz        |             |          |       |        |      |
|  |  | V  | 220                              | 230          | 240                                 | 220            | 230         | 240      | Min   | Max    |      |
| C<br>O<br>O<br>L<br>I<br>N<br>G                          | Capacity                                 | kW   | 12.5                             | 12.5         | 12.5                                | -              | -           | -        | 3.3   | 14.0   |      |
|  |  | BTU/h  | 42700                            | 42700        | 42700                               | -              | -           | -        | 11300 | 47800  |      |
|  | Current                                  | A  | 0.54×3                           | 0.55×3       | 0.56×3                              | 17.4           | 16.9        | 16.4     | -     | -      |      |
|  |  | W  | 115×3                            | 120×3        | 125×3                               | 3.665k         | 3.665k      | 3.665k   | -     | -      |      |
|  | Input power                              | TOTAL W  | -                                |              |                                     | 4.010k         | 4.025k      | 4.040k   | 1000  | 4.800k |      |
|  |  | Annual consumption                             | TOTAL kWh *4                     | -            |                                     |                | -           | 2015     | -     | -      | -    |
|  | EER/EER CLASS                            | TOTAL (W/W) *5 / ("A"-*G)                      | -                                | -            | -                                   | 3.12           | 3.11 / B    | 3.09     | 3.30  | 2.92   |      |
|  | Erp *6                                   | Pdesign  | kW                               | -            | -                                   | -              | -           | 12.5     | -     | -      | -    |
|  |  | η <sub>s.c</sub>                               | %                                | -            | -                                   | -              | -           | 229.0    | -     | -      | -    |
|  |  | Annual consumption                             | kWh                              | -            | -                                   | -              | -           | -        | -     | -      | -    |
|  |  | Class  |                                  | -            | -                                   | -              | -           | -        | -     | -      | -    |
|  | Power factor                             | %  | -                                | -            | -                                   | 96             | 94          | 93       | -     | -      |      |
|  | Noise indoor                             | dB-A (H/M/L)                                   | 41/39/35                         |              |                                     | -              | -           | -        | -     | -      |      |
|  |  | Power Level dB                                 | 58/56/52                         |              |                                     | -              | -           | -        | -     | -      |      |
| Noise outdoor  | dB-A (H/L)                               | -  |                                  |              | 53/-                                |                |             | -        | -     |        |      |
|  | Power Level dB                           | -  |                                  |              | 70/-                                |                |             | -        | -     |        |      |
| H<br>E<br>A<br>T<br>I<br>N<br>G                          | Capacity                                 | kW   | 14.0                             | 14.0         | 14.0                                | -              | -           | -        | 4.1   | 16.0   |      |
|  |  | BTU/h  | 47800                            | 47800        | 47800                               | -              | -           | -        | 14000 | 54600  |      |
|  | Current                                  | A  | 0.54×3                           | 0.55×3       | 0.56×3                              | 17.3           | 16.8        | 16.3     | -     | -      |      |
|  |  | W  | 115×3                            | 120×3        | 125×3                               | 3.655k         | 3.655k      | 3.655k   | -     | -      |      |
|  | Input power                              | TOTAL W  | -                                |              |                                     | 4.000k         | 4.015k      | 4.030k   | 1050  | 5.400k |      |
|  |  | COP/COP CLASS                                  | TOTAL (W/W) *5 / ("A"-*G)        | -            | -                                   | -              | 3.50        | 3.49 / B | 3.47  | 3.90   | 2.96 |
|  | Erp *6                                   | Pdesign at -10°C                               | kW                               | -            | -                                   | -              | -           | 12.5     | -     | -      | -    |
|  |  | Tbivalent                                      | °C                               | -            | -                                   | -              | -           | -7       | -     | -      | -    |
|  |  | η <sub>s.h</sub>                               | %                                | -            | -                                   | -              | -           | 144.1    | -     | -      | -    |
|  |  | Annual consumption                             | kWh                              | -            | -                                   | -              | -           | -        | -     | -      | -    |
|  | Class                                    |  | -                                | -            | -                                   | -              | -           | -        | -     | -      |      |
|  | Power factor                             | %  | -                                | -            | -                                   | 96             | 95          | 93       | -     | -      |      |
|  | Noise indoor                             | dB-A (H/M/L)                                   | 41/39/35                         |              |                                     | -              | -           | -        | -     | -      |      |
|  |  | Power Level dB                                 | 58/56/52                         |              |                                     | -              | -           | -        | -     | -      |      |
| Noise outdoor  | dB-A (H/L)                               | -  |                                  |              | 53/-                                |                |             | -        | -     |        |      |
|  | Power Level dB                           | -  |                                  |              | 70/-                                |                |             | -        | -     |        |      |
| EXTRA LOW TEMP Total capacity(kW) / Input power(W) / COP |  | -  |                                  |              |                                     |                |             |          |       |        |      |
| Max Current(A) / Max Input power(W)                      |  | 0.74×3/165×3                                   | 0.76×3/180×3                     | 0.78×3/190×3 | 28.0/6.000k                         | 28.0/6.200k    | 28.0/6.400k | -        |       |        |      |
| Starting current(A) / Comp output(W)                     |  | -  | -                                | -            | 17.4/3.0k                           | 16.9/3.0k      | 16.4/3.0k   | -        |       |        |      |
| Network Impedance(ΩMAX.)                                 |  | -  |                                  |              |                                     |                |             |          |       |        |      |
| Fan motor output (Indoor/Outdoor) W                      |  | 85×3   |                                  |              | 90×2                                |                |             | -        |       |        |      |
| Moisture removal volume                                  |  | L/h(Pt/h)                                      | 7.9                              | (2.63×3)     | (16.6)                              | -              |             |          | -     |        |      |
| External static pressure                                 |  | Pa   | 50 (MIN10 - MAX80)               |              |                                     | -              |             |          | -     |        |      |
| Indoor Air flow  | Cooling                                  | m³/min (ft³/min)                               | [16/13/11 (565/459/388)]×3       |              |                                     | -              |             |          | -     |        |      |
|  | Heating                                  | m³/min (ft³/min)                               | [16/13/11 (565/459/388)]×3       |              |                                     | -              |             |          | -     |        |      |
| Outdoor Air flow   | Cooling                                  | m³/min (ft³/min)                               | -                                |              |                                     | 130            | (4591)      | -        |       |        |      |
|  | Heating                                  | m³/min (ft³/min)                               | -                                |              |                                     | 110            | (3885)      | -        |       |        |      |
| Refrigerant type / amount g(oz)                          |  | -  |                                  |              | R410A                               | 3.40k          | (119.9)     | -        |       |        |      |
| Product dimension  | Height                                   | mm(inch)                                       | 250 (9-27/32)                    |              |                                     | 1416 (55-3/4)  |             |          | -     |        |      |
|  | Width                                    | mm(inch)                                       | 780 (+100) (30-23/32) (+3-15/16) |              |                                     | 940 (37-1/32)  |             |          | -     |        |      |
|  | Depth                                    | mm(inch)                                       | 650 (25-19/32)                   |              |                                     | 340 (13-13/32) |             |          | -     |        |      |
| Packing dimension  | Height                                   | mm(inch)                                       | 345                              |              |                                     | 1556           |             |          | -     |        |      |
|  | Width                                    | mm(inch)                                       | 1007                             |              |                                     | 1055           |             |          | -     |        |      |
|  | Depth                                    | mm(inch)                                       | 777                              |              |                                     | 485            |             |          | -     |        |      |
| Weight   | (NET)                                    | kg(lb)   | 29 (64)                          |              |                                     | 98 (216)       |             |          | -     |        |      |
|  | (GROSS)                                  | kg(lb)   | 34 (75)                          |              |                                     | 108 (238)      |             |          | -     |        |      |
| Layers limit (actually)                                  |  | 8 (9)  |                                  |              | 1 (2)                               |                |             | -        |       |        |      |
| Operation condition                                      | Cool (DBT)                               | 18°C ~ 32°C                                    |                                  |              | -15°C ~ 46°C                        |                |             | -        |       |        |      |
|  | Heat (DBT)                               | 16°C ~ 30°C                                    |                                  |              | -20°C ~ 24°C                        |                |             | -        |       |        |      |
| P I P I N G  | Pipe diameter mm (inch)                  | (Liquid)ø6.35(1/4) (Gas)ø12.7(1/2)             |                                  |              | (Liquid)ø9.52(3/8) (Gas)ø15.88(5/8) |                |             | -        |       |        |      |
|  | Connecting method, Standard length m(ft) | flared type, 5.0(16.4)                         |                                  |              | flared type, 5.0(16.4)              |                |             | -        |       |        |      |
| Pipe length range  | m (ft)                                   | 5 ~ 75 (16.4 ~ 246.1)                          |                                  |              | -                                   |                |             | -        |       |        |      |
| Indoor unit & Outdoor unit height difference             | m (ft)                                   | 15 (OD located lower) / 30 (OD located higher) |                                  |              | (49.2/98.4)                         |                |             | -        |       |        |      |
| Add gas amount   | g/m (oz/ft)                              | 50   |                                  |              | (0.538)                             |                |             | -        |       |        |      |
| Pipe length for additional gas                           | m (ft)                                   | 20   |                                  |              | (65.6)                              |                |             | -        |       |        |      |

\*1: In case it is necessary to indicate the air flow volume in (l/s), the value in (m³/min.) shall be multiplied by 16.7 and rounded down the decimal point.

\*2: If the EUROVENT Certified models can be operated under the "extra-low" temperature condition, -7°C dry bulb and -8°C wet-bulb temperatures with rated voltage 230 V shall be used.

\*3: Network Impedance shall be applicable for EUROPE and CHINA models.

\*4: The annual consumption is calculated by multiplying the input power at 230 V (400 V) by an average of 500 hours per year in cooling mode.

\*5: EER and COP classification is at 230 V (400 V) only in accordance with EU directive 2002/31/EC.

\*6: SEER and SCOP classification is at 230V(400V) only in accordance with EN-14825. For heating, SCOP indicates the value of only Average heating season.

# Single -Type

## 1-1. Unit Specifications

PE2

### 5. Ducted Type S-50PN1E5A / U-50PE2E5A

| INDOOR                                |   | MODEL                                  | S-50PN1E5A                                      |                    |                | -                                  |            |        | -    |        |      |
|---------------------------------------|---|--|---|--------------------|----------------|------------------------------------|------------|--------|------|--------|------|
| PANEL                                 |   | MODEK                                  | -   |                    |                | -                                  |            |        | -    |        |      |
| OUTDOOR                               |   | MODEL                                  | -   |                    |                | U-50PE2E5A                         |            |        | -    |        |      |
| Branch pipe                           |   | MODEL                                  | -   |                    |                | -                                  |            |        | -    |        |      |
| Performance test condition            |   | ISO13253 / EN14511 / EN12102 / EN14825 |   |                    |                |                                    |            |        |      |        |      |
| Power supply                          |   | Ø, Hz                                  | 1ø 50Hz   |                    |                | 1ø 50Hz                            |            |        | Min  | Max    |      |
|                                       |   | V                                      | 220V  | 230V               | 240V           | 220V                               | 230V       | 240V   |      |        |      |
| C<br>O<br>O<br>L<br>I<br>N<br>G       | Capacity  | kW                                     | 5.0   | 5.0                | 5.0            | -                                  | -          | -      | 1.5  | 5.6    |      |
|                                       |   | BTU/h                                  | 17100   | 17100              | 17100          | -                                  | -          | -      | 5100 | 19100  |      |
|                                       | Current   | A                                      | 0.54  | 0.55               | 0.56           | 7.00                               | 6.65       | 6.35   | -    | -      |      |
|                                       |   | W                                      | 115   | 120                | 125            | 1.445k                             | 1.440k     | 1.435k | -    | -      |      |
|                                       | Input power   | TOTAL W                                | -   |                    |                | 1.560k                             | 1.560k     | 1.560k | 340  | 1.890k |      |
|                                       |   | Annual consumption                     | TOTAL kWh *4                                    | -                  |                |                                    | -          | 780    | -    | -      | -    |
|                                       | EER/EER CLASS                                       | TOTAL (W/W) <sup>5)</sup> ("A"~"G")    | -   | -                  | -              | 3.21                               | 3.21/A     | 3.21   | 4.41 | 2.96   |      |
|                                       | E <sub>rp</sub> <sup>*6)</sup>                      | Pdesign                                | kW  | -                  | -              | -                                  | -          | 5.0    | -    | -      | -    |
|                                       |   | SEER                                   | (W/W)   | -                  | -              | -                                  | -          | 4.6    | -    | -      | -    |
|                                       |   | Annual consumption                     | kWh   | -                  | -              | -                                  | -          | 380    | -    | -      | -    |
| Class                                 |   |  | -   | -                  | -              | -                                  | B          | -      | -    | -      |      |
| Power factor                          | %   | -                                      | -   | -                  | 94             | 94                                 | 94         | -      | -    |        |      |
| Noise indoor                          | dB-A (H/M/L)  | 41/39/35                               |   |                    | -              | -                                  | -          | -      | -    |        |      |
|                                       | Power Level dB                                      | 58/56/52                               |   |                    | -              | -                                  | -          | -      | -    |        |      |
| Noise outdoor                         | dB-A (H/L)  | -                                      |   |                    | 46/-           |                                    |            | -      | -    |        |      |
|                                       | Power Level dB                                      | -                                      |   |                    | 65/-           |                                    |            | -      | -    |        |      |
| H<br>E<br>A<br>T<br>I<br>N<br>G       | Capacity  | kW                                     | 5.6   | 5.6                | 5.6            | -                                  | -          | -      | 1.5  | 6.5    |      |
|                                       |   | BTU/h                                  | 19100   | 19100              | 19100          | -                                  | -          | -      | 5100 | 22200  |      |
|                                       | Current   | A                                      | 0.54  | 0.55               | 0.56           | 6.60                               | 6.30       | 6.05   | -    | -      |      |
|                                       |   | W                                      | 115   | 120                | 125            | 1.355k                             | 1.350k     | 1.345k | -    | -      |      |
|                                       | Input power   | TOTAL W                                | -   |                    |                | 1.470k                             | 1.470k     | 1.470k | 290  | 1.860k |      |
|                                       |   | COP/COP CLASS                          | TOTAL (W/W) <sup>5)</sup> ("A"~"G")             | -                  | -              | -                                  | 3.81       | 3.81/A | 3.81 | 5.17   | 3.49 |
|                                       | E <sub>rp</sub> <sup>*6)</sup>                      | Pdesign at -10°C                       | kW  | -                  | -              | -                                  | -          | 3.8    | -    | -      | -    |
|                                       |   | Tbivalent                              | °C  | -                  | -              | -                                  | -          | -10    | -    | -      | -    |
|                                       |   | SCOP                                   | (W/W)   | -                  | -              | -                                  | -          | 3.8    | -    | -      | -    |
|                                       |   | Annual consumption                     | kWh   | -                  | -              | -                                  | -          | 1400   | -    | -      | -    |
| Class                                 |   | -                                      | -   | -                  | -              | A                                  | -          | -      | -    |        |      |
| Power factor                          | %   | -                                      | -   | -                  | 93             | 93                                 | 93         | -      | -    |        |      |
| Noise indoor                          | dB-A (H/M/L)  | 41/39/35                               |   |                    | -              | -                                  | -          | -      | -    |        |      |
|                                       | Power Level dB                                      | 58/56/52                               |   |                    | -              | -                                  | -          | -      | -    |        |      |
| Noise outdoor                         | dB-A (H/L)  | -                                      |   |                    | 48/-           |                                    |            | -      | -    |        |      |
|                                       | Power Level dB                                      | -                                      |   |                    | 68/-           |                                    |            | -      | -    |        |      |
| EXTRA LOW TEMP                        | Total capacity(kW) / Input power(W) / COP           |  | -   |                    |                |                                    |            |        |      | -      |      |
| Max Current(A) / Max Input power(W)   |   | 0.74/165                               | 0.76/180  | 0.78/190           | 12.0/2.46k     | 12.0/2.57k                         | 12.0/2.68k | -      |      |        |      |
| Starting current(A) / Comp output(W)  |   | -                                      | -   | -                  | 7.00/1.5k      | 6.65/1.5k                          | 6.35/1.5k  | -      |      |        |      |
| Network Impedance(ΩMAX.)              |   | -                                      |   |                    |                |                                    |            |        |      |        |      |
| Fan motor output (Indoor/Outdoor) W   |   | 85                                     |   |                    | 60             |                                    |            | -      |      |        |      |
| Moisture removal volume               |   | L/h(Pt/h)                              |   | 2.8 (5.9)          |                | -                                  |            |        |      |        |      |
| External static pressure              |   | Pa                                     |   | 50 (MIN10 - MAX80) |                |                                    |            |        |      |        |      |
| Indoor Air flow                       | Cooling   | m³/min (ft³/min)                       | 16.0 / 13.0 / 11.0 (565) / (459) / (388)        |                    |                | -                                  |            |        |      |        |      |
|                                       | Heating   | m³/min (ft³/min)                       | 16.0 / 13.0 / 11.0 (565) / (459) / (388)        |                    |                | -                                  |            |        |      |        |      |
| Outdoor Air flow                      | Cooling   | m³/min (ft³/min)                       | -   |                    |                | 38 (1342)                          |            | -      |      |        |      |
|                                       | Heating   | m³/min (ft³/min)                       | -   |                    |                | 41 (1448)                          |            | -      |      |        |      |
| Refrigerant type / amount g(oz)       |   | -                                      |   |                    | R410A          | 1.40k (49.4)                       |            | -      |      |        |      |
| Product dimension                     | Height  | mm(inch)                               | 250 (9-27/32)                                   |                    | 619 (24-3/8)   |                                    | -          |        |      |        |      |
|                                       | Width   | mm(inch)                               | 780 [+100] (30-23/32 [+3-15/16])                |                    | 799 (31-29/64) |                                    | -          |        |      |        |      |
|                                       | Depth   | mm(inch)                               | 650 (25-19/32)                                  |                    | 299 (11-49/64) |                                    | -          |        |      |        |      |
| Product dimension (Panel)             |   | HxWxD mm, inch                         |   |                    |                |                                    |            |        |      |        |      |
| Packing dimension                     | Height  | mm(inch)                               | 345   |                    |                | 688                                |            |        | -    |        |      |
|                                       | Width   | mm(inch)                               | 1007  |                    |                | 931                                |            |        | -    |        |      |
|                                       | Depth   | mm(inch)                               | 777   |                    |                | 422                                |            |        | -    |        |      |
| Weight                                | (NET)   | kg(lb)                                 | 29 (64)   |                    | 39 (86)        |                                    | -          |        |      |        |      |
|                                       | (GROSS)   | kg(lb)                                 | 34 (75)   |                    | 44 (97)        |                                    | -          |        |      |        |      |
|                                       | Panel (NET)   | kg(lb)                                 | -   |                    |                |                                    |            |        |      | -      |      |
| Layers limit (actually)               |   | 8 (9)                                  |   |                    | 5 (6)          |                                    |            | -      |      |        |      |
| Operation condition                   | Cool (DBT)  | 18°C ~ 32°C                            |   |                    | -15°C ~ 46°C   |                                    |            | -      |      |        |      |
|                                       | Heat (DBT)  | 16°C ~ 30°C                            |   |                    | -20°C ~ 24°C   |                                    |            | -      |      |        |      |
| P<br>I<br>P<br>I<br>N<br>G            | Pipe diameter mm (inch)                             |  | (Liquid)ø6.35(1/4) (Gas)ø12.7(1/2)              |                    |                | (Liquid)ø6.35(1/4) (Gas)ø12.7(1/2) |            |        | -    |        |      |
|                                       | Connecting method, Standard length m(ft)            |  | flared type, 5.0(16.4)                          |                    |                | flared type, 5.0(16.4)             |            |        | -    |        |      |
|                                       | Pipe length range m (ft)                            |  | 3 ~ 40m (9.8 ~ 131.2)                           |                    |                | -                                  |            |        | -    |        |      |
|                                       | Indoor unit & Outdoor unit height difference m (ft) |  | 15m (OD located lower) /30m (OD located higher) |                    |                | (49.2/98.4)                        |            |        | -    |        |      |
|                                       | Add gas amount g/m (oz/ft)                          |  | 20g (0.215)                                     |                    |                | -                                  |            |        | -    |        |      |
| Pipe length for additional gas m (ft) |   | 30m (98.4)                             |   |                    | -              |                                    |            | -      |      |        |      |

\*1: In case it is necessary to indicate the air flow volume in (l/s), the value in (m³/min.) shall be multiplied by 16.7 and rounded down the decimal point.  
 \*2: If the EUROVENT Certified models can be operated under the "extra-low" temperature condition, -7°C dry bulb and -8°C wet-bulb temperatures with rated voltage 230 V shall be used.  
 \*3: Network Impedance shall be applicable for EUROPE and CHINA models.  
 \*4: The annual consumption is calculated by multiplying the input power at 230 V (400 V) by an average of 500 hours per year in cooling mode.  
 \*5: EER and COP classification is at 230 V (400 V) only in accordance with EU directive 2002/31/EC.  
 \*6: SEER and SCOP classification is at 230V(400V) only in accordance with EN-14825. For heating, SCOP indicates the value of only Average heating season, Other fiche data indicates in an attached sheet.

# Simultaneous (Twin) -Type

## 1-1. Unit Specifications

**PE1**

### 5. Ducted Type S-50PN1E5A×2 / U-100PE1E5A

| INDOOR   |  | MODEL  | S-50PN1E5A×2                     |              |                                     | -              |             |          | -     |        |      |
|--|--|--|----------------------------------|--------------|-------------------------------------|----------------|-------------|----------|-------|--------|------|
| OUTDOOR  |  | MODEL  | -                                |              |                                     | U-100PE1E5A    |             |          | -     |        |      |
| Branch pipe  |  | MODEL  | CZ-P155BK1                       |              |                                     |                |             |          |       |        |      |
| Performance test condition                               |  | ISO13253 / EN14511 / EN14825 / EN12102         |                                  |              |                                     |                |             |          |       |        |      |
| Power supply   |  | Ø, Hz  | 1ø 50Hz                          |              |                                     | 1ø 50Hz        |             |          |       |        |      |
|  |  | V  | 220                              | 230          | 240                                 | 220            | 230         | 240      | Min   | Max    |      |
| C<br>O<br>O<br>L<br>I<br>N<br>G                          | Capacity                                 | kW   | 10.0                             | 10.0         | 10.0                                | -              | -           | -        | 3.3   | 12.5   |      |
|  |  | BTU/h  | 34100                            | 34100        | 34100                               | -              | -           | -        | 11300 | 42700  |      |
|  | Current                                  | A  | 0.54×2                           | 0.55×2       | 0.56×2                              | 11.6           | 11.2        | 10.9     | -     | -      |      |
|  |  | W  | 115×2                            | 120×2        | 125×2                               | 2.465k         | 2.465k      | 2.465k   | -     | -      |      |
|  | Input power                              | TOTAL W  | -                                |              |                                     | 2.695k         | 2.705k      | 2.715k   | 870   | 3.800k |      |
|  |  | Annual consumption                             | TOTAL kWh *4                     | -            |                                     |                | -           | 1355     | -     | -      | -    |
|  | EER/EER CLASS                            | TOTAL (W/W) *5 / ("A"-*G)                      | -                                | -            | -                                   | 3.71           | 3.70 / A    | 3.68     | 3.79  | 3.29   |      |
|  | Erp *6                                   | Pdesign  | kW                               | -            | -                                   | -              | -           | 10.0     | -     | -      | -    |
|  |  | SEER   | (W/W)                            | -            | -                                   | -              | -           | 5.5      | -     | -      | -    |
|  |  | Annual consumption                             | kWh                              | -            | -                                   | -              | -           | 636      | -     | -      | -    |
|  |  | Class  |                                  | -            | -                                   | -              | -           | A        | -     | -      | -    |
|  | Power factor                             | %  | -                                | -            | -                                   | 97             | 96          | 94       | -     | -      |      |
|  | Noise indoor                             | dB-A (H/M/L)                                   | 41/39/35                         |              |                                     | -              | -           | -        | -     | -      |      |
|  |  | Power Level dB                                 | 58/56/52                         |              |                                     | -              | -           | -        | -     | -      |      |
| Noise outdoor  | dB-A (H/L)                               | -  |                                  |              | -                                   | 52/-           | -           | -        | -     |        |      |
|  | Power Level dB                           | -  |                                  |              | -                                   | 69/-           | -           | -        | -     |        |      |
| H<br>E<br>A<br>T<br>I<br>N<br>G                          | Capacity                                 | kW   | 11.2                             | 11.2         | 11.2                                | -              | -           | -        | 4.1   | 14.0   |      |
|  |  | BTU/h  | 38200                            | 38200        | 38200                               | -              | -           | -        | 14000 | 47800  |      |
|  | Current                                  | A  | 0.54×2                           | 0.55×2       | 0.56×2                              | 12.8           | 12.5        | 12.2     | -     | -      |      |
|  |  | W  | 115×2                            | 120×2        | 125×2                               | 2.745k         | 2.745k      | 2.745k   | -     | -      |      |
|  | Input power                              | TOTAL W  | -                                |              |                                     | 2.975k         | 2.985k      | 2.995k   | 980   | 4.500k |      |
|  |  | COP/COP CLASS                                  | TOTAL (W/W) *5 / ("A"-*G)        | -            | -                                   | -              | 3.76        | 3.75 / A | 3.74  | 4.18   | 3.11 |
|  | Erp *6                                   | Pdesign at -10°C                               | kW                               | -            | -                                   | -              | -           | 10.0     | -     | -      | -    |
|  |  | Tbivalent                                      | °C                               | -            | -                                   | -              | -           | -10      | -     | -      | -    |
|  |  | SCOP   | (W/W)                            | -            | -                                   | -              | -           | 3.8      | -     | -      | -    |
|  |  | Annual consumption                             | kWh                              | -            | -                                   | -              | -           | 3670     | -     | -      | -    |
|  | Class                                    |  | -                                | -            | -                                   | -              | A           | -        | -     | -      |      |
|  | Power factor                             | %  | -                                | -            | -                                   | 97             | 95          | 94       | -     | -      |      |
|  | Noise indoor                             | dB-A (H/M/L)                                   | 41/39/35                         |              |                                     | -              | -           | -        | -     | -      |      |
|  |  | Power Level dB                                 | 58/56/52                         |              |                                     | -              | -           | -        | -     | -      |      |
| Noise outdoor  | dB-A (H/L)                               | -  |                                  |              | -                                   | 52/-           | -           | -        | -     |        |      |
|  | Power Level dB                           | -  |                                  |              | -                                   | 69/-           | -           | -        | -     |        |      |
| EXTRA LOW TEMP Total capacity(kW) / Input power(W) / COP |  | -  |                                  |              |                                     |                |             |          |       |        |      |
| Max Current(A) / Max Input power(W)                      |  | 0.74×2/165×2                                   | 0.76×2/180×2                     | 0.78×2/190×2 | 25.0/5.350k                         | 25.0/5.550k    | 25.0/5.750k | -        |       |        |      |
| Starting current(A) / Comp output(W)                     |  | -  | -                                | -            | 12.8/3.0k                           | 12.5/3.0k      | 12.2/3.0k   | -        |       |        |      |
| Network Impedance(ΩMAX.)                                 |  | -  |                                  |              |                                     |                |             |          |       |        |      |
| Fan motor output (Indoor/Outdoor) W                      |  | 85×2   |                                  |              | 90×2                                |                |             | -        |       |        |      |
| Moisture removal volume                                  |  | L/h(Pt/h)                                      | 6.0                              | (3.0×2)      | (12.6)                              | -              |             |          | -     |        |      |
| External static pressure                                 |  | Pa   | 50 (MIN10 - MAX80)               |              |                                     | -              |             |          | -     |        |      |
| Indoor Air flow  | Cooling                                  | m³/min (ft³/min)                               | [16/13/11 (565/459/388)]×2       |              |                                     | -              |             |          | -     |        |      |
|  | Heating                                  | m³/min (ft³/min)                               | [16/13/11 (565/459/388)]×2       |              |                                     | -              |             |          | -     |        |      |
| Outdoor Air flow   | Cooling                                  | m³/min (ft³/min)                               | -                                |              |                                     | 110            | (3885)      | -        |       |        |      |
|  | Heating                                  | m³/min (ft³/min)                               | -                                |              |                                     | 95             | (3355)      | -        |       |        |      |
| Refrigerant type / amount g(oz)                          |  | -  |                                  |              | R410A                               | 3.40k          | (119.9)     | -        |       |        |      |
| Product dimension  | Height                                   | mm(inch)                                       | 250 (9-27/32)                    |              |                                     | 1416 (55-3/4)  |             |          | -     |        |      |
|  | Width                                    | mm(inch)                                       | 780 (+100) (30-23/32) (+3-15/16) |              |                                     | 940 (37-1/32)  |             |          | -     |        |      |
|  | Depth                                    | mm(inch)                                       | 650 (25-19/32)                   |              |                                     | 340 (13-13/32) |             |          | -     |        |      |
| Packing dimension  | Height                                   | mm(inch)                                       | 345                              |              |                                     | 1556           |             |          | -     |        |      |
|  | Width                                    | mm(inch)                                       | 1007                             |              |                                     | 1055           |             |          | -     |        |      |
|  | Depth                                    | mm(inch)                                       | 777                              |              |                                     | 485            |             |          | -     |        |      |
| Weight   | (NET)                                    | kg(lb)   | 29 (64)                          |              |                                     | 98 (216)       |             |          | -     |        |      |
|  | (GROSS)                                  | kg(lb)   | 34 (75)                          |              |                                     | 108 (238)      |             |          | -     |        |      |
| Layers limit (actually)                                  |  | 8 (9)  |                                  |              | 1 (2)                               |                |             | -        |       |        |      |
| Operation condition                                      | Cool (DBT)                               | 18°C ~ 32°C                                    |                                  |              | -15°C ~ 46°C                        |                |             | -        |       |        |      |
|  | Heat (DBT)                               | 16°C ~ 30°C                                    |                                  |              | -20°C ~ 24°C                        |                |             | -        |       |        |      |
| P I P I N G  | Pipe diameter mm (inch)                  | (Liquid)ø6.35(1/4) (Gas)ø12.7(1/2)             |                                  |              | (Liquid)ø9.52(3/8) (Gas)ø15.88(5/8) |                |             | -        |       |        |      |
|  | Connecting method, Standard length m(ft) | flared type, 5.0(16.4)                         |                                  |              | flared type, 5.0(16.4)              |                |             | -        |       |        |      |
| Pipe length range m (ft)                                 |  | 5 ~ 75 (16.4 ~ 246.1)                          |                                  |              | -                                   |                |             | -        |       |        |      |
| Indoor unit & Outdoor unit height difference m (ft)      |  | 15 (OD located lower) / 30 (OD located higher) |                                  |              | (49.2/98.4)                         |                |             | -        |       |        |      |
| Add gas amount g/m (oz/ft)                               |  | 50   |                                  |              | (0.538)                             |                |             | -        |       |        |      |
| Pipe length for additional gas m (ft)                    |  | 30   |                                  |              | (98.4)                              |                |             | -        |       |        |      |

\*1: In case it is necessary to indicate the air flow volume in (l/s), the value in (m³/min.) shall be multiplied by 16.7 and rounded down the decimal point.

\*2: If the EUROVENT Certified models can be operated under the "extra-low" temperature condition, -7°C dry bulb and -8°C wet-bulb temperatures with rated voltage 230 V shall be used.

\*3: Network Impedance shall be applicable for EUROPE and CHINA models.

\*4: The annual consumption is calculated by multiplying the input power at 230 V (400 V) by an average of 500 hours per year in cooling mode.

\*5: EER and COP classification is at 230 V (400 V) only in accordance with EU directive 2002/31/EC.

\*6: SEER and SCOP classification is at 230V(400V) only in accordance with EN-14825. For heating, SCOP indicates the value of only Average heating season, Other fiche data indicates in an attached sheet.

# Simultaneous (Triple) -Type

## 1-1. Unit Specifications

**PE1**

### 5. Ducted Type S-50PN1E5A×3 / U-140PE1E5A

| INDOOR   |  | MODEL                                  | S-50PN1E5A×3                       |  |              | -                                   |             |          | -     |        |      |
|--|--|--|------------------------------------|--|--------------|-------------------------------------|-------------|----------|-------|--------|------|
| OUTDOOR  |  | MODEL                                  | -                                  |  |              | U-140PE1E5A                         |             |          | -     |        |      |
| Branch pipe  |  | MODEL                                  | CZ-P3HPC2                          |  |              |                                     |             |          |       |        |      |
| Performance test condition                               |  | ISO13253 / EN14511 / EN12102 / EN14825 |                                    |  |              |                                     |             |          |       |        |      |
| Power supply   |  | Ø, Hz                                  | 1ø 50Hz                            |  |              | 1ø 50Hz                             |             |          |       |        |      |
|  |  | V                                      | 220                                | 230  | 240          | 220                                 | 230         | 240      | Min   | Max    |      |
| C<br>O<br>O<br>L<br>I<br>N<br>G                          | Capacity                                 | kW                                     | 14.0                               | 14.0   | 14.0         | -                                   | -           | -        | 3.3   | 15.5   |      |
|  |  | BTU/h                                  | 47800                              | 47800  | 47800        | -                                   | -           | -        | 11300 | 52900  |      |
|  | Current                                  | A                                      | 0.54×3                             | 0.55×3   | 0.56×3       | 20.5                                | 20.1        | 19.5     | -     | -      |      |
|  |  | W                                      | 115×3                              | 120×3  | 125×3        | 4.400k                              | 4.400k      | 4.400k   | -     | -      |      |
|  | Input power                              | TOTAL W                                | -                                  |  |              | 4.745k                              | 4.760k      | 4.775k   | 1000  | 6.200k |      |
|  |  | Annual consumption                     | TOTAL kWh *4                       | -  |              |                                     | -           | 2380     | -     | -      | -    |
|  | EER/EER CLASS                            |  | TOTAL (W/W) *5 / ("A"-*G)          | -  | -            | -                                   | 2.95        | 2.94 / C | 2.93  | 3.30   | 2.50 |
|  | Erp *6                                   | Pdesign                                | kW                                 | -  | -            | -                                   | -           | 14.0     | -     | -      | -    |
|  |  | η <sub>s.c</sub>                       | %                                  | -  | -            | -                                   | -           | 219.8    | -     | -      | -    |
|  |  | Annual consumption                     | kWh                                | -  | -            | -                                   | -           | -        | -     | -      | -    |
|  |  | Class                                  |                                    | -  | -            | -                                   | -           | -        | -     | -      | -    |
|  | Power factor                             |  | %                                  | -  | -            | -                                   | 98          | 95       | 94    | -      | -    |
| Noise indoor   | dB-A (H/M/L)                             | 41/39/35                               |                                    |  | -            | -                                   | -           | -        | -     |        |      |
|  | Power Level dB                           | 58/56/52                               |                                    |  | -            | -                                   | -           | -        | -     |        |      |
| Noise outdoor  | dB-A (H/L)                               | -                                      |                                    |  | 54/-         |                                     |             | -        | -     |        |      |
|  | Power Level dB                           | -                                      |                                    |  | 71/-         |                                     |             | -        | -     |        |      |
| H<br>E<br>A<br>T<br>I<br>N<br>G                          | Capacity                                 | kW                                     | 16.0                               | 16.0   | 16.0         | -                                   | -           | -        | 4.1   | 18.0   |      |
|  |  | BTU/h                                  | 54600                              | 54600  | 54600        | -                                   | -           | -        | 14000 | 61400  |      |
|  | Current                                  | A                                      | 0.54×3                             | 0.55×3   | 0.56×3       | 20.6                                | 20.2        | 19.6     | -     | -      |      |
|  |  | W                                      | 115×3                              | 120×3  | 125×3        | 4.440k                              | 4.440k      | 4.440k   | -     | -      |      |
|  | Input power                              | TOTAL W                                | -                                  |  |              | 4.785k                              | 4.800k      | 4.815k   | 1050  | 6.100k |      |
|  |  | COP/COP CLASS                          | TOTAL (W/W) *5 / ("A"-*G)          | -  | -            | -                                   | 3.34        | 3.33 / C | 3.32  | 3.90   | 2.95 |
|  | Erp *6                                   | Pdesign at -10°C                       | kW                                 | -  | -            | -                                   | -           | 14.0     | -     | -      | -    |
|  |  | Tbivalent                              | °C                                 | -  | -            | -                                   | -           | -7       | -     | -      | -    |
|  |  | η <sub>s.h</sub>                       | %                                  | -  | -            | -                                   | -           | 140.7    | -     | -      | -    |
|  |  | Annual consumption                     | kWh                                | -  | -            | -                                   | -           | -        | -     | -      | -    |
|  | Power factor                             |  | %                                  | -  | -            | -                                   | 98          | 96       | 94    | -      | -    |
|  | Noise indoor                             | dB-A (H/M/L)                           | 41/39/35                           |  |              | -                                   | -           | -        | -     | -      |      |
| Power Level dB   |  | 58/56/52                               |                                    |  | -            | -                                   | -           | -        | -     |        |      |
| Noise outdoor  | dB-A (H/L)                               | -                                      |                                    |  | 55/-         |                                     |             | -        | -     |        |      |
|  | Power Level dB                           | -                                      |                                    |  | 71/-         |                                     |             | -        | -     |        |      |
| EXTRA LOW TEMP Total capacity(kW) / Input power(W) / COP |  | -                                      |                                    |  |              |                                     |             |          |       |        |      |
| Max Current(A) / Max Input power(W)                      |  | 0.74×3/165×3                           | 0.76×3/180×3                       | 0.78×3/190×3                                   | 30.0/6.450k  | 30.0/6.650k                         | 30.0/6.850k | -        |       |        |      |
| Starting current(A) / Comp output(W)                     |  | -                                      | -                                  | -  | 20.6/3.0k    | 20.2/3.0k                           | 19.6/3.0k   | -        |       |        |      |
| Network Impedance(ΩMAX.)                                 |  | -                                      |                                    |  |              |                                     |             |          |       |        |      |
| Fan motor output (Indoor/Outdoor) W                      |  | 85×3                                   |                                    |  | 90×2         |                                     |             | -        |       |        |      |
| Moisture removal volume                                  |  | L/h(Pt/h)                              | 9.0                                | (3.0×3)  | (18.9)       | -                                   |             |          | -     |        |      |
| External static pressure                                 |  | Pa                                     | 50 (MIN10 - MAX80)                 |  |              | -                                   |             |          | -     |        |      |
| Indoor Air flow  | Cooling                                  | m³/min (ft³/min)                       | [16/13/11 (565/459/388)]×3         |  |              | -                                   |             |          | -     |        |      |
|  | Heating                                  | m³/min (ft³/min)                       | [16/13/11 (565/459/388)]×3         |  |              | -                                   |             |          | -     |        |      |
| Outdoor Air flow   | Cooling                                  | m³/min (ft³/min)                       | -                                  |  |              | 135                                 | (4767)      | -        |       |        |      |
|  | Heating                                  | m³/min (ft³/min)                       | -                                  |  |              | 120                                 | (4238)      | -        |       |        |      |
| Refrigerant type / amount g(oz)                          |  | -                                      |                                    |  | R410A        | 3.40k                               | (119.9)     | -        |       |        |      |
| Product dimension  | Height                                   | mm(inch)                               | 250 (9-27/32)                      |  |              | 1416 (55-3/4)                       |             |          | -     |        |      |
|  | Width                                    | mm(inch)                               | 780 (+100) (30-23/32) (+3-15/16)   |  |              | 940 (37-1/32)                       |             |          | -     |        |      |
|  | Depth                                    | mm(inch)                               | 650 (25-19/32)                     |  |              | 340 (13-13/32)                      |             |          | -     |        |      |
| Packing dimension  | Height                                   | mm(inch)                               | 345                                |  |              | 1556                                |             |          | -     |        |      |
|  | Width                                    | mm(inch)                               | 1007                               |  |              | 1055                                |             |          | -     |        |      |
|  | Depth                                    | mm(inch)                               | 777                                |  |              | 485                                 |             |          | -     |        |      |
| Weight   | (NET)                                    | kg(lb)                                 | 29 (64)                            |  |              | 98 (216)                            |             |          | -     |        |      |
|  | (GROSS)                                  | kg(lb)                                 | 34 (75)                            |  |              | 108 (238)                           |             |          | -     |        |      |
| Layers limit (actually)                                  |  | 8 (9)                                  |                                    |  | 1 (2)        |                                     |             | -        |       |        |      |
| Operation condition                                      | Cool (DBT)                               | 18°C ~ 32°C                            |                                    |  | -15°C ~ 46°C |                                     |             | -        |       |        |      |
|  | Heat (DBT)                               | 16°C ~ 30°C                            |                                    |  | -20°C ~ 24°C |                                     |             | -        |       |        |      |
| P<br>I<br>P<br>I<br>N<br>G                               | Pipe diameter mm (inch)                  |  | (Liquid)ø6.35(1/4) (Gas)ø12.7(1/2) |  |              | (Liquid)ø9.52(3/8) (Gas)ø15.88(5/8) |             |          | -     |        |      |
|  | Connecting method, Standard length m(ft) |  | flared type, 5.0(16.4)             |  |              | flared type, 5.0(16.4)              |             |          | -     |        |      |
| Pipe length range  |  | m (ft)                                 |                                    | 5 ~ 75 (16.4 ~ 246.1)                          |              | -                                   |             |          |       |        |      |
| Indoor unit & Outdoor unit height difference             |  | m (ft)                                 |                                    | 15 (OD located lower) / 30 (OD located higher) |              | (49.2/98.4)                         |             | -        |       |        |      |
| Add gas amount   |  | g/m (oz/ft)                            |                                    | 50 (0.538)                                     |              | -                                   |             |          |       |        |      |
| Pipe length for additional gas                           |  | m (ft)                                 |                                    | 20 (65.6)                                      |              | -                                   |             |          |       |        |      |

\*1: In case it is necessary to indicate the air flow volume in (l/s), the value in (m³/min.) shall be multiplied by 16.7 and rounded down the decimal point.

\*2: If the EUROVENT Certified models can be operated under the "extra-low" temperature condition, -7°C dry bulb and -8°C wet-bulb temperatures with rated voltage 230 V shall be used.

\*3: Network Impedance shall be applicable for EUROPE and CHINA models.

\*4: The annual consumption is calculated by multiplying the input power at 230 V (400 V) by an average of 500 hours per year in cooling mode.

\*5: EER and COP classification is at 230 V (400 V) only in accordance with EU directive 2002/31/EC.

\*6: SEER and SCOP classification is at 230V(400V) only in accordance with EN-14825. For heating, SCOP indicates the value of only Average heating season.

# Single -Type

## 1-1. Unit Specifications

**PE2**

### 5. Ducted Type S-60PN1E5A / U-60PE2E5A

| INDOOR   |   | MODEL                                  | S-60PN1E5A                                       |                      |              | -                                   |            |        | -    |        |      |
|--|---|--|--|----------------------|--------------|-------------------------------------|------------|--------|------|--------|------|
| OUTDOOR  |   | MODEL                                  | -  |                      |              | U-60PE2E5A                          |            |        | -    |        |      |
| Branch pipe  |   | MODEL                                  | -  |                      |              | -                                   |            |        | -    |        |      |
| Performance test condition                               |   | ISO13253 / EN14511 / EN12102 / EN14825 |  |                      |              |                                     |            |        |      |        |      |
| Power supply   |   | Ø, Hz                                  | 1ø 50Hz  |                      |              | 1ø 50Hz                             |            |        | Min  | Max    |      |
|  |   | V                                      | 220V   | 230V                 | 240V         | 220V                                | 230V       | 240V   |      |        |      |
| C<br>O<br>O<br>L<br>I<br>N<br>G                          | Capacity  | kW                                     | 6.0  | 6.0                  | 6.0          | -                                   | -          | -      | 2.0  | 7.1    |      |
|  |   | BTU/h                                  | 20500  | 20500                | 20500        | -                                   | -          | -      | 6800 | 24200  |      |
|  | Current   | A                                      | 1.12   | 1.08                 | 1.04         | 8.60                                | 8.30       | 7.90   | -    | -      |      |
|  |   | W                                      | 140  | 140                  | 140          | 1.710k                              | 1.710k     | 1.710k | -    | -      |      |
|  | Input power   | TOTAL W                                | -  |                      |              | 1.850k                              | 1.850k     | 1.850k | 400  | 2.550k |      |
|  |   | Annual consumption                     | TOTAL kWh *4                                     | -                    |              |                                     | -          | 925    | -    | -      | -    |
|  | EER/EER CLASS                                       | TOTAL (W/W) <sup>15</sup> / ("A"-°G)   | -  | -                    | -            | 3.24                                | 3.24/A     | 3.24   | 5.00 | 2.78   |      |
|  | Erp <sup>16</sup>                                   | Pdesign                                | kW   | -                    | -            | -                                   | -          | 6.0    | -    | -      | -    |
|  |   | SEER                                   | (W/W)  | -                    | -            | -                                   | -          | 5.5    | -    | -      | -    |
|  |   | Annual consumption                     | kWh  | -                    | -            | -                                   | -          | 382    | -    | -      | -    |
|  |   | Class                                  |  | -                    | -            | -                                   | -          | A      | -    | -      | -    |
|  | Power factor  | %                                      | -  | -                    | -            | 90                                  | 90         | 90     | -    | -      |      |
|  | Noise indoor  | dB-A (H/M/L)                           | 43/41/36   |                      |              | -                                   | -          | -      | -    | -      |      |
|  |   | Power Level dB                         | 60/58/53   |                      |              | -                                   | -          | -      | -    | -      |      |
| Noise outdoor  | dB-A (H/L)  | -                                      |  |                      | -            | 46/-                                | -          | -      | -    |        |      |
|  | Power Level dB                                      | -                                      |  |                      | -            | 65/-                                | -          | -      | -    |        |      |
| H<br>E<br>A<br>T<br>I<br>N<br>G                          | Capacity  | kW                                     | 7.0  | 7.0                  | 7.0          | -                                   | -          | -      | 1.8  | 8.0    |      |
|  |   | BTU/h                                  | 23900  | 23900                | 23900        | -                                   | -          | -      | 6100 | 27300  |      |
|  | Current   | A                                      | 1.12   | 1.08                 | 1.04         | 8.75                                | 8.35       | 8.00   | -    | -      |      |
|  |   | W                                      | 140  | 140                  | 140          | 1.730k                              | 1.730k     | 1.730k | -    | -      |      |
|  | Input power   | TOTAL W                                | -  |                      |              | 1.870k                              | 1.870k     | 1.870k | 350  | 2.200k |      |
|  |   | COP/COP CLASS                          | TOTAL (W/W) <sup>15</sup> / ("A"-°G)             | -                    | -            | -                                   | 3.74       | 3.74/A | 3.74 | 5.14   | 3.64 |
|  | Erp <sup>16</sup>                                   | Pdesign at -10°C                       | kW   | -                    | -            | -                                   | -          | 5.6    | -    | -      | -    |
|  |   | Tbivalent                              | °C   | -                    | -            | -                                   | -          | -9     | -    | -      | -    |
|  |   | SCOP                                   | (W/W)  | -                    | -            | -                                   | -          | 3.8    | -    | -      | -    |
|  |   | Annual consumption                     | kWh  | -                    | -            | -                                   | -          | 2061   | -    | -      | -    |
|  | Class   |  | -  | -                    | -            | -                                   | A          | -      | -    | -      |      |
|  | Power factor  | %                                      | -  | -                    | -            | 90                                  | 90         | 90     | -    | -      |      |
|  | Noise indoor  | dB-A (H/M/L)                           | 43/41/36   |                      |              | -                                   | -          | -      | -    | -      |      |
|  |   | Power Level dB                         | 60/58/53   |                      |              | -                                   | -          | -      | -    | -      |      |
| Noise outdoor  | dB-A (H/L)  | -                                      |  |                      | -            | 49/-                                | -          | -      | -    |        |      |
|  | Power Level dB                                      | -                                      |  |                      | -            | 69/-                                | -          | -      | -    |        |      |
| EXTRA LOW TEMP Total capacity(kW) / Input power(W) / COP |   | -                                      |  |                      |              |                                     |            |        |      |        |      |
| Max Current(A) / Max Input power(W)                      |   | 1.28/160                               | 1.24/160   | 1.20/160             | 16.5/3.27k   | 16.5/3.42k                          | 16.5/3.57k | -      |      |        |      |
| Starting current(A) / Comp output(W)                     |   | -                                      | -  | -                    | 8.75/1.7k    | 8.35/1.7k                           | 8.00/1.7k  | -      |      |        |      |
| Network Impedance(ΩMAX.)                                 |   | -                                      |  |                      |              |                                     |            |        |      |        |      |
| Fan motor output (Indoor/Outdoor) W                      |   | 120                                    |  |                      | 60           |                                     |            | -      |      |        |      |
| Moisture removal volume                                  |   | L/h(P/h)                               | 3.4  | (7.1)                |              | -                                   |            |        | -    |        |      |
| External static pressure                                 |   | Pa                                     | 50 (MIN10 - MAX80)                               |                      |              | -                                   |            |        | -    |        |      |
| Indoor Air flow  | Cooling   | m³/min (ft³/min)                       | 22.0 / 20.0 / 16.0 (777) / (706) / (565)         |                      |              | -                                   |            |        | -    |        |      |
|  | Heating   | m³/min (ft³/min)                       | 22.0 / 20.0 / 16.0 (777) / (706) / (565)         |                      |              | -                                   |            |        | -    |        |      |
| Outdoor Air flow   | Cooling   | m³/min (ft³/min)                       | -  |                      |              | 38                                  | (1342)     | -      |      |        |      |
|  | Heating   | m³/min (ft³/min)                       | -  |                      |              | 41                                  | (1448)     | -      |      |        |      |
| Refrigerant type / amount g(oz)                          |   | -                                      |  |                      | R410A        | 1.95k                               | (68.8)     | -      |      |        |      |
| Product dimension  | Height  | mm(inch)                               | 250  | (9-27/32)            |              | 619                                 | (24-3/8)   | -      |      |        |      |
|  | Width   | mm(inch)                               | 1000 [+100]                                      | (39-5/16 [+3-15/16]) |              | 799                                 | (31-29/64) | -      |      |        |      |
|  | Depth   | mm(inch)                               | 650  | (25-19/32)           |              | 299                                 | (11-49/64) | -      |      |        |      |
| Product dimension (Panel)                                |   | H×W×D mm, inch                         | -  |                      |              | -                                   |            |        | -    |        |      |
| Packing dimension  | Height  | mm(inch)                               | 338  |                      |              | 688                                 |            |        | -    |        |      |
|  | Width   | mm(inch)                               | 1211   |                      |              | 931                                 |            |        | -    |        |      |
|  | Depth   | mm(inch)                               | 761  |                      |              | 422                                 |            |        | -    |        |      |
| Weight   | (NET)   | kg(lb)                                 | 32   | (71)                 |              | 40                                  | (88)       | -      |      |        |      |
|  | (GROSS)   | kg(lb)                                 | 38   | (84)                 |              | 45                                  | (99)       | -      |      |        |      |
|  | Panel (NET)   | kg(lb)                                 | -  |                      |              | -                                   |            |        | -    |        |      |
| Layers limit (actually)                                  |   | 6 (7)                                  |  |                      | 5 (6)        |                                     |            | -      |      |        |      |
| Operation condition                                      | Cool (DBT)  | 18°C ~ 32°C                            |  |                      | -15°C ~ 46°C |                                     |            | -      |      |        |      |
|  | Heat (DBT)  | 16°C ~ 30°C                            |  |                      | -20°C ~ 24°C |                                     |            | -      |      |        |      |
| P<br>I<br>P<br>I<br>N<br>G                               | Pipe diameter mm (inch)                             |  | (Liquid)ø9.52(3/8) (Gas)ø15.88(5/8)              |                      |              | (Liquid)ø9.52(3/8) (Gas)ø15.88(5/8) |            |        | -    |        |      |
|  | Connecting method, Standard length m(ft)            |  | flared type, 5.0(16.4)                           |                      |              | flared type, 5.0(16.4)              |            |        | -    |        |      |
|  | Pipe length range m (ft)                            |  | 3 ~ 40m (9.8 ~ 131.2)                            |                      |              |                                     |            |        | -    |        |      |
|  | Indoor unit & Outdoor unit height difference m (ft) |  | 15m (OD located lower) / 30m (OD located higher) |                      |              | (49.2/98.4)                         |            |        | -    |        |      |
|  | Add gas amount g/m (oz/ft)                          |  | 40g (0.430)                                      |                      |              |                                     |            |        | -    |        |      |
| Pipe length for additional gas m (ft)                    |   | 30m (98.4)                             |  |                      |              |                                     |            | -      |      |        |      |

\*1: In case it is necessary to indicate the air flow volume in (l/s), the value in (m³/min.) shall be multiplied by 16.7 and rounded down the decimal point.

\*2: If the EUROVENT Certified models can be operated under the "extra-low" temperature condition, -7°C dry bulb and -8°C wet-bulb temperatures with rated voltage 230 V shall be used.

\*3: Network Impedance shall be applicable for EUROPE and CHINA models.

\*4: The annual consumption is calculated by multiplying the input power at 230V (400V) by an average of 500 hours per year in cooling mode.

\*5: EER and COP classification is at 230V (400V) only in accordance with EU directive 2002/31/EC.

\*6: SEER and SCOP classification is at 230V (400V) only in accordance with EN-14825. For heating, SCOP indicates the value of only Average heating season, Other fiche data indicates in an attached sheet.

# Simultaneous (Twin) -Type

## 1-1. Unit Specifications

PE1

### 5. Ducted Type S-60PN1E5A×2 / U-125PE1E5A

| INDOOR   |  | MODEL                                  | S-60PN1E5A×2                        |  |              | -                                   |             |          | -     |        |      |
|--|--|--|-------------------------------------|--|--------------|-------------------------------------|-------------|----------|-------|--------|------|
| OUTDOOR  |  | MODEL                                  | -                                   |  |              | U-125PE1E5A                         |             |          | -     |        |      |
| Branch pipe  |  | MODEL                                  | CZ-P155BK1                          |  |              |                                     |             |          |       |        |      |
| Performance test condition                               |  | ISO13253 / EN14511 / EN12102 / EN14825 |                                     |  |              |                                     |             |          |       |        |      |
| Power supply   |  | Ø, Hz                                  | 1ø 50Hz                             |  |              | 1ø 50Hz                             |             |          |       |        |      |
|  |  | V                                      | 220                                 | 230  | 240          | 220                                 | 230         | 240      | Min   | Max    |      |
| C<br>O<br>O<br>L<br>I<br>N<br>G                          | Capacity                                 | kW                                     | 12.5                                | 12.5   | 12.5         | -                                   | -           | -        | 3.3   | 14.0   |      |
|  |  | BTU/h                                  | 42700                               | 42700  | 42700        | -                                   | -           | -        | 11300 | 47800  |      |
|  | Current                                  | A                                      | 1.12×2                              | 1.08×2   | 1.04×2       | 17.4                                | 16.9        | 16.4     | -     | -      |      |
|  |  | W                                      | 140×2                               | 140×2  | 140×2        | 3.665k                              | 3.665k      | 3.665k   | -     | -      |      |
|  | Input power                              | TOTAL W                                | -                                   |  |              | 3.945k                              | 3.945k      | 3.945k   | 1000  | 4.800k |      |
|  |  | Annual consumption                     | TOTAL kWh *4                        | -  |              |                                     | -           | 1975     | -     | -      | -    |
|  | EER/EER CLASS                            |  | TOTAL (W/W) *5 / ("A"-*G)           | -  | -            | -                                   | 3.17        | 3.17 / B | 3.17  | 3.30   | 2.92 |
|  | Erp *6                                   | Pdesign                                | kW                                  | -  | -            | -                                   | -           | 12.5     | -     | -      | -    |
|  |  | η <sub>s.c</sub>                       | %                                   | -  | -            | -                                   | -           | 229.0    | -     | -      | -    |
|  |  | Annual consumption                     | kWh                                 | -  | -            | -                                   | -           | -        | -     | -      | -    |
| Class  |  |  | -                                   | -  | -            | -                                   | -           | -        | -     | -      |      |
| Power factor   |  | %                                      | -                                   | -  | -            | 96                                  | 94          | 93       | -     | -      |      |
| Noise indoor   | dB-A (H/M/L)                             | 43/41/36                               |                                     |  | -            | -                                   | -           | -        | -     |        |      |
|  | Power Level dB                           | 60/58/53                               |                                     |  | -            | -                                   | -           | -        | -     |        |      |
| Noise outdoor  | dB-A (H/L)                               | -                                      |                                     |  | -            | 53/-                                |             | -        | -     |        |      |
|  | Power Level dB                           | -                                      |                                     |  | -            | 70/-                                |             | -        | -     |        |      |
| H<br>E<br>A<br>T<br>I<br>N<br>G                          | Capacity                                 | kW                                     | 14.0                                | 14.0   | 14.0         | -                                   | -           | -        | 4.1   | 16.0   |      |
|  |  | BTU/h                                  | 47800                               | 47800  | 47800        | -                                   | -           | -        | 14000 | 54600  |      |
|  | Current                                  | A                                      | 1.12×2                              | 1.08×2   | 1.04×2       | 17.3                                | 16.8        | 16.3     | -     | -      |      |
|  |  | W                                      | 140×2                               | 140×2  | 140×2        | 3.655k                              | 3.655k      | 3.655k   | -     | -      |      |
|  | Input power                              | TOTAL W                                | -                                   |  |              | 3.935k                              | 3.935k      | 3.935k   | 1050  | 5.400k |      |
|  |  | COP/COP CLASS                          | TOTAL (W/W) *5 / ("A"-*G)           | -  | -            | -                                   | 3.56        | 3.56 / B | 3.56  | 3.90   | 2.96 |
|  | Erp *6                                   | Pdesign at -10°C                       | kW                                  | -  | -            | -                                   | -           | 12.5     | -     | -      | -    |
|  |  | Tbivalent                              | °C                                  | -  | -            | -                                   | -           | -7       | -     | -      | -    |
|  |  | η <sub>s.h</sub>                       | %                                   | -  | -            | -                                   | -           | 144.1    | -     | -      | -    |
|  |  | Annual consumption                     | kWh                                 | -  | -            | -                                   | -           | -        | -     | -      | -    |
| Power factor   |  | %                                      | -                                   | -  | -            | 96                                  | 95          | 93       | -     | -      |      |
| Noise indoor   | dB-A (H/M/L)                             | 43/41/36                               |                                     |  | -            | -                                   | -           | -        | -     |        |      |
|  | Power Level dB                           | 60/58/53                               |                                     |  | -            | -                                   | -           | -        | -     |        |      |
| Noise outdoor  | dB-A (H/L)                               | -                                      |                                     |  | -            | 53/-                                |             | -        | -     |        |      |
|  | Power Level dB                           | -                                      |                                     |  | -            | 70/-                                |             | -        | -     |        |      |
| EXTRA LOW TEMP Total capacity(kW) / Input power(W) / COP |  | -                                      |                                     |  |              |                                     |             |          |       |        |      |
| Max Current(A) / Max Input power(W)                      |  | 1.28×2/160×2                           | 1.24×2/160×2                        | 1.20×2/160×2                                   | 28.0/6.000k  | 28.0/6.200k                         | 28.0/6.400k | -        |       |        |      |
| Starting current(A) / Comp output(W)                     |  | -                                      | -                                   | -  | 17.4/3.0k    | 16.9/3.0k                           | 16.4/3.0k   | -        |       |        |      |
| Network Impedance(ΩMAX.)                                 |  | -                                      |                                     |  |              |                                     |             |          |       |        |      |
| Fan motor output (Indoor/Outdoor) W                      |  | 120×2                                  |                                     |  | 90×2         |                                     |             | -        |       |        |      |
| Moisture removal volume                                  |  | L/h(Pt/h)                              | 7.9                                 | (3.95×2)                                       | (16.6)       | -                                   |             |          | -     |        |      |
| External static pressure                                 |  | Pa                                     | 50 (MIN10 - MAX80)                  |  |              | -                                   |             |          | -     |        |      |
| Indoor Air flow  | Cooling                                  | m³/min (ft³/min)                       | [22/20/16 (777/706/565)]×2          |  |              | -                                   |             |          | -     |        |      |
|  | Heating                                  | m³/min (ft³/min)                       | [22/20/16 (777/706/565)]×2          |  |              | -                                   |             |          | -     |        |      |
| Outdoor Air flow   | Cooling                                  | m³/min (ft³/min)                       | -                                   |  |              | 130                                 | (4591)      | -        |       |        |      |
|  | Heating                                  | m³/min (ft³/min)                       | -                                   |  |              | 110                                 | (3885)      | -        |       |        |      |
| Refrigerant type / amount g(oz)                          |  | -                                      |                                     |  | R410A        | 3.40k                               | (119.9)     | -        |       |        |      |
| Product dimension  | Height                                   | mm(inch)                               | 250 (9-27/32)                       |  |              | 1416 (55-3/4)                       |             |          | -     |        |      |
|  | Width                                    | mm(inch)                               | 1000 (+100) (39-5/16) (+3-15/16)    |  |              | 940 (37-1/32)                       |             |          | -     |        |      |
|  | Depth                                    | mm(inch)                               | 650 (25-19/32)                      |  |              | 340 (13-13/32)                      |             |          | -     |        |      |
| Packing dimension  | Height                                   | mm(inch)                               | 338                                 |  |              | 1556                                |             |          | -     |        |      |
|  | Width                                    | mm(inch)                               | 1211                                |  |              | 1055                                |             |          | -     |        |      |
|  | Depth                                    | mm(inch)                               | 761                                 |  |              | 485                                 |             |          | -     |        |      |
| Weight   | (NET)                                    | kg(lb)                                 | 32 (71)                             |  |              | 98 (216)                            |             |          | -     |        |      |
|  | (GROSS)                                  | kg(lb)                                 | 38 (84)                             |  |              | 108 (238)                           |             |          | -     |        |      |
| Layers limit (actually)                                  |  | 6 (7)                                  |                                     |  | 1 (2)        |                                     |             | -        |       |        |      |
| Operation condition                                      | Cool (DBT)                               | 18°C ~ 32°C                            |                                     |  | -15°C ~ 46°C |                                     |             | -        |       |        |      |
|  | Heat (DBT)                               | 16°C ~ 30°C                            |                                     |  | -20°C ~ 24°C |                                     |             | -        |       |        |      |
| P<br>I<br>P<br>I<br>N<br>G                               | Pipe diameter mm (inch)                  |  | (Liquid)ø9.52(3/8) (Gas)ø15.88(5/8) |  |              | (Liquid)ø9.52(3/8) (Gas)ø15.88(5/8) |             |          | -     |        |      |
|  | Connecting method, Standard length m(ft) |  | flared type, 5.0(16.4)              |  |              | flared type, 5.0(16.4)              |             |          | -     |        |      |
| Pipe length range  |  | m (ft)                                 |                                     | 5 ~ 75 (16.4 ~ 246.1)                          |              | -                                   |             |          |       |        |      |
| Indoor unit & Outdoor unit height difference             |  | m (ft)                                 |                                     | 15 (OD located lower) / 30 (OD located higher) |              | (49.2/98.4)                         |             | -        |       |        |      |
| Add gas amount   |  | g/m (oz/ft)                            |                                     | 50 (0.538)                                     |              | -                                   |             |          |       |        |      |
| Pipe length for additional gas                           |  | m (ft)                                 |                                     | 30 (98.4)                                      |              | -                                   |             |          |       |        |      |

\*1: In case it is necessary to indicate the air flow volume in (l/s), the value in (m³/min.) shall be multiplied by 16.7 and rounded down the decimal point.  
 \*2: If the EUROVENT Certified models can be operated under the "extra-low" temperature condition, -7°C dry bulb and -8°C wet-bulb temperatures with rated voltage 230 V shall be used.  
 \*3: Network Impedance shall be applicable for EUROPE and CHINA models.  
 \*4: The annual consumption is calculated by multiplying the input power at 230 V (400 V) by an average of 500 hours per year in cooling mode.  
 \*5: EER and COP classification is at 230 V (400 V) only in accordance with EU directive 2002/31/EC.  
 \*6: SEER and SCOP classification is at 230V(400V) only in accordance with EN-14825. For heating, SCOP indicates the value of only Average heating season.

# Single -Type

## 1-1. Unit Specifications

**PE1**

### 5. Ducted Type S-71PN1E5A / U-71PE1E5A

| INDOOR   |  | MODEL  | S-71PN1E5A                       |          |                                     | -              |             |          | -    |        |      |
|--|--|--|----------------------------------|----------|-------------------------------------|----------------|-------------|----------|------|--------|------|
| OUTDOOR  |  | MODEL  | -                                |          |                                     | U-71PE1E5A     |             |          | -    |        |      |
| Branch pipe  |  | MODEL  | -                                |          |                                     | -              |             |          | -    |        |      |
| Performance test condition                               |  | ISO13253 / EN14511 / EN14825 / EN12102         |                                  |          |                                     |                |             |          |      |        |      |
| Power supply   |  | Ø, Hz  | 1ø 50Hz                          |          |                                     | 1ø 50Hz        |             |          | Min  | Max    |      |
|  |  | V  | 220                              | 230      | 240                                 | 220            | 230         | 240      |      |        |      |
| C<br>O<br>O<br>L<br>I<br>N<br>G                          | Capacity                                 | kW   | 7.1                              | 7.1      | 7.1                                 | -              | -           | -        | 2.5  | 8.0    |      |
|  |  | BTU/h  | 24200                            | 24200    | 24200                               | -              | -           | -        | 8500 | 27300  |      |
|  | Current                                  | A  | 1.12                             | 1.08     | 1.04                                | 9.70           | 9.40        | 9.20     | -    | -      |      |
|  |  | W  | 140                              | 140      | 140                                 | 2.010k         | 2.010k      | 2.010k   | -    | -      |      |
|  | Input power                              | TOTAL W  | -                                |          |                                     | 2.150k         | 2.150k      | 2.150k   | 550  | 2.750k |      |
|  |  | Annual consumption                             | TOTAL kWh *4                     | -        |                                     |                | -           | 1075     | -    | -      | -    |
|  | EER/EER CLASS                            | TOTAL (W/W) *5 / ("A"-G)                       | -                                | -        | -                                   | 3.30           | 3.30 / A    | 3.30     | 4.55 | 2.91   |      |
|  | Erp *6                                   | Pdesign  | kW                               | -        | -                                   | -              | -           | 7.1      | -    | -      | -    |
|  |  | SEER   | (W/W)                            | -        | -                                   | -              | -           | 5.5      | -    | -      | -    |
|  |  | Annual consumption                             | kWh                              | -        | -                                   | -              | -           | 448      | -    | -      | -    |
|  |  | Class  |                                  | -        | -                                   | -              | -           | A        | -    | -      | -    |
|  | Power factor                             | %  | -                                | -        | -                                   | 94             | 93          | 91       | -    | -      |      |
|  | Noise indoor                             | dB-A (H/M/L)                                   | 43/41/36                         |          |                                     | -              | -           | -        | -    | -      |      |
|  |  | Power Level dB                                 | 60/58/53                         |          |                                     | -              | -           | -        | -    | -      |      |
| Noise outdoor  | dB-A (H/L)                               | -  |                                  |          | -                                   | 48/-           | -           | -        | -    |        |      |
|  | Power Level dB                           | -  |                                  |          | -                                   | 65/-           | -           | -        | -    |        |      |
| H<br>E<br>A<br>T<br>I<br>N<br>G                          | Capacity                                 | kW   | 8.0                              | 8.0      | 8.0                                 | -              | -           | -        | 2.0  | 9.0    |      |
|  |  | BTU/h  | 27300                            | 27300    | 27300                               | -              | -           | -        | 6800 | 30700  |      |
|  | Current                                  | A  | 1.12                             | 1.08     | 1.04                                | 10.2           | 9.90        | 9.70     | -    | -      |      |
|  |  | W  | 140                              | 140      | 140                                 | 2.120k         | 2.120k      | 2.120k   | -    | -      |      |
|  | Input power                              | TOTAL W  | -                                |          |                                     | 2.260k         | 2.260k      | 2.260k   | 500  | 2.920k |      |
|  |  | COP/COP CLASS                                  | TOTAL (W/W) *7 / ("A"-G)         | -        | -                                   | -              | 3.54        | 3.54 / B | 3.54 | 4.00   | 3.08 |
|  | Erp *6                                   | Pdesign at -10°C                               | kW                               | -        | -                                   | -              | -           | 6.2      | -    | -      | -    |
|  |  | Tbivalent                                      | °C                               | -        | -                                   | -              | -           | -9       | -    | -      | -    |
|  |  | SCOP   | (W/W)                            | -        | -                                   | -              | -           | 3.8      | -    | -      | -    |
|  |  | Annual consumption                             | kWh                              | -        | -                                   | -              | -           | 2284     | -    | -      | -    |
|  | Class                                    |  | -                                | -        | -                                   | -              | A           | -        | -    | -      |      |
|  | Power factor                             | %  | -                                | -        | -                                   | 94             | 93          | 91       | -    | -      |      |
|  | Noise indoor                             | dB-A (H/M/L)                                   | 43/41/36                         |          |                                     | -              | -           | -        | -    | -      |      |
|  |  | Power Level dB                                 | 60/58/53                         |          |                                     | -              | -           | -        | -    | -      |      |
| Noise outdoor  | dB-A (H/L)                               | -  |                                  |          | -                                   | 50/-           | -           | -        | -    |        |      |
|  | Power Level dB                           | -  |                                  |          | -                                   | 67/-           | -           | -        | -    |        |      |
| EXTRA LOW TEMP Total capacity(kW) / Input power(W) / COP |  | -  |                                  |          |                                     |                |             |          |      |        |      |
| Max Current(A) / Max Input power(W)                      |  | 1.28/160                                       | 1.24/160                         | 1.20/160 | 18.0/3.800k                         | 18.0/3.930k    | 18.0/4.060k | -        |      |        |      |
| Starting current(A) / Comp output(W)                     |  | -  | -                                | -        | 10.2/2.0k                           | 9.9/2.0k       | 9.7/2.0k    | -        |      |        |      |
| Network Impedance(ΩMAX.)                                 |  | -  |                                  |          |                                     |                |             |          |      |        |      |
| Fan motor output (Indoor/Outdoor) W                      |  | 120  |                                  |          | 90                                  |                |             | -        |      |        |      |
| Moisture removal volume                                  |  | L/h(Pt/h)                                      | 4.2                              | (8.8)    |                                     | -              |             |          | -    |        |      |
| External static pressure                                 |  | Pa   | 50 (MIN10 - MAX80)               |          |                                     | -              |             |          | -    |        |      |
| Indoor Air flow  | Cooling                                  | m³/min (ft³/min)                               | 22/20/16 (777/706/565)           |          |                                     | -              |             |          | -    |        |      |
|  | Heating                                  | m³/min (ft³/min)                               | 22/20/16 (777/706/565)           |          |                                     | -              |             |          | -    |        |      |
| Outdoor Air flow   | Cooling                                  | m³/min (ft³/min)                               | -                                |          |                                     | 60             | (2119)      | -        | -    |        |      |
|  | Heating                                  | m³/min (ft³/min)                               | -                                |          |                                     | 60             | (2119)      | -        | -    |        |      |
| Refrigerant type / amount g(oz)                          |  | -  |                                  |          | R410A                               | 2.35k          | (82.9)      | -        |      |        |      |
| Product dimension  | Height                                   | mm(inch)                                       | 250 (9-27/32)                    |          |                                     | 996 (39-77/32) |             |          | -    |        |      |
|  | Width                                    | mm(inch)                                       | 1000 (+100) (39-5/16) (+3-15/16) |          |                                     | 940 (37-1/32)  |             |          | -    |        |      |
|  | Depth                                    | mm(inch)                                       | 650 (25-19/32)                   |          |                                     | 340 (13-13/32) |             |          | -    |        |      |
| Packing dimension  | Height                                   | mm(inch)                                       | 338                              |          |                                     | 1136           |             |          | -    |        |      |
|  | Width                                    | mm(inch)                                       | 1211                             |          |                                     | 1055           |             |          | -    |        |      |
|  | Depth                                    | mm(inch)                                       | 761                              |          |                                     | 485            |             |          | -    |        |      |
| Weight   | (NET)                                    | kg(lb)   | 32 (71)                          |          |                                     | 69 (152)       |             |          | -    |        |      |
|  | (GROSS)                                  | kg(lb)   | 38 (84)                          |          |                                     | 77 (170)       |             |          | -    |        |      |
| Layers limit (actually)                                  |  | 6 (7)  |                                  |          | 2 (3)                               |                |             | -        |      |        |      |
| Operation condition                                      | Cool (DBT)                               | 18°C ~ 32°C                                    |                                  |          | -15°C ~ 46°C                        |                |             | -        |      |        |      |
|  | Heat (DBT)                               | 16°C ~ 30°C                                    |                                  |          | -20°C ~ 24°C                        |                |             | -        |      |        |      |
| P I P I N G  | Pipe diameter mm (inch)                  | (Liquid)ø9.52(3/8) (Gas)ø15.88(5/8)            |                                  |          | (Liquid)ø9.52(3/8) (Gas)ø15.88(5/8) |                |             | -        |      |        |      |
|  | Connecting method, Standard length m(ft) | flared type, 5.0(16.4)                         |                                  |          | flared type, 5.0(16.4)              |                |             | -        |      |        |      |
| Pipe length range m (ft)                                 |  | 5 ~ 50 (16.4 ~ 164.0)                          |                                  |          | -                                   |                |             | -        |      |        |      |
| Indoor unit & Outdoor unit height difference m (ft)      |  | 15 (OD located lower) / 30 (OD located higher) |                                  |          | (49.2/98.4)                         |                |             | -        |      |        |      |
| Add gas amount g/m (oz/ft)                               |  | 50   |                                  |          | (0.538)                             |                |             | -        |      |        |      |
| Pipe length for additional gas m (ft)                    |  | 30   |                                  |          | (98.4)                              |                |             | -        |      |        |      |

\*1: In case it is necessary to indicate the air flow volume in (l/s), the value in (m³/min.) shall be multiplied by 16.7 and rounded down the decimal point.

\*2: If the EUROVENT Certified models can be operated under the "extra-low" temperature condition, -7°C dry bulb and -8°C wet-bulb temperatures with rated voltage 230 V shall be used.

\*3: Network Impedance shall be applicable for EUROPE and CHINA models.

\*4: The annual consumption is calculated by multiplying the input power at 230 V (400 V) by an average of 500 hours per year in cooling mode.

\*5: EER and COP classification is at 230 V (400 V) only in accordance with EU directive 2002/31/EC.

\*6: SEER and SCOP classification is at 230V(400V) only in accordance with EN-14825. For heating, SCOP indicates the value of only Average heating season, Other fiche data indicates in an attached sheet.



# Simultaneous (Twin) -Type

## 1-1. Unit Specifications

**PE1**

### 5. Ducted Type S-71PN1E5A×2 / U-140PE1E5A

| INDOOR   |  | MODEL  | S-71PN1E5A×2                        |              |                                     | -              |             |          | -     |        |      |
|--|--|--|-------------------------------------|--------------|-------------------------------------|----------------|-------------|----------|-------|--------|------|
| OUTDOOR  |  | MODEL  | -                                   |              |                                     | U-140PE1E5A    |             |          | -     |        |      |
| Branch pipe  |  | MODEL  | CZ-P155BK1                          |              |                                     |                |             |          |       |        |      |
| Performance test condition                               |  | ISO13253 / EN14511 / EN12102 / EN14825         |                                     |              |                                     |                |             |          |       |        |      |
| Power supply   |  | Ø, Hz  | 1ø 50Hz                             |              |                                     | 1ø 50Hz        |             |          |       |        |      |
|  |  | V  | 220                                 | 230          | 240                                 | 220            | 230         | 240      | Min   | Max    |      |
| C<br>O<br>O<br>L<br>I<br>N<br>G                          | Capacity                                 | kW   | 14.0                                | 14.0         | 14.0                                | -              | -           | -        | 3.3   | 15.5   |      |
|  |  | BTU/h  | 47800                               | 47800        | 47800                               | -              | -           | -        | 11300 | 52900  |      |
|  | Current                                  | A  | 1.12×2                              | 1.08×2       | 1.04×2                              | 20.5           | 20.1        | 19.5     | -     | -      |      |
|  |  | W  | 140×2                               | 140×2        | 140×2                               | 4.400k         | 4.400k      | 4.400k   | -     | -      |      |
|  | Input power                              | TOTAL W  | -                                   |              |                                     | 4.680k         | 4.680k      | 4.680k   | 1000  | 6.200k |      |
|  |  | Annual consumption                             | TOTAL kWh *4                        | -            |                                     |                | -           | 2340     | -     | -      | -    |
|  | EER/EER CLASS                            | TOTAL (W/W) <sup>5</sup> / ("A"-°G)            | -                                   | -            | -                                   | 2.99           | 2.99 / C    | 2.99     | 3.30  | 2.50   |      |
|  | Erp <sup>*6</sup>                        | Pdesign  | kW                                  | -            | -                                   | -              | -           | 14.0     | -     | -      | -    |
|  |  | η <sub>s.c</sub>                               | %                                   | -            | -                                   | -              | -           | 219.8    | -     | -      | -    |
|  |  | Annual consumption                             | kWh                                 | -            | -                                   | -              | -           | -        | -     | -      | -    |
|  |  | Class  |                                     | -            | -                                   | -              | -           | -        | -     | -      | -    |
|  | Power factor                             | %  | -                                   | -            | -                                   | 98             | 95          | 94       | -     | -      |      |
| Noise indoor   | dB-A (H/M/L)                             | 43/41/36                                       |                                     |              | -                                   | -              | -           | -        | -     |        |      |
|  | Power Level dB                           | 60/58/53                                       |                                     |              | -                                   | -              | -           | -        | -     |        |      |
| Noise outdoor  | dB-A (H/L)                               | -  |                                     |              | 54/-                                |                |             | -        | -     |        |      |
|  | Power Level dB                           | -  |                                     |              | 71/-                                |                |             | -        | -     |        |      |
| H<br>E<br>A<br>T<br>I<br>N<br>G                          | Capacity                                 | kW   | 16.0                                | 16.0         | 16.0                                | -              | -           | -        | 4.1   | 18.0   |      |
|  |  | BTU/h  | 54600                               | 54600        | 54600                               | -              | -           | -        | 14000 | 61400  |      |
|  | Current                                  | A  | 1.12×2                              | 1.08×2       | 1.04×2                              | 20.6           | 20.2        | 19.6     | -     | -      |      |
|  |  | W  | 140×2                               | 140×2        | 140×2                               | 4.440k         | 4.440k      | 4.440k   | -     | -      |      |
|  | Input power                              | TOTAL W  | -                                   |              |                                     | 4.720k         | 4.720k      | 4.720k   | 1050  | 6.100k |      |
|  |  | COP/COP CLASS                                  | TOTAL (W/W) <sup>5</sup> / ("A"-°G) | -            | -                                   | -              | 3.39        | 3.39 / C | 3.39  | 3.90   | 2.95 |
|  | Erp <sup>*6</sup>                        | Pdesign at -10°C                               | kW                                  | -            | -                                   | -              | -           | 14.0     | -     | -      | -    |
|  |  | Tbivalent                                      | °C                                  | -            | -                                   | -              | -           | -7       | -     | -      | -    |
|  |  | η <sub>s.h</sub>                               | %                                   | -            | -                                   | -              | -           | 140.7    | -     | -      | -    |
|  |  | Annual consumption                             | kWh                                 | -            | -                                   | -              | -           | -        | -     | -      | -    |
|  | Class                                    |  | -                                   | -            | -                                   | -              | -           | -        | -     | -      |      |
|  | Power factor                             | %  | -                                   | -            | -                                   | 98             | 96          | 94       | -     | -      |      |
| Noise indoor   | dB-A (H/M/L)                             | 43/41/36                                       |                                     |              | -                                   |                |             | -        | -     |        |      |
|  | Power Level dB                           | 60/58/53                                       |                                     |              | -                                   |                |             | -        | -     |        |      |
| Noise outdoor  | dB-A (H/L)                               | -  |                                     |              | 55/-                                |                |             | -        | -     |        |      |
|  | Power Level dB                           | -  |                                     |              | 71/-                                |                |             | -        | -     |        |      |
| EXTRA LOW TEMP Total capacity(kW) / Input power(W) / COP |  | -  |                                     |              |                                     |                |             |          |       |        |      |
| Max Current(A) / Max Input power(W)                      |  | 1.28×2/160×2                                   | 1.24×2/160×2                        | 1.20×2/160×2 | 30.0/6.450k                         | 30.0/6.650k    | 30.0/6.850k | -        |       |        |      |
| Starting current(A) / Comp output(W)                     |  | -  | -                                   | -            | 20.6/3.0k                           | 20.2/3.0k      | 19.6/3.0k   | -        |       |        |      |
| Network Impedance(ΩMAX.)                                 |  | -  |                                     |              |                                     |                |             |          |       |        |      |
| Fan motor output (Indoor/Outdoor) W                      |  | 120×2  |                                     |              | 90×2                                |                |             | -        |       |        |      |
| Moisture removal volume                                  |  | L/h(Pt/h)                                      | 9.0                                 | (4.5×2)      | (18.9)                              | -              |             |          | -     |        |      |
| External static pressure                                 |  | Pa   | 50 (MIN10 - MAX80)                  |              |                                     | -              |             |          | -     |        |      |
| Indoor Air flow  | Cooling                                  | m³/min (ft³/min)                               | [22/20/16 (777/706/565)]×2          |              |                                     | -              |             |          | -     |        |      |
|  | Heating                                  | m³/min (ft³/min)                               | [22/20/16 (777/706/565)]×2          |              |                                     | -              |             |          | -     |        |      |
| Outdoor Air flow   | Cooling                                  | m³/min (ft³/min)                               | -                                   |              |                                     | 135            | (4767)      | -        |       |        |      |
|  | Heating                                  | m³/min (ft³/min)                               | -                                   |              |                                     | 120            | (4238)      | -        |       |        |      |
| Refrigerant type / amount g(oz)                          |  | -  |                                     |              | R410A                               | 3.40k          | (119.9)     | -        |       |        |      |
| Product dimension  | Height                                   | mm(inch)                                       | 250 (9-27/32)                       |              |                                     | 1416 (55-3/4)  |             |          | -     |        |      |
|  | Width                                    | mm(inch)                                       | 1000 (+100) (39-5/16) (+3-15/16)    |              |                                     | 940 (37-1/32)  |             |          | -     |        |      |
|  | Depth                                    | mm(inch)                                       | 650 (25-19/32)                      |              |                                     | 340 (13-13/32) |             |          | -     |        |      |
| Packing dimension  | Height                                   | mm(inch)                                       | 338                                 |              |                                     | 1556           |             |          | -     |        |      |
|  | Width                                    | mm(inch)                                       | 1211                                |              |                                     | 1055           |             |          | -     |        |      |
|  | Depth                                    | mm(inch)                                       | 761                                 |              |                                     | 485            |             |          | -     |        |      |
| Weight   | (NET)                                    | kg(lb)   | 32 (71)                             |              |                                     | 98 (216)       |             |          | -     |        |      |
|  | (GROSS)                                  | kg(lb)   | 38 (84)                             |              |                                     | 108 (238)      |             |          | -     |        |      |
| Layers limit (actually)                                  |  | 6 (7)  |                                     |              | 1 (2)                               |                |             | -        |       |        |      |
| Operation condition                                      | Cool (DBT)                               | 18°C ~ 32°C                                    |                                     |              | -15°C ~ 46°C                        |                |             | -        |       |        |      |
|  | Heat (DBT)                               | 16°C ~ 30°C                                    |                                     |              | -20°C ~ 24°C                        |                |             | -        |       |        |      |
| P<br>I<br>P<br>I<br>N<br>G                               | Pipe diameter mm (inch)                  | (Liquid)ø9.52(3/8) (Gas)ø15.88(5/8)            |                                     |              | (Liquid)ø9.52(3/8) (Gas)ø15.88(5/8) |                |             | -        |       |        |      |
|  | Connecting method, Standard length m(ft) | flared type, 5.0(16.4)                         |                                     |              | flared type, 5.0(16.4)              |                |             | -        |       |        |      |
| Pipe length range m (ft)                                 |  | 5 ~ 75 (16.4 ~ 246.1)                          |                                     |              | -                                   |                |             | -        |       |        |      |
| Indoor unit & Outdoor unit height difference m (ft)      |  | 15 (OD located lower) / 30 (OD located higher) |                                     |              | (49.2/98.4)                         |                |             | -        |       |        |      |
| Add gas amount g/m (oz/ft)                               |  | 50   |                                     |              | (0.538)                             |                |             | -        |       |        |      |
| Pipe length for additional gas m (ft)                    |  | 30   |                                     |              | (98.4)                              |                |             | -        |       |        |      |

\*1: In case it is necessary to indicate the air flow volume in (l/s), the value in (m³/min.) shall be multiplied by 16.7 and rounded down the decimal point.

\*2: If the EUROVENT Certified models can be operated under the "extra-low" temperature condition, -7°C dry bulb and -8°C wet-bulb temperatures with rated voltage 230 V shall be used.

\*3: Network Impedance shall be applicable for EUROPE and CHINA models.

\*4: The annual consumption is calculated by multiplying the input power at 230 V (400 V) by an average of 500 hours per year in cooling mode.

\*5: EER and COP classification is at 230 V (400 V) only in accordance with EU directive 2002/31/EC.

\*6: SEER and SCOP classification is at 230V(400V) only in accordance with EN-14825. For heating, SCOP indicates the value of only Average heating season.

# Single -Type

## 1-1. Unit Specifications

**PE1**

### 5. Ducted Type S-100PN1E5A / U-100PE1E5A

| INDOOR   |  | MODEL  | S-100PN1E5A                       |          |                                     | -              |             |          | -     |        |      |
|--|--|--|-----------------------------------|----------|-------------------------------------|----------------|-------------|----------|-------|--------|------|
| OUTDOOR  |  | MODEL  | -                                 |          |                                     | U-100PE1E5A    |             |          | -     |        |      |
| Branch pipe  |  | MODEL  | -                                 |          |                                     | -              |             |          | -     |        |      |
| Performance test condition                               |  | ISO13253 / EN14511 / EN14825 / EN12102         |                                   |          |                                     |                |             |          |       |        |      |
| Power supply   |  | Ø, Hz  | 1ø 50Hz                           |          |                                     | 1ø 50Hz        |             |          | Min   | Max    |      |
|  |  | V  | 220                               | 230      | 240                                 | 220            | 230         | 240      |       |        |      |
| C<br>O<br>O<br>L<br>I<br>N<br>G                          | Capacity                                 | kW   | 10.0                              | 10.0     | 10.0                                | -              | -           | -        | 3.3   | 12.5   |      |
|  |  | BTU/h  | 34100                             | 34100    | 34100                               | -              | -           | -        | 11300 | 42700  |      |
|  | Current                                  | A  | 1.54                              | 1.48     | 1.42                                | 11.6           | 11.2        | 10.9     | -     | -      |      |
|  |  | W  | 205                               | 205      | 205                                 | 2.465k         | 2.465k      | 2.465k   | -     | -      |      |
|  | Input power                              | TOTAL W  | -                                 |          |                                     | 2.670k         | 2.670k      | 2.670k   | 870   | 3.800k |      |
|  |  | Annual consumption                             | TOTAL kWh *4                      | -        |                                     |                | -           | 1335     | -     | -      | -    |
|  | EER/EER CLASS                            | TOTAL (W/W) <sup>15</sup> ("A"-G)              | -                                 | -        | -                                   | 3.75           | 3.75 / A    | 3.75     | 3.79  | 3.29   |      |
|  | Erp <sup>16</sup>                        | Pdesign  | kW                                | -        | -                                   | -              | -           | 10.0     | -     | -      | -    |
|  |  | SEER   | (W/W)                             | -        | -                                   | -              | -           | 5.9      | -     | -      | -    |
|  |  | Annual consumption                             | kWh                               | -        | -                                   | -              | -           | 589      | -     | -      | -    |
|  |  | Class  |                                   | -        | -                                   | -              | -           | A+       | -     | -      | -    |
|  | Power factor                             | %  | -                                 | -        | -                                   | 97             | 96          | 94       | -     | -      |      |
|  | Noise indoor                             | dB-A (H/M/L)                                   | 44/42/37                          |          |                                     | -              |             |          | -     | -      |      |
|  |  | Power Level dB                                 | 65/63/58                          |          |                                     | -              |             |          | -     | -      |      |
| Noise outdoor  | dB-A (H/L)                               | -  |                                   |          | 52/-                                |                |             | -        | -     |        |      |
|  | Power Level dB                           | -  |                                   |          | 69/-                                |                |             | -        | -     |        |      |
| H<br>E<br>A<br>T<br>I<br>N<br>G                          | Capacity                                 | kW   | 11.2                              | 11.2     | 11.2                                | -              | -           | -        | 4.1   | 14.0   |      |
|  |  | BTU/h  | 38200                             | 38200    | 38200                               | -              | -           | -        | 14000 | 47800  |      |
|  | Current                                  | A  | 1.54                              | 1.48     | 1.42                                | 12.8           | 12.5        | 12.2     | -     | -      |      |
|  |  | W  | 205                               | 205      | 205                                 | 2.745k         | 2.745k      | 2.745k   | -     | -      |      |
|  | Input power                              | TOTAL W  | -                                 |          |                                     | 2.950k         | 2.950k      | 2.950k   | 980   | 4.500k |      |
|  |  | COP/COP CLASS                                  | TOTAL (W/W) <sup>15</sup> ("A"-G) | -        | -                                   | -              | 3.80        | 3.80 / A | 3.80  | 4.18   | 3.11 |
|  | Erp <sup>16</sup>                        | Pdesign at -10°C                               | kW                                | -        | -                                   | -              | -           | 10.0     | -     | -      | -    |
|  |  | Tbivalent                                      | °C                                | -        | -                                   | -              | -           | -10      | -     | -      | -    |
|  |  | SCOP   | (W/W)                             | -        | -                                   | -              | -           | 3.9      | -     | -      | -    |
|  |  | Annual consumption                             | kWh                               | -        | -                                   | -              | -           | 3590     | -     | -      | -    |
|  | Class                                    |  | -                                 | -        | -                                   | -              | A           | -        | -     | -      |      |
|  | Power factor                             | %  | -                                 | -        | -                                   | 97             | 95          | 94       | -     | -      |      |
|  | Noise indoor                             | dB-A (H/M/L)                                   | 44/42/37                          |          |                                     | -              |             |          | -     | -      |      |
|  |  | Power Level dB                                 | 65/63/58                          |          |                                     | -              |             |          | -     | -      |      |
| Noise outdoor  | dB-A (H/L)                               | -  |                                   |          | 52/-                                |                |             | -        | -     |        |      |
|  | Power Level dB                           | -  |                                   |          | 69/-                                |                |             | -        | -     |        |      |
| EXTRA LOW TEMP Total capacity(kW) / Input power(W) / COP |  | -  |                                   |          |                                     |                |             |          |       |        |      |
| Max Current(A) / Max Input power(W)                      |  | 2.13/275                                       | 2.07/275                          | 2.01/275 | 25.0/5.350k                         | 25.0/5.550k    | 25.0/5.750k | -        |       |        |      |
| Starting current(A) / Comp output(W)                     |  | -  | -                                 | -        | 12.8/3.0k                           | 12.5/3.0k      | 12.2/3.0k   | -        |       |        |      |
| Network Impedance(ΩMAX.)                                 |  | -  |                                   |          |                                     |                |             |          |       |        |      |
| Fan motor output (Indoor/Outdoor) W                      |  | 200  |                                   |          | 90×2                                |                |             | -        |       |        |      |
| Moisture removal volume                                  |  | L/h(Pt/h)                                      | 6.0 (12.6)                        |          |                                     | -              |             |          | -     |        |      |
| External static pressure                                 |  | Pa   | 50 (MIN10 - MAX80)                |          |                                     | -              |             |          | -     |        |      |
| Indoor Air flow  | Cooling                                  | m³/min (ft³/min)                               | 36/33/26 (1271/1165/918)          |          |                                     | -              |             |          | -     | -      |      |
|  | Heating                                  | m³/min (ft³/min)                               | 36/33/26 (1271/1165/918)          |          |                                     | -              |             |          | -     | -      |      |
| Outdoor Air flow   | Cooling                                  | m³/min (ft³/min)                               | -                                 |          |                                     | 110 (3885)     |             | -        | -     |        |      |
|  | Heating                                  | m³/min (ft³/min)                               | -                                 |          |                                     | 95 (3355)      |             | -        | -     |        |      |
| Refrigerant type / amount g(oz)                          |  | -  |                                   |          | R410A                               | 3.40k          | (119.9)     | -        |       |        |      |
| Product dimension  | Height                                   | mm(inch)                                       | 250 (9-27/32)                     |          |                                     | 1416 (55-3/4)  |             |          | -     |        |      |
|  | Width                                    | mm(inch)                                       | 1200 (+100) (47-1/4) (+3-15/16)   |          |                                     | 940 (37-1/32)  |             |          | -     |        |      |
|  | Depth                                    | mm(inch)                                       | 650 (25-19/32)                    |          |                                     | 340 (13-13/32) |             |          | -     |        |      |
| Packing dimension  | Height                                   | mm(inch)                                       | 338                               |          |                                     | 1556           |             |          | -     |        |      |
|  | Width                                    | mm(inch)                                       | 1402                              |          |                                     | 1055           |             |          | -     |        |      |
|  | Depth                                    | mm(inch)                                       | 761                               |          |                                     | 485            |             |          | -     |        |      |
| Weight   | (NET)                                    | kg(lb)   | 41 (91)                           |          |                                     | 98 (216)       |             |          | -     |        |      |
|  | (GROSS)                                  | kg(lb)   | 48 (106)                          |          |                                     | 108 (238)      |             |          | -     |        |      |
| Layers limit (actually)                                  |  | 6 (7)  |                                   |          | 1 (2)                               |                |             | -        |       |        |      |
| Operation condition                                      | Cool (DBT)                               | 18°C ~ 32°C                                    |                                   |          | -15°C ~ 46°C                        |                |             | -        |       |        |      |
|  | Heat (DBT)                               | 16°C ~ 30°C                                    |                                   |          | -20°C ~ 24°C                        |                |             | -        |       |        |      |
| P I P I N G  | Pipe diameter mm (inch)                  | (Liquid)ø9.52(3/8) (Gas)ø15.88(5/8)            |                                   |          | (Liquid)ø9.52(3/8) (Gas)ø15.88(5/8) |                |             | -        |       |        |      |
|  | Connecting method, Standard length m(ft) | flared type, 5.0(16.4)                         |                                   |          | flared type, 5.0(16.4)              |                |             | -        |       |        |      |
| Pipe length range  | m (ft)                                   | 5 ~ 75 (16.4 ~ 246.1)                          |                                   |          | -                                   |                |             | -        |       |        |      |
| Indoor unit & Outdoor unit height difference             | m (ft)                                   | 15 (OD located lower) / 30 (OD located higher) |                                   |          | (49.2/98.4)                         |                |             | -        |       |        |      |
| Add gas amount   | g/m (oz/ft)                              | 50   |                                   |          | (0.538)                             |                |             | -        |       |        |      |
| Pipe length for additional gas                           | m (ft)                                   | 30   |                                   |          | (98.4)                              |                |             | -        |       |        |      |

\*1: In case it is necessary to indicate the air flow volume in (l/s), the value in (m³/min.) shall be multiplied by 16.7 and rounded down the decimal point.

\*2: If the EUROVENT Certified models can be operated under the "extra-low" temperature condition, -7°C dry bulb and -8°C wet-bulb temperatures with rated voltage 230 V shall be used.

\*3: Network Impedance shall be applicable for EUROPE and CHINA models.

\*4: The annual consumption is calculated by multiplying the input power at 230 V (400 V) by an average of 500 hours per year in cooling mode.

\*5: EER and COP classification is at 230 V (400 V) only in accordance with EU directive 2002/31/EC.

\*6: SEER and SCOP classification is at 230V(400V) only in accordance with EN-14825. For heating, SCOP indicates the value of only Average heating season, Other fiche data indicates in an attached sheet.

# Single -Type

## 1-1. Unit Specifications

**PE1**

### 5. Ducted Type S-125PN1E5A / U-125PE1E5A

| INDOOR   |  | MODEL  | S-125PN1E5A                     |          |                                     | -              |             |          | -     |        |      |
|--|--|--|---------------------------------|----------|-------------------------------------|----------------|-------------|----------|-------|--------|------|
| OUTDOOR  |  | MODEL  | -                               |          |                                     | U-125PE1E5A    |             |          | -     |        |      |
| Branch pipe  |  | MODEL  | -                               |          |                                     | -              |             |          | -     |        |      |
| Performance test condition                               |  | ISO13253 / EN14511 / EN12102 / EN14825         |                                 |          |                                     |                |             |          |       |        |      |
| Power supply   |  | Ø, Hz  | 1ø 50Hz                         |          |                                     | 1ø 50Hz        |             |          |       |        |      |
|  |  | V  | 220                             | 230      | 240                                 | 220            | 230         | 240      | Min   | Max    |      |
| C<br>O<br>O<br>L<br>I<br>N<br>G                          | Capacity                                 | kW   | 12.5                            | 12.5     | 12.5                                | -              | -           | -        | 3.3   | 14.0   |      |
|  |  | BTU/h  | 42700                           | 42700    | 42700                               | -              | -           | -        | 11300 | 47800  |      |
|  | Current                                  | A  | 1.74                            | 1.67     | 1.61                                | 17.4           | 16.9        | 16.4     | -     | -      |      |
|  |  | W  | 225                             | 225      | 225                                 | 3.665k         | 3.665k      | 3.665k   | -     | -      |      |
|  | Input power                              | TOTAL W  | -                               |          |                                     | 3.890k         | 3.890k      | 3.890k   | 1000  | 4.800k |      |
|  |  | Annual consumption                             | TOTAL kWh *4                    | -        |                                     |                | -           | 1945     | -     | -      | -    |
|  | EER/EER CLASS                            | TOTAL (W/W) *5 / ("A"-°G)                      | -                               | -        | -                                   | 3.21           | 3.21 / A    | 3.21     | 3.30  | 2.92   |      |
|  | Erp *6                                   | Pdesign  | kW                              | -        | -                                   | -              | -           | 12.5     | -     | -      | -    |
|  |  | η <sub>s.c</sub>                               | %                               | -        | -                                   | -              | -           | 214.6    | -     | -      | -    |
|  |  | Annual consumption                             | kWh                             | -        | -                                   | -              | -           | -        | -     | -      | -    |
|  |  | Class  |                                 | -        | -                                   | -              | -           | -        | -     | -      | -    |
|  | Power factor                             | %  | -                               | -        | -                                   | 96             | 94          | 93       | -     | -      |      |
| Noise indoor   | dB-A (H/M/L)                             | 45/43/38                                       |                                 |          | -                                   |                |             | -        | -     |        |      |
|  | Power Level dB                           | 66/64/59                                       |                                 |          | -                                   |                |             | -        | -     |        |      |
| Noise outdoor  | dB-A (H/L)                               | -  |                                 |          | 53/-                                |                |             | -        | -     |        |      |
|  | Power Level dB                           | -  |                                 |          | 70/-                                |                |             | -        | -     |        |      |
| H<br>E<br>A<br>T<br>I<br>N<br>G                          | Capacity                                 | kW   | 14.0                            | 14.0     | 14.0                                | -              | -           | -        | 4.1   | 16.0   |      |
|  |  | BTU/h  | 47800                           | 47800    | 47800                               | -              | -           | -        | 14000 | 54600  |      |
|  | Current                                  | A  | 1.74                            | 1.67     | 1.61                                | 17.3           | 16.8        | 16.3     | -     | -      |      |
|  |  | W  | 225                             | 225      | 225                                 | 3.655k         | 3.655k      | 3.655k   | -     | -      |      |
|  | Input power                              | TOTAL W  | -                               |          |                                     | 3.880k         | 3.880k      | 3.880k   | 1050  | 5.400k |      |
|  |  | COP/COP CLASS                                  | TOTAL (W/W) *5 / ("A"-°G)       | -        | -                                   | -              | 3.61        | 3.61 / A | 3.61  | 3.90   | 2.96 |
|  | Erp *6                                   | Pdesign at -10°C                               | kW                              | -        | -                                   | -              | -           | 12.5     | -     | -      | -    |
|  |  | Tbivalent                                      | °C                              | -        | -                                   | -              | -           | -7       | -     | -      | -    |
|  |  | η <sub>s.h</sub>                               | %                               | -        | -                                   | -              | -           | 143.4    | -     | -      | -    |
|  |  | Annual consumption                             | kWh                             | -        | -                                   | -              | -           | -        | -     | -      | -    |
|  | Class                                    |  | -                               | -        | -                                   | -              | -           | -        | -     | -      |      |
|  | Power factor                             | %  | -                               | -        | -                                   | 96             | 95          | 93       | -     | -      |      |
| Noise indoor   | dB-A (H/M/L)                             | 45/43/38                                       |                                 |          | -                                   |                |             | -        | -     |        |      |
|  | Power Level dB                           | 66/64/59                                       |                                 |          | -                                   |                |             | -        | -     |        |      |
| Noise outdoor  | dB-A (H/L)                               | -  |                                 |          | 53/-                                |                |             | -        | -     |        |      |
|  | Power Level dB                           | -  |                                 |          | 70/-                                |                |             | -        | -     |        |      |
| EXTRA LOW TEMP Total capacity(kW) / Input power(W) / COP |  | -  |                                 |          |                                     |                |             |          |       |        |      |
| Max Current(A) / Max Input power(W)                      |  | 2.36/300                                       | 2.30/300                        | 2.24/300 | 28.0/6.000k                         | 28.0/6.200k    | 28.0/6.400k | -        |       |        |      |
| Starting current(A) / Comp output(W)                     |  | -  | -                               | -        | 17.4/3.0k                           | 16.9/3.0k      | 16.4/3.0k   | -        |       |        |      |
| Network Impedance(ΩMAX.)                                 |  | -  |                                 |          |                                     |                |             |          |       |        |      |
| Fan motor output (Indoor/Outdoor) W                      |  | 200  |                                 |          | 90×2                                |                |             | -        |       |        |      |
| Moisture removal volume                                  |  | L/h(Pt/h)                                      | 7.9                             | (16.6)   |                                     | -              |             |          | -     |        |      |
| External static pressure                                 |  | Pa   | 50 (MIN10 - MAX80)              |          |                                     | -              |             |          | -     |        |      |
| Indoor Air flow  | Cooling                                  | m³/min (ft³/min)                               | 38/35/28 (1342/1236/989)        |          |                                     | -              |             |          | -     |        |      |
|  | Heating                                  | m³/min (ft³/min)                               | 38/35/28 (1342/1236/989)        |          |                                     | -              |             |          | -     |        |      |
| Outdoor Air flow   | Cooling                                  | m³/min (ft³/min)                               | -                               |          |                                     | 130            | (4591)      | -        |       |        |      |
|  | Heating                                  | m³/min (ft³/min)                               | -                               |          |                                     | 110            | (3885)      | -        |       |        |      |
| Refrigerant type / amount g(oz)                          |  | -  |                                 |          | R410A                               | 3.40k          | (119.9)     | -        |       |        |      |
| Product dimension  | Height                                   | mm(inch)                                       | 250 (9-27/32)                   |          |                                     | 1416 (55-3/4)  |             |          | -     |        |      |
|  | Width                                    | mm(inch)                                       | 1200 (+100) (47-1/4) (+3-15/16) |          |                                     | 940 (37-1/32)  |             |          | -     |        |      |
|  | Depth                                    | mm(inch)                                       | 650 (25-19/32)                  |          |                                     | 340 (13-13/32) |             |          | -     |        |      |
| Packing dimension  | Height                                   | mm(inch)                                       | 338                             |          |                                     | 1556           |             |          | -     |        |      |
|  | Width                                    | mm(inch)                                       | 1402                            |          |                                     | 1055           |             |          | -     |        |      |
|  | Depth                                    | mm(inch)                                       | 761                             |          |                                     | 485            |             |          | -     |        |      |
| Weight   | (NET)                                    | kg(lb)   | 41 (91)                         |          |                                     | 98 (216)       |             |          | -     |        |      |
|  | (GROSS)                                  | kg(lb)   | 48 (106)                        |          |                                     | 108 (238)      |             |          | -     |        |      |
| Layers limit (actually)                                  |  | 6 (7)  |                                 |          | 1 (2)                               |                |             | -        |       |        |      |
| Operation condition                                      | Cool (DBT)                               | 18°C ~ 32°C                                    |                                 |          | -15°C ~ 46°C                        |                |             | -        |       |        |      |
|  | Heat (DBT)                               | 16°C ~ 30°C                                    |                                 |          | -20°C ~ 24°C                        |                |             | -        |       |        |      |
| P<br>I<br>P<br>E<br>I<br>N<br>G                          | Pipe diameter mm (inch)                  | (Liquid)ø9.52(3/8) (Gas)ø15.88(5/8)            |                                 |          | (Liquid)ø9.52(3/8) (Gas)ø15.88(5/8) |                |             | -        |       |        |      |
|  | Connecting method, Standard length m(ft) | flared type, 5.0(16.4)                         |                                 |          | flared type, 5.0(16.4)              |                |             | -        |       |        |      |
| Pipe length range m (ft)                                 |  | 5 ~ 75 (16.4 ~ 246.1)                          |                                 |          | -                                   |                |             | -        |       |        |      |
| Indoor unit & Outdoor unit height difference m (ft)      |  | 15 (OD located lower) / 30 (OD located higher) |                                 |          | (49.2/98.4)                         |                |             | -        |       |        |      |
| Add gas amount g/m (oz/ft)                               |  | 50   |                                 |          | (0.538)                             |                |             | -        |       |        |      |
| Pipe length for additional gas m (ft)                    |  | 30   |                                 |          | (98.4)                              |                |             | -        |       |        |      |

\*1: In case it is necessary to indicate the air flow volume in (l/s), the value in (m³/min.) shall be multiplied by 16.7 and rounded down the decimal point.

\*2: If the EUROVENT Certified models can be operated under the "extra-low" temperature condition, -7°C dry bulb and -8°C wet-bulb temperatures with rated voltage 230 V shall be used.

\*3: Network Impedance shall be applicable for EUROPE and CHINA models.

\*4: The annual consumption is calculated by multiplying the input power at 230 V (400 V) by an average of 500 hours per year in cooling mode.

\*5: EER and COP classification is at 230 V (400 V) only in accordance with EU directive 2002/31/EC.

\*6: SEER and SCOP classification is at 230V(400V) only in accordance with EN-14825. For heating, SCOP indicates the value of only Average heating season.

# Single -Type

## 1-1. Unit Specifications

**PE1**

### 5. Ducted Type S-140PN1E5A / U-140PE1E5A

| INDOOR   |  | MODEL                                  | S-140PN1E5A                                    |          |             | -                                   |            |          | -     |        |      |
|--|--|--|--|----------|-------------|-------------------------------------|------------|----------|-------|--------|------|
| OUTDOOR  |  | MODEL                                  | -  |          |             | U-140PE1E5A                         |            |          | -     |        |      |
| Branch pipe  |  | MODEL                                  | -  |          |             | -                                   |            |          | -     |        |      |
| Performance test condition                                 |  | ISO13253 / EN14511 / EN12102 / EN14825 |  |          |             |                                     |            |          |       |        |      |
| Power supply   |  | Ø, Hz                                  | 1ø 50Hz  |          |             | 1ø 50Hz                             |            |          |       |        |      |
|  |  | V                                      | 220  | 230      | 240         | 220                                 | 230        | 240      | Min   | Max    |      |
| C<br>O<br>O<br>L<br>I<br>N<br>G                            | Capacity                                 | kW                                     | 14.0   | 14.0     | 14.0        | -                                   | -          | -        | 3.3   | 15.5   |      |
|  |  | BTU/h                                  | 47800  | 47800    | 47800       | -                                   | -          | -        | 11300 | 52900  |      |
|  | Current                                  | A                                      | 1.89   | 1.82     | 1.74        | 20.5                                | 20.1       | 19.5     | -     | -      |      |
|  |  | W                                      | 250  | 250      | 250         | 4.400k                              | 4.400k     | 4.400k   | -     | -      |      |
|  | Input power                              | TOTAL W                                | -  |          |             | 4.650k                              | 4.650k     | 4.650k   | 1000  | 6.200k |      |
|  |  | Annual consumption                     | TOTAL kWh *4                                   | -        |             |                                     | -          | 2325     | -     | -      | -    |
|  | EER/EER CLASS                            |  | TOTAL (W/W) *5/ ("A"~"G")                      | -        | -           | -                                   | 3.01       | 3.01 / B | 3.01  | 3.30   | 2.50 |
|  | Erp *6                                   | Pdesign                                | kW   | -        | -           | -                                   | -          | 14.0     | -     | -      | -    |
|  |  | η <sub>s.c</sub>                       | %  | -        | -           | -                                   | -          | 207.8    | -     | -      | -    |
|  |  | Annual consumption                     | kWh  | -        | -           | -                                   | -          | -        | -     | -      | -    |
|  |  | Class                                  |  | -        | -           | -                                   | -          | -        | -     | -      | -    |
|  | Power factor                             |  | %  | -        | -           | -                                   | 98         | 95       | 94    | -      | -    |
| Noise indoor   | dB-A (H/M/L)                             | 46/44/39                               |  |          | -           |                                     |            | -        | -     |        |      |
|  | Power Level dB                           | 67/65/60                               |  |          | -           |                                     |            | -        | -     |        |      |
| Noise outdoor  | dB-A (H/L)                               | -                                      |  |          | 54/-        |                                     |            | -        | -     |        |      |
|  | Power Level dB                           | -                                      |  |          | 71/-        |                                     |            | -        | -     |        |      |
| H<br>E<br>A<br>T<br>I<br>N<br>G                            | Capacity                                 | kW                                     | 16.0   | 16.0     | 16.0        | -                                   | -          | -        | 4.1   | 18.0   |      |
|  |  | BTU/h                                  | 54600  | 54600    | 54600       | -                                   | -          | -        | 14000 | 61400  |      |
|  | Current                                  | A                                      | 1.89   | 1.82     | 1.74        | 20.6                                | 20.2       | 19.6     | -     | -      |      |
|  |  | W                                      | 250  | 250      | 250         | 4.440k                              | 4.440k     | 4.440k   | -     | -      |      |
|  | Input power                              | TOTAL W                                | -  |          |             | 4.690k                              | 4.690k     | 4.690k   | 1050  | 6.100k |      |
|  |  | COP/COP CLASS                          | TOTAL (W/W) *7/ ("A"~"G")                      | -        | -           | -                                   | 3.41       | 3.41 / B | 3.41  | 3.90   | 2.95 |
|  | Erp *6                                   | Pdesign at -10°C                       | kW   | -        | -           | -                                   | -          | 14.0     | -     | -      | -    |
|  |  | Tbivalent                              | °C   | -        | -           | -                                   | -          | -7       | -     | -      | -    |
|  |  | η <sub>s.h</sub>                       | %  | -        | -           | -                                   | -          | 140.1    | -     | -      | -    |
|  |  | Annual consumption                     | kWh  | -        | -           | -                                   | -          | -        | -     | -      | -    |
|  | Power factor                             |  | %  | -        | -           | -                                   | 98         | 96       | 94    | -      | -    |
|  | Noise indoor                             | dB-A (H/M/L)                           | 46/44/39                                       |          |             | -                                   |            |          | -     | -      |      |
| Power Level dB   |  | 67/65/60                               |  |          | -           |                                     |            | -        | -     |        |      |
| Noise outdoor  | dB-A (H/L)                               | -                                      |  |          | 55/-        |                                     |            | -        | -     |        |      |
|  | Power Level dB                           | -                                      |  |          | 71/-        |                                     |            | -        | -     |        |      |
| EXTRA LOW TEMP   Total capacity(kW) / Input power(W) / COP |  | -                                      |  |          |             |                                     |            |          |       |        |      |
| Max Current(A) / Max Input power(W)                        |  | 2.59/345                               | 2.53/345                                       | 2.47/345 | 30.0/6.450k | 30.0/6650k                          | 30.0/6850k | -        |       |        |      |
| Starting current(A) / Comp output(W)                       |  | -                                      | -  | -        | 20.6/3.0k   | 20.2/3.0k                           | 19.6/3.0k  | -        |       |        |      |
| Network Impedance(ΩMAX.)                                   |  | -                                      |  |          |             |                                     |            |          |       |        |      |
| Fan motor output (Indoor/Outdoor) W                        |  | 200                                    |  |          | 90×2        |                                     |            | -        |       |        |      |
| Moisture removal volume                                    |  | L/h(Pt/h)                              | 9.0  | (18.9)   |             | -                                   |            |          | -     |        |      |
| External static pressure                                   |  | Pa                                     | 50 (MIN10 - MAX80)                             |          |             | -                                   |            |          | -     |        |      |
| Indoor Air flow  | Cooling                                  | m³/min (ft³/min)                       | 40/37/30 (1413/1307/1059)                      |          |             | -                                   |            |          | -     |        |      |
|  | Heating                                  | m³/min (ft³/min)                       | 40/37/30 (1413/1307/1059)                      |          |             | -                                   |            |          | -     |        |      |
| Outdoor Air flow   | Cooling                                  | m³/min (ft³/min)                       | -  |          |             | 135                                 | (4767)     | -        |       |        |      |
|  | Heating                                  | m³/min (ft³/min)                       | -  |          |             | 120                                 | (4238)     | -        |       |        |      |
| Refrigerant type / amount g(oz)                            |  |  | -  |          |             | R410A                               | 3.40k      | (119.9)  | -     |        |      |
| Product dimension  | Height                                   | mm(inch)                               | 250 (9-27/32)                                  |          |             | 1416 (55-3/4)                       |            |          | -     |        |      |
|  | Width                                    | mm(inch)                               | 1200 (+100) (47-1/4) (+3-15/16)                |          |             | 940 (37-1/32)                       |            |          | -     |        |      |
|  | Depth                                    | mm(inch)                               | 650 (25-19/32)                                 |          |             | 340 (13-13/32)                      |            |          | -     |        |      |
| Packing dimension  | Height                                   | mm(inch)                               | 338  |          |             | 1556                                |            |          | -     |        |      |
|  | Width                                    | mm(inch)                               | 1402   |          |             | 1055                                |            |          | -     |        |      |
|  | Depth                                    | mm(inch)                               | 761  |          |             | 485                                 |            |          | -     |        |      |
| Weight   | (NET)                                    | kg(lb)                                 | 41 (91)  |          |             | 98 (216)                            |            |          | -     |        |      |
|  | (GROSS)                                  | kg(lb)                                 | 48 (106)                                       |          |             | 108 (238)                           |            |          | -     |        |      |
| Layers limit (actually)                                    |  |  | 6 (7)  |          |             | 1 (2)                               |            |          | -     |        |      |
| Operation condition  | Cool (DBT)                               |  | 18°C ~ 32°C                                    |          |             | -15°C ~ 46°C                        |            |          | -     |        |      |
|  | Heat (DBT)                               |  | 16°C ~ 30°C                                    |          |             | -20°C ~ 24°C                        |            |          | -     |        |      |
| P<br>I<br>P<br>I<br>N<br>G                                 | Pipe diameter mm (inch)                  |  | (Liquid)ø9.52(3/8) (Gas)ø15.88(5/8)            |          |             | (Liquid)ø9.52(3/8) (Gas)ø15.88(5/8) |            |          | -     |        |      |
|  | Connecting method, Standard length m(ft) |  | flared type, 5.0(16.4)                         |          |             | flared type, 5.0(16.4)              |            |          | -     |        |      |
| Pipe length range  |  | m (ft)                                 | 5 ~ 75 (16.4 ~ 246.1)                          |          |             | -                                   |            |          | -     |        |      |
| Indoor unit & Outdoor unit height difference               |  | m (ft)                                 | 15 (OD located lower) / 30 (OD located higher) |          |             | (49.2/98.4)                         |            |          | -     |        |      |
| Add gas amount   |  | g/m (oz/ft)                            | 50   |          |             | (0.538)                             |            |          | -     |        |      |
| Pipe length for additional gas                             |  | m (ft)                                 | 30   |          |             | (98.4)                              |            |          | -     |        |      |

\*1: In case it is necessary to indicate the air flow volume in (l/s), the value in (m³/min.) shall be multiplied by 16.7 and rounded down the decimal point.

\*2: If the EUROVENT Certified models can be operated under the "extra-low" temperature condition, -7°C dry bulb and -8°C wet-bulb temperatures with rated voltage 230 V shall be used.

\*3: Network Impedance shall be applicable for EUROPE and CHINA models.

\*4: The annual consumption is calculated by multiplying the input power at 230 V (400 V) by an average of 500 hours per year in cooling mode.

\*5: EER and COP classification is at 230 V (400 V) only in accordance with EU directive 2002/31/EC.

\*6: SEER and SCOP classification is at 230V(400V) only in accordance with EN-14825. For heating, SCOP indicates the value of only Average heating season.

# Simultaneous (Twin) -Type

## 1-1. Unit Specifications

PE1

### 5. Ducted Type S-36PN1E5A×2 / U-71PE1E8A

| INDOOR   |  | MODEL                                  | S-36PN1E5A×2                       |  |              | -                                   |            |          | -    |        |      |
|--|--|--|------------------------------------|--|--------------|-------------------------------------|------------|----------|------|--------|------|
| OUTDOOR  |  | MODEL                                  | -                                  |  |              | U-71PE1E8A                          |            |          | -    |        |      |
| Branch pipe  |  | MODEL                                  | CZ-P155BK1                         |  |              |                                     |            |          |      |        |      |
| Performance test condition                               |  | ISO13253 / EN14511 / EN14825 / EN12102 |                                    |  |              |                                     |            |          |      |        |      |
| Power supply   |  | Ø, Hz                                  | 1ø 50Hz                            |  |              | 3ø 50Hz                             |            |          |      |        |      |
|  |  | V                                      | 220                                | 230  | 240          | 380                                 | 400        | 415      | Min  | Max    |      |
| C<br>O<br>O<br>L<br>I<br>N<br>G                          | Capacity                                 | kW                                     | 7.1                                | 7.1  | 7.1          | -                                   | -          | -        | 2.5  | 8.0    |      |
|  |  | BTU/h                                  | 24200                              | 24200  | 24200        | -                                   | -          | -        | 8500 | 27300  |      |
|  | Current                                  | A                                      | 0.42×2                             | 0.43×2   | 0.44×2       | 3.25                                | 3.10       | 3.00     | -    | -      |      |
|  |  | W                                      | 90×2                               | 94×2   | 98×2         | 2.010k                              | 2.012k     | 2.014k   | -    | -      |      |
|  | Input power                              | TOTAL W                                | -                                  |  |              | 2.190k                              | 2.200k     | 2.210k   | 660  | 2.750k |      |
|  |  | Annual consumption                     | TOTAL kWh *4                       | -  |              |                                     | -          | 1100     | -    | -      | -    |
|  | EER/EER CLASS                            |  | TOTAL (W/W) *5 / ("A"-*G)          | -  | -            | -                                   | 3.24       | 3.23 / A | 3.21 | 3.79   | 2.91 |
|  | Erp *6                                   | Pdesign                                | kW                                 | -  | -            | -                                   | -          | 7.1      | -    | -      | -    |
|  |  | SEER                                   | (W/W)                              | -  | -            | -                                   | -          | 4.7      | -    | -      | -    |
|  |  | Annual consumption                     | kWh                                | -  | -            | -                                   | -          | 531      | -    | -      | -    |
| Class  |  |  | -                                  | -  | -            | -                                   | B          | -        | -    | -      |      |
| Power factor   |  | %                                      | -                                  | -  | -            | 94                                  | 94         | 93       | -    | -      |      |
| Noise indoor   | dB-A (H/M/L)                             | 40/38/35                               |                                    |  | -            | -                                   | -          | -        | -    |        |      |
|  | Power Level dB                           | 57/55/52                               |                                    |  | -            | -                                   | -          | -        | -    |        |      |
| Noise outdoor  | dB-A (H/L)                               | -                                      |                                    |  | -            | 48/-                                | -          | -        | -    |        |      |
|  | Power Level dB                           | -                                      |                                    |  | -            | 65/-                                | -          | -        | -    |        |      |
| H<br>E<br>A<br>T<br>I<br>N<br>G                          | Capacity                                 | kW                                     | 8.0                                | 8.0  | 8.0          | -                                   | -          | -        | 2.0  | 9.0    |      |
|  |  | BTU/h                                  | 27300                              | 27300  | 27300        | -                                   | -          | -        | 6800 | 30700  |      |
|  | Current                                  | A                                      | 0.42×2                             | 0.43×2   | 0.44×2       | 3.35                                | 3.20       | 3.10     | -    | -      |      |
|  |  | W                                      | 90×2                               | 94×2   | 98×2         | 2.120k                              | 2.122k     | 2.124k   | -    | -      |      |
|  | Input power                              | TOTAL W                                | -                                  |  |              | 2.300k                              | 2.310k     | 2.320k   | 600  | 3.000k |      |
|  |  | COP/COP CLASS                          | TOTAL (W/W) *5 / ("A"-*G)          | -  | -            | -                                   | 3.48       | 3.46 / B | 3.45 | 3.33   | 3.00 |
|  | Erp *6                                   | Pdesign at -10°C                       | kW                                 | -  | -            | -                                   | -          | 6.1      | -    | -      | -    |
|  |  | Tbivalent                              | °C                                 | -  | -            | -                                   | -          | -9       | -    | -      | -    |
|  |  | SCOP                                   | (W/W)                              | -  | -            | -                                   | -          | 3.8      | -    | -      | -    |
|  |  | Annual consumption                     | kWh                                | -  | -            | -                                   | -          | 2245     | -    | -      | -    |
| Power factor   |  | %                                      | -                                  | -  | -            | 96                                  | 96         | 95       | -    | -      |      |
| Noise indoor   | dB-A (H/M/L)                             | 40/38/35                               |                                    |  | -            | -                                   | -          | -        | -    |        |      |
|  | Power Level dB                           | 57/55/52                               |                                    |  | -            | -                                   | -          | -        | -    |        |      |
| Noise outdoor  | dB-A (H/L)                               | -                                      |                                    |  | -            | 50/-                                | -          | -        | -    |        |      |
|  | Power Level dB                           | -                                      |                                    |  | -            | 67/-                                | -          | -        | -    |        |      |
| EXTRA LOW TEMP Total capacity(kW) / Input power(W) / COP |  | -                                      |                                    |  |              |                                     |            |          |      |        |      |
| Max Current(A) / Max Input power(W)                      |  | 0.60×2/130×2                           | 0.62×2/140×2                       | 0.63×2/150×2                                   | 7.0/4.150k   | 7.0/4.360k                          | 7.0/4.530k | -        |      |        |      |
| Starting current(A) / Comp output(W)                     |  | -                                      | -                                  | -  | 3.35/2.0k    | 3.20/2.0k                           | 3.10/2.0k  | -        |      |        |      |
| Network Impedance(ΩMAX.)                                 |  | -                                      |                                    |  |              |                                     |            |          |      |        |      |
| Fan motor output (Indoor/Outdoor) W                      |  | 60×2                                   |                                    |  | 90           |                                     |            | -        |      |        |      |
| Moisture removal volume                                  |  | L/h(Pt/h)                              | 4.2                                | (2.1×2)  | (8.8)        | -                                   |            |          | -    |        |      |
| External static pressure                                 |  | Pa                                     | 50 (MIN10 - MAX80)                 |  |              | -                                   |            |          | -    |        |      |
| Indoor Air flow  | Cooling                                  | m³/min (ft³/min)                       | [14/12/10 (494/424/353)]×2         |  |              | -                                   |            |          | -    |        |      |
|  | Heating                                  | m³/min (ft³/min)                       | [14/12/10 (494/424/353)]×2         |  |              | -                                   |            |          | -    |        |      |
| Outdoor Air flow   | Cooling                                  | m³/min (ft³/min)                       | -                                  |  |              | 60                                  | (2119)     | -        |      |        |      |
|  | Heating                                  | m³/min (ft³/min)                       | -                                  |  |              | 60                                  | (2119)     | -        |      |        |      |
| Refrigerant type / amount g(oz)                          |  | -                                      |                                    |  | R410A        | 2.35k                               | (82.9)     | -        |      |        |      |
| Product dimension  | Height                                   | mm(inch)                               | 250 (9-27/32)                      |  |              | 996 (39-77/32)                      |            |          | -    |        |      |
|  | Width                                    | mm(inch)                               | 780 (+100) (30-23/32) (+3-15/16)   |  |              | 940 (37-1/32)                       |            |          | -    |        |      |
|  | Depth                                    | mm(inch)                               | 650 (25-19/32)                     |  |              | 340 (13-13/32)                      |            |          | -    |        |      |
| Packing dimension  | Height                                   | mm(inch)                               | 345                                |  |              | 1136                                |            |          | -    |        |      |
|  | Width                                    | mm(inch)                               | 1007                               |  |              | 1055                                |            |          | -    |        |      |
|  | Depth                                    | mm(inch)                               | 777                                |  |              | 485                                 |            |          | -    |        |      |
| Weight   | (NET)                                    | kg(lb)                                 | 29 (64)                            |  |              | 71 (157)                            |            |          | -    |        |      |
|  | (GROSS)                                  | kg(lb)                                 | 34 (75)                            |  |              | 79 (174)                            |            |          | -    |        |      |
| Layers limit (actually)                                  |  | 8 (9)                                  |                                    |  | 2 (3)        |                                     |            | -        |      |        |      |
| Operation condition                                      | Cool (DBT)                               | 18°C ~ 32°C                            |                                    |  | -15°C ~ 46°C |                                     |            | -        |      |        |      |
|  | Heat (DBT)                               | 16°C ~ 30°C                            |                                    |  | -20°C ~ 24°C |                                     |            | -        |      |        |      |
| P<br>I<br>P<br>I<br>N<br>G                               | Pipe diameter mm (inch)                  |  | (Liquid)ø6.35(1/4) (Gas)ø12.7(1/2) |  |              | (Liquid)ø9.52(3/8) (Gas)ø15.88(5/8) |            |          | -    |        |      |
|  | Connecting method, Standard length m(ft) |  | flared type, 5.0(16.4)             |  |              | flared type, 5.0(16.4)              |            |          | -    |        |      |
| Pipe length range  |  | m (ft)                                 |                                    | 5 ~ 50 (16.4 ~ 164.0)                          |              | -                                   |            |          |      |        |      |
| Indoor unit & Outdoor unit height difference             |  | m (ft)                                 |                                    | 15 (OD located lower) / 30 (OD located higher) |              | (49.2/98.4)                         |            | -        |      |        |      |
| Add gas amount   |  | g/m (oz/ft)                            |                                    | 50 (0.538)                                     |              | -                                   |            |          |      |        |      |
| Pipe length for additional gas                           |  | m (ft)                                 |                                    | 30 (98.4)                                      |              | -                                   |            |          |      |        |      |

\*1: In case it is necessary to indicate the air flow volume in (l/s), the value in (m³/min.) shall be multiplied by 16.7 and rounded down the decimal point.  
 \*2: If the EUROVENT Certified models can be operated under the "extra-low" temperature condition, -7°C dry bulb and -8°C wet-bulb temperatures with rated voltage 230 V shall be used.  
 \*3: Network Impedance shall be applicable for EUROPE and CHINA models.  
 \*4: The annual consumption is calculated by multiplying the input power at 230 V (400 V) by an average of 500 hours per year in cooling mode.  
 \*5: EER and COP classification is at 230 V (400 V) only in accordance with EU directive 2002/31/EC.  
 \*6: SEER and SCOP classification is at 230V(400V) only in accordance with EN-14825. For heating, SCOP indicates the value of only Average heating season, Other fiche data indicates in an attached sheet.

# Simultaneous (Triple) -Type

## 1-1. Unit Specifications

**PE1**

### 5. Ducted Type S-36PN1E5A×3 / U-100PE1E8A

| INDOOR   |  | MODEL  | S-36PN1E5A×3                     |              |                                     | -              |            |          | -     |        |      |
|--|--|--|----------------------------------|--------------|-------------------------------------|----------------|------------|----------|-------|--------|------|
| OUTDOOR  |  | MODEL  | -                                |              |                                     | U-100PE1E8A    |            |          | -     |        |      |
| Branch pipe  |  | MODEL  | CZ-P3HPC2                        |              |                                     |                |            |          |       |        |      |
| Performance test condition                               |  | ISO13253 / EN14511 / EN14825 / EN12102         |                                  |              |                                     |                |            |          |       |        |      |
| Power supply   |  | Ø, Hz  | 1ø 50Hz                          |              |                                     | 3ø 50Hz        |            |          | Min   | Max    |      |
|  |  | V  | 220                              | 230          | 240                                 | 380            | 400        | 415      | -     | -      |      |
| C<br>O<br>O<br>L<br>I<br>N<br>G                          | Capacity                                 | kW   | 10.0                             | 10.0         | 10.0                                | -              | -          | -        | 3.3   | 12.5   |      |
|  |  | BTU/h  | 34100                            | 34100        | 34100                               | -              | -          | -        | 11300 | 42700  |      |
|  | Current                                  | A  | 0.42×3                           | 0.43×3       | 0.44×3                              | 3.95           | 3.75       | 3.60     | -     | -      |      |
|  |  | W  | 90×3                             | 94×3         | 98×3                                | 2.465k         | 2.468k     | 2.471k   | -     | -      |      |
|  | Input power                              | TOTAL W  | -                                |              |                                     | 2.735k         | 2.750k     | 2.765k   | 870   | 3.800k |      |
|  |  | Annual consumption                             | TOTAL kWh **4                    | -            |                                     |                | -          | 1375     | -     | -      | -    |
|  | EER/EER CLASS                            | TOTAL (W/W) **5 / ("A"-*G)                     | -                                | -            | -                                   | 3.66           | 3.64 / A   | 3.62     | 3.79  | 3.29   |      |
|  | Erp<br>*6                                | Pdesign  | kW                               | -            | -                                   | -              | -          | 10.0     | -     | -      | -    |
|  |  | SEER   | (W/W)                            | -            | -                                   | -              | -          | 5.0      | -     | -      | -    |
|  |  | Annual consumption                             | kWh                              | -            | -                                   | -              | -          | 700      | -     | -      | -    |
|  |  | Class  |                                  | -            | -                                   | -              | -          | B        | -     | -      | -    |
|  | Power factor                             | %  | -                                | -            | -                                   | 95             | 95         | 95       | -     | -      |      |
|  | Noise indoor                             | dB-A (H/M/L)                                   | 40/38/35                         |              |                                     | -              | -          | -        | -     | -      |      |
|  |  | Power Level dB                                 | 57/55/52                         |              |                                     | -              | -          | -        | -     | -      |      |
| Noise outdoor  | dB-A (H/L)                               | -  |                                  |              | -                                   | 52/-           | -          | -        | -     |        |      |
|  | Power Level dB                           | -  |                                  |              | -                                   | 69/-           | -          | -        | -     |        |      |
| H<br>E<br>A<br>T<br>I<br>N<br>G                          | Capacity                                 | kW   | 11.2                             | 11.2         | 11.2                                | -              | -          | -        | 4.1   | 14.0   |      |
|  |  | BTU/h  | 38200                            | 38200        | 38200                               | -              | -          | -        | 14000 | 47800  |      |
|  | Current                                  | A  | 0.42×3                           | 0.43×3       | 0.44×3                              | 4.35           | 4.15       | 4.00     | -     | -      |      |
|  |  | W  | 90×3                             | 94×3         | 98×3                                | 2.745k         | 2.748k     | 2.751k   | -     | -      |      |
|  | Input power                              | TOTAL W  | -                                |              |                                     | 3.015k         | 3.030k     | 3.045k   | 980   | 4.500k |      |
|  |  | COP/COP CLASS                                  | TOTAL (W/W) **5 / ("A"-*G)       | -            | -                                   | -              | 3.71       | 3.70 / A | 3.68  | 4.18   | 3.11 |
|  | Erp<br>*6                                | Pdesign at -10°C                               | kW                               | -            | -                                   | -              | -          | 9.9      | -     | -      | -    |
|  |  | Tbivalent                                      | °C                               | -            | -                                   | -              | -          | -9       | -     | -      | -    |
|  |  | SCOP   | (W/W)                            | -            | -                                   | -              | -          | 3.8      | -     | -      | -    |
|  |  | Annual consumption                             | kWh                              | -            | -                                   | -              | -          | 3646     | -     | -      | -    |
|  | Class                                    |  | -                                | -            | -                                   | -              | A          | -        | -     | -      |      |
|  | Power factor                             | %  | -                                | -            | -                                   | 96             | 96         | 96       | -     | -      |      |
|  | Noise indoor                             | dB-A (H/M/L)                                   | 40/38/35                         |              |                                     | -              | -          | -        | -     | -      |      |
|  |  | Power Level dB                                 | 57/55/52                         |              |                                     | -              | -          | -        | -     | -      |      |
| Noise outdoor  | dB-A (H/L)                               | -  |                                  |              | -                                   | 52/-           | -          | -        | -     |        |      |
|  | Power Level dB                           | -  |                                  |              | -                                   | 69/-           | -          | -        | -     |        |      |
| EXTRA LOW TEMP Total capacity(kW) / Input power(W) / COP |  | -  |                                  |              |                                     |                |            |          |       |        |      |
| Max Current(A) / Max Input power(W)                      |  | 0.60×3/130×3                                   | 0.62×3/140×3                     | 0.63×3/150×3 | 9.0/5.550k                          | 9.0/5.850k     | 9.0/6.100k | -        |       |        |      |
| Starting current(A) / Comp output(W)                     |  | -  | -                                | -            | 4.35/3.0k                           | 4.15/3.0k      | 4.00/3.0k  | -        |       |        |      |
| Network Impedance(ΩMAX.)                                 |  | -  |                                  |              |                                     |                |            |          |       |        |      |
| Fan motor output (Indoor/Outdoor) W                      |  | 60×3   |                                  |              | 90×2                                |                |            | -        |       |        |      |
| Moisture removal volume                                  |  | L/h(Pt/h)                                      | 6.0                              | (2.0×3)      | (12.6)                              | -              |            |          | -     |        |      |
| External static pressure                                 |  | Pa   | 50 (MIN10 - MAX80)               |              |                                     | -              |            |          | -     |        |      |
| Indoor Air flow  | Cooling                                  | m³/min (ft³/min)                               | [14/12/10 (494/424/353)]×3       |              |                                     | -              |            |          | -     |        |      |
|  | Heating                                  | m³/min (ft³/min)                               | [14/12/10 (494/424/353)]×3       |              |                                     | -              |            |          | -     |        |      |
| Outdoor Air flow   | Cooling                                  | m³/min (ft³/min)                               | -                                |              |                                     | 110            | (3885)     | -        |       |        |      |
|  | Heating                                  | m³/min (ft³/min)                               | -                                |              |                                     | 95             | (3355)     | -        |       |        |      |
| Refrigerant type / amount g(oz)                          |  | -  |                                  |              | R410A                               | 3.40k          | (119.9)    | -        |       |        |      |
| Product dimension  | Height                                   | mm(inch)                                       | 250 (9-27/32)                    |              |                                     | 1416 (55-3/4)  |            |          | -     |        |      |
|  | Width                                    | mm(inch)                                       | 780 (+100) (30-23/32) (+3-15/16) |              |                                     | 940 (37-1/32)  |            |          | -     |        |      |
|  | Depth                                    | mm(inch)                                       | 650 (25-19/32)                   |              |                                     | 340 (13-13/32) |            |          | -     |        |      |
| Packing dimension  | Height                                   | mm(inch)                                       | 345                              |              |                                     | 1556           |            |          | -     |        |      |
|  | Width                                    | mm(inch)                                       | 1007                             |              |                                     | 1055           |            |          | -     |        |      |
|  | Depth                                    | mm(inch)                                       | 777                              |              |                                     | 485            |            |          | -     |        |      |
| Weight   | (NET)                                    | kg(lb)   | 29 (64)                          |              |                                     | 98 (216)       |            |          | -     |        |      |
|  | (GROSS)                                  | kg(lb)   | 34 (75)                          |              |                                     | 108 (238)      |            |          | -     |        |      |
| Layers limit (actually)                                  |  | 8 (9)  |                                  |              | 1 (2)                               |                |            | -        |       |        |      |
| Operation condition                                      | Cool (DBT)                               | 18°C ~ 32°C                                    |                                  |              | -15°C ~ 46°C                        |                |            | -        |       |        |      |
|  | Heat (DBT)                               | 16°C ~ 30°C                                    |                                  |              | -20°C ~ 24°C                        |                |            | -        |       |        |      |
| P<br>I<br>P<br>E<br>I<br>N<br>G                          | Pipe diameter mm (inch)                  | (Liquid)ø6.35(1/4) (Gas)ø12.7(1/2)             |                                  |              | (Liquid)ø9.52(3/8) (Gas)ø15.88(5/8) |                |            | -        |       |        |      |
|  | Connecting method, Standard length m(ft) | flared type, 5.0(16.4)                         |                                  |              | flared type, 5.0(16.4)              |                |            | -        |       |        |      |
| Pipe length range m (ft)                                 |  | 5 ~ 75 (16.4 ~ 246.1)                          |                                  |              | -                                   |                |            | -        |       |        |      |
| Indoor unit & Outdoor unit height difference m (ft)      |  | 15 (OD located lower) / 30 (OD located higher) |                                  |              | (49.2/98.4)                         |                |            | -        |       |        |      |
| Add gas amount g/m (oz/ft)                               |  | 50   |                                  |              | (0.538)                             |                |            | -        |       |        |      |
| Pipe length for additional gas m (ft)                    |  | 20   |                                  |              | (65.6)                              |                |            | -        |       |        |      |

\*1: In case it is necessary to indicate the air flow volume in (l/s), the value in (m³/min.) shall be multiplied by 16.7 and rounded down the decimal point.

\*2: If the EUROVENT Certified models can be operated under the "extra-low" temperature condition, -7°C dry bulb and -8°C wet-bulb temperatures with rated voltage 230 V shall be used.

\*3: Network Impedance shall be applicable for EUROPE and CHINA models.

\*4: The annual consumption is calculated by multiplying the input power at 230 V (400 V) by an average of 500 hours per year in cooling mode.

\*5: EER and COP classification is at 230 V (400 V) only in accordance with EU directive 2002/31/EC.

\*6: SEER and SCOP classification is at 230V(400V) only in accordance with EN-14825. For heating, SCOP indicates the value of only Average heating season, Other fiche data indicates in an attached sheet.

# Simultaneous (Double-Twin) -Type

## 1-1. Unit Specifications

**PE1**

### 5. Ducted Type S-36PN1E5A×4 / U-125PE1E8A

| INDOOR   |   | MODEL  | S-36PN1E5A×4                     |              |                                     | -              |             |          | -     |        |      |
|--|---|--|----------------------------------|--------------|-------------------------------------|----------------|-------------|----------|-------|--------|------|
| OUTDOOR  |   | MODEL  | -                                |              |                                     | U-125PE1E8A    |             |          | -     |        |      |
| Branch pipe  |   | MODEL  | CZ-P155BK1×3                     |              |                                     |                |             |          |       | -      |      |
| Performance test condition                               |   | ISO13253 / EN14511 / EN12102 / EN14825         |                                  |              |                                     |                |             |          |       |        |      |
| Power supply   |   | Ø, Hz  | 1ø 50Hz                          |              |                                     | 3ø 50Hz        |             |          |       |        |      |
|  |   | V  | 220                              | 230          | 240                                 | 380            | 400         | 415      | Min   | Max    |      |
| C<br>O<br>O<br>L<br>I<br>N<br>G                          | Capacity  | kW   | 12.5                             | 12.5         | 12.5                                | -              | -           | -        | 3.3   | 14.0   |      |
|  |   | BTU/h  | 42700                            | 42700        | 42700                               | -              | -           | -        | 11300 | 47800  |      |
|  | Current   | A  | 0.42×4                           | 0.43×4       | 0.44×4                              | 5.80           | 5.50        | 5.30     | -     | -      |      |
|  |   | W  | 90×4                             | 94×4         | 98×4                                | 3.665k         | 3.669k      | 3.673k   | -     | -      |      |
|  | Input power   | TOTAL W  | -                                |              |                                     | 4.025k         | 4.045k      | 4.065k   | 1000  | 4.800k |      |
|  |   | Annual consumption                             | TOTAL kWh *4                     | -            |                                     |                | -           | 2025     | -     | -      | -    |
|  | EER/EER CLASS                                       | TOTAL (W/W) *5 / ("A"-*G)                      | -                                | -            | -                                   | 3.11           | 3.09 / B    | 3.08     | 3.30  | 2.92   |      |
|  | Erp *6  | Pdesign  | kW                               | -            | -                                   | -              | -           | 12.5     | -     | -      | -    |
|  |   | η <sub>s.c</sub>                               | %                                | -            | -                                   | -              | -           | 229.0    | -     | -      | -    |
|  |   | Annual consumption                             | kWh                              | -            | -                                   | -              | -           | -        | -     | -      | -    |
|  |   | Class  |                                  | -            | -                                   | -              | -           | -        | -     | -      | -    |
|  | Power factor  | %  | -                                | -            | -                                   | 96             | 96          | 96       | -     | -      |      |
|  | Noise indoor  | dB-A (H/M/L)                                   | 40/38/35                         |              |                                     | -              | -           | -        | -     | -      |      |
|  |   | Power Level dB                                 | 57/55/52                         |              |                                     | -              | -           | -        | -     | -      |      |
| Noise outdoor  | dB-A (H/L)  | -  |                                  |              | 53/-                                |                |             | -        | -     |        |      |
|  | Power Level dB                                      | -  |                                  |              | 70/-                                |                |             | -        | -     |        |      |
| H<br>E<br>A<br>T<br>I<br>N<br>G                          | Capacity  | kW   | 14.0                             | 14.0         | 14.0                                | -              | -           | -        | 4.1   | 16.0   |      |
|  |   | BTU/h  | 47800                            | 47800        | 47800                               | -              | -           | -        | 14000 | 54600  |      |
|  | Current   | A  | 0.42×4                           | 0.43×4       | 0.44×4                              | 5.80           | 5.50        | 5.30     | -     | -      |      |
|  |   | W  | 90×4                             | 94×4         | 98×4                                | 3.655k         | 3.659k      | 3.663k   | -     | -      |      |
|  | Input power   | TOTAL W  | -                                |              |                                     | 4.015k         | 4.035k      | 4.055k   | 1050  | 5.400k |      |
|  |   | COP/COP CLASS                                  | TOTAL (W/W) *5 / ("A"-*G)        | -            | -                                   | -              | 3.49        | 3.47 / B | 3.45  | 3.90   | 2.96 |
|  | Erp *6  | Pdesign at -10°C                               | kW                               | -            | -                                   | -              | -           | 12.5     | -     | -      | -    |
|  |   | Tbivalent                                      | °C                               | -            | -                                   | -              | -           | -7       | -     | -      | -    |
|  |   | η <sub>s.h</sub>                               | %                                | -            | -                                   | -              | -           | 144.1    | -     | -      | -    |
|  |   | Annual consumption                             | kWh                              | -            | -                                   | -              | -           | -        | -     | -      | -    |
|  | Class   |  | -                                | -            | -                                   | -              | -           | -        | -     | -      |      |
|  | Power factor  | %  | -                                | -            | -                                   | 96             | 96          | 96       | -     | -      |      |
|  | Noise indoor  | dB-A (H/M/L)                                   | 40/38/35                         |              |                                     | -              | -           | -        | -     | -      |      |
|  |   | Power Level dB                                 | 57/55/52                         |              |                                     | -              | -           | -        | -     | -      |      |
| Noise outdoor  | dB-A (H/L)  | -  |                                  |              | 53/-                                |                |             | -        | -     |        |      |
|  | Power Level dB                                      | -  |                                  |              | 70/-                                |                |             | -        | -     |        |      |
| EXTRA LOW TEMP Total capacity(kW) / Input power(W) / COP |   | -  |                                  |              |                                     |                |             |          |       |        |      |
| Max Current(A) / Max Input power(W)                      |   | 0.60×4/130×4                                   | 0.62×4/140×4                     | 0.63×4/150×4 | 10.0/6.200k                         | 10.0/6.500k    | 10.0/6.750k | -        |       |        |      |
| Starting current(A) / Comp output(W)                     |   | -  | -                                | -            | 5.80/3.0k                           | 5.50/3.0k      | 5.30/3.0k   | -        |       |        |      |
| Network Impedance(ΩMAX.)                                 |   | -  |                                  |              |                                     |                |             |          |       |        |      |
| Fan motor output (Indoor/Outdoor) W                      |   | 60×4   |                                  |              | 90×2                                |                |             | -        |       |        |      |
| Moisture removal volume                                  |   | L/h(Pt/h)                                      | 7.9                              | (1.98×4)     | (16.6)                              | -              |             |          | -     |        |      |
| External static pressure                                 |   | Pa   | 50 (MIN10 - MAX80)               |              |                                     | -              |             |          | -     |        |      |
| Indoor Air flow  | Cooling   | m³/min (ft³/min)                               | [14/12/10 (494/424/353)]×4       |              |                                     | -              |             |          | -     |        |      |
|  | Heating   | m³/min (ft³/min)                               | [14/12/10 (494/424/353)]×4       |              |                                     | -              |             |          | -     |        |      |
| Outdoor Air flow   | Cooling   | m³/min (ft³/min)                               | -                                |              |                                     | 130            | (4591)      | -        |       |        |      |
|  | Heating   | m³/min (ft³/min)                               | -                                |              |                                     | 110            | (3885)      | -        |       |        |      |
| Refrigerant type / amount g(oz)                          |   | -  |                                  |              | R410A                               | 3.40k          | (119.9)     | -        |       |        |      |
| Product dimension  | Height  | mm(inch)                                       | 250 (9-27/32)                    |              |                                     | 1416 (55-3/4)  |             |          | -     |        |      |
|  | Width   | mm(inch)                                       | 780 (+100) (30-23/32) (+3-15/16) |              |                                     | 940 (37-1/32)  |             |          | -     |        |      |
|  | Depth   | mm(inch)                                       | 650 (25-19/32)                   |              |                                     | 340 (13-13/32) |             |          | -     |        |      |
| Packing dimension  | Height  | mm(inch)                                       | 345                              |              |                                     | 1556           |             |          | -     |        |      |
|  | Width   | mm(inch)                                       | 1007                             |              |                                     | 1055           |             |          | -     |        |      |
|  | Depth   | mm(inch)                                       | 777                              |              |                                     | 485            |             |          | -     |        |      |
| Weight   | (NET)   | kg(lb)   | 29 (64)                          |              |                                     | 98 (216)       |             |          | -     |        |      |
|  | (GROSS)   | kg(lb)   | 34 (75)                          |              |                                     | 108 (238)      |             |          | -     |        |      |
| Layers limit (actually)                                  |   | 8 (9)  |                                  |              | 1 (2)                               |                |             | -        |       |        |      |
| Operation condition                                      | Cool (DBT)  | 18°C ~ 32°C                                    |                                  |              | -15°C ~ 46°C                        |                |             | -        |       |        |      |
|  | Heat (DBT)  | 16°C ~ 30°C                                    |                                  |              | -20°C ~ 24°C                        |                |             | -        |       |        |      |
| P<br>I<br>P<br>E   | Pipe diameter mm (inch)                             | (Liquid)ø6.35(1/4) (Gas)ø12.7(1/2)             |                                  |              | (Liquid)ø9.52(3/8) (Gas)ø15.88(5/8) |                |             | -        |       |        |      |
|  | Connecting method, Standard length m(ft)            | flared type, 5.0(16.4)                         |                                  |              | flared type, 5.0(16.4)              |                |             | -        |       |        |      |
| I<br>N<br>G  | Pipe length range m (ft)                            | 5 ~ 75 (16.4 ~ 246.1)                          |                                  |              | -                                   |                |             | -        |       |        |      |
|  | Indoor unit & Outdoor unit height difference m (ft) | 15 (OD located lower) / 30 (OD located higher) |                                  |              | (49.2/98.4)                         |                |             | -        |       |        |      |
| G  | Add gas amount g/m (oz/ft)                          | 50   |                                  |              | (0.538)                             |                |             | -        |       |        |      |
|  | Pipe length for additional gas m (ft)               | 20   |                                  |              | (65.6)                              |                |             | -        |       |        |      |

\*1: In case it is necessary to indicate the air flow volume in (l/s), the value in (m³/min.) shall be multiplied by 16.7 and rounded down the decimal point.

\*2: If the EUROVENT Certified models can be operated under the "extra-low" temperature condition, -7°C dry bulb and -8°C wet-bulb temperatures with rated voltage 230 V shall be used.

\*3: Network Impedance shall be applicable for EUROPE and CHINA models.

\*4: The annual consumption is calculated by multiplying the input power at 230 V (400 V) by an average of 500 hours per year in cooling mode.

\*5: EER and COP classification is at 230 V (400 V) only in accordance with EU directive 2002/31/EC.

\*6: SEER and SCOP classification is at 230V(400V) only in accordance with EN-14825. For heating, SCOP indicates the value of only Average heating season.

# Simultaneous (Triple) -Type

## 1-1. Unit Specifications

**PE1**

### 5. Ducted Type S-45PN1E5A×3 / U-125PE1E8A

| INDOOR   |  | MODEL  | S-45PN1E5A×3                     |              |                                     | -              |             |          | -     |        |      |
|--|--|--|----------------------------------|--------------|-------------------------------------|----------------|-------------|----------|-------|--------|------|
| OUTDOOR  |  | MODEL  | -                                |              |                                     | U-125PE1E8A    |             |          | -     |        |      |
| Branch pipe  |  | MODEL  | CZ-P3HPC2                        |              |                                     |                |             |          |       |        |      |
| Performance test condition                               |  | ISO13253 / EN14511 / EN12102 / EN14825         |                                  |              |                                     |                |             |          |       |        |      |
| Power supply   |  | Ø, Hz  | 1ø 50Hz                          |              |                                     | 3ø 50Hz        |             |          | Min   | Max    |      |
|  |  | V  | 220                              | 230          | 240                                 | 380            | 400         | 415      |       |        |      |
| C<br>O<br>O<br>L<br>I<br>N<br>G                          | Capacity                                 | kW   | 12.5                             | 12.5         | 12.5                                | -              | -           | -        | 3.3   | 14.0   |      |
|  |  | BTU/h  | 42700                            | 42700        | 42700                               | -              | -           | -        | 11300 | 47800  |      |
|  | Current                                  | A  | 0.54×3                           | 0.55×3       | 0.56×3                              | 5.80           | 5.50        | 5.30     | -     | -      |      |
|  |  | W  | 115×3                            | 120×3        | 125×3                               | 3.665k         | 3.665k      | 3.665k   | -     | -      |      |
|  | Input power                              | TOTAL W  | -                                |              |                                     | 4.010k         | 4.025k      | 4.040k   | 1000  | 4.800k |      |
|  |  | Annual consumption                             | TOTAL kWh *4                     | -            |                                     |                | -           | 2015     | -     | -      | -    |
|  | EER/EER CLASS                            | TOTAL (W/W) *5 / ("A"-*G)                      | -                                | -            | -                                   | 3.12           | 3.11 / B    | 3.09     | 3.30  | 2.92   |      |
|  | Erp *6                                   | Pdesign  | kW                               | -            | -                                   | -              | -           | 12.5     | -     | -      | -    |
|  |  | η <sub>s.c</sub>                               | %                                | -            | -                                   | -              | -           | 229.0    | -     | -      | -    |
|  |  | Annual consumption                             | kWh                              | -            | -                                   | -              | -           | -        | -     | -      | -    |
|  |  | Class  |                                  | -            | -                                   | -              | -           | -        | -     | -      | -    |
|  | Power factor                             | %  | -                                | -            | -                                   | 96             | 96          | 96       | -     | -      |      |
|  | Noise indoor                             | dB-A (H/M/L)                                   | 41/39/35                         |              |                                     | -              | -           | -        | -     | -      |      |
|  |  | Power Level dB                                 | 58/56/52                         |              |                                     | -              | -           | -        | -     | -      |      |
| Noise outdoor  | dB-A (H/L)                               | -  |                                  |              | 53/-                                |                |             | -        | -     |        |      |
|  | Power Level dB                           | -  |                                  |              | 70/-                                |                |             | -        | -     |        |      |
| H<br>E<br>A<br>T<br>I<br>N<br>G                          | Capacity                                 | kW   | 14.0                             | 14.0         | 14.0                                | -              | -           | -        | 4.1   | 16.0   |      |
|  |  | BTU/h  | 47800                            | 47800        | 47800                               | -              | -           | -        | 14000 | 54600  |      |
|  | Current                                  | A  | 0.54×3                           | 0.55×3       | 0.56×3                              | 5.80           | 5.50        | 5.30     | -     | -      |      |
|  |  | W  | 115×3                            | 120×3        | 125×3                               | 3.655k         | 3.655k      | 3.655k   | -     | -      |      |
|  | Input power                              | TOTAL W  | -                                |              |                                     | 4.000k         | 4.015k      | 4.030k   | 1050  | 5.400k |      |
|  |  | COP/COP CLASS                                  | TOTAL (W/W) *5 / ("A"-*G)        | -            | -                                   | -              | 3.50        | 3.49 / B | 3.47  | 3.90   | 2.96 |
|  | Erp *6                                   | Pdesign at -10°C                               | kW                               | -            | -                                   | -              | -           | 12.5     | -     | -      | -    |
|  |  | Tbivalent                                      | °C                               | -            | -                                   | -              | -           | -7       | -     | -      | -    |
|  |  | η <sub>s.h</sub>                               | %                                | -            | -                                   | -              | -           | 144.1    | -     | -      | -    |
|  |  | Annual consumption                             | kWh                              | -            | -                                   | -              | -           | -        | -     | -      | -    |
|  | Class                                    |  | -                                | -            | -                                   | -              | -           | -        | -     | -      |      |
|  | Power factor                             | %  | -                                | -            | -                                   | 96             | 96          | 96       | -     | -      |      |
|  | Noise indoor                             | dB-A (H/M/L)                                   | 41/39/35                         |              |                                     | -              |             |          | -     | -      |      |
|  |  | Power Level dB                                 | 58/56/52                         |              |                                     | -              |             |          | -     | -      |      |
| Noise outdoor  | dB-A (H/L)                               | -  |                                  |              | 53/-                                |                |             | -        | -     |        |      |
|  | Power Level dB                           | -  |                                  |              | 70/-                                |                |             | -        | -     |        |      |
| EXTRA LOW TEMP Total capacity(kW) / Input power(W) / COP |  | -  |                                  |              |                                     |                |             |          |       |        |      |
| Max Current(A) / Max Input power(W)                      |  | 0.74×3/165×3                                   | 0.76×3/180×3                     | 0.78×3/190×3 | 10.0/6.200k                         | 10.0/6.500k    | 10.0/6.750k | -        |       |        |      |
| Starting current(A) / Comp output(W)                     |  | -  | -                                | -            | 5.80/3.0k                           | 5.50/3.0k      | 5.30/3.0k   | -        |       |        |      |
| Network Impedance(ΩMAX.)                                 |  | -  |                                  |              |                                     |                |             |          |       |        |      |
| Fan motor output (Indoor/Outdoor) W                      |  | 85×3   |                                  |              | 90×2                                |                |             | -        |       |        |      |
| Moisture removal volume                                  |  | L/h(Pt/h)                                      | 7.9                              | (2.63×3)     | (16.6)                              | -              |             |          | -     |        |      |
| External static pressure                                 |  | Pa   | 50 (MIN10 - MAX80)               |              |                                     | -              |             |          | -     |        |      |
| Indoor Air flow  | Cooling                                  | m³/min (ft³/min)                               | [16/13/11 (565/459/388)]×3       |              |                                     | -              |             |          | -     |        |      |
|  | Heating                                  | m³/min (ft³/min)                               | [16/13/11 (565/459/388)]×3       |              |                                     | -              |             |          | -     |        |      |
| Outdoor Air flow   | Cooling                                  | m³/min (ft³/min)                               | -                                |              |                                     | 130            | (4591)      | -        |       |        |      |
|  | Heating                                  | m³/min (ft³/min)                               | -                                |              |                                     | 110            | (3885)      | -        |       |        |      |
| Refrigerant type / amount g(oz)                          |  | -  |                                  |              | R410A                               | 3.40k          | (119.9)     | -        |       |        |      |
| Product dimension  | Height                                   | mm(inch)                                       | 250 (9-27/32)                    |              |                                     | 1416 (55-3/4)  |             |          | -     |        |      |
|  | Width                                    | mm(inch)                                       | 780 (+100) (30-23/32) (+3-15/16) |              |                                     | 940 (37-1/32)  |             |          | -     |        |      |
|  | Depth                                    | mm(inch)                                       | 650 (25-19/32)                   |              |                                     | 340 (13-13/32) |             |          | -     |        |      |
| Packing dimension  | Height                                   | mm(inch)                                       | 345                              |              |                                     | 1556           |             |          | -     |        |      |
|  | Width                                    | mm(inch)                                       | 1007                             |              |                                     | 1055           |             |          | -     |        |      |
|  | Depth                                    | mm(inch)                                       | 777                              |              |                                     | 485            |             |          | -     |        |      |
| Weight   | (NET)                                    | kg(lb)   | 29 (64)                          |              |                                     | 98 (216)       |             |          | -     |        |      |
|  | (GROSS)                                  | kg(lb)   | 34 (75)                          |              |                                     | 108 (238)      |             |          | -     |        |      |
| Layers limit (actually)                                  |  | 8 (9)  |                                  |              | 1 (2)                               |                |             | -        |       |        |      |
| Operation condition                                      | Cool (DBT)                               | 18°C ~ 32°C                                    |                                  |              | -15°C ~ 46°C                        |                |             | -        |       |        |      |
|  | Heat (DBT)                               | 16°C ~ 30°C                                    |                                  |              | -20°C ~ 24°C                        |                |             | -        |       |        |      |
| P I P I N G  | Pipe diameter mm (inch)                  | (Liquid)ø6.35(1/4) (Gas)ø12.7(1/2)             |                                  |              | (Liquid)ø9.52(3/8) (Gas)ø15.88(5/8) |                |             | -        |       |        |      |
|  | Connecting method, Standard length m(ft) | flared type, 5.0(16.4)                         |                                  |              | flared type, 5.0(16.4)              |                |             | -        |       |        |      |
| Pipe length range  | m (ft)                                   | 5 ~ 75 (16.4 ~ 246.1)                          |                                  |              | -                                   |                |             | -        |       |        |      |
| Indoor unit & Outdoor unit height difference             | m (ft)                                   | 15 (OD located lower) / 30 (OD located higher) |                                  |              | (49.2/98.4)                         |                |             | -        |       |        |      |
| Add gas amount   | g/m (oz/ft)                              | 50   |                                  |              | (0.538)                             |                |             | -        |       |        |      |
| Pipe length for additional gas                           | m (ft)                                   | 20   |                                  |              | (65.6)                              |                |             | -        |       |        |      |

\*1: In case it is necessary to indicate the air flow volume in (l/s), the value in (m³/min.) shall be multiplied by 16.7 and rounded down the decimal point.

\*2: If the EUROVENT Certified models can be operated under the "extra-low" temperature condition, -7°C dry bulb and -8°C wet-bulb temperatures with rated voltage 230 V shall be used.

\*3: Network Impedance shall be applicable for EUROPE and CHINA models.

\*4: The annual consumption is calculated by multiplying the input power at 230 V (400 V) by an average of 500 hours per year in cooling mode.

\*5: EER and COP classification is at 230 V (400 V) only in accordance with EU directive 2002/31/EC.

\*6: SEER and SCOP classification is at 230V(400V) only in accordance with EN-14825. For heating, SCOP indicates the value of only Average heating season.



# Simultaneous (Twin) -Type

## 1-1. Unit Specifications

PE1

### 5. Ducted Type S-50PN1E5A×2 / U-100PE1E8A

| INDOOR   |  | MODEL  | S-50PN1E5A×2                     |              |                                     | -              |            |          | -     |        |      |
|--|--|--|----------------------------------|--------------|-------------------------------------|----------------|------------|----------|-------|--------|------|
| OUTDOOR  |  | MODEL  | -                                |              |                                     | U-100PE1E8A    |            |          | -     |        |      |
| Branch pipe  |  | MODEL  | CZ-P155BK1                       |              |                                     |                |            |          |       |        |      |
| Performance test condition                               |  | ISO13253 / EN14511 / EN14825 / EN12102         |                                  |              |                                     |                |            |          |       |        |      |
| Power supply   |  | Ø, Hz  | 1ø 50Hz                          |              |                                     | 3ø 50Hz        |            |          |       |        |      |
|  |  | V  | 220                              | 230          | 240                                 | 380            | 400        | 415      | Min   | Max    |      |
| C<br>O<br>O<br>L<br>I<br>N<br>G                          | Capacity                                 | kW   | 10.0                             | 10.0         | 10.0                                | -              | -          | -        | 3.3   | 12.5   |      |
|  |  | BTU/h  | 34100                            | 34100        | 34100                               | -              | -          | -        | 11300 | 42700  |      |
|  | Current                                  | A  | 0.54×2                           | 0.55×2       | 0.56×2                              | 3.95           | 3.75       | 3.60     | -     | -      |      |
|  |  | W  | 115×2                            | 120×2        | 125×2                               | 2.465k         | 2.465k     | 2.465k   | -     | -      |      |
|  | Input power                              | TOTAL W  | -                                |              |                                     | 2.695k         | 2.705k     | 2.715k   | 870   | 3.800k |      |
|  |  | Annual consumption                             | TOTAL kWh *4                     | -            |                                     |                | -          | 1355     | -     | -      | -    |
|  | EER/EER CLASS                            | TOTAL (W/W) *5 / ("A"-*G)                      | -                                | -            | -                                   | 3.71           | 3.70 / A   | 3.68     | 3.79  | 3.29   |      |
|  | Erp *6                                   | Pdesign  | kW                               | -            | -                                   | -              | -          | 10.0     | -     | -      | -    |
|  |  | SEER   | (W/W)                            | -            | -                                   | -              | -          | 5.3      | -     | -      | -    |
|  |  | Annual consumption                             | kWh                              | -            | -                                   | -              | -          | 659      | -     | -      | -    |
|  |  | Class  |                                  | -            | -                                   | -              | -          | A        | -     | -      | -    |
|  | Power factor                             | %  | -                                | -            | -                                   | 95             | 95         | 95       | -     | -      |      |
|  | Noise indoor                             | dB-A (H/M/L)                                   | 41/39/35                         |              |                                     | -              | -          | -        | -     | -      |      |
|  |  | Power Level dB                                 | 58/56/52                         |              |                                     | -              | -          | -        | -     | -      |      |
| Noise outdoor  | dB-A (H/L)                               | -  |                                  |              | -                                   | 52/-           | -          | -        | -     |        |      |
|  | Power Level dB                           | -  |                                  |              | -                                   | 69/-           | -          | -        | -     |        |      |
| H<br>E<br>A<br>T<br>I<br>N<br>G                          | Capacity                                 | kW   | 11.2                             | 11.2         | 11.2                                | -              | -          | -        | 4.1   | 14.0   |      |
|  |  | BTU/h  | 38200                            | 38200        | 38200                               | -              | -          | -        | 14000 | 47800  |      |
|  | Current                                  | A  | 0.54×2                           | 0.55×2       | 0.56×2                              | 4.35           | 4.15       | 4.00     | -     | -      |      |
|  |  | W  | 115×2                            | 120×2        | 125×2                               | 2.745k         | 2.745k     | 2.745k   | -     | -      |      |
|  | Input power                              | TOTAL W  | -                                |              |                                     | 2.975k         | 2.985k     | 2.995k   | 980   | 4.500k |      |
|  |  | COP/COP CLASS                                  | TOTAL (W/W) *5 / ("A"-*G)        | -            | -                                   | -              | 3.76       | 3.75 / A | 3.74  | 4.18   | 3.11 |
|  | Erp *6                                   | Pdesign at -10°C                               | kW                               | -            | -                                   | -              | -          | 9.9      | -     | -      | -    |
|  |  | Tbivalent                                      | °C                               | -            | -                                   | -              | -          | -9       | -     | -      | -    |
|  |  | SCOP   | (W/W)                            | -            | -                                   | -              | -          | 3.8      | -     | -      | -    |
|  |  | Annual consumption                             | kWh                              | -            | -                                   | -              | -          | 3646     | -     | -      | -    |
|  | Class                                    |  | -                                | -            | -                                   | -              | A          | -        | -     | -      |      |
|  | Power factor                             | %  | -                                | -            | -                                   | 96             | 95         | 95       | -     | -      |      |
|  | Noise indoor                             | dB-A (H/M/L)                                   | 41/39/35                         |              |                                     | -              | -          | -        | -     | -      |      |
|  |  | Power Level dB                                 | 58/56/52                         |              |                                     | -              | -          | -        | -     | -      |      |
| Noise outdoor  | dB-A (H/L)                               | -  |                                  |              | -                                   | 52/-           | -          | -        | -     |        |      |
|  | Power Level dB                           | -  |                                  |              | -                                   | 69/-           | -          | -        | -     |        |      |
| EXTRA LOW TEMP Total capacity(kW) / Input power(W) / COP |  | -  |                                  |              |                                     |                |            |          |       |        |      |
| Max Current(A) / Max Input power(W)                      |  | 0.74×2/165×2                                   | 0.76×2/180×2                     | 0.78×2/190×2 | 9.0/5.550k                          | 9.0/5.850k     | 9.0/6.100k | -        |       |        |      |
| Starting current(A) / Comp output(W)                     |  | -  | -                                | -            | 4.35/3.0k                           | 4.15/3.0k      | 4.00/3.0k  | -        |       |        |      |
| Network Impedance(ΩMAX.)                                 |  | -  |                                  |              |                                     |                |            |          |       |        |      |
| Fan motor output (Indoor/Outdoor) W                      |  | 85×2   |                                  |              | 90×2                                |                |            | -        |       |        |      |
| Moisture removal volume                                  |  | L/h(Pt/h)                                      | 6.0                              | (3.0×2)      | (12.6)                              | -              |            |          | -     |        |      |
| External static pressure                                 |  | Pa   | 50 (MIN10 - MAX80)               |              |                                     | -              |            |          | -     |        |      |
| Indoor Air flow  | Cooling                                  | m³/min (ft³/min)                               | [16/13/11 (565/459/388)]×2       |              |                                     | -              |            |          | -     |        |      |
|  | Heating                                  | m³/min (ft³/min)                               | [16/13/11 (565/459/388)]×2       |              |                                     | -              |            |          | -     |        |      |
| Outdoor Air flow   | Cooling                                  | m³/min (ft³/min)                               | -                                |              |                                     | 110            | (3885)     | -        |       |        |      |
|  | Heating                                  | m³/min (ft³/min)                               | -                                |              |                                     | 95             | (3355)     | -        |       |        |      |
| Refrigerant type / amount g(oz)                          |  | -  |                                  |              | R410A                               | 3.40k          | (119.9)    | -        |       |        |      |
| Product dimension  | Height                                   | mm(inch)                                       | 250 (9-27/32)                    |              |                                     | 1416 (55-3/4)  |            |          | -     |        |      |
|  | Width                                    | mm(inch)                                       | 780 (+100) (30-23/32) (+3-15/16) |              |                                     | 940 (37-1/32)  |            |          | -     |        |      |
|  | Depth                                    | mm(inch)                                       | 650 (25-19/32)                   |              |                                     | 340 (13-13/32) |            |          | -     |        |      |
| Packing dimension  | Height                                   | mm(inch)                                       | 345                              |              |                                     | 1556           |            |          | -     |        |      |
|  | Width                                    | mm(inch)                                       | 1007                             |              |                                     | 1055           |            |          | -     |        |      |
|  | Depth                                    | mm(inch)                                       | 777                              |              |                                     | 485            |            |          | -     |        |      |
| Weight   | (NET)                                    | kg(lb)   | 29 (64)                          |              |                                     | 98 (216)       |            |          | -     |        |      |
|  | (GROSS)                                  | kg(lb)   | 34 (75)                          |              |                                     | 108 (238)      |            |          | -     |        |      |
| Layers limit (actually)                                  |  | 8 (9)  |                                  |              | 1 (2)                               |                |            | -        |       |        |      |
| Operation condition                                      | Cool (DBT)                               | 18°C ~ 32°C                                    |                                  |              | -15°C ~ 46°C                        |                |            | -        |       |        |      |
|  | Heat (DBT)                               | 16°C ~ 30°C                                    |                                  |              | -20°C ~ 24°C                        |                |            | -        |       |        |      |
| P I P I N G  | Pipe diameter mm (inch)                  | (Liquid)ø6.35(1/4) (Gas)ø12.7(1/2)             |                                  |              | (Liquid)ø9.52(3/8) (Gas)ø15.88(5/8) |                |            | -        |       |        |      |
|  | Connecting method, Standard length m(ft) | flared type, 5.0(16.4)                         |                                  |              | flared type, 5.0(16.4)              |                |            | -        |       |        |      |
| Pipe length range  | m (ft)                                   | 5 ~ 75 (16.4 ~ 246.1)                          |                                  |              | -                                   |                |            | -        |       |        |      |
| Indoor unit & Outdoor unit height difference             | m (ft)                                   | 15 (OD located lower) / 30 (OD located higher) |                                  |              | (49.2/98.4)                         |                |            | -        |       |        |      |
| Add gas amount   | g/m (oz/ft)                              | 50   |                                  |              | (0.538)                             |                |            | -        |       |        |      |
| Pipe length for additional gas                           | m (ft)                                   | 30   |                                  |              | (98.4)                              |                |            | -        |       |        |      |

\*1: In case it is necessary to indicate the air flow volume in (l/s), the value in (m³/min.) shall be multiplied by 16.7 and rounded down the decimal point.  
 \*2: If the EUROVENT Certified models can be operated under the "extra-low" temperature condition, -7°C dry bulb and -8°C wet-bulb temperatures with rated voltage 230 V shall be used.  
 \*3: Network Impedance shall be applicable for EUROPE and CHINA models.  
 \*4: The annual consumption is calculated by multiplying the input power at 230 V (400 V) by an average of 500 hours per year in cooling mode.  
 \*5: EER and COP classification is at 230 V (400 V) only in accordance with EU directive 2002/31/EC.  
 \*6: SEER and SCOP classification is at 230V(400V) only in accordance with EN-14825. For heating, SCOP indicates the value of only Average heating season, Other fiche data indicates in an attached sheet.

# Simultaneous (Triple) -Type

## 1-1. Unit Specifications

**PE1**

### 5. Ducted Type S-50PN1E5A×3 / U-140PE1E8A

| INDOOR   |  | MODEL                                  | S-50PN1E5A×3                        |  |                                     | -              |             |          | -     |        |      |
|--|--|--|-------------------------------------|--|-------------------------------------|----------------|-------------|----------|-------|--------|------|
| OUTDOOR  |  | MODEL                                  | -                                   |  |                                     | U-140PE1E8A    |             |          | -     |        |      |
| Branch pipe  |  | MODEL                                  | CZ-P3HPC2                           |  |                                     |                |             |          |       |        |      |
| Performance test condition                               |  | ISO13253 / EN14511 / EN12102 / EN14825 |                                     |  |                                     |                |             |          |       |        |      |
| Power supply   |  | Ø, Hz                                  | 1ø 50Hz                             |  |                                     | 3ø 50Hz        |             |          | Min   | Max    |      |
|  |  | V                                      | 220                                 | 230  | 240                                 | 380            | 400         | 415      |       |        |      |
| C<br>O<br>O<br>L<br>I<br>N<br>G                          | Capacity                                 | kW                                     | 14.0                                | 14.0   | 14.0                                | -              | -           | -        | 3.3   | 15.5   |      |
|  |  | BTU/h                                  | 47800                               | 47800  | 47800                               | -              | -           | -        | 11300 | 52900  |      |
|  | Current                                  | A                                      | 0.54×3                              | 0.55×3   | 0.56×3                              | 6.95           | 6.60        | 6.35     | -     | -      |      |
|  |  | W                                      | 115×3                               | 120×3  | 125×3                               | 4.400k         | 4.400k      | 4.400k   | -     | -      |      |
|  | Input power                              | TOTAL W                                | -                                   |  |                                     | 4.745k         | 4.760k      | 4.775k   | 1000  | 6.200k |      |
|  |  | Annual consumption                     | TOTAL kWh *4                        | -  |                                     |                | -           | 2380     | -     | -      | -    |
|  | EER/EER CLASS                            | TOTAL (W/W) <sup>5</sup> / ("A"-°G)    | -                                   | -  | -                                   | 2.95           | 2.94 / C    | 2.93     | 3.30  | 2.50   |      |
|  | Erp <sup>*6</sup>                        | Pdesign                                | kW                                  | -  | -                                   | -              | -           | 14.0     | -     | -      | -    |
|  |  | η <sub>s.c</sub>                       | %                                   | -  | -                                   | -              | -           | 219.8    | -     | -      | -    |
|  |  | Annual consumption                     | kWh                                 | -  | -                                   | -              | -           | -        | -     | -      | -    |
|  |  | Class                                  |                                     | -  | -                                   | -              | -           | -        | -     | -      | -    |
|  | Power factor                             | %                                      | -                                   | -  | -                                   | 96             | 96          | 96       | -     | -      |      |
|  | Noise indoor                             | dB-A (H/M/L)                           | 41/39/35                            |  |                                     | -              | -           | -        | -     | -      |      |
|  |  | Power Level dB                         | 58/56/52                            |  |                                     | -              | -           | -        | -     | -      |      |
| Noise outdoor  | dB-A (H/L)                               | -                                      |                                     |  | 54/-                                |                |             | -        | -     |        |      |
|  | Power Level dB                           | -                                      |                                     |  | 71/-                                |                |             | -        | -     |        |      |
| H<br>E<br>A<br>T<br>I<br>N<br>G                          | Capacity                                 | kW                                     | 16.0                                | 16.0   | 16.0                                | -              | -           | -        | 4.1   | 18.0   |      |
|  |  | BTU/h                                  | 54600                               | 54600  | 54600                               | -              | -           | -        | 14000 | 61400  |      |
|  | Current                                  | A                                      | 0.54×3                              | 0.55×3   | 0.56×3                              | 7.00           | 6.65        | 6.45     | -     | -      |      |
|  |  | W                                      | 115×3                               | 120×3  | 125×3                               | 4.440k         | 4.440k      | 4.440k   | -     | -      |      |
|  | Input power                              | TOTAL W                                | -                                   |  |                                     | 4.785k         | 4.800k      | 4.815k   | 1050  | 6.100k |      |
|  |  | COP/COP CLASS                          | TOTAL (W/W) <sup>5</sup> / ("A"-°G) | -  | -                                   | -              | 3.34        | 3.33 / C | 3.32  | 3.90   | 2.95 |
|  | Erp <sup>*6</sup>                        | Pdesign at -10°C                       | kW                                  | -  | -                                   | -              | -           | 14.0     | -     | -      | -    |
|  |  | Tbivalent                              | °C                                  | -  | -                                   | -              | -           | -7       | -     | -      | -    |
|  |  | η <sub>s.h</sub>                       | %                                   | -  | -                                   | -              | -           | 140.7    | -     | -      | -    |
|  |  | Annual consumption                     | kWh                                 | -  | -                                   | -              | -           | -        | -     | -      | -    |
|  | Class                                    |  | -                                   | -  | -                                   | -              | -           | -        | -     | -      |      |
|  | Power factor                             | %                                      | -                                   | -  | -                                   | 96             | 96          | 96       | -     | -      |      |
|  | Noise indoor                             | dB-A (H/M/L)                           | 41/39/35                            |  |                                     | -              |             |          | -     | -      |      |
|  |  | Power Level dB                         | 58/56/52                            |  |                                     | -              |             |          | -     | -      |      |
| Noise outdoor  | dB-A (H/L)                               | -                                      |                                     |  | 55/-                                |                |             | -        | -     |        |      |
|  | Power Level dB                           | -                                      |                                     |  | 71/-                                |                |             | -        | -     |        |      |
| EXTRA LOW TEMP Total capacity(kW) / Input power(W) / COP |  | -                                      |                                     |  |                                     |                |             |          |       |        |      |
| Max Current(A) / Max Input power(W)                      |  | 0.74×3/165×3                           | 0.76×3/180×3                        | 0.78×3/190×3                                   | 11.0/6.800k                         | 11.0/7.150k    | 11.0/7.450k | -        |       |        |      |
| Starting current(A) / Comp output(W)                     |  | -                                      | -                                   | -  | 7.00/3.0k                           | 6.65/3.0k      | 6.45/3.0k   | -        |       |        |      |
| Network Impedance(ΩMAX.)                                 |  | -                                      |                                     |  |                                     |                |             |          |       |        |      |
| Fan motor output (Indoor/Outdoor) W                      |  | 85×3                                   |                                     |  | 90×2                                |                |             | -        |       |        |      |
| Moisture removal volume                                  |  | L/h(Pt/h)                              | 9.0                                 | (3.0×3)  | (18.9)                              | -              |             |          | -     |        |      |
| External static pressure                                 |  | Pa                                     | 50 (MIN10 - MAX80)                  |  |                                     | -              |             |          | -     |        |      |
| Indoor Air flow  | Cooling                                  | m³/min (ft³/min)                       | [16/13/11 (565/459/388)]×3          |  |                                     | -              |             |          | -     |        |      |
|  | Heating                                  | m³/min (ft³/min)                       | [16/13/11 (565/459/388)]×3          |  |                                     | -              |             |          | -     |        |      |
| Outdoor Air flow   | Cooling                                  | m³/min (ft³/min)                       | -                                   |  |                                     | 135            | (4767)      | -        |       |        |      |
|  | Heating                                  | m³/min (ft³/min)                       | -                                   |  |                                     | 120            | (4238)      | -        |       |        |      |
| Refrigerant type / amount g(oz)                          |  | -                                      |                                     |  | R410A                               | 3.40k          | (119.9)     | -        |       |        |      |
| Product dimension  | Height                                   | mm(inch)                               | 250 (9-27/32)                       |  |                                     | 1416 (55-3/4)  |             |          | -     |        |      |
|  | Width                                    | mm(inch)                               | 780 (+100) (30-23/32) (+3-15/16)    |  |                                     | 940 (37-1/32)  |             |          | -     |        |      |
|  | Depth                                    | mm(inch)                               | 650 (25-19/32)                      |  |                                     | 340 (13-13/32) |             |          | -     |        |      |
| Packing dimension  | Height                                   | mm(inch)                               | 345                                 |  |                                     | 1556           |             |          | -     |        |      |
|  | Width                                    | mm(inch)                               | 1007                                |  |                                     | 1055           |             |          | -     |        |      |
|  | Depth                                    | mm(inch)                               | 777                                 |  |                                     | 485            |             |          | -     |        |      |
| Weight   | (NET)                                    | kg(lb)                                 | 29 (64)                             |  |                                     | 98 (216)       |             |          | -     |        |      |
|  | (GROSS)                                  | kg(lb)                                 | 34 (75)                             |  |                                     | 108 (238)      |             |          | -     |        |      |
| Layers limit (actually)                                  |  | 8 (9)                                  |                                     |  | 1 (2)                               |                |             | -        |       |        |      |
| Operation condition                                      | Cool (DBT)                               | 18°C ~ 32°C                            |                                     |  | -15°C ~ 46°C                        |                |             | -        |       |        |      |
|  | Heat (DBT)                               | 16°C ~ 30°C                            |                                     |  | -20°C ~ 24°C                        |                |             | -        |       |        |      |
| P<br>I<br>P<br>E<br>I<br>N<br>G                          | Pipe diameter mm (inch)                  | (Liquid)ø6.35(1/4) (Gas)ø12.7(1/2)     |                                     |  | (Liquid)ø9.52(3/8) (Gas)ø15.88(5/8) |                |             | -        |       |        |      |
|  | Connecting method, Standard length m(ft) | flared type, 5.0(16.4)                 |                                     |  | flared type, 5.0(16.4)              |                |             | -        |       |        |      |
| Pipe length range  |  | m (ft)                                 |                                     | 5 ~ 75   | (16.4 ~ 246.1)                      |                | -           |          |       |        |      |
| Indoor unit & Outdoor unit height difference             |  | m (ft)                                 |                                     | 15 (OD located lower) / 30 (OD located higher) |                                     | (49.2/98.4)    |             | -        |       |        |      |
| Add gas amount   |  | g/m (oz/ft)                            |                                     | 50   |                                     | (0.538)        |             | -        |       |        |      |
| Pipe length for additional gas                           |  | m (ft)                                 |                                     | 20   |                                     | (65.6)         |             | -        |       |        |      |

\*1: In case it is necessary to indicate the air flow volume in (l/s), the value in (m³/min.) shall be multiplied by 16.7 and rounded down the decimal point.

\*2: If the EUROVENT Certified models can be operated under the "extra-low" temperature condition, -7°C dry bulb and -8°C wet-bulb temperatures with rated voltage 230 V shall be used.

\*3: Network Impedance shall be applicable for EUROPE and CHINA models.

\*4: The annual consumption is calculated by multiplying the input power at 230 V (400 V) by an average of 500 hours per year in cooling mode.

\*5: EER and COP classification is at 230 V (400 V) only in accordance with EU directive 2002/31/EC.

\*6: SEER and SCOP classification is at 230V(400V) only in accordance with EN-14825. For heating, SCOP indicates the value of only Average heating season.

# Simultaneous (Twin) -Type

## 1-1. Unit Specifications

PE1

### 5. Ducted Type S-60PN1E5A×2 / U-125PE1E8A

| INDOOR   |  | MODEL                                  | S-60PN1E5A×2                        |  |              | -                                   |             |          | -     |        |      |
|--|--|--|-------------------------------------|--|--------------|-------------------------------------|-------------|----------|-------|--------|------|
| OUTDOOR  |  | MODEL                                  | -                                   |  |              | U-125PE1E8A                         |             |          | -     |        |      |
| Branch pipe  |  | MODEL                                  | CZ-P155BK1                          |  |              |                                     |             |          |       |        |      |
| Performance test condition                               |  | ISO13253 / EN14511 / EN12102 / EN14825 |                                     |  |              |                                     |             |          |       |        |      |
| Power supply   |  | Ø, Hz                                  | 1ø 50Hz                             |  |              | 3ø 50Hz                             |             |          |       |        |      |
|  |  | V                                      | 220                                 | 230  | 240          | 380                                 | 400         | 415      | Min   | Max    |      |
| C<br>O<br>O<br>L<br>I<br>N<br>G                          | Capacity                                 | kW                                     | 12.5                                | 12.5   | 12.5         | -                                   | -           | -        | 3.3   | 14.0   |      |
|  |  | BTU/h                                  | 42700                               | 42700  | 42700        | -                                   | -           | -        | 11300 | 47800  |      |
|  | Current                                  | A                                      | 1.12×2                              | 1.08×2   | 1.04×2       | 5.80                                | 5.50        | 5.30     | -     | -      |      |
|  |  | W                                      | 140×2                               | 140×2  | 140×2        | 3.665k                              | 3.665k      | 3.665k   | -     | -      |      |
|  | Input power                              | TOTAL W                                | -                                   |  |              | 3.945k                              | 3.945k      | 3.945k   | 1000  | 4.800k |      |
|  |  | Annual consumption                     | TOTAL kWh *4                        | -  |              |                                     | -           | 1975     | -     | -      | -    |
|  | EER/EER CLASS                            |  | TOTAL (W/W) *5 / ("A"-*G)           | -  | -            | -                                   | 3.17        | 3.17 / B | 3.17  | 3.30   | 2.92 |
|  | Erp *6                                   | Pdesign                                | kW                                  | -  | -            | -                                   | -           | 12.5     | -     | -      | -    |
|  |  | η s.c                                  | %                                   | -  | -            | -                                   | -           | 229.0    | -     | -      | -    |
|  |  | Annual consumption                     | kWh                                 | -  | -            | -                                   | -           | -        | -     | -      | -    |
| Class  |  |  | -                                   | -  | -            | -                                   | -           | -        | -     | -      |      |
| Power factor   |  | %                                      | -                                   | -  | -            | 96                                  | 96          | 96       | -     | -      |      |
| Noise indoor   | dB-A (H/M/L)                             | 43/41/36                               |                                     |  | -            | -                                   | -           | -        | -     |        |      |
|  | Power Level dB                           | 60/58/53                               |                                     |  | -            | -                                   | -           | -        | -     |        |      |
| Noise outdoor  | dB-A (H/L)                               | -                                      |                                     |  | -            | 53/-                                |             | -        | -     |        |      |
|  | Power Level dB                           | -                                      |                                     |  | -            | 70/-                                |             | -        | -     |        |      |
| H<br>E<br>A<br>T<br>I<br>N<br>G                          | Capacity                                 | kW                                     | 14.0                                | 14.0   | 14.0         | -                                   | -           | -        | 4.1   | 16.0   |      |
|  |  | BTU/h                                  | 47800                               | 47800  | 47800        | -                                   | -           | -        | 14000 | 54600  |      |
|  | Current                                  | A                                      | 1.12×2                              | 1.08×2   | 1.04×2       | 5.80                                | 5.50        | 5.30     | -     | -      |      |
|  |  | W                                      | 140×2                               | 140×2  | 140×2        | 3.655k                              | 3.655k      | 3.655k   | -     | -      |      |
|  | Input power                              | TOTAL W                                | -                                   |  |              | 3.935k                              | 3.935k      | 3.935k   | 1050  | 5.400k |      |
|  |  | COP/COP CLASS                          | TOTAL (W/W) *5 / ("A"-*G)           | -  | -            | -                                   | 3.56        | 3.56 / B | 3.56  | 3.90   | 2.96 |
|  | Erp *6                                   | Pdesign at -10°C                       | kW                                  | -  | -            | -                                   | -           | 12.5     | -     | -      | -    |
|  |  | Tbivalent                              | °C                                  | -  | -            | -                                   | -           | -7       | -     | -      | -    |
|  |  | η s.h                                  | %                                   | -  | -            | -                                   | -           | 144.1    | -     | -      | -    |
|  |  | Annual consumption                     | kWh                                 | -  | -            | -                                   | -           | -        | -     | -      | -    |
| Power factor   |  | %                                      | -                                   | -  | -            | 96                                  | 96          | 96       | -     | -      |      |
| Noise indoor   | dB-A (H/M/L)                             | 43/41/36                               |                                     |  | -            | -                                   | -           | -        | -     |        |      |
|  | Power Level dB                           | 60/58/53                               |                                     |  | -            | -                                   | -           | -        | -     |        |      |
| Noise outdoor  | dB-A (H/L)                               | -                                      |                                     |  | -            | 53/-                                |             | -        | -     |        |      |
|  | Power Level dB                           | -                                      |                                     |  | -            | 70/-                                |             | -        | -     |        |      |
| EXTRA LOW TEMP Total capacity(kW) / Input power(W) / COP |  | -                                      |                                     |  |              |                                     |             |          |       |        |      |
| Max Current(A) / Max Input power(W)                      |  | 1.28×2/160×2                           | 1.24×2/160×2                        | 1.20×2/160×2                                   | 10.0/6.200k  | 10.0/6.500k                         | 10.0/6.750k | -        |       |        |      |
| Starting current(A) / Comp output(W)                     |  | -                                      | -                                   | -  | 5.80/3.0k    | 5.50/3.0k                           | 5.30/3.0k   | -        |       |        |      |
| Network Impedance(ΩMAX.)                                 |  | -                                      |                                     |  |              |                                     |             |          |       |        |      |
| Fan motor output (Indoor/Outdoor) W                      |  | 120×2                                  |                                     |  | 90×2         |                                     |             | -        |       |        |      |
| Moisture removal volume                                  |  | L/h(Pt/h)                              | 7.9                                 | (3.95×2)                                       | (16.6)       | -                                   |             |          | -     |        |      |
| External static pressure                                 |  | Pa                                     | 50 (MIN10 - MAX80)                  |  |              | -                                   |             |          | -     |        |      |
| Indoor Air flow  | Cooling                                  | m³/min (ft³/min)                       | [22/20/16 (777/706/565)]×2          |  |              | -                                   |             |          | -     |        |      |
|  | Heating                                  | m³/min (ft³/min)                       | [22/20/16 (777/706/565)]×2          |  |              | -                                   |             |          | -     |        |      |
| Outdoor Air flow   | Cooling                                  | m³/min (ft³/min)                       | -                                   |  |              | 130                                 | (4591)      | -        |       |        |      |
|  | Heating                                  | m³/min (ft³/min)                       | -                                   |  |              | 110                                 | (3885)      | -        |       |        |      |
| Refrigerant type / amount g(oz)                          |  | -                                      |                                     |  | R410A        | 3.40k                               | (119.9)     | -        |       |        |      |
| Product dimension  | Height                                   | mm(inch)                               | 250 (9-27/32)                       |  |              | 1416 (55-3/4)                       |             |          | -     |        |      |
|  | Width                                    | mm(inch)                               | 1000 (+100) (39-5/16) (+3-15/16)    |  |              | 940 (37-1/32)                       |             |          | -     |        |      |
|  | Depth                                    | mm(inch)                               | 650 (25-19/32)                      |  |              | 340 (13-13/32)                      |             |          | -     |        |      |
| Packing dimension  | Height                                   | mm(inch)                               | 338                                 |  |              | 1556                                |             |          | -     |        |      |
|  | Width                                    | mm(inch)                               | 1211                                |  |              | 1055                                |             |          | -     |        |      |
|  | Depth                                    | mm(inch)                               | 761                                 |  |              | 485                                 |             |          | -     |        |      |
| Weight   | (NET)                                    | kg(lb)                                 | 32 (71)                             |  |              | 98 (216)                            |             |          | -     |        |      |
|  | (GROSS)                                  | kg(lb)                                 | 38 (84)                             |  |              | 108 (238)                           |             |          | -     |        |      |
| Layers limit (actually)                                  |  | 6 (7)                                  |                                     |  | 1 (2)        |                                     |             | -        |       |        |      |
| Operation condition                                      | Cool (DBT)                               | 18°C ~ 32°C                            |                                     |  | -15°C ~ 46°C |                                     |             | -        |       |        |      |
|  | Heat (DBT)                               | 16°C ~ 30°C                            |                                     |  | -20°C ~ 24°C |                                     |             | -        |       |        |      |
| P I P I N G  | Pipe diameter mm (inch)                  |  | (Liquid)ø9.52(3/8) (Gas)ø15.88(5/8) |  |              | (Liquid)ø9.52(3/8) (Gas)ø15.88(5/8) |             |          | -     |        |      |
|  | Connecting method, Standard length m(ft) |  | flared type, 5.0(16.4)              |  |              | flared type, 5.0(16.4)              |             |          | -     |        |      |
| Pipe length range  |  | m (ft)                                 |                                     | 5 ~ 75 (16.4 ~ 246.1)                          |              | -                                   |             |          |       |        |      |
| Indoor unit & Outdoor unit height difference             |  | m (ft)                                 |                                     | 15 (OD located lower) / 30 (OD located higher) |              | (49.2/98.4)                         |             | -        |       |        |      |
| Add gas amount   |  | g/m (oz/ft)                            |                                     | 50 (0.538)                                     |              | -                                   |             |          |       |        |      |
| Pipe length for additional gas                           |  | m (ft)                                 |                                     | 30 (98.4)                                      |              | -                                   |             |          |       |        |      |

\*1: In case it is necessary to indicate the air flow volume in (l/s), the value in (m³/min.) shall be multiplied by 16.7 and rounded down the decimal point.  
 \*2: If the EUROVENT Certified models can be operated under the "extra-low" temperature condition, -7°C dry bulb and -8°C wet-bulb temperatures with rated voltage 230 V shall be used.  
 \*3: Network Impedance shall be applicable for EUROPE and CHINA models.  
 \*4: The annual consumption is calculated by multiplying the input power at 230 V (400 V) by an average of 500 hours per year in cooling mode.  
 \*5: EER and COP classification is at 230 V (400 V) only in accordance with EU directive 2002/31/EC.  
 \*6: SEER and SCOP classification is at 230V(400V) only in accordance with EN-14825. For heating, SCOP indicates the value of only Average heating season.

# Single -Type

## 1-1. Unit Specifications

**PE1**

### 5. Ducted Type S-71PN1E5A / U-71PE1E8A

| INDOOR   |  | MODEL  | S-71PN1E5A                       |          |                                     | -              |            |          | -    |        |      |
|--|--|--|----------------------------------|----------|-------------------------------------|----------------|------------|----------|------|--------|------|
| OUTDOOR  |  | MODEL  | -                                |          |                                     | U-71PE1E8A     |            |          | -    |        |      |
| Branch pipe  |  | MODEL  | -                                |          |                                     | -              |            |          | -    |        |      |
| Performance test condition                               |  | ISO13253 / EN14511 / EN14825 / EN12102         |                                  |          |                                     |                |            |          |      |        |      |
| Power supply   |  | Ø, Hz  | 1ø 50Hz                          |          |                                     | 3ø 50Hz        |            |          | Min  | Max    |      |
|  |  | V  | 220                              | 230      | 240                                 | 380            | 400        | 415      | -    | -      |      |
| C<br>O<br>O<br>L<br>I<br>N<br>G                          | Capacity                                 | kW   | 7.1                              | 7.1      | 7.1                                 | -              | -          | -        | 2.5  | 8.0    |      |
|  |  | BTU/h  | 24200                            | 24200    | 24200                               | -              | -          | -        | 8500 | 27300  |      |
|  | Current                                  | A  | 1.12                             | 1.08     | 1.04                                | 3.25           | 3.10       | 3.00     | -    | -      |      |
|  |  | W  | 140                              | 140      | 140                                 | 2.010k         | 2.010k     | 2.010k   | -    | -      |      |
|  | Input power                              | TOTAL W  | -                                | -        | -                                   | 2.150k         | 2.150k     | 2.150k   | 660  | 2.750k |      |
|  |  | Annual consumption                             | TOTAL kWh **4                    | -        | -                                   | -              | 1075       | -        | -    | -      | -    |
|  | EER/EER CLASS                            | TOTAL (W/W) **5 / ("A"-*G)                     | -                                | -        | -                                   | 3.30           | 3.30 / A   | 3.30     | 3.79 | 2.91   |      |
|  | Erp<br>*6                                | Pdesign  | kW                               | -        | -                                   | -              | -          | 7.1      | -    | -      | -    |
|  |  | SEER   | (W/W)                            | -        | -                                   | -              | -          | 5.1      | -    | -      | -    |
|  |  | Annual consumption                             | kWh                              | -        | -                                   | -              | -          | 487      | -    | -      | -    |
|  |  | Class  |                                  | -        | -                                   | -              | -          | A        | -    | -      | -    |
|  | Power factor                             | %  | -                                | -        | -                                   | 94             | 94         | 93       | -    | -      |      |
|  | Noise indoor                             | dB-A (H/M/L)                                   | 43/41/36                         |          |                                     | -              | -          | -        | -    | -      |      |
|  |  | Power Level dB                                 | 60/58/53                         |          |                                     | -              | -          | -        | -    | -      |      |
| Noise outdoor  | dB-A (H/L)                               | -  |                                  |          | -                                   | 48/-           | -          | -        | -    |        |      |
|  | Power Level dB                           | -  |                                  |          | -                                   | 65/-           | -          | -        | -    |        |      |
| H<br>E<br>A<br>T<br>I<br>N<br>G                          | Capacity                                 | kW   | 8.0                              | 8.0      | 8.0                                 | -              | -          | -        | 2.0  | 9.0    |      |
|  |  | BTU/h  | 27300                            | 27300    | 27300                               | -              | -          | -        | 6800 | 30700  |      |
|  | Current                                  | A  | 1.12                             | 1.08     | 1.04                                | 3.35           | 3.20       | 3.10     | -    | -      |      |
|  |  | W  | 140                              | 140      | 140                                 | 2.120k         | 2.120k     | 2.120k   | -    | -      |      |
|  | Input power                              | TOTAL W  | -                                | -        | -                                   | 2.260k         | 2.260k     | 2.260k   | 600  | 3.000k |      |
|  |  | COP/COP CLASS                                  | TOTAL (W/W) **7 / ("A"-*G)       | -        | -                                   | -              | 3.54       | 3.54 / B | 3.54 | 3.33   | 3.00 |
|  | Erp<br>*6                                | Pdesign at -10°C                               | kW                               | -        | -                                   | -              | -          | 6.2      | -    | -      | -    |
|  |  | Tbivalent                                      | °C                               | -        | -                                   | -              | -          | -9       | -    | -      | -    |
|  |  | SCOP   | (W/W)                            | -        | -                                   | -              | -          | 3.8      | -    | -      | -    |
|  |  | Annual consumption                             | kWh                              | -        | -                                   | -              | -          | 2284     | -    | -      | -    |
|  | Class                                    |  | -                                | -        | -                                   | -              | A          | -        | -    | -      |      |
|  | Power factor                             | %  | -                                | -        | -                                   | 96             | 96         | 95       | -    | -      |      |
|  | Noise indoor                             | dB-A (H/M/L)                                   | 43/41/36                         |          |                                     | -              | -          | -        | -    | -      |      |
|  |  | Power Level dB                                 | 60/58/53                         |          |                                     | -              | -          | -        | -    | -      |      |
| Noise outdoor  | dB-A (H/L)                               | -  |                                  |          | -                                   | 50/-           | -          | -        | -    |        |      |
|  | Power Level dB                           | -  |                                  |          | -                                   | 67/-           | -          | -        | -    |        |      |
| EXTRA LOW TEMP Total capacity(kW) / Input power(W) / COP |  | -  |                                  |          |                                     |                |            |          |      |        |      |
| Max Current(A) / Max Input power(W)                      |  | 1.28/160                                       | 1.24/160                         | 1.20/160 | 7.0/4.150k                          | 7.0/4.360k     | 7.0/4.530k | -        |      |        |      |
| Starting current(A) / Comp output(W)                     |  | -  | -                                | -        | 3.35/2.0k                           | 3.20/2.0k      | 3.10/2.0k  | -        |      |        |      |
| Network Impedance(ΩMAX.)                                 |  | -  |                                  |          |                                     |                |            |          |      |        |      |
| Fan motor output (Indoor/Outdoor) W                      |  | 120  |                                  |          | 90                                  |                |            | -        |      |        |      |
| Moisture removal volume                                  |  | L/h(Pt/h)                                      | 4.2                              | (8.8)    |                                     | -              |            |          | -    |        |      |
| External static pressure                                 |  | Pa   | 50 (MIN10 - MAX80)               |          |                                     | -              |            |          | -    |        |      |
| Indoor Air flow  | Cooling                                  | m³/min (ft³/min)                               | 22/20/16 (777/706/565)           |          |                                     | -              |            |          | -    |        |      |
|  | Heating                                  | m³/min (ft³/min)                               | 22/20/16 (777/706/565)           |          |                                     | -              |            |          | -    |        |      |
| Outdoor Air flow   | Cooling                                  | m³/min (ft³/min)                               | -                                |          |                                     | 60             | (2119)     |          | -    |        |      |
|  | Heating                                  | m³/min (ft³/min)                               | -                                |          |                                     | 60             | (2119)     |          | -    |        |      |
| Refrigerant type / amount g(oz)                          |  | -  |                                  |          | R410A                               | 2.35k          | (82.9)     |          | -    |        |      |
| Product dimension  | Height                                   | mm(inch)                                       | 250 (9-27/32)                    |          |                                     | 996 (39-77/32) |            |          | -    |        |      |
|  | Width                                    | mm(inch)                                       | 1000 (+100) (39-5/16) (+3-15/16) |          |                                     | 940 (37-1/32)  |            |          | -    |        |      |
|  | Depth                                    | mm(inch)                                       | 650 (25-19/32)                   |          |                                     | 340 (13-13/32) |            |          | -    |        |      |
| Packing dimension  | Height                                   | mm(inch)                                       | 338                              |          |                                     | 1136           |            |          | -    |        |      |
|  | Width                                    | mm(inch)                                       | 1211                             |          |                                     | 1055           |            |          | -    |        |      |
|  | Depth                                    | mm(inch)                                       | 761                              |          |                                     | 485            |            |          | -    |        |      |
| Weight   | (NET)                                    | kg(lb)   | 32 (71)                          |          |                                     | 71 (157)       |            |          | -    |        |      |
|  | (GROSS)                                  | kg(lb)   | 38 (84)                          |          |                                     | 79 (174)       |            |          | -    |        |      |
| Layers limit (actually)                                  |  | 6 (7)  |                                  |          | 2 (3)                               |                |            | -        |      |        |      |
| Operation condition                                      | Cool (DBT)                               | 18°C ~ 32°C                                    |                                  |          | -15°C ~ 46°C                        |                |            | -        |      |        |      |
|  | Heat (DBT)                               | 16°C ~ 30°C                                    |                                  |          | -20°C ~ 24°C                        |                |            | -        |      |        |      |
| P<br>I<br>P<br>I<br>N<br>G                               | Pipe diameter mm (inch)                  | (Liquid)ø9.52(3/8) (Gas)ø15.88(5/8)            |                                  |          | (Liquid)ø9.52(3/8) (Gas)ø15.88(5/8) |                |            | -        |      |        |      |
|  | Connecting method, Standard length m(ft) | flared type, 5.0(16.4)                         |                                  |          | flared type, 5.0(16.4)              |                |            | -        |      |        |      |
| Pipe length range m (ft)                                 |  | 5 ~ 50 (16.4 ~ 164.0)                          |                                  |          | -                                   |                |            | -        |      |        |      |
| Indoor unit & Outdoor unit height difference m (ft)      |  | 15 (OD located lower) / 30 (OD located higher) |                                  |          | (49.2/98.4)                         |                |            | -        |      |        |      |
| Add gas amount g/m (oz/ft)                               |  | 50   |                                  |          | (0.538)                             |                |            | -        |      |        |      |
| Pipe length for additional gas m (ft)                    |  | 30   |                                  |          | (98.4)                              |                |            | -        |      |        |      |

\*1: In case it is necessary to indicate the air flow volume in (l/s), the value in (m³/min.) shall be multiplied by 16.7 and rounded down the decimal point.

\*2: If the EUROVENT Certified models can be operated under the "extra-low" temperature condition, -7°C dry bulb and -8°C wet-bulb temperatures with rated voltage 230 V shall be used.

\*3: Network Impedance shall be applicable for EUROPE and CHINA models.

\*4: The annual consumption is calculated by multiplying the input power at 230 V (400 V) by an average of 500 hours per year in cooling mode.

\*5: EER and COP classification is at 230 V (400 V) only in accordance with EU directive 2002/31/EC.

\*6: SEER and SCOP classification is at 230V(400V) only in accordance with EN-14825. For heating, SCOP indicates the value of only Average heating season, Other fiche data indicates in an attached sheet.

# Simultaneous (Twin) -Type

## 1-1. Unit Specifications

PE1

### 5. Ducted Type S-71PN1E5A×2 / U-140PE1E8A

|  |  |  |                                     |  |              |                                     |             |          |       |        |      |
|--|--|--|-------------------------------------|--|--------------|-------------------------------------|-------------|----------|-------|--------|------|
| INDOOR                                       |  | MODEL                                  | S-71PN1E5A×2                        |  |              | -                                   |             |          | -     |        |      |
| OUTDOOR                                      |  | MODEL                                  | -                                   |  |              | U-140PE1E8A                         |             |          | -     |        |      |
| Branch pipe                                  |  | MODEL                                  | CZ-P155BK1                          |  |              |                                     |             |          |       |        |      |
| Performance test condition                   |  | ISO13253 / EN14511 / EN12102 / EN14825 |                                     |  |              |                                     |             |          |       |        |      |
| Power supply                                 |  | Ø, Hz                                  | 1ø 50Hz                             |  |              | 3ø 50Hz                             |             |          |       |        |      |
|  |  | V                                      | 220                                 | 230  | 240          | 380                                 | 400         | 415      | Min   | Max    |      |
| C<br>O<br>O<br>L<br>I<br>N<br>G              | Capacity   | kW                                     | 14.0                                | 14.0   | 14.0         | -                                   | -           | -        | 3.3   | 15.5   |      |
|  |  | BTU/h                                  | 47800                               | 47800  | 47800        | -                                   | -           | -        | 11300 | 52900  |      |
|  | Current  | A                                      | 1.12×2                              | 1.08×2   | 1.04×2       | 6.95                                | 6.60        | 6.35     | -     | -      |      |
|  |  | W                                      | 140×2                               | 140×2  | 140×2        | 4.400k                              | 4.400k      | 4.400k   | -     | -      |      |
|  | Input power  | TOTAL W                                | -                                   |  |              | 4.680k                              | 4.680k      | 4.680k   | 1000  | 6.200k |      |
|  |  | Annual consumption                     | TOTAL kWh *4                        | -  |              |                                     | -           | 2340     | -     | -      | -    |
|  | EER/EER CLASS  |  | TOTAL (W/W) <sup>5</sup> / ("A"-°G) | -  | -            | -                                   | 2.99        | 2.99 / C | 2.99  | 3.30   | 2.50 |
|  | Erp <sup>*6</sup>  | Pdesign                                | kW                                  | -  | -            | -                                   | -           | 14.0     | -     | -      | -    |
|  |  | η <sub>s.c</sub>                       | %                                   | -  | -            | -                                   | -           | 219.8    | -     | -      | -    |
|  |  | Annual consumption                     | kWh                                 | -  | -            | -                                   | -           | -        | -     | -      | -    |
|  |  | Class                                  |                                     | -  | -            | -                                   | -           | -        | -     | -      | -    |
|  | Power factor   |  | %                                   | -  | -            | -                                   | 96          | 96       | 96    | -      | -    |
|  | Noise indoor   | dB-A (H/M/L)                           | 43/41/36                            |  |              | -                                   | -           | -        | -     | -      |      |
|  |  | Power Level dB                         | 60/58/53                            |  |              | -                                   | -           | -        | -     | -      |      |
|  | Noise outdoor  | dB-A (H/L)                             | -                                   |  |              | 54/-                                |             |          | -     | -      |      |
|  |  | Power Level dB                         | -                                   |  |              | 71/-                                |             |          | -     | -      |      |
| H<br>E<br>A<br>T<br>I<br>N<br>G              | Capacity   | kW                                     | 16.0                                | 16.0   | 16.0         | -                                   | -           | -        | 4.1   | 18.0   |      |
|  |  | BTU/h                                  | 54600                               | 54600  | 54600        | -                                   | -           | -        | 14000 | 61400  |      |
|  | Current  | A                                      | 1.12×2                              | 1.08×2   | 1.04×2       | 7.00                                | 6.65        | 6.45     | -     | -      |      |
|  |  | W                                      | 140×2                               | 140×2  | 140×2        | 4.440k                              | 4.440k      | 4.440k   | -     | -      |      |
|  | Input power  | TOTAL W                                | -                                   |  |              | 4.720k                              | 4.720k      | 4.720k   | 1050  | 6.100k |      |
|  |  | COP/COP CLASS                          | TOTAL (W/W) <sup>5</sup> / ("A"-°G) | -  | -            | -                                   | 3.39        | 3.39 / C | 3.39  | 3.90   | 2.95 |
|  | Erp <sup>*6</sup>  | Pdesign at -10°C                       | kW                                  | -  | -            | -                                   | -           | 14.0     | -     | -      | -    |
|  |  | Tbivalent                              | °C                                  | -  | -            | -                                   | -           | -7       | -     | -      | -    |
|  |  | η <sub>s.h</sub>                       | %                                   | -  | -            | -                                   | -           | 140.7    | -     | -      | -    |
|  |  | Annual consumption                     | kWh                                 | -  | -            | -                                   | -           | -        | -     | -      | -    |
|  | Power factor   |  | %                                   | -  | -            | -                                   | 96          | 96       | 96    | -      | -    |
|  | Noise indoor   | dB-A (H/M/L)                           | 43/41/36                            |  |              | -                                   |             |          | -     | -      |      |
|  |  | Power Level dB                         | 60/58/53                            |  |              | -                                   |             |          | -     | -      |      |
|  | Noise outdoor  | dB-A (H/L)                             | -                                   |  |              | 55/-                                |             |          | -     | -      |      |
|  |  | Power Level dB                         | -                                   |  |              | 71/-                                |             |          | -     | -      |      |
|  | EXTRA LOW TEMP Total capacity(kW) / Input power(W) / COP |  | -                                   |  |              |                                     |             |          |       |        |      |
| Max Current(A) / Max Input power(W)          |  | 1.28×2/160×2                           | 1.24×2/160×2                        | 1.20×2/160×2                                   | 11.0/6.800k  | 11.0/7.150k                         | 11.0/7.450k | -        |       |        |      |
| Starting current(A) / Comp output(W)         |  | -                                      | -                                   | -  | 7.00/3.0k    | 6.65/3.0k                           | 6.45/3.0k   | -        |       |        |      |
| Network Impedance(ΩMAX.)                     |  | -                                      |                                     |  |              |                                     |             |          |       |        |      |
| Fan motor output (Indoor/Outdoor) W          |  | 120×2                                  |                                     |  | 90×2         |                                     |             | -        |       |        |      |
| Moisture removal volume                      |  | L/h(Pt/h)                              | 9.0                                 | (4.5×2)  | (18.9)       | -                                   |             |          | -     |        |      |
| External static pressure                     |  | Pa                                     | 50 (MIN10 - MAX80)                  |  |              | -                                   |             |          | -     |        |      |
| Indoor Air flow                              | Cooling  | m³/min (ft³/min)                       | [22/20/16 (777/706/565)]×2          |  |              | -                                   |             |          | -     |        |      |
|  | Heating  | m³/min (ft³/min)                       | [22/20/16 (777/706/565)]×2          |  |              | -                                   |             |          | -     |        |      |
| Outdoor Air flow                             | Cooling  | m³/min (ft³/min)                       | -                                   |  |              | 135                                 | (4767)      | -        |       |        |      |
|  | Heating  | m³/min (ft³/min)                       | -                                   |  |              | 120                                 | (4238)      | -        |       |        |      |
| Refrigerant type / amount g(oz)              |  | -                                      |                                     |  | R410A        | 3.40k                               | (119.9)     | -        |       |        |      |
| Product dimension                            | Height   | mm(inch)                               | 250 (9-27/32)                       |  |              | 1416 (55-3/4)                       |             |          | -     |        |      |
|  | Width  | mm(inch)                               | 1000 (+100) (39-5/16) (+3-15/16)    |  |              | 940 (37-1/32)                       |             |          | -     |        |      |
|  | Depth  | mm(inch)                               | 650 (25-19/32)                      |  |              | 340 (13-13/32)                      |             |          | -     |        |      |
| Packing dimension                            | Height   | mm(inch)                               | 338                                 |  |              | 1556                                |             |          | -     |        |      |
|  | Width  | mm(inch)                               | 1211                                |  |              | 1055                                |             |          | -     |        |      |
|  | Depth  | mm(inch)                               | 761                                 |  |              | 485                                 |             |          | -     |        |      |
| Weight                                       | (NET)  | kg(lb)                                 | 32 (71)                             |  |              | 98 (216)                            |             |          | -     |        |      |
|  | (GROSS)  | kg(lb)                                 | 38 (84)                             |  |              | 108 (238)                           |             |          | -     |        |      |
| Layers limit (actually)                      |  | 6 (7)                                  |                                     |  | 1 (2)        |                                     |             | -        |       |        |      |
| Operation condition                          | Cool (DBT)   | 18°C ~ 32°C                            |                                     |  | -15°C ~ 46°C |                                     |             | -        |       |        |      |
|  | Heat (DBT)   | 16°C ~ 30°C                            |                                     |  | -20°C ~ 24°C |                                     |             | -        |       |        |      |
| P<br>I<br>P<br>I<br>N<br>G                   | Pipe diameter mm (inch)                                  |  | (Liquid)ø9.52(3/8) (Gas)ø15.88(5/8) |  |              | (Liquid)ø9.52(3/8) (Gas)ø15.88(5/8) |             |          | -     |        |      |
|  | Connecting method, Standard length m(ft)                 |  | flared type, 5.0(16.4)              |  |              | flared type, 5.0(16.4)              |             |          | -     |        |      |
| Pipe length range                            |  | m (ft)                                 |                                     | 5 ~ 75 (16.4 ~ 246.1)                          |              | -                                   |             |          |       |        |      |
| Indoor unit & Outdoor unit height difference |  | m (ft)                                 |                                     | 15 (OD located lower) / 30 (OD located higher) |              | (49.2/98.4)                         |             | -        |       |        |      |
| Add gas amount                               |  | g/m (oz/ft)                            |                                     | 50 (0.538)                                     |              | -                                   |             |          |       |        |      |
| Pipe length for additional gas               |  | m (ft)                                 |                                     | 30 (98.4)                                      |              | -                                   |             |          |       |        |      |

\*1: In case it is necessary to indicate the air flow volume in (l/s), the value in (m³/min.) shall be multiplied by 16.7 and rounded down the decimal point.  
 \*2: If the EUROVENT Certified models can be operated under the "extra-low" temperature condition, -7°C dry bulb and -8°C wet-bulb temperatures with rated voltage 230 V shall be used.  
 \*3: Network Impedance shall be applicable for EUROPE and CHINA models.  
 \*4: The annual consumption is calculated by multiplying the input power at 230 V (400 V) by an average of 500 hours per year in cooling mode.  
 \*5: EER and COP classification is at 230 V (400 V) only in accordance with EU directive 2002/31/EC.  
 \*6: SEER and SCOP classification is at 230V(400V) only in accordance with EN-14825. For heating, SCOP indicates the value of only Average heating season.

# Single -Type

## 1-1. Unit Specifications

**PE1**

### 5. Ducted Type S-100PN1E5A / U-100PE1E8A

| INDOOR   |  | MODEL  | S-100PN1E5A                     |          |                                     | -              |            |          | -     |        |      |
|--|--|--|---------------------------------|----------|-------------------------------------|----------------|------------|----------|-------|--------|------|
| OUTDOOR  |  | MODEL  | -                               |          |                                     | U-100PE1E8A    |            |          | -     |        |      |
| Branch pipe  |  | MODEL  | -                               |          |                                     | -              |            |          | -     |        |      |
| Performance test condition                               |  | ISO13253 / EN14511 / EN14825 / EN12102         |                                 |          |                                     |                |            |          |       |        |      |
| Power supply   |  | Ø, Hz  | 1ø 50Hz                         |          |                                     | 3ø 50Hz        |            |          | Min   | Max    |      |
|  |  | V  | 220                             | 230      | 240                                 | 380            | 400        | 415      |       |        |      |
| C<br>O<br>O<br>L<br>I<br>N<br>G                          | Capacity                                 | kW   | 10.0                            | 10.0     | 10.0                                | -              | -          | -        | 3.3   | 12.5   |      |
|  |  | BTU/h  | 34100                           | 34100    | 34100                               | -              | -          | -        | 11300 | 42700  |      |
|  | Current                                  | A  | 1.54                            | 1.48     | 1.42                                | 3.95           | 3.75       | 3.60     | -     | -      |      |
|  |  | W  | 205                             | 205      | 205                                 | 2.465k         | 2.465k     | 2.465k   | -     | -      |      |
|  | Input power                              | TOTAL W  | -                               |          |                                     | 2.670k         | 2.670k     | 2.670k   | 870   | 3.800k |      |
|  |  | Annual consumption                             | TOTAL kWh *4                    | -        |                                     |                | -          | 1335     | -     | -      | -    |
|  | EER/EER CLASS                            | TOTAL (W/W) *5 / ("A"-*G)                      | -                               | -        | -                                   | 3.75           | 3.75 / A   | 3.75     | 3.79  | 3.29   |      |
|  | Erp *6                                   | Pdesign  | kW                              | -        | -                                   | -              | -          | 10.0     | -     | -      | -    |
|  |  | SEER   | (W/W)                           | -        | -                                   | -              | -          | 5.6      | -     | -      | -    |
|  |  | Annual consumption                             | kWh                             | -        | -                                   | -              | -          | 621      | -     | -      | -    |
| Class  |  |  | -                               | -        | -                                   | -              | A+         | -        | -     | -      |      |
| Power factor   | %  | -  | -                               | -        | 95                                  | 95             | 95         | -        | -     |        |      |
| Noise indoor   | dB-A (H/M/L)                             | 44/42/37                                       |                                 |          | -                                   |                |            | -        | -     |        |      |
|  | Power Level dB                           | 65/63/58                                       |                                 |          | -                                   |                |            | -        | -     |        |      |
| Noise outdoor  | dB-A (H/L)                               | -  |                                 |          | 52/-                                |                |            | -        | -     |        |      |
|  | Power Level dB                           | -  |                                 |          | 69/-                                |                |            | -        | -     |        |      |
| H<br>E<br>A<br>T<br>I<br>N<br>G                          | Capacity                                 | kW   | 11.2                            | 11.2     | 11.2                                | -              | -          | -        | 4.1   | 14.0   |      |
|  |  | BTU/h  | 38200                           | 38200    | 38200                               | -              | -          | -        | 14000 | 47800  |      |
|  | Current                                  | A  | 1.54                            | 1.48     | 1.42                                | 4.35           | 4.15       | 4.00     | -     | -      |      |
|  |  | W  | 205                             | 205      | 205                                 | 2.745k         | 2.745k     | 2.745k   | -     | -      |      |
|  | Input power                              | TOTAL W  | -                               |          |                                     | 2.950k         | 2.950k     | 2.950k   | 980   | 4.500k |      |
|  |  | COP/COP CLASS                                  | TOTAL (W/W) *5 / ("A"-*G)       | -        | -                                   | -              | 3.80       | 3.80 / A | 3.80  | 4.18   | 3.11 |
|  | Erp *6                                   | Pdesign at -10°C                               | kW                              | -        | -                                   | -              | -          | 10.0     | -     | -      | -    |
|  |  | Tbivalent                                      | °C                              | -        | -                                   | -              | -          | -10      | -     | -      | -    |
|  |  | SCOP   | (W/W)                           | -        | -                                   | -              | -          | 3.8      | -     | -      | -    |
|  |  | Annual consumption                             | kWh                             | -        | -                                   | -              | -          | 3684     | -     | -      | -    |
| Class  |  | -  | -                               | -        | -                                   | A              | -          | -        | -     |        |      |
| Power factor   | %  | -  | -                               | -        | 96                                  | 95             | 95         | -        | -     |        |      |
| Noise indoor   | dB-A (H/M/L)                             | 44/42/37                                       |                                 |          | -                                   |                |            | -        | -     |        |      |
|  | Power Level dB                           | 65/63/58                                       |                                 |          | -                                   |                |            | -        | -     |        |      |
| Noise outdoor  | dB-A (H/L)                               | -  |                                 |          | 52/-                                |                |            | -        | -     |        |      |
|  | Power Level dB                           | -  |                                 |          | 69/-                                |                |            | -        | -     |        |      |
| EXTRA LOW TEMP Total capacity(kW) / Input power(W) / COP |  | -  |                                 |          |                                     |                |            |          |       |        |      |
| Max Current(A) / Max Input power(W)                      |  | 2.13/275                                       | 2.07/275                        | 2.01/275 | 9.0/5.550k                          | 9.0/5.850k     | 9.0/6.100k | -        |       |        |      |
| Starting current(A) / Comp output(W)                     |  | -  | -                               | -        | 4.35/3.0k                           | 4.15/3.0k      | 4.00/3.00k | -        |       |        |      |
| Network Impedance(ΩMAX.)                                 |  | -  |                                 |          |                                     |                |            |          |       |        |      |
| Fan motor output (Indoor/Outdoor) W                      |  | 200  |                                 |          | 90×2                                |                |            | -        |       |        |      |
| Moisture removal volume                                  |  | L/h(Pt/h)                                      | 6.0 (12.6)                      |          |                                     | -              |            |          | -     |        |      |
| External static pressure                                 |  | Pa   | 50 (MIN10 - MAX80)              |          |                                     | -              |            |          | -     |        |      |
| Indoor Air flow  | Cooling                                  | m³/min (ft³/min)                               | 36/33/26 (1271/1165/918)        |          |                                     | -              |            |          | -     | -      |      |
|  | Heating                                  | m³/min (ft³/min)                               | 36/33/26 (1271/1165/918)        |          |                                     | -              |            |          | -     | -      |      |
| Outdoor Air flow   | Cooling                                  | m³/min (ft³/min)                               | -                               |          |                                     | 110            | (3885)     | -        | -     |        |      |
|  | Heating                                  | m³/min (ft³/min)                               | -                               |          |                                     | 95             | (3355)     | -        | -     |        |      |
| Refrigerant type / amount g(oz)                          |  | -  |                                 |          | R410A                               | 3.40k          | (119.9)    | -        |       |        |      |
| Product dimension  | Height                                   | mm(inch)                                       | 250 (9-27/32)                   |          |                                     | 1416 (55-3/4)  |            |          | -     |        |      |
|  | Width                                    | mm(inch)                                       | 1200 (+100) (47-1/4) (+3-15/16) |          |                                     | 940 (37-1/32)  |            |          | -     |        |      |
|  | Depth                                    | mm(inch)                                       | 650 (25-19/32)                  |          |                                     | 340 (13-13/32) |            |          | -     |        |      |
| Packing dimension  | Height                                   | mm(inch)                                       | 338                             |          |                                     | 1556           |            |          | -     |        |      |
|  | Width                                    | mm(inch)                                       | 1402                            |          |                                     | 1055           |            |          | -     |        |      |
|  | Depth                                    | mm(inch)                                       | 761                             |          |                                     | 485            |            |          | -     |        |      |
| Weight   | (NET)                                    | kg(lb)   | 41 (91)                         |          |                                     | 98 (216)       |            |          | -     |        |      |
|  | (GROSS)                                  | kg(lb)   | 48 (106)                        |          |                                     | 108 (238)      |            |          | -     |        |      |
| Layers limit (actually)                                  |  | 6 (7)  |                                 |          | 1 (2)                               |                |            | -        |       |        |      |
| Operation condition                                      | Cool (DBT)                               | 18°C ~ 32°C                                    |                                 |          | -15°C ~ 46°C                        |                |            | -        |       |        |      |
|  | Heat (DBT)                               | 16°C ~ 30°C                                    |                                 |          | -20°C ~ 24°C                        |                |            | -        |       |        |      |
| P<br>I<br>P<br>E<br>I<br>N<br>G                          | Pipe diameter mm (inch)                  | (Liquid)ø9.52(3/8) (Gas)ø15.88(5/8)            |                                 |          | (Liquid)ø9.52(3/8) (Gas)ø15.88(5/8) |                |            | -        |       |        |      |
|  | Connecting method, Standard length m(ft) | flared type, 5.0(16.4)                         |                                 |          | flared type, 5.0(16.4)              |                |            | -        |       |        |      |
| Pipe length range m (ft)                                 |  | 5 ~ 75 (16.4 ~ 246.1)                          |                                 |          | -                                   |                |            | -        |       |        |      |
| Indoor unit & Outdoor unit height difference m (ft)      |  | 15 (OD located lower) / 30 (OD located higher) |                                 |          | (49.2/98.4)                         |                |            | -        |       |        |      |
| Add gas amount g/m (oz/ft)                               |  | 50   |                                 |          | (0.538)                             |                |            | -        |       |        |      |
| Pipe length for additional gas m (ft)                    |  | 30   |                                 |          | (98.4)                              |                |            | -        |       |        |      |

\*1: In case it is necessary to indicate the air flow volume in (l/s), the value in (m³/min.) shall be multiplied by 16.7 and rounded down the decimal point.

\*2: If the EUROVENT Certified models can be operated under the "extra-low" temperature condition, -7°C dry bulb and -8°C wet-bulb temperatures with rated voltage 230 V shall be used.

\*3: Network Impedance shall be applicable for EUROPE and CHINA models.

\*4: The annual consumption is calculated by multiplying the input power at 230 V (400 V) by an average of 500 hours per year in cooling mode.

\*5: EER and COP classification is at 230 V (400 V) only in accordance with EU directive 2002/31/EC.

\*6: SEER and SCOP classification is at 230V(400V) only in accordance with EN-14825. For heating, SCOP indicates the value of only Average heating season, Other fiche data indicates in an attached sheet.

# Single -Type

## 1-1. Unit Specifications

**PE1**

### 5. Ducted Type S-125PN1E5A / U-125PE1E8A

| INDOOR   |   | MODEL                                  | S-125PN1E5A                                    |          |             | -                                   |             |          | -     |        |      |
|--|---|--|--|----------|-------------|-------------------------------------|-------------|----------|-------|--------|------|
| OUTDOOR  |   | MODEL                                  | -  |          |             | U-125PE1E8A                         |             |          | -     |        |      |
| Branch pipe  |   | MODEL                                  | -  |          |             | -                                   |             |          | -     |        |      |
| Performance test condition                               |   | ISO13253 / EN14511 / EN12102 / EN14825 |  |          |             |                                     |             |          |       |        |      |
| Power supply   |   | Ø, Hz                                  | 1ø 50Hz  |          |             | 3ø 50Hz                             |             |          | Min   | Max    |      |
|  |   | V                                      | 220  | 230      | 240         | 380                                 | 400         | 415      |       |        |      |
| C<br>O<br>O<br>L<br>I<br>N<br>G                          | Capacity  | kW                                     | 12.5   | 12.5     | 12.5        | -                                   | -           | -        | 3.3   | 14.0   |      |
|  |   | BTU/h                                  | 42700  | 42700    | 42700       | -                                   | -           | -        | 11300 | 47800  |      |
|  | Current   | A                                      | 1.74   | 1.67     | 1.61        | 5.80                                | 5.50        | 5.30     | -     | -      |      |
|  |   | W                                      | 225  | 225      | 225         | 3.665k                              | 3.665k      | 3.665k   | -     | -      |      |
|  | Input power   | TOTAL W                                | -  |          |             | 3.890k                              | 3.890k      | 3.890k   | 1000  | 4.800k |      |
|  |   | Annual consumption                     | TOTAL kWh *4                                   | -        |             |                                     | -           | 1945     | -     | -      | -    |
|  | EER/EER CLASS                                       | TOTAL (W/W) *5 / ("A"-°G)              | -  | -        | -           | 3.21                                | 3.21 / A    | 3.21     | 3.30  | 2.92   |      |
|  | Erp *6  | Pdesign                                | kW   | -        | -           | -                                   | -           | 12.5     | -     | -      | -    |
|  |   | η <sub>s.c</sub>                       | %  | -        | -           | -                                   | -           | 214.6    | -     | -      | -    |
|  |   | Annual consumption                     | kWh  | -        | -           | -                                   | -           | -        | -     | -      | -    |
|  |   | Class                                  |  | -        | -           | -                                   | -           | -        | -     | -      | -    |
|  | Power factor  | %                                      | -  | -        | -           | 96                                  | 96          | 96       | -     | -      |      |
|  | Noise indoor  | dB-A (H/M/L)                           | 45/43/38                                       |          |             | -                                   |             |          | -     | -      |      |
|  |   | Power Level dB                         | 66/64/59                                       |          |             | -                                   |             |          | -     | -      |      |
| Noise outdoor  | dB-A (H/L)  | -                                      |  |          | 53/-        |                                     |             | -        | -     |        |      |
|  | Power Level dB                                      | -                                      |  |          | 70/-        |                                     |             | -        | -     |        |      |
| H<br>E<br>A<br>T<br>I<br>N<br>G                          | Capacity  | kW                                     | 14.0   | 14.0     | 14.0        | -                                   | -           | -        | 4.1   | 16.0   |      |
|  |   | BTU/h                                  | 47800  | 47800    | 47800       | -                                   | -           | -        | 14000 | 54600  |      |
|  | Current   | A                                      | 1.74   | 1.67     | 1.61        | 5.80                                | 5.50        | 5.30     | -     | -      |      |
|  |   | W                                      | 225  | 225      | 225         | 3.655k                              | 3.655k      | 3.655k   | -     | -      |      |
|  | Input power   | TOTAL W                                | -  |          |             | 3.880k                              | 3.880k      | 3.880k   | 1050  | 5.400k |      |
|  |   | COP/COP CLASS                          | TOTAL (W/W) *5 / ("A"-°G)                      | -        | -           | -                                   | 3.61        | 3.61 / A | 3.61  | 3.90   | 2.96 |
|  | Erp *6  | Pdesign at -10°C                       | kW   | -        | -           | -                                   | -           | 12.5     | -     | -      | -    |
|  |   | Tbivalent                              | °C   | -        | -           | -                                   | -           | -7       | -     | -      | -    |
|  |   | η <sub>s.h</sub>                       | %  | -        | -           | -                                   | -           | 143.4    | -     | -      | -    |
|  |   | Annual consumption                     | kWh  | -        | -           | -                                   | -           | -        | -     | -      | -    |
|  | Class   |  | -  | -        | -           | -                                   | -           | -        | -     | -      |      |
|  | Power factor  | %                                      | -  | -        | -           | 96                                  | 96          | 96       | -     | -      |      |
|  | Noise indoor  | dB-A (H/M/L)                           | 45/43/38                                       |          |             | -                                   |             |          | -     | -      |      |
|  |   | Power Level dB                         | 66/64/59                                       |          |             | -                                   |             |          | -     | -      |      |
| Noise outdoor  | dB-A (H/L)  | -                                      |  |          | 53/-        |                                     |             | -        | -     |        |      |
|  | Power Level dB                                      | -                                      |  |          | 70/-        |                                     |             | -        | -     |        |      |
| EXTRA LOW TEMP Total capacity(kW) / Input power(W) / COP |   | -                                      |  |          |             |                                     |             |          |       |        |      |
| Max Current(A) / Max Input power(W)                      |   | 2.36/300                               | 2.30/300                                       | 2.24/300 | 10.0/6.200k | 10.0/6.500k                         | 10.0/6.750k | -        |       |        |      |
| Starting current(A) / Comp output(W)                     |   | -                                      | -  | -        | 5.80/3.0k   | 5.50/3.0k                           | 5.30/3.0k   | -        |       |        |      |
| Network Impedance(ΩMAX.)                                 |   | -                                      |  |          |             |                                     |             |          |       |        |      |
| Fan motor output (Indoor/Outdoor) W                      |   | 200                                    |  |          | 90×2        |                                     |             | -        |       |        |      |
| Moisture removal volume                                  |   | L/h(Pt/h)                              | 7.9  | (16.6)   |             | -                                   |             |          | -     |        |      |
| External static pressure                                 |   | Pa                                     | 50 (MIN10 - MAX80)                             |          |             | -                                   |             |          | -     |        |      |
| Indoor Air flow  | Cooling   | m³/min (ft³/min)                       | 38/35/28 (1342/1236/989)                       |          |             | -                                   |             |          | -     |        |      |
|  | Heating   | m³/min (ft³/min)                       | 38/35/28 (1342/1236/989)                       |          |             | -                                   |             |          | -     |        |      |
| Outdoor Air flow   | Cooling   | m³/min (ft³/min)                       | -  |          |             | 130                                 | (4591)      | -        |       |        |      |
|  | Heating   | m³/min (ft³/min)                       | -  |          |             | 110                                 | (3885)      | -        |       |        |      |
| Refrigerant type / amount g(oz)                          |   |  | -  |          |             | R410A                               | 3.40k       | (119.9)  | -     |        |      |
| Product dimension  | Height  | mm(inch)                               | 250 (9-27/32)                                  |          |             | 1416 (55-3/4)                       |             |          | -     |        |      |
|  | Width   | mm(inch)                               | 1200 (+100) (47-1/4) (+3-15/16)                |          |             | 940 (37-1/32)                       |             |          | -     |        |      |
|  | Depth   | mm(inch)                               | 650 (25-19/32)                                 |          |             | 340 (13-13/32)                      |             |          | -     |        |      |
| Packing dimension  | Height  | mm(inch)                               | 338  |          |             | 1556                                |             |          | -     |        |      |
|  | Width   | mm(inch)                               | 1402   |          |             | 1055                                |             |          | -     |        |      |
|  | Depth   | mm(inch)                               | 761  |          |             | 485                                 |             |          | -     |        |      |
| Weight   | (NET)   | kg(lb)                                 | 41 (91)  |          |             | 98 (216)                            |             |          | -     |        |      |
|  | (GROSS)   | kg(lb)                                 | 48 (106)                                       |          |             | 108 (238)                           |             |          | -     |        |      |
| Layers limit (actually)                                  |   |  | 6 (7)  |          |             | 1 (2)                               |             |          | -     |        |      |
| Operation condition                                      | Cool (DBT)  |  | 18°C ~ 32°C                                    |          |             | -15°C ~ 46°C                        |             |          | -     |        |      |
|  | Heat (DBT)  |  | 16°C ~ 30°C                                    |          |             | -20°C ~ 24°C                        |             |          | -     |        |      |
| P<br>I<br>P<br>E<br>I<br>N<br>G                          | Pipe diameter mm (inch)                             |  | (Liquid)ø9.52(3/8) (Gas)ø15.88(5/8)            |          |             | (Liquid)ø9.52(3/8) (Gas)ø15.88(5/8) |             |          | -     |        |      |
|  | Connecting method, Standard length m(ft)            |  | flared type, 5.0(16.4)                         |          |             | flared type, 5.0(16.4)              |             |          | -     |        |      |
|  | Pipe length range m (ft)                            |  | 5 ~ 75 (16.4 ~ 246.1)                          |          |             | -                                   |             |          | -     |        |      |
|  | Indoor unit & Outdoor unit height difference m (ft) |  | 15 (OD located lower) / 30 (OD located higher) |          |             | (49.2/98.4)                         |             |          | -     |        |      |
|  | Add gas amount g/m (oz/ft)                          |  | 50   |          |             | (0.538)                             |             |          | -     |        |      |
|  | Pipe length for additional gas m (ft)               |  | 30   |          |             | (98.4)                              |             |          | -     |        |      |

\*1: In case it is necessary to indicate the air flow volume in (l/s), the value in (m³/min.) shall be multiplied by 16.7 and rounded down the decimal point.

\*2: If the EUROVENT Certified models can be operated under the "extra-low" temperature condition, -7°C dry bulb and -8°C wet-bulb temperatures with rated voltage 230 V shall be used.

\*3: Network Impedance shall be applicable for EUROPE and CHINA models.

\*4: The annual consumption is calculated by multiplying the input power at 230 V (400 V) by an average of 500 hours per year in cooling mode.

\*5: EER and COP classification is at 230 V (400 V) only in accordance with EU directive 2002/31/EC.

\*6: SEER and SCOP classification is at 230V(400V) only in accordance with EN-14825. For heating, SCOP indicates the value of only Average heating season.

# Single -Type

## 1-1. Unit Specifications

**PE1**

### 5. Ducted Type S-140PN1E5A / U-140PE1E8A

| INDOOR   |  | MODEL  | S-140PN1E5A                     |          |                                     | -              |             |          | -     |        |      |
|--|--|--|---------------------------------|----------|-------------------------------------|----------------|-------------|----------|-------|--------|------|
| OUTDOOR  |  | MODEL  | -                               |          |                                     | U-140PE1E8A    |             |          | -     |        |      |
| Branch pipe  |  | MODEL  | -                               |          |                                     | -              |             |          | -     |        |      |
| Performance test condition                               |  | ISO13253 / EN14511 / EN12102 / EN14825         |                                 |          |                                     |                |             |          |       |        |      |
| Power supply   |  | Ø, Hz  | 1ø 50Hz                         |          |                                     | 3ø 50Hz        |             |          | Min   | Max    |      |
|  |  | V  | 220                             | 230      | 240                                 | 380            | 400         | 415      | -     | -      |      |
| C<br>O<br>O<br>L<br>I<br>N<br>G                          | Capacity                                 | kW   | 14.0                            | 14.0     | 14.0                                | -              | -           | -        | 3.3   | 15.5   |      |
|  |  | BTU/h  | 47800                           | 47800    | 47800                               | -              | -           | -        | 11300 | 52900  |      |
|  | Current                                  | A  | 1.89                            | 1.82     | 1.74                                | 6.95           | 6.60        | 6.35     | -     | -      |      |
|  |  | W  | 250                             | 250      | 250                                 | 4.400k         | 4.400k      | 4.400k   | -     | -      |      |
|  | Input power                              | TOTAL W  | -                               |          |                                     | 4.650k         | 4.650k      | 4.650k   | 1000  | 6.200k |      |
|  |  | Annual consumption                             | TOTAL kWh **4                   | -        |                                     |                | -           | 2325     | -     | -      | -    |
|  | EER/EER CLASS                            | TOTAL (W/W) **5 / ("A"-*G)                     | -                               | -        | -                                   | 3.01           | 3.01 / B    | 3.01     | 3.30  | 2.50   |      |
|  | Erp<br>*6                                | Pdesign  | kW                              | -        | -                                   | -              | -           | 14.0     | -     | -      | -    |
|  |  | η <sub>s.c</sub>                               | %                               | -        | -                                   | -              | -           | 207.8    | -     | -      | -    |
|  |  | Annual consumption                             | kWh                             | -        | -                                   | -              | -           | -        | -     | -      | -    |
|  |  | Class  |                                 | -        | -                                   | -              | -           | -        | -     | -      | -    |
|  | Power factor                             | %  | -                               | -        | -                                   | 96             | 96          | 96       | -     | -      |      |
|  | Noise indoor                             | dB-A (H/M/L)                                   | 46/44/39                        |          |                                     | -              |             |          | -     | -      |      |
|  |  | Power Level dB                                 | 67/65/60                        |          |                                     | -              |             |          | -     | -      |      |
| Noise outdoor  | dB-A (H/L)                               | -  |                                 |          | 54/-                                |                |             | -        | -     |        |      |
|  | Power Level dB                           | -  |                                 |          | 71/-                                |                |             | -        | -     |        |      |
| H<br>E<br>A<br>T<br>I<br>N<br>G                          | Capacity                                 | kW   | 16.0                            | 16.0     | 16.0                                | -              | -           | -        | 4.1   | 18.0   |      |
|  |  | BTU/h  | 54600                           | 54600    | 54600                               | -              | -           | -        | 14000 | 61400  |      |
|  | Current                                  | A  | 1.89                            | 1.82     | 1.74                                | 7.00           | 6.65        | 6.45     | -     | -      |      |
|  |  | W  | 250                             | 250      | 250                                 | 4.440k         | 4.440k      | 4.440k   | -     | -      |      |
|  | Input power                              | TOTAL W  | -                               |          |                                     | 4.690k         | 4.690k      | 4.690k   | 1050  | 6.100k |      |
|  |  | COP/COP CLASS                                  | TOTAL (W/W) **5 / ("A"-*G)      | -        | -                                   | -              | 3.41        | 3.41 / B | 3.41  | 3.90   | 2.95 |
|  | Erp<br>*6                                | Pdesign at -10°C                               | kW                              | -        | -                                   | -              | -           | 14.0     | -     | -      | -    |
|  |  | Tbivalent                                      | °C                              | -        | -                                   | -              | -           | -7       | -     | -      | -    |
|  |  | η <sub>s.h</sub>                               | %                               | -        | -                                   | -              | -           | 140.1    | -     | -      | -    |
|  |  | Annual consumption                             | kWh                             | -        | -                                   | -              | -           | -        | -     | -      | -    |
|  | Class                                    |  | -                               | -        | -                                   | -              | -           | -        | -     | -      |      |
|  | Power factor                             | %  | -                               | -        | -                                   | 96             | 96          | 96       | -     | -      |      |
|  | Noise indoor                             | dB-A (H/M/L)                                   | 46/44/39                        |          |                                     | -              |             |          | -     | -      |      |
|  |  | Power Level dB                                 | 67/65/60                        |          |                                     | -              |             |          | -     | -      |      |
| Noise outdoor  | dB-A (H/L)                               | -  |                                 |          | 55/-                                |                |             | -        | -     |        |      |
|  | Power Level dB                           | -  |                                 |          | 71/-                                |                |             | -        | -     |        |      |
| EXTRA LOW TEMP Total capacity(kW) / Input power(W) / COP |  | -  |                                 |          |                                     |                |             |          |       |        |      |
| Max Current(A) / Max Input power(W)                      |  | 2.59/345                                       | 2.53/345                        | 2.47/345 | 11.0/6.800k                         | 11.0/7.150k    | 11.0/7.450k | -        |       |        |      |
| Starting current(A) / Comp output(W)                     |  | -  | -                               | -        | 7.00/3.0k                           | 6.65/3.0k      | 6.45/3.0k   | -        |       |        |      |
| Network Impedance(ΩMAX.)                                 |  | -  |                                 |          |                                     |                |             |          |       |        |      |
| Fan motor output (Indoor/Outdoor) W                      |  | 200  |                                 |          | 90×2                                |                |             | -        |       |        |      |
| Moisture removal volume                                  |  | L/h(Pt/h)                                      | 9.0 (18.9)                      |          |                                     | -              |             |          | -     |        |      |
| External static pressure                                 |  | Pa   | 50 (MIN10 - MAX80)              |          |                                     | -              |             |          | -     |        |      |
| Indoor Air flow  | Cooling                                  | m³/min (ft³/min)                               | 40/37/30 (1413/1307/1059)       |          |                                     | -              |             |          | -     | -      |      |
|  | Heating                                  | m³/min (ft³/min)                               | 40/37/30 (1413/1307/1059)       |          |                                     | -              |             |          | -     | -      |      |
| Outdoor Air flow   | Cooling                                  | m³/min (ft³/min)                               | -                               |          |                                     | 135            | (4767)      | -        | -     |        |      |
|  | Heating                                  | m³/min (ft³/min)                               | -                               |          |                                     | 120            | (4238)      | -        | -     |        |      |
| Refrigerant type / amount g(oz)                          |  | -  |                                 |          | R410A                               | 3.40k          | (119.9)     | -        |       |        |      |
| Product dimension  | Height                                   | mm(inch)                                       | 250 (9-27/32)                   |          |                                     | 1416 (55-3/4)  |             |          | -     |        |      |
|  | Width                                    | mm(inch)                                       | 1200 (+100) (47-1/4) (+3-15/16) |          |                                     | 940 (37-1/32)  |             |          | -     |        |      |
|  | Depth                                    | mm(inch)                                       | 650 (25-19/32)                  |          |                                     | 340 (13-13/32) |             |          | -     |        |      |
| Packing dimension  | Height                                   | mm(inch)                                       | 338                             |          |                                     | 1556           |             |          | -     |        |      |
|  | Width                                    | mm(inch)                                       | 1402                            |          |                                     | 1055           |             |          | -     |        |      |
|  | Depth                                    | mm(inch)                                       | 761                             |          |                                     | 485            |             |          | -     |        |      |
| Weight   | (NET)                                    | kg(lb)   | 41 (91)                         |          |                                     | 98 (216)       |             |          | -     |        |      |
|  | (GROSS)                                  | kg(lb)   | 48 (106)                        |          |                                     | 108 (238)      |             |          | -     |        |      |
| Layers limit (actually)                                  |  | 6 (7)  |                                 |          | 1 (2)                               |                |             | -        |       |        |      |
| Operation condition                                      | Cool (DBT)                               | 18°C ~ 32°C                                    |                                 |          | -15°C ~ 46°C                        |                |             | -        |       |        |      |
|  | Heat (DBT)                               | 16°C ~ 30°C                                    |                                 |          | -20°C ~ 24°C                        |                |             | -        |       |        |      |
| P<br>I<br>P<br>E<br>L<br>I<br>N<br>G                     | Pipe diameter mm (inch)                  | (Liquid)ø9.52(3/8) (Gas)ø15.88(5/8)            |                                 |          | (Liquid)ø9.52(3/8) (Gas)ø15.88(5/8) |                |             | -        |       |        |      |
|  | Connecting method, Standard length m(ft) | flared type, 5.0(16.4)                         |                                 |          | flared type, 5.0(16.4)              |                |             | -        |       |        |      |
| Pipe length range m (ft)                                 |  | 5 ~ 75 (16.4 ~ 246.1)                          |                                 |          | -                                   |                |             | -        |       |        |      |
| Indoor unit & Outdoor unit height difference m (ft)      |  | 15 (OD located lower) / 30 (OD located higher) |                                 |          | (49.2/98.4)                         |                |             | -        |       |        |      |
| Add gas amount g/m (oz/ft)                               |  | 50   |                                 |          | (0.538)                             |                |             | -        |       |        |      |
| Pipe length for additional gas m (ft)                    |  | 30   |                                 |          | (98.4)                              |                |             | -        |       |        |      |

\*1: In case it is necessary to indicate the air flow volume in (l/s), the value in (m³/min.) shall be multiplied by 16.7 and rounded down the decimal point.

\*2: If the EUROVENT Certified models can be operated under the "extra-low" temperature condition, -7°C dry bulb and -8°C wet-bulb temperatures with rated voltage 230 V shall be used.

\*3: Network Impedance shall be applicable for EUROPE and CHINA models.

\*4: The annual consumption is calculated by multiplying the input power at 230 V (400 V) by an average of 500 hours per year in cooling mode.

\*5: EER and COP classification is at 230 V (400 V) only in accordance with EU directive 2002/31/EC.

\*6: SEER and SCOP classification is at 230V(400V) only in accordance with EN-14825. For heating, SCOP indicates the value of only Average heating season.



# Single -Type

## 1-1. Unit Specifications

PE2

### 6. 4-Way Cassette 60x60 Type S-36PY2E5A / U-36PE2E5A

|  |   |                                   |  |         |              |                                    |            |        |             |             |      |
|--|---|-----------------------------------|--|---------|--------------|------------------------------------|------------|--------|-------------|-------------|------|
| INDOOR   |   | MODEL                             | S-36PY2E5A                                     |         |              |                                    |            |        | -           | -           |      |
| PANEL  |   | MODEL                             | CZ-KPY3AW / CZ-KPY3BW                          |         |              |                                    |            |        | -           | -           |      |
| OUTDOOR  |   | MODEL                             |  |         |              | U-36PE2E5A                         |            |        | -           | -           |      |
| Branch pipe  |   | MODEL                             |  |         |              |                                    |            |        | -           | -           |      |
| Performance test condition                                 |   |                                   | ISO5151 / EN14511 / EN12102 / EN14825          |         |              |                                    |            |        |             |             |      |
| Power supply   |   | Ø, Hz                             | 1ø 50Hz  |         |              | 1ø 50Hz                            |            |        |             |             |      |
|  |   | V                                 | 220V   | 230V    | 240V         | 220V                               | 230V       | 240V   | Min         | Max         |      |
| C<br>O<br>O<br>L<br>I<br>N<br>G                            | Capacity  | kW                                | 3.6  | 3.6     | 3.6          | -                                  | -          | -      | 1.5         | 4.0         |      |
|  |   | BTU/h                             | 12300  | 12300   | 12300        | -                                  | -          | -      | 5100        | 13600       |      |
|  | Current   | A                                 | 0.30   | 0.30    | 0.30         | 3.80                               | 3.60       | 3.50   | -           | -           |      |
|  |   | W                                 | 40   | 40      | 40           | 0.760k                             | 0.760k     | 0.760k | -           | -           |      |
|  | Input power   | TOTAL W                           | -  | -       | -            | 0.800k                             | 0.800k     | 0.800k | 240         | 950         |      |
|  |   | Annual consumption                | TOTAL kWh **                                   | -       | -            | -                                  | -          | 400    | -           | -           |      |
|  | EER/EER CLASS                                       | TOTAL (W/W) <sup>7)</sup> ("A"-G) | -  | -       | -            | 4.50                               | 4.50/A     | 4.50   | 6.25        | 4.21        |      |
|  | Erp <sup>6)</sup>                                   | Pdesign                           | kW   | -       | -            | -                                  | -          | 3.6    | -           | -           |      |
|  |   | SEER                              | (W/W)  | -       | -            | -                                  | -          | 6.3    | -           | -           |      |
|  |   | Annual consumption                | kWh  | -       | -            | -                                  | -          | 200    | -           | -           |      |
| Class  |   |                                   | -  | -       | -            | -                                  | A++        | -      | -           |             |      |
| Power factor   | %   | -                                 | -  | -       | 91           | 91                                 | 91         | -      | -           |             |      |
| Noise indoor   | dB-A (H/M/L)  | 36/32/26(31)*7                    |  |         |              |                                    |            | -      | -           |             |      |
|  | Power Level dB                                      | 51/47/41(46)*7                    |  |         |              |                                    |            | -      | -           |             |      |
| Noise outdoor  | dB-A (H/L)  |                                   |  |         | 45/-         |                                    |            | -      | -           |             |      |
|  | Power Level dB                                      |                                   |  |         | 64/-         |                                    |            | -      | -           |             |      |
| H<br>E<br>A<br>T<br>I<br>N<br>G                            | Capacity  | kW                                | 4.0  | 4.0     | 4.0          | -                                  | -          | -      | 1.5         | 5.0         |      |
|  |   | BTU/h                             | 13600  | 13600   | 13600        | -                                  | -          | -      | 5100        | 17100       |      |
|  | Current   | A                                 | 0.30   | 0.30    | 0.30         | 4.70                               | 4.50       | 4.35   | -           | -           |      |
|  |   | W                                 | 35   | 35      | 35           | 0.945k                             | 0.945k     | 0.945k | -           | -           |      |
|  | Input power   | TOTAL W                           | -  | -       | -            | 0.980k                             | 0.980k     | 0.980k | 190         | 1.360k      |      |
|  |   | COP/COP CLASS                     | TOTAL (W/W) <sup>7)</sup> ("A"-G)              | -       | -            | -                                  | 4.08       | 4.08/A | 4.08        | 7.89        | 3.68 |
|  | Erp <sup>6)</sup>                                   | Pdesign at -10°C                  | kW   | -       | -            | -                                  | -          | 3.6    | -           | -           |      |
|  |   | Tbivalent                         | °C   | -       | -            | -                                  | -          | -10    | -           | -           |      |
|  |   | SCOP                              | (W/W)  | -       | -            | -                                  | -          | 4.1    | -           | -           |      |
|  |   | Annual consumption                | kWh  | -       | -            | -                                  | -          | 1229   | -           | -           |      |
| Class  |   | -                                 | -  | -       | -            | A+                                 | -          | -      |             |             |      |
| Power factor   | %   | -                                 | -  | -       | 91           | 91                                 | 91         | -      | -           |             |      |
| Noise indoor   | dB-A (H/M/L)  | 36/32/26(31)*7                    |  |         |              |                                    |            | -      | -           |             |      |
|  | Power Level dB                                      | 51/47/41(46)*7                    |  |         |              |                                    |            | -      | -           |             |      |
| Noise outdoor  | dB-A (H/L)  |                                   |  |         | 46/-         |                                    |            | -      | -           |             |      |
|  | Power Level dB                                      |                                   |  |         | 66/-         |                                    |            | -      | -           |             |      |
| EXTRA LOW TEMP   Total capacity(kW) / Input power(W) / COP |   |                                   |  |         |              |                                    |            |        |             |             |      |
| Max Current(A) / Max Input power(W)                        |   | 0.35/50                           | 0.35/50  | 0.35/50 | 11.0/2.20k   | 11.0/2.30k                         | 11.0/2.40k |        |             |             |      |
| Starting current(A) / Comp output(W)                       |   | -                                 | -  | -       | 4.70/1.1k    | 4.50/1.1k                          | 4.35/1.1k  |        |             |             |      |
| Network Impedance(QMAX.)                                   |   |                                   |  |         |              |                                    |            |        |             |             |      |
| Fan motor output (Indoor/Outdoor) W                        |   | 40                                |  |         | 60           |                                    |            |        |             |             |      |
| Moisture removal volume                                    |   | L/h(Pt/h)                         | 2.1  | (4.4)   |              |                                    |            |        |             |             |      |
| Indoor Air flow  | Cooling   | m³/min (ft³/min)                  | 9.7 / 8.0 / 6.0*7 (343) / (283) / (212)        |         |              |                                    |            |        | -           | -           |      |
|  | Heating   | m³/min (ft³/min)                  | 9.9 / 8.2 / 6.0*7 (350) / (290) / (212)        |         |              |                                    |            |        | -           | -           |      |
| Outdoor Air flow   | Cooling   | m³/min (ft³/min)                  |  |         |              | 38 (1342)                          |            |        | -           | -           |      |
|  | Heating   | m³/min (ft³/min)                  |  |         |              | 38 (1342)                          |            |        | -           | -           |      |
| Refrigerant type / amount g(oz)                            |   |                                   |  |         | R410A        | 1.40k                              | (49.4)     |        |             |             |      |
| Product dimension  | Height  | mm(inch)                          | 260<265 + 23>                                  |         | (10-1/4)     | 619                                | (24-3/8)   |        |             |             |      |
|  | Width   | mm(inch)                          | 575<583>                                       |         | (22-21/32)   | 799                                | (31-29/64) |        |             |             |      |
|  | Depth   | mm(inch)                          | 575<583>                                       |         | (22-21/32)   | 299                                | (11-49/64) |        |             |             |      |
|  | Panel H×W×D   | mm                                | 31 × 700 × 700 *                               |         |              |                                    |            |        | * CZ-KPY3AW |             |      |
| Packing dimension  | Height  | mm(inch)                          | 345  |         | (13-19/32)   | 688                                |            |        |             |             |      |
|  | Width   | mm(inch)                          | 691  |         | (27-7/32)    | 931                                |            |        |             |             |      |
|  | Depth   | mm(inch)                          | 691  |         | (27-7/32)    | 422                                |            |        |             |             |      |
| Weight   | (NET)   | kg(lb)                            | 18   |         | (40)         | 39 (86)                            |            |        |             |             |      |
|  | (GROSS)   | kg(lb)                            | 23   |         | (51)         | 44 (97)                            |            |        |             |             |      |
|  | Panel (NET)   | kg(lb)                            | 2.4  |         | (5.3)        |                                    |            |        |             |             |      |
| Layers limit (actually)                                    |   | 11 (12)                           |  |         | 5 (6)        |                                    |            |        |             |             |      |
| Operation condition  | Cool (DBT)  | 18°C ~ 32°C                       |  |         | -15°C ~ 46°C |                                    |            |        |             |             |      |
|  | Heat (DBT)  | 16°C ~ 30°C                       |  |         | -20°C ~ 24°C |                                    |            |        |             |             |      |
| P<br>I<br>P<br>E<br>I<br>N<br>G                            | Pipe diameter mm (inch)                             |                                   | (Liquid)ø6.35(1/4) (Gas)ø12.7(1/2)             |         |              | (Liquid)ø6.35(1/4) (Gas)ø12.7(1/2) |            |        |             |             |      |
|  | Connecting method, Standard length m(ft)            |                                   | flared type, 5.0 (16.4)                        |         |              | flared type, 5.0 (16.4)            |            |        |             |             |      |
|  | Pipe length range m (ft)                            |                                   | 3 ~ 40m (9.8 ~ 131.2)                          |         |              |                                    |            |        |             |             |      |
|  | Indoor unit & Outdoor unit height difference m (ft) |                                   | 15m (OD located lower)/30m (OD located higher) |         |              |                                    |            |        |             | (49.2/98.4) |      |
| Add gas amount g/m (oz/ft)                                 |   | 20g (0.215)                       |  |         |              |                                    |            |        |             |             |      |
| Pipe length for additional gas m (ft)                      |   | 30m (98.4)                        |  |         |              |                                    |            |        |             |             |      |

\*1: In case it is necessary to indicate the air flow volume in (l/s), the value in (m³/min.) shall be multiplied by 16.7 and rounded down the decimal point.  
 \*2: If the EUROVENT Certified models can be operated under the "extra-low" temperature condition, -7°C dry bulb and -8°C wet-bulb temperatures with rated voltage 230 V shall be used.  
 \*3: Network Impedance shall be applicable for EUROPE and CHINA models.  
 \*4: The annual consumption is calculated by multiplying the input power at 230V (400V) by an average of 500 hours per year in cooling mode.  
 \*5: EER and COP classification is at 230V (400V) only in accordance with EU directive 2002/31/EC.  
 \*6: SEER and SCOP classification is at 230V (400V) only in accordance with EN-14825. For heating, SCOP indicates the value of only Average heating season. Other fiche data indicates in an attached sheet.  
 \*7: Noise and air flow rate of L are indicated by the values at FAN mode. ( ) : Normal operation Cooling/Heating noise value. Normal operation Cooling/Heating air flow rate are 7.6 (m³/min).

# Simultaneous (Twin) -Type

## 1-1. Unit Specifications

**PE1**

### 6. 4-Way Cassette 60x60 Type S-36PY2E5A×2 / U-71PE1E5A

| INDOOR   |   | MODEL                                      | S-36PY2E5A ×2                               |             |                                     | -              |            |        | -           |        |
|--|---|--|---|-------------|-------------------------------------|----------------|------------|--------|-------------|--------|
| PANEL  |   | MODEL                                      | (CZ-KPY3AW / CZ-KPY3BW) ×2                  |             |                                     | -              |            |        | -           |        |
| OUTDOOR  |   | MODEL                                      | -   |             |                                     | U-71PE1E5A     |            |        | -           |        |
| Branch pipe  |   | MODEL                                      | CZ-P155BK1                                  |             |                                     |                |            |        |             |        |
| Performance test condition                                 |   | ISO5151 / EN14511 / EN14825 / EN12102      |   |             |                                     |                |            |        |             |        |
| C<br>O<br>O<br>L<br>I<br>N<br>G                            | Power supply  | ∅, Hz                                      | 1∅ 50Hz                                     |             |                                     | 1∅ 50Hz        |            |        |             |        |
|  |   | V  | 220   | 230         | 240                                 | 220            | 230        | 240    | Min         | Max    |
|  | Capacity  | kW   | 7.1   | 7.1         | 7.1                                 | -              | -          | -      | 2.5         | 8.0    |
|  |   | BTU/h                                      | 24200                                       | 24200       | 24200                               | -              | -          | -      | 8500        | 27300  |
|  | Current   | A  | 0.30 x 2                                    |             |                                     | 9.60           | 9.30       | 9.00   | -           | -      |
|  |   | W  | 40 x 2                                      |             |                                     | 1.985k         | 1.985k     | 1.985k | -           | -      |
|  | Input power   | TOTAL W                                    | -   |             |                                     | 2.065k         | 2.065k     | 2.065k | 450         | 2.650k |
|  |   | Annual consumption                         | TOTAL kWh **                                | -           | -                                   | -              | -          | 1032.5 | -           | -      |
|  | EER/EER CLASS                                       | TOTAL (W/W) <sup>††</sup> ("A"-G)          | -   | -           | -                                   | 3.44           | 3.44/A     | 3.44   | 5.56        | 3.02   |
|  | E <sub>sp</sub> <sup>†††</sup>                      | Pdesign                                    | kW  | -           | -                                   | -              | -          | 7.1    | -           | -      |
| SEER   |   | (W/W)                                      | -   | -           | -                                   | -              | 6.2        | -      | -           |        |
| Annual consumption   |   | kWh  | -   | -           | -                                   | -              | 401        | -      | -           |        |
| Class  |   |  | -   | -           | -                                   | -              | A++        | -      | -           |        |
| Power factor   | %   | -  | -   | -           | 94                                  | 93             | 92         | -      | -           |        |
| Noise indoor   | dB-A (H/M/L)  | 36/32/26(31)*7                             |   |             | -                                   |                |            | -      | -           |        |
|  | Power Level dB                                      | 51/47/41(46)*7                             |   |             | -                                   |                |            | -      | -           |        |
| Noise outdoor  | dB-A (H/L)  | -  |   |             | 48/-                                |                |            | -      | -           |        |
|  | Power Level dB                                      | -  |   |             | 65/-                                |                |            | -      | -           |        |
| H<br>E<br>A<br>T<br>I<br>N<br>G                            | Capacity  | kW   | 8.0   | 8.0         | 8.0                                 | -              | -          | -      | 2.0         | 9.0    |
|  |   | BTU/h                                      | 27300                                       | 27300       | 27300                               | -              | -          | -      | 6800        | 30700  |
|  | Current   | A  | 0.30 x 2                                    |             |                                     | 10.0           | 9.70       | 9.40   | -           | -      |
|  |   | W  | 35 x 2                                      |             |                                     | 2.080k         | 2.080k     | 2.080k | -           | -      |
|  | Input power   | TOTAL W                                    | -   |             |                                     | 2.150k         | 2.150k     | 2.150k | 400         | 2.900k |
|  |   | COP/COP CLASS                              | TOTAL (W/W) <sup>††</sup> ("A"-G)           | -           | -                                   | -              | 3.72       | 3.72/A | 3.72        | 5.00   |
|  | E <sub>sp</sub> <sup>†††</sup>                      | Pdesign at -10°C                           | kW  | -           | -                                   | -              | -          | 7.1    | -           | -      |
|  |   | Tbivalent                                  | °C  | -           | -                                   | -              | -          | -7     | -           | -      |
|  |   | SCOP                                       | (W/W)                                       | -           | -                                   | -              | -          | 3.8    | -           | -      |
|  |   | Annual consumption                         | kWh   | -           | -                                   | -              | -          | 2616   | -           | -      |
| Class  |   | -  | -   | -           | -                                   | A              | -          | -      |             |        |
| Power factor   | %   | -  | -   | -           | 95                                  | 93             | 92         | -      | -           |        |
| Noise indoor   | dB-A (H/M/L)  | 36/32/26(31)*7                             |   |             | -                                   |                |            | -      | -           |        |
|  | Power Level dB                                      | 51/47/41(46)*7                             |   |             | -                                   |                |            | -      | -           |        |
| Noise outdoor  | dB-A (H/L)  | -  |   |             | 50/-                                |                |            | -      | -           |        |
|  | Power Level dB                                      | -  |   |             | 67/-                                |                |            | -      | -           |        |
| EXTRA LOW TEMP   Total capacity(kW) / Input power(W) / COP |   | -  |   |             |                                     |                |            |        |             |        |
| Max Current(A) / Max Input power(W)                        |   | 0.35/50 x 2                                | 0.35/50 x 2                                 | 0.35/50 x 2 | 18.0/3.80k                          | 18.0/3.93k     | 18.0/4.06k | -      | -           |        |
| Starting current(A) / Comp output(W)                       |   | -  | -   | -           | 10.0/2.0k                           | 9.70/2.0k      | 9.40/2.0k  | -      | -           |        |
| Network Impedance(QMAX.)                                   |   | -  |   |             |                                     |                |            |        |             |        |
| Fan motor output (Indoor/Outdoor) W                        |   | 40 x 2                                     |   |             | 90                                  |                |            | -      |             |        |
| Moisture removal volume                                    |   | L/h (P/h)                                  | 4.2   | (2.1×2)     | (8.8)                               | -              |            |        | -           |        |
| Indoor Air flow  | Cooling   | m <sup>3</sup> /min (ft <sup>3</sup> /min) | 9.7×2/8.0×2/6.0×2*7 (343)×2/(283)×2/(212)×2 |             |                                     | -              |            |        | -           |        |
|  | Heating   | m <sup>3</sup> /min (ft <sup>3</sup> /min) | 9.9×2/8.2×2/6.0×2*7 (350)×2/(290)×2/(212)×2 |             |                                     | -              |            |        | -           |        |
| Outdoor Air flow   | Cooling   | m <sup>3</sup> /min (ft <sup>3</sup> /min) | -   |             |                                     | 60 (2119)      |            |        | -           |        |
|  | Heating   | m <sup>3</sup> /min (ft <sup>3</sup> /min) | -   |             |                                     | 60 (2119)      |            |        | -           |        |
| Refrigerant type / amount g(oz)                            |   | -  |   |             | R410A                               | 2.35k          | (82.9)     | -      | -           |        |
| Product dimension  | Height  | mm(inch)                                   | 260<265 + 23> (10-1/4)                      |             |                                     | 996 (39-7/32)  |            |        | -           | -      |
|  | Width   | mm(inch)                                   | 575<583> (22-21/32)                         |             |                                     | 940 (37-1/32)  |            |        | -           | -      |
|  | Depth   | mm(inch)                                   | 575<583> (22-21/32)                         |             |                                     | 340 (13-13/32) |            |        | -           | -      |
|  | Panel H×W×D   | mm   | 31 × 700 × 700 *                            |             |                                     | -              |            |        | * CZ-KPY3AW |        |
| Packing dimension  | Height  | mm(inch)                                   | 345 (13-19/32)                              |             |                                     | 1136           |            |        | -           | -      |
|  | Width   | mm(inch)                                   | 691 (27-7/32)                               |             |                                     | 1055           |            |        | -           | -      |
|  | Depth   | mm(inch)                                   | 691 (27-7/32)                               |             |                                     | 485            |            |        | -           | -      |
| Weight   | (NET)   | kg(lb)                                     | 18 (40)                                     |             |                                     | 69 (152)       |            |        | -           | -      |
|  | (GROSS)   | kg(lb)                                     | 23 (51)                                     |             |                                     | 77 (170)       |            |        | -           | -      |
| Layers limit (actually)                                    |   | 11 (12)                                    |   |             | 2 (3)                               |                |            | -      |             |        |
| Operation condition  | Cool (DBT)  | 18°C ~ 32°C                                |   |             | -15°C ~ 46°C                        |                |            | -      |             |        |
|  | Heat (DBT)  | 16°C ~ 30°C                                |   |             | -20°C ~ 24°C                        |                |            | -      |             |        |
| P<br>I<br>P<br>E   | Pipe diameter mm (inch)                             | (Liquid)∅6.35(1/4) (Gas)∅12.7(1/2)         |   |             | (Liquid)∅9.52(3/8) (Gas)∅15.88(5/8) |                |            | -      |             |        |
|  | Connecting method, Standard length m(ft)            | flared type, 5.0 (16.4)                    |   |             | flared type, 5.0 (16.4)             |                |            | -      |             |        |
| P<br>I<br>N<br>G   | Pipe length range m (ft)                            | 5 ~ 50 (16.4 ~ 164.0)                      |   |             |                                     |                |            |        |             |        |
|  | Indoor unit & Outdoor unit height difference m (ft) | 15(OD located lower)/30(OD located higher) |   |             | (49.2/98.4)                         |                |            | -      |             |        |
| Add gas amount g/m (oz/ft)                                 |   | 50 (0.538)                                 |   |             |                                     |                |            |        |             |        |
| Pipe length for additional gas m (ft)                      |   | 30 (98.4)                                  |   |             |                                     |                |            |        |             |        |

\*1: In case it is necessary to indicate the air flow volume in (l/s), the value in (m<sup>3</sup>/min.) shall be multiplied by 16.7 and rounded down the decimal point.

\*2: If the EUROVENT Certified models can be operated under the "extra-low" temperature condition, -7°C dry bulb and -8°C wet-bulb temperatures with rated voltage 230 V shall be used.

\*3: Network Impedance shall be applicable for EUROPE and CHINA models.

\*4: The annual consumption is calculated by multiplying the input power at 230V (400V) by an average of 500 hours per year in cooling mode.

\*5: EER and COP classification is at 230V (400V) only in accordance with EU directive 2002/31/EC.

\*6: SEER and SCOP classification is at 230V (400V) only in accordance with EN-14825. For heating, SCOP indicates the value of only Average heating season. Other fiche data indicates in an attached sheet.

\*7: Noise and air flow rate of L are indicated by the values at FAN mode. ( ) : Normal operation Cooling/Heating noise value. Normal operation Cooling/Heating air flow rate are 7.6 (m<sup>3</sup>/min).

# Simultaneous (Triple) -Type

## 1-1. Unit Specifications

PE1

### 6. 4-Way Cassette 60x60 Type S-36PY2E5A×3 / U-100PE1E5A

|   |  |   |   |                |             |                                     |            |            |        |             |        |
|---|--|---|---|----------------|-------------|-------------------------------------|------------|------------|--------|-------------|--------|
| INDOOR  |  | MODEL                                     | S-36PY2E5A ×3                               |                |             |                                     |            |            | -      | -           |        |
| PANEL   |  | MODEL                                     | (CZ-KPY3AW / CZ-KPY3BW) ×3                  |                |             |                                     |            |            | -      | -           |        |
| OUTDOOR   |  | MODEL                                     | -   |                |             | U-100PE1E5A                         |            |            | -      | -           |        |
| Branch pipe   |  | MODEL                                     |   |                |             | CZ-P3HPC2                           |            |            | -      | -           |        |
| Performance test condition                          |  | ISO5151 / EN14511 / EN14825 / EN12102     |   |                |             |                                     |            |            |        |             |        |
| C<br>O<br>O<br>L<br>I<br>N<br>G                     | Power supply                             |   | 1ø 50Hz                                     |                |             | 1ø 50Hz                             |            |            |        |             |        |
|   |  |   | Ø, Hz                                       |                |             |                                     |            |            |        |             |        |
|   |  |   | V   | 220            | 230         | 240                                 | 220        | 230        | 240    | Min         | Max    |
|   | Capacity                                 |   | kW  | 10.0           | 10.0        | 10.0                                | -          | -          | -      | 3.3         | 12.5   |
|   |  |   | BTU/h                                       | 34100          | 34100       | 34100                               | -          | -          | -      | 11300       | 42700  |
|   | Current                                  |   | A   | 0.30 × 3       |             |                                     | 12.2       | 11.8       | 11.3   | -           | -      |
|   | Input power                              |   | W   | 40 × 3         |             |                                     | 2.560k     | 2.560k     | 2.560k | -           | -      |
|   |  |   | TOTAL W                                     |                |             |                                     | 2.680k     | 2.680k     | 2.680k | 840         | 3.700k |
|   | Annual consumption                       |   | TOTAL kWh **                                | -              | -           | -                                   | -          | 1340       | -      | -           | -      |
|   | EER/EER CLASS                            |   | TOTAL (W/W) <sup>††</sup> ("A"-G)           | -              | -           | -                                   | 3.73       | 3.73/A     | 3.73   | 3.93        | 3.38   |
|   | E<br>r<br>p<br>*<br>6                    | P<br>d<br>e<br>s<br>i<br>g<br>n           | Pdesign                                     | kW             | -           | -                                   | -          | -          | 10.0   | -           | -      |
|   |  |   | SEER  | (W/W)          | -           | -                                   | -          | -          | 6.5    | -           | -      |
|   |  |   | Annual consumption                          | kWh            | -           | -                                   | -          | -          | 538    | -           | -      |
|   |  |   | Class                                       |                | -           | -                                   | -          | -          | A++    | -           | -      |
| Power factor  |  | %   | -   | -              | -           | 95                                  | 94         | 94         | -      | -           |        |
| Noise indoor  |  | dB-A (H/M/L)                              | 36/32/26(31)*7                              |                |             |                                     |            |            | -      | -           |        |
|   |  | Power Level dB                            | 51/47/41(46)*7                              |                |             |                                     |            |            | -      | -           |        |
| Noise outdoor                                       |  | dB-A (H/L)                                |   |                |             | 52/-                                |            |            | -      | -           |        |
|   |  | Power Level dB                            |   |                |             | 69/-                                |            |            | -      | -           |        |
| H<br>E<br>A<br>T<br>I<br>N<br>G                     | Capacity                                 |   | kW  | 11.2           | 11.2        | 11.2                                | -          | -          | -      | 4.1         | 14.0   |
|   |  |   | BTU/h                                       | 38200          | 38200       | 38200                               | -          | -          | -      | 14000       | 47800  |
|   | Current                                  |   | A   | 0.30 × 3       |             |                                     | 13.4       | 13.0       | 12.6   | -           | -      |
|   | Input power                              |   | W   | 35 × 3         |             |                                     | 2.825k     | 2.825k     | 2.825k | -           | -      |
|   |  |   | TOTAL W                                     |                |             |                                     | 2.930k     | 2.930k     | 2.930k | 900         | 4.400k |
|   | COP/COP CLASS                            |   | TOTAL (W/W) <sup>††</sup> ("A"-G)           | -              | -           | -                                   | 3.82       | 3.82/A     | 3.82   | 4.56        | 3.18   |
|   | E<br>r<br>p<br>*<br>6                    | P<br>d<br>e<br>s<br>i<br>g<br>n           | Pdesign at -10°C                            | kW             | -           | -                                   | -          | -          | 9.5    | -           | -      |
|   |  |   | Tbivalent                                   | °C             | -           | -                                   | -          | -          | -10    | -           | -      |
|   |  |   | SCOP  | (W/W)          | -           | -                                   | -          | -          | 3.8    | -           | -      |
|   |  |   | Annual consumption                          | kWh            | -           | -                                   | -          | -          | 3500   | -           | -      |
|   | Power factor                             |   | %   | -              | -           | -                                   | 96         | 94         | 93     | -           | -      |
|   | Noise indoor                             |   | dB-A (H/M/L)                                | 36/32/26(31)*7 |             |                                     |            |            |        | -           | -      |
|   |  |   | Power Level dB                              | 51/47/41(46)*7 |             |                                     |            |            |        | -           | -      |
|   | Noise outdoor                            |   | dB-A (H/L)                                  |                |             |                                     | 52/-       |            |        | -           | -      |
|   |  | Power Level dB                            |   |                |             | 69/-                                |            |            | -      | -           |        |
| EXTRA LOW TEMP                                      |  | Total capacity(kW) / Input power(W) / COP |   |                |             |                                     |            |            |        |             |        |
| Max Current(A) / Max Input power(W)                 |  |   | 0.35/50 × 3                                 | 0.35/50 × 3    | 0.35/50 × 3 | 25.0/5.35k                          | 25.0/5.55k | 25.0/5.75k | -      | -           |        |
| Starting current(A) / Comp output(W)                |  |   | -   | -              | -           | 13.4/3.0k                           | 13.0/3.0k  | 12.6/3.0k  | -      | -           |        |
| Network Impedance(QMAX.)                            |  |   | -   |                |             | -                                   |            |            | -      | -           |        |
| Fan motor output (Indoor/Outdoor) W                 |  |   | 40 × 3                                      |                |             | 90 × 2                              |            |            | -      | -           |        |
| Moisture removal volume                             |  | L/h(PT/h)                                 | 6.0   | (2.0×3)        | (12.6)      |                                     |            |            | -      | -           |        |
| Indoor Air flow                                     | Cooling                                  | m³/min (ft³/min)                          | 9.7×3/8.0×3/6.0×3*7 (343)×3/(283)×3/(212)×3 |                |             |                                     |            |            | -      | -           |        |
|   | Heating                                  | m³/min (ft³/min)                          | 9.9×3/8.2×3/6.0×3*7 (350)×3/(290)×3/(212)×3 |                |             |                                     |            |            | -      | -           |        |
| Outdoor Air flow                                    | Cooling                                  | m³/min (ft³/min)                          | -   |                |             | 110 (3885)                          |            |            | -      | -           |        |
|   | Heating                                  | m³/min (ft³/min)                          | -   |                |             | 95 (3355)                           |            |            | -      | -           |        |
| Refrigerant type / amount g(oz)                     |  |   | -   |                |             | R410A                               | 3.40k      | (119.9)    | -      | -           |        |
| Product dimension                                   | Height                                   | mm(inch)                                  | 260<265 + 23> (10-1/4)                      |                |             | 1416 (55-3/4)                       |            |            | -      | -           |        |
|   | Width                                    | mm(inch)                                  | 575<583> (22-21/32)                         |                |             | 940 (37-1/32)                       |            |            | -      | -           |        |
|   | Depth                                    | mm(inch)                                  | 575<583> (22-21/32)                         |                |             | 340 (13-13/32)                      |            |            | -      | -           |        |
|   | Panel H×W×D mm                           |   | 31 × 700 × 700 *                            |                |             | -                                   |            |            | -      | * CZ-KPY3AW |        |
| Packing dimension                                   | Height                                   | mm(inch)                                  | 345 (13-19/32)                              |                |             | 1556                                |            |            | -      | -           |        |
|   | Width                                    | mm(inch)                                  | 691 (27-7/32)                               |                |             | 1055                                |            |            | -      | -           |        |
|   | Depth                                    | mm(inch)                                  | 691 (27-7/32)                               |                |             | 485                                 |            |            | -      | -           |        |
| Weight  | (NET)                                    | kg(lb)                                    | 18 (40)                                     |                |             | 98 (216)                            |            |            | -      | -           |        |
|   | (GROSS)                                  | kg(lb)                                    | 23 (51)                                     |                |             | 108 (238)                           |            |            | -      | -           |        |
| Layers limit (actually)                             |  |   | 11 (12)                                     |                |             | 1 (2)                               |            |            | -      | -           |        |
| Operation condition                                 | Cool (DBT)                               |   | 18°C ~ 32°C                                 |                |             | -15°C ~ 46°C                        |            |            | -      | -           |        |
|   | Heat (DBT)                               |   | 16°C ~ 30°C                                 |                |             | -20°C ~ 24°C                        |            |            | -      | -           |        |
| P<br>I<br>P<br>I<br>N<br>G                          | Pipe diameter mm (inch)                  |   | (Liquid)ø6.35(1/4) (Gas)ø12.7(1/2)          |                |             | (Liquid)ø9.52(3/8) (Gas)ø15.88(5/8) |            |            | -      | -           |        |
|   | Connecting method, Standard length m(ft) |   | flared type, 5.0 (16.4)                     |                |             | flared type, 5.0 (16.4)             |            |            | -      | -           |        |
| Pipe length range m (ft)                            |  |   | 5 ~ 75 (16.4 ~ 246.1)                       |                |             |                                     |            |            |        | -           | -      |
| Indoor unit & Outdoor unit height difference m (ft) |  |   | 15(OD located lower)/30(OD located higher)  |                |             | (49.2/98.4)                         |            |            | -      | -           |        |
| Add gas amount g/m (oz/ft)                          |  |   | 50 (0.538)                                  |                |             |                                     |            |            |        | -           | -      |
| Pipe length for additional gas m (ft)               |  |   | 20 (65.6)                                   |                |             |                                     |            |            |        | -           | -      |

\*1: In case it is necessary to indicate the air flow volume in (l/s), the value in (m³/min.) shall be multiplied by 16.7 and rounded down the decimal point.  
\*2: If the EUROVENT Certified models can be operated under the "extra-low" temperature condition, -7°C dry bulb and -8°C wet-bulb temperatures with rated voltage 230 V shall be used.  
\*3: Network Impedance shall be applicable for EUROPE and CHINA models.  
\*4: The annual consumption is calculated by multiplying the input power at 230V (400V) by an average of 500 hours per year in cooling mode.  
\*5: EER and COP classification is at 230V (400V) only in accordance with EU directive 2002/31/EC.  
\*6: SEER and SCOP classification is at 230V (400V) only in accordance with EN-14825. For heating, SCOP indicates the value of only Average heating season. Other fiche data indicates in an attached sheet.  
\*7: Noise and air flow rate of L are indicated by the values at FAN mode. ( ) : Normal operation Cooling/Heating noise value. Normal operation Cooling/Heating air flow rate are 7.6 (m³/min).

# Simultaneous (Double-Twin) -Type

## 1-1. Unit Specifications

**PE1**

### 6. 4-Way Cassette 60x60 Type S-36PY2E5A×4 / U-125PE1E5A

| INDOOR   |  | MODEL                                      | S-36PY2E5A ×4                               |             |                                     | -              |        |            | -      |            |      |             |   |  |
|--|--|--|---|-------------|-------------------------------------|----------------|--------|------------|--------|------------|------|-------------|---|--|
| PANEL  |  | MODEL                                      | (CZ-KPY3AW / CZ-KPY3BW) ×4                  |             |                                     | -              |        |            | -      |            |      |             |   |  |
| OUTDOOR  |  | MODEL                                      | -   |             |                                     | U-125PE1E5A    |        |            | -      |            |      |             |   |  |
| Branch pipe  |  | MODEL                                      | -   |             |                                     | CZ-P155BK1 ×3  |        |            | -      |            |      |             |   |  |
| Performance test condition                                 |  |  | ISO5151 / EN14511 / EN14825 / EN12102       |             |                                     |                |        |            |        |            |      |             |   |  |
| C<br>O<br>O<br>L<br>I<br>N<br>G                            | Power supply                             | ∅, Hz                                      | 1∅ 50Hz                                     |             |                                     | 1∅ 50Hz        |        |            |        |            |      |             |   |  |
|  |  | V  | 220   | 230         | 240                                 | 220            | 230    | 240        | Min    | Max        |      |             |   |  |
|  | Capacity                                 | kW   | 12.5  | 12.5        | 12.5                                | -              | -      | -          | 3.3    | 14.0       |      |             |   |  |
|  |  | BTU/h                                      | 42700                                       | 42700       | 42700                               | -              | -      | -          | 11300  | 47800      |      |             |   |  |
|  | Current                                  | A  | 0.30 × 4                                    |             |                                     | 17.5           | 16.9   | 16.4       | -      | -          |      |             |   |  |
|  |  | W  | 40 × 4                                      |             |                                     | 3.680k         | 3.680k | 3.680k     | -      | -          |      |             |   |  |
|  | Input power                              | TOTAL W                                    | -   |             |                                     | 3.840k         | 3.840k | 3.840k     | 840    | 4.600k     |      |             |   |  |
|  |  | Annual consumption                         | TOTAL kWh **                                | -           | -                                   | -              | -      | 1920       | -      | -          |      |             |   |  |
|  | EER/EER CLASS                            | TOTAL (W/W) <sup>†‡</sup> ("A"-G)          | -   | -           | -                                   | 3.26           | 3.26/A | 3.26       | 3.93   | 3.04       |      |             |   |  |
|  | Erp<br>*6                                | Pdesign                                    | kW  | -           | -                                   | -              | -      | 12.5       | -      | -          |      |             |   |  |
| η <sub>s.c</sub>   |  | %  | -   | -           | -                                   | -              | 209.2  | -          | -      |            |      |             |   |  |
| Annual consumption   |  | kWh  | -   | -           | -                                   | -              | -      | -          | -      |            |      |             |   |  |
| Class  |  |  | -   | -           | -                                   | -              | -      | -          | -      |            |      |             |   |  |
| Power factor   | %  | -  | -   | -           | 96                                  | 95             | 93     | -          | -      |            |      |             |   |  |
| Noise indoor   | dB-A (H/M/L)                             | 36/32/26(31)*7                             |   |             | -                                   |                |        | -          | -      |            |      |             |   |  |
|  | Power Level dB                           | 51/47/41(46)*7                             |   |             | -                                   |                |        | -          | -      |            |      |             |   |  |
| Noise outdoor  | dB-A (H/L)                               | -  |   |             | 53/-                                |                |        | -          | -      |            |      |             |   |  |
|  | Power Level dB                           | -  |   |             | 70/-                                |                |        | -          | -      |            |      |             |   |  |
| H<br>E<br>A<br>T<br>I<br>N<br>G                            | Capacity                                 | kW   | 14.0  | 14.0        | 14.0                                | -              | -      | -          | 4.1    | 16.0       |      |             |   |  |
|  |  | BTU/h                                      | 47800                                       | 47800       | 47800                               | -              | -      | -          | 14000  | 54600      |      |             |   |  |
|  | Current                                  | A  | 0.30 × 4                                    |             |                                     | 17.9           | 17.3   | 16.8       | -      | -          |      |             |   |  |
|  |  | W  | 35 × 4                                      |             |                                     | 3.750k         | 3.750k | 3.750k     | -      | -          |      |             |   |  |
|  | Input power                              | TOTAL W                                    | -   |             |                                     | 3.890k         | 3.890k | 3.890k     | 900    | 5.200k     |      |             |   |  |
|  |  | COP/COP CLASS                              | TOTAL (W/W) <sup>†‡</sup> ("A"-G)           | -           | -                                   | -              | 3.60   | 3.60/A     | 3.60   | 4.56       | 3.08 |             |   |  |
|  | Erp<br>*6                                | Pdesign at -10°C                           | kW  | -           | -                                   | -              | -      | 12.5       | -      | -          |      |             |   |  |
|  |  | Tbivalent                                  | °C  | -           | -                                   | -              | -      | -9         | -      | -          |      |             |   |  |
|  |  | η <sub>s.h</sub>                           | %   | -           | -                                   | -              | -      | 141.4      | -      | -          |      |             |   |  |
|  |  | Annual consumption                         | kWh   | -           | -                                   | -              | -      | -          | -      | -          |      |             |   |  |
| Class  |  | -  | -   | -           | -                                   | -              | -      | -          |        |            |      |             |   |  |
| Power factor   | %  | -  | -   | -           | 95                                  | 94             | 93     | -          | -      |            |      |             |   |  |
| Noise indoor   | dB-A (H/M/L)                             | 36/32/26(31)*7                             |   |             | -                                   |                |        | -          | -      |            |      |             |   |  |
|  | Power Level dB                           | 51/47/41(46)*7                             |   |             | -                                   |                |        | -          | -      |            |      |             |   |  |
| Noise outdoor  | dB-A (H/L)                               | -  |   |             | 53/-                                |                |        | -          | -      |            |      |             |   |  |
|  | Power Level dB                           | -  |   |             | 70/-                                |                |        | -          | -      |            |      |             |   |  |
| EXTRA LOW TEMP   Total capacity(kW) / Input power(W) / COP |  |  |   |             |                                     |                |        |            |        |            |      |             |   |  |
| Max Current(A) / Max Input power(W)                        |  | 0.35/50 × 4                                |   | 0.35/50 × 4 |                                     | 0.35/50 × 4    |        | 28.0/6.00k |        | 28.0/6.20k |      | 28.0/6.40k  |   |  |
| Starting current(A) / Comp output(W)                       |  | -  |   | -           |                                     | -              |        | 17.9/3.0k  |        | 17.3/3.0k  |      | 16.8/3.0k   |   |  |
| Network Impedance(QMAX.)                                   |  | -  |   | -           |                                     | -              |        | -          |        | -          |      | -           |   |  |
| Fan motor output (Indoor/Outdoor) W                        |  | -  |   | 40 × 4      |                                     | -              |        | 90 × 2     |        | -          |      | -           |   |  |
| Moisture removal volume                                    |  | L/h (PT/h)                                 |   | 7.9         |                                     | (1.975×4)      |        | (16.6)     |        | -          |      | -           |   |  |
| Indoor Air flow  | Cooling                                  | m <sup>3</sup> /min (ft <sup>3</sup> /min) | 9.7×4/8.0×4/6.0×4*7 (343)×4/(283)×4/(212)×4 |             |                                     | -              |        |            | -      |            | -    |             | - |  |
|  | Heating                                  | m <sup>3</sup> /min (ft <sup>3</sup> /min) | 9.9×4/8.2×4/6.0×4*7 (350)×4/(290)×4/(212)×4 |             |                                     | -              |        |            | -      |            | -    |             | - |  |
| Outdoor Air flow   | Cooling                                  | m <sup>3</sup> /min (ft <sup>3</sup> /min) | -   |             |                                     | 130            |        |            | (4591) |            | -    |             | - |  |
|  | Heating                                  | m <sup>3</sup> /min (ft <sup>3</sup> /min) | -   |             |                                     | 110            |        |            | (3885) |            | -    |             | - |  |
| Refrigerant type / amount g(oz)                            |  | -  |   | -           |                                     | R410A          |        | 3.40k      |        | (119.9)    |      | -           |   |  |
| Product dimension  | Height                                   | mm(inch)                                   | 260<265 + 23> (10-1/4)                      |             |                                     | 1416 (55-3/4)  |        |            | -      |            | -    |             | - |  |
|  | Width                                    | mm(inch)                                   | 575<583> (22-21/32)                         |             |                                     | 940 (37-1/32)  |        |            | -      |            | -    |             | - |  |
|  | Depth                                    | mm(inch)                                   | 575<583> (22-21/32)                         |             |                                     | 340 (13-13/32) |        |            | -      |            | -    |             | - |  |
|  | Panel H×W×D mm                           | 31 × 700 × 700                             |   |             | *                                   |                |        | -          |        | -          |      | * CZ-KPY3AW |   |  |
| Packing dimension  | Height                                   | mm(inch)                                   | 345 (13-19/32)                              |             |                                     | 1556           |        |            | -      |            | -    |             | - |  |
|  | Width                                    | mm(inch)                                   | 691 (27-7/32)                               |             |                                     | 1055           |        |            | -      |            | -    |             | - |  |
|  | Depth                                    | mm(inch)                                   | 691 (27-7/32)                               |             |                                     | 485            |        |            | -      |            | -    |             | - |  |
| Weight   | (NET)                                    | kg(lb)                                     | 18 (40)                                     |             |                                     | 98 (216)       |        |            | -      |            | -    |             | - |  |
|  | (GROSS)                                  | kg(lb)                                     | 23 (51)                                     |             |                                     | 108 (238)      |        |            | -      |            | -    |             | - |  |
| Layers limit (actually)                                    |  | 11 (12)                                    |   | 1(2)        |                                     | -              |        | -          |        | -          |      | -           |   |  |
| Operation condition  | Cool (DBT)                               | 18°C ~ 32°C                                |   |             | -15°C ~ 46°C                        |                |        | -          |        | -          |      | -           |   |  |
|  | Heat (DBT)                               | 16°C ~ 30°C                                |   |             | -20°C ~ 24°C                        |                |        | -          |        | -          |      | -           |   |  |
| P<br>I<br>P<br>I<br>N<br>G                                 | Pipe diameter mm (inch)                  | (Liquid)∅6.35(1/4) (Gas)∅12.7(1/2)         |   |             | (Liquid)∅9.52(3/8) (Gas)∅15.88(5/8) |                |        | -          |        | -          |      | -           |   |  |
|  | Connecting method, Standard length m(ft) | flared type, 5.0 (16.4)                    |   |             | flared type, 5.0 (16.4)             |                |        | -          |        | -          |      | -           |   |  |
| Pipe length range m (ft)                                   |  | 5 ~ 75 (16.4 ~ 246.1)                      |   |             | -                                   |                |        | -          |        | -          |      | -           |   |  |
| Indoor unit & Outdoor unit height difference m (ft)        |  | 15(OD located lower)/30(OD located higher) |   |             | (49.2/98.4)                         |                |        | -          |        | -          |      | -           |   |  |
| Add gas amount g/m (oz/ft)                                 |  | 50 (0.538)                                 |   |             | -                                   |                |        | -          |        | -          |      | -           |   |  |
| Pipe length for additional gas m (ft)                      |  | 20 (65.6)                                  |   |             | -                                   |                |        | -          |        | -          |      | -           |   |  |

\*1: In case it is necessary to indicate the air flow volume in (l/s), the value in (m<sup>3</sup>/min.) shall be multiplied by 16.7 and rounded down the decimal point.

\*2: If the EUROVENT Certified models can be operated under the "extra-low" temperature condition, -7°C dry bulb and -8°C wet-bulb temperatures with rated voltage 230 V shall be used.

\*3: Network Impedance shall be applicable for EUROPE and CHINA models.

\*4: The annual consumption is calculated by multiplying the input power at 230V (400V) by an average of 500 hours per year in cooling mode.

\*5: EER and COP classification is at 230V (400V) only in accordance with EU directive 2002/31/EC.

\*6: SEER and SCOP classification is at 230V (400V) only in accordance with EN-14825. For heating, SCOP indicates the value of only Average heating season.

\*7: Noise and air flow rate of L are indicated by the values at FAN mode. ( ) : Normal operation Cooling/Heating noise value. Normal operation Cooling/Heating air flow rate are 7.6 (m<sup>3</sup>/min).

# Simultaneous (Triple) -Type

## 1-1. Unit Specifications

PE1

### 6. 4-Way Cassette 60x60 Type S-45PY2E5A×3 / U-125PE1E5A

| INDOOR   |  | MODEL                                      | S-45PY2E5A ×3                                 |             |                                     | -              |        |            | -      |            |      |             |   |  |
|--|--|--|---|-------------|-------------------------------------|----------------|--------|------------|--------|------------|------|-------------|---|--|
| PANEL  |  | MODEL                                      | (CZ-KPY3AW / CZ-KPY3BW) ×3                    |             |                                     | -              |        |            | -      |            |      |             |   |  |
| OUTDOOR  |  | MODEL                                      | -   |             |                                     | U-125PE1E5A    |        |            | -      |            |      |             |   |  |
| Branch pipe  |  | MODEL                                      | CZ-P3HPC2                                     |             |                                     |                |        |            |        | -          |      |             |   |  |
| Performance test condition                                 |  |  | ISO5151 / EN14511 / EN14825 / EN12102         |             |                                     |                |        |            |        |            |      |             |   |  |
| C<br>O<br>O<br>L<br>I<br>N<br>G                            | Power supply                             | ∅, Hz                                      | 1∅ 50Hz                                       |             |                                     | 1∅ 50Hz        |        |            |        |            |      |             |   |  |
|  |  | V  | 220   | 230         | 240                                 | 220            | 230    | 240        | Min    | Max        |      |             |   |  |
|  | Capacity                                 | kW   | 12.5  | 12.5        | 12.5                                | -              | -      | -          | 3.3    | 14.0       |      |             |   |  |
|  |  | BTU/h                                      | 42700   | 42700       | 42700                               | -              | -      | -          | 11300  | 47800      |      |             |   |  |
|  | Current                                  | A  | 0.32 × 3                                      |             |                                     | 17.5           | 16.9   | 16.4       | -      | -          |      |             |   |  |
|  |  | W  | 40 × 3  |             |                                     | 3.680k         | 3.680k | 3.680k     | -      | -          |      |             |   |  |
|  | Input power                              | TOTAL W                                    | -   |             |                                     | 3.800k         | 3.800k | 3.800k     | 840    | 4.600k     |      |             |   |  |
|  |  | Annual consumption                         | TOTAL kWh **                                  | -           | -                                   | -              | -      | 1900       | -      | -          |      |             |   |  |
|  | EER/EER CLASS                            | TOTAL (W/W) <sup>†‡</sup> ("A"-G)          | -   | -           | -                                   | 3.29           | 3.29/A | 3.29       | 3.93   | 3.04       |      |             |   |  |
|  | Erp<br>*6                                | Pdesign                                    | kW  | -           | -                                   | -              | -      | 12.5       | -      | -          |      |             |   |  |
| η <sub>s.c</sub>   |  | %  | -   | -           | -                                   | -              | 212.6  | -          | -      |            |      |             |   |  |
| Annual consumption   |  | kWh  | -   | -           | -                                   | -              | -      | -          | -      |            |      |             |   |  |
| Class  |  |  | -   | -           | -                                   | -              | -      | -          | -      |            |      |             |   |  |
| Power factor   | %  | -  | -   | -           | 96                                  | 95             | 93     | -          | -      |            |      |             |   |  |
| Noise indoor   | dB-A (H/M/L)                             | 38/34/28(32)*7                             |   |             | -                                   |                |        | -          | -      |            |      |             |   |  |
|  | Power Level dB                           | 53/49/43(47)*7                             |   |             | -                                   |                |        | -          | -      |            |      |             |   |  |
| Noise outdoor  | dB-A (H/L)                               | -  |   |             | 53/-                                |                |        | -          | -      |            |      |             |   |  |
|  | Power Level dB                           | -  |   |             | 70/-                                |                |        | -          | -      |            |      |             |   |  |
| H<br>E<br>A<br>T<br>I<br>N<br>G                            | Capacity                                 | kW   | 14.0  | 14.0        | 14.0                                | -              | -      | -          | 4.1    | 16.0       |      |             |   |  |
|  |  | BTU/h                                      | 47800   | 47800       | 47800                               | -              | -      | -          | 14000  | 54600      |      |             |   |  |
|  | Current                                  | A  | 0.30 × 3                                      |             |                                     | 17.9           | 17.3   | 16.8       | -      | -          |      |             |   |  |
|  |  | W  | 35 × 3  |             |                                     | 3.750k         | 3.750k | 3.750k     | -      | -          |      |             |   |  |
|  | Input power                              | TOTAL W                                    | -   |             |                                     | 3.860k         | 3.860k | 3.860k     | 900    | 5.200k     |      |             |   |  |
|  |  | COP/COP CLASS                              | TOTAL (W/W) <sup>†‡</sup> ("A"-G)             | -           | -                                   | -              | 3.63   | 3.63/A     | 3.63   | 4.56       | 3.08 |             |   |  |
|  | Erp<br>*6                                | Pdesign at -10°C                           | kW  | -           | -                                   | -              | -      | 12.5       | -      | -          |      |             |   |  |
|  |  | Tbivalent                                  | °C  | -           | -                                   | -              | -      | -9         | -      | -          |      |             |   |  |
|  |  | η <sub>s.h</sub>                           | %   | -           | -                                   | -              | -      | 141.5      | -      | -          |      |             |   |  |
|  |  | Annual consumption                         | kWh   | -           | -                                   | -              | -      | -          | -      | -          |      |             |   |  |
| Class  |  | -  | -   | -           | -                                   | -              | -      | -          |        |            |      |             |   |  |
| Power factor   | %  | -  | -   | -           | 95                                  | 94             | 93     | -          | -      |            |      |             |   |  |
| Noise indoor   | dB-A (H/M/L)                             | 38/34/28(32)*7                             |   |             | -                                   |                |        | -          | -      |            |      |             |   |  |
|  | Power Level dB                           | 53/49/43(47)*7                             |   |             | -                                   |                |        | -          | -      |            |      |             |   |  |
| Noise outdoor  | dB-A (H/L)                               | -  |   |             | 53/-                                |                |        | -          | -      |            |      |             |   |  |
|  | Power Level dB                           | -  |   |             | 70/-                                |                |        | -          | -      |            |      |             |   |  |
| EXTRA LOW TEMP   Total capacity(kW) / Input power(W) / COP |  |  |   |             |                                     |                |        |            |        |            |      |             |   |  |
| Max Current(A) / Max Input power(W)                        |  | 0.37/50 × 3                                |   | 0.37/50 × 3 |                                     | 0.37/50 × 3    |        | 28.0/6.00k |        | 28.0/6.20k |      | 28.0/6.40k  |   |  |
| Starting current(A) / Comp output(W)                       |  | -  |   | -           |                                     | -              |        | 17.9/3.0k  |        | 17.3/3.0k  |      | 16.8/3.0k   |   |  |
| Network Impedance(QMAX.)                                   |  | -  |   | -           |                                     | -              |        | -          |        | -          |      | -           |   |  |
| Fan motor output (Indoor/Outdoor) W                        |  | -  |   | 40 × 3      |                                     | -              |        | 90 × 2     |        | -          |      | -           |   |  |
| Moisture removal volume                                    |  | L/h (PT/h)                                 |   | 7.9         |                                     | (2.63×3)       |        | (16.6)     |        | -          |      | -           |   |  |
| Indoor Air flow  | Cooling                                  | m <sup>3</sup> /min (ft <sup>3</sup> /min) | 10.0×3/8.8×3/7.0 ×3*7 (353)×3/(311)×3/(247)×3 |             |                                     | -              |        |            | -      |            | -    |             | - |  |
|  | Heating                                  | m <sup>3</sup> /min (ft <sup>3</sup> /min) | 10.3×3/9.2×3/7.0 ×3*7 (364)×3/(325)×3/(247)×3 |             |                                     | -              |        |            | -      |            | -    |             | - |  |
| Outdoor Air flow   | Cooling                                  | m <sup>3</sup> /min (ft <sup>3</sup> /min) | -   |             |                                     | 130            |        |            | (4591) |            | -    |             | - |  |
|  | Heating                                  | m <sup>3</sup> /min (ft <sup>3</sup> /min) | -   |             |                                     | 110            |        |            | (3885) |            | -    |             | - |  |
| Refrigerant type / amount g(oz)                            |  | -  |   | -           |                                     | R410A          |        | 3.40k      |        | (119.9)    |      | -           |   |  |
| Product dimension  | Height                                   | mm(inch)                                   | 260<265 + 23> (10-1/4)                        |             |                                     | 1416 (55-3/4)  |        |            | -      |            | -    |             | - |  |
|  | Width                                    | mm(inch)                                   | 575<583> (22-21/32)                           |             |                                     | 940 (37-1/32)  |        |            | -      |            | -    |             | - |  |
|  | Depth                                    | mm(inch)                                   | 575<583> (22-21/32)                           |             |                                     | 340 (13-13/32) |        |            | -      |            | -    |             | - |  |
|  | Panel H×W×D mm                           | 31 × 700 × 700                             |   |             | *                                   |                |        | -          |        | -          |      | * CZ-KPY3AW |   |  |
| Packing dimension  | Height                                   | mm(inch)                                   | 345 (13-19/32)                                |             |                                     | 1556           |        |            | -      |            | -    |             | - |  |
|  | Width                                    | mm(inch)                                   | 691 (27-7/32)                                 |             |                                     | 1055           |        |            | -      |            | -    |             | - |  |
|  | Depth                                    | mm(inch)                                   | 691 (27-7/32)                                 |             |                                     | 485            |        |            | -      |            | -    |             | - |  |
| Weight   | (NET)                                    | kg(lb)                                     | 18 (40)                                       |             |                                     | 98 (216)       |        |            | -      |            | -    |             | - |  |
|  | (GROSS)                                  | kg(lb)                                     | 23 (51)                                       |             |                                     | 108 (238)      |        |            | -      |            | -    |             | - |  |
| Layers limit (actually)                                    |  | 11 (12)                                    |   | 1 (2)       |                                     | -              |        | -          |        | -          |      | -           |   |  |
| Operation condition  | Cool (DBT)                               | 18°C ~ 32°C                                |   |             | -15°C ~ 46°C                        |                |        | -          |        | -          |      | -           |   |  |
|  | Heat (DBT)                               | 16°C ~ 30°C                                |   |             | -20°C ~ 24°C                        |                |        | -          |        | -          |      | -           |   |  |
| P<br>I<br>P<br>I<br>N<br>G                                 | Pipe diameter mm (inch)                  | (Liquid)∅6.35(1/4) (Gas)∅12.7(1/2)         |   |             | (Liquid)∅9.52(3/8) (Gas)∅15.88(5/8) |                |        | -          |        | -          |      | -           |   |  |
|  | Connecting method, Standard length m(ft) | flared type, 5.0 (16.4)                    |   |             | flared type, 5.0 (16.4)             |                |        | -          |        | -          |      | -           |   |  |
| Pipe length range m (ft)                                   |  | 5 ~ 75 (16.4 ~ 246.1)                      |   |             | -                                   |                |        | -          |        | -          |      | -           |   |  |
| Indoor unit & Outdoor unit height difference m (ft)        |  | 15(OD located lower)/30(OD located higher) |   |             | (49.2/98.4)                         |                |        | -          |        | -          |      | -           |   |  |
| Add gas amount g/m (oz/ft)                                 |  | 50 (0.538)                                 |   |             | -                                   |                |        | -          |        | -          |      | -           |   |  |
| Pipe length for additional gas m (ft)                      |  | 20 (65.6)                                  |   |             | -                                   |                |        | -          |        | -          |      | -           |   |  |

\*1: In case it is necessary to indicate the air flow volume in (l/s), the value in (m<sup>3</sup>/min.) shall be multiplied by 16.7 and rounded down the decimal point.  
\*2: If the EUROVENT Certified models can be operated under the "extra-low" temperature condition, -7°C dry bulb and -8°C wet-bulb temperatures with rated voltage 230 V shall be used.  
\*3: Network Impedance shall be applicable for EUROPE and CHINA models.  
\*4: The annual consumption is calculated by multiplying the input power at 230V (400V) by an average of 500 hours per year in cooling mode.  
\*5: EER and COP classification is at 230V (400V) only in accordance with EU directive 2002/31/EC.  
\*6: SEER and SCOP classification is at 230V (400V) only in accordance with EN-14825. For heating, SCOP indicates the value of only Average heating season.  
\*7: Noise and air flow rate of L are indicated by the values at FAN mode. ( ): Normal operation Cooling/Heating noise value. Normal operation Cooling/Heating air flow rate are 7.6 (m<sup>3</sup>/min).

# Single -Type

## 1-1. Unit Specifications

**PE2**

### 6. 4-Way Cassette 60×60 Type S-50PY2E5A / U-50PE2E5A

| INDOOR   |  | MODEL                                      | S-50PY2E5A                             |  |                                    | -          |            |        | -           |        |
|--|--|--|--|--|------------------------------------|------------|------------|--------|-------------|--------|
| PANEL  |  | MODEL                                      | CZ-KPY3AW / CZ-KPY3BW                  |  |                                    | -          |            |        | -           |        |
| OUTDOOR  |  | MODEL                                      | -                                      |  |                                    | U-50PE2E5A |            |        | -           |        |
| Branch pipe  |  | MODEL                                      | -                                      |  |                                    | -          |            |        | -           |        |
| Performance test condition                               |  |  | ISO5151 / EN14511 / EN12102 / EN14825  |  |                                    |            |            |        |             |        |
| C<br>O<br>L<br>I<br>N<br>G                               | Power supply                             | Ø, Hz                                      | 1ø 50Hz                                |  |                                    | 1ø 50Hz    |            |        |             |        |
|  |  | V  | 220V                                   | 230V   | 240V                               | 220V       | 230v       | 240V   | Min         | Max    |
|  | Capacity                                 | kW   | 5.0                                    | 5.0  | 5.0                                | -          | -          | -      | 1.5         | 5.6    |
|  |  | BTU/h                                      | 17100                                  | 17100  | 17100                              | -          | -          | -      | 5100        | 19100  |
|  | Current                                  | A  | 0.35                                   | 0.35   | 0.35                               | 6.70       | 6.50       | 6.20   | -           | -      |
|  |  | W  | 45                                     | 45   | 45                                 | 1.395k     | 1.395k     | 1.395k | -           | -      |
|  | Input power                              | TOTAL W                                    | -                                      | -  | -                                  | 1.440k     | 1.440k     | 1.440k | 240         | 1.770k |
|  |  | Annual consumption                         | TOTAL kWh **                           | -  | -                                  | -          | -          | 720    | -           | -      |
|  | EER/EER CLASS                            | TOTAL (W/W) <sup>2</sup> / ("A"-G)         | -                                      | -  | -                                  | 3.47       | 3.47/A     | 3.47   | 6.25        | 3.16   |
|  | Erp<br>*6                                | Pdesign                                    | kW                                     | -  | -                                  | -          | -          | 5.0    | -           | -      |
| SEER   |  | (W/W)                                      | -                                      | -  | -                                  | -          | 6.1        | -      | -           |        |
| Annual consumption                                       |  | kWh  | -                                      | -  | -                                  | -          | 287        | -      | -           |        |
| Class  |  |  | -                                      | -  | -                                  | -          | A++        | -      | -           |        |
| Power factor   | %  | -  | -                                      | -  | 94                                 | 94         | 94         | -      | -           |        |
| Noise indoor   | dB-A (H/M/L)                             | 40/37/33                                   |  |  | -                                  |            |            | -      | -           |        |
|  | Power Level dB                           | 55/52/48                                   |  |  | -                                  |            |            | -      | -           |        |
| Noise outdoor  | dB-A (H/L)                               | -  |  |  | 46/-                               |            |            | -      | -           |        |
|  | Power Level dB                           | -  |  |  | 65/-                               |            |            | -      | -           |        |
| H<br>E<br>A<br>T<br>I<br>N<br>G                          | Capacity                                 | kW   | 5.6                                    | 5.6  | 5.6                                | -          | -          | -      | 1.5         | 6.5    |
|  |  | BTU/h                                      | 19100                                  | 19100  | 19100                              | -          | -          | -      | 5100        | 22200  |
|  | Current                                  | A  | 0.35                                   |  |                                    | 8.05       | 7.70       | 7.40   | -           | -      |
|  |  | W  | 40                                     |  |                                    | 1.650k     | 1.650k     | 1.650k | -           | -      |
|  | Input power                              | TOTAL W                                    | -                                      | -  | -                                  | 1.690k     | 1.690k     | 1.690k | 190         | 2.170k |
|  |  | COP/COP CLASS                              | TOTAL (W/W) <sup>2</sup> / ("A"-G)     | -  | -                                  | -          | 3.31       | 3.31/C | 3.31        | 7.89   |
|  | Erp<br>*6                                | Pdesign at -10°C                           | kW                                     | -  | -                                  | -          | -          | 5.0    | -           | -      |
|  |  | Tbivalent                                  | °C                                     | -  | -                                  | -          | -          | -7     | -           | -      |
|  |  | SCOP                                       | (W/W)                                  | -  | -                                  | -          | -          | 3.9    | -           | -      |
|  |  | Annual consumption                         | kWh                                    | -  | -                                  | -          | -          | 1795   | -           | -      |
| Class  |  | -  | -                                      | -  | -                                  | A          | -          | -      |             |        |
| Power factor   | %  | -  | -                                      | -  | 93                                 | 93         | 93         | -      | -           |        |
| Noise indoor   | dB-A (H/M/L)                             | 40/37/33                                   |  |  | -                                  |            |            | -      | -           |        |
|  | Power Level dB                           | 55/52/48                                   |  |  | -                                  |            |            | -      | -           |        |
| Noise outdoor  | dB-A (H/L)                               | -  |  |  | 48/-                               |            |            | -      | -           |        |
|  | Power Level dB                           | -  |  |  | 68/-                               |            |            | -      | -           |        |
| EXTRA LOW TEMP Total capacity(kW) / Input power(W) / COP |  | -  |  |  |                                    |            |            |        |             |        |
| Max Current(A) / Max Input power(W)                      |  | 0.40/55                                    | 0.40/55                                | 0.40/55  | 12.0/2.46k                         | 12.0/2.57k | 12.0/2.68k | -      |             |        |
| Starting current(A) / Comp output(W)                     |  | -  | -                                      | -  | 8.05/1.5k                          | 7.70/1.5k  | 7.40/1.5k  | -      |             |        |
| Network Impedance(ΩMAX.)                                 |  | -  |  |  |                                    |            |            |        |             |        |
| Fan motor output (Indoor/Outdoor) W                      |  | 40   |  |  | 60                                 |            |            | -      |             |        |
| Moisture removal volume                                  |  | L/h(Pt/h)                                  | 2.8                                    | (5.9)  | -                                  |            |            | -      |             |        |
| Indoor Air flow  | Cooling                                  | m <sup>3</sup> /min (ft <sup>3</sup> /min) | 11.1 / 9.8 / 8.5 (392) / (346) / (300) |  |                                    | -          |            |        | -           | -      |
|  | Heating                                  | m <sup>3</sup> /min (ft <sup>3</sup> /min) | 11.1 / 9.8 / 8.7 (392) / (346) / (307) |  |                                    | -          |            |        | -           | -      |
| Outdoor Air flow   | Cooling                                  | m <sup>3</sup> /min (ft <sup>3</sup> /min) | -                                      |  |                                    | 38 (1342)  |            |        | -           | -      |
|  | Heating                                  | m <sup>3</sup> /min (ft <sup>3</sup> /min) | -                                      |  |                                    | 41 (1448)  |            |        | -           | -      |
| Refrigerant type / amount g(oz)                          |  | -  |  |  | R410A                              | 1.40k      | (49.4)     | -      |             |        |
| Product dimension  | Height                                   | mm(inch)                                   | 260<265 + 23>                          |  | (10-1/4)                           | 619        | (24-3/8)   | -      |             |        |
|  | Width                                    | mm(inch)                                   | 575<583>                               |  | (22-21/32)                         | 799        | (31-29/64) | -      |             |        |
|  | Depth                                    | mm(inch)                                   | 575<583>                               |  | (22-21/32)                         | 299        | (11-49/64) | -      |             |        |
|  | Panel H×W×D                              | mm   | 31 × 700 × 700 *                       |  |                                    | -          |            |        | * CZ-KPY3AW |        |
| Packing dimension  | Height                                   | mm(inch)                                   | 345                                    |  | (13-19/32)                         | 688        |            |        | -           |        |
|  | Width                                    | mm(inch)                                   | 691                                    |  | (27-7/32)                          | 931        |            |        | -           |        |
|  | Depth                                    | mm(inch)                                   | 691                                    |  | (27-7/32)                          | 422        |            |        | -           |        |
| Weight   | (NET)                                    | kg(lb)                                     | 18                                     |  | (40)                               | 39 (86)    |            | -      |             |        |
|  | (GROSS)                                  | kg(lb)                                     | 23                                     |  | (51)                               | 44 (97)    |            | -      |             |        |
|  | Panel (NET)                              | kg(lb)                                     | 2.4                                    |  | (5.3)                              | -          |            |        | -           |        |
| Layers limit (actually)                                  |  | 11(12)                                     |  |  | 5(6)                               |            |            | -      |             |        |
| Operation condition                                      | Cool (DBT)                               | 18°C ~ 32°C                                |  |  | -15°C ~ 46°C                       |            |            | -      |             |        |
|  | Heat (DBT)                               | 16°C ~ 30°C                                |  |  | -20°C ~ 24°C                       |            |            | -      |             |        |
| P<br>I<br>P<br>I<br>N<br>G                               | Pipe diameter mm (inch)                  | (Liquid)ø6.35(1/4) (Gas)ø12.7(1/2)         |  |  | (Liquid)ø6.35(1/4) (Gas)ø12.7(1/2) |            |            | -      |             |        |
|  | Connecting method, Standard length m(ft) | flared type, 5.0 (16.4)                    |  |  | flared type, 5.0 (16.4)            |            |            | -      |             |        |
| Pipe length range  |  | m (ft)                                     |  | 3 ~ 40m (9.8 ~ 131.2)                                      |                                    |            |            |        |             |        |
| Indoor unit & Outdoor unit height difference             |  | m (ft)                                     |  | 15m (OD located lower)/30m (OD located higher) (49.2/98.4) |                                    |            |            |        |             |        |
| Add gas amount   |  | g/m (oz/ft)                                |  | 20g (0.215)  |                                    |            |            |        |             |        |
| Pipe length for additional gas                           |  | m (ft)                                     |  | 30m (98.4)   |                                    |            |            |        |             |        |

\*1: In case it is necessary to indicate the air flow volume in (l/s), the value in (m<sup>3</sup>/min.) shall be multiplied by 16.7 and rounded down the decimal point.

\*2: If the EUROVENT Certified models can be operated under the "extra-low" temperature condition, -7°C dry bulb and -8°C wet-bulb temperatures with rated voltage 230V shall be used.

\*3: Network Impedance shall be applicable for EUROPE and CHINA models.

\*4: The annual consumption is calculated by multiplying the input power at 230V (400V) by an average of 500 hours per year in cooling mode.

\*5: EER and COP classification is at 230V (400V) only in accordance with EU directive 2002/31/EC.

\*6: SEER and SCOP classification is at 230V (400V) only in accordance with EN-14825. For heating, SCOP indicates the value of only Average heating season, Other fiche data indicates in an attached sheet.

# Simultaneous (Twin) -Type

## 1-1. Unit Specifications

PE1

### 6. 4-Way Cassette 60x60 Type S-50PY2E5A×2 / U-100PE1E5A

|  |   |  |  |             |                                     |                |            |        |             |        |
|--|---|--|--|-------------|-------------------------------------|----------------|------------|--------|-------------|--------|
| INDOOR   |   | MODEL                                      | S-50PY2E5A ×2                              |             |                                     | -              |            |        | -           |        |
| PANEL  |   | MODEL                                      | (CZ-KPY3AW / CZ-KPY3BW) ×2                 |             |                                     | -              |            |        | -           |        |
| OUTDOOR  |   | MODEL                                      | -  |             |                                     | U-100PE1E5A    |            |        | -           |        |
| Branch pipe  |   | MODEL                                      | -  |             |                                     | CZ-P155BK1     |            |        | -           |        |
| Performance test condition                                 |   | ISO5151 / EN14511 / EN14825 / EN12102      |  |             |                                     |                |            |        |             |        |
| Power supply   |   | Ø, Hz                                      | 1ø 50Hz                                    |             |                                     | 1ø 50Hz        |            |        |             |        |
|  |   | V  | 220  | 230         | 240                                 | 220            | 230        | 240    | Min         | Max    |
| C<br>O<br>O<br>L<br>I<br>N<br>G                            | Capacity  | kW   | 10.0                                       | 10.0        | 10.0                                | -              | -          | -      | 3.3         | 12.5   |
|  |   | BTU/h                                      | 34100                                      | 34100       | 34100                               | -              | -          | -      | 11300       | 42700  |
|  | Current   | A  | 0.35 × 2                                   |             |                                     | 12.2           | 11.8       | 11.3   | -           | -      |
|  |   | W  | 45 × 2                                     |             |                                     | 2.560k         | 2.560k     | 2.560k | -           | -      |
|  | Input power   | TOTAL W                                    | -  |             |                                     | 2.650k         | 2.650k     | 2.650k | 840         | 3.700k |
|  |   | Annual consumption                         | TOTAL kWh **                               | -           | -                                   | -              | -          | 1325   | -           | -      |
|  | EER/EER CLASS                                       | TOTAL (W/W) <sup>†3</sup> ("A"-G)          | -  | -           | -                                   | 3.77           | 3.77/A     | 3.77   | 3.93        | 3.38   |
|  | Erp<br>*6   | Pdesign                                    | kW   | -           | -                                   | -              | -          | 10.0   | -           | -      |
|  |   | SEER                                       | (W/W)                                      | -           | -                                   | -              | -          | 6.5    | -           | -      |
|  |   | Annual consumption                         | kWh  | -           | -                                   | -              | -          | 538    | -           | -      |
| Class  |   |  | -  | -           | -                                   | -              | A++        | -      | -           |        |
| Power factor   | %   | -  | -  | -           | 95                                  | 94             | 94         | -      | -           |        |
| Noise indoor   | dB-A (H/M/L)  | 40/37/33                                   |  |             | -                                   |                |            | -      | -           |        |
|  | Power Level dB                                      | 55/52/48                                   |  |             | -                                   |                |            | -      | -           |        |
| Noise outdoor  | dB-A (H/L)  | -  |  |             | 52/-                                |                |            | -      | -           |        |
|  | Power Level dB                                      | -  |  |             | 69/-                                |                |            | -      | -           |        |
| H<br>E<br>A<br>T<br>I<br>N<br>G                            | Capacity  | kW   | 11.2                                       | 11.2        | 11.2                                | -              | -          | -      | 4.1         | 14.0   |
|  |   | BTU/h                                      | 38200                                      | 38200       | 38200                               | -              | -          | -      | 14000       | 47800  |
|  | Current   | A  | 0.35 × 2                                   |             |                                     | 13.4           | 13.0       | 12.6   | -           | -      |
|  |   | W  | 40 × 2                                     |             |                                     | 2.825k         | 2.825k     | 2.825k | -           | -      |
|  | Input power   | TOTAL W                                    | -  |             |                                     | 2.910k         | 2.910k     | 2.910k | 900         | 4.400k |
|  |   | COP/COP CLASS                              | TOTAL (W/W) <sup>†3</sup> ("A"-G)          | -           | -                                   | -              | 3.85       | 3.85/A | 3.85        | 4.56   |
|  | Erp<br>*6   | Pdesign at -10°C                           | kW   | -           | -                                   | -              | -          | 9.5    | -           | -      |
|  |   | Tbivalent                                  | °C   | -           | -                                   | -              | -          | -10    | -           | -      |
|  |   | SCOP                                       | (W/W)                                      | -           | -                                   | -              | -          | 3.8    | -           | -      |
|  |   | Annual consumption                         | kWh  | -           | -                                   | -              | -          | 3500   | -           | -      |
| Class  |   | -  | -  | -           | -                                   | A              | -          | -      |             |        |
| Power factor   | %   | -  | -  | -           | 96                                  | 94             | 93         | -      | -           |        |
| Noise indoor   | dB-A (H/M/L)  | 40/37/33                                   |  |             | -                                   |                |            | -      | -           |        |
|  | Power Level dB                                      | 55/52/48                                   |  |             | -                                   |                |            | -      | -           |        |
| Noise outdoor  | dB-A (H/L)  | -  |  |             | 52/-                                |                |            | -      | -           |        |
|  | Power Level dB                                      | -  |  |             | 69/-                                |                |            | -      | -           |        |
| EXTRA LOW TEMP   Total capacity(kW) / Input power(W) / COP |   | -  |  |             |                                     |                |            |        |             |        |
| Max Current(A) / Max Input power(W)                        |   | 0.40/55 × 2                                | 0.40/55 × 2                                | 0.40/55 × 2 | 25.0/5.35k                          | 25.0/5.55k     | 25.0/5.75k | -      |             |        |
| Starting current(A) / Comp output(W)                       |   | -  | -  | -           | 13.4/3.0k                           | 13.0/3.0k      | 12.6/3.0k  | -      |             |        |
| Network Impedance(QMAX.)                                   |   | -  |  |             | -                                   |                |            | -      |             |        |
| Fan motor output (Indoor/Outdoor) W                        |   | 40 × 2                                     |  |             | 90 × 2                              |                |            | -      |             |        |
| Moisture removal volume                                    |   | L/h (PT/h)                                 | 6.0  | (3.0×2)     | (12.6)                              | -              |            |        | -           |        |
| Indoor Air flow  | Cooling   | m³/min (ft³/min)                           | 11.1×2/9.8×2/8.5×2 (392)×2/(346)×2/(300)×2 |             |                                     | -              |            |        | -           |        |
|  | Heating   | m³/min (ft³/min)                           | 11.1×2/9.8×2/8.7×2 (392)×2/(346)×2/(307)×2 |             |                                     | -              |            |        | -           |        |
| Outdoor Air flow   | Cooling   | m³/min (ft³/min)                           | -  |             |                                     | 110 (3885)     |            |        | -           |        |
|  | Heating   | m³/min (ft³/min)                           | -  |             |                                     | 95 (3355)      |            |        | -           |        |
| Refrigerant type / amount g(oz)                            |   | -  |  |             | R410A                               | 3.40k          | (119.9)    | -      |             |        |
| Product dimension  | Height  | mm(inch)                                   | 260<265 + 23> (10-1/4)                     |             |                                     | 1416 (55-3/4)  |            |        | -           |        |
|  | Width   | mm(inch)                                   | 575<583> (22-21/32)                        |             |                                     | 940 (37-1/32)  |            |        | -           |        |
|  | Depth   | mm(inch)                                   | 575<583> (22-21/32)                        |             |                                     | 340 (13-13/32) |            |        | -           |        |
|  | Panel H×W×D mm                                      |  | 31 × 700 × 700 *                           |             |                                     | -              |            |        | * CZ-KPY3AW |        |
| Packing dimension  | Height  | mm(inch)                                   | 345 (13-19/32)                             |             |                                     | 1556           |            |        | -           |        |
|  | Width   | mm(inch)                                   | 691 (27-7/32)                              |             |                                     | 1055           |            |        | -           |        |
|  | Depth   | mm(inch)                                   | 691 (27-7/32)                              |             |                                     | 485            |            |        | -           |        |
| Weight   | (NET)   | kg(lb)                                     | 18 (40)                                    |             |                                     | 98 (216)       |            |        | -           |        |
|  | (GROSS)   | kg(lb)                                     | 23 (51)                                    |             |                                     | 108 (238)      |            |        | -           |        |
| Layers limit (actually)                                    |   | 11 (12)                                    |  |             | 1 (2)                               |                |            | -      |             |        |
| Operation condition  | Cool (DBT)  | 18°C ~ 32°C                                |  |             | -15°C ~ 46°C                        |                |            | -      |             |        |
|  | Heat (DBT)  | 16°C ~ 30°C                                |  |             | -20°C ~ 24°C                        |                |            | -      |             |        |
| P<br>I<br>P<br>E   | Pipe diameter mm (inch)                             | (Liquid)ø6.35(1/4) (Gas)ø12.7(1/2)         |  |             | (Liquid)ø9.52(3/8) (Gas)ø15.88(5/8) |                |            | -      |             |        |
|  | Connecting method, Standard length m(ft)            | flared type, 5.0 (16.4)                    |  |             | flared type, 5.0 (16.4)             |                |            | -      |             |        |
| I<br>N<br>G  | Pipe length range m (ft)                            | 5 ~ 75 (16.4 ~ 246.1)                      |  |             | -                                   |                |            | -      |             |        |
|  | Indoor unit & Outdoor unit height difference m (ft) | 15(OD located lower)/30(OD located higher) |  |             | (49.2/98.4)                         |                |            | -      |             |        |
| Add gas amount g/m (oz/ft)                                 |   | 50 (0.538)                                 |  |             | -                                   |                |            | -      |             |        |
| Pipe length for additional gas m (ft)                      |   | 30 (98.4)                                  |  |             | -                                   |                |            | -      |             |        |

\*1: In case it is necessary to indicate the air flow volume in (l/s), the value in (m³/min.) shall be multiplied by 16.7 and rounded down the decimal point.  
 \*2: If the EUROVENT Certified models can be operated under the "extra-low" temperature condition, -7°C dry bulb and -8°C wet-bulb temperatures with rated voltage 230V shall be used.  
 \*3: Network Impedance shall be applicable for EUROPE and CHINA models.  
 \*4: The annual consumption is calculated by multiplying the input power at 230V(400V) by an average of 500 hours per year in cooling mode.  
 \*5: EER and COP classification is at 230V(400V) only in accordance with EU directive 2002/31/EC.  
 \*6: SEER and SCOP classification is at 230V(400V) only in accordance with EN-14825. For heating, SCOP indicates the value of only Average heating season, Other fiche data indicates in an attached sheet.

# Simultaneous (Triple) -Type

## 1-1. Unit Specifications

**PE1**

### 6. 4-Way Cassette 60×60 Type S-50PY2E5A×3 / U-140PE1E5A

| INDOOR   |  | MODEL                                      | S-50PY2E5A ×3                              |             |                                     | -              |            |        | -           |        |
|--|--|--|--|-------------|-------------------------------------|----------------|------------|--------|-------------|--------|
| PANEL  |  | MODEL                                      | (CZ-KPY3AW / CZ-KPY3BW) ×3                 |             |                                     | -              |            |        | -           |        |
| OUTDOOR  |  | MODEL                                      | -  |             |                                     | U-140PE1E5A    |            |        | -           |        |
| Branch pipe  |  | MODEL                                      | -  |             |                                     | CZ-P3HPC2      |            |        | -           |        |
| Performance test condition                                 |  | ISO5151 / EN14511 / EN14825 / EN12102      |  |             |                                     |                |            |        |             |        |
| C<br>O<br>L<br>I<br>N<br>G                                 | Power supply                             | Ø, Hz                                      | 1ø 50Hz                                    |             |                                     | 1ø 50Hz        |            |        |             |        |
|  |  | V  | 220  | 230         | 240                                 | 220            | 230        | 240    | Min         | Max    |
|  | Capacity                                 | kW   | 14.0                                       | 14.0        | 14.0                                | -              | -          | -      | 3.3         | 15.5   |
|  |  | BTU/h                                      | 47800                                      | 47800       | 47800                               | -              | -          | -      | 11300       | 52900  |
|  | Current                                  | A  | 0.35 × 3                                   |             |                                     | 21.5           | 20.8       | 20.1   | -           | -      |
|  |  | W  | 45 × 3                                     |             |                                     | 4.565k         | 4.565k     | 4.565k | -           | -      |
|  | Input power                              | TOTAL W                                    | -  |             |                                     | 4.700k         | 4.700k     | 4.700k | 840         | 6.000k |
|  |  | Annual consumption                         | TOTAL kWh **                               | -           | -                                   | -              | -          | 2350   | -           | -      |
|  | EER/EER CLASS                            | TOTAL (W/W) <sup>23</sup> / ("A"-G)        | -  | -           | -                                   | 2.98           | 2.98/C     | 2.98   | 3.93        | 2.58   |
|  | Erp<br>*6                                | Pdesign                                    | kW   | -           | -                                   | -              | -          | 14.0   | -           | -      |
| η <sub>s.c</sub>   |  | %  | -  | -           | -                                   | -              | 203.1      | -      | -           |        |
| Annual consumption   |  | kWh  | -  | -           | -                                   | -              | -          | -      | -           |        |
| Class  |  |  | -  | -           | -                                   | -              | -          | -      | -           |        |
| Power factor   | %  | -  | -  | -           | 97                                  | 95             | 95         | -      | -           |        |
| Noise indoor   | dB-A (H/M/L)                             | 40/37/33                                   |  |             | -                                   |                |            | -      | -           |        |
|  | Power Level dB                           | 55/52/48                                   |  |             | -                                   |                |            | -      | -           |        |
| Noise outdoor  | dB-A (H/L)                               | -  |  |             | 54/-                                |                |            | -      | -           |        |
|  | Power Level dB                           | -  |  |             | 71/-                                |                |            | -      | -           |        |
| H<br>E<br>A<br>T<br>I<br>N<br>G                            | Capacity                                 | kW   | 16.0                                       | 16.0        | 16.0                                | -              | -          | -      | 4.1         | 18.0   |
|  |  | BTU/h                                      | 54600                                      | 54600       | 54600                               | -              | -          | -      | 14000       | 61400  |
|  | Current                                  | A  | 0.35 × 3                                   |             |                                     | 22.2           | 21.4       | 20.8   | -           | -      |
|  |  | W  | 40 × 3                                     |             |                                     | 4.700k         | 4.700k     | 4.700k | -           | -      |
|  | Input power                              | TOTAL W                                    | -  |             |                                     | 4.820k         | 4.820k     | 4.820k | 900         | 5.900k |
|  |  | COP/COP CLASS                              | TOTAL (W/W) <sup>23</sup> / ("A"-G)        | -           | -                                   | -              | 3.32       | 3.32/C | 3.32        | 4.56   |
|  | Erp<br>*6                                | Pdesign at -10°C                           | kW   | -           | -                                   | -              | -          | 14.0   | -           | -      |
|  |  | Tbivalent                                  | °C   | -           | -                                   | -              | -          | -7     | -           | -      |
|  |  | η <sub>s.h</sub>                           | %  | -           | -                                   | -              | -          | 139.2  | -           | -      |
|  |  | Annual consumption                         | kWh  | -           | -                                   | -              | -          | -      | -           | -      |
| Class  |  | -  | -  | -           | -                                   | -              | -          | -      |             |        |
| Power factor   | %  | -  | -  | -           | 96                                  | 95             | 94         | -      | -           |        |
| Noise indoor   | dB-A (H/M/L)                             | 40/37/33                                   |  |             | -                                   |                |            | -      | -           |        |
|  | Power Level dB                           | 55/52/48                                   |  |             | -                                   |                |            | -      | -           |        |
| Noise outdoor  | dB-A (H/L)                               | -  |  |             | 55/-                                |                |            | -      | -           |        |
|  | Power Level dB                           | -  |  |             | 71/-                                |                |            | -      | -           |        |
| EXTRA LOW TEMP   Total capacity(kW) / Input power(W) / COP |  | -  |  |             |                                     |                |            |        |             |        |
| Max Current(A) / Max Input power(W)                        |  | 0.40/55 × 3                                | 0.40/55 × 3                                | 0.40/55 × 3 | 30.0/6.45k                          | 30.0/6.65k     | 30.0/6.85k | -      |             |        |
| Starting current(A) / Comp output(W)                       |  | -  | -  | -           | 22.2/3.0k                           | 21.4/3.0k      | 20.8/3.0k  | -      |             |        |
| Network Impedance(ΩMAX.)                                   |  | -  |  |             |                                     |                |            |        |             |        |
| Fan motor output (Indoor/Outdoor) W                        |  | 40 × 3                                     |  |             | 90 × 2                              |                |            | -      |             |        |
| Moisture removal volume   L/h(Pt/h)                        |  | 9.0  | (3.0×3)                                    | (18.9)      | -                                   |                |            | -      |             |        |
| Indoor Air flow  | Cooling                                  | m <sup>3</sup> /min (ft <sup>3</sup> /min) | 11.1×3/9.8×3/8.5×3 (392)×3/(346)×3/(300)×3 |             |                                     | -              |            |        | -           | -      |
|  | Heating                                  | m <sup>3</sup> /min (ft <sup>3</sup> /min) | 11.1×3/9.8×3/8.7×3 (392)×3/(346)×3/(307)×3 |             |                                     | -              |            |        | -           | -      |
| Outdoor Air flow   | Cooling                                  | m <sup>3</sup> /min (ft <sup>3</sup> /min) | -  |             |                                     | 135            | (4767)     | -      | -           |        |
|  | Heating                                  | m <sup>3</sup> /min (ft <sup>3</sup> /min) | -  |             |                                     | 120            | (4238)     | -      | -           |        |
| Refrigerant type / amount g(oz)                            |  | -  |  |             | R410A                               | 3.40k          | (119.9)    | -      |             |        |
| Product dimension  | Height                                   | mm(inch)                                   | 260<265 + 23> (10-1/4)                     |             |                                     | 1416 (55-3/4)  |            |        | -           |        |
|  | Width                                    | mm(inch)                                   | 575<583> (22-21/32)                        |             |                                     | 940 (37-1/32)  |            |        | -           |        |
|  | Depth                                    | mm(inch)                                   | 575<583> (22-21/32)                        |             |                                     | 340 (13-13/32) |            |        | -           |        |
|  | Panel H×W×D                              | mm   | 31 × 700 × 700 *                           |             |                                     | -              |            |        | * CZ-KPY3AW |        |
| Packing dimension  | Height                                   | mm(inch)                                   | 345 (13-19/32)                             |             |                                     | 1556           |            |        | -           |        |
|  | Width                                    | mm(inch)                                   | 691 (27-7/32)                              |             |                                     | 1055           |            |        | -           |        |
|  | Depth                                    | mm(inch)                                   | 691 (27-7/32)                              |             |                                     | 485            |            |        | -           |        |
| Weight   | (NET)                                    | kg(lb)                                     | 18 (40)                                    |             |                                     | 98 (216)       |            |        | -           |        |
|  | (GROSS)                                  | kg(lb)                                     | 23 (51)                                    |             |                                     | 108 (238)      |            |        | -           |        |
| Layers limit (actually)                                    |  | 11 (12)                                    |  |             | 1 (2)                               |                |            | -      |             |        |
| Operation condition  | Cool (DBT)                               | 18°C ~ 32°C                                |  |             | -15°C ~ 46°C                        |                |            | -      |             |        |
|  | Heat (DBT)                               | 16°C ~ 30°C                                |  |             | -20°C ~ 24°C                        |                |            | -      |             |        |
| P<br>I<br>P<br>I<br>N<br>G                                 | Pipe diameter mm (inch)                  | (Liquid)ø6.35(1/4) (Gas)ø12.7(1/2)         |  |             | (Liquid)ø9.52(3/8) (Gas)ø15.88(5/8) |                |            | -      |             |        |
|  | Connecting method, Standard length m(ft) | flared type, 5.0 (16.4)                    |  |             | flared type, 5.0 (16.4)             |                |            | -      |             |        |
| Pipe length range m (ft)                                   |  | 5 ~ 75 (16.4 ~ 246.1)                      |  |             |                                     |                |            |        |             |        |
| Indoor unit & Outdoor unit height difference m (ft)        |  | 15(OD located lower)/30(OD located higher) |  |             | (49.2/98.4)                         |                |            | -      |             |        |
| Add gas amount g/m (oz/ft)                                 |  | 50 (0.538)                                 |  |             |                                     |                |            |        |             |        |
| Pipe length for additional gas m (ft)                      |  | 20 (65.6)                                  |  |             |                                     |                |            |        |             |        |

\*1: In case it is necessary to indicate the air flow volume in (l/s), the value in (m<sup>3</sup>/min.) shall be multiplied by 16.7 and rounded down the decimal point.

\*2: If the EUROVENT Certified models can be operated under the "extra-low" temperature condition, -7°C dry bulb and -8°C wet-bulb temperatures with rated voltage 230V shall be used.

\*3: Network Impedance shall be applicable for EUROPE and CHINA models.

\*4: The annual consumption is calculated by multiplying the input power at 230V(400V) by an average of 500 hours per year in cooling mode.

\*5: EER and COP classification is at 230V(400V) only in accordance with EU directive 2002/31/EC.

\*6: SEER and SCOP classification is at 230V(400V) only in accordance with EN-14825. For heating, SCOP indicates the value of only Average heating season.



# Simultaneous (Twin) -Type

## 1-1. Unit Specifications

PE1

### 6. 4-Way Cassette 60x60 Type S-36PY2E5A×2 / U-71PE1E8A

|  |  |  |   |             |                                     |                |           |        |             |        |
|--|--|--|---|-------------|-------------------------------------|----------------|-----------|--------|-------------|--------|
| INDOOR   |  | MODEL                                      | S-36PY2E5A ×2                               |             |                                     | -              |           |        | -           |        |
| PANEL  |  | MODEL                                      | (CZ-KPY3AW / CZ-KPY3BW) ×2                  |             |                                     | -              |           |        | -           |        |
| OUTDOOR  |  | MODEL                                      | -   |             |                                     | U-71PE1E8A     |           |        | -           |        |
| Branch pipe  |  | MODEL                                      | CZ-P155BK1                                  |             |                                     |                |           |        |             |        |
| Performance test condition                               |  | ISO5151 / EN14511 / EN14825 / EN12102      |   |             |                                     |                |           |        |             |        |
| Power supply   |  | ∅, Hz                                      | 1∅ 50Hz                                     |             |                                     | 1∅ 50Hz        |           |        |             |        |
|  |  | V  | 220   | 230         | 240                                 | 380            | 400       | 415    | Min         | Max    |
| C<br>O<br>O<br>L<br>I<br>N<br>G                          | Capacity                                 | kW   | 7.1   | 7.1         | 7.1                                 | -              | -         | -      | 3.2         | 8.0    |
|  |  | BTU/h                                      | 24200                                       | 24200       | 24200                               | -              | -         | -      | 10900       | 27300  |
|  | Current                                  | A  | 0.30 × 2                                    |             |                                     | 3.20           | 3.10      | 3.00   | -           | -      |
|  |  | W  | 40 × 2                                      |             |                                     | 1.985k         | 1.985k    | 1.985k | -           | -      |
|  | Input power                              | TOTAL W                                    | -   |             |                                     | 2.065k         | 2.065k    | 2.065k | 560         | 2.650k |
|  |  | Annual consumption                         | TOTAL kWh **                                | -           | -                                   | -              | -         | 1032.5 | -           | -      |
|  | EER/EER CLASS                            | TOTAL (W/W) <sup>5)</sup> ("A"-G)          | -   | -           | -                                   | 3.44           | 3.44/A    | 3.44   | 5.71        | 3.02   |
|  | E <sub>sp</sub> <sup>6)</sup>            | Pdesign                                    | kW  | -           | -                                   | -              | -         | 7.1    | -           | -      |
|  |  | SEER                                       | (W/W)                                       | -           | -                                   | -              | -         | 5.8    | -           | -      |
|  |  | Annual consumption                         | kWh   | -           | -                                   | -              | -         | 428    | -           | -      |
| Class  |  |  | -   | -           | -                                   | -              | A+        | -      | -           |        |
| Power factor   | %  | -  | -   | -           | 94                                  | 92             | 92        | -      | -           |        |
| Noise indoor   | dB-A (H/M/L)                             | 36/32/26(31)*7                             |   |             | -                                   |                |           | -      | -           |        |
|  | Power Level dB                           | 51/47/41(46)*7                             |   |             | -                                   |                |           | -      | -           |        |
| Noise outdoor  | dB-A (H/L)                               | -  |   |             | 48/-                                |                |           | -      | -           |        |
|  | Power Level dB                           | -  |   |             | 65/-                                |                |           | -      | -           |        |
| H<br>E<br>A<br>T<br>I<br>N<br>G                          | Capacity                                 | kW   | 8.0   | 8.0         | 8.0                                 | -              | -         | -      | 2.8         | 9.0    |
|  |  | BTU/h                                      | 27300                                       | 27300       | 27300                               | -              | -         | -      | 9600        | 30700  |
|  | Current                                  | A  | 0.30 × 2                                    |             |                                     | 3.35           | 3.25      | 3.15   | -           | -      |
|  |  | W  | 35 × 2                                      |             |                                     | 2.080k         | 2.080k    | 2.080k | -           | -      |
|  | Input power                              | TOTAL W                                    | -   |             |                                     | 2.150k         | 2.150k    | 2.150k | 500         | 2.900k |
|  |  | COP/COP CLASS                              | TOTAL (W/W) <sup>5)</sup> ("A"-G)           | -           | -                                   | -              | 3.72      | 3.72/A | 3.72        | 5.60   |
|  | E <sub>sp</sub> <sup>6)</sup>            | Pdesign at -10°C                           | kW  | -           | -                                   | -              | -         | 7.1    | -           | -      |
|  |  | Tbivalent                                  | °C  | -           | -                                   | -              | -         | -7     | -           | -      |
|  |  | SCOP                                       | (W/W)                                       | -           | -                                   | -              | -         | 3.8    | -           | -      |
|  |  | Annual consumption                         | kWh   | -           | -                                   | -              | -         | 2616   | -           | -      |
| Class  |  | -  | -   | -           | -                                   | A              | -         | -      |             |        |
| Power factor   | %  | -  | -   | -           | 94                                  | 92             | 92        | -      | -           |        |
| Noise indoor   | dB-A (H/M/L)                             | 36/32/26(31)*7                             |   |             | -                                   |                |           | -      | -           |        |
|  | Power Level dB                           | 51/47/41(46)*7                             |   |             | -                                   |                |           | -      | -           |        |
| Noise outdoor  | dB-A (H/L)                               | -  |   |             | 50/-                                |                |           | -      | -           |        |
|  | Power Level dB                           | -  |   |             | 67/-                                |                |           | -      | -           |        |
| EXTRA LOW TEMP Total capacity(kW) / Input power(W) / COP |  | -  |   |             |                                     |                |           |        |             |        |
| Max Current(A) / Max Input power(W)                      |  | 0.35/50 × 2                                | 0.35/50 × 2                                 | 0.35/50 × 2 | 7.0/4.15k                           | 7.0/4.36k      | 7.0/4.53k | -      |             |        |
| Starting current(A) / Comp output(W)                     |  | -  | -   | -           | 3.35/2.0k                           | 3.25/2.0k      | 3.15/2.0k | -      |             |        |
| Network Impedance(QMAX.)                                 |  | -  |   |             |                                     |                |           |        |             |        |
| Fan motor output (Indoor/Outdoor) W                      |  | 40 × 2                                     |   |             | 90                                  |                |           | -      |             |        |
| Moisture removal volume                                  |  | L/h (P/h)                                  | 4.2   | (2.1×2)     | (8.8)                               | -              |           |        |             |        |
| Indoor Air flow  | Cooling                                  | m <sup>3</sup> /min (ft <sup>3</sup> /min) | 9.7×2/8.0×2/6.0×2*7 (343)×2/(283)×2/(212)×2 |             |                                     | -              |           |        | -           | -      |
|  | Heating                                  | m <sup>3</sup> /min (ft <sup>3</sup> /min) | 9.9×2/8.2×2/6.0×2*7 (350)×2/(290)×2/(212)×2 |             |                                     | -              |           |        | -           | -      |
| Outdoor Air flow   | Cooling                                  | m <sup>3</sup> /min (ft <sup>3</sup> /min) | -   |             |                                     | 60 (2119)      |           |        | -           | -      |
|  | Heating                                  | m <sup>3</sup> /min (ft <sup>3</sup> /min) | -   |             |                                     | 60 (2119)      |           |        | -           | -      |
| Refrigerant type / amount g(oz)                          |  | -  |   |             | R410A                               | 2.35k          | (82.9)    | -      |             |        |
| Product dimension  | Height                                   | mm(inch)                                   | 260<265 + 23> (10-1/4)                      |             |                                     | 996 (39-7/32)  |           |        | -           |        |
|  | Width                                    | mm(inch)                                   | 575<583> (22-21/32)                         |             |                                     | 940 (37-1/32)  |           |        | -           |        |
|  | Depth                                    | mm(inch)                                   | 575<583> (22-21/32)                         |             |                                     | 340 (13-13/32) |           |        | -           |        |
|  | Panel H×W×D mm                           |  | 31 × 700 × 700 *                            |             |                                     | -              |           |        | * CZ-KPY3AW |        |
| Packing dimension  | Height                                   | mm(inch)                                   | 345 (13-19/32)                              |             |                                     | 1136           |           |        | -           |        |
|  | Width                                    | mm(inch)                                   | 691 (27-7/32)                               |             |                                     | 1055           |           |        | -           |        |
|  | Depth                                    | mm(inch)                                   | 691 (27-7/32)                               |             |                                     | 485            |           |        | -           |        |
| Weight   | (NET)                                    | kg(lb)                                     | 18 (40)                                     |             |                                     | 71 (157)       |           |        | -           |        |
|  | (GROSS)                                  | kg(lb)                                     | 23 (51)                                     |             |                                     | 79 (174)       |           |        | -           |        |
| Layers limit (actually)                                  |  | 11 (12)                                    |   |             | 2 (3)                               |                |           | -      |             |        |
| Operation condition                                      | Cool (DBT)                               | 18°C ~ 32°C                                |   |             | -15°C ~ 46°C                        |                |           | -      |             |        |
|  | Heat (DBT)                               | 16°C ~ 30°C                                |   |             | -20°C ~ 24°C                        |                |           | -      |             |        |
| P<br>I<br>P<br>I<br>N<br>G                               | Pipe diameter mm (inch)                  | (Liquid)∅6.35(1/4) (Gas)∅12.7(1/2)         |   |             | (Liquid)∅9.52(3/8) (Gas)∅15.88(5/8) |                |           | -      |             |        |
|  | Connecting method, Standard length m(ft) | flared type, 5.0 (16.4)                    |   |             | flared type, 5.0 (16.4)             |                |           | -      |             |        |
| Pipe length range m (ft)                                 |  | 5 ~ 50 (16.4 ~ 164)                        |   |             |                                     |                |           |        |             |        |
| Indoor unit & Outdoor unit height difference m (ft)      |  | 15(OD located lower)/30(OD located higher) |   |             | (49.2/98.4)                         |                |           | -      |             |        |
| Add gas amount g/m (oz/ft)                               |  | 50 (0.538)                                 |   |             |                                     |                |           |        |             |        |
| Pipe length for additional gas m (ft)                    |  | 30 (98.4)                                  |   |             |                                     |                |           |        |             |        |

\*1: In case it is necessary to indicate the air flow volume in (l/s), the value in (m<sup>3</sup>/min.) shall be multiplied by 16.7 and rounded down the decimal point.  
\*2: If the EUROVENT Certified models can be operated under the "extra-low" temperature condition, -7°C dry bulb and -8°C wet-bulb temperatures with rated voltage 230 V shall be used.  
\*3: Network Impedance shall be applicable for EUROPE and CHINA models.  
\*4: The annual consumption is calculated by multiplying the input power at 230V (400V) by an average of 500 hours per year in cooling mode.  
\*5: EER and COP classification is at 230V (400V) only in accordance with EU directive 2002/31/EC.  
\*6: SEER and SCOP classification is at 230V (400V) only in accordance with EN-14825. For heating, SCOP indicates the value of only Average heating season, Other fiche data indicates in an attached sheet.  
\*7: Noise and air flow rate of L are indicated by the values at FAN mode. ( ): Normal operation Cooling/Heating noise value. Normal operation Cooling/Heating air flow rate are 7.6 (m<sup>3</sup>/min).

# Simultaneous (Triple) -Type

## 1-1. Unit Specifications

**PE1**

### 6. 4-Way Cassette 60×60 Type S-36PY2E5A×3 / U-100PE1E8A

| INDOOR   |   | MODEL                                      | S-36PY2E5A ×3                               |             |                                     | -              |           |        | -           |        |
|--|---|--|---|-------------|-------------------------------------|----------------|-----------|--------|-------------|--------|
| PANEL  |   | MODEL                                      | (CZ-KPY3AW / CZ-KPY3BW) ×3                  |             |                                     | -              |           |        | -           |        |
| OUTDOOR  |   | MODEL                                      | -   |             |                                     | U-100PE1E8A    |           |        | -           |        |
| Branch pipe  |   | MODEL                                      | -   |             |                                     | CZ-P3HPC2      |           |        | -           |        |
| Performance test condition                                 |   |  | ISO5151 / EN14511 / EN14825 / EN12102       |             |                                     |                |           |        |             |        |
| C<br>O<br>O<br>L<br>I<br>N<br>G                            | Power supply  | Ø, Hz                                      | 1ø 50Hz                                     |             |                                     | 3ø 50Hz        |           |        |             |        |
|  |   | V  | 220   | 230         | 240                                 | 380            | 400       | 415    | Min         | Max    |
|  | Capacity  | kW   | 10.0  | 10.0        | 10.0                                | -              | -         | -      | 3.3         | 12.5   |
|  |   | BTU/h                                      | 34100                                       | 34100       | 34100                               | -              | -         | -      | 11300       | 42700  |
|  | Current   | A  | 0.30 × 3                                    |             |                                     | 4.20           | 4.00      | 3.90   | -           | -      |
|  |   | W  | 40 × 3                                      |             |                                     | 2.560k         | 2.560k    | 2.560k | -           | -      |
|  | Input power   | TOTAL W                                    | -   |             |                                     | 2.680k         | 2.680k    | 2.680k | 840         | 3.700k |
|  |   | Annual consumption                         | TOTAL kWh **                                | -           | -                                   | -              | -         | 1340   | -           | -      |
|  | EER/EER CLASS                                       | TOTAL (W/W) <sup>††</sup> ("A"-G)          | -   | -           | -                                   | 3.73           | 3.73/A    | 3.73   | 3.93        | 3.38   |
|  | E <sub>sp</sub> <sup>†††</sup>                      | Pdesign                                    | kW  | -           | -                                   | -              | -         | 10.0   | -           | -      |
| SEER   |   | (W/W)                                      | -   | -           | -                                   | -              | 6.3       | -      | -           |        |
| Annual consumption   |   | kWh  | -   | -           | -                                   | -              | 555       | -      | -           |        |
| Class  |   |  | -   | -           | -                                   | -              | A++       | -      | -           |        |
| Power factor   | %   | -  | -   | -           | 93                                  | 92             | 91        | -      | -           |        |
| Noise indoor   | dB-A (H/M/L)  | 36/32/26(31)*7                             |   |             | -                                   |                |           | -      | -           |        |
|  | Power Level dB                                      | 51/47/41(46)*7                             |   |             | -                                   |                |           | -      | -           |        |
| Noise outdoor  | dB-A (H/L)  | -  |   |             | 52/-                                |                |           | -      | -           |        |
|  | Power Level dB                                      | -  |   |             | 69/-                                |                |           | -      | -           |        |
| H<br>E<br>A<br>T<br>I<br>N<br>G                            | Capacity  | kW   | 11.2  | 11.2        | 11.2                                | -              | -         | -      | 4.1         | 14.0   |
|  |   | BTU/h                                      | 38200                                       | 38200       | 38200                               | -              | -         | -      | 14000       | 47800  |
|  | Current   | A  | 0.30 × 3                                    |             |                                     | 4.60           | 4.40      | 4.30   | -           | -      |
|  |   | W  | 35 × 3                                      |             |                                     | 2.825k         | 2.825k    | 2.825k | -           | -      |
|  | Input power   | TOTAL W                                    | -   |             |                                     | 2.930k         | 2.930k    | 2.930k | 900         | 4.400k |
|  |   | COP/COP CLASS                              | TOTAL (W/W) <sup>††</sup> ("A"-G)           | -           | -                                   | -              | 3.82      | 3.82/A | 3.82        | 4.56   |
|  | E <sub>sp</sub> <sup>†††</sup>                      | Pdesign at -10°C                           | kW  | -           | -                                   | -              | -         | 9.5    | -           | -      |
|  |   | Tbivalent                                  | °C  | -           | -                                   | -              | -         | -10    | -           | -      |
|  |   | SCOP                                       | (W/W)                                       | -           | -                                   | -              | -         | 3.8    | -           | -      |
|  |   | Annual consumption                         | kWh   | -           | -                                   | -              | -         | 3500   | -           | -      |
| Class  |   | -  | -   | -           | -                                   | A              | -         | -      |             |        |
| Power factor   | %   | -  | -   | -           | 93                                  | 93             | 91        | -      | -           |        |
| Noise indoor   | dB-A (H/M/L)  | 36/32/26(31)*7                             |   |             | -                                   |                |           | -      | -           |        |
|  | Power Level dB                                      | 51/47/41(46)*7                             |   |             | -                                   |                |           | -      | -           |        |
| Noise outdoor  | dB-A (H/L)  | -  |   |             | 52/-                                |                |           | -      | -           |        |
|  | Power Level dB                                      | -  |   |             | 69/-                                |                |           | -      | -           |        |
| EXTRA LOW TEMP   Total capacity(kW) / Input power(W) / COP |   | -  |   |             |                                     |                |           |        |             |        |
| Max Current(A) / Max Input power(W)                        |   | 0.35/50 × 3                                | 0.35/50 × 3                                 | 0.35/50 × 3 | 9.0/5.55k                           | 9.0/5.85k      | 9.0/6.10k | -      |             |        |
| Starting current(A) / Comp output(W)                       |   | -  | -   | -           | 4.60/3.0k                           | 4.40/3.0k      | 4.30/3.0k | -      |             |        |
| Network Impedance(QMAX.)                                   |   | -  |   |             |                                     |                |           |        |             |        |
| Fan motor output (Indoor/Outdoor) W                        |   | 40 × 3                                     |   |             | 90 × 2                              |                |           | -      |             |        |
| Moisture removal volume                                    |   | L/h (P/h)                                  | 6.0   | (2.0×3)     | (12.6)                              | -              |           |        | -           |        |
| Indoor Air flow  | Cooling   | m <sup>3</sup> /min (ft <sup>3</sup> /min) | 9.7×3/8.0×3/6.0×3*7 (343)×3/(283)×3/(212)×3 |             |                                     | -              |           |        | -           |        |
|  | Heating   | m <sup>3</sup> /min (ft <sup>3</sup> /min) | 9.9×3/8.2×3/6.0×3*7 (350)×3/(290)×3/(212)×3 |             |                                     | -              |           |        | -           |        |
| Outdoor Air flow   | Cooling   | m <sup>3</sup> /min (ft <sup>3</sup> /min) | -   |             |                                     | 110 (3885)     |           |        | -           |        |
|  | Heating   | m <sup>3</sup> /min (ft <sup>3</sup> /min) | -   |             |                                     | 95 (3355)      |           |        | -           |        |
| Refrigerant type / amount g(oz)                            |   | -  |   |             | R410A                               | 3.40k          | (119.9)   | -      |             |        |
| Product dimension  | Height  | mm(inch)                                   | 260<265 + 23> (10-1/4)                      |             |                                     | 1416 (55-3/4)  |           |        | -           |        |
|  | Width   | mm(inch)                                   | 575<583> (22-21/32)                         |             |                                     | 940 (37-1/32)  |           |        | -           |        |
|  | Depth   | mm(inch)                                   | 575<583> (22-21/32)                         |             |                                     | 340 (13-13/32) |           |        | -           |        |
|  | Panel H×W×D mm                                      |  | 31 × 700 × 700 *                            |             |                                     | -              |           |        | * CZ-KPY3AW |        |
| Packing dimension  | Height  | mm(inch)                                   | 345 (13-19/32)                              |             |                                     | 1556           |           |        | -           |        |
|  | Width   | mm(inch)                                   | 691 (27-7/32)                               |             |                                     | 1055           |           |        | -           |        |
|  | Depth   | mm(inch)                                   | 691 (27-7/32)                               |             |                                     | 485            |           |        | -           |        |
| Weight   | (NET)   | kg(lb)                                     | 18 (40)                                     |             |                                     | 98 (216)       |           |        | -           |        |
|  | (GROSS)   | kg(lb)                                     | 23 (51)                                     |             |                                     | 108 (238)      |           |        | -           |        |
| Layers limit (actually)                                    |   | 11 (12)                                    |   |             | 1(2)                                |                |           | -      |             |        |
| Operation condition  | Cool (DBT)  | 18°C ~ 32°C                                |   |             | -15°C ~ 46°C                        |                |           | -      |             |        |
|  | Heat (DBT)  | 16°C ~ 30°C                                |   |             | -20°C ~ 24°C                        |                |           | -      |             |        |
| P<br>I<br>P<br>E   | Pipe diameter mm (inch)                             | (Liquid)ø6.35(1/4) (Gas)ø12.7(1/2)         |   |             | (Liquid)ø9.52(3/8) (Gas)ø15.88(5/8) |                |           | -      |             |        |
|  | Connecting method, Standard length m(ft)            | flared type, 5.0 (16.4)                    |   |             | flared type, 5.0 (16.4)             |                |           | -      |             |        |
| P<br>I<br>N<br>G   | Pipe length range m (ft)                            | 5 ~ 75 (16.4 ~ 246.1)                      |   |             |                                     |                |           |        |             |        |
|  | Indoor unit & Outdoor unit height difference m (ft) | 15(OD located lower)/30(OD located higher) |   |             | (49.2/98.4)                         |                |           | -      |             |        |
| Add gas amount g/m (oz/ft)                                 |   | 50 (0.538)                                 |   |             |                                     |                |           |        |             |        |
| Pipe length for additional gas m (ft)                      |   | 20 (65.6)                                  |   |             |                                     |                |           |        |             |        |

\*1: In case it is necessary to indicate the air flow volume in (l/s), the value in (m<sup>3</sup>/min.) shall be multiplied by 16.7 and rounded down the decimal point.

\*2: If the EUROVENT Certified models can be operated under the "extra-low" temperature condition, -7°C dry bulb and -8°C wet-bulb temperatures with rated voltage 230 V shall be used.

\*3: Network Impedance shall be applicable for EUROPE and CHINA models.

\*4: The annual consumption is calculated by multiplying the input power at 230V (400V) by an average of 500 hours per year in cooling mode.

\*5: EER and COP classification is at 230V (400V) only in accordance with EU directive 2002/31/EC.

\*6: SEER and SCOP classification is at 230V (400V) only in accordance with EN-14825. For heating, SCOP indicates the value of only Average heating season, Other fiche data indicates in an attached sheet.

\*7: Noise and air flow rate of L are indicated by the values at FAN mode. ( ) : Normal operation Cooling/Heating noise value. Normal operation Cooling/Heating air flow rate are 7.6 (m<sup>3</sup>/min).

# Simultaneous (Double-Twin) -Type

## 1-1. Unit Specifications

PE1

### 6. 4-Way Cassette 60x60 Type S-36PY2E5A×4 / U-125PE1E8A

|  |  |  |   |                                       |                                     |                |            |             |        |      |  |
|--|--|--|---|---------------------------------------|-------------------------------------|----------------|------------|-------------|--------|------|--|
| INDOOR   |  | MODEL                                      | S-36PY2E5A ×4                               |                                       |                                     | -              |            |             | -      |      |  |
| PANEL  |  | MODEL                                      | (CZ-KPY3AW / CZ-KPY3BW) ×4                  |                                       |                                     | -              |            |             | -      |      |  |
| OUTDOOR  |  | MODEL                                      | -   |                                       |                                     | U-125PE1E8A    |            |             | -      |      |  |
| Branch pipe  |  | MODEL                                      | -   |                                       |                                     | CZ-P155BK1 ×3  |            |             | -      |      |  |
| Performance test condition                                 |  |  |   | ISO5151 / EN14511 / EN14825 / EN12102 |                                     |                |            |             |        |      |  |
| Power supply   |  | ∅, Hz                                      | 1∅ 50Hz                                     |                                       |                                     | 3∅ 50Hz        |            |             |        |      |  |
|  |  | V  | 220   | 230                                   | 240                                 | 380            | 400        | 415         | Min    | Max  |  |
| Capacity   | kW                                       | 12.5                                       | 12.5  | 12.5                                  | -                                   | -              | -          | 3.3         | 14.0   |      |  |
|  | BTU/h                                    | 42700                                      | 42700                                       | 42700                                 | -                                   | -              | -          | 11300       | 47800  |      |  |
| Current  |  | A  | 0.30 × 4                                    |                                       |                                     | 6.00           | 5.70       | 5.50        | -      | -    |  |
| Input power  | W  | 40 × 4                                     |   |                                       | 3.680k                              | 3.680k         | 3.680k     | -           | -      |      |  |
|  | TOTAL W                                  | -  |   |                                       | 3.840k                              | 3.840k         | 3.840k     | 840         | 4.600k |      |  |
| Annual consumption   |  | TOTAL kWh **                               | -   | -                                     | -                                   | -              | 1920       | -           | -      |      |  |
| EER/EER CLASS  |  | TOTAL (W/W) <sup>†‡</sup> ("A"-G)          | -   | -                                     | -                                   | 3.26           | 3.26/A     | 3.26        | 3.93   | 3.04 |  |
| Erp <sub>sg</sub>  | Pdesign                                  | kW   | -   | -                                     | -                                   | -              | 12.5       | -           | -      | -    |  |
|  | η <sub>s.c</sub>                         | %  | -   | -                                     | -                                   | -              | 208.6      | -           | -      | -    |  |
|  | Annual consumption                       | kWh  | -   | -                                     | -                                   | -              | -          | -           | -      | -    |  |
|  | Class                                    |  | -   | -                                     | -                                   | -              | -          | -           | -      | -    |  |
| Power factor   |  | %  | -   | -                                     | -                                   | 93             | 93         | 93          | -      | -    |  |
| Noise indoor   | dB-A (H/M/L)                             | 36/32/26(31)*7                             |   |                                       | -                                   |                |            | -           | -      |      |  |
|  | Power Level dB                           | 51/47/41(46)*7                             |   |                                       | -                                   |                |            | -           | -      |      |  |
| Noise outdoor  | dB-A (H/L)                               | -  |   |                                       | 53/-                                |                |            | -           | -      |      |  |
|  | Power Level dB                           | -  |   |                                       | 70/-                                |                |            | -           | -      |      |  |
| Capacity   | kW                                       | 14.0                                       | 14.0  | 14.0                                  | -                                   | -              | -          | 4.1         | 16.0   |      |  |
|  | BTU/h                                    | 47800                                      | 47800                                       | 47800                                 | -                                   | -              | -          | 14000       | 54600  |      |  |
| Current  |  | A  | 0.30 × 4                                    |                                       |                                     | 6.20           | 5.90       | 5.70        | -      | -    |  |
| Input power  | W  | 35 × 4                                     |   |                                       | 3.750k                              | 3.750k         | 3.750k     | -           | -      |      |  |
|  | TOTAL W                                  | -  |   |                                       | 3.890k                              | 3.890k         | 3.890k     | 900         | 5.200k |      |  |
| COP/COP CLASS  |  | TOTAL (W/W) <sup>†‡</sup> ("A"-G)          | -   | -                                     | -                                   | 3.60           | 3.60/A     | 3.60        | 4.56   | 3.08 |  |
| Erp <sub>sg</sub>  | Pdesign at -10°C                         | kW   | -   | -                                     | -                                   | -              | 12.5       | -           | -      | -    |  |
|  | Tbivalent                                | °C   | -   | -                                     | -                                   | -              | -9         | -           | -      | -    |  |
|  | η <sub>s.h</sub>                         | %  | -   | -                                     | -                                   | -              | 141.4      | -           | -      | -    |  |
|  | Annual consumption                       | kWh  | -   | -                                     | -                                   | -              | -          | -           | -      | -    |  |
| Power factor   |  | %  | -   | -                                     | -                                   | 92             | 92         | 92          | -      | -    |  |
| Noise indoor   | dB-A (H/M/L)                             | 36/32/26(31)*7                             |   |                                       | -                                   |                |            | -           | -      |      |  |
|  | Power Level dB                           | 51/47/41(46)*7                             |   |                                       | -                                   |                |            | -           | -      |      |  |
| Noise outdoor  | dB-A (H/L)                               | -  |   |                                       | 53/-                                |                |            | -           | -      |      |  |
|  | Power Level dB                           | -  |   |                                       | 70/-                                |                |            | -           | -      |      |  |
| EXTRA LOW TEMP   Total capacity(kW) / Input power(W) / COP |  |  |   |                                       |                                     |                |            |             |        |      |  |
| Max Current(A) / Max Input power(W)                        |  | 0.35/50 × 4                                | 0.35/50 × 4                                 | 0.35/50 × 4                           | 10.0/6.20k                          | 10.0/6.50k     | 10.0/6.75k | -           | -      |      |  |
| Starting current(A) / Comp output(W)                       |  | -  | -   | -                                     | 6.20/3.0k                           | 5.90/3.0k      | 5.70/3.0k  | -           | -      |      |  |
| Network Impedance(QMAX.)                                   |  | -  |   |                                       | -                                   |                |            | -           |        |      |  |
| Fan motor output (Indoor/Outdoor) W                        |  | 40 × 4                                     |   |                                       | 90 × 2                              |                |            | -           |        |      |  |
| Moisture removal volume                                    |  | L/h (P/h)                                  | 7.9   | (1.975×4)                             | (16.6)                              | -              |            |             | -      |      |  |
| Indoor Air flow  | Cooling                                  | m³/min (ft³/min)                           | 9.7×4/8.0×4/6.0×4*7 (343)×4/(283)×4/(212)×4 |                                       |                                     | -              |            |             | -      |      |  |
|  | Heating                                  | m³/min (ft³/min)                           | 9.9×4/8.2×4/6.0×4*7 (350)×4/(290)×4/(212)×4 |                                       |                                     | -              |            |             | -      |      |  |
| Outdoor Air flow   | Cooling                                  | m³/min (ft³/min)                           | -   |                                       |                                     | 130            | (4591)     | -           | -      |      |  |
|  | Heating                                  | m³/min (ft³/min)                           | -   |                                       |                                     | 110            | (3885)     | -           | -      |      |  |
| Refrigerant type / amount g(oz)                            |  | -  |   |                                       | R410A                               | 3.40k          | (119.9)    | -           |        |      |  |
| Product dimension  | Height                                   | mm(inch)                                   | 260<265 + 23> (10-1/4)                      |                                       |                                     | 1416 (55-3/4)  |            |             | -      |      |  |
|  | Width                                    | mm(inch)                                   | 575<583> (22-21/32)                         |                                       |                                     | 940 (37-1/32)  |            |             | -      |      |  |
|  | Depth                                    | mm(inch)                                   | 575<583> (22-21/32)                         |                                       |                                     | 340 (13-13/32) |            |             | -      |      |  |
|  | Panel H×W×D mm                           | 31 × 700 × 700                             |   |                                       | -                                   |                |            | * CZ-KPY3AW |        |      |  |
| Packing dimension  | Height                                   | mm(inch)                                   | 345 (13-19/32)                              |                                       |                                     | 1556           |            |             | -      |      |  |
|  | Width                                    | mm(inch)                                   | 691 (27-7/32)                               |                                       |                                     | 1055           |            |             | -      |      |  |
|  | Depth                                    | mm(inch)                                   | 691 (27-7/32)                               |                                       |                                     | 485            |            |             | -      |      |  |
| Weight   | (NET)                                    | kg(lb)                                     | 18 (40)                                     |                                       |                                     | 98 (216)       |            |             | -      |      |  |
|  | (GROSS)                                  | kg(lb)                                     | 23 (51)                                     |                                       |                                     | 108 (238)      |            |             | -      |      |  |
| Layers limit (actually)                                    |  | 11 (12)                                    |   |                                       | 1 (2)                               |                |            | -           |        |      |  |
| Operation condition  | Cool (DBT)                               | 18°C ~ 32°C                                |   |                                       | -15°C ~ 46°C                        |                |            | -           |        |      |  |
|  | Heat (DBT)                               | 16°C ~ 30°C                                |   |                                       | -20°C ~ 24°C                        |                |            | -           |        |      |  |
| P I P I N G  | Pipe diameter mm (inch)                  | (Liquid)∅6.35(1/4) (Gas)∅12.7(1/2)         |   |                                       | (Liquid)∅9.52(3/8) (Gas)∅15.88(5/8) |                |            | -           |        |      |  |
|  | Connecting method, Standard length m(ft) | flared type, 5.0 (16.4)                    |   |                                       | flared type, 5.0 (16.4)             |                |            | -           |        |      |  |
| Pipe length range m (ft)                                   |  | 5 ~ 75 (16.4 ~ 246.1)                      |   |                                       | -                                   |                |            | -           |        |      |  |
| Indoor unit & Outdoor unit height difference m (ft)        |  | 15(OD located lower)/30(OD located higher) |   |                                       | (49.2/98.4)                         |                |            | -           |        |      |  |
| Add gas amount g/m (oz/ft)                                 |  | 50 (0.538)                                 |   |                                       | -                                   |                |            | -           |        |      |  |
| Pipe length for additional gas m (ft)                      |  | 20 (65.6)                                  |   |                                       | -                                   |                |            | -           |        |      |  |

\*1: In case it is necessary to indicate the air flow volume in (l/s), the value in (m³/min.) shall be multiplied by 16.7 and rounded down the decimal point.  
 \*2: If the EUROVENT Certified models can be operated under the "extra-low" temperature condition, -7°C dry bulb and -8°C wet-bulb temperatures with rated voltage 230 V shall be used.  
 \*3: Network Impedance shall be applicable for EUROPE and CHINA models.  
 \*4: The annual consumption is calculated by multiplying the input power at 230V (400V) by an average of 500 hours per year in cooling mode.  
 \*5: EER and COP classification is at 230V (400V) only in accordance with EU directive 2002/31/EC.  
 \*6: SEER and SCOP classification is at 230V (400V) only in accordance with EN-14825. For heating, SCOP indicates the value of only Average heating season.  
 \*7: Noise and air flow rate of L are indicated by the values at FAN mode. ( ): Normal operation Cooling/Heating noise value. Normal operation Cooling/Heating air flow rate are 7.6 (m³/min).

# Simultaneous (Triple) -Type

## 1-1. Unit Specifications

**PE1**

### 6. 4-Way Cassette 60x60 Type S-45PY2E5A×3 / U-125PE1E8A

| INDOOR   |  | MODEL                                      | S-45PY2E5A ×3                                |             |                                     | -              |        |            | -           |            |      |
|--|--|--|--|-------------|-------------------------------------|----------------|--------|------------|-------------|------------|------|
| PANEL  |  | MODEL                                      | (CZ-KPY3AW / CZ-KPY3BW) ×3                   |             |                                     | -              |        |            | -           |            |      |
| OUTDOOR  |  | MODEL                                      | -  |             |                                     | U-125PE1E8A    |        |            | -           |            |      |
| Branch pipe  |  | MODEL                                      | CZ-P3HPC2                                    |             |                                     |                |        |            |             | -          |      |
| Performance test condition                                 |  |  | ISO5151 / EN14511 / EN14825 / EN12102        |             |                                     |                |        |            |             | -          |      |
| C<br>O<br>O<br>L<br>I<br>N<br>G                            | Power supply                             | ∅, Hz                                      | 1∅ 50Hz                                      |             |                                     | 3∅ 50Hz        |        |            | -           |            |      |
|  |  | V  | 220  | 230         | 240                                 | 380            | 400    | 415        | Min         | Max        |      |
|  | Capacity                                 | kW   | 12.5   | 12.5        | 12.5                                | -              | -      | -          | 3.3         | 14.0       |      |
|  |  | BTU/h                                      | 42700  | 42700       | 42700                               | -              | -      | -          | 11300       | 47800      |      |
|  | Current                                  | A  | 0.32 × 3                                     |             |                                     | 6.00           | 5.70   | 5.50       | -           | -          |      |
|  |  | W  | 40 × 3                                       |             |                                     | 3.680k         | 3.680k | 3.680k     | -           | -          |      |
|  | Input power                              | TOTAL W                                    | -  |             |                                     | 3.800k         | 3.800k | 3.800k     | 840         | 4.600k     |      |
|  |  | Annual consumption                         | TOTAL kWh **                                 | -           | -                                   | -              | -      | 1900       | -           | -          |      |
|  | EER/EER CLASS                            | TOTAL (W/W) <sup>†‡</sup> ("A"-G)          | -  | -           | -                                   | 3.29           | 3.29/A | 3.29       | 3.93        | 3.04       |      |
|  | E <sub>sp</sub> <sup>‡§</sup>            | Pdesign                                    | kW   | -           | -                                   | -              | -      | 12.5       | -           | -          |      |
| η <sub>s.c</sub>   |  | %  | -  | -           | -                                   | -              | 211.9  | -          | -           |            |      |
| Annual consumption   |  | kWh  | -  | -           | -                                   | -              | -      | -          | -           |            |      |
| Class  |  |  | -  | -           | -                                   | -              | -      | -          | -           |            |      |
| Power factor   | %  | -  | -  | -           | 93                                  | 93             | 93     | -          | -           |            |      |
| Noise indoor   | dB-A (H/M/L)                             | 38/34/28(32)*7                             |  |             | -                                   |                |        | -          | -           |            |      |
|  | Power Level dB                           | 53/49/43(47)*7                             |  |             | -                                   |                |        | -          | -           |            |      |
| Noise outdoor  | dB-A (H/L)                               | -  |  |             | 53/-                                |                |        | -          | -           |            |      |
|  | Power Level dB                           | -  |  |             | 70/-                                |                |        | -          | -           |            |      |
| H<br>E<br>A<br>T<br>I<br>N<br>G                            | Capacity                                 | kW   | 14.0   | 14.0        | 14.0                                | -              | -      | -          | 4.1         | 16.0       |      |
|  |  | BTU/h                                      | 47800  | 47800       | 47800                               | -              | -      | -          | 14000       | 54600      |      |
|  | Current                                  | A  | 0.30 × 3                                     |             |                                     | 6.20           | 5.90   | 5.70       | -           | -          |      |
|  |  | W  | 35 × 3                                       |             |                                     | 3.750k         | 3.750k | 3.750k     | -           | -          |      |
|  | Input power                              | TOTAL W                                    | -  |             |                                     | 3.860k         | 3.860k | 3.860k     | 900         | 5.200k     |      |
|  |  | COP/COP CLASS                              | TOTAL (W/W) <sup>†‡</sup> ("A"-G)            | -           | -                                   | -              | 3.63   | 3.63/A     | 3.63        | 4.56       | 3.08 |
|  | E <sub>sp</sub> <sup>‡§</sup>            | Pdesign at -10°C                           | kW   | -           | -                                   | -              | -      | 12.5       | -           | -          |      |
|  |  | Tbivalent                                  | °C   | -           | -                                   | -              | -      | -9         | -           | -          |      |
|  |  | η <sub>s.h</sub>                           | %  | -           | -                                   | -              | -      | 141.5      | -           | -          |      |
|  |  | Annual consumption                         | kWh  | -           | -                                   | -              | -      | -          | -           | -          |      |
| Class  |  | -  | -  | -           | -                                   | -              | -      | -          |             |            |      |
| Power factor   | %  | -  | -  | -           | 92                                  | 92             | 92     | -          | -           |            |      |
| Noise indoor   | dB-A (H/M/L)                             | 38/34/28(32)*7                             |  |             | -                                   |                |        | -          | -           |            |      |
|  | Power Level dB                           | 53/49/43(47)*7                             |  |             | -                                   |                |        | -          | -           |            |      |
| Noise outdoor  | dB-A (H/L)                               | -  |  |             | 53/-                                |                |        | -          | -           |            |      |
|  | Power Level dB                           | -  |  |             | 70/-                                |                |        | -          | -           |            |      |
| EXTRA LOW TEMP   Total capacity(kW) / Input power(W) / COP |  |  |  |             |                                     |                |        |            |             |            |      |
| Max Current(A) / Max Input power(W)                        |  | 0.37/50 × 3                                |  | 0.37/50 × 3 |                                     | 0.37/50 × 3    |        | 10.0/6.20k | 10.0/6.50k  | 10.0/6.75k |      |
| Starting current(A) / Comp output(W)                       |  | -  |  | -           |                                     | -              |        | 6.20/3.0k  | 5.90/3.0k   | 5.70/3.0k  |      |
| Network Impedance(QMAX.)                                   |  | -  |  | -           |                                     | -              |        | -          |             |            |      |
| Fan motor output (Indoor/Outdoor) W                        |  | -  |  | 40 × 3      |                                     | -              |        | 90 × 2     |             |            |      |
| Moisture removal volume                                    |  | L/h(P/h)                                   | 7.9  | (2.63×3)    | (16.6)                              | -              |        |            | -           |            |      |
| Indoor Air flow  | Cooling                                  | m <sup>3</sup> /min (ft <sup>3</sup> /min) | 10.0×3/8.8×3/7.0×3*7 (353)×3/(311)×3/(247)×3 |             |                                     | -              |        |            | -           | -          |      |
|  | Heating                                  | m <sup>3</sup> /min (ft <sup>3</sup> /min) | 10.3×3/9.2×3/7.0×3*7 (364)×3/(325)×3/(247)×3 |             |                                     | -              |        |            | -           | -          |      |
| Outdoor Air flow   | Cooling                                  | m <sup>3</sup> /min (ft <sup>3</sup> /min) | -  |             |                                     | 130            |        |            | (4591)      | -          |      |
|  | Heating                                  | m <sup>3</sup> /min (ft <sup>3</sup> /min) | -  |             |                                     | 110            |        |            | (3885)      | -          |      |
| Refrigerant type / amount g(oz)                            |  | -  |  | -           |                                     | R410A          | 3.40k  | (119.9)    | -           |            |      |
| Product dimension  | Height                                   | mm(inch)                                   | 260<265 + 23> (10-1/4)                       |             |                                     | 1416 (55-3/4)  |        |            | -           |            |      |
|  | Width                                    | mm(inch)                                   | 575<583> (22-21/32)                          |             |                                     | 940 (37-1/32)  |        |            | -           |            |      |
|  | Depth                                    | mm(inch)                                   | 575<583> (22-21/32)                          |             |                                     | 340 (13-13/32) |        |            | -           |            |      |
|  | Panel H×W×D mm                           | 31 × 700 × 700                             |  | *           |                                     | -              |        |            | * CZ-KPY3AW |            |      |
| Packing dimension  | Height                                   | mm(inch)                                   | 345 (13-19/32)                               |             |                                     | 1556           |        |            | -           |            |      |
|  | Width                                    | mm(inch)                                   | 691 (27-7/32)                                |             |                                     | 1055           |        |            | -           |            |      |
|  | Depth                                    | mm(inch)                                   | 691 (27-7/32)                                |             |                                     | 485            |        |            | -           |            |      |
| Weight   | (NET)                                    | kg(lb)                                     | 18 (40)                                      |             |                                     | 98 (216)       |        |            | -           |            |      |
|  | (GROSS)                                  | kg(lb)                                     | 23 (51)                                      |             |                                     | 108 (238)      |        |            | -           |            |      |
| Layers limit (actually)                                    |  | 11(12)                                     |  |             | 1(2)                                |                |        | -          |             |            |      |
| Operation condition  | Cool (DBT)                               | 18°C ~ 32°C                                |  |             | -15°C ~ 46°C                        |                |        | -          |             |            |      |
|  | Heat (DBT)                               | 16°C ~ 30°C                                |  |             | -20°C ~ 24°C                        |                |        | -          |             |            |      |
| P<br>I<br>P<br>I<br>N<br>G                                 | Pipe diameter mm (inch)                  | (Liquid)∅6.35(1/4) (Gas)∅12.7(1/2)         |  |             | (Liquid)∅9.52(3/8) (Gas)∅15.88(5/8) |                |        | -          |             |            |      |
|  | Connecting method, Standard length m(ft) | flared type, 5.0 (16.4)                    |  |             | flared type, 5.0 (16.4)             |                |        | -          |             |            |      |
| Pipe length range m (ft)                                   |  | 5 ~ 75 (16.4 ~ 246.1)                      |  |             |                                     |                |        |            |             |            |      |
| Indoor unit & Outdoor unit height difference m (ft)        |  | 15(OD located lower)/30(OD located higher) |  |             | (49.2/98.4)                         |                |        | -          |             |            |      |
| Add gas amount g/m (oz/ft)                                 |  | 50 (0.538)                                 |  |             |                                     |                |        |            |             |            |      |
| Pipe length for additional gas m (ft)                      |  | 20 (65.6)                                  |  |             |                                     |                |        |            |             |            |      |

\*1: In case it is necessary to indicate the air flow volume in (l/s), the value in (m<sup>3</sup>/min.) shall be multiplied by 16.7 and rounded down the decimal point.

\*2: If the EUROVENT Certified models can be operated under the "extra-low" temperature condition, -7°C dry bulb and -8°C wet-bulb temperatures with rated voltage 230 V shall be used.

\*3: Network Impedance shall be applicable for EUROPE and CHINA models.

\*4: The annual consumption is calculated by multiplying the input power at 230V (400V) by an average of 500 hours per year in cooling mode.

\*5: EER and COP classification is at 230V (400V) only in accordance with EU directive 2002/31/EC.

\*6: SEER and SCOP classification is at 230V (400V) only in accordance with EN-14825. For heating, SCOP indicates the value of only Average heating season.

\*7: Noise and air flow rate of L are indicated by the values at FAN mode. ( ): Normal operation Cooling/Heating noise value. Normal operation Cooling/Heating air flow rate are 7.6 (m<sup>3</sup>/min).

# Simultaneous (Twin) -Type

## 1-1. Unit Specifications

PE1

### 6. 4-Way Cassette 60x60 Type S-50PY2E5A×2 / U-100PE1E8A

|  |  |  |  |             |                                     |                |           |       |             |       |
|--|--|--|--|-------------|-------------------------------------|----------------|-----------|-------|-------------|-------|
| INDOOR   |  | MODEL                                      | S-50PY2E5A ×2                              |             |                                     | -              |           |       | -           |       |
| PANEL  |  | MODEL                                      | (CZ-KPY3AW / CZ-KPY3BW) ×2                 |             |                                     | -              |           |       | -           |       |
| OUTDOOR  |  | MODEL                                      | -  |             |                                     | U-100PE1E8A    |           |       | -           |       |
| Branch pipe  |  | MODEL                                      | -  |             |                                     | CZ-P155BK1     |           |       | -           |       |
| Performance test condition                                 |  | ISO5151 / EN14511 / EN14825 / EN12102      |  |             |                                     |                |           |       |             |       |
| Power supply   |  | Ø, Hz                                      | 1ø 50Hz                                    |             |                                     | 3ø 50Hz        |           |       |             |       |
|  |  | V  | 220  | 230         | 240                                 | 380            | 400       | 415   | Min         | Max   |
| Capacity   | kW                                       | 10.0                                       | 10.0                                       | 10.0        | -                                   | -              | -         | -     | 3.3         | 12.5  |
|  | BTU/h                                    | 34100                                      | 34100                                      | 34100       | -                                   | -              | -         | -     | 11300       | 42700 |
| Current  | A  | 0.35 × 2                                   |  |             | 4.20                                | 4.00           | 3.90      | -     | -           | -     |
| Input power  | W  | 45 × 2                                     |  |             | 2.560k                              | 2.560k         | 2.560k    | -     | -           | -     |
|  | TOTAL W                                  | -  |  |             | 2.650k                              | 2.650k         | 2.650k    | 840   | 3.700k      | -     |
| Annual consumption   | TOTAL kWh **4                            | -  | -  | -           | -                                   | 1325           | -         | -     | -           | -     |
| EER/EER CLASS  | TOTAL (W/W) **5 ("A"-G)                  | -  | -  | -           | 3.77                                | 3.77/A         | 3.77      | 3.93  | 3.38        | -     |
| Erp *6   | Pdesign                                  | kW   | -  | -           | -                                   | -              | 10.0      | -     | -           | -     |
|  | SEER                                     | (W/W)                                      | -  | -           | -                                   | -              | 6.3       | -     | -           | -     |
|  | Annual consumption                       | kWh  | -  | -           | -                                   | -              | 555       | -     | -           | -     |
|  | Class                                    |  | -  | -           | -                                   | -              | A++       | -     | -           | -     |
| Power factor   | %  | -  | -  | -           | 93                                  | 92             | 91        | -     | -           | -     |
| Noise indoor   | dB-A (H/M/L)                             | 40/37/33                                   |  |             | -                                   |                |           | -     | -           | -     |
|  | Power Level dB                           | 55/52/48                                   |  |             | -                                   |                |           | -     | -           | -     |
| Noise outdoor  | dB-A (H/L)                               | -  |  |             | 52/-                                |                |           | -     | -           | -     |
|  | Power Level dB                           | -  |  |             | 69/-                                |                |           | -     | -           | -     |
| Capacity   | kW                                       | 11.2                                       | 11.2                                       | 11.2        | -                                   | -              | -         | 4.1   | 14.0        | -     |
|  | BTU/h                                    | 38200                                      | 38200                                      | 38200       | -                                   | -              | -         | 14000 | 47800       | -     |
| Current  | A  | 0.35 × 2                                   |  |             | 4.60                                | 4.40           | 4.30      | -     | -           | -     |
| Input power  | W  | 40 × 2                                     |  |             | 2.825k                              | 2.825k         | 2.825k    | -     | -           | -     |
|  | TOTAL W                                  | -  |  |             | 2.910k                              | 2.910k         | 2.910k    | 900   | 4.400k      | -     |
| COP/COP CLASS  | TOTAL (W/W) **5 ("A"-G)                  | -  | -  | -           | 3.85                                | 3.85/A         | 3.85      | 4.56  | 3.18        | -     |
| Erp *6   | Pdesign at -10°C                         | kW   | -  | -           | -                                   | -              | 9.5       | -     | -           | -     |
|  | Tbivalent                                | °C   | -  | -           | -                                   | -              | -10       | -     | -           | -     |
|  | SCOP                                     | (W/W)                                      | -  | -           | -                                   | -              | 3.8       | -     | -           | -     |
|  | Annual consumption                       | kWh  | -  | -           | -                                   | -              | 3500      | -     | -           | -     |
| Class  |  | -  | -  | -           | -                                   | A              | -         | -     | -           |       |
| Power factor   | %  | -  | -  | -           | 93                                  | 93             | 91        | -     | -           | -     |
| Noise indoor   | dB-A (H/M/L)                             | 40/37/33                                   |  |             | -                                   |                |           | -     | -           | -     |
|  | Power Level dB                           | 55/52/48                                   |  |             | -                                   |                |           | -     | -           | -     |
| Noise outdoor  | dB-A (H/L)                               | -  |  |             | 52/-                                |                |           | -     | -           | -     |
|  | Power Level dB                           | -  |  |             | 69/-                                |                |           | -     | -           | -     |
| EXTRA LOW TEMP   Total capacity(kW) / Input power(W) / COP |  | -  |  |             |                                     |                |           |       |             |       |
| Max Current(A) / Max Input power(W)                        |  | 0.40/55 × 2                                | 0.40/55 × 2                                | 0.40/55 × 2 | 9.0/5.55k                           | 9.0/5.85k      | 9.0/6.10k | -     | -           | -     |
| Starting current(A) / Comp output(W)                       |  | -  | -  | -           | 4.60/3.0k                           | 4.40/3.0k      | 4.30/3.0k | -     | -           | -     |
| Network Impedance(QMAX.)                                   |  | -  |  |             |                                     |                |           |       |             |       |
| Fan motor output (Indoor/Outdoor) W                        |  | 40 × 2                                     |  |             | 90 × 2                              |                |           | -     |             |       |
| Moisture removal volume                                    |  | L/h (PT/h)                                 | 6.0  | (3.0×2)     | (12.6)                              | -              |           |       | -           |       |
| Indoor Air flow  | Cooling                                  | m³/min (ft³/min)                           | 11.1×2/9.8×2/8.5×2 (392)×2/(346)×2/(300)×2 |             |                                     | -              |           |       | -           | -     |
|  | Heating                                  | m³/min (ft³/min)                           | 11.1×2/9.8×2/8.7×2 (392)×2/(346)×2/(307)×2 |             |                                     | -              |           |       | -           | -     |
| Outdoor Air flow   | Cooling                                  | m³/min (ft³/min)                           | -  |             |                                     | 110            | (3885)    | -     | -           |       |
|  | Heating                                  | m³/min (ft³/min)                           | -  |             |                                     | 95             | (3355)    | -     | -           |       |
| Refrigerant type / amount g(oz)                            |  | -  |  |             | R410A                               | 3.40k          | (119.9)   | -     |             |       |
| Product dimension  | Height                                   | mm(inch)                                   | 260<265 + 23> (10-1/4)                     |             |                                     | 1416 (55-3/4)  |           |       | -           |       |
|  | Width                                    | mm(inch)                                   | 575<583> (22-21/32)                        |             |                                     | 940 (37-1/32)  |           |       | -           |       |
|  | Depth                                    | mm(inch)                                   | 575<583> (22-21/32)                        |             |                                     | 340 (13-13/32) |           |       | -           |       |
|  | Panel H×W×D mm                           |  | 31 × 700 × 700                             |             |                                     | -              |           |       | * CZ-KPY3AW |       |
| Packing dimension  | Height                                   | mm(inch)                                   | 345 (13-19/32)                             |             |                                     | 1556           |           |       | -           |       |
|  | Width                                    | mm(inch)                                   | 691 (27-7/32)                              |             |                                     | 1055           |           |       | -           |       |
|  | Depth                                    | mm(inch)                                   | 691 (27-7/32)                              |             |                                     | 485            |           |       | -           |       |
| Weight   | (NET)                                    | kg(lb)                                     | 18 (40)                                    |             |                                     | 98 (216)       |           |       | -           |       |
|  | (GROSS)                                  | kg(lb)                                     | 23 (51)                                    |             |                                     | 108 (238)      |           |       | -           |       |
| Layers limit (actually)                                    |  | 11 (12)                                    |  |             | 1 (2)                               |                |           | -     |             |       |
| Operation condition  | Cool (DBT)                               | 18°C ~ 32°C                                |  |             | -15°C ~ 46°C                        |                |           | -     |             |       |
|  | Heat (DBT)                               | 16°C ~ 30°C                                |  |             | -20°C ~ 24°C                        |                |           | -     |             |       |
| P I P I N G  | Pipe diameter mm (inch)                  | (Liquid)ø6.35(1/4) (Gas)ø12.7(1/2)         |  |             | (Liquid)ø9.52(3/8) (Gas)ø15.88(5/8) |                |           | -     |             |       |
|  | Connecting method, Standard length m(ft) | flared type, 5.0(16.4)                     |  |             | flared type, 5.0(16.4)              |                |           | -     |             |       |
| Pipe length range m (ft)                                   |  | 5 ~ 75 (16.4 ~ 246.1)                      |  |             |                                     |                |           |       |             |       |
| Indoor unit & Outdoor unit height difference m (ft)        |  | 15(OD located lower)/30(OD located higher) |  |             | (49.2/98.4)                         |                |           | -     |             |       |
| Add gas amount g/m (oz/ft)                                 |  | 50 (0.538)                                 |  |             |                                     |                |           |       |             |       |
| Pipe length for additional gas m (ft)                      |  | 30 (98.4)                                  |  |             |                                     |                |           |       |             |       |

\*1: In case it is necessary to indicate the air flow volume in (l/s), the value in (m³/min.) shall be multiplied by 16.7 and rounded down the decimal point.  
 \*2: If the EUROVENT Certified models can be operated under the "extra-low" temperature condition, -7°C dry bulb and -8°C wet-bulb temperatures with rated voltage 230V shall be used.  
 \*3: Network Impedance shall be applicable for EUROPE and CHINA models.  
 \*4: The annual consumption is calculated by multiplying the input power at 230V(400V) by an average of 500 hours per year in cooling mode.  
 \*5: EER and COP classification is at 230V(400V) only in accordance with EU directive 2002/31/EC.  
 \*6: SEER and SCOP classification is at 230V(400V) only in accordance with EN-14825. For heating, SCOP indicates the value of only Average heating season, Other fiche data indicates in an attached sheet.

# Simultaneous (Triple) -Type

## 1-1. Unit Specifications

**PE1**

### 6. 4-Way Cassette 60x60 Type S-50PY2E5A×3 / U-140PE1E8A

| INDOOR   |  | MODEL                                      | S-50PY2E5A ×3                              |             |                                     | -              |            |       | -           |   |
|--|--|--|--|-------------|-------------------------------------|----------------|------------|-------|-------------|---|
| PANEL  |  | MODEL                                      | (CZ-KPY3AW / CZ-KPY3BW) ×3                 |             |                                     | -              |            |       | -           |   |
| OUTDOOR  |  | MODEL                                      | -  |             |                                     | U-140PE1E8A    |            |       | -           |   |
| Branch pipe  |  | MODEL                                      | -  |             |                                     | CZ-P3HPC2      |            |       | -           |   |
| Performance test condition                                 |  | ISO5151 / EN14511 / EN14825 / EN12102      |  |             |                                     |                |            |       |             |   |
| Power supply   | Ø, Hz                                    | 1ø 50Hz                                    |  |             | 3ø 50Hz                             |                |            |       |             |   |
|  | V  | 220  | 230  | 240         | 380                                 | 400            | 415        | Min   | Max         |   |
| Capacity   | kW                                       | 14.0                                       | 14.0                                       | 14.0        | -                                   | -              | -          | 3.3   | 15.5        |   |
|  | BTU/h                                    | 47800                                      | 47800                                      | 47800       | -                                   | -              | -          | 11300 | 52900       |   |
| Current  | A  | 0.35 × 3                                   |  |             | 7.40                                | 7.00           | 6.80       | -     | -           |   |
| Input power  | W  | 45 × 3                                     |  |             | 4.565k                              | 4.565k         | 4.565k     | -     | -           |   |
|  | TOTAL W                                  | -  |  |             | 4.700k                              | 4.700k         | 4.700k     | 840   | 6.000k      |   |
| Annual consumption   | TOTAL kWh **                             | -  | -  | -           | -                                   | 2350           | -          | -     | -           |   |
| EER/EER CLASS  | TOTAL (W/W) <sup>†5</sup> ("A"-G)        | -  | -  | -           | 2.98                                | 2.98/C         | 2.98       | 3.93  | 2.58        |   |
| Erp <sup>†6</sup>  | Pdesign                                  | kW   | -  | -           | -                                   | -              | 14.0       | -     | -           |   |
|  | η <sub>s.c</sub>                         | %  | -  | -           | -                                   | -              | 202.7      | -     | -           |   |
|  | Annual consumption                       | kWh  | -  | -           | -                                   | -              | -          | -     | -           |   |
|  | Class                                    |  | -  | -           | -                                   | -              | -          | -     | -           |   |
| Power factor   | %  | -  | -  | -           | 94                                  | 94             | 93         | -     | -           |   |
| Noise indoor   | dB-A (H/M/L)                             | 40/37/33                                   |  |             | -                                   |                |            | -     | -           |   |
|  | Power Level dB                           | 55/52/48                                   |  |             | -                                   |                |            | -     | -           |   |
| Noise outdoor  | dB-A (H/L)                               | -  |  |             | 54/-                                |                |            | -     | -           |   |
|  | Power Level dB                           | -  |  |             | 71/-                                |                |            | -     | -           |   |
| Capacity   | kW                                       | 16.0                                       | 16.0                                       | 16.0        | -                                   | -              | -          | 4.1   | 18.0        |   |
|  | BTU/h                                    | 54600                                      | 54600                                      | 54600       | -                                   | -              | -          | 14000 | 61400       |   |
| Current  | A  | 0.35 × 3                                   |  |             | 7.70                                | 7.30           | 7.00       | -     | -           |   |
| Input power  | W  | 40 × 3                                     |  |             | 4.700k                              | 4.700k         | 4.700k     | -     | -           |   |
|  | TOTAL W                                  | -  |  |             | 4.820k                              | 4.820k         | 4.820k     | 900   | 5.900k      |   |
| COP/COP CLASS  | TOTAL (W/W) <sup>†5</sup> ("A"-G)        | -  | -  | -           | 3.32                                | 3.32/C         | 3.32       | 4.56  | 3.05        |   |
| Erp <sup>†6</sup>  | Pdesign at -10°C                         | kW   | -  | -           | -                                   | -              | 14.0       | -     | -           |   |
|  | Tbivalent                                | °C   | -  | -           | -                                   | -              | -7         | -     | -           |   |
|  | η <sub>s.h</sub>                         | %  | -  | -           | -                                   | -              | 139.2      | -     | -           |   |
|  | Annual consumption                       | kWh  | -  | -           | -                                   | -              | -          | -     | -           |   |
| Class  |  | -  | -  | -           | -                                   | -              | -          | -     |             |   |
| Power factor   | %  | -  | -  | -           | 93                                  | 93             | 93         | -     | -           |   |
| Noise indoor   | dB-A (H/M/L)                             | 40/37/33                                   |  |             | -                                   |                |            | -     | -           |   |
|  | Power Level dB                           | 55/52/48                                   |  |             | -                                   |                |            | -     | -           |   |
| Noise outdoor  | dB-A (H/L)                               | -  |  |             | 55/-                                |                |            | -     | -           |   |
|  | Power Level dB                           | -  |  |             | 71/-                                |                |            | -     | -           |   |
| EXTRA LOW TEMP   Total capacity(kW) / Input power(W) / COP |  | -  |  |             |                                     |                |            |       |             |   |
| Max Current(A) / Max Input power(W)                        |  | 0.40/55 × 3                                | 0.40/55 × 3                                | 0.40/55 × 3 | 11.0/6.80k                          | 11.0/7.15k     | 11.0/7.45k | -     |             |   |
| Starting current(A) / Comp output(W)                       |  | -  | -  | -           | 7.70/3.0k                           | 7.30/3.0k      | 7.00/3.0k  | -     |             |   |
| Network Impedance(QMAX.)                                   |  | -  |  |             | -                                   |                |            | -     |             |   |
| Fan motor output (Indoor/Outdoor) W                        |  | 40 × 3                                     |  |             | 90 × 2                              |                |            | -     |             |   |
| Moisture removal volume   L/h(P/h)                         |  | 9.0  | (3.0×3)                                    | (18.9)      | -                                   |                |            | -     |             |   |
| Indoor Air flow  | Cooling                                  | m <sup>3</sup> /min (ft <sup>3</sup> /min) | 11.1×3/9.8×3/8.5×3 (392)×3/(346)×3/(300)×3 |             |                                     | -              |            |       | -           | - |
|  | Heating                                  | m <sup>3</sup> /min (ft <sup>3</sup> /min) | 11.1×3/9.8×3/8.7×3 (392)×3/(346)×3/(307)×3 |             |                                     | -              |            |       | -           | - |
| Outdoor Air flow   | Cooling                                  | m <sup>3</sup> /min (ft <sup>3</sup> /min) | -  |             |                                     | 135            | (4767)     | -     | -           |   |
|  | Heating                                  | m <sup>3</sup> /min (ft <sup>3</sup> /min) | -  |             |                                     | 120            | (4238)     | -     | -           |   |
| Refrigerant type / amount g(oz)                            |  | -  |  |             | R410A                               | 3.40k          | (119.9)    | -     |             |   |
| Product dimension  | Height                                   | mm(inch)                                   | 260<265 + 23> (10-1/4)                     |             |                                     | 1416 (55-3/4)  |            |       | -           |   |
|  | Width                                    | mm(inch)                                   | 575<583> (22-21/32)                        |             |                                     | 940 (37-1/32)  |            |       | -           |   |
|  | Depth                                    | mm(inch)                                   | 575<583> (22-21/32)                        |             |                                     | 340 (13-13/32) |            |       | -           |   |
|  | Panel H×W×D mm                           |  | 31 × 700 × 700                             |             |                                     | -              |            |       | * CZ-KPY3AW |   |
| Packing dimension  | Height                                   | mm(inch)                                   | 345 (13-19/32)                             |             |                                     | 1556           |            |       | -           |   |
|  | Width                                    | mm(inch)                                   | 691 (27-7/32)                              |             |                                     | 1055           |            |       | -           |   |
|  | Depth                                    | mm(inch)                                   | 691 (27-7/32)                              |             |                                     | 485            |            |       | -           |   |
| Weight   | (NET)                                    | kg(lb)                                     | 18 (40)                                    |             |                                     | 98 (216)       |            |       | -           |   |
|  | (GROSS)                                  | kg(lb)                                     | 23 (51)                                    |             |                                     | 108 (238)      |            |       | -           |   |
| Layers limit (actually)                                    |  | 11 (12)                                    |  |             | 1 (2)                               |                |            | -     |             |   |
| Operation condition  | Cool (DBT)                               | 18°C ~ 32°C                                |  |             | -15°C ~ 46°C                        |                |            | -     |             |   |
|  | Heat (DBT)                               | 16°C ~ 30°C                                |  |             | -20°C ~ 24°C                        |                |            | -     |             |   |
| P I P I N G  | Pipe diameter mm (inch)                  | (Liquid)ø6.35(1/4) (Gas)ø12.7(1/2)         |  |             | (Liquid)ø9.52(3/8) (Gas)ø15.88(5/8) |                |            | -     |             |   |
|  | Connecting method, Standard length m(ft) | flared type, 5.0 (16.4)                    |  |             | flared type, 5.0 (16.4)             |                |            | -     |             |   |
| Pipe length range m (ft)                                   |  | 5 ~ 75 (16.4 ~ 246.1)                      |  |             | -                                   |                |            | -     |             |   |
| Indoor unit & Outdoor unit height difference m (ft)        |  | 15(OD located lower)/30(OD located higher) |  |             | (49.2/98.4)                         |                |            | -     |             |   |
| Add gas amount g/m (oz/ft)                                 |  | 50 (0.538)                                 |  |             | -                                   |                |            | -     |             |   |
| Pipe length for additional gas m (ft)                      |  | 20 (65.6)                                  |  |             | -                                   |                |            | -     |             |   |

\*1: In case it is necessary to indicate the air flow volume in (l/s), the value in (m<sup>3</sup>/min.) shall be multiplied by 16.7 and rounded down the decimal point.

\*2: If the EUROVENT Certified models can be operated under the "extra-low" temperature condition, -7°C dry bulb and -8°C wet-bulb temperatures with rated voltage 230V shall be used.

\*3: Network Impedance shall be applicable for EUROPE and CHINA models.

\*4: The annual consumption is calculated by multiplying the input power at 230V(400V) by an average of 500 hours per year in cooling mode.

\*5: EER and COP classification is at 230V(400V) only in accordance with EU directive 2002/31/EC.

\*6: SEER and SCOP classification is at 230V(400V) only in accordance with EN-14825. For heating, SCOP indicates the value of only Average heating season.

# Simultaneous (Twin) -Type

## 1-1. Unit Specifications

**PEY1**

### 7. 4-Way Cassette Type S-50PU2E5A×2 / U-100PEY1E5

| INDOOR   |  | MODEL   | S-50PU2E5A ×2                                       |               |                                     | -              |              |        | -    |        |      |
|--|--|---|---|---------------|-------------------------------------|----------------|--------------|--------|------|--------|------|
| PANEL  |  | MODEL   | Standard type:CZ-KPU3 ×2 / ECONAVI type:CZ-KPU3A ×2 |               |                                     | -              |              |        | -    |        |      |
| OUTDOOR  |  | MODEL   | -   |               |                                     | U-100PEY1E5    |              |        | -    |        |      |
| Branch pipe  |  | MODEL   | CZ-P155BK1  |               |                                     |                |              |        |      | -      |      |
| Performance test condition                               |  | ISO5151 / EN14511 / EN12102 / EN14825                           |   |               |                                     |                |              |        |      |        |      |
| C<br>O<br>O<br>L<br>I<br>N<br>G                          | Power supply                             | ∅, Hz   | 1∅ 50Hz   |               |                                     | 1∅ 50Hz        |              |        |      |        |      |
|  |  | V   | 220V  | 230V          | 240V                                | 220V           | 230V         | 240V   | Min  | Max    |      |
|  | Capacity                                 | kW  | 10.0  | 10.0          | 10.0                                | -              | -            | -      | 2.7  | 11.5   |      |
|  |  | BTU/h   | 34100   | 34100         | 34100                               | -              | -            | -      | 9200 | 39200  |      |
|  | Current                                  | A   | 0.27 ×2   | 0.26 ×2       | 0.25 ×2                             | 15.0           | 14.3         | 13.7   | -    | -      |      |
|  |  | W   | 29 ×2   | 29 ×2         | 29 ×2                               | 3.102k         | 3.102k       | 3.102k | -    | -      |      |
|  | Input power                              | TOTAL W   | -   | -             | -                                   | 3.160k         | 3.160k       | 3.160k | 530  | 4.200k |      |
|  |  | Annual consumption  | TOTAL kWh *4  | -             | -                                   | -              | -            | 1580   | -    | -      |      |
|  | EER/EER CLASS                            | TOTAL (W/W) <sup>*5</sup> ("A"-G)                               | -   | -             | -                                   | 3.16           | 3.16/B       | 3.16   | 5.09 | 2.74   |      |
|  | Erp <sup>*6</sup>                        | Pdesign   | kW  | -             | -                                   | -              | -            | 10.0   | -    | -      |      |
|  |  | SEER  | (W/W)   | -             | -                                   | -              | -            | 6.6    | -    | -      |      |
|  |  | Annual consumption  | kWh   | -             | -                                   | -              | -            | 530    | -    | -      |      |
|  |  | Class   |   | -             | -                                   | -              | -            | A++    | -    | -      |      |
|  | Power factor                             | %   | -   | -             | -                                   | 94             | 94           | 94     | -    | -      |      |
| Noise indoor   | dB-A (H/M/L) *7                          | 32/29/27  |   |               | -                                   |                |              | -      | -    |        |      |
|  | Power Level dB                           | 47/44/42  |   |               | -                                   |                |              | -      | -    |        |      |
| Noise outdoor  | dB-A (H/L)                               | -   |   |               | 54/-                                |                |              | -      | -    |        |      |
|  | Power Level dB                           | -   |   |               | 70/-                                |                |              | -      | -    |        |      |
| H<br>E<br>A<br>T<br>I<br>N<br>G                          | Capacity                                 | kW  | 10.0  | 10.0          | 10.0                                | -              | -            | -      | 2.1  | 13.8   |      |
|  |  | BTU/h   | 34100   | 34100         | 34100                               | -              | -            | -      | 7200 | 47100  |      |
|  | Current                                  | A   | 0.26 ×2   | 0.25 ×2       | 0.24 ×2                             | 11.2           | 10.8         | 10.3   | -    | -      |      |
|  |  | W   | 27 ×2   | 27 ×2         | 27 ×2                               | 2.356k         | 2.356k       | 2.356k | -    | -      |      |
|  | Input power                              | TOTAL W   | -   | -             | -                                   | 2.410k         | 2.410k       | 2.410k | 410  | 4.000k |      |
|  |  | COP/COP CLASS   | TOTAL (W/W) <sup>*5</sup> ("A"-G)                   | -             | -                                   | -              | 4.15         | 4.15/A | 4.15 | 5.12   | 3.45 |
|  | Erp <sup>*6</sup>                        | Pdesign at -10°C  | kW  | -             | -                                   | -              | -            | 10.0   | -    | -      |      |
|  |  | Tbivalent   | °C  | -             | -                                   | -              | -            | -8     | -    | -      |      |
|  |  | SCOP  | (W/W)   | -             | -                                   | -              | -            | 4.3    | -    | -      |      |
|  |  | Annual consumption  | kWh   | -             | -                                   | -              | -            | 3256   | -    | -      |      |
|  | Class                                    |   | -   | -             | -                                   | -              | A+           | -      | -    |        |      |
|  | Power factor                             | %   | -   | -             | -                                   | 96             | 95           | 95     | -    | -      |      |
|  | Noise indoor                             | dB-A (H/M/L) *7   | 32/29/27  |               |                                     | -              |              |        | -    | -      |      |
|  |  | Power Level dB  | 47/44/42  |               |                                     | -              |              |        | -    | -      |      |
| Noise outdoor  | dB-A (H/L)                               | -   |   |               | 54/-                                |                |              | -      | -    |        |      |
|  | Power Level dB                           | -   |   |               | 70/-                                |                |              | -      | -    |        |      |
| EXTRA LOW TEMP Total capacity(kW) / Input power(W) / COP |  | -   |   |               |                                     |                |              |        |      |        |      |
| Max Current(A) / Max Input power(W)                      |  | 0.27 ×2/29 ×2   | 0.26 ×2/29 ×2                                       | 0.25 ×2/29 ×2 | 25.0 / 5.30k                        | 25.0 / 5.50k   | 25.0 / 5.70k | -      |      |        |      |
| Starting current(A) / Comp output(W)                     |  | -   | -   | -             | 15.0 / 1.7k                         | 14.3 / 1.7k    | 13.7 / 1.7k  | -      |      |        |      |
| Network Impedance(QMAX.)                                 |  | -   |   |               |                                     |                |              |        |      |        |      |
| Fan motor output (Indoor/Outdoor) W                      |  | 60  |   |               | 90                                  |                |              | -      |      |        |      |
| Moisture removal volume                                  |  | L/h(Pt/h)   | 3.2   | (1.6×2)       | (6.7)                               | -              |              |        | -    |        |      |
| External static pressure                                 |  | Pa  | -   |               |                                     | -              |              |        | -    |        |      |
| Indoor Air flow *7                                       | Cooling                                  | m³/min (ft³/min)  | 16.5×2/13.5×2/11.5×2 (583)×2/(477)×2/(406)×2        |               |                                     | -              |              |        | -    | -      |      |
|  | Heating                                  | m³/min (ft³/min)  | 16.5×2/13.5×2/11.5×2 (583)×2/(477)×2/(406)×2        |               |                                     | -              |              |        | -    | -      |      |
| Outdoor Air flow   | Cooling                                  | m³/min (ft³/min)  | -   |               |                                     | 76 (2684)      |              |        | -    | -      |      |
|  | Heating                                  | m³/min (ft³/min)  | -   |               |                                     | 67 (2366)      |              |        | -    | -      |      |
| Refrigerant type / amount g(oz)                          |  | -   |   |               | R410A 2.60k (91.7)                  |                |              | -      |      |        |      |
| Product dimension  | Height                                   | mm(inch)  | 256   | (10-5/64)     |                                     | 996 (39-7/32)  |              |        | -    |        |      |
|  | Width                                    | mm(inch)  | 840   | (33-5/64)     |                                     | 940 (37-1/32)  |              |        | -    |        |      |
|  | Depth                                    | mm(inch)  | 840   | (33-5/64)     |                                     | 340 (13-13/32) |              |        | -    |        |      |
| Product dimension (Panel)                                |  | H×W×D mm, inch  | 33.5×950×950  |               | 1-11/32 × 37-13/32 × 37-13/32       |                | -            |        |      |        |      |
| Packing dimension  | Height                                   | mm(inch)  | 302   | (11-57/64)    |                                     | 1136           |              |        | -    |        |      |
|  | Width                                    | mm(inch)  | 898   | (35-3/8)      |                                     | 1055           |              |        | -    |        |      |
|  | Depth                                    | mm(inch)  | 898   | (35-3/8)      |                                     | 485            |              |        | -    |        |      |
| Weight   | (NET)                                    | kg(lb)  | 19  | (42)          |                                     | 73             | (161)        |        | -    |        |      |
|  | (GROSS)                                  | kg(lb)  | 26  | (57)          |                                     | 81             | (179)        |        | -    |        |      |
|  | Panel (NET)                              | kg(lb)  | 5   | (11)          |                                     | -              |              |        | -    |        |      |
|  | Layers limit (actually)                  |   | 11 (12)   |               |                                     | 2 (3)          |              |        | -    |        |      |
| Operation condition                                      | Cool (DBT)                               | 18°C ~ 32°C   |   |               | -10°C ~ 43°C                        |                |              | -      |      |        |      |
|  | Heat (DBT)                               | 16°C ~ 30°C   |   |               | -15°C ~ 24°C                        |                |              | -      |      |        |      |
| P I P I N G  | Pipe diameter mm (inch)                  | (Liquid)∅6.35(1/4) (Gas)∅12.7(1/2)                              |   |               | (Liquid)∅9.52(3/8) (Gas)∅15.88(5/8) |                |              | -      |      |        |      |
|  | Connecting method, Standard length m(ft) | flared type, 5.0(16.4)  |   |               | flared type, 5.0(16.4)              |                |              | -      |      |        |      |
| Pipe length range  |  | m (ft) 5 ~ 50m (16.4 ~164)                                      |   |               |                                     |                |              |        |      |        |      |
| Indoor unit & Outdoor unit height difference             |  | m (ft) 15m(OD located lower)/30m(OD located higher) (49.2/98.4) |   |               |                                     |                |              |        |      |        |      |
| Add gas amount   |  | g/m (oz/ft) 50g (0.538)   |   |               |                                     |                |              |        |      |        |      |
| Pipe length for additional gas                           |  | m (ft) 30m (98.4)   |   |               |                                     |                |              |        |      |        |      |

\*1 In case it is necessary to indicate the air flow volume in (l/s), the value in (m³/min.) shall be multiplied by 16.7 and rounded down the decimal point.  
 \*2 If the EUROVENT Certified models can be operated under the "extra-low"temperature condition, -7°C dry bulb and -8°C wet-bulb temperatures with rated voltage 230V shall be used.  
 \*3 Network Impedance shall be applicable for EUROPE and CHINA models.  
 \*4 The annual consumption is calculated by multiplying the input power at 230V(400V) by an average of 500 hours per year in cooling mode.  
 \*5 EER and COP classification is at 230V(400V) only in accordance with EU directive 2002/31/EC.  
 \*6 SEER and SCOP classification is at 230V(400V) only in accordance with EN-14825. For heating, SCOP indicates the value of only Average heating season, Other fiche data indicates in an attached sheet  
 \*7 H: High at setting 5 stage (Level 5), M: Middle at setting 5 stage (Level 3), L: Low at setting 5 stage (Level 1)

# Single -Type

## 1-1. Unit Specifications

### PEY2

#### 7. 4-Way Cassette Type S-60PU2E5A / U-60PEY2E5A

| INDOOR   | MODEL                                    | S-60PU2E5A  |  |            | -                                   |              |              | -      |      |        |
|--|--|---|--|------------|-------------------------------------|--------------|--------------|--------|------|--------|
| PANEL  | MODEL                                    | Standard type:CZ-KPU3 / ECONAVI type:CZ-KPU3A                   |  |            | -                                   |              |              | -      |      |        |
| OUTDOOR  | MODEL                                    | -   |  |            | U-60PEY2E5                          |              |              | -      |      |        |
| Branch pipe  | MODEL                                    | -   |  |            | -                                   |              |              | -      |      |        |
| Performance test condition                               |  | ISO5151 / EN14511 / EN12102 / EN14825                           |  |            |                                     |              |              |        |      |        |
| C<br>O<br>O<br>L<br>I<br>N<br>G                          | Power supply                             | Ø, Hz   | 1Ø 50Hz                                  |            |                                     | 1Ø 50Hz      |              |        | Min  | Max    |
|  | Capacity                                 | kW  | 220V                                     | 230V       | 240V                                | 220V         | 230V         | 240V   | 2.0  | 7.1    |
|  |  | BTU/h   | 6.0                                      | 6.0        | 6.0                                 | -            | -            | -      | 6800 | 24200  |
|  | Current                                  | A   | 0.36                                     | 0.35       | 0.34                                | 8.00         | 7.60         | 7.30   | -    | -      |
|  |  | W   | 38                                       | 38         | 38                                  | 1.582k       | 1.582k       | 1.582k | -    | -      |
|  | Input power                              | TOTAL W   | -  | -          | -                                   | 1.620k       | 1.620k       | 1.620k | 250  | 2.200k |
|  |  | Annual consumption  | TOTAL kWh *4                             | -          | -                                   | -            | -            | 810    | -    | -      |
|  | EER/EER CLASS                            | TOTAL (W/W) *5 / ("A"-G)  | -  | -          | -                                   | 3.70         | 3.70/A       | 3.70   | 8.00 | 3.23   |
|  | Erp *6                                   | Pdesign   | kW                                       | -          | -                                   | -            | -            | 6.0    | -    | -      |
|  |  | SEER  | (W/W)                                    | -          | -                                   | -            | -            | 7.0    | -    | -      |
|  |  | Annual consumption  | kWh                                      | -          | -                                   | -            | -            | 300    | -    | -      |
|  |  | Class   | -  | -          | -                                   | -            | -            | A++    | -    | -      |
|  | Power factor                             | %   | -  | -          | -                                   | 90           | 90           | 90     | -    | -      |
|  | Noise indoor                             | dB-A (H/M/L) *7   | 36/31/28                                 |            |                                     | -            |              |        | -    | -      |
| Power Level dB   |  | 51/46/43  |  |            | -                                   |              |              | -      | -    |        |
| Noise outdoor  | dB-A (H/L)                               | -   |  |            | 46/-                                |              |              | -      | -    |        |
|  | Power Level dB                           | -   |  |            | 65/-                                |              |              | -      | -    |        |
| H<br>E<br>A<br>T<br>I<br>N<br>G                          | Capacity                                 | kW  | 6.0                                      | 6.0        | 6.0                                 | -            | -            | -      | 1.8  | 7.0    |
|  |  | BTU/h   | 20500                                    | 20500      | 20500                               | -            | -            | -      | 6100 | 23900  |
|  | Current                                  | A   | 0.35                                     | 0.34       | 0.33                                | 7.05         | 6.75         | 6.45   | -    | -      |
|  |  | W   | 36                                       | 36         | 36                                  | 1.394k       | 1.394k       | 1.394k | -    | -      |
|  | Input power                              | TOTAL W   | -  | -          | -                                   | 1.430k       | 1.430k       | 1.430k | 200  | 1.650k |
|  |  | COP/COP CLASS   | TOTAL (W/W) *5 / ("A"-G)                 | -          | -                                   | -            | 4.20         | 4.20/A | 4.20 | 9.00   |
|  | Erp *6                                   | Pdesign at -10°C  | kW                                       | -          | -                                   | -            | -            | 6.0    | -    | -      |
|  |  | Tbivalent   | °C                                       | -          | -                                   | -            | -            | -8     | -    | -      |
|  |  | SCOP  | (W/W)                                    | -          | -                                   | -            | -            | 4.1    | -    | -      |
|  |  | Annual consumption  | kWh                                      | -          | -                                   | -            | -            | 2047   | -    | -      |
|  | Class                                    | -   | -  | -          | -                                   | -            | A+           | -      | -    |        |
|  | Power factor                             | %   | -  | -          | -                                   | 90           | 90           | 90     | -    | -      |
|  | Noise indoor                             | dB-A (H/M/L) *7   | 36/31/28                                 |            |                                     | -            |              |        | -    | -      |
|  |  | Power Level dB  | 51/46/43                                 |            |                                     | -            |              |        | -    | -      |
| Noise outdoor  | dB-A (H/L)                               | -   |  |            | 48/-                                |              |              | -      | -    |        |
|  | Power Level dB                           | -   |  |            | 68/-                                |              |              | -      | -    |        |
| EXTRA LOW TEMP Total capacity(kW) / Input power(W) / COP |  | -   |  |            |                                     |              |              |        |      |        |
| Max Current(A) / Max Input power(W)                      |  | 0.36/38   | 0.35/38                                  | 0.34/38    | 16.5 / 3.27k                        | 16.5 / 3.42k | 16.5 / 3.57k | -      |      |        |
| Starting current(A) / Comp output(W)                     |  | -   | -  | -          | 8.00 / 1.7k                         | 7.60 / 1.7k  | 7.30 / 1.7k  | -      |      |        |
| Network Impedance(ΩMAX.)                                 |  | -   |  |            |                                     |              |              |        |      |        |
| Fan motor output (Indoor/Outdoor) W                      |  | 60  |  |            | 60                                  |              |              | -      |      |        |
| Moisture removal volume                                  |  | L/h(Pt/h)   | 1.7                                      | (3.6)      | -                                   |              |              | -      |      |        |
| External static pressure                                 |  | Pa  | -  |            |                                     | -            |              |        | -    |        |
| Indoor Air flow *7                                       | Cooling                                  | m³/min (ft³/min)  | 21.0 / 16.0 / 13.0 (742) / (565) / (459) |            |                                     | -            |              |        | -    | -      |
|  | Heating                                  | m³/min (ft³/min)  | 21.0 / 16.0 / 13.0 (742) / (565) / (459) |            |                                     | -            |              |        | -    | -      |
| Outdoor Air flow   | Cooling                                  | m³/min (ft³/min)  | -  |            |                                     | 38 (1342)    |              |        | -    | -      |
|  | Heating                                  | m³/min (ft³/min)  | -  |            |                                     | 41 (1448)    |              |        | -    | -      |
| Refrigerant type / amount g(oz)                          |  | -   |  |            | R410A 1.95k (68.8)                  |              |              | -      |      |        |
| Product dimension  | Height                                   | mm(inch)  | 256                                      | (10-5/64)  | 619                                 | (24-3/8)     | -            |        |      |        |
|  | Width                                    | mm(inch)  | 840                                      | (33-5/64)  | 799                                 | (31-29/64)   | -            |        |      |        |
|  | Depth                                    | mm(inch)  | 840                                      | (33-5/64)  | 299                                 | (11-49/64)   | -            |        |      |        |
| Product dimension (Panel)                                |  | H×W×D mm, inch  | 33.5×950×950                             |            | 1-11/32 × 37-13/32 × 37-13/32       |              | -            |        |      |        |
| Packing dimension  | Height                                   | mm(inch)  | 302                                      | (11-57/64) | 688                                 |              |              | -      |      |        |
|  | Width                                    | mm(inch)  | 898                                      | (35-3/8)   | 931                                 |              |              | -      |      |        |
|  | Depth                                    | mm(inch)  | 898                                      | (35-3/8)   | 422                                 |              |              | -      |      |        |
| Weight   | (NET)                                    | kg(lb)  | 20                                       | (44)       | 40                                  | (88)         | -            |        |      |        |
|  | (GROSS)                                  | kg(lb)  | 27                                       | (60)       | 45                                  | (99)         | -            |        |      |        |
|  | Panel (NET)                              | kg(lb)  | 5  | (11)       | -                                   |              |              | -      |      |        |
| Layers limit (actually)                                  |  | 11 (12)   |  |            | 5 (6)                               |              |              | -      |      |        |
| Operation condition                                      | Cool (DBT)                               | 18°C ~ 32°C   |  |            | -10°C ~ 43°C                        |              |              | -      |      |        |
|  | Heat (DBT)                               | 16°C ~ 30°C   |  |            | -15°C ~ 24°C                        |              |              | -      |      |        |
| P<br>I<br>P<br>I<br>N<br>G                               | Pipe diameter mm (inch)                  | (Liquid)Ø9.52(3/8) (Gas)Ø15.88(5/8)                             |  |            | (Liquid)Ø9.52(3/8) (Gas)Ø15.88(5/8) |              |              | -      |      |        |
|  | Connecting method, Standard length m(ft) | flared type, 5.0(16.4)  |  |            | flared type, 5.0(16.4)              |              |              | -      |      |        |
| Pipe length range  |  | m (ft) 3 ~ 40m (9.8 ~ 131.2)                                    |  |            |                                     |              |              |        |      |        |
| Indoor unit & Outdoor unit height difference             |  | m (ft) 15m(OD located lower)/30m(OD located higher) (49.2/98.4) |  |            |                                     |              |              |        |      |        |
| Add gas amount   |  | g(m) 40g (0.430)  |  |            |                                     |              |              |        |      |        |
| Pipe length for additional gas                           |  | m (ft) 30m (98.4)   |  |            |                                     |              |              |        |      |        |

\*1 In case it is necessary to indicate the air flow volume in (l/s), the value in (m³/min.) shall be multiplied by 16.7 and rounded down the decimal point.

\*2 If the EUROVENT Certified models can be operated under the "extra-low" temperature condition, -7°C dry bulb and -8°C wet-bulb temperatures with rated voltage 230V shall be used.

\*3 Network Impedance shall be applicable for EUROPE and CHINA models.

\*4 The annual consumption is calculated by multiplying the input power at 230V(400V) by an average of 500 hours per year in cooling mode.

\*5 EER and COP classification is at 230V(400V) only in accordance with EU directive 2002/31/EC.

\*6 SEER and SCOP classification is at 230V(400V) only in accordance with EN-14825. For heating, SCOP indicates the value of only Average heating season, Other fiche data indicates in an attached sheet

\*7 H: High at setting 5 stage (Level 5), M: Middle at setting 5 stage (Level 3), L: Low at setting 5 stage (Level 1)



# Simultaneous (Twin) -Type

## 1-1. Unit Specifications

**PEY1**

### 7. 4-Way Cassette Type S-60PU2E5A×2 / U-125PEY1E5

| INDOOR  |                    | MODEL                                     | S-60PU2E5A ×2                                       |  |         | -                             |        |                                     | -      |              |        |
|---|--------------------|---|---|--|---------|-------------------------------|--------|-------------------------------------|--------|--------------|--------|
| PANEL   |                    | MODEL                                     | Standard type:CZ-KPU3 ×2 / ECONAVI type:CZ-KPU3A ×2 |  |         | -                             |        |                                     | -      |              |        |
| OUTDOOR   |                    | MODEL                                     | -   |  |         | U-125PEY1E5                   |        |                                     | -      |              |        |
| Branch pipe   |                    | MODEL                                     | -   |  |         | CZ-P155BK1                    |        |                                     | -      |              |        |
| Performance test condition                          |                    | ISO5151 / EN14511 / EN12102 / EN14825     |   |  |         |                               |        |                                     |        |              |        |
| C<br>O<br>O<br>L<br>I<br>N<br>G                     | Power supply       |   | 1Ø 50Hz   |  |         | 1Ø 50Hz                       |        |                                     |        |              |        |
|   |                    |   | ∅, Hz   |  |         |                               |        |                                     |        |              |        |
|   |                    |   | V   | 220V   | 230V    | 240V                          | 220V   | 230V                                | 240V   | Min          | Max    |
|   | Capacity           |   | kW  | 12.5   | 12.5    | 12.5                          | -      | -                                   | -      | 3.8          | 13.5   |
|   |                    |   | BTU/h   | 42700  | 42700   | 42700                         | -      | -                                   | -      | 13000        | 46100  |
|   | Current            |   | A   | 0.36 ×2  | 0.35 ×2 | 0.34 ×2                       | 19.0   | 18.2                                | 17.4   | -            | -      |
|   | Input power        |   | W   | 38 ×2  | 38 ×2   | 38 ×2                         | 3.884k | 3.884k                              | 3.884k | -            | -      |
|   |                    |   | TOTAL W   | -  | -       | -                             | 3.960k | 3.960k                              | 3.960k | 900          | 4.880k |
|   | Annual consumption |   | TOTAL kWh *4  | -  | -       | -                             | -      | 1980                                | -      | -            | -      |
|   | EER/EER CLASS      |   | TOTAL (W/W) *5 / ("A"-G)                            | -  | -       | -                             | 3.16   | 3.16/B                              | 3.16   | 4.22         | 2.77   |
|   | Erp *6             |   | Pdesign   | kW   | -       | -                             | -      | 12.5                                | -      | -            | -      |
|   |                    |   | η <sub>s.c</sub>                                    | %  | -       | -                             | -      | 248.8                               | -      | -            | -      |
|   |                    |   | Annual consumption                                  | kWh  | -       | -                             | -      | -                                   | -      | -            | -      |
|   |                    |   | Class   | -  | -       | -                             | -      | -                                   | -      | -            | -      |
| Power factor  |                    | %   | -   | -  | -       | 93                            | 93     | 93                                  | -      | -            |        |
| Noise indoor  |                    | dB-A (H/M/L) *7                           | 36/31/28  |  |         | -                             |        |                                     | -      | -            |        |
|   |                    | Power Level dB                            | 51/46/43  |  |         | -                             |        |                                     | -      | -            |        |
| Noise outdoor                                       |                    | dB-A (H/L)                                | -   |  |         | 56/-                          |        |                                     | -      | -            |        |
|   |                    | Power Level dB                            | -   |  |         | 73/-                          |        |                                     | -      | -            |        |
| H<br>E<br>A<br>T<br>I<br>N<br>G                     | Capacity           |   | kW  | 12.5   | 12.5    | 12.5                          | -      | -                                   | -      | 3.4          | 15.0   |
|   |                    |   | BTU/h   | 42700  | 42700   | 42700                         | -      | -                                   | -      | 11600        | 51200  |
|   | Current            |   | A   | 0.35 ×2  | 0.34 ×2 | 0.33 ×2                       | 14.4   | 13.8                                | 13.2   | -            | -      |
|   | Input power        |   | W   | 36 ×2  | 36 ×2   | 36 ×2                         | 2.978k | 2.978k                              | 2.978k | -            | -      |
|   |                    |   | TOTAL W   | -  | -       | -                             | 3.050k | 3.050k                              | 3.050k | 730          | 4.400k |
|   | COP/COP CLASS      |   | TOTAL (W/W) *5 / ("A"-G)                            | -  | -       | -                             | 4.10   | 4.10/A                              | 4.10   | 4.66         | 3.41   |
|   | Erp *6             |   | Pdesign at -10°C                                    | kW   | -       | -                             | -      | 12.5                                | -      | -            | -      |
|   |                    |   | Tbivalent   | °C   | -       | -                             | -      | -7                                  | -      | -            | -      |
|   |                    |   | η <sub>s.h</sub>                                    | %  | -       | -                             | -      | 151.9                               | -      | -            | -      |
|   |                    |   | Annual consumption                                  | kWh  | -       | -                             | -      | -                                   | -      | -            | -      |
|   |                    |   | Class   | -  | -       | -                             | -      | -                                   | -      | -            | -      |
|   | Power factor       |   | %   | -  | -       | -                             | 94     | 94                                  | 94     | -            | -      |
|   | Noise indoor       |   | dB-A (H/M/L) *7                                     | 36/31/28   |         |                               | -      |                                     |        | -            | -      |
|   |                    |   | Power Level dB                                      | 51/46/43   |         |                               | -      |                                     |        | -            | -      |
| Noise outdoor                                       |                    | dB-A (H/L)                                | -   |  |         | 56/-                          |        |                                     | -      | -            |        |
|   |                    | Power Level dB                            | -   |  |         | 73/-                          |        |                                     | -      | -            |        |
| EXTRA LOW TEMP                                      |                    | Total capacity(kW) / Input power(W) / COP |   |  |         |                               |        |                                     |        |              |        |
| Max Current(A) / Max Input power(W)                 |                    | 0.36×2/38×2                               |   | 0.35×2/38×2  |         | 0.34×2/38×2                   |        | 29.0 / 6.00k                        |        | 29.0 / 6.30k |        |
| Starting current(A) / Comp output(W)                |                    | -   |   | -  |         | -                             |        | 19.0 / 3.0k                         |        | 18.2 / 3.0k  |        |
| Network Impedance(ΩMAX.)                            |                    | -   |   | -  |         | -                             |        | -                                   |        | -            |        |
| Fan motor output (Indoor/Outdoor) W                 |                    | -   |   | 60   |         | -                             |        | 90                                  |        | -            |        |
| Moisture removal volume                             |                    | L/h(Pt/h)                                 |   | 3.4 (1.7×2)  |         | (7.1)                         |        | -                                   |        | -            |        |
| External static pressure                            |                    | Pa  |   | -  |         | -                             |        | -                                   |        | -            |        |
| Indoor Air flow *7                                  | Cooling            | m³/min (ft³/min)                          |   | 21.0×2/16.0×2/13.0×2 (742)×2/(565)×2/(459)×2             |         | -                             |        | -                                   |        | -            |        |
|   | Heating            | m³/min (ft³/min)                          |   | 21.0×2/16.0×2/13.0×2 (742)×2/(565)×2/(459)×2             |         | -                             |        | -                                   |        | -            |        |
| Outdoor Air flow                                    | Cooling            | m³/min (ft³/min)                          |   | -  |         | -                             |        | 80 (2825)                           |        | -            |        |
|   | Heating            | m³/min (ft³/min)                          |   | -  |         | -                             |        | 73 (2578)                           |        | -            |        |
| Refrigerant type / amount g(oz)                     |                    | -   |   | -  |         | -                             |        | R410A 3.20k (112.9)                 |        | -            |        |
| Product dimension                                   | Height             | mm(inch)                                  |   | 256 (10-5/64)  |         | -                             |        | 996 (39-7/32)                       |        | -            |        |
|   | Width              | mm(inch)                                  |   | 840 (33-5/64)  |         | -                             |        | 940 (37-1/32)                       |        | -            |        |
|   | Depth              | mm(inch)                                  |   | 840 (33-5/64)  |         | -                             |        | 340 (13-13/32)                      |        | -            |        |
| Product dimension (Panel)                           |                    | H×W×D mm, inch                            |   | 33.5×950×950   |         | 1-11/32 × 37-13/32 × 37-13/32 |        | -                                   |        | -            |        |
| Packing dimension                                   | Height             | mm(inch)                                  |   | 302 (11-57/64)   |         | -                             |        | 1136                                |        | -            |        |
|   | Width              | mm(inch)                                  |   | 898 (35-3/8)   |         | -                             |        | 1055                                |        | -            |        |
|   | Depth              | mm(inch)                                  |   | 898 (35-3/8)   |         | -                             |        | 485                                 |        | -            |        |
| Weight  | (NET)              | kg(lb)                                    |   | 20 (44)  |         | 85 (187)                      |        | -                                   |        | -            |        |
|   | (GROSS)            | kg(lb)                                    |   | 27 (60)  |         | 93 (205)                      |        | -                                   |        | -            |        |
|   | Panel (NET)        | kg(lb)                                    |   | 5 (11)   |         | -                             |        | -                                   |        | -            |        |
| Layers limit (actually)                             |                    | -   |   | 11 (12)  |         | -                             |        | 2 (3)                               |        | -            |        |
| Operation condition                                 | Cool (DBT)         | -   |   | 18°C ~ 32°C  |         | -                             |        | -10°C ~ 43°C                        |        | -            |        |
|   | Heat (DBT)         | -   |   | 16°C ~ 30°C  |         | -                             |        | -15°C ~ 24°C                        |        | -            |        |
| Pipe diameter mm (inch)                             |                    | -   |   | (Liquid)Ø9.52(3/8) (Gas)Ø15.88(5/8)                      |         | -                             |        | (Liquid)Ø9.52(3/8) (Gas)Ø15.88(5/8) |        | -            |        |
| Connecting method, Standard length m(ft)            |                    | -   |   | flared type, 5.0(16.4)                                   |         | -                             |        | flared type, 5.0(16.4)              |        | -            |        |
| Pipe length range m (ft)                            |                    | -   |   | 5 ~ 50m (16.4 ~164)                                      |         | -                             |        | -                                   |        | -            |        |
| Indoor unit & Outdoor unit height difference m (ft) |                    | -   |   | 15m(OD located lower)/30m(OD located higher) (49.2/98.4) |         | -                             |        | -                                   |        | -            |        |
| Add gas amount g/m (oz/ft)                          |                    | -   |   | 50g (0.538)  |         | -                             |        | -                                   |        | -            |        |
| Pipe length for additional gas m (ft)               |                    | -   |   | 30m (98.4)   |         | -                             |        | -                                   |        | -            |        |

\*1 In case it is necessary to indicate the air flow volume in (l/s), the value in (m³/min.) shall be multiplied by 16.7 and rounded down the decimal point.

\*2 If the EUROVENT Certified models can be operated under the "extra-low" temperature condition, -7°C dry bulb and -8°C wet-bulb temperatures with rated voltage 230V shall be used.

\*3 Network Impedance shall be applicable for EUROPE and CHINA models.

\*4 The annual consumption is calculated by multiplying the input power at 230V(400V) by an average of 500 hours per year in cooling mode.

\*5 EER and COP classification is at 230V(400V) only in accordance with EU directive 2002/31/EC.

\*6 SEER and SCOP classification is at 230V(400V) only in accordance with EN-14825. For heating, SCOP indicates the value of only Average heating season.

\*7 H: High at setting 5 stage (Level 5), M: Middle at setting 5 stage (Level 3), L: Low at setting 5 stage (Level 1)

# Single -Type

## 1-1. Unit Specifications

### PEY2

#### 7. 4-Way Cassette Type S-71PU2E5A / U-71PEY2E5

| INDOOR   | MODEL                                    | S-71PU2E5A  |                                   |            | -                                   |            |            | -      |      |        |
|--|--|---|-----------------------------------|------------|-------------------------------------|------------|------------|--------|------|--------|
| PANEL  | MODEL                                    | Standard type:CZ-KPU3:ECONAVI type:CZ-KPU3A                     |                                   |            | -                                   |            |            | -      |      |        |
| OUTDOOR  | MODEL                                    | -   |                                   |            | U-71PEY2E5                          |            |            | -      |      |        |
| Branch pipe  | MODEL                                    | -   |                                   |            | -                                   |            |            | -      |      |        |
| Performance test condition                               |  | ISO5151 / EN14511 / EN12102 / EN14825                           |                                   |            |                                     |            |            |        |      |        |
| C<br>O<br>O<br>L<br>I<br>N<br>G                          | Power supply                             | Ø, Hz   | 1Ø 50Hz                           |            |                                     | 1Ø 50Hz    |            |        | Min  | Max    |
|  |  | V   | 220V                              | 230V       | 240V                                | 220V       | 230V       | 240V   |      |        |
|  | Capacity                                 | kW  | 7.1                               | 7.1        | 7.1                                 | -          | -          | -      | 2.0  | 7.7    |
|  |  | BTU/h   | 24200                             | 24200      | 24200                               | -          | -          | -      | 6800 | 26300  |
|  | Current                                  | A   | 0.40                              | 0.39       | 0.38                                | 10.7       | 10.3       | 9.85   | -    | -      |
|  |  | W   | 42                                | 42         | 42                                  | 2.148k     | 2.148k     | 2.148k | -    | -      |
|  | Input power                              | TOTAL W   | -                                 | -          | -                                   | 2.190k     | 2.190k     | 2.190k | 250  | 2.650k |
|  |  | Annual consumption  | TOTAL kWh *4                      | -          | -                                   | -          | -          | 1095   | -    | -      |
|  | EER/EER CLASS                            | TOTAL (W/W) <sup>5/</sup> ("A"-G)                               | -                                 | -          | -                                   | 3.24       | 3.24/A     | 3.24   | 8.00 | 2.91   |
|  | Erp <sup>6/</sup>                        | Pdesign   | kW                                | -          | -                                   | -          | -          | 7.1    | -    | -      |
|  |  | SEER  | (W/W)                             | -          | -                                   | -          | -          | 6.5    | -    | -      |
|  |  | Annual consumption  | kWh                               | -          | -                                   | -          | -          | 382    | -    | -      |
|  |  | Class   |                                   | -          | -                                   | -          | -          | A++    | -    | -      |
|  | Power factor                             | %   | -                                 | -          | -                                   | 91         | 91         | 91     | -    | -      |
| Noise indoor   | dB-A (H/M/L) *7                          | 37/31/28  |                                   |            | -                                   |            |            | -      | -    |        |
|  | Power Level dB                           | 52/46/43  |                                   |            | -                                   |            |            | -      | -    |        |
| Noise outdoor  | dB-A (H/L)                               | -   |                                   |            | 49/-                                |            |            | -      | -    |        |
|  | Power Level dB                           | -   |                                   |            | 69/-                                |            |            | -      | -    |        |
| H<br>E<br>A<br>T<br>I<br>N<br>G                          | Capacity                                 | kW  | 7.1                               | 7.1        | 7.1                                 | -          | -          | -      | 1.8  | 8.1    |
|  |  | BTU/h   | 24200                             | 24200      | 24200                               | -          | -          | -      | 6100 | 27600  |
|  | Current                                  | A   | 0.39                              | 0.38       | 0.37                                | 8.50       | 8.10       | 7.80   | -    | -      |
|  |  | W   | 40                                | 40         | 40                                  | 1.680k     | 1.680k     | 1.680k | -    | -      |
|  | Input power                              | TOTAL W   | -                                 | -          | -                                   | 1.720k     | 1.720k     | 1.720k | 200  | 2.200k |
|  |  | COP/COP CLASS   | TOTAL (W/W) <sup>5/</sup> ("A"-G) | -          | -                                   | -          | 4.13       | 4.13/A | 4.13 | 9.00   |
|  | Erp <sup>6/</sup>                        | Pdesign at -10°C  | kW                                | -          | -                                   | -          | -          | 6.0    | -    | -      |
|  |  | Tbivalent   | °C                                | -          | -                                   | -          | -          | -8     | -    | -      |
|  |  | SCOP  | (W/W)                             | -          | -                                   | -          | -          | 4.2    | -    | -      |
|  |  | Annual consumption  | kWh                               | -          | -                                   | -          | -          | 2002   | -    | -      |
|  | Class                                    |   | -                                 | -          | -                                   | -          | A+         | -      | -    |        |
|  | Power factor                             | %   | -                                 | -          | -                                   | 90         | 90         | 90     | -    | -      |
|  | Noise indoor                             | dB-A (H/M/L) *7   | 37/31/28                          |            |                                     | -          |            |        | -    | -      |
|  |  | Power Level dB  | 52/46/43                          |            |                                     | -          |            |        | -    | -      |
| Noise outdoor  | dB-A (H/L)                               | -   |                                   |            | 49/-                                |            |            | -      | -    |        |
|  | Power Level dB                           | -   |                                   |            | 69/-                                |            |            | -      | -    |        |
| EXTRA LOW TEMP Total capacity(kW) / Input power(W) / COP |  | -   |                                   |            |                                     |            |            |        |      |        |
| Max Current(A) / Max Input power(W)                      |  | 0.40/42   | 0.39/42                           | 0.38/42    | 16.5/3.27k                          | 16.5/3.42k | 16.5/3.57k | -      |      |        |
| Starting current(A) / Comp output(W)                     |  | -   | -                                 | -          | 10.7/2.0k                           | 10.3/2.0k  | 9.85/2.0k  | -      |      |        |
| Network Impedance(ΩMAX.)                                 |  | -   |                                   |            |                                     |            |            |        |      |        |
| Fan motor output (Indoor/Outdoor) W                      |  | 60  |                                   |            | 60                                  |            |            | -      |      |        |
| Moisture removal volume                                  |  | L/h(Pt/h)   | 2.5                               | (5.3)      | -                                   |            |            | -      |      |        |
| External static pressure                                 |  | Pa  | -                                 |            |                                     | -          |            |        | -    |        |
| Indoor Air flow *7                                       | Cooling                                  | m³/min (ft³/min)  | 22.0/16.0/13.0 (777)/(565)/(459)  |            |                                     | -          |            |        | -    | -      |
|  | Heating                                  | m³/min (ft³/min)  | 22.0/16.0/13.0 (777)/(565)/(459)  |            |                                     | -          |            |        | -    | -      |
| Outdoor Air flow   | Cooling                                  | m³/min (ft³/min)  | -                                 |            |                                     | 44 (1554)  |            |        | -    | -      |
|  | Heating                                  | m³/min (ft³/min)  | -                                 |            |                                     | 41 (1448)  |            |        | -    | -      |
| Refrigerant type / amount g(oz)                          |  | -   |                                   |            | R410A 1.95k (68.8)                  |            |            | -      |      |        |
| Product dimension  | Height                                   | mm(inch)  | 256                               | (10-5/64)  | 619                                 | (24-3/8)   | -          |        |      |        |
|  | Width                                    | mm(inch)  | 840                               | (33-5/64)  | 799                                 | (31-29/64) | -          |        |      |        |
|  | Depth                                    | mm(inch)  | 840                               | (33-5/64)  | 299                                 | (11-49/64) | -          |        |      |        |
| Product dimension (Panel)                                |  | H×W×D mm, inch  | 33.5×950×950                      |            | 1-11/32 × 37-13/32 × 37-13/32       |            | -          |        |      |        |
| Packing dimension  | Height                                   | mm(inch)  | 302                               | (11-57/64) | 688                                 |            |            | -      |      |        |
|  | Width                                    | mm(inch)  | 898                               | (35-3/8)   | 931                                 |            |            | -      |      |        |
|  | Depth                                    | mm(inch)  | 898                               | (35-3/8)   | 422                                 |            |            | -      |      |        |
| Weight   | (NET)                                    | kg(lb)  | 20                                | (44)       | 40                                  | (88)       | -          |        |      |        |
|  | (GROSS)                                  | kg(lb)  | 27                                | (60)       | 45                                  | (99)       | -          |        |      |        |
|  | Panel (NET)                              | kg(lb)  | 5                                 | (11)       | -                                   |            |            | -      |      |        |
| Layers limit (actually)                                  |  | 11 (12)   |                                   |            | 5 (6)                               |            |            | -      |      |        |
| Operation condition                                      | Cool (DBT)                               | 18°C ~ 32°C   |                                   |            | -10°C ~ 43°C                        |            |            | -      |      |        |
|  | Heat (DBT)                               | 16°C ~ 30°C   |                                   |            | -15°C ~ 24°C                        |            |            | -      |      |        |
| P<br>I<br>P<br>I<br>N<br>G                               | Pipe diameter mm (inch)                  | (Liquid)Ø9.52(3/8) (Gas)Ø15.88(5/8)                             |                                   |            | (Liquid)Ø9.52(3/8) (Gas)Ø15.88(5/8) |            |            | -      |      |        |
|  | Connecting method, Standard length m(ft) | flared type, 5.0(16.4)  |                                   |            | flared type, 5.0(16.4)              |            |            | -      |      |        |
| Pipe length range  |  | m (ft) 3 ~ 40m (9.8 ~ 131.2)                                    |                                   |            |                                     |            |            |        |      |        |
| Indoor unit & Outdoor unit height difference             |  | m (ft) 15m(OD located lower)/30m(OD located higher) (49.2/98.4) |                                   |            |                                     |            |            |        |      |        |
| Add gas amount   |  | g/m (oz/ft) 40g (0.430)   |                                   |            |                                     |            |            |        |      |        |
| Pipe length for additional gas                           |  | m (ft) 30m (98.4)   |                                   |            |                                     |            |            |        |      |        |

\*1 In case it is necessary to indicate the air flow volume in (l/s), the value in (m³/min.) shall be multiplied by 16.7 and rounded down the decimal point.

\*2 If the EUROVENT Certified models can be operated under the "extra-low" temperature condition, -7°C dry bulb and -8°C wet-bulb temperatures with rated voltage 230V shall be used.

\*3 Network Impedance shall be applicable for EUROPE and CHINA models.

\*4 The annual consumption is calculated by multiplying the input power at 230V(400V) by an average of 500 hours per year in cooling mode.

\*5 EER and COP classification is at 230V(400V) only in accordance with EU directive 2002/31/EC.

\*6 SEER and SCOP classification is at 230V(400V) only in accordance with EN-14825. For heating, SCOP indicates the value of only Average heating season, Other fiche data indicates in an attached sheet

\*7 H: High at setting 5 stage (Level 5), M: Middle at setting 5 stage (Level 3), L: Low at setting 5 stage (Level 1)

# Single -Type

## 1-1. Unit Specifications

**PEY1**

### 7. 4-Way Cassette Type S-100PU2E5A / U-100PEY1E5

| INDOOR   |  | MODEL              | S-100PU2E5A                                 |  |                               | -                                   |                |              | -      |      |        |
|--|--|--------------------|---|--|-------------------------------|-------------------------------------|----------------|--------------|--------|------|--------|
| PANEL  |  | MODEL              | Standard type:CZ-KPU3:ECONAVI type:CZ-KPU3A |  |                               | -                                   |                |              | -      |      |        |
| OUTDOOR  |  | MODEL              | -   |  |                               | U-100PEY1E5                         |                |              | -      |      |        |
| Branch pipe  |  | MODEL              | -   |  |                               | -                                   |                |              | -      |      |        |
| Performance test condition                               |  |                    | ISO5151 / EN14511 / EN12102 / EN14825       |  |                               |                                     |                |              |        |      |        |
| C<br>O<br>O<br>L<br>I<br>N<br>G                          | Power supply                             |                    | 1Ø 50Hz                                     |  |                               | 1Ø 50Hz                             |                |              |        |      |        |
|  |  |                    | Ø, Hz                                       |  |                               |                                     |                |              |        |      |        |
|  |  |                    | V   | 220V   | 230V                          | 240V                                | 220V           | 230V         | 240V   | Min  | Max    |
|  | Capacity                                 |                    | kW  | 10.0   | 10.0                          | 10.0                                | -              | -            | -      | 2.7  | 11.5   |
|  |  |                    | BTU/h                                       | 34100  | 34100                         | 34100                               | -              | -            | -      | 9200 | 39200  |
|  | Current                                  |                    | A   | 0.82   | 0.79                          | 0.76                                | 14.8           | 14.2         | 13.6   | -    | -      |
|  | Input power                              |                    | W   | 100  | 100                           | 100                                 | 3.060k         | 3.060k       | 3.060k | -    | -      |
|  |  |                    | TOTAL W                                     | -  | -                             | -                                   | 3.160k         | 3.160k       | 3.160k | 530  | 4.200k |
|  | Annual consumption                       |                    | TOTAL kWh *4                                | -  | -                             | -                                   | -              | 1580         | -      | -    | -      |
|  | EER/EER CLASS                            |                    | TOTAL (W/W) <sup>5/7</sup> ("A"-G)          | -  | -                             | -                                   | 3.16           | 3.16/B       | 3.16   | 5.09 | 2.74   |
|  | E<br>r<br>p<br>*6                        | Pdesign            |   | kW   | -                             | -                                   | -              | 10.0         | -      | -    | -      |
|  |  | SEER               |   | (W/W)  | -                             | -                                   | -              | -            | 6.7    | -    | -      |
|  |  | Annual consumption |   | kWh  | -                             | -                                   | -              | -            | 522    | -    | -      |
|  |  | Class              |   |  | -                             | -                                   | -              | -            | A++    | -    | -      |
| Power factor   |  | %                  | -   | -  | -                             | 94                                  | 94             | 94           | -      | -    |        |
| Noise indoor   |  | dB-A (H/M/L) *7    | 45/38/32                                    |  |                               | -                                   |                |              | -      | -    |        |
|  |  | Power Level dB     | 60/53/47                                    |  |                               | -                                   |                |              | -      | -    |        |
| Noise outdoor  |  | dB-A (H/L)         | -   |  |                               | 54/-                                |                |              | -      | -    |        |
|  |  | Power Level dB     | -   |  |                               | 70/-                                |                |              | -      | -    |        |
| H<br>E<br>A<br>T<br>I<br>N<br>G                          | Capacity                                 |                    | kW  | 10.0   | 10.0                          | 10.0                                | -              | -            | -      | 2.1  | 13.8   |
|  |  |                    | BTU/h                                       | 34100  | 34100                         | 34100                               | -              | -            | -      | 7200 | 47100  |
|  | Current                                  |                    | A   | 0.81   | 0.78                          | 0.75                                | 11.0           | 10.6         | 10.2   | -    | -      |
|  | Input power                              |                    | W   | 95   | 95                            | 95                                  | 2.315k         | 2.315k       | 2.315k | -    | -      |
|  |  |                    | TOTAL W                                     | -  | -                             | -                                   | 2.410k         | 2.410k       | 2.410k | 410  | 4.000k |
|  | COP/COP CLASS                            |                    | TOTAL (W/W) <sup>5/7</sup> ("A"-G)          | -  | -                             | -                                   | 4.15           | 4.15/A       | 4.15   | 5.12 | 3.45   |
|  | E<br>r<br>p<br>*6                        | Pdesign at -10°C   |   | kW   | -                             | -                                   | -              | 10.0         | -      | -    | -      |
|  |  | Tbivalent          |   | °C   | -                             | -                                   | -              | -            | -8     | -    | -      |
|  |  | SCOP               |   | (W/W)  | -                             | -                                   | -              | -            | 4.3    | -    | -      |
|  |  | Annual consumption |   | kWh  | -                             | -                                   | -              | -            | 3256   | -    | -      |
|  | Class                                    |                    |   | -  | -                             | -                                   | -              | A+           | -      | -    |        |
|  | Power factor                             |                    | %   | -  | -                             | -                                   | 96             | 95           | 95     | -    | -      |
|  | Noise indoor                             |                    | dB-A (H/M/L) *7                             | 45/38/32   |                               |                                     | -              |              |        | -    | -      |
|  |  |                    | Power Level dB                              | 60/53/47   |                               |                                     | -              |              |        | -    | -      |
| Noise outdoor  |  | dB-A (H/L)         | -   |  |                               | 54/-                                |                |              | -      | -    |        |
|  |  | Power Level dB     | -   |  |                               | 70/-                                |                |              | -      | -    |        |
| EXTRA LOW TEMP Total capacity(kW) / Input power(W) / COP |  |                    | -   |  |                               |                                     |                |              |        | -    |        |
| Max Current(A) / Max Input power(W)                      |  |                    | 0.82/100                                    | 0.79/100   | 0.76/100                      | 25.0 / 5.30k                        | 25.0 / 5.50k   | 25.0 / 5.70k | -      |      |        |
| Starting current(A) / Comp output(W)                     |  |                    | -   | -  | -                             | 14.8 / 1.7k                         | 14.2 / 1.7k    | 13.6 / 1.7k  | -      |      |        |
| Network Impedance(ΩMAX.)                                 |  |                    | -   |  |                               |                                     |                |              |        | -    |        |
| Fan motor output (Indoor/Outdoor) W                      |  |                    | 90  |  |                               | 90                                  |                |              | -      |      |        |
| Moisture removal volume                                  |  |                    | L/h(Pt/h)                                   |  | 2.7                           | (5.7)                               |                | -            |        |      |        |
| External static pressure                                 |  |                    | Pa  |  | -                             |                                     |                | -            |        |      |        |
| Indoor Air flow *7                                       | Cooling                                  | m³/min (ft³/min)   | 36.0/26.0/18.0 (1271)/(918)/(636)           |  |                               | -                                   |                |              | -      | -    |        |
|  | Heating                                  | m³/min (ft³/min)   | 36.0/26.0/18.0 (1271)/(918)/(636)           |  |                               | -                                   |                |              | -      | -    |        |
| Outdoor Air flow   | Cooling                                  | m³/min (ft³/min)   | -   |  |                               | 76 (2684)                           |                |              | -      | -    |        |
|  | Heating                                  | m³/min (ft³/min)   | -   |  |                               | 67 (2366)                           |                |              | -      | -    |        |
| Refrigerant type / amount g(oz)                          |  |                    | -   |  |                               | R410A 2.60k (91.7)                  |                |              | -      |      |        |
| Product dimension  |  | Height mm(inch)    | 319   |  | (12-9/16)                     |                                     | 996 (39-7/32)  |              | -      |      |        |
|  |  | Width mm(inch)     | 840   |  | (33-5/64)                     |                                     | 940 (37-1/32)  |              | -      |      |        |
|  |  | Depth mm(inch)     | 840   |  | (33-5/64)                     |                                     | 340 (13-13/32) |              | -      |      |        |
| Product dimension (Panel)                                |  | H×W×D mm, inch     | 33.5×950×950                                |  | 1-11/32 × 37-13/32 × 37-13/32 |                                     | -              |              | -      |      |        |
| Packing dimension  |  | Height mm(inch)    | 365   |  | (14-3/8)                      |                                     | 1136           |              | -      |      |        |
|  |  | Width mm(inch)     | 898   |  | (35-3/8)                      |                                     | 1055           |              | -      |      |        |
|  |  | Depth mm(inch)     | 898   |  | (35-3/8)                      |                                     | 485            |              | -      |      |        |
| Weight   |  | (NET) kg(lb)       | 25  |  | (44)                          |                                     | 73             |              | (161)  |      |        |
|  |  | (GROSS) kg(lb)     | 32  |  | (71)                          |                                     | 81             |              | (179)  |      |        |
|  |  | Panel (NET) kg(lb) | 5   |  | (11)                          |                                     | -              |              | -      |      |        |
| Layers limit (actually)                                  |  |                    | 11 (12)                                     |  |                               | 2 (3)                               |                |              | -      |      |        |
| Operation condition                                      |  | Cool (DBT)         | 18°C ~ 32°C                                 |  |                               | -10°C ~ 43°C                        |                |              | -      |      |        |
|  |  | Heat (DBT)         | 16°C ~ 30°C                                 |  |                               | -15°C ~ 24°C                        |                |              | -      |      |        |
| P<br>I<br>P<br>I<br>N<br>G                               | Pipe diameter mm (inch)                  |                    | (Liquid)Ø9.52(3/8) (Gas)Ø15.88(5/8)         |  |                               | (Liquid)Ø9.52(3/8) (Gas)Ø15.88(5/8) |                |              | -      |      |        |
|  | Connecting method, Standard length m(ft) |                    | flared type, 5.0(16.4)                      |  |                               | flared type, 5.0(16.4)              |                |              | -      |      |        |
| Pipe length range  |  | m (ft)             |   | 5 ~ 50m (16.4 ~164)                                      |                               |                                     |                |              |        | -    |        |
| Indoor unit & Outdoor unit height difference             |  | m (ft)             |   | 15m(OD located lower)/30m(OD located higher) (49.2/98.4) |                               |                                     |                |              |        | -    |        |
| Add gas amount   |  | g/m (oz/ft)        |   | 50g (0.538)  |                               |                                     |                |              |        | -    |        |
| Pipe length for additional gas                           |  | m (ft)             |   | 30m (98.4)   |                               |                                     |                |              |        | -    |        |

\*1 In case it is necessary to indicate the air flow volume in (l/s), the value in (m³/min.) shall be multiplied by 16.7 and rounded down the decimal point.  
 \*2 If the EUROVENT Certified models can be operated under the "extra-low"temperature condition, -7°C dry bulb and -8°C wet-bulb temperatures with rated voltage 230V shall be used.  
 \*3 Network Impedance shall be applicable for EUROPE and CHINA models.  
 \*4 The annual consumption is calculated by multiplying the input power at 230V(400V) by an average of 500 hours per year in cooling mode.  
 \*5 EER and COP classification is at 230V(400V) only in accordance with EU directive 2002/31/EC.  
 \*6 SEER and SCOP classification is at 230V(400V) only in accordance with EN-14825. For heating, SCOP indicates the value of only Average heating season, Other fiche data indicates in an attached sheet  
 \*7 H: High at setting 5 stage (Level 5), M: Middle at setting 5 stage (Level 3), L: Low at setting 5 stage (Level 1)

# Single -Type

## 1-1. Unit Specifications

**PEY1**

### 7. 4-Way Cassette Type S-125PU2E5A / U-125PEY1E5

| INDOOR  |                    | MODEL  | S-125PU2E5A                                 |           |                                     | -              |              |        | -      |       |        |
|---|--------------------|--|---|-----------|-------------------------------------|----------------|--------------|--------|--------|-------|--------|
| PANEL   |                    | MODEL  | Standard type:CZ-KPU3:ECONAVI type:CZ-KPU3A |           |                                     | -              |              |        | -      |       |        |
| OUTDOOR   |                    | MODEL  | -   |           |                                     | U-125PEY1E5    |              |        | -      |       |        |
| Branch pipe   |                    | MODEL  | -   |           |                                     | -              |              |        | -      |       |        |
| Performance test condition                          |                    | ISO5151 / EN14511 / EN12102 / EN14825                    |   |           |                                     |                |              |        |        |       |        |
| C<br>O<br>O<br>L<br>I<br>N<br>G                     | Power supply       |  | 1Ø 50Hz                                     |           |                                     | 1Ø 50Hz        |              |        |        |       |        |
|   |                    |  | Ø, Hz                                       |           |                                     |                |              |        |        |       |        |
|   |                    |  | V   | 220V      | 230V                                | 240V           | 220V         | 230V   | 240V   | Min   | Max    |
|   | Capacity           |  | kW  | 12.5      | 12.5                                | 12.5           | -            | -      | -      | 3.8   | 13.5   |
|   |                    |  | BTU/h                                       | 42700     | 42700                               | 42700          | -            | -      | -      | 13000 | 46100  |
|   | Current            |  | A   | 0.91      | 0.88                                | 0.85           | 18.8         | 18.0   | 17.2   | -     | -      |
|   | Input power        |  | W   | 110       | 110                                 | 110            | 3.850k       | 3.850k | 3.850k | -     | -      |
|   |                    |  | TOTAL W                                     | -         | -                                   | -              | 3.960k       | 3.960k | 3.960k | 900   | 4.880k |
|   | Annual consumption |  | TOTAL kWh *4                                | -         | -                                   | -              | -            | 1980   | -      | -     | -      |
|   | EER/EER CLASS      |  | TOTAL (W/W) *5 / ("A"-G)                    | -         | -                                   | -              | 3.16         | 3.16/B | 3.16   | 4.22  | 2.77   |
| E<br>r<br>p<br>*6                                   | Pdesign            |  | kW  | -         | -                                   | -              | 12.5         | -      | -      | -     |        |
|   | η <sub>s.c</sub>   |  | %   | -         | -                                   | -              | 245.9        | -      | -      | -     |        |
|   | Annual consumption |  | kWh   | -         | -                                   | -              | -            | -      | -      | -     |        |
|   | Class              |  |   | -         | -                                   | -              | -            | -      | -      | -     |        |
| Power factor  |                    | %  | -   | -         | -                                   | 93             | 93           | 93     | -      | -     |        |
| Noise indoor  |                    | dB-A (H/M/L) *7  |   | 46/39/33  |                                     |                | -            |        |        | -     |        |
|   |                    | Power Level dB   |   | 61/54/48  |                                     |                | -            |        |        | -     |        |
| Noise outdoor                                       |                    | dB-A (H/L)   |   | -         |                                     |                | 56/-         |        |        | -     |        |
|   |                    | Power Level dB   |   | -         |                                     |                | 73/-         |        |        | -     |        |
| H<br>E<br>A<br>T<br>I<br>N<br>G                     | Capacity           |  | kW  | 12.5      | 12.5                                | 12.5           | -            | -      | -      | 3.4   | 15.0   |
|   |                    |  | BTU/h                                       | 42700     | 42700                               | 42700          | -            | -      | -      | 11600 | 51200  |
|   | Current            |  | A   | 0.90      | 0.87                                | 0.84           | 14.3         | 13.6   | 13.1   | -     | -      |
|   | Input power        |  | W   | 105       | 105                                 | 105            | 2.945k       | 2.945k | 2.945k | -     | -      |
|   |                    |  | TOTAL W                                     | -         | -                                   | -              | 3.050k       | 3.050k | 3.050k | 730   | 4.400k |
|   | COP/COP CLASS      |  | TOTAL (W/W) *5 / ("A"-G)                    | -         | -                                   | -              | 4.10         | 4.10/A | 4.10   | 4.66  | 3.41   |
|   | E<br>r<br>p<br>*6  | Pdesign at -10°C   |   | kW        | -                                   | -              | -            | 12.5   | -      | -     | -      |
|   |                    | Tbivalent  |   | °C        | -                                   | -              | -            | -7     | -      | -     | -      |
|   |                    | η <sub>s.h</sub>   |   | %         | -                                   | -              | -            | 151.8  | -      | -     | -      |
|   |                    | Annual consumption                                       |   | kWh       | -                                   | -              | -            | -      | -      | -     | -      |
| Class   |                    |  | -   | -         | -                                   | -              | -            | -      | -      |       |        |
| Power factor  |                    | %  | -   | -         | -                                   | 94             | 94           | 94     | -      | -     |        |
| Noise indoor  |                    | dB-A (H/M/L) *7  |   | 46/39/33  |                                     |                | -            |        |        | -     |        |
|   |                    | Power Level dB   |   | 61/54/48  |                                     |                | -            |        |        | -     |        |
| Noise outdoor                                       |                    | dB-A (H/L)   |   | -         |                                     |                | 56/-         |        |        | -     |        |
|   |                    | Power Level dB   |   | -         |                                     |                | 73/-         |        |        | -     |        |
| EXTRA LOW TEMP                                      |                    | Total capacity(kW) / Input power(W) / COP                |   |           |                                     |                |              |        |        |       |        |
| Max Current(A) / Max Input power(W)                 |                    | 0.91/110   | 0.88/110                                    | 0.85/110  | 29.0 / 6.00k                        | 29.0 / 6.30k   | 29.0 / 6.60k | -      |        |       |        |
| Starting current(A) / Comp output(W)                |                    | -  | -   | -         | 18.8 / 3.0k                         | 18.0 / 3.0k    | 17.2 / 3.0k  | -      |        |       |        |
| Network Impedance(ΩMAX.)                            |                    | -  |   |           |                                     |                |              |        |        |       |        |
| Fan motor output (Indoor/Outdoor) W                 |                    | 90   |   |           | 90                                  |                |              | -      |        |       |        |
| Moisture removal volume                             |                    | L/h(Pt/h)  | 4.8   | (10.1)    |                                     | -              |              |        | -      |       |        |
| External static pressure                            |                    | Pa   | -   |           |                                     | -              |              |        | -      |       |        |
| Indoor Air flow *7                                  | Cooling            | m³/min (ft³/min)   | 37.0/27.0/19.0 (1307)/(953)/(671)           |           |                                     | -              |              |        | -      |       |        |
|   | Heating            | m³/min (ft³/min)   | 37.0/27.0/19.0 (1307)/(953)/(671)           |           |                                     | -              |              |        | -      |       |        |
| Outdoor Air flow                                    | Cooling            | m³/min (ft³/min)   | -   |           |                                     | 80 (2825)      |              |        | -      |       |        |
|   | Heating            | m³/min (ft³/min)   | -   |           |                                     | 73 (2578)      |              |        | -      |       |        |
| Refrigerant type / amount g(oz)                     |                    | -  |   |           | R410A 3.20k (112.9)                 |                |              | -      |        |       |        |
| Product dimension                                   |                    | Height mm(inch)  | 319   | (12-9/16) |                                     | 996 (39-7/32)  |              |        | -      |       |        |
|   |                    | Width mm(inch)   | 840   | (33-5/64) |                                     | 940 (37-1/32)  |              |        | -      |       |        |
|   |                    | Depth mm(inch)   | 840   | (33-5/64) |                                     | 340 (13-13/32) |              |        | -      |       |        |
| Product dimension (Panel)                           |                    | H×W×D mm, inch   | 33.5×950×950                                |           | 1-11/32 × 37-13/32 × 37-13/32       |                | -            |        |        |       |        |
| Packing dimension                                   |                    | Height mm(inch)  | 365   | (14-3/8)  |                                     | 1136           |              |        | -      |       |        |
|   |                    | Width mm(inch)   | 898   | (35-3/8)  |                                     | 1055           |              |        | -      |       |        |
|   |                    | Depth mm(inch)   | 898   | (35-3/8)  |                                     | 485            |              |        | -      |       |        |
| Weight  |                    | (NET) kg(lb)   | 25  | (55)      |                                     | 85             | (187)        |        | -      |       |        |
|   |                    | (GROSS) kg(lb)   | 32  | (71)      |                                     | 93             | (205)        |        | -      |       |        |
|   |                    | Panel (NET) kg(lb)                                       | 5   | (11)      |                                     | -              |              |        | -      |       |        |
| Layers limit (actually)                             |                    | 11 (12)  |   |           | 2 (3)                               |                |              | -      |        |       |        |
| Operation condition                                 |                    | Cool (DBT)   | 18°C ~ 32°C                                 |           |                                     | -10°C ~ 43°C   |              |        | -      |       |        |
|   |                    | Heat (DBT)   | 16°C ~ 30°C                                 |           |                                     | -15°C ~ 24°C   |              |        | -      |       |        |
| Pipe diameter mm (inch)                             |                    | (Liquid)Ø9.52(3/8) (Gas)Ø15.88(5/8)                      |   |           | (Liquid)Ø9.52(3/8) (Gas)Ø15.88(5/8) |                |              | -      |        |       |        |
| Connecting method, Standard length m(ft)            |                    | flared type, 5.0(16.4)                                   |   |           | flared type, 5.0(16.4)              |                |              | -      |        |       |        |
| Pipe length range m (ft)                            |                    | 5 ~ 50m (16.4 ~164)                                      |   |           | -                                   |                |              | -      |        |       |        |
| Indoor unit & Outdoor unit height difference m (ft) |                    | 15m(OD located lower)/30m(OD located higher) (49.2/98.4) |   |           | -                                   |                |              | -      |        |       |        |
| Add gas amount g/m (oz/ft)                          |                    | 50g (0.538)  |   |           | -                                   |                |              | -      |        |       |        |
| Pipe length for additional gas m (ft)               |                    | 30m (98.4)   |   |           | -                                   |                |              | -      |        |       |        |

\*1 In case it is necessary to indicate the air flow volume in (l/s), the value in (m³/min.) shall be multiplied by 16.7 and rounded down the decimal point.

\*2 If the EUROVENT Certified models can be operated under the "extra-low" temperature condition, -7°C dry bulb and -8°C wet-bulb temperatures with rated voltage 230V shall be used.

\*3 Network Impedance shall be applicable for EUROPE and CHINA models.

\*4 The annual consumption is calculated by multiplying the input power at 230V(400V) by an average of 500 hours per year in cooling mode.

\*5 EER and COP classification is at 230V(400V) only in accordance with EU directive 2002/31/EC.

\*6 SEER and SCOP classification is at 230V(400V) only in accordance with EN-14825. For heating, SCOP indicates the value of only Average heating season.

\*7 H: High at setting 5 stage (Level 5), M: Middle at setting 5 stage (Level 3), L: Low at setting 5 stage (Level 1)

# Simultaneous (Twin) -Type

## 1-1. Unit Specifications

**PEY1**

### 7. 4-Way Cassette Type S-50PU2E5A×2 / U-100PEY1E8

| INDOOR   |  | MODEL  | S-50PU2E5A ×2                                       |               |                                     | -              |              |        | -      |      |        |
|--|--|--|---|---------------|-------------------------------------|----------------|--------------|--------|--------|------|--------|
| PANEL  |  | MODEL  | Standard type:CZ-KPU3 ×2 / ECONAVI type:CZ-KPU3A ×2 |               |                                     | -              |              |        | -      |      |        |
| OUTDOOR  |  | MODEL  | -   |               |                                     | U-100PEY1E8    |              |        | -      |      |        |
| Branch pipe  |  | MODEL  | -   |               |                                     | CZ-P155BK1     |              |        | -      |      |        |
| Performance test condition                                 |  | ISO5151 / EN14511 / EN12102 / EN14825                    |   |               |                                     |                |              |        |        |      |        |
| C<br>O<br>O<br>L<br>I<br>N<br>G                            | Power supply                             |  | 1Ø 50Hz   |               |                                     | 3Ø 50Hz        |              |        |        |      |        |
|  |  |  | Ø, Hz   |               |                                     |                |              |        |        |      |        |
|  |  |  | V   | 220V          | 230V                                | 240V           | 380V         | 400V   | 415V   | Min  | Max    |
|  | Capacity                                 |  | kW  | 10.0          | 10.0                                | 10.0           | -            | -      | -      | 2.7  | 11.5   |
|  |  |  | BTU/h   | 34100         | 34100                               | 34100          | -            | -      | -      | 9200 | 39200  |
|  | Current                                  |  | A   | 0.27 ×2       | 0.26 ×2                             | 0.25 ×2        | 5.05         | 4.80   | 4.65   | -    | -      |
|  | Input power                              |  | W   | 29 ×2         | 29 ×2                               | 29 ×2          | 3.102k       | 3.102k | 3.102k | -    | -      |
|  |  |  | TOTAL W   | -             | -                                   | -              | 3.160k       | 3.160k | 3.160k | 530  | 4.200k |
|  | Annual consumption                       |  | TOTAL kWh *4  | -             | -                                   | -              | -            | 1580   | -      | -    | -      |
|  | EER/EER CLASS                            |  | TOTAL (W/W) <sup>7</sup> ("A"-G)                    | -             | -                                   | -              | 3.16         | 3.16/B | 3.16   | 5.09 | 2.74   |
|  | E<br>r<br>p<br>*6                        | Pdesign  | kW  | -             | -                                   | -              | -            | 10.0   | -      | -    | -      |
|  |  | SEER   | (W/W)   | -             | -                                   | -              | -            | 6.5    | -      | -    | -      |
|  |  | Annual consumption                                       | kWh   | -             | -                                   | -              | -            | 538    | -      | -    | -      |
|  |  | Class  |   | -             | -                                   | -              | -            | A++    | -      | -    | -      |
| Power factor   |  | %  | -   | -             | -                                   | 93             | 93           | 93     | -      | -    |        |
| Noise indoor   | dB-A (H/M/L) *7                          |  | 32/29/27  |               |                                     | -              |              |        | -      |      |        |
|  | Power Level dB                           |  | 47/44/42  |               |                                     | -              |              |        | -      |      |        |
| Noise outdoor  | dB-A (H/L)                               |  | -   |               |                                     | 54/-           |              |        | -      |      |        |
|  | Power Level dB                           |  | -   |               |                                     | 70/-           |              |        | -      |      |        |
| H<br>E<br>A<br>T<br>I<br>N<br>G                            | Capacity                                 |  | kW  | 10.0          | 10.0                                | 10.0           | -            | -      | -      | 2.1  | 13.8   |
|  |  |  | BTU/h   | 34100         | 34100                               | 34100          | -            | -      | -      | 7200 | 47100  |
|  | Current                                  |  | A   | 0.26 ×2       | 0.25 ×2                             | 0.24 ×2        | 3.85         | 3.65   | 3.55   | -    | -      |
|  | Input power                              |  | W   | 27 ×2         | 27 ×2                               | 27 ×2          | 2.356k       | 2.356k | 2.356k | -    | -      |
|  |  |  | TOTAL W   | -             | -                                   | -              | 2.410k       | 2.410k | 2.410k | 410  | 4.000k |
|  | COP/COP CLASS                            |  | TOTAL (W/W) <sup>7</sup> ("A"-G)                    | -             | -                                   | -              | 4.15         | 4.15/A | 4.15   | 5.12 | 3.45   |
|  | E<br>r<br>p<br>*6                        | Pdesign at -10°C   | kW  | -             | -                                   | -              | -            | 10.0   | -      | -    | -      |
|  |  | Tbivalent  | °C  | -             | -                                   | -              | -            | -8     | -      | -    | -      |
|  |  | SCOP   | (W/W)   | -             | -                                   | -              | -            | 4.3    | -      | -    | -      |
|  |  | Annual consumption                                       | kWh   | -             | -                                   | -              | -            | 3256   | -      | -    | -      |
|  | Power factor                             |  | %   | -             | -                                   | -              | 93           | 93     | 92     | -    | -      |
|  | Noise indoor                             | dB-A (H/M/L) *7  |   | 32/29/27      |                                     |                | -            |        |        | -    |        |
|  |  | Power Level dB   |   | 47/44/42      |                                     |                | -            |        |        | -    |        |
|  | Noise outdoor                            | dB-A (H/L)   |   | -             |                                     |                | 54/-         |        |        | -    |        |
| Power Level dB   |  | -  |   |               | 70/-                                |                |              | -      |        |      |        |
| EXTRA LOW TEMP   Total capacity(kW) / Input power(W) / COP |  | -  |   |               |                                     |                |              |        |        |      |        |
| Max Current(A) / Max Input power(W)                        |  | 0.27 ×2/29 ×2  | 0.26 ×2/29 ×2                                       | 0.25 ×2/29 ×2 | 9.00 / 5.55k                        | 9.00 / 5.80k   | 9.00 / 6.05k | -      |        |      |        |
| Starting current(A) / Comp output(W)                       |  | -  | -   | -             | 5.05 / 1.7k                         | 4.80 / 1.7k    | 4.65 / 1.7k  | -      |        |      |        |
| Network Impedance(QMAX.)                                   |  | -  |   |               |                                     |                |              |        |        |      |        |
| Fan motor output (Indoor/Outdoor) W                        |  | 60   |   |               | 90                                  |                |              | -      |        |      |        |
| Moisture removal volume                                    |  | L/h(P/h)   | 3.2   | (1.6×2)       | (6.7)                               | -              |              |        | -      |      |        |
| External static pressure                                   |  | Pa   | -   |               |                                     | -              |              |        | -      |      |        |
| Indoor Air flow *7   | Cooling                                  | m³/min (ft³/min)   | 16.5×2/13.5×2/11.5×2 (583)×2/(477)×2/(406)×2        |               |                                     | -              |              |        | -      |      |        |
|  | Heating                                  | m³/min (ft³/min)   | 16.5×2/13.5×2/11.5×2 (583)×2/(477)×2/(406)×2        |               |                                     | -              |              |        | -      |      |        |
| Outdoor Air flow   | Cooling                                  | m³/min (ft³/min)   | -   |               |                                     | 76 (2684)      |              |        | -      |      |        |
|  | Heating                                  | m³/min (ft³/min)   | -   |               |                                     | 67 (2366)      |              |        | -      |      |        |
| Refrigerant type / amount g(oz)                            |  | -  |   |               | R410A 2.60k (91.7)                  |                |              | -      |        |      |        |
| Product dimension  | Height                                   | mm(inch)   | 256   | (10-5/64)     |                                     | 996 (39-7/32)  |              |        | -      |      |        |
|  | Width                                    | mm(inch)   | 840   | (33-5/64)     |                                     | 940 (37-1/32)  |              |        | -      |      |        |
|  | Depth                                    | mm(inch)   | 840   | (33-5/64)     |                                     | 340 (13-13/32) |              |        | -      |      |        |
| Product dimension (Panel)                                  |  | H×W×D mm, inch   | 33.5×950×950  |               | 1-11/32 × 37-13/32 × 37-13/32       |                | -            |        |        |      |        |
| Packing dimension  | Height                                   | mm(inch)   | 302   | (11-57/64)    |                                     | 1136           |              |        | -      |      |        |
|  | Width                                    | mm(inch)   | 898   | (35-3/8)      |                                     | 1055           |              |        | -      |      |        |
|  | Depth                                    | mm(inch)   | 898   | (35-3/8)      |                                     | 485            |              |        | -      |      |        |
| Weight   | (NET)                                    | kg(lb)   | 19  | (42)          |                                     | 73             | (161)        |        | -      |      |        |
|  | (GROSS)                                  | kg(lb)   | 26  | (57)          |                                     | 81             | (179)        |        | -      |      |        |
|  | Panel (NET)                              | kg(lb)   | 5   | (11)          |                                     | -              |              |        | -      |      |        |
|  | Layers limit (actually)                  |  | 11 (12)   |               |                                     | 2 (3)          |              |        | -      |      |        |
| Operation condition  | Cool (DBT)                               | 18°C ~ 32°C  |   |               | -10°C ~ 43°C                        |                |              | -      |        |      |        |
|  | Heat (DBT)                               | 16°C ~ 30°C  |   |               | -15°C ~ 24°C                        |                |              | -      |        |      |        |
| P<br>I<br>P<br>I<br>N<br>G                                 | Pipe diameter mm (inch)                  | (Liquid)Ø6.35(1/4) (Gas)Ø12.7(1/2)                       |   |               | (Liquid)Ø9.52(3/8) (Gas)Ø15.88(5/8) |                |              | -      |        |      |        |
|  | Connecting method, Standard length m(ft) | flared type, 5.0(16.4)                                   |   |               | flared type, 5.0(16.4)              |                |              | -      |        |      |        |
| Pipe length range m (ft)                                   |  | 5 ~ 50m (16.4 ~164)                                      |   |               |                                     |                |              |        |        |      |        |
| Indoor unit & Outdoor unit height difference m (ft)        |  | 15m(OD located lower)/30m(OD located higher) (49.2/98.4) |   |               |                                     |                |              |        |        |      |        |
| Add gas amount g/m (oz/ft)                                 |  | 50g (0.538)  |   |               |                                     |                |              |        |        |      |        |
| Pipe length for additional gas m (ft)                      |  | 30m (98.4)   |   |               |                                     |                |              |        |        |      |        |

\*1 In case it is necessary to indicate the air flow volume in (l/s), the value in (m³/min.) shall be multiplied by 16.7 and rounded down the decimal point.  
 \*2 If the EUROVENT Certified models can be operated under the "extra-low"temperature condition, -7°C dry bulb and -8°C wet-bulb temperatures with rated voltage 230V shall be used.  
 \*3 Network Impedance shall be applicable for EUROPE and CHINA models.  
 \*4 The annual consumption is calculated by multiplying the input power at 230V(400V) by an average of 500 hours per year in cooling mode.  
 \*5 EER and COP classification is at 230V(400V) only in accordance with EU directive 2002/31/EC.  
 \*6 SEER and SCOP classification is at 230V(400V) only in accordance with EN-14825. For heating, SCOP indicates the value of only Average heating season, Other fiche data indicates in an attached sheet  
 \*7 H: High at setting 5 stage (Level 5), M: Middle at setting 5 stage (Level 3), L: Low at setting 5 stage (Level 1)

# Simultaneous (Twin) -Type

## 1-1. Unit Specifications

**PEY1**

### 7. 4-Way Cassette Type S-60PU2E5A×2 / U-125PEY1E8

| INDOOR  |                    | MODEL                                     | S-60PU2E5A ×2  |             |                               | -                                   |              |              | -      |       |        |
|---|--------------------|---|--|-------------|-------------------------------|-------------------------------------|--------------|--------------|--------|-------|--------|
| PANEL   |                    | MODEL                                     | Standard type:CZ-KPU3 ×2 / ECONAVI type:CZ-KPU3A ×2      |             |                               | -                                   |              |              | -      |       |        |
| OUTDOOR   |                    | MODEL                                     | -  |             |                               | U-125PEY1E8                         |              |              | -      |       |        |
| Branch pipe   |                    | MODEL                                     | -  |             |                               | CZ-P155BK1                          |              |              | -      |       |        |
| Performance test condition                          |                    | ISO5151 / EN14511 / EN12102 / EN14825     |  |             |                               |                                     |              |              |        |       |        |
| C<br>O<br>O<br>L<br>I<br>N<br>G                     | Power supply       |   | 1Ø 50Hz  |             |                               | 3Ø 50Hz                             |              |              |        |       |        |
|   |                    |   | Ø, Hz  |             |                               |                                     |              |              |        |       |        |
|   |                    |   | V  | 220V        | 230V                          | 240V                                | 380V         | 400V         | 415V   | Min   | Max    |
|   | Capacity           |   | kW   | 12.5        | 12.5                          | 12.5                                | -            | -            | -      | 3.8   | 13.5   |
|   |                    |   | BTU/h  | 42700       | 42700                         | 42700                               | -            | -            | -      | 13000 | 46100  |
|   | Current            |   | A  | 0.36 ×2     | 0.35 ×2                       | 0.34 ×2                             | 6.25         | 5.95         | 5.75   | -     | -      |
|   | Input power        |   | W  | 38 ×2       | 38 ×2                         | 38 ×2                               | 3.884k       | 3.884k       | 3.884k | -     | -      |
|   |                    |   | TOTAL W  | -           |                               |                                     | 3.960k       | 3.960k       | 3.960k | 900   | 4.880k |
|   | Annual consumption |   | TOTAL kWh *4   | -           |                               |                                     | 1980         |              |        | -     | -      |
|   | EER/EER CLASS      |   | TOTAL (W/W) *5 / ("A"-G)                                 | -           |                               |                                     | 3.16         | 3.16/B       | 3.16   | 4.22  | 2.77   |
|   | Erp *6             |   | Pdesign  | -           |                               |                                     | 12.5         |              |        | -     | -      |
|   |                    |   | η <sub>s.c</sub>   | -           |                               |                                     | 248.0        |              |        | -     | -      |
|   |                    |   | Annual consumption                                       | -           |                               |                                     | -            |              |        | -     | -      |
|   |                    |   | Class  | -           |                               |                                     | -            |              |        | -     | -      |
| Power factor  |                    | %   | -  |             |                               | 94                                  | 94           | 94           | -      | -     |        |
| Noise indoor  |                    | dB-A (H/M/L) *7                           | 36/31/28   |             |                               | -                                   |              |              | -      | -     |        |
|   |                    | Power Level dB                            | 51/46/43   |             |                               | -                                   |              |              | -      | -     |        |
| Noise outdoor                                       |                    | dB-A (H/L)                                | -  |             |                               | 56/-                                |              |              | -      | -     |        |
|   |                    | Power Level dB                            | -  |             |                               | 73/-                                |              |              | -      | -     |        |
| H<br>E<br>A<br>T<br>I<br>N<br>G                     | Capacity           |   | kW   | 12.5        | 12.5                          | 12.5                                | -            | -            | -      | 3.4   | 15.0   |
|   |                    |   | BTU/h  | 42700       | 42700                         | 42700                               | -            | -            | -      | 11600 | 51200  |
|   | Current            |   | A  | 0.35 ×2     | 0.34 ×2                       | 0.33 ×2                             | 4.80         | 4.55         | 4.40   | -     | -      |
|   | Input power        |   | W  | 36 ×2       | 36 ×2                         | 36 ×2                               | 2.978k       | 2.978k       | 2.978k | -     | -      |
|   |                    |   | TOTAL W  | -           |                               |                                     | 3.050k       | 3.050k       | 3.050k | 730   | 4.400k |
|   | COP/COP CLASS      |   | TOTAL (W/W) *5 / ("A"-G)                                 | -           |                               |                                     | 4.10         | 4.10/A       | 4.10   | 4.66  | 3.41   |
|   | Erp *6             |   | Pdesign at -10°C   | -           |                               |                                     | 12.5         |              |        | -     | -      |
|   |                    |   | Tbivalent  | -           |                               |                                     | -7           |              |        | -     | -      |
|   |                    |   | η <sub>s.h</sub>   | -           |                               |                                     | 151.9        |              |        | -     | -      |
|   |                    |   | Annual consumption                                       | -           |                               |                                     | -            |              |        | -     | -      |
|   |                    |   | Class  | -           |                               |                                     | -            |              |        | -     | -      |
|   | Power factor       |   | %  | -           |                               |                                     | 94           | 94           | 94     | -     | -      |
|   | Noise indoor       |   | dB-A (H/M/L) *7  | 36/31/28    |                               |                                     | -            |              |        | -     | -      |
|   |                    |   | Power Level dB   | 51/46/43    |                               |                                     | -            |              |        | -     | -      |
| Noise outdoor                                       |                    | dB-A (H/L)                                | -  |             |                               | 56/-                                |              |              | -      | -     |        |
|   |                    | Power Level dB                            | -  |             |                               | 73/-                                |              |              | -      | -     |        |
| EXTRA LOW TEMP                                      |                    | Total capacity(kW) / Input power(W) / COP | -  |             |                               | -                                   |              |              | -      | -     |        |
| Max Current(A) / Max Input power(W)                 |                    |   | 0.36×2/38×2  | 0.35×2/38×2 | 0.34×2/38×2                   | 10.0 / 6.20k                        | 10.0 / 6.50k | 10.0 / 6.75k | -      |       |        |
| Starting current(A) / Comp output(W)                |                    |   | -  | -           | -                             | 6.25 / 3.0k                         | 5.95 / 3.0k  | 5.75 / 3.0k  | -      |       |        |
| Network Impedance(ΩMAX.)                            |                    |   | -  |             |                               | -                                   |              |              | -      |       |        |
| Fan motor output (Indoor/Outdoor) W                 |                    |   | 60   |             |                               | 90                                  |              |              | -      |       |        |
| Moisture removal volume                             |                    | L/h(Pt/h)                                 | 3.4  | (1.7×2)     | (7.1)                         | -                                   |              |              | -      |       |        |
| External static pressure                            |                    | Pa  | -  |             |                               | -                                   |              |              | -      |       |        |
| Indoor Air flow *7                                  | Cooling            | m³/min (ft³/min)                          | 21.0×2/16.0×2/13.0×2 (742)×2/(565)×2/(459)×2             |             |                               | -                                   |              |              | -      |       |        |
|   | Heating            | m³/min (ft³/min)                          | 21.0×2/16.0×2/13.0×2 (742)×2/(565)×2/(459)×2             |             |                               | -                                   |              |              | -      |       |        |
| Outdoor Air flow                                    | Cooling            | m³/min (ft³/min)                          | -  |             |                               | 80 (2825)                           |              |              | -      |       |        |
|   | Heating            | m³/min (ft³/min)                          | -  |             |                               | 73 (2578)                           |              |              | -      |       |        |
| Refrigerant type / amount g(oz)                     |                    |   | -  |             |                               | R410A 3.20k (112.9)                 |              |              | -      |       |        |
| Product dimension                                   | Height             | mm(inch)                                  | 256  | (10-5/64)   |                               | 996 (39-7/32)                       |              |              | -      |       |        |
|   | Width              | mm(inch)                                  | 840  | (33-5/64)   |                               | 940 (37-1/32)                       |              |              | -      |       |        |
|   | Depth              | mm(inch)                                  | 840  | (33-5/64)   |                               | 340 (13-13/32)                      |              |              | -      |       |        |
| Product dimension (Panel)                           |                    | H×W×D mm, inch                            | 33.5×950×950   |             | 1-11/32 × 37-13/32 × 37-13/32 |                                     | -            |              |        | -     |        |
| Packing dimension                                   | Height             | mm(inch)                                  | 302  | (11-57/64)  |                               | 1136                                |              |              | -      |       |        |
|   | Width              | mm(inch)                                  | 898  | (35-3/8)    |                               | 1055                                |              |              | -      |       |        |
|   | Depth              | mm(inch)                                  | 898  | (35-3/8)    |                               | 485                                 |              |              | -      |       |        |
| Weight  | (NET)              | kg(lb)                                    | 20   | (44)        |                               | 85                                  | (187)        |              | -      |       |        |
|   | (GROSS)            | kg(lb)                                    | 27   | (60)        |                               | 93                                  | (205)        |              | -      |       |        |
|   | Panel (NET)        | kg(lb)                                    | 5  | (11)        |                               | -                                   |              |              | -      |       |        |
| Layers limit (actually)                             |                    |   | 11 (12)  |             |                               | 2 (3)                               |              |              | -      |       |        |
| Operation condition                                 | Cool (DBT)         |   | 18°C ~ 32°C  |             |                               | -10°C ~ 43°C                        |              |              | -      |       |        |
|   | Heat (DBT)         |   | 16°C ~ 30°C  |             |                               | -15°C ~ 24°C                        |              |              | -      |       |        |
| Pipe diameter mm (inch)                             |                    |   | (Liquid)Ø9.52(3/8) (Gas)Ø15.88(5/8)                      |             |                               | (Liquid)Ø9.52(3/8) (Gas)Ø15.88(5/8) |              |              | -      |       |        |
| Connecting method, Standard length m(ft)            |                    |   | flared type, 5.0(16.4)                                   |             |                               | flared type, 5.0(16.4)              |              |              | -      |       |        |
| Pipe length range m (ft)                            |                    |   | 5 ~ 50m (16.4 ~164)                                      |             |                               | -                                   |              |              | -      |       |        |
| Indoor unit & Outdoor unit height difference m (ft) |                    |   | 15m(OD located lower)/30m(OD located higher) (49.2/98.4) |             |                               | -                                   |              |              | -      |       |        |
| Add gas amount g/m (oz/ft)                          |                    |   | 50g (0.538)  |             |                               | -                                   |              |              | -      |       |        |
| Pipe length for additional gas m (ft)               |                    |   | 30m (98.4)   |             |                               | -                                   |              |              | -      |       |        |

\*1 In case it is necessary to indicate the air flow volume in (l/s), the value in (m³/min.) shall be multiplied by 16.7 and rounded down the decimal point.

\*2 If the EUROVENT Certified models can be operated under the "extra-low"temperature condition, -7°C dry bulb and -8°C wet-bulb temperatures with rated voltage 230V shall be used.

\*3 Network Impedance shall be applicable for EUROPE and CHINA models.

\*4 The annual consumption is calculated by multiplying the input power at 230V(400V) by an average of 500 hours per year in cooling mode.

\*5 EER and COP classification is at 230V(400V) only in accordance with EU directive 2002/31/EC.

\*6 SEER and SCOP classification is at 230V(400V) only in accordance with EN-14825. For heating, SCOP indicates the value of only Average heating season.

\*7 H: High at setting 5 stage (Level 5), M: Middle at setting 5 stage (Level 3), L: Low at setting 5 stage (Level 1)

# Simultaneous (Twin) -Type

## 1-1. Unit Specifications

**PEY1**

### 7. 4-Way Cassette Type S-71PU2E5A×2 / U-140PEY1E8

| INDOOR  |                       | MODEL  | S-71PU2E5A×2                                      |  |                                     | -                             |               |                     | -      |              |        |  |
|---|-----------------------|--|---|--|-------------------------------------|-------------------------------|---------------|---------------------|--------|--------------|--------|--|
| PANEL   |                       | MODEL  | Standard type:CZ-KPU3×2 / ECONAVI type:CZ-KPU3A×2 |  |                                     | -                             |               |                     | -      |              |        |  |
| OUTDOOR   |                       | MODEL  | -   |  |                                     | U-140PEY1E8                   |               |                     | -      |              |        |  |
| Branch pipe   |                       | MODEL  | -   |  |                                     | CZ-P155BK1                    |               |                     | -      |              |        |  |
| Performance test condition                          |                       | ISO5151 / EN14511 / EN12102 / EN14825                    |   |  |                                     |                               |               |                     |        |              |        |  |
| C<br>O<br>O<br>L<br>I<br>N<br>G                     | Power supply          |  | 1Ø 50Hz   |  |                                     | 3Ø 50Hz                       |               |                     |        |              |        |  |
|   |                       |  | Ø, Hz   |  |                                     |                               |               |                     |        |              |        |  |
|   |                       |  | V   | 220V   | 230V                                | 240V                          | 380V          | 400V                | 415V   | Min          | Max    |  |
|   | Capacity              |  | kW  | 14.0   | 14.0                                | 14.0                          | -             | -                   | -      | 3.3          | 15.5   |  |
|   |                       |  | BTU/h   | 47800  | 47800                               | 47800                         | -             | -                   | -      | 11300        | 52900  |  |
|   | Current               |  | A   | 0.40×2                                       | 0.39×2                              | 0.38×2                        | 6.80          | 6.50                | 6.25   | -            | -      |  |
|   | Input power           |  | W   | 42×2   | 42×2                                | 42×2                          | 4.226k        | 4.226k              | 4.226k | -            | -      |  |
|   |                       |  | TOTAL W   | -  |                                     |                               | 4.310k        | 4.310k              | 4.310k | 840          | 5.810k |  |
|   | Annual consumption    |  | TOTAL kWh *4                                      | -  |                                     |                               | 2155          |                     |        | -            | -      |  |
|   | EER/EER CLASS         |  | TOTAL (W/W) <sup>5/7</sup> ("A"-G)                | -  |                                     |                               | 3.25          | 3.25/A              | 3.25   | 3.93         | 2.67   |  |
|   | E<br>r<br>p<br>*<br>6 | Pdesign  |   | kW   |                                     |                               | -             |                     |        | 14.0         |        |  |
|   |                       | η <sub>s.c</sub>   |   | %  |                                     |                               | -             |                     |        | 255.5        |        |  |
|   |                       | Annual consumption                                       |   | kWh  |                                     |                               | -             |                     |        | -            |        |  |
|   |                       | Class  |   | -  |                                     |                               | -             |                     |        | -            |        |  |
| Power factor  |                       | %  |   |  | -                                   |                               |               | 94                  |        | 94           |        |  |
| Noise indoor  |                       | dB-A (H/M/L) *7  |   | 37/31/28                                     |                                     |                               | -             |                     |        | -            |        |  |
|   |                       | Power Level dB   |   | 52/46/43                                     |                                     |                               | -             |                     |        | -            |        |  |
| Noise outdoor                                       |                       | dB-A (H/L)   |   | -  |                                     |                               | 54/-          |                     |        | -            |        |  |
|   |                       | Power Level dB   |   | -  |                                     |                               | 71/-          |                     |        | -            |        |  |
| H<br>E<br>A<br>T<br>I<br>N<br>G                     | Capacity              |  | kW  | 14.0   | 14.0                                | 14.0                          | -             | -                   | -      | 4.1          | 16.0   |  |
|   |                       |  | BTU/h   | 47800  | 47800                               | 47800                         | -             | -                   | -      | 14000        | 54600  |  |
|   | Current               |  | A   | 0.39×2                                       | 0.38×2                              | 0.37×2                        | 5.30          | 5.05                | 4.85   | -            | -      |  |
|   | Input power           |  | W   | 40×2   | 40×2                                | 40×2                          | 3.290k        | 3.290k              | 3.290k | -            | -      |  |
|   |                       |  | TOTAL W   | -  |                                     |                               | 3.370k        | 3.370k              | 3.370k | 900          | 5.200k |  |
|   | COP/COP CLASS         |  | TOTAL (W/W) <sup>5/7</sup> ("A"-G)                | -  |                                     |                               | 4.15          | 4.15/A              | 4.15   | 4.56         | 3.08   |  |
|   | E<br>r<br>p<br>*<br>6 | Pdesign at -10°C   |   | kW   |                                     |                               | -             |                     |        | 14.0         |        |  |
|   |                       | Tbivalent  |   | °C   |                                     |                               | -             |                     |        | -7           |        |  |
|   |                       | η <sub>s.h</sub>   |   | %  |                                     |                               | -             |                     |        | 148.5        |        |  |
|   |                       | Annual consumption                                       |   | kWh  |                                     |                               | -             |                     |        | -            |        |  |
|   | Class                 |  | -   |  |                                     | -                             |               |                     | -      |              |        |  |
|   | Power factor          |  | %   |  |                                     | -                             |               |                     | 94     |              | 94     |  |
|   | Noise indoor          |  | dB-A (H/M/L) *7                                   |  | 37/31/28                            |                               |               | -                   |        |              | -      |  |
|   |                       |  | Power Level dB                                    |  | 52/46/43                            |                               |               | -                   |        |              | -      |  |
| Noise outdoor                                       |                       | dB-A (H/L)   |   | -  |                                     |                               | 53/-          |                     |        | -            |        |  |
|   |                       | Power Level dB   |   | -  |                                     |                               | 70/-          |                     |        | -            |        |  |
| EXTRA LOW TEMP                                      |                       | Total capacity(kW) / Input power(W) / COP                |   |  |                                     |                               |               |                     |        |              |        |  |
| Max Current(A) / Max Input power(W)                 |                       | 0.40×2/42×2  |   | 0.39×2/42×2                                  |                                     | 0.38×2/42×2                   |               | 10.0 / 6.20k        |        | 10.0 / 6.50k |        |  |
| Starting current(A) / Comp output(W)                |                       | -  |   | -  |                                     | -                             |               | 6.80 / 3.0k         |        | 6.50 / 3.0k  |        |  |
| Network Impedance(ΩMAX.)                            |                       | -  |   |  |                                     |                               |               |                     |        |              |        |  |
| Fan motor output (Indoor/Outdoor) W                 |                       | 60   |   |  | -                                   |                               |               | 90×2                |        |              |        |  |
| Moisture removal volume                             |                       | L/h(Pt/h)  |   | 5.0 (2.5×2)                                  |                                     | (10.5)                        |               | -                   |        |              |        |  |
| External static pressure                            |                       | Pa   |   | -  |                                     |                               | -             |                     |        | -            |        |  |
| Indoor Air flow *7                                  | Cooling               | m³/min (ft³/min)   |   | 22.0×2/16.0×2/13.0×2 (777)×2/(565)×2/(459)×2 |                                     |                               | -             |                     |        | -            |        |  |
|   | Heating               | m³/min (ft³/min)   |   | 22.0×2/16.0×2/13.0×2 (777)×2/(565)×2/(459)×2 |                                     |                               | -             |                     |        | -            |        |  |
| Outdoor Air flow                                    | Cooling               | m³/min (ft³/min)   |   | -  |                                     |                               | 135 (4767)    |                     |        | -            |        |  |
|   | Heating               | m³/min (ft³/min)   |   | -  |                                     |                               | 120 (4238)    |                     |        | -            |        |  |
| Refrigerant type / amount g(oz)                     |                       | -  |   |  | -                                   |                               |               | R410A 3.40k (119.9) |        |              | -      |  |
| Product dimension                                   |                       | Height   | mm(inch)  |  | 256 (10-5/64)                       |                               | 1416 (55-3/4) |                     |        | -            |        |  |
|   |                       | Width  | mm(inch)  |  | 840 (33-5/64)                       |                               |               | 940 (37-1/32)       |        |              | -      |  |
|   |                       | Depth  | mm(inch)  |  | 840 (33-5/64)                       |                               |               | 340 (13-13/32)      |        |              | -      |  |
| Product dimension (Panel)                           |                       | H×W×D mm, inch   |   | 33.5×950×950                                 |                                     | 1-11/32 × 37-13/32 × 37-13/32 |               | -                   |        |              | -      |  |
| Packing dimension                                   |                       | Height   | mm(inch)  |  | 302 (11-57/64)                      |                               | 1556          |                     |        | -            |        |  |
|   |                       | Width  | mm(inch)  |  | 898 (35-3/8)                        |                               |               | 1055                |        |              | -      |  |
|   |                       | Depth  | mm(inch)  |  | 898 (35-3/8)                        |                               |               | 485                 |        |              | -      |  |
| Weight  |                       | (NET)  | kg(lb)  |  | 20 (44)                             |                               | 98 (216)      |                     | -      |              |        |  |
|   |                       | (GROSS)  | kg(lb)  |  | 27 (60)                             |                               | 108 (238)     |                     | -      |              |        |  |
|   |                       | Panel (NET)  | kg(lb)  |  | 5 (11)                              |                               | -             |                     |        | -            |        |  |
| Layers limit (actually)                             |                       | 11 (12)  |   |  | 1 (2)                               |                               |               | -                   |        |              |        |  |
| Operation condition                                 |                       | Cool (DBT)   | 18°C ~ 32°C                                       |  |                                     | -10°C ~ 43°C                  |               |                     | -      |              |        |  |
|   |                       | Heat (DBT)   | 16°C ~ 30°C                                       |  |                                     | -15°C ~ 24°C                  |               |                     | -      |              |        |  |
| Pipe diameter mm (inch)                             |                       | (Liquid)Ø9.52(3/8) (Gas)Ø15.88(5/8)                      |   |  | (Liquid)Ø9.52(3/8) (Gas)Ø15.88(5/8) |                               |               | -                   |        |              |        |  |
| Connecting method, Standard length m(ft)            |                       | flared type, 5.0(16.4)                                   |   |  | flared type, 5.0(16.4)              |                               |               | -                   |        |              |        |  |
| Pipe length range m (ft)                            |                       | 5 ~ 50m (16.4 ~164)                                      |   |  | -                                   |                               |               | -                   |        |              |        |  |
| Indoor unit & Outdoor unit height difference m (ft) |                       | 15m(OD located lower)/30m(OD located higher) (49.2/98.4) |   |  | -                                   |                               |               | -                   |        |              |        |  |
| Add gas amount g/m (oz/ft)                          |                       | 50g (0.538)  |   |  | -                                   |                               |               | -                   |        |              |        |  |
| Pipe length for additional gas m (ft)               |                       | 30m (98.4)   |   |  | -                                   |                               |               | -                   |        |              |        |  |

\*1 In case it is necessary to indicate the air flow volume in (l/s), the value in (m³/min.) shall be multiplied by 16.7 and rounded down the decimal point.  
 \*2 If the EUROVENT Certified models can be operated under the "extra-low"temperature condition, -7°C dry bulb and -8°C wet-bulb temperatures with rated voltage 230V shall be used.  
 \*3 Network Impedance shall be applicable for EUROPE and CHINA models.  
 \*4 The annual consumption is calculated by multiplying the input power at 230V(400V) by an average of 500 hours per year in cooling mode.  
 \*5 EER and COP classification is at 230V(400V) only in accordance with EU directive 2002/31/EC.  
 \*6 SEER and SCOP classification is at 230V(400V) only in accordance with EN-14825. For heating, SCOP indicates the value of only Average heating season.  
 \*7 H: High at setting 5 stage (Level 5), M: Middle at setting 5 stage (Level 3), L: Low at setting 5 stage (Level 1)

# Single -Type

## 1-1. Unit Specifications

**PEY1**

### 7. 4-Way Cassette Type S-100PU2E5A / U-100PEY1E8

| INDOOR                                       |  | MODEL                                     | S-100PU2E5A                                 |  |                               | -                                   |              |        | -      |        |        |
|--|--|---|---|--|-------------------------------|-------------------------------------|--------------|--------|--------|--------|--------|
| PANEL  |  | MODEL                                     | Standard type:CZ-KPU3:ECONAVI type:CZ-KPU3A |  |                               | -                                   |              |        | -      |        |        |
| OUTDOOR                                      |  | MODEL                                     | -   |  |                               | U-100PEY1E8                         |              |        | -      |        |        |
| Branch pipe                                  |  | MODEL                                     | -   |  |                               | -                                   |              |        | -      |        |        |
| Performance test condition                   |  | ISO5151 / EN14511 / EN12102 / EN14825     |   |  |                               |                                     |              |        |        |        |        |
| C<br>O<br>O<br>L<br>I<br>N<br>G              | Power supply                             |   | 1Ø 50Hz                                     |  |                               | 3Ø 50Hz                             |              |        |        |        |        |
|  |  |   | Ø, Hz                                       |  |                               |                                     |              |        |        |        |        |
|  |  |   | V   | 220V   | 230V                          | 240V                                | 380V         | 400V   | 415V   | Min    | Max    |
|  | Capacity                                 |   | kW  | 10.0   | 10.0                          | 10.0                                | -            | -      | -      | 2.7    | 11.5   |
|  |  |   | BTU/h                                       | 34100  | 34100                         | 34100                               | -            | -      | -      | 9200   | 39200  |
|  | Current                                  |   | A   | 0.82   | 0.79                          | 0.76                                | 5.00         | 4.75   | 4.60   | -      | -      |
|  | Input power                              |   | W   | 100  | 100                           | 100                                 | 3.060k       | 3.060k | 3.060k | -      | -      |
|  |  |   | TOTAL W                                     | -  | -                             | -                                   | 3.160k       | 3.160k | 3.160k | 530    | 4.200k |
|  | Annual consumption                       |   | TOTAL kWh *4                                | -  | -                             | -                                   | -            | 1580   | -      | -      | -      |
|  | EER/EER CLASS                            |   | TOTAL (W/W) <sup>7</sup> / ("A"-G)          | -  | -                             | -                                   | 3.16         | 3.16/B | 3.16   | 5.09   | 2.74   |
| H<br>E<br>A<br>T<br>I<br>N<br>G              | Erp <sup>*6</sup>                        | Pdesign                                   | kW  | -  | -                             | -                                   | -            | 10.0   | -      | -      | -      |
|  |  | SEER                                      | (W/W)                                       | -  | -                             | -                                   | -            | 6.6    | -      | -      | -      |
|  |  | Annual consumption                        | kWh   | -  | -                             | -                                   | -            | 530    | -      | -      | -      |
|  |  | Class                                     |   | -  | -                             | -                                   | -            | A++    | -      | -      | -      |
|  | Power factor                             |   | %   | -  | -                             | -                                   | 93           | 93     | 93     | -      | -      |
|  | Noise indoor                             | dB-A (H/M/L) *7                           |   | 45/38/32   |                               |                                     | -            |        |        | -      |        |
|  |  | Power Level dB                            |   | 60/53/47   |                               |                                     | -            |        |        | -      |        |
|  | Noise outdoor                            | dB-A (H/L)                                |   | -  |                               |                                     | 54/-         |        |        | -      |        |
|  |  | Power Level dB                            |   | -  |                               |                                     | 70/-         |        |        | -      |        |
|  | Capacity                                 |   | kW  | 10.0   | 10.0                          | 10.0                                | -            | -      | -      | 2.1    | 13.8   |
|  |  | BTU/h                                     | 34100                                       | 34100  | 34100                         | -                                   | -            | -      | 7200   | 47100  |        |
| Current                                      |  | A   | 0.81  | 0.78   | 0.75                          | 3.80                                | 3.60         | 3.50   | -      | -      |        |
| Input power                                  |  | W   | 95  | 95   | 95                            | 2.315k                              | 2.315k       | 2.315k | -      | -      |        |
|  |  | TOTAL W                                   | -   | -  | -                             | 2.410k                              | 2.410k       | 2.410k | 410    | 4.000k |        |
| COP/COP CLASS                                |  | TOTAL (W/W) <sup>7</sup> / ("A"-G)        | -   | -  | -                             | 4.15                                | 4.15/A       | 4.15   | 5.12   | 3.45   |        |
| Erp <sup>*6</sup>                            | Pdesign at -10°C                         |   | kW  | -  | -                             | -                                   | -            | 10.0   | -      | -      |        |
|  | Tbivalent                                |   | °C  | -  | -                             | -                                   | -            | -8     | -      | -      |        |
|  | SCOP                                     |   | (W/W)                                       | -  | -                             | -                                   | -            | 4.3    | -      | -      |        |
|  | Annual consumption                       |   | kWh   | -  | -                             | -                                   | -            | 3256   | -      | -      |        |
| Class  |  |   | -   | -  | -                             | -                                   | A+           | -      | -      |        |        |
| Power factor                                 |  | %   | -   | -  | -                             | 93                                  | 93           | 92     | -      | -      |        |
| Noise indoor                                 | dB-A (H/M/L) *7                          |   | 45/38/32                                    |  |                               | -                                   |              |        | -      |        |        |
|  | Power Level dB                           |   | 60/53/47                                    |  |                               | -                                   |              |        | -      |        |        |
| Noise outdoor                                | dB-A (H/L)                               |   | -   |  |                               | 54/-                                |              |        | -      |        |        |
|  | Power Level dB                           |   | -   |  |                               | 70/-                                |              |        | -      |        |        |
| EXTRA LOW TEMP                               |  | Total capacity(kW) / Input power(W) / COP |   | -  |                               |                                     |              |        |        | -      |        |
| Max Current(A) / Max Input power(W)          |  | 0.82/100                                  | 0.79/100                                    | 0.76/100   | 9.00 / 5.55k                  | 9.00 / 5.80k                        | 9.00 / 6.05k | -      |        |        |        |
| Starting current(A) / Comp output(W)         |  | -   | -   | -  | 5.00 / 1.7k                   | 4.75 / 1.7k                         | 4.55 / 1.7k  | -      |        |        |        |
| Network Impedance(ΩMAX.)                     |  | -   |   |  |                               |                                     |              |        |        |        |        |
| Fan motor output (Indoor/Outdoor) W          |  | 90  |   |  | 90                            |                                     |              | -      |        |        |        |
| Moisture removal volume                      |  | L/h(P/h)                                  | 2.7   | (5.7)  |                               | -                                   |              |        | -      |        |        |
| External static pressure                     |  | Pa  | -   |  |                               | -                                   |              |        | -      |        |        |
| Indoor Air flow *7                           | Cooling                                  | m³/min (ft³/min)                          | 36.0/26.0/18.0 (1271)/(918)/(636)           |  |                               | -                                   |              |        | -      |        |        |
|  | Heating                                  | m³/min (ft³/min)                          | 36.0/26.0/18.0 (1271)/(918)/(636)           |  |                               | -                                   |              |        | -      |        |        |
| Outdoor Air flow                             | Cooling                                  | m³/min (ft³/min)                          | -   |  |                               | 76 (2684)                           |              |        | -      |        |        |
|  | Heating                                  | m³/min (ft³/min)                          | -   |  |                               | 67 (2366)                           |              |        | -      |        |        |
| Refrigerant type / amount g(oz)              |  | -   |   |  | R410A 2.60k (91.7)            |                                     |              | -      |        |        |        |
| Product dimension                            | Height                                   | mm(inch)                                  | 319   | (12-9/16)  |                               | 996 (39-7/32)                       |              |        | -      |        |        |
|  | Width                                    | mm(inch)                                  | 840   | (33-5/64)  |                               | 940 (37-1/32)                       |              |        | -      |        |        |
|  | Depth                                    | mm(inch)                                  | 840   | (33-5/64)  |                               | 340 (13-13/32)                      |              |        | -      |        |        |
| Product dimension (Panel)                    |  | H×W×D mm, inch                            | 33.5×950×950                                |  | 1-11/32 × 37-13/32 × 37-13/32 |                                     | -            |        |        |        |        |
| Packing dimension                            | Height                                   | mm(inch)                                  | 365   | (14-3/8)   |                               | 1136                                |              |        | -      |        |        |
|  | Width                                    | mm(inch)                                  | 898   | (35-3/8)   |                               | 1055                                |              |        | -      |        |        |
|  | Depth                                    | mm(inch)                                  | 898   | (35-3/8)   |                               | 485                                 |              |        | -      |        |        |
| Weight                                       | (NET)                                    | kg(lb)                                    | 25  | (55)   |                               | 73                                  | (161)        |        | -      |        |        |
|  | (GROSS)                                  | kg(lb)                                    | 32  | (71)   |                               | 81                                  | (179)        |        | -      |        |        |
|  | Panel (NET)                              | kg(lb)                                    | 5   | (11)   |                               | -                                   |              |        | -      |        |        |
| Layers limit (actually)                      |  | 11 (12)                                   |   |  | 2 (3)                         |                                     |              | -      |        |        |        |
| Operation condition                          | Cool (DBT)                               | 18°C ~ 32°C                               |   |  | -10°C ~ 43°C                  |                                     |              | -      |        |        |        |
|  | Heat (DBT)                               | 16°C ~ 30°C                               |   |  | -15°C ~ 24°C                  |                                     |              | -      |        |        |        |
| P<br>I<br>P<br>I<br>N<br>G                   | Pipe diameter mm (inch)                  |   | (Liquid)Ø9.52(3/8) (Gas)Ø15.88(5/8)         |  |                               | (Liquid)Ø9.52(3/8) (Gas)Ø15.88(5/8) |              |        | -      |        |        |
|  | Connecting method, Standard length m(ft) |   | flared type, 5.0(16.4)                      |  |                               | flared type, 5.0(16.4)              |              |        | -      |        |        |
| Pipe length range                            |  | m (ft)                                    |   | 5 ~ 50m (16.4 ~164)                                      |                               |                                     |              |        |        | -      |        |
| Indoor unit & Outdoor unit height difference |  | m (ft)                                    |   | 15m(OD located lower)/30m(OD located higher) (49.2/98.4) |                               |                                     |              |        |        | -      |        |
| Add gas amount                               |  | g/m (oz/ft)                               |   | 50g (0.538)  |                               |                                     |              |        |        | -      |        |
| Pipe length for additional gas               |  | m (ft)                                    |   | 30m (98.4)   |                               |                                     |              |        |        | -      |        |

\*1 In case it is necessary to indicate the air flow volume in (l/s), the value in (m³/min.) shall be multiplied by 16.7 and rounded down the decimal point.

\*2 If the EUROVENT Certified models can be operated under the "extra-low"temperature condition, -7°C dry bulb and -8°C wet-bulb temperatures with rated voltage 230V shall be used.

\*3 Network Impedance shall be applicable for EUROPE and CHINA models.

\*4 The annual consumption is calculated by multiplying the input power at 230V(400V) by an average of 500 hours per year in cooling mode.

\*5 EER and COP classification is at 230V(400V) only in accordance with EU directive 2002/31/EC.

\*6 SEER and SCOP classification is at 230V(400V) only in accordance with EN-14825. For heating, SCOP indicates the value of only Average heating season, Other fiche data indicates in an attached sheet

\*7 H: High at setting 5 stage (Level 5), M: Middle at setting 5 stage (Level 3), L: Low at setting 5 stage (Level 1)



# Single -Type

## 1-1. Unit Specifications

**PEY1**

### 7. 4-Way Cassette Type S-125PU2E5A / U-125PEY1E8

| INDOOR                                       |  | MODEL                                     | S-125PU2E5A                                 |  |                               | -                                   |              |        | -      |       |
|--|--|---|---|--|-------------------------------|-------------------------------------|--------------|--------|--------|-------|
| PANEL  |  | MODEL                                     | Standard type:CZ-KPU3:ECONAVI type:CZ-KPU3A |  |                               | -                                   |              |        | -      |       |
| OUTDOOR                                      |  | MODEL                                     | -   |  |                               | U-125PEY1E8                         |              |        | -      |       |
| Branch pipe                                  |  | MODEL                                     | -   |  |                               | -                                   |              |        | -      |       |
| Performance test condition                   |  | ISO5151 / EN14511 / EN12102 / EN14825     |   |  |                               |                                     |              |        |        |       |
| C<br>O<br>O<br>L<br>I<br>N<br>G              | Power supply                             |   | 1Ø 50Hz                                     |  |                               | 3Ø 50Hz                             |              |        | Min    | Max   |
|  |  |   | Ø, Hz                                       |  |                               |                                     |              |        |        |       |
|  |  |   | V   | 220V   | 230V                          | 240V                                | 380V         | 400V   | 415V   |       |
|  | Capacity                                 |   | kW  | 12.5   | 12.5                          | 12.5                                | -            | -      | -      | 3.8   |
|  |  |   | BTU/h                                       | 42700  | 42700                         | 42700                               | -            | -      | -      | 13000 |
|  | Current                                  |   | A   | 0.91   | 0.88                          | 0.85                                | 6.20         | 5.90   | 5.70   | -     |
|  | Input power                              |   | W   | 110  | 110                           | 110                                 | 3.850k       | 3.850k | 3.850k | -     |
|  |  |   | TOTAL W                                     | -  | -                             | -                                   | 3.960k       | 3.960k | 3.960k | 900   |
|  | Annual consumption                       |   | TOTAL kWh *4                                | -  | -                             | -                                   | -            | 1980   | -      | -     |
|  | EER/EER CLASS                            |   | TOTAL (W/W) *5 / ("A"-G)                    | -  | -                             | -                                   | 3.16         | 3.16/B | 3.16   | 4.22  |
|  | Erp *6                                   |   | Pdesign kW                                  | -  | -                             | -                                   | -            | 12.5   | -      | -     |
|  |  |   | η s.c %                                     | -  | -                             | -                                   | -            | 245.0  | -      | -     |
|  |  |   | Annual consumption kWh                      | -  | -                             | -                                   | -            | -      | -      | -     |
|  |  |   | Class                                       | -  | -                             | -                                   | -            | -      | -      | -     |
| Power factor                                 |  | %   | -   | -  | -                             | 94                                  | 94           | 94     | -      |       |
| Noise indoor                                 |  | dB-A (H/M/L) *7                           | 46/39/33                                    |  |                               | -                                   |              |        | -      |       |
|  |  | Power Level dB                            | 61/54/48                                    |  |                               | -                                   |              |        | -      |       |
| Noise outdoor                                |  | dB-A (H/L)                                | -   |  |                               | 56/-                                |              |        | -      |       |
|  |  | Power Level dB                            | -   |  |                               | 73/-                                |              |        | -      |       |
| H<br>E<br>A<br>T<br>I<br>N<br>G              | Capacity                                 |   | kW  | 12.5   | 12.5                          | 12.5                                | -            | -      | -      | 3.4   |
|  |  |   | BTU/h                                       | 42700  | 42700                         | 42700                               | -            | -      | -      | 11600 |
|  | Current                                  |   | A   | 0.90   | 0.87                          | 0.84                                | 4.75         | 4.50   | 4.35   | -     |
|  | Input power                              |   | W   | 105  | 105                           | 105                                 | 2.945k       | 2.945k | 2.945k | -     |
|  |  |   | TOTAL W                                     | -  | -                             | -                                   | 3.050k       | 3.050k | 3.050k | 730   |
|  | COP/COP CLASS                            |   | TOTAL (W/W) *5 / ("A"-G)                    | -  | -                             | -                                   | 4.10         | 4.10/A | 4.10   | 4.66  |
|  | Erp *6                                   |   | Pdesign at -10°C kW                         | -  | -                             | -                                   | -            | 12.5   | -      | -     |
|  |  |   | Tbivalent °C                                | -  | -                             | -                                   | -            | -7     | -      | -     |
|  |  |   | η s.h %                                     | -  | -                             | -                                   | -            | 151.8  | -      | -     |
|  |  |   | Annual consumption kWh                      | -  | -                             | -                                   | -            | -      | -      | -     |
|  |  |   | Class                                       | -  | -                             | -                                   | -            | -      | -      | -     |
|  | Power factor                             |   | %   | -  | -                             | -                                   | 94           | 94     | 94     | -     |
|  | Noise indoor                             |   | dB-A (H/M/L) *7                             | 46/39/33   |                               |                                     | -            |        |        | -     |
|  |  |   | Power Level dB                              | 61/54/48   |                               |                                     | -            |        |        | -     |
| Noise outdoor                                |  | dB-A (H/L)                                | -   |  |                               | 56/-                                |              |        | -      |       |
|  |  | Power Level dB                            | -   |  |                               | 73/-                                |              |        | -      |       |
| EXTRA LOW TEMP                               |  | Total capacity(kW) / Input power(W) / COP | -   |  |                               | -                                   |              |        | -      |       |
| Max Current(A) / Max Input power(W)          |  | 0.91/110                                  | 0.88/110                                    | 0.85/110   | 10.0 / 6.20k                  | 10.0 / 6.50k                        | 10.0 / 6.75k | -      |        |       |
| Starting current(A) / Comp output(W)         |  | -   | -   | -  | 6.20 / 3.0k                   | 5.90 / 3.0k                         | 5.70 / 3.0k  | -      |        |       |
| Network Impedance(ΩMAX.)                     |  | -   |   |  | -                             |                                     |              | -      |        |       |
| Fan motor output (Indoor/Outdoor) W          |  | 90  |   |  | 90                            |                                     |              | -      |        |       |
| Moisture removal volume                      |  | L/h(Pt/h)                                 | 4.8   | (10.1)   |                               | -                                   |              |        | -      |       |
| External static pressure                     |  | Pa  | -   |  |                               | -                                   |              |        | -      |       |
| Indoor Air flow *7                           | Cooling                                  | m³/min (ft³/min)                          | 37.0/27.0/19.0 (1307)/(953)/(671)           |  |                               | -                                   |              |        | -      |       |
|  | Heating                                  | m³/min (ft³/min)                          | 37.0/27.0/19.0 (1307)/(953)/(671)           |  |                               | -                                   |              |        | -      |       |
| Outdoor Air flow                             | Cooling                                  | m³/min (ft³/min)                          | -   |  |                               | 80 (2825)                           |              |        | -      |       |
|  | Heating                                  | m³/min (ft³/min)                          | -   |  |                               | 73 (2578)                           |              |        | -      |       |
| Refrigerant type / amount g(oz)              |  | -   |   |  | R410A 3.20k (112.9)           |                                     |              | -      |        |       |
| Product dimension                            | Height                                   | mm(inch)                                  | 319   | (12-9/16)  |                               | 996 (39-7/32)                       |              |        | -      |       |
|  | Width                                    | mm(inch)                                  | 840   | (33-5/64)  |                               | 940 (37-1/32)                       |              |        | -      |       |
|  | Depth                                    | mm(inch)                                  | 840   | (33-5/64)  |                               | 340 (13-13/32)                      |              |        | -      |       |
| Product dimension (Panel)                    |  | H×W×D mm, inch                            | 33.5×950×950                                |  | 1-11/32 × 37-13/32 × 37-13/32 |                                     | -            |        |        |       |
| Packing dimension                            | Height                                   | mm(inch)                                  | 365   | (14-3/8)   |                               | 1136                                |              |        | -      |       |
|  | Width                                    | mm(inch)                                  | 898   | (35-3/8)   |                               | 1055                                |              |        | -      |       |
|  | Depth                                    | mm(inch)                                  | 898   | (35-3/8)   |                               | 485                                 |              |        | -      |       |
| Weight                                       | (NET)                                    | kg(lb)                                    | 25  | (55)   |                               | 85                                  | (187)        |        | -      |       |
|  | (GROSS)                                  | kg(lb)                                    | 32  | (71)   |                               | 93                                  | (205)        |        | -      |       |
|  | Panel (NET)                              | kg(lb)                                    | 5   | (11)   |                               | -                                   |              |        | -      |       |
| Layers limit (actually)                      |  | 11 (12)                                   |   |  | 2 (3)                         |                                     |              | -      |        |       |
| Operation condition                          | Cool (DBT)                               | 18°C ~ 32°C                               |   |  | -10°C ~ 43°C                  |                                     |              | -      |        |       |
|  | Heat (DBT)                               | 16°C ~ 30°C                               |   |  | -15°C ~ 24°C                  |                                     |              | -      |        |       |
| P I P I N G                                  | Pipe diameter mm (inch)                  |   | (Liquid)Ø9.52(3/8) (Gas)Ø15.88(5/8)         |  |                               | (Liquid)Ø9.52(3/8) (Gas)Ø15.88(5/8) |              |        | -      |       |
|  | Connecting method, Standard length m(ft) |   | flared type, 5.0(16.4)                      |  |                               | flared type, 5.0(16.4)              |              |        | -      |       |
| Pipe length range                            |  | m (ft)                                    |   | 5 ~ 50m (16.4 ~164)                                      |                               |                                     |              |        |        |       |
| Indoor unit & Outdoor unit height difference |  | m (ft)                                    |   | 15m(OD located lower)/30m(OD located higher) (49.2/98.4) |                               |                                     |              |        |        |       |
| Add gas amount                               |  | g/m (oz/ft)                               |   | 50g (0.538)  |                               |                                     |              |        |        |       |
| Pipe length for additional gas               |  | m (ft)                                    |   | 30m (98.4)   |                               |                                     |              |        |        |       |

\*1 In case it is necessary to indicate the air flow volume in (l/s), the value in (m³/min.) shall be multiplied by 16.7 and rounded down the decimal point.  
 \*2 If the EUROVENT Certified models can be operated under the "extra-low"temperature condition, -7°C dry bulb and -8°C wet-bulb temperatures with rated voltage 230V shall be used.  
 \*3 Network Impedance shall be applicable for EUROPE and CHINA models.  
 \*4 The annual consumption is calculated by multiplying the input power at 230V(400V) by an average of 500 hours per year in cooling mode.  
 \*5 EER and COP classification is at 230V(400V) only in accordance with EU directive 2002/31/EC.  
 \*6 SEER and SCOP classification is at 230V(400V) only in accordance with EN-14825. For heating, SCOP indicates the value of only Average heating season.  
 \*7 H: High at setting 5 stage (Level 5), M: Middle at setting 5 stage (Level 3), L: Low at setting 5 stage (Level 1)

# Single -Type

## 1-1. Unit Specifications

**PEY1**

### 7. 4-Way Cassette Type S-140PU2E5A / U-140PEY1E8

| INDOOR   | MODEL           | S-140PU2E5A  |                                    |           | -                                   |                |              | -      |       |        |
|--|-----------------|--|------------------------------------|-----------|-------------------------------------|----------------|--------------|--------|-------|--------|
| PANEL  | MODEL           | Standard type:CZ-KPU3:ECONAVI type:CZ-KPU3A              |                                    |           | -                                   |                |              | -      |       |        |
| OUTDOOR  | MODEL           | -  |                                    |           | U-140PEY1E8                         |                |              | -      |       |        |
| Branch pipe  | MODEL           | -  |                                    |           | -                                   |                |              | -      |       |        |
| Performance test condition                                 |                 | ISO5151 / EN14511 / EN12102 / EN14825                    |                                    |           |                                     |                |              |        |       |        |
| C<br>O<br>O<br>L<br>I<br>N<br>G                            | Power supply    | Ø, Hz  | 1Ø 50Hz                            |           |                                     | 3Ø 50Hz        |              |        | Min   | Max    |
|  |                 | V  | 220V                               | 230V      | 240V                                | 380V           | 400V         | 415V   |       |        |
|  | Capacity        | kW   | 14.0                               | 14.0      | 14.0                                | -              | -            | -      | 3.3   | 15.5   |
|  |                 | BTU/h  | 47800                              | 47800     | 47800                               | -              | -            | -      | 11300 | 52900  |
|  | Current         | A  | 0.97                               | 0.94      | 0.91                                | 6.75           | 6.40         | 6.20   | -     | -      |
|  |                 | W  | 120                                | 120       | 120                                 | 4.190k         | 4.190k       | 4.190k | -     | -      |
|  | Input power     | TOTAL W  | -                                  | -         | -                                   | 4.310k         | 4.310k       | 4.310k | 840   | 5.810k |
|  |                 | Annual consumption                                       | TOTAL kWh *4                       | -         | -                                   | -              | -            | 2155   | -     | -      |
|  | EER/EER CLASS   | TOTAL (W/W) *5 / ("A"-G)                                 | -                                  | -         | -                                   | 3.25           | 3.25/A       | 3.25   | 3.93  | 2.67   |
|  | Erp *6          | Pdesign  | kW                                 | -         | -                                   | -              | -            | 14.0   | -     | -      |
|  |                 | η <sub>s.c</sub>   | %                                  | -         | -                                   | -              | -            | 252.7  | -     | -      |
|  |                 | Annual consumption                                       | kWh                                | -         | -                                   | -              | -            | -      | -     | -      |
|  |                 | Class  |                                    | -         | -                                   | -              | -            | -      | -     | -      |
|  | Power factor    | %  | -                                  | -         | -                                   | 94             | 94           | 94     | -     | -      |
| Noise indoor   | dB-A (H/M/L) *7 | 47/40/34   |                                    |           | -                                   |                |              | -      | -     |        |
|  | Power Level dB  | 62/55/49   |                                    |           | -                                   |                |              | -      | -     |        |
| Noise outdoor  | dB-A (H/L)      | -  |                                    |           | 54/-                                |                |              | -      | -     |        |
|  | Power Level dB  | -  |                                    |           | 71/-                                |                |              | -      | -     |        |
| H<br>E<br>A<br>T<br>I<br>N<br>G                            | Capacity        | kW   | 14.0                               | 14.0      | 14.0                                | -              | -            | -      | 4.1   | 16.0   |
|  |                 | BTU/h  | 47800                              | 47800     | 47800                               | -              | -            | -      | 14000 | 54600  |
|  | Current         | A  | 0.96                               | 0.93      | 0.90                                | 5.25           | 5.00         | 4.80   | -     | -      |
|  |                 | W  | 115                                | 115       | 115                                 | 3.255k         | 3.255k       | 3.255k | -     | -      |
|  | Input power     | TOTAL W  | -                                  | -         | -                                   | 3.370k         | 3.370k       | 3.370k | 900   | 5.200k |
|  |                 | COP/COP CLASS  | TOTAL (W/W) *5 / ("A"-G)           | -         | -                                   | -              | 4.15         | 4.15/A | 4.15  | 4.56   |
|  | Erp *6          | Pdesign at -10°C   | kW                                 | -         | -                                   | -              | -            | 14.0   | -     | -      |
|  |                 | Tbivalent  | °C                                 | -         | -                                   | -              | -            | -7     | -     | -      |
|  |                 | η <sub>s.h</sub>   | %                                  | -         | -                                   | -              | -            | 148.4  | -     | -      |
|  |                 | Annual consumption                                       | kWh                                | -         | -                                   | -              | -            | -      | -     | -      |
|  | Class           |  | -                                  | -         | -                                   | -              | -            | -      | -     | -      |
|  | Power factor    | %  | -                                  | -         | -                                   | 94             | 94           | 94     | -     | -      |
|  | Noise indoor    | dB-A (H/M/L) *7  | 47/40/34                           |           |                                     | -              |              |        | -     | -      |
|  |                 | Power Level dB   | 62/55/49                           |           |                                     | -              |              |        | -     | -      |
| Noise outdoor  | dB-A (H/L)      | -  |                                    |           | 53/-                                |                |              | -      | -     |        |
|  | Power Level dB  | -  |                                    |           | 70/-                                |                |              | -      | -     |        |
| EXTRA LOW TEMP   Total capacity(kW) / Input power(W) / COP |                 | -  |                                    |           |                                     |                |              |        |       |        |
| Max Current(A) / Max Input power(W)                        |                 | 0.97/120   | 0.94/120                           | 0.91/120  | 10.0 / 6.20k                        | 10.0 / 6.50k   | 10.0 / 6.75k | -      |       |        |
| Starting current(A) / Comp output(W)                       |                 | -  | -                                  | -         | 6.75 / 3.0k                         | 6.40 / 3.0k    | 6.20 / 3.0k  | -      |       |        |
| Network Impedance(ΩMAX.)                                   |                 | -  |                                    |           |                                     |                |              |        |       |        |
| Fan motor output (Indoor/Outdoor) W                        |                 | 90   |                                    |           | 90 × 2                              |                |              | -      |       |        |
| Moisture removal volume                                    |                 | L/h(Pt/h)  | 6.0                                | (12.6)    |                                     | -              |              |        | -     |        |
| External static pressure                                   |                 | Pa   | -                                  |           |                                     | -              |              |        | -     |        |
| Indoor Air flow *7   | Cooling         | m³/min (ft³/min)   | 38.0/29.0/20.0 (1342)/(1024)/(706) |           |                                     | -              |              |        | -     |        |
|  | Heating         | m³/min (ft³/min)   | 38.0/29.0/20.0 (1342)/(1024)/(706) |           |                                     | -              |              |        | -     |        |
| Outdoor Air flow   | Cooling         | m³/min (ft³/min)   | -                                  |           |                                     | 135 (4767)     |              |        | -     |        |
|  | Heating         | m³/min (ft³/min)   | -                                  |           |                                     | 120 (4238)     |              |        | -     |        |
| Refrigerant type / amount g(oz)                            |                 | -  |                                    |           | R410A 3.40k (119.9)                 |                |              | -      |       |        |
| Product dimension  | Height          | mm(inch)   | 319                                | (12-9/16) |                                     | 1416 (55-3/4)  |              |        | -     |        |
|  | Width           | mm(inch)   | 840                                | (33-5/64) |                                     | 940 (37-1/32)  |              |        | -     |        |
|  | Depth           | mm(inch)   | 840                                | (33-5/64) |                                     | 340 (13-13/32) |              |        | -     |        |
| Product dimension (Panel)                                  |                 | H×W×D mm, inch   | 33.5×950×950                       |           | 1-11/32 × 37-13/32 × 37-13/32       |                | -            |        |       |        |
| Packing dimension  | Height          | mm(inch)   | 365                                | (14-3/8)  |                                     | 1556           |              |        | -     |        |
|  | Width           | mm(inch)   | 898                                | (35-3/8)  |                                     | 1055           |              |        | -     |        |
|  | Depth           | mm(inch)   | 898                                | (35-3/8)  |                                     | 485            |              |        | -     |        |
| Weight   | (NET)           | kg(lb)   | 25                                 | (55)      |                                     | 98             | (216)        |        | -     |        |
|  | (GROSS)         | kg(lb)   | 32                                 | (71)      |                                     | 108            | (238)        |        | -     |        |
|  | Panel (NET)     | kg(lb)   | 5                                  | (11)      |                                     | -              |              |        | -     |        |
| Layers limit (actually)                                    |                 | 11 (12)  |                                    |           | 1 (2)                               |                |              | -      |       |        |
| Operation condition  | Cool (DBT)      | 18°C ~ 32°C  |                                    |           | -10°C ~ 43°C                        |                |              | -      |       |        |
|  | Heat (DBT)      | 16°C ~ 30°C  |                                    |           | -15°C ~ 24°C                        |                |              | -      |       |        |
| Pipe diameter mm (inch)                                    |                 | (Liquid)Ø9.52(3/8) (Gas)Ø15.88(5/8)                      |                                    |           | (Liquid)Ø9.52(3/8) (Gas)Ø15.88(5/8) |                |              | -      |       |        |
| Connecting method, Standard length m(ft)                   |                 | flared type, 5.0(16.4)                                   |                                    |           | flared type, 5.0(16.4)              |                |              | -      |       |        |
| Pipe length range m (ft)                                   |                 | 5 ~ 50m (16.4 ~ 164)                                     |                                    |           |                                     |                |              |        |       |        |
| Indoor unit & Outdoor unit height difference m (ft)        |                 | 15m(OD located lower)/30m(OD located higher) (49.2/98.4) |                                    |           |                                     |                |              |        |       |        |
| Add gas amount g/m (oz/ft)                                 |                 | 50g (0.538)  |                                    |           |                                     |                |              |        |       |        |
| Pipe length for additional gas m (ft)                      |                 | 30m (98.4)   |                                    |           |                                     |                |              |        |       |        |

\*1 In case it is necessary to indicate the air flow volume in (l/s), the value in (m³/min.) shall be multiplied by 16.7 and rounded down the decimal point.

\*2 If the EUROVENT Certified models can be operated under the "extra-low" temperature condition, -7°C dry bulb and -8°C wet-bulb temperatures with rated voltage 230V shall be used.

\*3 Network Impedance shall be applicable for EUROPE and CHINA models.

\*4 The annual consumption is calculated by multiplying the input power at 230V(400V) by an average of 500 hours per year in cooling mode.

\*5 EER and COP classification is at 230V(400V) only in accordance with EU directive 2002/31/EC.

\*6 SEER and SCOP classification is at 230V(400V) only in accordance with EN-14825. For heating, SCOP indicates the value of only Average heating season.

\*7 H: High at setting 5 stage (Level 5), M: Middle at setting 5 stage (Level 3), L: Low at setting 5 stage (Level 1)

# Simultaneous (Twin) -Type

## 1-1. Unit Specifications

**PEY1**

### 8. Ceiling Type S-50PT2E5A×2 / U-100PEY1E5

|  |  |                                     |  |             |                                       |                                     |            |      |        |       |
|--|--|-------------------------------------|--|-------------|---------------------------------------|-------------------------------------|------------|------|--------|-------|
| INDOOR   |  | MODEL                               | S-50PT2E5A×2                                   |             |                                       | -                                   |            |      | -      |       |
| PANEL  |  | MODEL                               | -  |             |                                       | -                                   |            |      | -      |       |
| OUTDOOR  |  | MODEL                               | -  |             |                                       | U-100PEY1E5                         |            |      | -      |       |
| Branch pipe  |  | MODEL                               | -  |             |                                       | CZ-P155BK1                          |            |      | -      |       |
| Performance test condition                                 |  |                                     |  |             | ISO5151 / EN14511 / EN14825 / EN12102 |                                     |            |      |        |       |
| Power supply   |  | Ø, Hz                               | 1ø 50Hz  |             |                                       | 1ø 50Hz                             |            |      |        |       |
|  |  | V                                   | 220  | 230         | 240                                   | 220                                 | 230        | 240  | Min    | Max   |
| Capacity   | kW                                       | 10.0                                | 10.0   | 10.0        | -                                     | -                                   | -          | -    | 2.7    | 11.5  |
|  | BTU/h                                    | 34100                               | 34100  | 34100       | -                                     | -                                   | -          | -    | 9200   | 39200 |
| Current  | A  | 0.39×2                              | 0.38×2   | 0.37×2      | 15.6                                  | 15.0                                | 14.4       | -    | -      | -     |
|  | W  | 40×2                                | 40×2   | 40×2        | 3.240k                                | 3.240k                              | 3.240k     | -    | -      | -     |
| Input power  | TOTAL W                                  | -                                   |  |             | 3.320k                                | 3.320k                              | 3.320k     | 530  | 4.340k | -     |
|  | Annual consumption                       | TOTAL kWh *4                        | -  |             |                                       | -                                   | 1660       | -    | -      | -     |
| EER/EER CLASS  | TOTAL (W/W) <sup>*5</sup> ("A"~"G")      | -                                   | -  | -           | 3.01                                  | 3.01 / B                            | 3.01       | 5.09 | 2.65   | -     |
| Erp *6   | Pdesign                                  | kW                                  | -  | -           | -                                     | -                                   | 10.0       | -    | -      | -     |
|  | SEER                                     | (W/W)                               | -  | -           | -                                     | -                                   | 5.9        | -    | -      | -     |
|  | Annual consumption                       | kWh                                 | -  | -           | -                                     | -                                   | 594        | -    | -      | -     |
|  | Class                                    |                                     | -  | -           | -                                     | -                                   | A+         | -    | -      | -     |
| Power factor   | %  | -                                   | -  | -           | 94                                    | 94                                  | 94         | -    | -      | -     |
| Noise indoor   | dB-A (H/M/L)                             | 37/33/29                            |  |             | -                                     |                                     |            | -    | -      | -     |
|  | Power Level dB                           | 55/51/47                            |  |             | -                                     |                                     |            | -    | -      | -     |
| Noise outdoor  | dB-A (H/L)                               | -                                   |  |             | 54/-                                  |                                     |            | -    | -      | -     |
|  | Power Level dB                           | -                                   |  |             | 70/-                                  |                                     |            | -    | -      | -     |
| Capacity   | kW                                       | 10.0                                | 10.0   | 10.0        | -                                     | -                                   | -          | 2.1  | 13.8   | -     |
|  | BTU/h                                    | 34100                               | 34100  | 34100       | -                                     | -                                   | -          | 7200 | 47100  | -     |
| Current  | A  | 0.39×2                              | 0.38×2   | 0.37×2      | 11.9                                  | 11.5                                | 11.1       | -    | -      | -     |
|  | W  | 40×2                                | 40×2   | 40×2        | 2.520k                                | 2.520k                              | 2.520k     | -    | -      | -     |
| Input power  | TOTAL W                                  | -                                   |  |             | 2.600k                                | 2.600k                              | 2.600k     | 410  | 4.000k | -     |
|  | COP/COP CLASS                            | TOTAL (W/W) <sup>*5</sup> ("A"~"G") | -  | -           | -                                     | 3.85                                | 3.85 / A   | 3.85 | 5.12   | 3.45  |
| Erp *6   | Pdesign at -10°C                         | kW                                  | -  | -           | -                                     | -                                   | 10.0       | -    | -      | -     |
|  | Tbivalent                                | °C                                  | -  | -           | -                                     | -                                   | -7         | -    | -      | -     |
|  | SCOP                                     | (W/W)                               | -  | -           | -                                     | -                                   | 3.9        | -    | -      | -     |
|  | Annual consumption                       | kWh                                 | -  | -           | -                                     | -                                   | 3590       | -    | -      | -     |
| Class  |  | -                                   | -  | -           | -                                     | A                                   | -          | -    | -      |       |
| Power factor   | %  | -                                   | -  | -           | 96                                    | 95                                  | 95         | -    | -      | -     |
| Noise indoor   | dB-A (H/M/L)                             | 37/33/29                            |  |             | -                                     |                                     |            | -    | -      | -     |
|  | Power Level dB                           | 55/51/47                            |  |             | -                                     |                                     |            | -    | -      | -     |
| Noise outdoor  | dB-A (H/L)                               | -                                   |  |             | 54/-                                  |                                     |            | -    | -      | -     |
|  | Power Level dB                           | -                                   |  |             | 70/-                                  |                                     |            | -    | -      | -     |
| EXTRA LOW TEMP   Total capacity(kW) / Input power(W) / COP |  |                                     |  |             | -                                     |                                     |            |      |        |       |
| Max Current(A) / Max Input power(W)                        |  | 0.39×2/40×2                         | 0.38×2/40×2                                    | 0.37×2/40×2 | 25.0/5.17k                            | 25.0/5.41k                          | 25.0/5.64k | -    |        |       |
| Starting current(A) / Comp output(W)                       |  | -                                   | -  | -           | 15.6/1.7k                             | 15.0/1.7k                           | 14.4/1.7k  | -    |        |       |
| Network Impedance(ΩMAX.)                                   |  | -                                   |  |             | -                                     |                                     |            | -    |        |       |
| Fan motor output (Indoor/Outdoor) W                        |  | 43                                  |  |             | 90                                    |                                     |            | -    |        |       |
| Moisture removal volume                                    |  | L/h(Pt/h)                           | 6.0  | (3.0×2)     | (12.6)                                | -                                   |            |      | -      |       |
| External static pressure                                   |  | Pa                                  | -  |             |                                       | -                                   |            |      | -      |       |
| Indoor Air flow  | Cooling                                  | m³/min (ft³/min)                    | [15/12.5/10.5 (530/441/371)]×2                 |             |                                       | -                                   |            |      | -      | -     |
|  | Heating                                  | m³/min (ft³/min)                    | [15/12.5/10.5 (530/441/371)]×2                 |             |                                       | -                                   |            |      | -      | -     |
| Outdoor Air flow   | Cooling                                  | m³/min (ft³/min)                    | -  |             |                                       | 76                                  | (2684)     | -    | -      |       |
|  | Heating                                  | m³/min (ft³/min)                    | -  |             |                                       | 67                                  | (2366)     | -    | -      |       |
| Refrigerant type / amount g(oz)                            |  | -                                   |  |             | R410A                                 | 2.60k                               | (91.7)     | -    |        |       |
| Product dimension  | Height                                   | mm(inch)                            | 235 (9-1/4)                                    |             |                                       | 996 (39-7/32)                       |            |      | -      |       |
|  | Width                                    | mm(inch)                            | 960 (37-25/32)                                 |             |                                       | 940 (37-1/32)                       |            |      | -      |       |
|  | Depth                                    | mm(inch)                            | 690 (27-5/32)                                  |             |                                       | 340 (13-13/32)                      |            |      | -      |       |
| Packing dimension  | Height                                   | mm(inch)                            | 360  |             |                                       | 1136                                |            |      | -      |       |
|  | Width                                    | mm(inch)                            | 1025   |             |                                       | 1055                                |            |      | -      |       |
|  | Depth                                    | mm(inch)                            | 820  |             |                                       | 485                                 |            |      | -      |       |
| Weight   | (NET)                                    | kg(lb)                              | 27 (60)  |             |                                       | 73 (161)                            |            |      | -      |       |
|  | (GROSS)                                  | kg(lb)                              | 34 (75)  |             |                                       | 81 (179)                            |            |      | -      |       |
| Layers limit (actually)                                    |  |                                     | 9 (10)   |             |                                       | 2 (3)                               |            |      | -      |       |
| Operation condition  | Cool (DBT)                               |                                     | 18°C ~ 32°C                                    |             |                                       | -10°C ~ 43°C                        |            |      | -      |       |
|  | Heat (DBT)                               |                                     | 16°C ~ 30°C                                    |             |                                       | -15°C ~ 24°C                        |            |      | -      |       |
| P I P I N G  | Pipe diameter mm (inch)                  |                                     | (Liquid)ø6.35(1/4) (Gas)ø12.7(1/2)             |             |                                       | (Liquid)ø9.52(3/8) (Gas)ø15.88(5/8) |            |      | -      |       |
|  | Connecting method, Standard length m(ft) |                                     | flared type, 5.0(16.4)                         |             |                                       | flared type, 5.0(16.4)              |            |      | -      |       |
| Pipe length range  |  | m (ft)                              | 5 ~ 50 (16.4 ~ 164.0)                          |             |                                       | -                                   |            |      | -      |       |
| Indoor unit & Outdoor unit height difference               |  | m (ft)                              | 15 (OD located lower) / 30 (OD located higher) |             |                                       | (49.2/98.4)                         |            |      | -      |       |
| Add gas amount   |  | g/m (oz/ft)                         | 50 (0.538)                                     |             |                                       | -                                   |            |      | -      |       |
| Pipe length for additional gas                             |  | m (ft)                              | 30 (98.4)                                      |             |                                       | -                                   |            |      | -      |       |

\*1: In case it is necessary to indicate the air flow volume in (l/s), the value in (m³/min.) shall be multiplied by 16.7 and rounded down the decimal point.  
 \*2: If the EUROVENT Certified models can be operated under the "extra-low" temperature condition, -7°C dry bulb and -8°C wet-bulb temperatures with rated voltage 230 V shall be used.  
 \*3: Network Impedance shall be applicable for EUROPE and CHINA models.  
 \*4: The annual consumption is calculated by multiplying the input power at 230 V (400 V) by an average of 500 hours per year in cooling mode.  
 \*5: EER and COP classification is at 230 V (400 V) only in accordance with EU directive 2002/31/EC.  
 \*6: SEER and SCOP classification is at 230V(400V) only in accordance with EN-14825. For heating, SCOP indicates the value of only Average heating season, Other fiche data indicates in an attached sheet.

# Single -Type

## 1-1. Unit Specifications

**PEY2**

### 8. Ceiling Type S-60PT2E5A / U-60PEY2E5

| INDOOR   | MODEL   | S-60PT2E5A                                       |  |           | -                                   |            |            | -      |      |        |
|--|---|--|--|-----------|-------------------------------------|------------|------------|--------|------|--------|
| PANEL  | MODEL   | -  |  |           | -                                   |            |            | -      |      |        |
| OUTDOOR  | MODEL   | -  |  |           | U-60PEY2E5                          |            |            | -      |      |        |
| Branch pipe  | MODEL   | -  |  |           | -                                   |            |            | -      |      |        |
| Performance test condition                                 |   | ISO5151 / EN14511 / EN12102 / EN14825            |  |           |                                     |            |            |        |      |        |
| Power supply   |   | Ø, Hz  | 1ø 50Hz                                |           |                                     | 1ø 50Hz    |            |        | Min  | Max    |
|  |   | V  | 220V                                   | 230V      | 240V                                | 220V       | 230V       | 240V   |      |        |
| C<br>O<br>O<br>L<br>I<br>N<br>G                            | Capacity  | kW   | 6.0                                    | 6.0       | 6.0                                 | -          | -          | -      | 2.0  | 7.1    |
|  |   | BTU/h  | 20500                                  | 20500     | 20500                               | -          | -          | -      | 6800 | 24200  |
|  | Current   | A  | 0.42                                   | 0.41      | 0.40                                | 8.00       | 7.60       | 7.30   | -    | -      |
|  | Input power   | W  | 50                                     | 50        | 50                                  | 1.580k     | 1.580k     | 1.580k | -    | -      |
|  |   | TOTAL W  | -                                      |           |                                     | 1.630k     | 1.630k     | 1.630k | 250  | 2.250k |
|  | Annual consumption                                  | TOTAL kWh *4                                     | -                                      |           |                                     | -          | 815        | -      | -    | -      |
|  | EER/EER CLASS                                       | TOTAL (W/W) <sup>5</sup> ("A"~"G")               | -                                      | -         | -                                   | 3.68       | 3.68/A     | 3.68   | 8.00 | 3.16   |
|  | Erp <sup>6</sup>                                    | Pdesign  | kW                                     | -         | -                                   | -          | 6.0        | -      | -    | -      |
|  |   | SEER   | (W/W)                                  | -         | -                                   | -          | 6.7        | -      | -    | -      |
|  |   | Annual consumption                               | kWh                                    | -         | -                                   | -          | 313        | -      | -    | -      |
| Class  |   |  | -                                      | -         | -                                   | A++        | -          | -      | -    |        |
| Power factor   | %   | -  | -                                      | -         | 90                                  | 90         | 90         | -      | -    |        |
| Noise indoor   | dB-A (H/M/L)  | 38/34/30   |  |           | -                                   |            |            | -      | -    |        |
|  | Power Level dB                                      | 56/52/48   |  |           | -                                   |            |            | -      | -    |        |
| Noise outdoor  | dB-A (H/L)  | -  |  |           | 46/-                                |            |            | -      | -    |        |
|  | Power Level dB                                      | -  |  |           | 65/-                                |            |            | -      | -    |        |
| H<br>E<br>A<br>T<br>I<br>N<br>G                            | Capacity  | kW   | 6.0                                    | 6.0       | 6.0                                 | -          | -          | -      | 1.8  | 7.0    |
|  |   | BTU/h  | 20500                                  | 20500     | 20500                               | -          | -          | -      | 6100 | 23900  |
|  | Current   | A  | 0.42                                   | 0.41      | 0.40                                | 6.70       | 6.45       | 6.15   | -    | -      |
|  | Input power   | W  | 50                                     | 50        | 50                                  | 1.330k     | 1.330k     | 1.330k | -    | -      |
|  |   | TOTAL W  | -                                      |           |                                     | 1.380k     | 1.380k     | 1.380k | 200  | 1.600k |
|  | COP/COP CLASS                                       | TOTAL (W/W) <sup>5</sup> ("A"~"G")               | -                                      | -         | -                                   | 4.35       | 4.35/A     | 4.35   | 9.00 | 4.38   |
|  | Erp <sup>6</sup>                                    | Pdesign at -10°C                                 | kW                                     | -         | -                                   | -          | 6.0        | -      | -    | -      |
|  |   | Tbivalent  | °C                                     | -         | -                                   | -          | -8         | -      | -    | -      |
|  |   | SCOP   | (W/W)                                  | -         | -                                   | -          | 4.0        | -      | -    | -      |
|  |   | Annual consumption                               | kWh                                    | -         | -                                   | -          | 2100       | -      | -    | -      |
| Class  |   | -  | -                                      | -         | A+                                  | -          | -          | -      |      |        |
| Power factor   | %   | -  | -                                      | -         | 90                                  | 90         | 90         | -      | -    |        |
| Noise indoor   | dB-A (H/M/L)  | 38/34/30   |  |           | -                                   |            |            | -      | -    |        |
|  | Power Level dB                                      | 56/52/48   |  |           | -                                   |            |            | -      | -    |        |
| Noise outdoor  | dB-A (H/L)  | -  |  |           | 48/-                                |            |            | -      | -    |        |
|  | Power Level dB                                      | -  |  |           | 68/-                                |            |            | -      | -    |        |
| EXTRA LOW TEMP   Total capacity(kW) / Input power(W) / COP |   | -  |  |           |                                     |            |            |        |      |        |
| Max Current(A) / Max Input power(W)                        |   | 0.42/50  | 0.41/50                                | 0.40/50   | 16.5/3.27k                          | 16.5/3.42k | 16.5/3.57k | -      |      |        |
| Starting current(A) / Comp output(W)                       |   | -  | -                                      | -         | 8.00/1.7k                           | 7.60/1.7k  | 7.30/1.7k  | -      |      |        |
| Network Impedance(ΩMAX.)                                   |   | -  |  |           |                                     |            |            |        |      |        |
| Fan motor output (Indoor/Outdoor) W                        |   | 74   |  |           | 60                                  |            |            | -      |      |        |
| Moisture removal volume                                    |   | L/h(Pt/h)  | 3.4                                    | (7.1)     | -                                   |            |            | -      |      |        |
| External static pressure                                   |   | Pa   | -                                      |           |                                     | -          |            |        | -    |        |
| Indoor Air flow  | Cooling   | m³/min (ft³/min)                                 | 20.0 / 17.0 / 14.5 (706) / (600)/(512) |           |                                     | -          |            |        | -    | -      |
|  | Heating   | m³/min (ft³/min)                                 | 20.0 / 17.0 / 14.5 (706) / (600)/(512) |           |                                     | -          |            |        | -    | -      |
| Outdoor Air flow   | Cooling   | m³/min (ft³/min)                                 | -                                      |           |                                     | 38         | (1342)     | -      | -    |        |
|  | Heating   | m³/min (ft³/min)                                 | -                                      |           |                                     | 41         | (1448)     | -      | -    |        |
| Refrigerant type / amount g(oz)                            |   | -  |  |           | R410A                               | 1.95k      | (68.8)     | -      |      |        |
| Product dimension  | Height  | mm(inch)   | 235                                    | (9-1/4)   | 619                                 | (24-3/8)   | -          |        |      |        |
|  | Width   | mm(inch)   | 1275                                   | (50-3/16) | 799                                 | (31-29/64) | -          |        |      |        |
|  | Depth   | mm(inch)   | 690                                    | (27-5/32) | 299                                 | (11-49/64) | -          |        |      |        |
| Product dimension (Panel)                                  |   | H×W×D mm, inch                                   | -                                      |           |                                     | -          |            |        | -    |        |
| Packing dimension  | Height  | mm(inch)   | 360                                    |           |                                     | 688        |            |        | -    |        |
|  | Width   | mm(inch)   | 1340                                   |           |                                     | 931        |            |        | -    |        |
|  | Depth   | mm(inch)   | 820                                    |           |                                     | 422        |            |        | -    |        |
| Weight   | (NET)   | kg(lb)   | 33                                     | (73)      | 40                                  | (88)       | -          |        |      |        |
|  | (GROSS)   | kg(lb)   | 42                                     | (93)      | 45                                  | (99)       | -          |        |      |        |
|  | Panel (NET)   | kg(lb)   | -                                      |           |                                     | -          |            |        | -    |        |
| Layers limit (actually)                                    |   | 9 (10)   |  |           | 5 (6)                               |            |            | -      |      |        |
| Operation condition  | Cool (DBT)  | 18°C ~ 32°C                                      |  |           | -10°C ~ 43°C                        |            |            | -      |      |        |
|  | Heat (DBT)  | 16°C ~ 30°C                                      |  |           | -15°C ~ 24°C                        |            |            | -      |      |        |
| P<br>I<br>P<br>I<br>N<br>G                                 | Pipe diameter mm (inch)                             | (Liquid)ø9.52(3/8) (Gas)ø15.88(5/8)              |  |           | (Liquid)ø9.52(3/8) (Gas)ø15.88(5/8) |            |            | -      |      |        |
|  | Connecting method, Standard length m(ft)            | flared type, 5.0(16.4)                           |  |           | flared type, 5.0(16.4)              |            |            | -      |      |        |
|  | Pipe length range m (ft)                            | 3 ~ 40m (9.8 ~ 131.2)                            |  |           | -                                   |            |            | -      |      |        |
|  | Indoor unit & Outdoor unit height difference m (ft) | 15m (OD located lower) / 30m (OD located higher) |  |           | (49.2/98.4)                         |            |            | -      |      |        |
|  | Add gas amount g/m (oz/ft)                          | 40g (0.430)                                      |  |           | -                                   |            |            | -      |      |        |
|  | Pipe length for additional gas m (ft)               | 30m (98.4)                                       |  |           | -                                   |            |            | -      |      |        |

\*1: In case it is necessary to indicate the air flow volume in (l/s), the value in (m³/min.) shall be multiplied by 16.7 and rounded down the decimal point.

\*2: If the EUROVENT Certified models can be operated under the "extra-low" temperature condition, -7°C dry bulb and -8°C wet-bulb temperatures with rated voltage 230 V shall be used.

\*3: Network Impedance shall be applicable for EUROPE and CHINA models.

\*4: The annual consumption is calculated by multiplying the input power at 230V (400V) by an average of 500 hours per year in cooling mode.

\*5: EER and COP classification is at 230V (400V) only in accordance with EU directive 2002/31/EC.

\*6: SEER and SCOP classification is at 230V (400V) only in accordance with EN-14825. For heating, SCOP indicates the value of only Average heating season, Other fiche data indicates in an attached sheet.

# Simultaneous (Twin) -Type

## 1-1. Unit Specifications

**PEY1**

### 8. Ceiling Type S-60PT2E5A×2 / U-125PEY1E5

|  |  |  |                              |                       |                                     |                |            |          |       |        |      |
|--|--|--|------------------------------|-----------------------|-------------------------------------|----------------|------------|----------|-------|--------|------|
| INDOOR   |  | MODEL  | S-60PT2E5A×2                 |                       |                                     | -              |            |          | -     |        |      |
| PANEL  |  | MODEL  | -                            |                       |                                     | -              |            |          | -     |        |      |
| OUTDOOR  |  | MODEL  | -                            |                       |                                     | U-125PEY1E5    |            |          | -     |        |      |
| Branch pipe  |  | MODEL  | -                            |                       |                                     | CZ-P155BK1     |            |          | -     |        |      |
| Performance test condition                                 |  | ISO5151 / EN14511 / EN12102 / EN14825          |                              |                       |                                     |                |            |          |       |        |      |
| Power supply   |  | Ø, Hz  | 1ø 50Hz                      |                       |                                     | 1ø 50Hz        |            |          |       |        |      |
|  |  | V  | 220                          | 230                   | 240                                 | 220            | 230        | 240      | Min   | Max    |      |
| C<br>O<br>O<br>L<br>I<br>N<br>G                            | Capacity                                 | kW   | 12.5                         | 12.5                  | 12.5                                | -              | -          | -        | 3.8   | 13.5   |      |
|  |  | BTU/h  | 42700                        | 42700                 | 42700                               | -              | -          | -        | 13000 | 46100  |      |
|  | Current                                  | A  | 0.42×2                       | 0.41×2                | 0.40×2                              | 19.7           | 18.9       | 18.1     | -     | -      |      |
|  |  | W  | 50×2                         | 50×2                  | 50×2                                | 4.050k         | 4.050k     | 4.050k   | -     | -      |      |
|  | Input power                              | TOTAL W  | -                            |                       |                                     | 4.150k         | 4.150k     | 4.150k   | 900   | 5.160k |      |
|  |  | Annual consumption                             | TOTAL kWh *4                 | -                     |                                     |                | -          | 2075     | -     | -      | -    |
|  | EER/EER CLASS                            | TOTAL (W/W) *5 ("A"~"G")                       | -                            | -                     | -                                   | 3.01           | 3.01 / B   | 3.01     | 4.22  | 2.62   |      |
|  | E<br>r<br>p<br>*6                        | Pdesign  | kW                           | -                     | -                                   | -              | -          | 12.5     | -     | -      | -    |
|  |  | η <sub>s.c</sub>                               | %                            | -                     | -                                   | -              | -          | 218.3    | -     | -      | -    |
|  |  | Annual consumption                             | kWh                          | -                     | -                                   | -              | -          | -        | -     | -      | -    |
| Class  |  |  | -                            | -                     | -                                   | -              | -          | -        | -     | -      |      |
| Power factor   | %  | -  | -                            | -                     | 93                                  | 93             | 93         | -        | -     |        |      |
| Noise indoor   | dB-A (H/M/L)                             | 38/34/30                                       |                              |                       | -                                   |                |            | -        | -     |        |      |
|  | Power Level dB                           | 56/52/48                                       |                              |                       | -                                   |                |            | -        | -     |        |      |
| Noise outdoor  | dB-A (H/L)                               | -  |                              |                       | 56/-                                |                |            | -        | -     |        |      |
|  | Power Level dB                           | -  |                              |                       | 73/-                                |                |            | -        | -     |        |      |
| H<br>E<br>A<br>T<br>I<br>N<br>G                            | Capacity                                 | kW   | 12.5                         | 12.5                  | 12.5                                | -              | -          | -        | 3.4   | 15.0   |      |
|  |  | BTU/h  | 42700                        | 42700                 | 42700                               | -              | -          | -        | 11600 | 51200  |      |
|  | Current                                  | A  | 0.42×2                       | 0.41×2                | 0.40×2                              | 15.2           | 14.6       | 13.9     | -     | -      |      |
|  |  | W  | 50×2                         | 50×2                  | 50×2                                | 3.150k         | 3.150k     | 3.150k   | -     | -      |      |
|  | Input power                              | TOTAL W  | -                            |                       |                                     | 3.250k         | 3.250k     | 3.250k   | 730   | 4.400k |      |
|  |  | COP/COP CLASS                                  | TOTAL (W/W) *5 ("A"~"G")     | -                     | -                                   | -              | 3.85       | 3.85 / A | 3.85  | 4.66   | 3.41 |
|  | E<br>r<br>p<br>*6                        | Pdesign at -10°C                               | kW                           | -                     | -                                   | -              | -          | 12.5     | -     | -      | -    |
|  |  | Tbivalent                                      | °C                           | -                     | -                                   | -              | -          | -7       | -     | -      | -    |
|  |  | η <sub>s.h</sub>                               | %                            | -                     | -                                   | -              | -          | 140.5    | -     | -      | -    |
|  |  | Annual consumption                             | kWh                          | -                     | -                                   | -              | -          | -        | -     | -      | -    |
| Class  |  | -  | -                            | -                     | -                                   | -              | -          | -        | -     |        |      |
| Power factor   | %  | -  | -                            | -                     | 94                                  | 94             | 94         | -        | -     |        |      |
| Noise indoor   | dB-A (H/M/L)                             | 38/34/30                                       |                              |                       | -                                   |                |            | -        | -     |        |      |
|  | Power Level dB                           | 56/52/48                                       |                              |                       | -                                   |                |            | -        | -     |        |      |
| Noise outdoor  | dB-A (H/L)                               | -  |                              |                       | 56/-                                |                |            | -        | -     |        |      |
|  | Power Level dB                           | -  |                              |                       | 73/-                                |                |            | -        | -     |        |      |
| EXTRA LOW TEMP   Total capacity(kW) / Input power(W) / COP |  | -  |                              |                       |                                     |                |            |          |       |        |      |
| Max Current(A) / Max Input power(W)                        |  | 0.42×2/50×2                                    | 0.41×2/50×2                  | 0.40×2/50×2           | 29.0/5.93k                          | 29.0/6.20k     | 29.0/6.47k | -        |       |        |      |
| Starting current(A) / Comp output(W)                       |  | -  | -                            | -                     | 19.7/3.0k                           | 18.9/3.0k      | 18.1/3.0k  | -        |       |        |      |
| Network Impedance(ΩMAX.)                                   |  | -  |                              |                       |                                     |                |            |          |       |        |      |
| Fan motor output (Indoor/Outdoor) W                        |  | 74   |                              |                       | 90                                  |                |            | -        |       |        |      |
| Moisture removal volume                                    |  | L/h(Pt/h)                                      | 7.9                          | (3.95×2)              | (16.6)                              | -              |            |          | -     |        |      |
| External static pressure                                   |  | Pa   | -                            |                       |                                     | -              |            |          | -     |        |      |
| Indoor Air flow  | Cooling                                  | m³/min (ft³/min)                               | [20/17/14.5 (706/600/512)]×2 |                       |                                     | -              |            |          | -     |        |      |
|  | Heating                                  | m³/min (ft³/min)                               | [20/17/14.5 (706/600/512)]×2 |                       |                                     | -              |            |          | -     |        |      |
| Outdoor Air flow   | Cooling                                  | m³/min (ft³/min)                               | -                            |                       |                                     | 80             | (2825)     | -        |       |        |      |
|  | Heating                                  | m³/min (ft³/min)                               | -                            |                       |                                     | 73             | (2578)     | -        |       |        |      |
| Refrigerant type / amount g(oz)                            |  | -  |                              |                       | R410A                               | 3.20k          | (112.9)    | -        |       |        |      |
| Product dimension  | Height                                   | mm(inch)                                       | 235 (9-1/4)                  |                       |                                     | 996 (39-7/32)  |            |          | -     |        |      |
|  | Width                                    | mm(inch)                                       | 1275 (50-3/16)               |                       |                                     | 940 (37-1/32)  |            |          | -     |        |      |
|  | Depth                                    | mm(inch)                                       | 690 (27-5/32)                |                       |                                     | 340 (13-13/32) |            |          | -     |        |      |
| Packing dimension  | Height                                   | mm(inch)                                       | 360                          |                       |                                     | 1136           |            |          | -     |        |      |
|  | Width                                    | mm(inch)                                       | 1340                         |                       |                                     | 1055           |            |          | -     |        |      |
|  | Depth                                    | mm(inch)                                       | 820                          |                       |                                     | 485            |            |          | -     |        |      |
| Weight   | (NET)                                    | kg(lb)   | 33 (73)                      |                       |                                     | 85 (187)       |            |          | -     |        |      |
|  | (GROSS)                                  | kg(lb)   | 42 (93)                      |                       |                                     | 93 (205)       |            |          | -     |        |      |
| Layers limit (actually)                                    |  | 9 (10)   |                              |                       | 2 (3)                               |                |            | -        |       |        |      |
| Operation condition  | Cool (DBT)                               | 18°C ~ 32°C                                    |                              |                       | -10°C ~ 43°C                        |                |            | -        |       |        |      |
|  | Heat (DBT)                               | 16°C ~ 30°C                                    |                              |                       | -15°C ~ 24°C                        |                |            | -        |       |        |      |
| P<br>I<br>P<br>I<br>N<br>G                                 | Pipe diameter mm (inch)                  | (Liquid)ø9.52(3/8) (Gas)ø15.88(5/8)            |                              |                       | (Liquid)ø9.52(3/8) (Gas)ø15.88(5/8) |                |            | -        |       |        |      |
|  | Connecting method, Standard length m(ft) | flared type, 5.0(16.4)                         |                              |                       | flared type, 5.0(16.4)              |                |            | -        |       |        |      |
| Pipe length range  |  | m (ft)   |                              | 5 ~ 50 (16.4 ~ 164.0) |                                     | -              |            |          |       |        |      |
| Indoor unit & Outdoor unit height difference m (ft)        |  | 15 (OD located lower) / 30 (OD located higher) |                              |                       | (49.2/98.4)                         |                |            | -        |       |        |      |
| Add gas amount g/m (oz/ft)                                 |  | 50 (0.538)                                     |                              |                       | -                                   |                |            | -        |       |        |      |
| Pipe length for additional gas                             |  | m (ft)   |                              | 30 (98.4)             |                                     | -              |            |          |       |        |      |

\*1: In case it is necessary to indicate the air flow volume in (l/s), the value in (m³/min.) shall be multiplied by 16.7 and rounded down the decimal point.  
 \*2: If the EUROVENT Certified models can be operated under the "extra-low" temperature condition, -7°C dry bulb and -8°C wet-bulb temperatures with rated voltage 230 V shall be used.  
 \*3: Network Impedance shall be applicable for EUROPE and CHINA models.  
 \*4: The annual consumption is calculated by multiplying the input power at 230 V (400 V) by an average of 500 hours per year in cooling mode.  
 \*5: EER and COP classification is at 230 V (400 V) only in accordance with EU directive 2002/31/EC.  
 \*6: SEER and SCOP classification is at 230V(400V) only in accordance with EN-14825. For heating, SCOP indicates the value of only Average heating season.

# Single -Type

## 1-1. Unit Specifications

**PEY2**

### 8. Ceiling Type S-71PT2E5A / U-71PEY2E5

| INDOOR   |   | MODEL                               | S-71PT2E5A                                       |             |                                       | -                                   |            |        | -    |        |   |
|--|---|-------------------------------------|--|-------------|---------------------------------------|-------------------------------------|------------|--------|------|--------|---|
| PANEL  |   | MODEL                               | -  |             |                                       | -                                   |            |        | -    |        |   |
| OUTDOOR  |   | MODEL                               | -  |             |                                       | U-71PEY2E5                          |            |        | -    |        |   |
| Branch pipe  |   | MODEL                               | -  |             |                                       | -                                   |            |        | -    |        |   |
| Performance test condition                                 |   |                                     |  |             | ISO5151 / EN14511 / EN12102 / EN14825 |                                     |            |        |      |        |   |
| Power supply   |   | Ø, Hz                               | 1ø 50Hz  |             |                                       | 1ø 50Hz                             |            |        |      |        |   |
|  |   | V                                   | 220V   | 230V        | 240V                                  | 220V                                | 230V       | 240V   | Min  | Max    |   |
| C<br>O<br>O<br>L<br>I<br>N<br>G                            | Capacity  | kW                                  | 7.1  | 7.1         | 7.1                                   | -                                   | -          | -      | 2.0  | 7.7    |   |
|  |   | BTU/h                               | 24200  | 24200       | 24200                                 | -                                   | -          | -      | 6800 | 26300  |   |
|  | Current   | A                                   | 0.45   | 0.44        | 0.43                                  | 10.8                                | 10.3       | 9.85   | -    | -      |   |
|  | Input power   | W                                   | 55   | 55          | 55                                    | 2.155k                              | 2.155k     | 2.155k | -    | -      |   |
|  |   | TOTAL W                             | -  | -           | -                                     | 2.210k                              | 2.210k     | 2.210k | 250  | 2.650k |   |
|  | Annual consumption                                  | TOTAL kWh *4                        | -  | -           | -                                     | -                                   | 1105       | -      | -    | -      |   |
|  | EER/EER CLASS                                       | TOTAL (W/W) <sup>*5</sup> ("A"~"G") | -  | -           | -                                     | 3.21                                | 3.21/A     | 3.21   | 8.00 | 2.91   |   |
|  | Erp <sup>*6</sup>                                   | Pdesign                             | kW   | -           | -                                     | -                                   | -          | 7.1    | -    | -      | - |
|  |   | SEER                                | (W/W)  | -           | -                                     | -                                   | -          | 6.1    | -    | -      | - |
|  |   | Annual consumption                  | kWh  | -           | -                                     | -                                   | -          | 407    | -    | -      | - |
| Class  |   |                                     | -  | -           | -                                     | -                                   | A++        | -      | -    | -      |   |
| Power factor   | %   | -                                   | -  | -           | 91                                    | 91                                  | 91         | -      | -    |        |   |
| Noise indoor   | dB-A (H/M/L)  | 39/35/31                            |  |             | -                                     |                                     |            | -      | -    |        |   |
|  | Power Level dB                                      | 57/53/49                            |  |             | -                                     |                                     |            | -      | -    |        |   |
| Noise outdoor  | dB-A (H/L)  | -                                   |  |             | 49/-                                  |                                     |            | -      | -    |        |   |
|  | Power Level dB                                      | -                                   |  |             | 69/-                                  |                                     |            | -      | -    |        |   |
| H<br>E<br>A<br>T<br>I<br>N<br>G                            | Capacity  | kW                                  | 7.1  | 7.1         | 7.1                                   | -                                   | -          | -      | 1.8  | 8.1    |   |
|  |   | BTU/h                               | 24200  | 24200       | 24200                                 | -                                   | -          | -      | 6100 | 27600  |   |
|  | Current   | A                                   | 0.45   | 0.44        | 0.43                                  | 8.20                                | 7.85       | 7.50   | -    | -      |   |
|  | Input power   | W                                   | 55   | 55          | 55                                    | 1.625k                              | 1.625k     | 1.625k | -    | -      |   |
|  |   | TOTAL W                             | -  | -           | -                                     | 1.680k                              | 1.680k     | 1.680k | 200  | 2.150k |   |
|  | COP/COP CLASS                                       | TOTAL (W/W) <sup>*5</sup> ("A"~"G") | -  | -           | -                                     | 4.23                                | 4.23/A     | 4.23   | 9.00 | 3.77   |   |
|  | Erp <sup>*6</sup>                                   | Pdesign at -10°C                    | kW   | -           | -                                     | -                                   | -          | 6.0    | -    | -      | - |
|  |   | Tbivalent                           | °C   | -           | -                                     | -                                   | -          | -8     | -    | -      | - |
|  |   | SCOP                                | (W/W)  | -           | -                                     | -                                   | -          | 4.0    | -    | -      | - |
|  |   | Annual consumption                  | kWh  | -           | -                                     | -                                   | -          | 2100   | -    | -      | - |
| Class  |   | -                                   | -  | -           | -                                     | A+                                  | -          | -      | -    |        |   |
| Power factor   | %   | -                                   | -  | -           | 90                                    | 90                                  | 90         | -      | -    |        |   |
| Noise indoor   | dB-A (H/M/L)  | 39/35/31                            |  |             | -                                     |                                     |            | -      | -    |        |   |
|  | Power Level dB                                      | 57/53/49                            |  |             | -                                     |                                     |            | -      | -    |        |   |
| Noise outdoor  | dB-A (H/L)  | -                                   |  |             | 49/-                                  |                                     |            | -      | -    |        |   |
|  | Power Level dB                                      | -                                   |  |             | 69/-                                  |                                     |            | -      | -    |        |   |
| EXTRA LOW TEMP   Total capacity(kW) / Input power(W) / COP |   |                                     |  |             |                                       |                                     |            |        |      |        |   |
| Max Current(A) / Max Input power(W)                        |   | 0.45/55                             | 0.44/55  | 0.43/55     | 16.5/3.27k                            | 16.5/3.42k                          | 16.5/3.57k |        |      |        |   |
| Starting current(A) / Comp output(W)                       |   | -                                   | -  | -           | 10.8/2.0k                             | 10.3/2.0k                           | 9.85/2.0k  |        |      |        |   |
| Network Impedance(ΩMAX.)                                   |   |                                     |  |             |                                       |                                     |            |        |      |        |   |
| Fan motor output (Indoor/Outdoor) W                        |   |                                     |  | 74          |                                       | 60                                  |            |        |      |        |   |
| Moisture removal volume                                    |   | L/h(Pt/h)                           | 4.2  | (8.8)       |                                       |                                     |            |        |      |        |   |
| External static pressure                                   |   | Pa                                  |  |             |                                       |                                     |            |        |      |        |   |
| Indoor Air flow  | Cooling   | m³/min (ft³/min)                    | 21.0 / 18.0 / 15.5 (742) / (636) / (547)         |             |                                       |                                     |            |        | -    | -      |   |
|  | Heating   | m³/min (ft³/min)                    | 21.0 / 18.0 / 15.5 (742) / (636) / (547)         |             |                                       |                                     |            |        | -    | -      |   |
| Outdoor Air flow   | Cooling   | m³/min (ft³/min)                    | -  |             |                                       | 44 (1554)                           |            | -      | -    |        |   |
|  | Heating   | m³/min (ft³/min)                    | -  |             |                                       | 41 (1448)                           |            | -      | -    |        |   |
| Refrigerant type / amount g(oz)                            |   |                                     |  |             |                                       | R410A                               | 1.95k      | (68.8) |      |        |   |
| Product dimension  | Height  | mm(inch)                            | 235  | (9-1/4)     |                                       | 619                                 | (24-3/8)   |        | -    |        |   |
|  | Width   | mm(inch)                            | 1275   | (50-3/16)   |                                       | 799                                 | (31-29/64) |        | -    |        |   |
|  | Depth   | mm(inch)                            | 690  | (27-5/32)   |                                       | 299                                 | (11-49/64) |        | -    |        |   |
| Product dimension (Panel)                                  |   | H×W×D mm, inch                      |  |             |                                       |                                     |            |        | -    |        |   |
| Packing dimension  | Height  | mm(inch)                            | 360  |             | 688                                   |                                     |            |        | -    |        |   |
|  | Width   | mm(inch)                            | 1340   |             | 931                                   |                                     |            |        | -    |        |   |
|  | Depth   | mm(inch)                            | 820  |             | 422                                   |                                     |            |        | -    |        |   |
| Weight   | (NET)   | kg(lb)                              | 33   | (73)        |                                       | 40                                  | (88)       |        | -    |        |   |
|  | (GROSS)   | kg(lb)                              | 42   | (93)        |                                       | 45                                  | (99)       |        | -    |        |   |
|  | Panel (NET)   | kg(lb)                              |  |             |                                       |                                     |            |        | -    |        |   |
| Layers limit (actually)                                    |   |                                     |  | 9 (10)      |                                       | 5 (6)                               |            |        |      |        |   |
| Operation condition  | Cool (DBT)  |                                     |  | 18°C ~ 32°C |                                       | -10°C ~ 43°C                        |            |        |      |        |   |
|  | Heat (DBT)  |                                     |  | 16°C ~ 30°C |                                       | -15°C ~ 24°C                        |            |        |      |        |   |
| P<br>I<br>P<br>I<br>N<br>G                                 | Pipe diameter mm (inch)                             |                                     | (Liquid)ø9.52(3/8) (Gas)ø15.88(5/8)              |             |                                       | (Liquid)ø9.52(3/8) (Gas)ø15.88(5/8) |            |        |      |        |   |
|  | Connecting method, Standard length m(ft)            |                                     | flared type, 5.0(16.4)                           |             |                                       | flared type, 5.0(16.4)              |            |        |      |        |   |
|  | Pipe length range m (ft)                            |                                     | 3 ~ 40m (9.8 ~ 131.2)                            |             |                                       |                                     |            |        |      |        |   |
|  | Indoor unit & Outdoor unit height difference m (ft) |                                     | 15m (OD located lower) / 30m (OD located higher) |             |                                       | (49.2/98.4)                         |            |        |      |        |   |
| Add gas amount g/m (oz/ft)                                 |   |                                     |  | 40g (0.430) |                                       |                                     |            |        |      |        |   |
| Pipe length for additional gas m (ft)                      |   |                                     |  | 30m (98.4)  |                                       |                                     |            |        |      |        |   |

\*1: In case it is necessary to indicate the air flow volume in (l/s), the value in (m³/min.) shall be multiplied by 16.7 and rounded down the decimal point.

\*2: If the EUROVENT Certified models can be operated under the "extra-low" temperature condition, -7°C dry bulb and -8°C wet-bulb temperatures with rated voltage 230 V shall be used.

\*3: Network Impedance shall be applicable for EUROPE and CHINA models.

\*4: The annual consumption is calculated by multiplying the input power at 230V (400V) by an average of 500 hours per year in cooling mode.

\*5: EER and COP classification is at 230V (400V) only in accordance with EU directive 2002/31/EC.

\*6: SEER and SCOP classification is at 230V (400V) only in accordance with EN-14825. For heating, SCOP indicates the value of only Average heating season, Other fiche data indicates in an attached sheet.

# Single -Type

## 1-1. Unit Specifications

**PEY1**

### 8. Ceiling Type S-100PT2E5A / U-100PEY1E5

|                                       |   |   |  |         |                                       |                                     |            |      |        |       |  |
|---------------------------------------|---|---|--|---------|---------------------------------------|-------------------------------------|------------|------|--------|-------|--|
| INDOOR                                |   | MODEL                                     | S-100PT2E5A                                    |         |                                       | -                                   |            |      | -      |       |  |
| PANEL                                 |   | MODEL                                     | -  |         |                                       | -                                   |            |      | -      |       |  |
| OUTDOOR                               |   | MODEL                                     | -  |         |                                       | U-100PEY1E5                         |            |      | -      |       |  |
| Branch pipe                           |   | MODEL                                     | -  |         |                                       | -                                   |            |      | -      |       |  |
| Performance test condition            |   |   |  |         | ISO5151 / EN14511 / EN14825 / EN12102 |                                     |            |      |        |       |  |
| Power supply                          |   | Ø, Hz                                     | 1ø 50Hz  |         |                                       | 1ø 50Hz                             |            |      |        |       |  |
|                                       |   | V   | 220  | 230     | 240                                   | 220                                 | 230        | 240  | Min    | Max   |  |
| Capacity                              | kW  | 10.0                                      | 10.0   | 10.0    | -                                     | -                                   | -          | -    | 2.7    | 11.5  |  |
|                                       | BTU/h   | 34100                                     | 34100  | 34100   | -                                     | -                                   | -          | -    | 9200   | 39200 |  |
| Current                               | A   | 0.69                                      | 0.67   | 0.65    | 15.6                                  | 15.0                                | 14.4       | -    | -      | -     |  |
|                                       | W   | 80  | 80   | 80      | 3.240k                                | 3.240k                              | 3.240k     | -    | -      | -     |  |
| Input power                           | TOTAL W   | -   | -  | -       | 3.320k                                | 3.320k                              | 3.320k     | 530  | 4.340k | -     |  |
|                                       | Annual consumption                                  | TOTAL kWh *4                              | -  | -       | -                                     | -                                   | 1660       | -    | -      | -     |  |
| EER/EER CLASS                         | TOTAL (W/W) <sup>5</sup> ("A"-~"G")                 | -   | -  | -       | 3.01                                  | 3.01 / B                            | 3.01       | 5.09 | 2.65   | -     |  |
| Erp *6                                | Pdesign   | kW  | -  | -       | -                                     | -                                   | 10.0       | -    | -      | -     |  |
|                                       | SEER  | (W/W)                                     | -  | -       | -                                     | -                                   | 6.1        | -    | -      | -     |  |
|                                       | Annual consumption                                  | kWh                                       | -  | -       | -                                     | -                                   | 574        | -    | -      | -     |  |
|                                       | Class   |   | -  | -       | -                                     | -                                   | A++        | -    | -      | -     |  |
| Power factor                          | %   | -   | -  | -       | 94                                    | 94                                  | 94         | -    | -      | -     |  |
| Noise indoor                          | dB-A (H/M/L)  | 42/37/35                                  |  |         | -                                     |                                     |            | -    | -      | -     |  |
|                                       | Power Level dB                                      | 60/55/53                                  |  |         | -                                     |                                     |            | -    | -      | -     |  |
| Noise outdoor                         | dB-A (H/L)  | -   |  |         | 54/-                                  |                                     |            | -    | -      | -     |  |
|                                       | Power Level dB                                      | -   |  |         | 70/-                                  |                                     |            | -    | -      | -     |  |
| Capacity                              | kW  | 10.0                                      | 10.0   | 10.0    | -                                     | -                                   | -          | 2.1  | 13.8   | -     |  |
|                                       | BTU/h   | 34100                                     | 34100  | 34100   | -                                     | -                                   | -          | 7200 | 47100  | -     |  |
| Current                               | A   | 0.69                                      | 0.67   | 0.65    | 11.9                                  | 11.5                                | 11.1       | -    | -      | -     |  |
|                                       | W   | 80  | 80   | 80      | 2.520k                                | 2.520k                              | 2.520k     | -    | -      | -     |  |
| Input power                           | TOTAL W   | -   | -  | -       | 2.600k                                | 2.600k                              | 2.600k     | 410  | 4.000k | -     |  |
|                                       | COP/COP CLASS                                       | TOTAL (W/W) <sup>5</sup> ("A"-~"G")       | -  | -       | -                                     | 3.85                                | 3.85 / A   | 3.85 | 5.12   | 3.45  |  |
| Erp *6                                | Pdesign at -10°C                                    | kW  | -  | -       | -                                     | -                                   | 10.0       | -    | -      | -     |  |
|                                       | Tbivalent   | °C  | -  | -       | -                                     | -                                   | -7         | -    | -      | -     |  |
|                                       | SCOP  | (W/W)                                     | -  | -       | -                                     | -                                   | 3.9        | -    | -      | -     |  |
|                                       | Annual consumption                                  | kWh                                       | -  | -       | -                                     | -                                   | 3590       | -    | -      | -     |  |
| Class                                 |   | -   | -  | -       | -                                     | A                                   | -          | -    | -      |       |  |
| Power factor                          | %   | -   | -  | -       | 96                                    | 95                                  | 95         | -    | -      | -     |  |
| Noise indoor                          | dB-A (H/M/L)  | 42/37/35                                  |  |         | -                                     |                                     |            | -    | -      | -     |  |
|                                       | Power Level dB                                      | 60/55/53                                  |  |         | -                                     |                                     |            | -    | -      | -     |  |
| Noise outdoor                         | dB-A (H/L)  | -   |  |         | 54/-                                  |                                     |            | -    | -      | -     |  |
|                                       | Power Level dB                                      | -   |  |         | 70/-                                  |                                     |            | -    | -      | -     |  |
| EXTRA LOW TEMP                        |   | Total capacity(kW) / Input power(W) / COP | -  |         |                                       |                                     |            |      |        |       |  |
| Max Current(A) / Max Input power(W)   |   | 0.69/80                                   | 0.67/80  | 0.65/80 | 25.0/5.17k                            | 25.0/5.41k                          | 25.0/5.64k | -    |        |       |  |
| Starting current(A) / Comp output(W)  |   | -   | -  | -       | 15.6/1.7k                             | 15.0/1.7k                           | 14.4/1.7k  | -    |        |       |  |
| Network Impedance(ΩMAX.)              |   | -   |  |         | -                                     |                                     |            | -    |        |       |  |
| Fan motor output (Indoor/Outdoor) W   |   | 111                                       |  |         | 90                                    |                                     |            | -    |        |       |  |
| Moisture removal volume               |   | L/h(Pt/h)                                 | 6.0  | (12.6)  | -                                     |                                     |            | -    |        |       |  |
| External static pressure              |   | Pa  | -  |         |                                       | -                                   |            |      | -      |       |  |
| Indoor Air flow                       | Cooling   | m³/min (ft³/min)                          | 30/25/23 (1059/883/812)                        |         |                                       | -                                   |            |      | -      | -     |  |
|                                       | Heating   | m³/min (ft³/min)                          | 30/25/23 (1059/883/812)                        |         |                                       | -                                   |            |      | -      | -     |  |
| Outdoor Air flow                      | Cooling   | m³/min (ft³/min)                          | -  |         |                                       | 76                                  | (2684)     | -    | -      |       |  |
|                                       | Heating   | m³/min (ft³/min)                          | -  |         |                                       | 67                                  | (2366)     | -    | -      |       |  |
| Refrigerant type / amount g(oz)       |   | -   |  |         | R410A                                 | 2.60k                               | (91.7)     | -    |        |       |  |
| Product dimension                     | Height  | mm(inch)                                  | 235 (9-1/4)                                    |         |                                       | 996 (39-7/32)                       |            |      | -      |       |  |
|                                       | Width   | mm(inch)                                  | 1590 (62-19/32)                                |         |                                       | 940 (37-1/32)                       |            |      | -      |       |  |
|                                       | Depth   | mm(inch)                                  | 690 (27-5/32)                                  |         |                                       | 340 (13-13/32)                      |            |      | -      |       |  |
| Packing dimension                     | Height  | mm(inch)                                  | 360  |         |                                       | 1136                                |            |      | -      |       |  |
|                                       | Width   | mm(inch)                                  | 1655   |         |                                       | 1055                                |            |      | -      |       |  |
|                                       | Depth   | mm(inch)                                  | 820  |         |                                       | 485                                 |            |      | -      |       |  |
| Weight                                | (NET)   | kg(lb)                                    | 40 (88)  |         |                                       | 73 (161)                            |            |      | -      |       |  |
|                                       | (GROSS)   | kg(lb)                                    | 49 (108)                                       |         |                                       | 81 (179)                            |            |      | -      |       |  |
| Layers limit (actually)               |   |   | 9 (10)   |         |                                       | 2 (3)                               |            |      | -      |       |  |
| Operation condition                   |   | Cool (DBT)                                | 18°C ~ 32°C                                    |         |                                       | -10°C ~ 43°C                        |            |      | -      |       |  |
|                                       |   | Heat (DBT)                                | 16°C ~ 30°C                                    |         |                                       | -15°C ~ 24°C                        |            |      | -      |       |  |
| P I P I N G                           | Pipe diameter mm (inch)                             |   | (Liquid)ø9.52(3/8) (Gas)ø15.88(5/8)            |         |                                       | (Liquid)ø9.52(3/8) (Gas)ø15.88(5/8) |            |      | -      |       |  |
|                                       | Connecting method, Standard length m(ft)            |   | flared type, 5.0(16.4)                         |         |                                       | flared type, 5.0(16.4)              |            |      | -      |       |  |
|                                       | Pipe length range m (ft)                            |   | 5 ~ 50 (16.4 ~ 164.0)                          |         |                                       | -                                   |            |      | -      |       |  |
|                                       | Indoor unit & Outdoor unit height difference m (ft) |   | 15 (OD located lower) / 30 (OD located higher) |         |                                       | (49.2/98.4)                         |            |      | -      |       |  |
| Add gas amount g/m (oz/ft)            |   | 50 (0.538)                                |  |         | -                                     |                                     |            | -    |        |       |  |
| Pipe length for additional gas m (ft) |   | 30 (98.4)                                 |  |         | -                                     |                                     |            | -    |        |       |  |

\*1: In case it is necessary to indicate the air flow volume in (l/s), the value in (m³/min.) shall be multiplied by 16.7 and rounded down the decimal point.  
 \*2: If the EUROVENT Certified models can be operated under the "extra-low" temperature condition, -7°C dry bulb and -8°C wet-bulb temperatures with rated voltage 230 V shall be used.  
 \*3: Network Impedance shall be applicable for EUROPE and CHINA models.  
 \*4: The annual consumption is calculated by multiplying the input power at 230 V (400 V) by an average of 500 hours per year in cooling mode.  
 \*5: EER and COP classification is at 230 V (400 V) only in accordance with EU directive 2002/31/EC.  
 \*6: SEER and SCOP classification is at 230V(400V) only in accordance with EN-14825. For heating, SCOP indicates the value of only Average heating season, Other fiche data indicates in an attached sheet.

# Single -Type

## 1-1. Unit Specifications

**PEY1**

### 8. Ceiling Type S-125PT2E5A / U-125PEY1E5

| INDOOR   |  | MODEL                               | S-125PT2E5A                         |  |                                       | -              |            |            | -       |        |      |
|--|--|-------------------------------------|-------------------------------------|--|---------------------------------------|----------------|------------|------------|---------|--------|------|
| PANEL  |  | MODEL                               | -                                   |  |                                       | -              |            |            | -       |        |      |
| OUTDOOR  |  | MODEL                               | -                                   |  |                                       | U-125PEY1E5    |            |            | -       |        |      |
| Branch pipe  |  | MODEL                               | -                                   |  |                                       | -              |            |            | -       |        |      |
| Performance test condition                                 |  |                                     |                                     |  | ISO5151 / EN14511 / EN12102 / EN14825 |                |            |            |         |        |      |
| Power supply   |  | Ø, Hz                               | 1ø 50Hz                             |  |                                       | 1ø 50Hz        |            |            |         |        |      |
|  |  | V                                   | 220                                 | 230  | 240                                   | 220            | 230        | 240        | Min     | Max    |      |
| C<br>O<br>O<br>L<br>I<br>N<br>G                            | Capacity                                 | kW                                  | 12.5                                | 12.5   | 12.5                                  | -              | -          | -          | 3.8     | 13.5   |      |
|  |  | BTU/h                               | 42700                               | 42700  | 42700                                 | -              | -          | -          | 13000   | 46100  |      |
|  | Current                                  | A                                   | 0.89                                | 0.86   | 0.83                                  | 19.7           | 18.9       | 18.1       | -       | -      |      |
|  |  | W                                   | 110                                 | 110  | 110                                   | 4.040k         | 4.040k     | 4.040k     | -       | -      |      |
|  | Input power                              | TOTAL W                             | -                                   |  |                                       | 4.150k         | 4.150k     | 4.150k     | 900     | 5.160k |      |
|  |  | Annual consumption                  | TOTAL kWh *4                        | -  |                                       |                | -          | 2075       | -       | -      | -    |
|  | EER/EER CLASS                            | TOTAL (W/W) <sup>*5</sup> ("A"~"G") | -                                   | -  | -                                     | 3.01           | 3.01 / B   | 3.01       | 4.22    | 2.62   |      |
|  | Erp <sup>*6</sup>                        | Pdesign                             | kW                                  | -  | -                                     | -              | -          | 12.5       | -       | -      | -    |
|  |  | η <sub>s,c</sub>                    | %                                   | -  | -                                     | -              | -          | 207.3      | -       | -      | -    |
|  |  | Annual consumption                  | kWh                                 | -  | -                                     | -              | -          | -          | -       | -      | -    |
| Class  |  |                                     | -                                   | -  | -                                     | -              | -          | -          | -       | -      |      |
| Power factor   | %  | -                                   | -                                   | -  | 93                                    | 93             | 93         | -          | -       |        |      |
| Noise indoor   | dB-A (H/M/L)                             | 46/40/36                            |                                     |  | -                                     |                |            | -          | -       |        |      |
|  | Power Level dB                           | 64/58/54                            |                                     |  | -                                     |                |            | -          | -       |        |      |
| Noise outdoor  | dB-A (H/L)                               | -                                   |                                     |  | 56/-                                  |                |            | -          | -       |        |      |
|  | Power Level dB                           | -                                   |                                     |  | 73/-                                  |                |            | -          | -       |        |      |
| H<br>E<br>A<br>T<br>I<br>N<br>G                            | Capacity                                 | kW                                  | 12.5                                | 12.5   | 12.5                                  | -              | -          | -          | 3.4     | 15.0   |      |
|  |  | BTU/h                               | 42700                               | 42700  | 42700                                 | -              | -          | -          | 11600   | 51200  |      |
|  | Current                                  | A                                   | 0.89                                | 0.86   | 0.83                                  | 15.2           | 14.6       | 13.9       | -       | -      |      |
|  |  | W                                   | 110                                 | 110  | 110                                   | 3.140k         | 3.140k     | 3.140k     | -       | -      |      |
|  | Input power                              | TOTAL W                             | -                                   |  |                                       | 3.250k         | 3.250k     | 3.250k     | 730     | 4.400k |      |
|  |  | COP/COP CLASS                       | TOTAL (W/W) <sup>*5</sup> ("A"~"G") | -  | -                                     | -              | 3.85       | 3.85 / A   | 3.85    | 4.66   | 3.41 |
|  | Erp <sup>*6</sup>                        | Pdesign at -10°C                    | kW                                  | -  | -                                     | -              | -          | 12.5       | -       | -      | -    |
|  |  | Tbivalent                           | °C                                  | -  | -                                     | -              | -          | -7         | -       | -      | -    |
|  |  | η <sub>s,h</sub>                    | %                                   | -  | -                                     | -              | -          | 140.0      | -       | -      | -    |
|  |  | Annual consumption                  | kWh                                 | -  | -                                     | -              | -          | -          | -       | -      | -    |
| Class  |  | -                                   | -                                   | -  | -                                     | -              | -          | -          | -       |        |      |
| Power factor   | %  | -                                   | -                                   | -  | 94                                    | 94             | 94         | -          | -       |        |      |
| Noise indoor   | dB-A (H/M/L)                             | 46/40/36                            |                                     |  | -                                     |                |            | -          | -       |        |      |
|  | Power Level dB                           | 64/58/54                            |                                     |  | -                                     |                |            | -          | -       |        |      |
| Noise outdoor  | dB-A (H/L)                               | -                                   |                                     |  | 56/-                                  |                |            | -          | -       |        |      |
|  | Power Level dB                           | -                                   |                                     |  | 73/-                                  |                |            | -          | -       |        |      |
| EXTRA LOW TEMP   Total capacity(kW) / Input power(W) / COP |  |                                     |                                     |  |                                       |                |            |            |         |        |      |
| Max Current(A) / Max Input power(W)                        |  |                                     | 0.89/110                            | 0.86/110                                       | 0.83/110                              | 29.0/5.93k     | 29.0/6.20k | 29.0/6.47k | -       |        |      |
| Starting current(A) / Comp output(W)                       |  |                                     | -                                   | -  | -                                     | 19.7/3.0k      | 18.9/3.0k  | 18.1/3.0k  | -       |        |      |
| Network Impedance(ΩMAX.)                                   |  |                                     | -                                   |  |                                       | -              |            |            | -       |        |      |
| Fan motor output (Indoor/Outdoor) W                        |  |                                     | 111                                 |  |                                       | 90             |            |            | -       |        |      |
| Moisture removal volume                                    |  |                                     | L/h(Pt/h)                           |  | 7.9                                   | (16.6)         |            | -          |         |        |      |
| External static pressure                                   |  |                                     | Pa                                  |  | -                                     |                |            | -          |         |        |      |
| Indoor Air flow  | Cooling                                  | m³/min (ft³/min)                    | 34/28/24 (1201/989/848)             |  |                                       | -              |            |            | -       | -      |      |
|  | Heating                                  | m³/min (ft³/min)                    | 34/28/24 (1201/989/848)             |  |                                       | -              |            |            | -       | -      |      |
| Outdoor Air flow   | Cooling                                  | m³/min (ft³/min)                    | -                                   |  |                                       | 80             |            | (2825)     |         | -      |      |
|  | Heating                                  | m³/min (ft³/min)                    | -                                   |  |                                       | 73             |            | (2578)     |         | -      |      |
| Refrigerant type / amount g(oz)                            |  |                                     |                                     |  | R410A                                 |                | 3.20k      |            | (112.9) |        |      |
| Product dimension  | Height                                   | mm(inch)                            | 235 (9-1/4)                         |  |                                       | 996 (39-7/32)  |            |            | -       |        |      |
|  | Width                                    | mm(inch)                            | 1590 (62-19/32)                     |  |                                       | 940 (37-1/32)  |            |            | -       |        |      |
|  | Depth                                    | mm(inch)                            | 690 (27-5/32)                       |  |                                       | 340 (13-13/32) |            |            | -       |        |      |
| Packing dimension  | Height                                   | mm(inch)                            | 360                                 |  |                                       | 1136           |            |            | -       |        |      |
|  | Width                                    | mm(inch)                            | 1655                                |  |                                       | 1055           |            |            | -       |        |      |
|  | Depth                                    | mm(inch)                            | 820                                 |  |                                       | 485            |            |            | -       |        |      |
| Weight   | (NET)                                    | kg(lb)                              | 40 (88)                             |  |                                       | 85 (187)       |            |            | -       |        |      |
|  | (GROSS)                                  | kg(lb)                              | 49 (108)                            |  |                                       | 93 (205)       |            |            | -       |        |      |
| Layers limit (actually)                                    |  |                                     | 9 (10)                              |  |                                       | 2 (3)          |            |            | -       |        |      |
| Operation condition  | Cool (DBT)                               | 18°C ~ 32°C                         |                                     |  | -10°C ~ 43°C                          |                |            | -          |         |        |      |
|  | Heat (DBT)                               | 16°C ~ 30°C                         |                                     |  | -15°C ~ 24°C                          |                |            | -          |         |        |      |
| P<br>I<br>P<br>I<br>N<br>G                                 | Pipe diameter mm (inch)                  | (Liquid)ø9.52(3/8) (Gas)ø15.88(5/8) |                                     |  | (Liquid)ø9.52(3/8) (Gas)ø15.88(5/8)   |                |            | -          |         |        |      |
|  | Connecting method, Standard length m(ft) | flared type, 5.0(16.4)              |                                     |  | flared type, 5.0(16.4)                |                |            | -          |         |        |      |
| Pipe length range  |  | m (ft)                              |                                     | 5 ~ 50 (16.4 ~ 164.0)                          |                                       | -              |            |            |         |        |      |
| Indoor unit & Outdoor unit height difference               |  | m (ft)                              |                                     | 15 (OD located lower) / 30 (OD located higher) |                                       | (49.2/98.4)    |            | -          |         |        |      |
| Add gas amount   |  | g/m (oz/ft)                         |                                     | 50 (0.538)                                     |                                       | -              |            |            |         |        |      |
| Pipe length for additional gas                             |  | m (ft)                              |                                     | 30 (98.4)                                      |                                       | -              |            |            |         |        |      |

\*1: In case it is necessary to indicate the air flow volume in (l/s), the value in (m³/min.) shall be multiplied by 16.7 and rounded down the decimal point.

\*2: If the EUROVENT Certified models can be operated under the "extra-low" temperature condition, -7°C dry bulb and -8°C wet-bulb temperatures with rated voltage 230 V shall be used.

\*3: Network Impedance shall be applicable for EUROPE and CHINA models.

\*4: The annual consumption is calculated by multiplying the input power at 230 V (400 V) by an average of 500 hours per year in cooling mode.

\*5: EER and COP classification is at 230 V (400 V) only in accordance with EU directive 2002/31/EC.

\*6: SEER and SCOP classification is at 230V(400V) only in accordance with EN-14825. For heating, SCOP indicates the value of only Average heating season.



# Simultaneous (Twin) -Type

## 1-1. Unit Specifications

**PEY1**

### 8. Ceiling Type S-50PT2E5A×2 / U-100PEY1E8

|  |  |  |                                |             |                                     |                |           |      |        |       |
|--|--|--|--------------------------------|-------------|-------------------------------------|----------------|-----------|------|--------|-------|
| INDOOR   |  | MODEL  | S-50PT2E5A×2                   |             |                                     | -              |           |      | -      |       |
| PANEL  |  | MODEL  | -                              |             |                                     | -              |           |      | -      |       |
| OUTDOOR  |  | MODEL  | -                              |             |                                     | U-100PEY1E8    |           |      | -      |       |
| Branch pipe  |  | MODEL  | -                              |             |                                     | CZ-P155BK1     |           |      | -      |       |
| Performance test condition                                 |  | ISO5151 / EN14511 / EN14825 / EN12102          |                                |             |                                     |                |           |      |        |       |
| Power supply   |  | ∅, Hz  | 1∅ 50Hz                        |             |                                     | 3∅ 50Hz        |           |      |        |       |
|  |  | V  | 220                            | 230         | 240                                 | 380            | 400       | 415  | Min    | Max   |
| Capacity   | kW                                       | 10.0   | 10.0                           | 10.0        | -                                   | -              | -         | -    | 2.7    | 11.5  |
|  | BTU/h                                    | 34100  | 34100                          | 34100       | -                                   | -              | -         | -    | 9200   | 39200 |
| Current  | A  | 0.39×2   | 0.38×2                         | 0.37×2      | 5.30                                | 5.05           | 4.85      | -    | -      | -     |
| Input power  | W  | 40×2   | 40×2                           | 40×2        | 3.240k                              | 3.240k         | 3.240k    | -    | -      | -     |
|  | TOTAL W                                  | -  |                                |             | 3.320k                              | 3.320k         | 3.320k    | 530  | 4.340k | -     |
| Annual consumption   | TOTAL kWh *4                             | -  |                                |             | -                                   | 1660           | -         | -    | -      | -     |
| EER/EER CLASS  | TOTAL (W/W) <sup>*5</sup> ("A"~"G")      | -  | -                              | -           | 3.01                                | 3.01 / B       | 3.01      | 5.09 | 2.65   | -     |
| Erp *6   | Pdesign                                  | kW   | -                              | -           | -                                   | 10.0           | -         | -    | -      | -     |
|  | SEER                                     | (W/W)  | -                              | -           | -                                   | 5.8            | -         | -    | -      | -     |
|  | Annual consumption                       | kWh  | -                              | -           | -                                   | 604            | -         | -    | -      | -     |
|  | Class                                    |  | -                              | -           | -                                   | A+             | -         | -    | -      | -     |
| Power factor   | %  | -  | -                              | -           | 93                                  | 93             | 93        | -    | -      | -     |
| Noise indoor   | dB-A (H/M/L)                             | 37/33/29                                       |                                |             | -                                   |                |           | -    | -      | -     |
|  | Power Level dB                           | 55/51/47                                       |                                |             | -                                   |                |           | -    | -      | -     |
| Noise outdoor  | dB-A (H/L)                               | -  |                                |             | 54/-                                |                |           | -    | -      | -     |
|  | Power Level dB                           | -  |                                |             | 70/-                                |                |           | -    | -      | -     |
| Capacity   | kW                                       | 10.0   | 10.0                           | 10.0        | -                                   | -              | -         | 2.1  | 13.8   |       |
|  | BTU/h                                    | 34100  | 34100                          | 34100       | -                                   | -              | -         | 7200 | 47100  |       |
| Current  | A  | 0.39×2   | 0.38×2                         | 0.37×2      | 4.10                                | 3.90           | 3.75      | -    | -      |       |
| Input power  | W  | 40×2   | 40×2                           | 40×2        | 2.520k                              | 2.520k         | 2.520k    | -    | -      |       |
|  | TOTAL W                                  | -  |                                |             | 2.600k                              | 2.600k         | 2.600k    | 410  | 4.000k |       |
| COP/COP CLASS  | TOTAL (W/W) <sup>*5</sup> ("A"~"G")      | -  | -                              | -           | 3.85                                | 3.85 / A       | 3.85      | 5.12 | 3.45   |       |
| Erp *6   | Pdesign at -10°C                         | kW   | -                              | -           | -                                   | 10.0           | -         | -    | -      | -     |
|  | Tbivalent                                | °C   | -                              | -           | -                                   | -7             | -         | -    | -      | -     |
|  | SCOP                                     | (W/W)  | -                              | -           | -                                   | 3.9            | -         | -    | -      | -     |
|  | Annual consumption                       | kWh  | -                              | -           | -                                   | 3590           | -         | -    | -      | -     |
| Class  |  | -  | -                              | -           | A                                   | -              | -         | -    | -      |       |
| Power factor   | %  | -  | -                              | -           | 93                                  | 93             | 93        | -    | -      |       |
| Noise indoor   | dB-A (H/M/L)                             | 37/33/29                                       |                                |             | -                                   |                |           | -    | -      | -     |
|  | Power Level dB                           | 55/51/47                                       |                                |             | -                                   |                |           | -    | -      | -     |
| Noise outdoor  | dB-A (H/L)                               | -  |                                |             | 54/-                                |                |           | -    | -      | -     |
|  | Power Level dB                           | -  |                                |             | 70/-                                |                |           | -    | -      | -     |
| EXTRA LOW TEMP   Total capacity(kW) / Input power(W) / COP |  | -  |                                |             |                                     |                |           |      |        |       |
| Max Current(A) / Max Input power(W)                        |  | 0.39×2/40×2                                    | 0.38×2/40×2                    | 0.37×2/40×2 | 9.0/5.51k                           | 9.0/5.80k      | 9.0/6.02k | -    |        |       |
| Starting current(A) / Comp output(W)                       |  | -  | -                              | -           | 5.30/1.7k                           | 5.05/1.7k      | 4.85/1.7k | -    |        |       |
| Network Impedance(ΩMAX.)                                   |  | -  |                                |             |                                     |                |           |      |        |       |
| Fan motor output (Indoor/Outdoor) W                        |  | 43   |                                |             | 90                                  |                |           | -    |        |       |
| Moisture removal volume                                    |  | L/h(Pt/h)                                      | 6.0                            | (3.0×2)     | (12.6)                              | -              |           |      | -      |       |
| External static pressure                                   |  | Pa   | -                              |             |                                     | -              |           |      | -      |       |
| Indoor Air flow  | Cooling                                  | m³/min (ft³/min)                               | [15/12.5/10.5 (530/441/371)]×2 |             |                                     | -              |           |      | -      |       |
|  | Heating                                  | m³/min (ft³/min)                               | [15/12.5/10.5 (530/441/371)]×2 |             |                                     | -              |           |      | -      |       |
| Outdoor Air flow   | Cooling                                  | m³/min (ft³/min)                               | -                              |             |                                     | 76             | (2684)    | -    |        |       |
|  | Heating                                  | m³/min (ft³/min)                               | -                              |             |                                     | 67             | (2366)    | -    |        |       |
| Refrigerant type / amount g(oz)                            |  | -  |                                |             | R410A                               | 2.60k          | (91.7)    | -    |        |       |
| Product dimension  | Height                                   | mm(inch)                                       | 235 (9-1/4)                    |             |                                     | 996 (39-7/32)  |           |      | -      |       |
|  | Width                                    | mm(inch)                                       | 960 (37-25/32)                 |             |                                     | 940 (37-1/32)  |           |      | -      |       |
|  | Depth                                    | mm(inch)                                       | 690 (27-5/32)                  |             |                                     | 340 (13-13/32) |           |      | -      |       |
| Packing dimension  | Height                                   | mm(inch)                                       | 360                            |             |                                     | 1136           |           |      | -      |       |
|  | Width                                    | mm(inch)                                       | 1025                           |             |                                     | 1055           |           |      | -      |       |
|  | Depth                                    | mm(inch)                                       | 820                            |             |                                     | 485            |           |      | -      |       |
| Weight   | (NET)                                    | kg(lb)   | 27 (60)                        |             |                                     | 73 (161)       |           |      | -      |       |
|  | (GROSS)                                  | kg(lb)   | 34 (75)                        |             |                                     | 81 (179)       |           |      | -      |       |
| Layers limit (actually)                                    |  | 9 (10)   |                                |             | 2 (3)                               |                |           | -    |        |       |
| Operation condition  | Cool (DBT)                               | 18°C ~ 32°C                                    |                                |             | -10°C ~ 43°C                        |                |           | -    |        |       |
|  | Heat (DBT)                               | 16°C ~ 30°C                                    |                                |             | -15°C ~ 24°C                        |                |           | -    |        |       |
| P I P I N G  | Pipe diameter mm (inch)                  | (Liquid)∅6.35(1/4) (Gas)∅12.7(1/2)             |                                |             | (Liquid)∅9.52(3/8) (Gas)∅15.88(5/8) |                |           | -    |        |       |
|  | Connecting method, Standard length m(ft) | flared type, 5.0(16.4)                         |                                |             | flared type, 5.0(16.4)              |                |           | -    |        |       |
| Pipe length range  |  | m (ft)   |                                |             | 5 ~ 50 (16.4 ~ 164.0)               |                |           | -    |        |       |
| Indoor unit & Outdoor unit height difference m (ft)        |  | 15 (OD located lower) / 30 (OD located higher) |                                |             | (49.2/98.4)                         |                |           | -    |        |       |
| Add gas amount g/m (oz/ft)                                 |  | 50   |                                |             | (0.538)                             |                |           | -    |        |       |
| Pipe length for additional gas                             |  | m (ft)   |                                |             | 30 (98.4)                           |                |           | -    |        |       |

\*1: In case it is necessary to indicate the air flow volume in (l/s), the value in (m³/min.) shall be multiplied by 16.7 and rounded down the decimal point.  
 \*2: If the EUROVENT Certified models can be operated under the "extra-low" temperature condition, -7°C dry bulb and -8°C wet-bulb temperatures with rated voltage 230 V shall be used.  
 \*3: Network Impedance shall be applicable for EUROPE and CHINA models.  
 \*4: The annual consumption is calculated by multiplying the input power at 230 V (400 V) by an average of 500 hours per year in cooling mode.  
 \*5: EER and COP classification is at 230 V (400 V) only in accordance with EU directive 2002/31/EC.  
 \*6: SEER and SCOP classification is at 230V(400V) only in accordance with EN-14825. For heating, SCOP indicates the value of only Average heating season, Other fiche data indicates in an attached sheet.

# Simultaneous (Twin) -Type

## 1-1. Unit Specifications

**PEY1**

### 8. Ceiling Type S-60PT2E5A×2 / U-125PEY1E8

| INDOOR   |  | MODEL  | S-60PT2E5A×2                        |             |                                     | -              |            |          | -     |        |      |
|--|--|--|-------------------------------------|-------------|-------------------------------------|----------------|------------|----------|-------|--------|------|
| PANEL  |  | MODEL  | -                                   |             |                                     | -              |            |          | -     |        |      |
| OUTDOOR  |  | MODEL  | -                                   |             |                                     | U-125PEY1E8    |            |          | -     |        |      |
| Branch pipe  |  | MODEL  | -                                   |             |                                     | CZ-P155BK1     |            |          | -     |        |      |
| Performance test condition                                 |  | ISO5151 / EN14511 / EN12102 / EN14825          |                                     |             |                                     |                |            |          |       |        |      |
| Power supply   |  | Ø, Hz  | 1ø 50Hz                             |             |                                     | 3ø 50Hz        |            |          |       |        |      |
|  |  | V  | 220                                 | 230         | 240                                 | 380            | 400        | 415      | Min   | Max    |      |
| C<br>O<br>O<br>L<br>I<br>N<br>G                            | Capacity                                 | kW   | 12.5                                | 12.5        | 12.5                                | -              | -          | -        | 3.8   | 13.5   |      |
|  |  | BTU/h  | 42700                               | 42700       | 42700                               | -              | -          | -        | 13000 | 46100  |      |
|  | Current                                  | A  | 0.42×2                              | 0.41×2      | 0.40×2                              | 6.55           | 6.20       | 6.00     | -     | -      |      |
|  |  | W  | 50×2                                | 50×2        | 50×2                                | 4.050k         | 4.050k     | 4.050k   | -     | -      |      |
|  | Input power                              | TOTAL W  | -                                   |             |                                     | 4.150k         | 4.150k     | 4.150k   | 900   | 5.160k |      |
|  |  | Annual consumption                             | TOTAL kWh *4                        | -           |                                     |                | -          | 2075     | -     | -      | -    |
|  | EER/EER CLASS                            | TOTAL (W/W) <sup>*5</sup> ("A"~"G")            | -                                   | -           | -                                   | 3.01           | 3.01 / B   | 3.01     | 4.22  | 2.62   |      |
|  | Erp<br>*6                                | Pdesign  | kW                                  | -           | -                                   | -              | -          | 12.5     | -     | -      | -    |
|  |  | η <sub>s,c</sub>                               | %                                   | -           | -                                   | -              | -          | 217.7    | -     | -      | -    |
|  |  | Annual consumption                             | kWh                                 | -           | -                                   | -              | -          | -        | -     | -      | -    |
| Class  |  |  | -                                   | -           | -                                   | -              | -          | -        | -     | -      |      |
| Power factor   | %  | -  | -                                   | -           | 94                                  | 94             | 94         | -        | -     |        |      |
| Noise indoor   | dB-A (H/M/L)                             | 38/34/30                                       |                                     |             | -                                   |                |            | -        | -     |        |      |
|  | Power Level dB                           | 56/52/48                                       |                                     |             | -                                   |                |            | -        | -     |        |      |
| Noise outdoor  | dB-A (H/L)                               | -  |                                     |             | 56/-                                |                |            | -        | -     |        |      |
|  | Power Level dB                           | -  |                                     |             | 73/-                                |                |            | -        | -     |        |      |
| H<br>E<br>A<br>T<br>I<br>N<br>G                            | Capacity                                 | kW   | 12.5                                | 12.5        | 12.5                                | -              | -          | -        | 3.4   | 15.0   |      |
|  |  | BTU/h  | 42700                               | 42700       | 42700                               | -              | -          | -        | 11600 | 51200  |      |
|  | Current                                  | A  | 0.42×2                              | 0.41×2      | 0.40×2                              | 5.10           | 4.85       | 4.65     | -     | -      |      |
|  |  | W  | 50×2                                | 50×2        | 50×2                                | 3.150k         | 3.150k     | 3.150k   | -     | -      |      |
|  | Input power                              | TOTAL W  | -                                   |             |                                     | 3.250k         | 3.250k     | 3.250k   | 730   | 4.400k |      |
|  |  | COP/COP CLASS                                  | TOTAL (W/W) <sup>*5</sup> ("A"~"G") | -           | -                                   | -              | 3.85       | 3.85 / A | 3.85  | 4.66   | 3.41 |
|  | Erp<br>*6                                | Pdesign at -10°C                               | kW                                  | -           | -                                   | -              | -          | 12.5     | -     | -      | -    |
|  |  | Tbivalent                                      | °C                                  | -           | -                                   | -              | -          | -7       | -     | -      | -    |
|  |  | η <sub>s,h</sub>                               | %                                   | -           | -                                   | -              | -          | 140.5    | -     | -      | -    |
|  |  | Annual consumption                             | kWh                                 | -           | -                                   | -              | -          | -        | -     | -      | -    |
| Class  |  | -  | -                                   | -           | -                                   | -              | -          | -        | -     |        |      |
| Power factor   | %  | -  | -                                   | -           | 94                                  | 94             | 94         | -        | -     |        |      |
| Noise indoor   | dB-A (H/M/L)                             | 38/34/30                                       |                                     |             | -                                   |                |            | -        | -     |        |      |
|  | Power Level dB                           | 56/52/48                                       |                                     |             | -                                   |                |            | -        | -     |        |      |
| Noise outdoor  | dB-A (H/L)                               | -  |                                     |             | 56/-                                |                |            | -        | -     |        |      |
|  | Power Level dB                           | -  |                                     |             | 73/-                                |                |            | -        | -     |        |      |
| EXTRA LOW TEMP   Total capacity(kW) / Input power(W) / COP |  | -  |                                     |             |                                     |                |            |          |       |        |      |
| Max Current(A) / Max Input power(W)                        |  | 0.42×2/50×2                                    | 0.41×2/50×2                         | 0.40×2/50×2 | 10.0/6.19k                          | 10.0/6.51k     | 10.0/6.75k | -        |       |        |      |
| Starting current(A) / Comp output(W)                       |  | -  | -                                   | -           | 6.55/3.0k                           | 6.20/3.0k      | 6.00/3.0k  | -        |       |        |      |
| Network Impedance(ΩMAX.)                                   |  | -  |                                     |             |                                     |                |            |          |       |        |      |
| Fan motor output (Indoor/Outdoor) W                        |  | 74   |                                     |             | 90                                  |                |            | -        |       |        |      |
| Moisture removal volume                                    |  | L/h(Pt/h)                                      | 7.9                                 | (3.95×2)    | (16.6)                              | -              |            |          | -     |        |      |
| External static pressure                                   |  | Pa   | -                                   |             |                                     | -              |            |          | -     |        |      |
| Indoor Air flow  | Cooling                                  | m³/min (ft³/min)                               | [20/17/14.5 (706/600/512)]×2        |             |                                     | -              |            |          | -     |        |      |
|  | Heating                                  | m³/min (ft³/min)                               | [20/17/14.5 (706/600/512)]×2        |             |                                     | -              |            |          | -     |        |      |
| Outdoor Air flow   | Cooling                                  | m³/min (ft³/min)                               | -                                   |             |                                     | 80             | (2825)     | -        |       |        |      |
|  | Heating                                  | m³/min (ft³/min)                               | -                                   |             |                                     | 73             | (2578)     | -        |       |        |      |
| Refrigerant type / amount g(oz)                            |  | -  |                                     |             | R410A                               | 3.20k          | (112.9)    | -        |       |        |      |
| Product dimension  | Height                                   | mm(inch)                                       | 235 (9-1/4)                         |             |                                     | 996 (39-7/32)  |            |          | -     |        |      |
|  | Width                                    | mm(inch)                                       | 1275 (50-3/16)                      |             |                                     | 940 (37-1/32)  |            |          | -     |        |      |
|  | Depth                                    | mm(inch)                                       | 690 (27-5/32)                       |             |                                     | 340 (13-13/32) |            |          | -     |        |      |
| Packing dimension  | Height                                   | mm(inch)                                       | 360                                 |             |                                     | 1136           |            |          | -     |        |      |
|  | Width                                    | mm(inch)                                       | 1340                                |             |                                     | 1055           |            |          | -     |        |      |
|  | Depth                                    | mm(inch)                                       | 820                                 |             |                                     | 485            |            |          | -     |        |      |
| Weight   | (NET)                                    | kg(lb)   | 33 (73)                             |             |                                     | 85 (187)       |            |          | -     |        |      |
|  | (GROSS)                                  | kg(lb)   | 42 (93)                             |             |                                     | 93 (205)       |            |          | -     |        |      |
| Layers limit (actually)                                    |  | 9 (10)   |                                     |             | 2 (3)                               |                |            | -        |       |        |      |
| Operation condition  | Cool (DBT)                               | 18°C ~ 32°C                                    |                                     |             | -10°C ~ 43°C                        |                |            | -        |       |        |      |
|  | Heat (DBT)                               | 16°C ~ 30°C                                    |                                     |             | -15°C ~ 24°C                        |                |            | -        |       |        |      |
| P<br>I<br>P<br>I<br>N<br>G                                 | Pipe diameter mm (inch)                  | (Liquid)ø9.52(3/8) (Gas)ø15.88(5/8)            |                                     |             | (Liquid)ø9.52(3/8) (Gas)ø15.88(5/8) |                |            | -        |       |        |      |
|  | Connecting method, Standard length m(ft) | flared type, 5.0(16.4)                         |                                     |             | flared type, 5.0(16.4)              |                |            | -        |       |        |      |
| Pipe length range  |  | m (ft)   |                                     |             | 5 ~ 50 (16.4 ~ 164.0)               |                |            | -        |       |        |      |
| Indoor unit & Outdoor unit height difference m (ft)        |  | 15 (OD located lower) / 30 (OD located higher) |                                     |             | (49.2/98.4)                         |                |            | -        |       |        |      |
| Add gas amount g/m (oz/ft)                                 |  | 50   |                                     |             | (0.538)                             |                |            | -        |       |        |      |
| Pipe length for additional gas                             |  | m (ft)   |                                     |             | 30 (98.4)                           |                |            | -        |       |        |      |

\*1: In case it is necessary to indicate the air flow volume in (l/s), the value in (m³/min.) shall be multiplied by 16.7 and rounded down the decimal point.

\*2: If the EUROVENT Certified models can be operated under the "extra-low" temperature condition, -7°C dry bulb and -8°C wet-bulb temperatures with rated voltage 230 V shall be used.

\*3: Network Impedance shall be applicable for EUROPE and CHINA models.

\*4: The annual consumption is calculated by multiplying the input power at 230 V (400 V) by an average of 500 hours per year in cooling mode.

\*5: EER and COP classification is at 230 V (400 V) only in accordance with EU directive 2002/31/EC.

\*6: SEER and SCOP classification is at 230V(400V) only in accordance with EN-14825. For heating, SCOP indicates the value of only Average heating season.

# Simultaneous (Twin) -Type

## 1-1. Unit Specifications

**PEY1**

### 8. Ceiling Type S-71PT2E5A×2 / U-140PEY1E8

|  |  |   |  |             |            |                                     |            |       |        |      |
|--|--|---|--|-------------|------------|-------------------------------------|------------|-------|--------|------|
| INDOOR                                       |  | MODEL                                     | S-71PT2E5A×2                                   |             |            |                                     |            |       | -      | -    |
| PANEL  |  | MODEL                                     |  |             |            |                                     |            |       | -      | -    |
| OUTDOOR                                      |  | MODEL                                     |  |             |            | U-140PEY1E8                         |            |       | -      | -    |
| Branch pipe                                  |  | MODEL                                     |  |             |            | CZ-P155BK1                          |            |       | -      | -    |
| Performance test condition                   |  | ISO5151 / EN14511 / EN12102 / EN14825     |  |             |            |                                     |            |       |        |      |
| Power supply                                 |  | Ø, Hz                                     | 1ø 50Hz  |             |            | 3ø 50Hz                             |            |       | Min    | Max  |
|  |  | V   | 220  | 230         | 240        | 380                                 | 400        | 415   |        |      |
| Capacity                                     | kW                                       | 14.0                                      | 14.0   | 14.0        | -          | -                                   | -          | 3.8   | 15.0   |      |
|  | BTU/h                                    | 47800                                     | 47800  | 47800       | -          | -                                   | -          | 11300 | 51200  |      |
| Current                                      | A  | 0.45×2                                    | 0.44×2   | 0.43×2      | 7.40       | 7.05                                | 6.80       | -     | -      |      |
|  | W  | 55×2                                      | 55×2   | 55×2        | 4.590k     | 4.590k                              | 4.590k     | -     | -      |      |
| Input power                                  | TOTAL W                                  |   |  |             | 4.700k     | 4.700k                              | 4.700k     | 840   | 5.700k |      |
|  | Annual consumption                       | TOTAL kWh *4                              |  |             |            | -                                   | 2350       | -     | -      | -    |
| EER/EER CLASS                                | TOTAL (W/W) <sup>5)</sup> ("A"~"G")      | -   | -  | -           | 2.98       | 2.98 / C                            | 2.98       | 3.93  | 2.63   |      |
| Erp *6                                       | Pdesign                                  | kW  | -  | -           | -          | -                                   | 14.0       | -     | -      |      |
|  | η <sub>s.c</sub>                         | %   | -  | -           | -          | -                                   | 217.0      | -     | -      |      |
|  | Annual consumption                       | kWh                                       | -  | -           | -          | -                                   | -          | -     | -      |      |
|  | Class                                    |   | -  | -           | -          | -                                   | -          | -     | -      |      |
| Power factor                                 | %  | -   | -  | -           | 94         | 94                                  | 94         | -     | -      |      |
| Noise indoor                                 | dB-A (H/M/L)                             | 39/35/31                                  |  |             |            |                                     |            | -     | -      |      |
|  | Power Level dB                           | 57/53/49                                  |  |             |            |                                     |            | -     | -      |      |
| Noise outdoor                                | dB-A (H/L)                               |   |  |             | 54/-       |                                     |            | -     | -      |      |
|  | Power Level dB                           |   |  |             | 71/-       |                                     |            | -     | -      |      |
| Capacity                                     | kW                                       | 14.0                                      | 14.0   | 14.0        | -          | -                                   | -          | 4.1   | 16.0   |      |
|  | BTU/h                                    | 47800                                     | 47800  | 47800       | -          | -                                   | -          | 14000 | 54600  |      |
| Current                                      | A  | 0.45×2                                    | 0.44×2   | 0.43×2      | 5.65       | 5.35                                | 5.20       | -     | -      |      |
|  | W  | 55×2                                      | 55×2   | 55×2        | 3.500k     | 3.500k                              | 3.500k     | -     | -      |      |
| Input power                                  | TOTAL W                                  |   |  |             | 3.610k     | 3.610k                              | 3.610k     | 900   | 5.210k |      |
|  | COP/COP CLASS                            | TOTAL (W/W) <sup>5)</sup> ("A"~"G")       | -  | -           | -          | 3.88                                | 3.88 / A   | 3.88  | 4.56   | 3.07 |
| Erp *6                                       | Pdesign at -10°C                         | kW  | -  | -           | -          | -                                   | 14.0       | -     | -      |      |
|  | Tbivalent                                | °C  | -  | -           | -          | -                                   | -7         | -     | -      |      |
|  | η <sub>s.h</sub>                         | %   | -  | -           | -          | -                                   | 140.4      | -     | -      |      |
|  | Annual consumption                       | kWh                                       | -  | -           | -          | -                                   | -          | -     | -      |      |
| Class  |  | -   | -  | -           | -          | -                                   | -          | -     | -      |      |
| Power factor                                 | %  | -   | -  | -           | 94         | 94                                  | 94         | -     | -      |      |
| Noise indoor                                 | dB-A (H/M/L)                             | 39/35/31                                  |  |             |            |                                     |            | -     | -      |      |
|  | Power Level dB                           | 57/53/49                                  |  |             |            |                                     |            | -     | -      |      |
| Noise outdoor                                | dB-A (H/L)                               |   |  |             | 53/-       |                                     |            | -     | -      |      |
|  | Power Level dB                           |   |  |             | 70/-       |                                     |            | -     | -      |      |
| EXTRA LOW TEMP                               |  | Total capacity(kW) / Input power(W) / COP |  |             |            |                                     |            |       |        |      |
| Max Current(A) / Max Input power(W)          |  | 0.45×2/55×2                               | 0.44×2/55×2                                    | 0.43×2/55×2 | 10.0/6.19k | 10.0/6.51k                          | 10.0/6.75k | -     | -      |      |
| Starting current(A) / Comp output(W)         |  | -   | -  | -           | 7.40/3.0k  | 7.05/3.0k                           | 6.80/3.0k  | -     | -      |      |
| Network Impedance(ΩMAX.)                     |  |   |  |             |            |                                     |            |       |        |      |
| Fan motor output (Indoor/Outdoor) W          |  | 74  |  |             | 90×2       |                                     |            | -     | -      |      |
| Moisture removal volume                      |  | L/h(Pt/h)                                 | 9.0  | (4.5×2)     | (18.9)     |                                     |            |       | -      |      |
| External static pressure                     |  | Pa  |  |             |            |                                     |            |       |        |      |
| Indoor Air flow                              | Cooling                                  | m³/min (ft³/min)                          | [21/18/15.5 (742/636/547)]×2                   |             |            |                                     |            |       | -      | -    |
|  | Heating                                  | m³/min (ft³/min)                          | [21/18/15.5 (742/636/547)]×2                   |             |            |                                     |            |       | -      | -    |
| Outdoor Air flow                             | Cooling                                  | m³/min (ft³/min)                          |  |             |            | 135                                 | (4767)     | -     | -      |      |
|  | Heating                                  | m³/min (ft³/min)                          |  |             |            | 120                                 | (4238)     | -     | -      |      |
| Refrigerant type / amount g(oz)              |  |   |  |             | R410A      | 3.40k                               | (119.9)    | -     | -      |      |
| Product dimension                            | Height                                   | mm(inch)                                  | 235 (9-1/4)                                    |             |            | 1416 (55-3/4)                       |            |       | -      | -    |
|  | Width                                    | mm(inch)                                  | 1275 (50-3/16)                                 |             |            | 940 (37-1/32)                       |            |       | -      | -    |
|  | Depth                                    | mm(inch)                                  | 690 (27-5/32)                                  |             |            | 340 (13-13/32)                      |            |       | -      | -    |
| Packing dimension                            | Height                                   | mm(inch)                                  | 360  |             |            | 1556                                |            |       | -      | -    |
|  | Width                                    | mm(inch)                                  | 1340   |             |            | 1055                                |            |       | -      | -    |
|  | Depth                                    | mm(inch)                                  | 820  |             |            | 485                                 |            |       | -      | -    |
| Weight                                       | (NET)                                    | kg(lb)                                    | 33 (73)  |             |            | 98 (216)                            |            |       | -      | -    |
|  | (GROSS)                                  | kg(lb)                                    | 42 (93)  |             |            | 108 (238)                           |            |       | -      | -    |
| Layers limit (actually)                      |  |   | 9 (10)   |             |            | 1 (2)                               |            |       | -      | -    |
| Operation condition                          | Cool (DBT)                               |   | 18°C ~ 32°C                                    |             |            | -10°C ~ 43°C                        |            |       | -      | -    |
|  | Heat (DBT)                               |   | 16°C ~ 30°C                                    |             |            | -15°C ~ 24°C                        |            |       | -      | -    |
| P I P E I N G                                | Pipe diameter mm (inch)                  |   | (Liquid)ø9.52(3/8) (Gas)ø15.88(5/8)            |             |            | (Liquid)ø9.52(3/8) (Gas)ø15.88(5/8) |            |       | -      | -    |
|  | Connecting method, Standard length m(ft) |   | flared type, 5.0(16.4)                         |             |            | flared type, 5.0(16.4)              |            |       | -      | -    |
| Pipe length range                            |  | m (ft)                                    | 5 ~ 50 (16.4 ~ 164.0)                          |             |            |                                     |            |       | -      | -    |
| Indoor unit & Outdoor unit height difference |  | m (ft)                                    | 15 (OD located lower) / 30 (OD located higher) |             |            | (49.2/98.4)                         |            |       | -      | -    |
| Add gas amount                               |  | g/m (oz/ft)                               | 50 (0.538)                                     |             |            |                                     |            |       | -      | -    |
| Pipe length for additional gas               |  | m (ft)                                    | 30 (98.4)                                      |             |            |                                     |            |       | -      | -    |

\*1: In case it is necessary to indicate the air flow volume in (l/s), the value in (m³/min.) shall be multiplied by 16.7 and rounded down the decimal point.  
 \*2: If the EUROVENT Certified models can be operated under the "extra-low" temperature condition, -7°C dry bulb and -8°C wet-bulb temperatures with rated voltage 230 V shall be used.  
 \*3: Network Impedance shall be applicable for EUROPE and CHINA models.  
 \*4: The annual consumption is calculated by multiplying the input power at 230 V (400 V) by an average of 500 hours per year in cooling mode.  
 \*5: EER and COP classification is at 230 V (400 V) only in accordance with EU directive 2002/31/EC.  
 \*6: SEER and SCOP classification is at 230V(400V) only in accordance with EN-14825. For heating, SCOP indicates the value of only Average heating season.

# Single -Type

## 1-1. Unit Specifications

**PEY1**

### 8. Ceiling Type S-100PT2E5A / U-100PEY1E8

| INDOOR   | MODEL   | S-100PT2E5A                                    |                                     |         | -                                   |                |           | -        |      |        |
|--|---|--|-------------------------------------|---------|-------------------------------------|----------------|-----------|----------|------|--------|
| PANEL  | MODEL   | -  |                                     |         | -                                   |                |           | -        |      |        |
| OUTDOOR  | MODEL   | -  |                                     |         | U-100PEY1E8                         |                |           | -        |      |        |
| Branch pipe  | MODEL   | -  |                                     |         | -                                   |                |           | -        |      |        |
| Performance test condition                                 |   | ISO5151 / EN14511 / EN14825 / EN12102          |                                     |         |                                     |                |           |          |      |        |
| Power supply   |   | Ø, Hz  | 1ø 50Hz                             |         |                                     | 3ø 50Hz        |           |          | Min  | Max    |
|  |   | V  | 220                                 | 230     | 240                                 | 380            | 400       | 415      |      |        |
| C<br>O<br>O<br>L<br>I<br>N<br>G                            | Capacity  | kW   | 10.0                                | 10.0    | 10.0                                | -              | -         | -        | 11.5 | 13.5   |
|  |   | BTU/h  | 34100                               | 34100   | 34100                               | -              | -         | -        | 9200 | 39200  |
|  | Current   | A  | 0.69                                | 0.67    | 0.65                                | 5.30           | 5.05      | 4.85     | -    | -      |
|  |   | W  | 80                                  | 80      | 80                                  | 3.240k         | 3.240k    | 3.240k   | -    | -      |
|  | Input power   | TOTAL W  | -                                   | -       | -                                   | 3.320k         | 3.320k    | 3.320k   | 530  | 4.340k |
|  |   | Annual consumption                             | TOTAL kWh *4                        | -       | -                                   | -              | -         | 1660     | -    | -      |
|  | EER/EER CLASS                                       | TOTAL (W/W) <sup>*5</sup> ("A"~"G")            | -                                   | -       | -                                   | 3.01           | 3.01 / B  | 3.01     | 5.09 | 2.65   |
|  | E <sub>rp</sub> <sup>*6</sup>                       | Pdesign  | kW                                  | -       | -                                   | -              | -         | 10.0     | -    | -      |
|  |   | SEER   | (W/W)                               | -       | -                                   | -              | -         | 6.0      | -    | -      |
|  |   | Annual consumption                             | kWh                                 | -       | -                                   | -              | -         | 584      | -    | -      |
| Class  |   |  | -                                   | -       | -                                   | -              | A+        | -        | -    |        |
| Power factor   | %   | -  | -                                   | -       | 93                                  | 93             | 93        | -        | -    |        |
| Noise indoor   | dB-A (H/M/L)  | 42/37/35                                       |                                     |         | -                                   |                |           | -        | -    |        |
|  | Power Level dB                                      | 60/55/53                                       |                                     |         | -                                   |                |           | -        | -    |        |
| Noise outdoor  | dB-A (H/L)  | -  |                                     |         | 54/-                                |                |           | -        | -    |        |
|  | Power Level dB                                      | -  |                                     |         | 70/-                                |                |           | -        | -    |        |
| H<br>E<br>A<br>T<br>I<br>N<br>G                            | Capacity  | kW   | 10.0                                | 10.0    | 10.0                                | -              | -         | -        | 2.1  | 13.8   |
|  |   | BTU/h  | 34100                               | 34100   | 34100                               | -              | -         | -        | 7200 | 47100  |
|  | Current   | A  | 0.69                                | 0.67    | 0.65                                | 4.10           | 3.90      | 3.75     | -    | -      |
|  |   | W  | 80                                  | 80      | 80                                  | 2.520k         | 2.520k    | 2.520k   | -    | -      |
|  | Input power   | TOTAL W  | -                                   | -       | -                                   | 2.600k         | 2.600k    | 2.600k   | 410  | 4.000k |
|  |   | COP/COP CLASS                                  | TOTAL (W/W) <sup>*5</sup> ("A"~"G") | -       | -                                   | -              | 3.85      | 3.85 / A | 3.85 | 5.12   |
|  | E <sub>rp</sub> <sup>*6</sup>                       | Pdesign at -10°C                               | kW                                  | -       | -                                   | -              | -         | 10.0     | -    | -      |
|  |   | Tbivalent                                      | °C                                  | -       | -                                   | -              | -         | -7       | -    | -      |
|  |   | SCOP   | (W/W)                               | -       | -                                   | -              | -         | 3.9      | -    | -      |
|  |   | Annual consumption                             | kWh                                 | -       | -                                   | -              | -         | 3590     | -    | -      |
| Class  |   | -  | -                                   | -       | -                                   | A              | -         | -        |      |        |
| Power factor   | %   | -  | -                                   | -       | 93                                  | 93             | 93        | -        | -    |        |
| Noise indoor   | dB-A (H/M/L)  | 42/37/35                                       |                                     |         | -                                   |                |           | -        | -    |        |
|  | Power Level dB                                      | 60/55/53                                       |                                     |         | -                                   |                |           | -        | -    |        |
| Noise outdoor  | dB-A (H/L)  | -  |                                     |         | 54/-                                |                |           | -        | -    |        |
|  | Power Level dB                                      | -  |                                     |         | 70/-                                |                |           | -        | -    |        |
| EXTRA LOW TEMP   Total capacity(kW) / Input power(W) / COP |   | -  |                                     |         |                                     |                |           |          |      |        |
| Max Current(A) / Max Input power(W)                        |   | 0.69/80  | 0.67/80                             | 0.65/80 | 9.0/5.51k                           | 9.0/5.80k      | 9.0/6.02k | -        |      |        |
| Starting current(A) / Comp output(W)                       |   | -  | -                                   | -       | 5.30/1.7k                           | 5.05/1.7k      | 4.85/1.7k | -        |      |        |
| Network Impedance(ΩMAX.)                                   |   | -  |                                     |         |                                     |                |           |          |      |        |
| Fan motor output (Indoor/Outdoor) W                        |   | 111  |                                     |         | 90                                  |                |           | -        |      |        |
| Moisture removal volume                                    |   | L/h(Pt/h)                                      | 6.0                                 | (12.6)  |                                     | -              |           |          | -    |        |
| External static pressure                                   |   | Pa   | -                                   |         |                                     | -              |           |          | -    |        |
| Indoor Air flow  | Cooling   | m³/min (ft³/min)                               | 30/25/23 (1059/883/812)             |         |                                     | -              |           |          | -    |        |
|  | Heating   | m³/min (ft³/min)                               | 30/25/23 (1059/883/812)             |         |                                     | -              |           |          | -    |        |
| Outdoor Air flow   | Cooling   | m³/min (ft³/min)                               | -                                   |         |                                     | 76             | (2684)    |          | -    |        |
|  | Heating   | m³/min (ft³/min)                               | -                                   |         |                                     | 67             | (2366)    |          | -    |        |
| Refrigerant type / amount g(oz)                            |   | -  |                                     |         | R410A                               | 2.60k          | (91.7)    |          | -    |        |
| Product dimension  | Height  | mm(inch)                                       | 235 (9-1/4)                         |         |                                     | 996 (39-7/32)  |           |          | -    |        |
|  | Width   | mm(inch)                                       | 1590 (62-19/32)                     |         |                                     | 940 (37-1/32)  |           |          | -    |        |
|  | Depth   | mm(inch)                                       | 690 (27-5/32)                       |         |                                     | 340 (13-13/32) |           |          | -    |        |
| Packing dimension  | Height  | mm(inch)                                       | 360                                 |         |                                     | 1136           |           |          | -    |        |
|  | Width   | mm(inch)                                       | 1655                                |         |                                     | 1055           |           |          | -    |        |
|  | Depth   | mm(inch)                                       | 820                                 |         |                                     | 485            |           |          | -    |        |
| Weight   | (NET)   | kg(lb)   | 40 (88)                             |         |                                     | 73 (161)       |           |          | -    |        |
|  | (GROSS)   | kg(lb)   | 49 (108)                            |         |                                     | 81 (179)       |           |          | -    |        |
| Layers limit (actually)                                    |   | 9 (10)   |                                     |         | 2 (3)                               |                |           | -        |      |        |
| Operation condition  | Cool (DBT)  | 18°C ~ 32°C                                    |                                     |         | -10°C ~ 43°C                        |                |           | -        |      |        |
|  | Heat (DBT)  | 16°C ~ 30°C                                    |                                     |         | -15°C ~ 24°C                        |                |           | -        |      |        |
| P<br>I<br>P<br>I<br>N<br>G                                 | Pipe diameter mm (inch)                             | (Liquid)ø9.52(3/8) (Gas)ø15.88(5/8)            |                                     |         | (Liquid)ø9.52(3/8) (Gas)ø15.88(5/8) |                |           | -        |      |        |
|  | Connecting method, Standard length m(ft)            | flared type, 5.0(16.4)                         |                                     |         | flared type, 5.0(16.4)              |                |           | -        |      |        |
|  | Pipe length range                                   | m (ft)   |                                     |         | 5 ~ 50 (16.4 ~ 164.0)               |                |           | -        |      |        |
|  | Indoor unit & Outdoor unit height difference m (ft) | 15 (OD located lower) / 30 (OD located higher) |                                     |         | (49.2/98.4)                         |                |           | -        |      |        |
|  | Add gas amount g/m (oz/ft)                          | 50   |                                     |         | (0.538)                             |                |           | -        |      |        |
|  | Pipe length for additional gas                      | m (ft)   |                                     |         | 30 (98.4)                           |                |           | -        |      |        |

\*1: In case it is necessary to indicate the air flow volume in (l/s), the value in (m³/min.) shall be multiplied by 16.7 and rounded down the decimal point.

\*2: If the EUROVENT Certified models can be operated under the "extra-low" temperature condition, -7°C dry bulb and -8°C wet-bulb temperatures with rated voltage 230 V shall be used.

\*3: Network Impedance shall be applicable for EUROPE and CHINA models.

\*4: The annual consumption is calculated by multiplying the input power at 230 V (400 V) by an average of 500 hours per year in cooling mode.

\*5: EER and COP classification is at 230 V (400 V) only in accordance with EU directive 2002/31/EC.

\*6: SEER and SCOP classification is at 230V(400V) only in accordance with EN-14825. For heating, SCOP indicates the value of only Average heating season, Other fiche data indicates in an attached sheet.

# Single -Type

## 1-1. Unit Specifications

**PEY1**

### 8. Ceiling Type S-125PT2E5A / U-125PEY1E8

|  |  |                                     |                                     |  |                                       |                |            |            |         |        |      |
|--|--|-------------------------------------|-------------------------------------|--|---------------------------------------|----------------|------------|------------|---------|--------|------|
| INDOOR   |  | MODEL                               | S-125PT2E5A                         |  |                                       | -              |            |            | -       |        |      |
| PANEL  |  | MODEL                               | -                                   |  |                                       | -              |            |            | -       |        |      |
| OUTDOOR  |  | MODEL                               | -                                   |  |                                       | U-125PEY1E8    |            |            | -       |        |      |
| Branch pipe  |  | MODEL                               | -                                   |  |                                       | -              |            |            | -       |        |      |
| Performance test condition                                 |  |                                     |                                     |  | ISO5151 / EN14511 / EN12102 / EN14825 |                |            |            |         |        |      |
| Power supply   |  | Ø, Hz                               | 1ø 50Hz                             |  |                                       | 3ø 50Hz        |            |            |         |        |      |
|  |  | V                                   | 220                                 | 230  | 240                                   | 380            | 400        | 415        | Min     | Max    |      |
| C<br>O<br>O<br>L<br>I<br>N<br>G                            | Capacity                                 | kW                                  | 12.5                                | 12.5   | 12.5                                  | -              | -          | -          | 3.8     | 13.5   |      |
|  |  | BTU/h                               | 42700                               | 42700  | 42700                                 | -              | -          | -          | 13000   | 46100  |      |
|  | Current                                  | A                                   | 0.89                                | 0.86   | 0.83                                  | 6.50           | 6.20       | 6.00       | -       | -      |      |
|  |  | W                                   | 110                                 | 110  | 110                                   | 4.040k         | 4.040k     | 4.040k     | -       | -      |      |
|  | Input power                              | TOTAL W                             | -                                   |  |                                       | 4.150k         | 4.150k     | 4.150k     | 900     | 5.160k |      |
|  |  | Annual consumption                  | TOTAL kWh *4                        | -  |                                       |                | -          | 2075       | -       | -      | -    |
|  | EER/EER CLASS                            | TOTAL (W/W) <sup>*5</sup> ("A"~"G") | -                                   | -  | -                                     | 3.01           | 3.01 / B   | 3.01       | 4.22    | 2.62   |      |
|  | E<br>r<br>p<br>*6                        | Pdesign                             | kW                                  | -  | -                                     | -              | -          | 12.5       | -       | -      | -    |
|  |  | η <sub>s.c</sub>                    | %                                   | -  | -                                     | -              | -          | 206.7      | -       | -      | -    |
|  |  | Annual consumption                  | kWh                                 | -  | -                                     | -              | -          | -          | -       | -      | -    |
| Class  |  |                                     | -                                   | -  | -                                     | -              | -          | -          | -       | -      |      |
| Power factor   | %  | -                                   | -                                   | -  | 94                                    | 94             | 94         | -          | -       |        |      |
| Noise indoor   | dB-A (H/M/L)                             | 46/40/36                            |                                     |  | -                                     |                |            | -          | -       | -      |      |
|  | Power Level dB                           | 64/58/54                            |                                     |  | -                                     |                |            | -          | -       | -      |      |
| Noise outdoor  | dB-A (H/L)                               | -                                   |                                     |  | 56/-                                  |                |            | -          | -       | -      |      |
|  | Power Level dB                           | -                                   |                                     |  | 73/-                                  |                |            | -          | -       | -      |      |
| H<br>E<br>A<br>T<br>I<br>N<br>G                            | Capacity                                 | kW                                  | 12.5                                | 12.5   | 12.5                                  | -              | -          | -          | 3.4     | 15.0   |      |
|  |  | BTU/h                               | 42700                               | 42700  | 42700                                 | -              | -          | -          | 11600   | 51200  |      |
|  | Current                                  | A                                   | 0.89                                | 0.86   | 0.83                                  | 5.10           | 4.80       | 4.65       | -       | -      |      |
|  |  | W                                   | 110                                 | 110  | 110                                   | 3.140k         | 3.140k     | 3.140k     | -       | -      |      |
|  | Input power                              | TOTAL W                             | -                                   |  |                                       | 3.250k         | 3.250k     | 3.250k     | 730     | 4.400k |      |
|  |  | COP/COP CLASS                       | TOTAL (W/W) <sup>*5</sup> ("A"~"G") | -  | -                                     | -              | 3.85       | 3.85 / A   | 3.85    | 4.66   | 3.41 |
|  | E<br>r<br>p<br>*6                        | Pdesign at -10°C                    | kW                                  | -  | -                                     | -              | -          | 12.5       | -       | -      | -    |
|  |  | Tbivalent                           | °C                                  | -  | -                                     | -              | -          | -7         | -       | -      | -    |
|  |  | η <sub>s.h</sub>                    | %                                   | -  | -                                     | -              | -          | 140.0      | -       | -      | -    |
|  |  | Annual consumption                  | kWh                                 | -  | -                                     | -              | -          | -          | -       | -      | -    |
| Class  |  | -                                   | -                                   | -  | -                                     | -              | -          | -          | -       |        |      |
| Power factor   | %  | -                                   | -                                   | -  | 94                                    | 94             | 94         | -          | -       |        |      |
| Noise indoor   | dB-A (H/M/L)                             | 46/40/36                            |                                     |  | -                                     |                |            | -          | -       | -      |      |
|  | Power Level dB                           | 64/58/54                            |                                     |  | -                                     |                |            | -          | -       | -      |      |
| Noise outdoor  | dB-A (H/L)                               | -                                   |                                     |  | 56/-                                  |                |            | -          | -       | -      |      |
|  | Power Level dB                           | -                                   |                                     |  | 73/-                                  |                |            | -          | -       | -      |      |
| EXTRA LOW TEMP   Total capacity(kW) / Input power(W) / COP |  |                                     |                                     |  |                                       |                |            |            |         |        |      |
| Max Current(A) / Max Input power(W)                        |  |                                     | 0.89/110                            | 0.86/110                                       | 0.83/110                              | 10.0/6.19k     | 10.0/6.51k | 10.0/6.75k | -       |        |      |
| Starting current(A) / Comp output(W)                       |  |                                     | -                                   | -  | -                                     | 6.50/3.0k      | 6.20/3.0k  | 6.00/3.0k  | -       |        |      |
| Network Impedance(ΩMAX.)                                   |  |                                     | -                                   |  |                                       | -              |            |            | -       |        |      |
| Fan motor output (Indoor/Outdoor) W                        |  |                                     | 111                                 |  |                                       | 90             |            |            | -       |        |      |
| Moisture removal volume                                    |  |                                     | L/h(Pt/h)                           |  | 7.9                                   | (16.6)         |            | -          |         | -      |      |
| External static pressure                                   |  |                                     | Pa                                  |  | -                                     |                |            | -          |         | -      |      |
| Indoor Air flow  | Cooling                                  | m³/min (ft³/min)                    | 34/28/24 (1201/989/848)             |  |                                       | -              |            |            | -       | -      |      |
|  | Heating                                  | m³/min (ft³/min)                    | 34/28/24 (1201/989/848)             |  |                                       | -              |            |            | -       | -      |      |
| Outdoor Air flow   | Cooling                                  | m³/min (ft³/min)                    | -                                   |  |                                       | 80             |            | (2825)     |         | -      |      |
|  | Heating                                  | m³/min (ft³/min)                    | -                                   |  |                                       | 73             |            | (2578)     |         | -      |      |
| Refrigerant type / amount g(oz)                            |  |                                     |                                     |  | R410A                                 |                | 3.20k      |            | (112.9) |        |      |
| Product dimension  | Height                                   | mm(inch)                            | 235 (9-1/4)                         |  |                                       | 996 (39-7/32)  |            |            | -       |        |      |
|  | Width                                    | mm(inch)                            | 1590 (62-19/32)                     |  |                                       | 940 (37-1/32)  |            |            | -       |        |      |
|  | Depth                                    | mm(inch)                            | 690 (27-5/32)                       |  |                                       | 340 (13-13/32) |            |            | -       |        |      |
| Packing dimension  | Height                                   | mm(inch)                            | 360                                 |  |                                       | 1136           |            |            | -       |        |      |
|  | Width                                    | mm(inch)                            | 1655                                |  |                                       | 1055           |            |            | -       |        |      |
|  | Depth                                    | mm(inch)                            | 820                                 |  |                                       | 485            |            |            | -       |        |      |
| Weight   | (NET)                                    | kg(lb)                              | 40 (88)                             |  |                                       | 85 (187)       |            |            | -       |        |      |
|  | (GROSS)                                  | kg(lb)                              | 49 (108)                            |  |                                       | 93 (205)       |            |            | -       |        |      |
| Layers limit (actually)                                    |  |                                     | 9 (10)                              |  |                                       | 2 (3)          |            |            | -       |        |      |
| Operation condition  | Cool (DBT)                               | 18°C ~ 32°C                         |                                     |  | -10°C ~ 43°C                          |                |            | -          |         |        |      |
|  | Heat (DBT)                               | 16°C ~ 30°C                         |                                     |  | -15°C ~ 24°C                          |                |            | -          |         |        |      |
| P<br>I<br>P<br>I<br>N<br>G                                 | Pipe diameter mm (inch)                  | (Liquid)ø9.52(3/8) (Gas)ø15.88(5/8) |                                     |  | (Liquid)ø9.52(3/8) (Gas)ø15.88(5/8)   |                |            | -          |         |        |      |
|  | Connecting method, Standard length m(ft) | flared type, 5.0(16.4)              |                                     |  | flared type, 5.0(16.4)                |                |            | -          |         |        |      |
| Pipe length range  |  | m (ft)                              |                                     | 5 ~ 50 (16.4 ~ 164.0)                          |                                       | -              |            |            |         |        |      |
| Indoor unit & Outdoor unit height difference               |  | m (ft)                              |                                     | 15 (OD located lower) / 30 (OD located higher) |                                       | (49.2/98.4)    |            | -          |         |        |      |
| Add gas amount   |  | g/m (oz/ft)                         |                                     | 50 (0.538)                                     |                                       | -              |            |            |         |        |      |
| Pipe length for additional gas                             |  | m (ft)                              |                                     | 30 (98.4)                                      |                                       | -              |            |            |         |        |      |

\*1: In case it is necessary to indicate the air flow volume in (l/s), the value in (m³/min.) shall be multiplied by 16.7 and rounded down the decimal point.

\*2: If the EUROVENT Certified models can be operated under the "extra-low" temperature condition, -7°C dry bulb and -8°C wet-bulb temperatures with rated voltage 230 V shall be used.

\*3: Network Impedance shall be applicable for EUROPE and CHINA models.

\*4: The annual consumption is calculated by multiplying the input power at 230 V (400 V) by an average of 500 hours per year in cooling mode.

\*5: EER and COP classification is at 230 V (400 V) only in accordance with EU directive 2002/31/EC.

\*6: SEER and SCOP classification is at 230V(400V) only in accordance with EN-14825. For heating, SCOP indicates the value of only Average heating season.

# Single -Type

## 1-1. Unit Specifications

**PEY1**

### 8. Ceiling Type S-140PT2E5A / U-140PEY1E8

| INDOOR   |  | MODEL  | S-140PT2E5A                           |          |                                     | -              |            |       | -      |       |  |
|--|--|--|---------------------------------------|----------|-------------------------------------|----------------|------------|-------|--------|-------|--|
| PANEL  |  | MODEL  | -                                     |          |                                     | -              |            |       | -      |       |  |
| OUTDOOR  |  | MODEL  | -                                     |          |                                     | U-140PEY1E8    |            |       | -      |       |  |
| Branch pipe  |  | MODEL  | -                                     |          |                                     | -              |            |       | -      |       |  |
| Performance test condition                                 |  |  | ISO5151 / EN14511 / EN12102 / EN14825 |          |                                     |                |            |       |        |       |  |
| Power supply   |  | Ø, Hz  | 1ø 50Hz                               |          |                                     | 3ø 50Hz        |            |       |        |       |  |
|  |  | V  | 220                                   | 230      | 240                                 | 380            | 400        | 415   | Min    | Max   |  |
| Capacity   | kW                                       | 14.0   | 14.0                                  | 14.0     | -                                   | -              | -          | -     | 3.3    | 15.0  |  |
|  | BTU/h                                    | 47800  | 47800                                 | 47800    | -                                   | -              | -          | -     | 11300  | 51200 |  |
| Current  | A  | 0.94   | 0.91                                  | 0.88     | 7.40                                | 7.00           | 6.80       | -     | -      | -     |  |
| Input power  | W  | 120  | 120                                   | 120      | 4.580k                              | 4.580k         | 4.580k     | -     | -      | -     |  |
|  | TOTAL W                                  | -  | -                                     | -        | 4.700k                              | 4.700k         | 4.700k     | 840   | 5.700k | -     |  |
| Annual consumption   | TOTAL kWh *4                             | -  | -                                     | -        | -                                   | 2350           | -          | -     | -      | -     |  |
| EER/EER CLASS  | TOTAL (W/W) <sup>*5</sup> ("A"~"G")      | -  | -                                     | -        | 2.98                                | 2.98 / C       | 2.98       | 3.93  | 2.63   | -     |  |
| Erp *6   | Pdesign                                  | kW   | -                                     | -        | -                                   | -              | 14.0       | -     | -      | -     |  |
|  | η <sub>s,c</sub>                         | %  | -                                     | -        | -                                   | -              | 206.8      | -     | -      | -     |  |
|  | Annual consumption                       | kWh  | -                                     | -        | -                                   | -              | -          | -     | -      | -     |  |
|  | Class                                    | -  | -                                     | -        | -                                   | -              | -          | -     | -      | -     |  |
| Power factor   | %  | -  | -                                     | -        | 94                                  | 94             | 94         | -     | -      | -     |  |
| Noise indoor   | dB-A (H/M/L)                             | 47/41/37                                       |                                       |          | -                                   |                |            | -     |        | -     |  |
|  | Power Level dB                           | 65/59/55                                       |                                       |          | -                                   |                |            | -     |        | -     |  |
| Noise outdoor  | dB-A (H/L)                               | -  |                                       |          | 54/-                                |                |            | -     |        | -     |  |
|  | Power Level dB                           | -  |                                       |          | 71/-                                |                |            | -     |        | -     |  |
| Capacity   | kW                                       | 14.0   | 14.0                                  | 14.0     | -                                   | -              | -          | 4.1   | 16.0   | -     |  |
|  | BTU/h                                    | 47800  | 47800                                 | 47800    | -                                   | -              | -          | 14000 | 54600  | -     |  |
| Current  | A  | 0.94   | 0.91                                  | 0.88     | 5.65                                | 5.35           | 5.15       | -     | -      | -     |  |
| Input power  | W  | 120  | 120                                   | 120      | 3.490k                              | 3.490k         | 3.490k     | -     | -      | -     |  |
|  | TOTAL W                                  | -  | -                                     | -        | 3.610k                              | 3.610k         | 3.610k     | 900   | 5.210k | -     |  |
| COP/COP CLASS  | TOTAL (W/W) <sup>*5</sup> ("A"~"G")      | -  | -                                     | -        | 3.88                                | 3.88 / A       | 3.88       | 4.56  | 3.07   | -     |  |
| Erp *6   | Pdesign at -10°C                         | kW   | -                                     | -        | -                                   | -              | 14.0       | -     | -      | -     |  |
|  | Tbivalent                                | °C   | -                                     | -        | -                                   | -              | -7         | -     | -      | -     |  |
|  | η <sub>s,h</sub>                         | %  | -                                     | -        | -                                   | -              | 139.9      | -     | -      | -     |  |
|  | Annual consumption                       | kWh  | -                                     | -        | -                                   | -              | -          | -     | -      | -     |  |
| Class  | -  | -  | -                                     | -        | -                                   | -              | -          | -     | -      | -     |  |
| Power factor   | %  | -  | -                                     | -        | 94                                  | 94             | 94         | -     | -      | -     |  |
| Noise indoor   | dB-A (H/M/L)                             | 47/41/37                                       |                                       |          | -                                   |                |            | -     |        | -     |  |
|  | Power Level dB                           | 65/59/55                                       |                                       |          | -                                   |                |            | -     |        | -     |  |
| Noise outdoor  | dB-A (H/L)                               | -  |                                       |          | 53/-                                |                |            | -     |        | -     |  |
|  | Power Level dB                           | -  |                                       |          | 70/-                                |                |            | -     |        | -     |  |
| EXTRA LOW TEMP   Total capacity(kW) / Input power(W) / COP |  | -  |                                       |          | -                                   |                |            | -     |        | -     |  |
| Max Current(A) / Max Input power(W)                        |  | 0.94/120                                       | 0.91/120                              | 0.88/120 | 10.0/6.19k                          | 10.0/6.51k     | 10.0/6.75k | -     |        |       |  |
| Starting current(A) / Comp output(W)                       |  | -  | -                                     | -        | 7.40/3.0k                           | 7.00/3.0k      | 6.80/3.0k  | -     |        |       |  |
| Network Impedance(ΩMAX.)                                   |  | -  |                                       |          | -                                   |                |            | -     |        |       |  |
| Fan motor output (Indoor/Outdoor) W                        |  | 111  |                                       |          | 90×2                                |                |            | -     |        |       |  |
| Moisture removal volume                                    |  | L/h(Pt/h)                                      | 9.0                                   | (18.9)   | -                                   |                |            | -     |        |       |  |
| External static pressure                                   |  | Pa   | -                                     |          |                                     | -              |            |       | -      |       |  |
| Indoor Air flow  | Cooling                                  | m³/min (ft³/min)                               | 35/29/25 (1236/1024/883)              |          |                                     | -              |            |       | -      |       |  |
|  | Heating                                  | m³/min (ft³/min)                               | 35/29/25 (1236/1024/883)              |          |                                     | -              |            |       | -      |       |  |
| Outdoor Air flow   | Cooling                                  | m³/min (ft³/min)                               | -                                     |          |                                     | 135            | (4767)     | -     |        |       |  |
|  | Heating                                  | m³/min (ft³/min)                               | -                                     |          |                                     | 120            | (4238)     | -     |        |       |  |
| Refrigerant type / amount g(oz)                            |  | -  |                                       |          | R410A                               | 3.40k          | (119.9)    | -     |        |       |  |
| Product dimension  | Height                                   | mm(inch)                                       | 235 (9-1/4)                           |          |                                     | 1416 (55-3/4)  |            |       | -      |       |  |
|  | Width                                    | mm(inch)                                       | 1590 (62-19/32)                       |          |                                     | 940 (37-1/32)  |            |       | -      |       |  |
|  | Depth                                    | mm(inch)                                       | 690 (27-5/32)                         |          |                                     | 340 (13-13/32) |            |       | -      |       |  |
| Packing dimension  | Height                                   | mm(inch)                                       | 360                                   |          |                                     | 1556           |            |       | -      |       |  |
|  | Width                                    | mm(inch)                                       | 1655                                  |          |                                     | 1055           |            |       | -      |       |  |
|  | Depth                                    | mm(inch)                                       | 820                                   |          |                                     | 485            |            |       | -      |       |  |
| Weight   | (NET)                                    | kg(lb)   | 40 (88)                               |          |                                     | 98 (216)       |            |       | -      |       |  |
|  | (GROSS)                                  | kg(lb)   | 49 (108)                              |          |                                     | 108 (238)      |            |       | -      |       |  |
| Layers limit (actually)                                    |  | 9 (10)   |                                       |          | 1 (2)                               |                |            | -     |        |       |  |
| Operation condition  | Cool (DBT)                               | 18°C ~ 32°C                                    |                                       |          | -10°C ~ 43°C                        |                |            | -     |        |       |  |
|  | Heat (DBT)                               | 16°C ~ 30°C                                    |                                       |          | -15°C ~ 24°C                        |                |            | -     |        |       |  |
| P I P I N G  | Pipe diameter mm (inch)                  | (Liquid)ø9.52(3/8) (Gas)ø15.88(5/8)            |                                       |          | (Liquid)ø9.52(3/8) (Gas)ø15.88(5/8) |                |            | -     |        |       |  |
|  | Connecting method, Standard length m(ft) | flared type, 5.0(16.4)                         |                                       |          | flared type, 5.0(16.4)              |                |            | -     |        |       |  |
| Pipe length range  |  | m (ft)   |                                       |          | 5 ~ 50 (16.4 ~ 164.0)               |                |            | -     |        |       |  |
| Indoor unit & Outdoor unit height difference m (ft)        |  | 15 (OD located lower) / 30 (OD located higher) |                                       |          | (49.2/98.4)                         |                |            | -     |        |       |  |
| Add gas amount g/m (oz/ft)                                 |  | 50   |                                       |          | (0.538)                             |                |            | -     |        |       |  |
| Pipe length for additional gas                             |  | m (ft)   |                                       |          | 30 (98.4)                           |                |            | -     |        |       |  |

\*1: In case it is necessary to indicate the air flow volume in (l/s), the value in (m³/min.) shall be multiplied by 16.7 and rounded down the decimal point.

\*2: If the EUROVENT Certified models can be operated under the "extra-low" temperature condition, -7°C dry bulb and -8°C wet-bulb temperatures with rated voltage 230 V shall be used.

\*3: Network Impedance shall be applicable for EUROPE and CHINA models.

\*4: The annual consumption is calculated by multiplying the input power at 230 V (400 V) by an average of 500 hours per year in cooling mode.

\*5: EER and COP classification is at 230 V (400 V) only in accordance with EU directive 2002/31/EC.

\*6: SEER and SCOP classification is at 230V(400V) only in accordance with EN-14825. For heating, SCOP indicates the value of only Average heating season.

# Simultaneous (Twin) -Type

## 1-1. Unit Specifications

**PEY1**

### 9. Wall Mounted Type S-50PK1E5A×2 / U-100PEY1E5

|   |   |  |                              |             |                                     |                |             |      |        |      |
|---|---|--|------------------------------|-------------|-------------------------------------|----------------|-------------|------|--------|------|
| INDOOR  | MODEL   | S-50PK1E5A×2                                   |                              |             | -                                   |                |             | -    |        |      |
| PANEL   | MODEL   | -  |                              |             | -                                   |                |             | -    |        |      |
| OUTDOOR   | MODEL   | -  |                              |             | U-100PEY1E5                         |                |             | -    |        |      |
| Branch pipe   | MODEL   | -  |                              |             | CZ-P155BK1                          |                |             | -    |        |      |
| Performance test condition  |   | ISO5151 / EN14511 / EN14825 / EN12102          |                              |             |                                     |                |             |      |        |      |
| Power supply  | Ø, Hz   | 1ø 50Hz  |                              |             | 1ø 50Hz                             |                |             |      |        |      |
|   | V   | 220  | 230                          | 240         | 220                                 | 230            | 240         | Min  | Max    |      |
| Capacity  | kW  | 10.0   | 10.0                         | 10.0        | -                                   | -              | -           | 2.7  | 11.0   |      |
|   | BTU/h   | 34100  | 34100                        | 34100       | -                                   | -              | -           | 9200 | 37500  |      |
| Current   | A   | 0.27×2   | 0.27×2                       | 0.27×2      | 17.0                                | 16.3           | 15.5        | -    | -      |      |
|   | W   | 26×2   | 27×2                         | 28×2        | 3.515k                              | 3.515k         | 3.510k      | -    | -      |      |
| Input power   | TOTAL W   | -  |                              |             | 3.570k                              | 3.570k         | 3.570k      | 530  | 4.200k |      |
|   | Annual consumption                                  | -  |                              |             | -                                   | 1785           | -           | -    | -      |      |
| EER/EER CLASS   | TOTAL (W/W) <sup>*2</sup> ("A"~"G")                 | -  | -                            | -           | 2.80                                | 2.80 / C       | 2.80        | 5.09 | 2.62   |      |
| Erp <sup>*3</sup>   | Pdesign   | kW   | -                            | -           | -                                   | 10.0           | -           | -    | -      |      |
|   | SEER  | (W/W)  | -                            | -           | -                                   | 6.1            | -           | -    | -      |      |
|   | Annual consumption                                  | kWh  | -                            | -           | -                                   | 574            | -           | -    | -      |      |
|   | Class   |  | -                            | -           | -                                   | A++            | -           | -    | -      |      |
| Power factor  | %   | -  | -                            | -           | 94                                  | 94             | 94          | -    | -      |      |
| Noise indoor  | dB-A (H/M/L)  | 40/36/32                                       |                              |             | -                                   |                |             | -    | -      |      |
|   | Power Level dB                                      | 57/51/46                                       |                              |             | -                                   |                |             | -    | -      |      |
| Noise outdoor   | dB-A (H/L)  | -  |                              |             | 54/-                                |                |             | -    | -      |      |
|   | Power Level dB                                      | -  |                              |             | 70/-                                |                |             | -    | -      |      |
| Capacity  | kW  | 10.0   | 10.0                         | 10.0        | -                                   | -              | -           | 2.1  | 12.4   |      |
|   | BTU/h   | 34100  | 34100                        | 34100       | -                                   | -              | -           | 7200 | 42300  |      |
| Current   | A   | 0.27×2   | 0.27×2                       | 0.27×2      | 12.9                                | 12.4           | 11.9        | -    | -      |      |
|   | W   | 26×2   | 27×2                         | 28×2        | 2.720k                              | 2.720k         | 2.715k      | -    | -      |      |
| Input power   | TOTAL W   | -  |                              |             | 2.775k                              | 2.775k         | 2.775k      | 410  | 4.000k |      |
|   | COP/COP CLASS                                       | TOTAL (W/W) <sup>*5</sup> ("A"~"G")            | -                            | -           | -                                   | 3.60           | 3.60 / A    | 3.60 | 5.12   | 3.10 |
| Erp <sup>*3</sup>   | Pdesign at -10°C                                    | kW   | -                            | -           | -                                   | 10.0           | -           | -    | -      |      |
|   | Tbivalent   | °C   | -                            | -           | -                                   | -7             | -           | -    | -      |      |
|   | SCOP  | (W/W)  | -                            | -           | -                                   | 3.8            | -           | -    | -      |      |
|   | Annual consumption                                  | kWh  | -                            | -           | -                                   | 3684           | -           | -    | -      |      |
| Class   |   | -  | -                            | -           | A                                   | -              | -           | -    | -      |      |
| Power factor  | %   | -  | -                            | -           | 96                                  | 95             | 95          | -    | -      |      |
| Noise indoor  | dB-A (H/M/L)  | 40/36/32                                       |                              |             | -                                   |                |             | -    | -      |      |
|   | Power Level dB                                      | 57/51/46                                       |                              |             | -                                   |                |             | -    | -      |      |
| Noise outdoor   | dB-A (H/L)  | -  |                              |             | 54/-                                |                |             | -    | -      |      |
|   | Power Level dB                                      | -  |                              |             | 70/-                                |                |             | -    | -      |      |
| EXTRA LOW TEMP <sup>6</sup> Total capacity(kW) / Input power(W) / COP |   | -  |                              |             |                                     |                |             |      |        |      |
| Max Current(A) / Max Input power(W)                                   |   | 0.27×2/26×2                                    | 0.27×2/27×2                  | 0.27×2/28×2 | 25.0/5.300k                         | 25.0/5.500k    | 25.0/5.700k |      |        |      |
| Starting current(A) / Comp output(W)                                  |   | -  | -                            | -           | 17.0/1.7k                           | 16.3/1.7k      | 15.5/1.7k   |      |        |      |
| Network Impedance(ΩMAX.)  |   | -  |                              |             |                                     |                |             |      |        |      |
| Fan motor output (Indoor/Outdoor) W                                   |   | 47×2   |                              |             | 90                                  |                |             |      |        |      |
| Moisture removal volume   |   | L/h(Pt/h)                                      | 6.0                          | (3.0×2)     | (12.6)                              | -              |             |      | -      |      |
| External static pressure  |   | Pa   | -                            |             |                                     | -              |             |      | -      |      |
| Indoor Air flow   | Cooling   | m³/min (ft³/min)                               | [14/12/10.5 (494/424/371)]×2 |             |                                     | -              |             |      | -      |      |
|   | Heating   | m³/min (ft³/min)                               | [14/12/10.5 (494/424/371)]×2 |             |                                     | -              |             |      | -      |      |
| Outdoor Air flow  | Cooling   | m³/min (ft³/min)                               | -                            |             |                                     | 76             | (2684)      | -    |        |      |
|   | Heating   | m³/min (ft³/min)                               | -                            |             |                                     | 67             | (2366)      | -    |        |      |
| Refrigerant type / amount g(oz)                                       |   | -  |                              |             | R410A                               | 2.60k          | (91.7)      | -    |        |      |
| Product dimension   | Height  | mm(inch)                                       | 300 (11-1/32)                |             |                                     | 996 (39-7/32)  |             |      | -      |      |
|   | Width   | mm(inch)                                       | 1065 (41-15/16)              |             |                                     | 940 (37-1/32)  |             |      | -      |      |
|   | Depth   | mm(inch)                                       | 230 (9-1/32)                 |             |                                     | 340 (13-13/32) |             |      | -      |      |
| Packing dimension   | Height  | mm(inch)                                       | 310                          |             |                                     | 1136           |             |      | -      |      |
|   | Width   | mm(inch)                                       | 1140                         |             |                                     | 1055           |             |      | -      |      |
|   | Depth   | mm(inch)                                       | 380                          |             |                                     | 485            |             |      | -      |      |
| Weight  | (NET)   | kg(lb)   | 13 (29)                      |             |                                     | 73 (161)       |             |      | -      |      |
|   | (GROSS)   | kg(lb)   | 17 (37)                      |             |                                     | 81 (179)       |             |      | -      |      |
| Layers limit (actually)   |   | 15 (16)  |                              |             | 2 (3)                               |                |             | -    |        |      |
| Operation condition   | Cool (DBT)  | 18°C ~ 32°C                                    |                              |             | -10°C ~ 43°C                        |                |             | -    |        |      |
|   | Heat (DBT)  | 16°C ~ 30°C                                    |                              |             | -15°C ~ 24°C                        |                |             | -    |        |      |
| P I P I N G   | Pipe diameter mm (inch)                             | (Liquid)ø6.35(1/4) (Gas)ø12.7(1/2)             |                              |             | (Liquid)ø9.52(3/8) (Gas)ø15.88(5/8) |                |             | -    |        |      |
|   | Connecting method, Standard length m(ft)            | flared type, 5.0(16.4)                         |                              |             | flared type, 5.0(16.4)              |                |             | -    |        |      |
| I N G   | Pipe length range                                   | m (ft)   |                              |             | 5 ~ 50 (16.4 ~ 164.0)               |                |             | -    |        |      |
|   | Indoor unit & Outdoor unit height difference m (ft) | 15 (OD located lower) / 30 (OD located higher) |                              |             | (49.2/98.4)                         |                |             | -    |        |      |
| N G   | Add gas amount g/m (oz/ft)                          | 50   |                              |             | (0.538)                             |                |             | -    |        |      |
|   | Pipe length for additional gas                      | m (ft)   |                              |             | 30 (98.4)                           |                |             | -    |        |      |

\*1: In case it is necessary to indicate the air flow volume in (l/s), the value in (m³/min.) shall be multiplied by 16.7 and rounded down the decimal point.

\*2: If the EUROVENT Certified models can be operated under the "extra-low" temperature condition, -7°C dry bulb and -8°C wet-bulb temperatures with rated voltage 230 V shall be used.

\*3: Network Impedance shall be applicable for EUROPE and CHINA models.

\*4: The annual consumption is calculated by multiplying the input power at 230 V (400 V) by an average of 500 hours per year in cooling mode.

\*5: EER and COP classification is at 230 V (400 V) only in accordance with EU directive 2002/31/EC.

\*6: SEER and SCOP classification is at 230V(400V) only in accordance with EN-14825. For heating, SCOP indicates the value of only Average heating season, Other fiche data indicates in an attached sheet.

# Single -Type

## 1-1. Unit Specifications

### PEY2

### 9. Wall Mounted Type S-60PK1E5A / U-60PEY2E5

| INDOOR                               |   | MODEL  | S-60PK1E5A                               |                       |                                       | -          |            |        | -    |        |      |
|--------------------------------------|---|--|--|-----------------------|---------------------------------------|------------|------------|--------|------|--------|------|
| PANEL                                |   | MODEL  | -  |                       |                                       | -          |            |        | -    |        |      |
| OUTDOOR                              |   | MODEL  | -  |                       |                                       | U-60PEY2E5 |            |        | -    |        |      |
| Branch pipe                          |   | MODEL  | -  |                       |                                       | -          |            |        | -    |        |      |
| Performance test condition           |   |  |  |                       | ISO5151 / EN14511 / EN12102 / EN14825 |            |            |        |      |        |      |
| Power supply                         |   | Ø, Hz  | 1ø 50Hz                                  |                       |                                       | 1ø 50Hz    |            |        | Min  | Max    |      |
|                                      |   | V  | 220V                                     | 230V                  | 240V                                  | 220V       | 230V       | 240V   |      |        |      |
| C<br>O<br>O<br>L<br>I<br>N<br>G      | Capacity  | kW   | 6.0                                      | 6.0                   | 6.0                                   | -          | -          | -      | 2.0  | 7.1    |      |
|                                      |   | BTU/h  | 20500                                    | 20500                 | 20500                                 | -          | -          | -      | 6800 | 24200  |      |
|                                      | Current   | A  | 0.59                                     | 0.58                  | 0.52                                  | 8.30       | 7.90       | 7.60   | -    | -      |      |
|                                      |   | W  | 57                                       | 57                    | 57                                    | 1.643k     | 1.643k     | 1.643k | -    | -      |      |
|                                      | Input power   | TOTAL W  | -  | -                     | -                                     | 1.700k     | 1.700k     | 1.700k | 300  | 2.350k |      |
|                                      |   | Annual consumption                               | TOTAL kWh *4                             | -                     | -                                     | -          | -          | 850    | -    | -      | -    |
|                                      | EER/EER CLASS                                       | TOTAL (W/W) <sup>5</sup> ("A"~"G")               | -  | -                     | -                                     | 3.53       | 3.53/A     | 3.53   | 6.67 | 3.02   |      |
|                                      | Erp <sup>6</sup>                                    | Pdesign  | kW                                       | -                     | -                                     | -          | -          | 6.0    | -    | -      | -    |
|                                      |   | SEER   | (W/W)                                    | -                     | -                                     | -          | -          | 5.5    | -    | -      | -    |
|                                      |   | Annual consumption                               | kWh                                      | -                     | -                                     | -          | -          | 382    | -    | -      | -    |
| Class                                |   |  | -  | -                     | -                                     | -          | A          | -      | -    | -      |      |
| Power factor                         | %   | -  | -  | -                     | 90                                    | 90         | 90         | -      | -    |        |      |
| Noise indoor                         | dB-A (H/M/L)  | 47/44/40   |  |                       | -                                     |            |            | -      | -    |        |      |
|                                      | Power Level dB                                      | 64/59/54   |  |                       | -                                     |            |            | -      | -    |        |      |
| Noise outdoor                        | dB-A (H/L)  | -  |  |                       | 46/-                                  |            |            | -      | -    |        |      |
|                                      | Power Level dB                                      | -  |  |                       | 65/-                                  |            |            | -      | -    |        |      |
| H<br>E<br>A<br>T<br>I<br>N<br>G      | Capacity  | kW   | 6.0                                      | 6.0                   | 6.0                                   | -          | -          | -      | 1.8  | 7.0    |      |
|                                      |   | BTU/h  | 20500                                    | 20500                 | 20500                                 | -          | -          | -      | 6100 | 23900  |      |
|                                      | Current   | A  | 0.59                                     | 0.58                  | 0.52                                  | 7.05       | 6.75       | 6.45   | -    | -      |      |
|                                      |   | W  | 57                                       | 57                    | 57                                    | 1.393k     | 1.393k     | 1.393k | -    | -      |      |
|                                      | Input power   | TOTAL W  | -  | -                     | -                                     | 1.450k     | 1.450k     | 1.450k | 200  | 1.700k |      |
|                                      |   | COP/COP CLASS                                    | TOTAL (W/W) <sup>5</sup> ("A"~"G")       | -                     | -                                     | -          | 4.14       | 4.14/A | 4.14 | 9.00   | 4.12 |
|                                      | Erp <sup>6</sup>                                    | Pdesign at -10°C                                 | kW                                       | -                     | -                                     | -          | -          | 6.0    | -    | -      | -    |
|                                      |   | Tbivalent  | °C                                       | -                     | -                                     | -          | -          | -8     | -    | -      | -    |
|                                      |   | SCOP   | (W/W)                                    | -                     | -                                     | -          | -          | 3.9    | -    | -      | -    |
|                                      |   | Annual consumption                               | kWh                                      | -                     | -                                     | -          | -          | 2154   | -    | -      | -    |
| Class                                |   | -  | -  | -                     | -                                     | A          | -          | -      | -    |        |      |
| Power factor                         | %   | -  | -  | -                     | 90                                    | 90         | 90         | -      | -    |        |      |
| Noise indoor                         | dB-A (H/M/L)  | 47/44/40   |  |                       | -                                     |            |            | -      | -    |        |      |
|                                      | Power Level dB                                      | 64/59/54   |  |                       | -                                     |            |            | -      | -    |        |      |
| Noise outdoor                        | dB-A (H/L)  | -  |  |                       | 48/-                                  |            |            | -      | -    |        |      |
|                                      | Power Level dB                                      | -  |  |                       | 68/-                                  |            |            | -      | -    |        |      |
| EXTRA LOW TEMP                       |   | Total capacity(kW) / Input power(W) / COP        |  | -                     |                                       | -          |            | -      |      |        |      |
| Max Current(A) / Max Input power(W)  |   | 0.59/57  | 0.58/57                                  | 0.52/57               | 16.5/3.27k                            | 16.5/3.42k | 16.5/3.57k | -      |      |        |      |
| Starting current(A) / Comp output(W) |   | -  | -  | -                     | 8.30/1.7k                             | 7.90/1.7k  | 7.60/1.7k  | -      |      |        |      |
| Network Impedance(ΩMAX.)             |   | -  |  | -                     |                                       | -          |            | -      |      |        |      |
| Fan motor output (Indoor/Outdoor) W  |   | 47   |  | -                     |                                       | 60         |            | -      |      |        |      |
| Moisture removal volume              |   | L/h(Pt/h)  | 3.4                                      | (7.1)                 | -                                     |            | -          |        |      |        |      |
| External static pressure             |   | Pa   | -  |                       | -                                     |            | -          |        |      |        |      |
| Indoor Air flow                      | Cooling   | m³/min (ft³/min)                                 | 18.0 / 14.5 / 11.5 (636) / (512) / (406) |                       |                                       | -          |            |        | -    | -      |      |
|                                      | Heating   | m³/min (ft³/min)                                 | 18.0 / 14.5 / 11.5 (636) / (512) / (406) |                       |                                       | -          |            |        | -    | -      |      |
| Outdoor Air flow                     | Cooling   | m³/min (ft³/min)                                 | -  |                       |                                       | 38         | (1342)     | -      | -    |        |      |
|                                      | Heating   | m³/min (ft³/min)                                 | -  |                       |                                       | 41         | (1448)     | -      | -    |        |      |
| Refrigerant type / amount g(oz)      |   | -  |  | R410A                 |                                       | 1.95k      | (68.8)     | -      |      |        |      |
| Product dimension                    | Height  | mm(inch)   | 300                                      | (11-1/32)             | 619                                   | (24-3/8)   | -          |        |      |        |      |
|                                      | Width   | mm(inch)   | 1065                                     | (41-15/16)            | 799                                   | (31-29/64) | -          |        |      |        |      |
|                                      | Depth   | mm(inch)   | 230                                      | (9-1/32)              | 299                                   | (11-49/64) | -          |        |      |        |      |
| Product dimension (Panel)            |   | H×W×D mm, inch                                   | -  |                       | -                                     |            | -          |        |      |        |      |
| Packing dimension                    | Height  | mm(inch)   | 310                                      |                       | 688                                   |            | -          |        |      |        |      |
|                                      | Width   | mm(inch)   | 1140                                     |                       | 931                                   |            | -          |        |      |        |      |
|                                      | Depth   | mm(inch)   | 380                                      |                       | 422                                   |            | -          |        |      |        |      |
| Weight                               | (NET)   | kg(lb)   | 14.5                                     | (32)                  | 40                                    | (88)       | -          |        |      |        |      |
|                                      | (GROSS)   | kg(lb)   | 18                                       | (40)                  | 45                                    | (99)       | -          |        |      |        |      |
|                                      | Panel (NET)   | kg(lb)   | -  |                       | -                                     |            | -          |        |      |        |      |
| Layers limit (actually)              |   | 15 (16)  |  | 5 (6)                 |                                       | -          |            |        |      |        |      |
| Operation condition                  | Cool (DBT)  | 18°C ~ 32°C                                      |  |                       | -10°C ~ 43°C                          |            |            | -      |      |        |      |
|                                      | Heat (DBT)  | 16°C ~ 30°C                                      |  |                       | -15°C ~ 24°C                          |            |            | -      |      |        |      |
| P<br>I<br>P<br>E                     | Pipe diameter mm (inch)                             | (Liquid)ø9.52(3/8) (Gas)ø15.88(5/8)              |  |                       | (Liquid)ø9.52(3/8) (Gas)ø15.88(5/8)   |            |            | -      |      |        |      |
|                                      | Connecting method, Standard length m(ft)            | flared type, 5.0(16.4)                           |  |                       | flared type, 5.0(16.4)                |            |            | -      |      |        |      |
| I<br>N<br>G                          | Pipe length range                                   | m (ft)   |  | 3 ~ 40m (9.8 ~ 131.2) |                                       | -          |            | -      |      |        |      |
|                                      | Indoor unit & Outdoor unit height difference m (ft) | 15m (OD located lower) / 30m (OD located higher) |  |                       | (49.2/98.4)                           |            |            | -      |      |        |      |
|                                      | Add gas amount g/m (oz/ft)                          | 40g  |  |                       | (0.430)                               |            |            | -      |      |        |      |
| G                                    | Pipe length for additional gas                      | m (ft)   |  | 30m (98.4)            |                                       | -          |            | -      |      |        |      |

\*1: In case it is necessary to indicate the air flow volume in (l/s), the value in (m³/min.) shall be multiplied by 16.7 and rounded down the decimal point.

\*2: If the EUROVENT Certified models can be operated under the "extra-low" temperature condition, -7°C dry bulb and -8°C wet-bulb temperatures with rated voltage 230 V shall be used.

\*3: Network Impedance shall be applicable for EUROPE and CHINA models.

\*4: The annual consumption is calculated by multiplying the input power at 230 V (400 V) by an average of 500 hours per year in cooling mode.

\*5: EER and COP classification is at 230 V (400 V) only in accordance with EU directive 2002/31/EC.

\*6: SEER and SCOP classification is at 230V(400V) only in accordance with EN-14825. For heating, SCOP indicates the value of only Average heating season, Other fiche data indicates in an attached sheet.



# Single -Type

## 1-1. Unit Specifications

**PEY2**

### 9. Wall Mounted Type S-71PK1E5A / U-71PEY2E5

| INDOOR   |   | MODEL                             | S-71PK1E5A                                       |            |              | -                                   |            |        | -    |        |      |
|--|---|-----------------------------------|--|------------|--------------|-------------------------------------|------------|--------|------|--------|------|
| PANEL  |   | MODEL                             | -  |            |              | -                                   |            |        | -    |        |      |
| OUTDOOR  |   | MODEL                             | -  |            |              | U-71PEY2E5                          |            |        | -    |        |      |
| Branch pipe  |   | MODEL                             | -  |            |              | -                                   |            |        | -    |        |      |
| Performance test condition                                 |   |                                   | ISO5151 / EN14511 / EN12102 / EN14825            |            |              |                                     |            |        |      |        |      |
| Power supply   |   | Ø, Hz                             | 1ø 50Hz  |            |              | 1ø 50Hz                             |            |        | Min  | Max    |      |
|  |   | V                                 | 220V   | 230V       | 240V         | 220V                                | 230V       | 240V   |      |        |      |
| C<br>O<br>O<br>L<br>I<br>N<br>G                            | Capacity  | kW                                | 7.1  | 7.1        | 7.1          | -                                   | -          | -      | 2.0  | 7.7    |      |
|  |   | BTU/h                             | 24200  | 24200      | 24200        | -                                   | -          | -      | 6800 | 26300  |      |
|  | Current   | A                                 | 0.59   | 0.58       | 0.52         | 12.0                                | 11.4       | 11.0   | -    | -      |      |
|  |   | W                                 | 57   | 57         | 57           | 2.393k                              | 2.393k     | 2.393k | -    | -      |      |
|  | Input power   | TOTAL W                           | -  | -          | -            | 2.450k                              | 2.450k     | 2.450k | 300  | 2.950k |      |
|  |   | Annual consumption                | TOTAL kWh *4                                     | -          | -            | -                                   | -          | 1225   | -    | -      | -    |
|  | EER/EER CLASS                                       | TOTAL (W/W) <sup>5)</sup> ("A"-G) | -  | -          | -            | 2.90                                | 2.90/C     | 2.90   | 6.67 | 2.61   |      |
|  | E <sub>rp</sub> <sup>*6)</sup>                      | Pdesign                           | kW   | -          | -            | -                                   | -          | 7.1    | -    | -      | -    |
|  |   | SEER                              | (W/W)  | -          | -            | -                                   | -          | 5.2    | -    | -      | -    |
|  |   | Annual consumption                | kWh  | -          | -            | -                                   | -          | 478    | -    | -      | -    |
| Class  |   |                                   | -  | -          | -            | -                                   | A          | -      | -    | -      |      |
| Power factor   | %   | -                                 | -  | -          | 91           | 91                                  | 91         | -      | -    |        |      |
| Noise indoor   | dB-A (H/M/L)  | 47/44/40                          |  |            | -            |                                     |            | -      | -    |        |      |
|  | Power Level dB                                      | 64/59/54                          |  |            | -            |                                     |            | -      | -    |        |      |
| Noise outdoor  | dB-A (H/L)  | -                                 |  |            | 49/-         |                                     |            | -      | -    |        |      |
|  | Power Level dB                                      | -                                 |  |            | 69/-         |                                     |            | -      | -    |        |      |
| H<br>E<br>A<br>T<br>I<br>N<br>G                            | Capacity  | kW                                | 7.1  | 7.1        | 7.1          | -                                   | -          | -      | 1.8  | 8.1    |      |
|  |   | BTU/h                             | 24200  | 24200      | 24200        | -                                   | -          | -      | 6100 | 27600  |      |
|  | Current   | A                                 | 0.59   | 0.58       | 0.52         | 8.50                                | 8.15       | 7.80   | -    | -      |      |
|  |   | W                                 | 57   | 57         | 57           | 1.683k                              | 1.683k     | 1.683k | -    | -      |      |
|  | Input power   | TOTAL W                           | -  | -          | -            | 1.740k                              | 1.740k     | 1.740k | 200  | 2.250k |      |
|  |   | COP/COP CLASS                     | TOTAL (W/W) <sup>5)</sup> ("A"-G)                | -          | -            | -                                   | 4.08       | 4.08/A | 4.08 | 9.00   | 3.60 |
|  | E <sub>rp</sub> <sup>*6)</sup>                      | Pdesign at -10°C                  | kW   | -          | -            | -                                   | -          | 6.0    | -    | -      | -    |
|  |   | Tbivalent                         | °C   | -          | -            | -                                   | -          | -8     | -    | -      | -    |
|  |   | SCOP                              | (W/W)  | -          | -            | -                                   | -          | 3.9    | -    | -      | -    |
|  |   | Annual consumption                | kWh  | -          | -            | -                                   | -          | 2154   | -    | -      | -    |
| Class  |   | -                                 | -  | -          | -            | A                                   | -          | -      | -    |        |      |
| Power factor   | %   | -                                 | -  | -          | 90           | 90                                  | 90         | -      | -    |        |      |
| Noise indoor   | dB-A (H/M/L)  | 47/44/40                          |  |            | -            |                                     |            | -      | -    |        |      |
|  | Power Level dB                                      | 64/59/54                          |  |            | -            |                                     |            | -      | -    |        |      |
| Noise outdoor  | dB-A (H/L)  | -                                 |  |            | 49/-         |                                     |            | -      | -    |        |      |
|  | Power Level dB                                      | -                                 |  |            | 69/-         |                                     |            | -      | -    |        |      |
| EXTRA LOW TEMP   Total capacity(kW) / Input power(W) / COP |   | -                                 |  | -          |              | -                                   |            | -      |      |        |      |
| Max Current(A) / Max Input power(W)                        |   | 0.59/57                           | 0.58/57  | 0.52/57    | 16.5/3.27k   | 16.5/3.42k                          | 16.5/3.57k | -      |      |        |      |
| Starting current(A) / Comp output(W)                       |   | -                                 | -  | -          | 12.0/2.0k    | 11.4/2.0k                           | 11.0/2.0k  | -      |      |        |      |
| Network Impedance(ΩMAX.)                                   |   | -                                 |  | -          |              | -                                   |            | -      |      |        |      |
| Fan motor output (Indoor/Outdoor) W                        |   | 47                                |  | -          |              | 60                                  |            | -      |      |        |      |
| Moisture removal volume                                    |   | L/h(Pt/h)                         | 4.2  | (8.8)      |              | -                                   |            | -      |      |        |      |
| External static pressure                                   |   | Pa                                | -  |            | -            |                                     | -          |        |      |        |      |
| Indoor Air flow  | Cooling   | m³/min (ft³/min)                  | 18.0 / 14.5 / 11.5 (636) / (512) / (406)         |            |              | -                                   |            |        | -    | -      |      |
|  | Heating   | m³/min (ft³/min)                  | 18.0 / 14.5 / 11.5 (636) / (512) / (406)         |            |              | -                                   |            |        | -    | -      |      |
| Outdoor Air flow   | Cooling   | m³/min (ft³/min)                  | -  |            |              | 44 (1554)                           |            | -      |      |        |      |
|  | Heating   | m³/min (ft³/min)                  | -  |            |              | 41 (1448)                           |            | -      |      |        |      |
| Refrigerant type / amount g(oz)                            |   | -                                 |  | R410A      |              | 1.95k (68.8)                        |            | -      |      |        |      |
| Product dimension  | Height  | mm(inch)                          | 300  | (11-1/32)  |              | 619 (24-3/8)                        |            | -      |      |        |      |
|  | Width   | mm(inch)                          | 1065   | (41-15/16) |              | 799 (31-29/64)                      |            | -      |      |        |      |
|  | Depth   | mm(inch)                          | 230  | (9-1/32)   |              | 299 (11-49/64)                      |            | -      |      |        |      |
| Product dimension (Panel)                                  |   | HxWxD mm, inch                    | -  |            | -            |                                     | -          |        |      |        |      |
| Packing dimension  | Height  | mm(inch)                          | 310  |            | 688          |                                     | -          |        |      |        |      |
|  | Width   | mm(inch)                          | 1140   |            | 931          |                                     | -          |        |      |        |      |
|  | Depth   | mm(inch)                          | 380  |            | 422          |                                     | -          |        |      |        |      |
| Weight   | (NET)   | kg(lb)                            | 14.5   | (32)       |              | 40 (88)                             |            | -      |      |        |      |
|  | (GROSS)   | kg(lb)                            | 18   | (40)       |              | 45 (99)                             |            | -      |      |        |      |
|  | Panel (NET)   | kg(lb)                            | -  |            | -            |                                     | -          |        |      |        |      |
| Layers limit (actually)                                    |   | 15 (16)                           |  | 5 (6)      |              | -                                   |            | -      |      |        |      |
| Operation condition  | Cool (DBT)  | 18°C ~ 32°C                       |  |            | -10°C ~ 43°C |                                     |            | -      |      |        |      |
|  | Heat (DBT)  | 16°C ~ 30°C                       |  |            | -15°C ~ 24°C |                                     |            | -      |      |        |      |
| P<br>I<br>P<br>I<br>N<br>G                                 | Pipe diameter mm (inch)                             |                                   | (Liquid)ø9.52(3/8) (Gas)ø15.88(5/8)              |            |              | (Liquid)ø9.52(3/8) (Gas)ø15.88(5/8) |            |        | -    |        |      |
|  | Connecting method, Standard length m(ft)            |                                   | flared type, 5.0(16.4)                           |            |              | flared type, 5.0(16.4)              |            |        | -    |        |      |
|  | Pipe length range m (ft)                            |                                   | 3 ~ 40m (9.8 ~ 131.2)                            |            |              | -                                   |            |        | -    |        |      |
|  | Indoor unit & Outdoor unit height difference m (ft) |                                   | 15m (OD located lower) / 30m (OD located higher) |            |              | (49.2/98.4)                         |            |        | -    |        |      |
|  | Add gas amount g/m (oz/ft)                          |                                   | 40g (0.430)                                      |            |              | -                                   |            |        | -    |        |      |
| Pipe length for additional gas m (ft)                      |   | 30m (98.4)                        |  |            | -            |                                     |            | -      |      |        |      |

\*1: In case it is necessary to indicate the air flow volume in (l/s), the value in (m³/min.) shall be multiplied by 16.7 and rounded down the decimal point.  
 \*2: If the EUROVENT Certified models can be operated under the "extra-low" temperature condition, -7°C dry bulb and -8°C wet-bulb temperatures with rated voltage 230 V shall be used.  
 \*3: Network Impedance shall be applicable for EUROPE and CHINA models.  
 \*4: The annual consumption is calculated by multiplying the input power at 230 V (400 V) by an average of 500 hours per year in cooling mode.  
 \*5: EER and COP classification is at 230 V (400 V) only in accordance with EU directive 2002/31/EC.  
 \*6: SEER and SCOP classification is at 230V(400V) only in accordance with EN-14825. For heating, SCOP indicates the value of only Average heating season, Other fiche data indicates in an attached sheet.

# Single -Type

## 1-1. Unit Specifications

**PEY1**

### 9. Wall Mounted Type S-100PK1E5A / U-100PEY1E5

| INDOOR   |   | MODEL                               | S-100PK1E5A                                    |         |                                       | -                                   |           |          | -    |        |      |
|--|---|-------------------------------------|--|---------|---------------------------------------|-------------------------------------|-----------|----------|------|--------|------|
| PANEL  |   | MODEL                               | -  |         |                                       | -                                   |           |          | -    |        |      |
| OUTDOOR  |   | MODEL                               | -  |         |                                       | U-100PEY1E5                         |           |          | -    |        |      |
| Branch pipe  |   | MODEL                               | -  |         |                                       | -                                   |           |          | -    |        |      |
| Performance test condition                                 |   |                                     |  |         | ISO5151 / EN14511 / EN14825 / EN12102 |                                     |           |          |      |        |      |
| Power supply   |   | Ø, Hz                               | 1ø 50Hz  |         |                                       | 1ø 50Hz                             |           |          |      |        |      |
|  |   | V                                   | 220  | 230     | 240                                   | 220                                 | 230       | 240      | Min  | Max    |      |
| C<br>O<br>O<br>L<br>I<br>N<br>G                            | Capacity  | kW                                  | 9.0  | 9.0     | 9.0                                   | -                                   | -         | -        | 2.7  | 9.7    |      |
|  |   | BTU/h                               | 30700  | 30700   | 30700                                 | -                                   | -         | -        | 9200 | 33100  |      |
|  | Current   | A                                   | 0.61   | 0.59    | 0.55                                  | 16.0                                | 15.3      | 14.6     | -    | -      |      |
|  |   | W                                   | 65   | 65      | 65                                    | 3.305k                              | 3.305k    | 3.305k   | -    | -      |      |
|  | Input power   | TOTAL W                             | -  | -       | -                                     | 3.370k                              | 3.370k    | 3.370k   | 530  | 3.800k |      |
|  |   | Annual consumption                  | TOTAL kWh *4                                   | -       | -                                     | -                                   | -         | 1685     | -    | -      | -    |
|  | EER/EER CLASS                                       | TOTAL (W/W) <sup>5/</sup> ("A"~"G") | -  | -       | -                                     | 2.67                                | 2.67 / D  | 2.67     | 5.09 | 2.55   |      |
|  | Erp *6  | Pdesign                             | kW   | -       | -                                     | -                                   | -         | 9.0      | -    | -      | -    |
|  |   | SEER                                | (W/W)  | -       | -                                     | -                                   | -         | 5.8      | -    | -      | -    |
|  |   | Annual consumption                  | kWh  | -       | -                                     | -                                   | -         | 543      | -    | -      | -    |
| Class  |   |                                     | -  | -       | -                                     | -                                   | A+        | -        | -    | -      |      |
| Power factor   | %   | -                                   | -  | -       | 94                                    | 94                                  | 94        | -        | -    |        |      |
| Noise indoor   | dB-A (H/M/L)  | 49/45/41                            |  |         | -                                     |                                     |           | -        | -    |        |      |
|  | Power Level dB                                      | 65/60/55                            |  |         | -                                     |                                     |           | -        | -    |        |      |
| Noise outdoor  | dB-A (H/L)  | -                                   |  |         | 54/-                                  |                                     |           | -        | -    |        |      |
|  | Power Level dB                                      | -                                   |  |         | 70/-                                  |                                     |           | -        | -    |        |      |
| H<br>E<br>A<br>T<br>I<br>N<br>G                            | Capacity  | kW                                  | 9.0  | 9.0     | 9.0                                   | -                                   | -         | -        | 2.1  | 10.5   |      |
|  |   | BTU/h                               | 30700  | 30700   | 30700                                 | -                                   | -         | -        | 7200 | 35800  |      |
|  | Current   | A                                   | 0.62   | 0.60    | 0.56                                  | 11.2                                | 10.8      | 10.4     | -    | -      |      |
|  |   | W                                   | 65   | 65      | 65                                    | 2.365k                              | 2.365k    | 2.365k   | -    | -      |      |
|  | Input power   | TOTAL W                             | -  | -       | -                                     | 2.430k                              | 2.430k    | 2.430k   | 410  | 3.000k |      |
|  |   | COP/COP CLASS                       | TOTAL (W/W) <sup>5/</sup> ("A"~"G")            | -       | -                                     | -                                   | 3.70      | 3.70 / A | 3.70 | 5.12   | 3.50 |
|  | Erp *6  | Pdesign at -10°C                    | kW   | -       | -                                     | -                                   | -         | 9.0      | -    | -      | -    |
|  |   | Tbivalent                           | °C   | -       | -                                     | -                                   | -         | -7       | -    | -      | -    |
|  |   | SCOP                                | (W/W)  | -       | -                                     | -                                   | -         | 3.8      | -    | -      | -    |
|  |   | Annual consumption                  | kWh  | -       | -                                     | -                                   | -         | 3316     | -    | -      | -    |
| Class  |   | -                                   | -  | -       | -                                     | A                                   | -         | -        | -    |        |      |
| Power factor   | %   | -                                   | -  | -       | 96                                    | 95                                  | 95        | -        | -    |        |      |
| Noise indoor   | dB-A (H/M/L)  | 49/45/41                            |  |         | -                                     |                                     |           | -        | -    |        |      |
|  | Power Level dB                                      | 65/60/55                            |  |         | -                                     |                                     |           | -        | -    |        |      |
| Noise outdoor  | dB-A (H/L)  | -                                   |  |         | 54/-                                  |                                     |           | -        | -    |        |      |
|  | Power Level dB                                      | -                                   |  |         | 70/-                                  |                                     |           | -        | -    |        |      |
| EXTRA LOW TEMP   Total capacity(kW) / Input power(W) / COP |   | -                                   |  |         | -                                     |                                     |           | -        |      |        |      |
| Max Current(A) / Max Input power(W)                        |   | 0.62/65                             | 0.60/65  | 0.56/65 | 25/5.170k                             | 25/5.410k                           | 25/5.640k | -        |      |        |      |
| Starting current(A) / Comp output(W)                       |   | -                                   | -  | -       | 16.0/1.7k                             | 15.3/1.7k                           | 14.6/1.7k | -        |      |        |      |
| Network Impedance(ΩMAX.)                                   |   | -                                   |  |         | -                                     |                                     |           | -        |      |        |      |
| Fan motor output (Indoor/Outdoor) W                        |   | 47                                  |  |         | 90                                    |                                     |           | -        |      |        |      |
| Moisture removal volume                                    |   | L/h(Pt/h)                           | 5.4 (11.3)                                     |         |                                       | -                                   |           |          | -    |        |      |
| External static pressure                                   |   | Pa                                  | -  |         |                                       | -                                   |           |          | -    |        |      |
| Indoor Air flow  | Cooling   | m³/min (ft³/min)                    | 19/16.5/13 (671/583/459)                       |         |                                       | -                                   |           |          | -    | -      |      |
|  | Heating   | m³/min (ft³/min)                    | 19/16.5/13 (671/583/459)                       |         |                                       | -                                   |           |          | -    | -      |      |
| Outdoor Air flow   | Cooling   | m³/min (ft³/min)                    | -  |         |                                       | 76 (2684)                           |           |          | -    | -      |      |
|  | Heating   | m³/min (ft³/min)                    | -  |         |                                       | 67 (2366)                           |           |          | -    | -      |      |
| Refrigerant type / amount g(oz)                            |   | -                                   |  |         | R410A                                 | 2.60k                               | (91.7)    | -        |      |        |      |
| Product dimension  | Height  | mm(inch)                            | 300 (11-1/32)                                  |         |                                       | 996 (39-7/32)                       |           |          | -    |        |      |
|  | Width   | mm(inch)                            | 1065 (41-15/16)                                |         |                                       | 940 (37-1/32)                       |           |          | -    |        |      |
|  | Depth   | mm(inch)                            | 230 (9-1/32)                                   |         |                                       | 340 (13-13/32)                      |           |          | -    |        |      |
| Packing dimension  | Height  | mm(inch)                            | 310  |         |                                       | 1136                                |           |          | -    |        |      |
|  | Width   | mm(inch)                            | 1140   |         |                                       | 1055                                |           |          | -    |        |      |
|  | Depth   | mm(inch)                            | 380  |         |                                       | 485                                 |           |          | -    |        |      |
| Weight   | (NET)   | kg(lb)                              | 14.5 (32)                                      |         |                                       | 73 (161)                            |           |          | -    |        |      |
|  | (GROSS)   | kg(lb)                              | 18 (40)  |         |                                       | 81 (179)                            |           |          | -    |        |      |
| Layers limit (actually)                                    |   | 15 (16)                             |  |         | 2 (3)                                 |                                     |           | -        |      |        |      |
| Operation condition  | Cool (DBT)  | 18°C ~ 32°C                         |  |         | -10°C ~ 43°C                          |                                     |           | -        |      |        |      |
|  | Heat (DBT)  | 16°C ~ 30°C                         |  |         | -15°C ~ 24°C                          |                                     |           | -        |      |        |      |
| P<br>I<br>P<br>I<br>N<br>G                                 | Pipe diameter mm (inch)                             |                                     | (Liquid)ø9.52(3/8) (Gas)ø15.88(5/8)            |         |                                       | (Liquid)ø9.52(3/8) (Gas)ø15.88(5/8) |           |          | -    |        |      |
|  | Connecting method, Standard length m(ft)            |                                     | flared type, 5.0(16.4)                         |         |                                       | flared type, 5.0(16.4)              |           |          | -    |        |      |
|  | Pipe length range m (ft)                            |                                     | 5 ~ 50 (16.4 ~ 164.0)                          |         |                                       | -                                   |           |          | -    |        |      |
|  | Indoor unit & Outdoor unit height difference m (ft) |                                     | 15 (OD located lower) / 30 (OD located higher) |         |                                       | (49.2/98.4)                         |           |          | -    |        |      |
|  | Add gas amount g/m (oz/ft)                          |                                     | 50 (0.538)                                     |         |                                       | -                                   |           |          | -    |        |      |
| Pipe length for additional gas m (ft)                      |   | 30 (98.4)                           |  |         | -                                     |                                     |           | -        |      |        |      |

\*1: In case it is necessary to indicate the air flow volume in (l/s), the value in (m³/min.) shall be multiplied by 16.7 and rounded down the decimal point.

\*2: If the EUROVENT Certified models can be operated under the "extra-low" temperature condition, -7°C dry bulb and -8°C wet-bulb temperatures with rated voltage 230 V shall be used.

\*3: Network Impedance shall be applicable for EUROPE and CHINA models.

\*4: The annual consumption is calculated by multiplying the input power at 230 V (400 V) by an average of 500 hours per year in cooling mode.

\*5: EER and COP classification is at 230 V (400 V) only in accordance with EU directive 2002/31/EC.

\*6: SEER and SCOP classification is at 230V(400V) only in accordance with EN-14825. For heating, SCOP indicates the value of only Average heating season, Other fiche data indicates in an attached sheet.

# Simultaneous (Twin) -Type

## 1-1. Unit Specifications

**PEY1**

### 9. Wall Mounted Type S-50PK1E5A×2 / U-100PEY1E8

|   |  |  |                              |             |                                     |                |            |      |        |       |
|---|--|--|------------------------------|-------------|-------------------------------------|----------------|------------|------|--------|-------|
| INDOOR  |  | MODEL  | S-50PK1E5A×2                 |             |                                     | -              |            |      | -      |       |
| PANEL   |  | MODEL  | -                            |             |                                     | -              |            |      | -      |       |
| OUTDOOR   |  | MODEL  | -                            |             |                                     | U-100PEY1E8    |            |      | -      |       |
| Branch pipe   |  | MODEL  | -                            |             |                                     | CZ-P155BK1     |            |      | -      |       |
| Performance test condition  |  | ISO5151 / EN14511 / EN14825 / EN12102          |                              |             |                                     |                |            |      |        |       |
| Power supply  |  | Ø, Hz  | 1ø 50Hz                      |             |                                     | 3ø 50Hz        |            |      |        |       |
|   |  | V  | 220                          | 230         | 240                                 | 380            | 400        | 415  | Min    | Max   |
| Capacity  | kW                                       | 10.0   | 10.0                         | 10.0        | -                                   | -              | -          | -    | 2.7    | 11.0  |
|   | BTU/h                                    | 34100  | 34100                        | 34100       | -                                   | -              | -          | -    | 9200   | 37500 |
| Current   | A  | 0.27×2   | 0.27×2                       | 0.27×2      | 5.75                                | 5.45           | 5.25       | -    | -      | -     |
|   | W  | 26×2   | 27×2                         | 28×2        | 3.515k                              | 3.515k         | 3.510k     | -    | -      | -     |
| Input power   | TOTAL W                                  | -  |                              |             | 3.570k                              | 3.570k         | 3.570k     | 530  | 4.200k | -     |
|   | Annual consumption                       | TOTAL kWh *4                                   | -                            |             |                                     | -              | 1785       | -    | -      | -     |
| EER/EER CLASS   | TOTAL (W/W) <sup>*5</sup> ("A"~"G")      | -  | -                            | -           | 2.80                                | 2.80 / C       | 2.80       | 5.09 | 2.62   | -     |
| Erp *6  | Pdesign                                  | kW   | -                            | -           | -                                   | -              | 10.0       | -    | -      | -     |
|   | SEER                                     | (W/W)  | -                            | -           | -                                   | -              | 5.9        | -    | -      | -     |
|   | Annual consumption                       | kWh  | -                            | -           | -                                   | -              | 593        | -    | -      | -     |
|   | Class                                    |  | -                            | -           | -                                   | -              | A+         | -    | -      | -     |
| Power factor  | %  | -  | -                            | -           | 93                                  | 93             | 93         | -    | -      | -     |
| Noise indoor  | dB-A (H/M/L)                             | 40/36/32                                       |                              |             | -                                   |                |            | -    | -      | -     |
|   | Power Level dB                           | 57/51/46                                       |                              |             | -                                   |                |            | -    | -      | -     |
| Noise outdoor   | dB-A (H/L)                               | -  |                              |             | 54/-                                |                |            | -    | -      | -     |
|   | Power Level dB                           | -  |                              |             | 70/-                                |                |            | -    | -      | -     |
| Capacity  | kW                                       | 10.0   | 10.0                         | 10.0        | -                                   | -              | -          | 2.1  | 12.4   | -     |
|   | BTU/h                                    | 34100  | 34100                        | 34100       | -                                   | -              | -          | 7200 | 42300  | -     |
| Current   | A  | 0.27×2   | 0.27×2                       | 0.27×2      | 4.45                                | 4.20           | 4.05       | -    | -      | -     |
| Input power   | W  | 26×2   | 27×2                         | 28×2        | 2.720k                              | 2.720k         | 2.715k     | -    | -      | -     |
|   | TOTAL W                                  | -  |                              |             | 2.775k                              | 2.775k         | 2.775k     | 410  | 4.000k | -     |
| COP/COP CLASS   | TOTAL (W/W) <sup>*5</sup> ("A"~"G")      | -  | -                            | -           | 3.60                                | 3.60 / A       | 3.60       | 5.12 | 3.10   | -     |
| Erp *6  | Pdesign at -10°C                         | kW   | -                            | -           | -                                   | -              | 10.0       | -    | -      | -     |
|   | Tbivalent                                | °C   | -                            | -           | -                                   | -              | -7         | -    | -      | -     |
|   | SCOP                                     | (W/W)  | -                            | -           | -                                   | -              | 3.8        | -    | -      | -     |
|   | Annual consumption                       | kWh  | -                            | -           | -                                   | -              | 3684       | -    | -      | -     |
| Class   |  | -  | -                            | -           | -                                   | A              | -          | -    | -      |       |
| Power factor  | %  | -  | -                            | -           | 93                                  | 93             | 93         | -    | -      | -     |
| Noise indoor  | dB-A (H/M/L)                             | 40/36/32                                       |                              |             | -                                   |                |            | -    | -      | -     |
|   | Power Level dB                           | 57/51/46                                       |                              |             | -                                   |                |            | -    | -      | -     |
| Noise outdoor   | dB-A (H/L)                               | -  |                              |             | 54/-                                |                |            | -    | -      | -     |
|   | Power Level dB                           | -  |                              |             | 70/-                                |                |            | -    | -      | -     |
| EXTRA LOW TEMP <sup>1</sup> Total capacity(kW) / Input power(W) / COP |  | -  |                              |             |                                     |                |            |      |        |       |
| Max Current(A) / Max Input power(W)                                   |  | 0.27×2/26×2                                    | 0.27×2/27×2                  | 0.27×2/28×2 | 9.0/5.550k                          | 9.0/5.800k     | 9.0/6.050k | -    |        |       |
| Starting current(A) / Comp output(W)                                  |  | -  | -                            | -           | 5.75/1.7k                           | 5.45/1.7k      | 5.25/1.7k  | -    |        |       |
| Network Impedance(ΩMAX.)  |  | -  |                              |             |                                     |                |            |      |        |       |
| Fan motor output (Indoor/Outdoor) W                                   |  | 47×2   |                              |             | 90                                  |                |            | -    |        |       |
| Moisture removal volume   |  | L/h(Pt/h)                                      | 6.0                          | (3.0×2)     | (12.6)                              | -              |            |      | -      |       |
| External static pressure  |  | Pa   | -                            |             |                                     | -              |            |      | -      |       |
| Indoor Air flow   | Cooling                                  | m³/min (ft³/min)                               | [14/12/10.5 (494/424/371)]×2 |             |                                     | -              |            |      | -      | -     |
|   | Heating                                  | m³/min (ft³/min)                               | [14/12/10.5 (494/424/371)]×2 |             |                                     | -              |            |      | -      | -     |
| Outdoor Air flow  | Cooling                                  | m³/min (ft³/min)                               | -                            |             |                                     | 76             | (2684)     | -    |        |       |
|   | Heating                                  | m³/min (ft³/min)                               | -                            |             |                                     | 67             | (2366)     | -    |        |       |
| Refrigerant type / amount g(oz)                                       |  | -  |                              |             | R410A                               | 2.60k          | (91.7)     | -    |        |       |
| Product dimension   | Height                                   | mm(inch)                                       | 300 (11-1/32)                |             |                                     | 996 (39-7/32)  |            |      | -      |       |
|   | Width                                    | mm(inch)                                       | 1065 (41-15/16)              |             |                                     | 940 (37-1/32)  |            |      | -      |       |
|   | Depth                                    | mm(inch)                                       | 230 (9-1/32)                 |             |                                     | 340 (13-13/32) |            |      | -      |       |
| Packing dimension   | Height                                   | mm(inch)                                       | 310                          |             |                                     | 1136           |            |      | -      |       |
|   | Width                                    | mm(inch)                                       | 1140                         |             |                                     | 1055           |            |      | -      |       |
|   | Depth                                    | mm(inch)                                       | 380                          |             |                                     | 485            |            |      | -      |       |
| Weight  | (NET)                                    | kg(lb)   | 13 (29)                      |             |                                     | 73 (161)       |            |      | -      |       |
|   | (GROSS)                                  | kg(lb)   | 17 (37)                      |             |                                     | 81 (179)       |            |      | -      |       |
| Layers limit (actually)   |  | 15 (16)  |                              |             | 2 (3)                               |                |            | -    |        |       |
| Operation condition   | Cool (DBT)                               | 18°C ~ 32°C                                    |                              |             | -10°C ~ 43°C                        |                |            | -    |        |       |
|   | Heat (DBT)                               | 16°C ~ 30°C                                    |                              |             | -15°C ~ 24°C                        |                |            | -    |        |       |
| P I P I N G   | Pipe diameter mm (inch)                  | (Liquid)ø6.35(1/4) (Gas)ø12.7(1/2)             |                              |             | (Liquid)ø9.52(3/8) (Gas)ø15.88(5/8) |                |            | -    |        |       |
|   | Connecting method, Standard length m(ft) | flared type, 5.0(16.4)                         |                              |             | flared type, 5.0(16.4)              |                |            | -    |        |       |
| Pipe length range   |  | m (ft)   |                              |             | 5 ~ 50 (16.4 ~ 164.0)               |                |            | -    |        |       |
| Indoor unit & Outdoor unit height difference m (ft)                   |  | 15 (OD located lower) / 30 (OD located higher) |                              |             | (49.2/98.4)                         |                |            | -    |        |       |
| Add gas amount g/m (oz/ft)  |  | 50   |                              |             | (0.538)                             |                |            | -    |        |       |
| Pipe length for additional gas  |  | m (ft)   |                              |             | 30 (98.4)                           |                |            | -    |        |       |

\*1: In case it is necessary to indicate the air flow volume in (l/s), the value in (m³/min.) shall be multiplied by 16.7 and rounded down the decimal point.  
 \*2: If the EUROVENT Certified models can be operated under the "extra-low" temperature condition, -7°C dry bulb and -8°C wet-bulb temperatures with rated voltage 230 V shall be used.  
 \*3: Network Impedance shall be applicable for EUROPE and CHINA models.  
 \*4: The annual consumption is calculated by multiplying the input power at 230 V (400 V) by an average of 500 hours per year in cooling mode.  
 \*5: EER and COP classification is at 230 V (400 V) only in accordance with EU directive 2002/31/EC.  
 \*6: SEER and SCOP classification is at 230V(400V) only in accordance with EN-14825. For heating, SCOP indicates the value of only Average heating season, Other fiche data indicates in an attached sheet.

# Single -Type

## 1-1. Unit Specifications

**PEY1**

### 9. Wall Mounted Type S-100PK1E5A / U-100PEY1E8

| INDOOR                                |   | MODEL                                     | S-100PK1E5A                                    |         |            | -                                   |            |      | -      |       |
|---------------------------------------|---|---|--|---------|------------|-------------------------------------|------------|------|--------|-------|
| PANEL                                 |   | MODEL                                     | -  |         |            | -                                   |            |      | -      |       |
| OUTDOOR                               |   | MODEL                                     | -  |         |            | U-100PEY1E8                         |            |      | -      |       |
| Branch pipe                           |   | MODEL                                     | -  |         |            | -                                   |            |      | -      |       |
| Performance test condition            |   |   | ISO5151 / EN14511 / EN14825 / EN12102          |         |            |                                     |            |      |        |       |
| Power supply                          |   | Ø, Hz                                     | 1ø 50Hz  |         |            | 3ø 50Hz                             |            |      |        |       |
|                                       |   | V   | 220  | 230     | 240        | 380                                 | 400        | 415  | Min    | Max   |
| Capacity                              | kW  | 9.0                                       | 9.0  | 9.0     | -          | -                                   | -          | -    | 2.7    | 9.7   |
|                                       | BTU/h   | 30700                                     | 30700  | 30700   | -          | -                                   | -          | -    | 9200   | 33100 |
| Current                               | A   | 0.61                                      | 0.59   | 0.55    | 5.40       | 5.15                                | 4.95       | -    | -      | -     |
|                                       | W   | 65  | 65   | 65      | 3.305k     | 3.305k                              | 3.305k     | -    | -      | -     |
| Input power                           | TOTAL W   | -   | -  | -       | 3.370k     | 3.370k                              | 3.370k     | 530  | 3.800k | -     |
|                                       | Annual consumption                                  | TOTAL kWh *4                              | -  | -       | -          | -                                   | 1685       | -    | -      | -     |
| EER/EER CLASS                         | TOTAL (W/W) <sup>5</sup> ("A"~"G")                  | -   | -  | -       | 2.67       | 2.67 / D                            | 2.67       | 5.09 | 2.55   | -     |
| Erp *6                                | Pdesign   | kW  | -  | -       | -          | -                                   | 9.0        | -    | -      | -     |
|                                       | SEER  | (W/W)                                     | -  | -       | -          | -                                   | 5.7        | -    | -      | -     |
|                                       | Annual consumption                                  | kWh                                       | -  | -       | -          | -                                   | 553        | -    | -      | -     |
|                                       | Class   |   | -  | -       | -          | -                                   | A+         | -    | -      | -     |
| Power factor                          | %   | -   | -  | -       | 93         | 93                                  | 93         | -    | -      | -     |
| Noise indoor                          | dB-A (H/M/L)  | 49/45/41                                  |  |         | -          |                                     |            | -    |        | -     |
|                                       | Power Level dB                                      | 65/60/55                                  |  |         | -          |                                     |            | -    |        | -     |
| Noise outdoor                         | dB-A (H/L)  | -   |  |         | 54/-       |                                     |            | -    |        | -     |
|                                       | Power Level dB                                      | -   |  |         | 70/-       |                                     |            | -    |        | -     |
| Capacity                              | kW  | 9.0                                       | 9.0  | 9.0     | -          | -                                   | -          | 2.1  | 10.5   | -     |
|                                       | BTU/h   | 30700                                     | 30700  | 30700   | -          | -                                   | -          | 7200 | 35800  | -     |
| Current                               | A   | 0.62                                      | 0.60   | 0.56    | 3.85       | 3.65                                | 3.55       | -    | -      | -     |
|                                       | W   | 65  | 65   | 65      | 2.365k     | 2.365k                              | 2.365k     | -    | -      | -     |
| Input power                           | TOTAL W   | -   | -  | -       | 2.430k     | 2.430k                              | 2.430k     | 410  | 3.000k | -     |
|                                       | COP/COP CLASS                                       | TOTAL (W/W) <sup>5</sup> ("A"~"G")        | -  | -       | -          | 3.70                                | 3.70 / A   | 3.70 | 5.12   | 3.50  |
| Erp *6                                | Pdesign at -10°C                                    | kW  | -  | -       | -          | -                                   | 9.0        | -    | -      | -     |
|                                       | Tbivalent   | °C  | -  | -       | -          | -                                   | -7         | -    | -      | -     |
|                                       | SCOP  | (W/W)                                     | -  | -       | -          | -                                   | 3.8        | -    | -      | -     |
|                                       | Annual consumption                                  | kWh                                       | -  | -       | -          | -                                   | 3316       | -    | -      | -     |
| Class                                 |   | -   | -  | -       | -          | A                                   | -          | -    | -      | -     |
| Power factor                          | %   | -   | -  | -       | 93         | 94                                  | 93         | -    | -      | -     |
| Noise indoor                          | dB-A (H/M/L)  | 49/45/41                                  |  |         | -          |                                     |            | -    |        | -     |
|                                       | Power Level dB                                      | 65/60/55                                  |  |         | -          |                                     |            | -    |        | -     |
| Noise outdoor                         | dB-A (H/L)  | -   |  |         | 54/-       |                                     |            | -    |        | -     |
|                                       | Power Level dB                                      | -   |  |         | 70/-       |                                     |            | -    |        | -     |
| EXTRA LOW TEMP                        |   | Total capacity(kW) / Input power(W) / COP | -  |         |            |                                     |            |      |        |       |
| Max Current(A) / Max Input power(W)   |   | 0.62/65                                   | 0.60/65  | 0.56/65 | 9.0/5.510k | 9.0/5.800k                          | 9.0/6.020k | -    |        |       |
| Starting current(A) / Comp output(W)  |   | -   | -  | -       | 5.40/1.7k  | 5.15/1.7k                           | 4.95/1.7k  | -    |        |       |
| Network Impedance(ΩMAX.)              |   | -   |  |         | -          |                                     |            | -    |        |       |
| Fan motor output (Indoor/Outdoor) W   |   | 47  |  |         | 90         |                                     |            | -    |        |       |
| Moisture removal volume               |   | L/h(Pt/h)                                 | 5.4  | (11.3)  |            | -                                   |            |      | -      |       |
| External static pressure              |   | Pa  | -  |         |            | -                                   |            |      | -      |       |
| Indoor Air flow                       | Cooling   | m³/min (ft³/min)                          | 19/16.5/13 (671/583/459)                       |         |            | -                                   |            |      | -      |       |
|                                       | Heating   | m³/min (ft³/min)                          | 19/16.5/13 (671/583/459)                       |         |            | -                                   |            |      | -      |       |
| Outdoor Air flow                      | Cooling   | m³/min (ft³/min)                          | -  |         |            | 76                                  | (2684)     |      | -      |       |
|                                       | Heating   | m³/min (ft³/min)                          | -  |         |            | 67                                  | (2366)     |      | -      |       |
| Refrigerant type / amount g(oz)       |   | -   |  |         | R410A      | 2.60k                               | (91.7)     |      | -      |       |
| Product dimension                     | Height  | mm(inch)                                  | 300 (11-1/32)                                  |         |            | 996 (39-7/32)                       |            |      | -      |       |
|                                       | Width   | mm(inch)                                  | 1065 (41-15/16)                                |         |            | 940 (37-1/32)                       |            |      | -      |       |
|                                       | Depth   | mm(inch)                                  | 230 (9-1/32)                                   |         |            | 340 (13-13/32)                      |            |      | -      |       |
| Packing dimension                     | Height  | mm(inch)                                  | 310  |         |            | 1136                                |            |      | -      |       |
|                                       | Width   | mm(inch)                                  | 1140   |         |            | 1055                                |            |      | -      |       |
|                                       | Depth   | mm(inch)                                  | 380  |         |            | 485                                 |            |      | -      |       |
| Weight                                | (NET)   | kg(lb)                                    | 14.5 (32)                                      |         |            | 73 (161)                            |            |      | -      |       |
|                                       | (GROSS)   | kg(lb)                                    | 18 (40)  |         |            | 81 (179)                            |            |      | -      |       |
| Layers limit (actually)               |   |   | 15 (16)  |         |            | 2 (3)                               |            |      | -      |       |
| Operation condition                   |   | Cool (DBT)                                | 18°C ~ 32°C                                    |         |            | -10°C ~ 43°C                        |            |      | -      |       |
|                                       |   | Heat (DBT)                                | 16°C ~ 30°C                                    |         |            | -15°C ~ 24°C                        |            |      | -      |       |
| P I P I N G                           | Pipe diameter mm (inch)                             |   | (Liquid)ø9.52(3/8) (Gas)ø15.88(5/8)            |         |            | (Liquid)ø9.52(3/8) (Gas)ø15.88(5/8) |            |      | -      |       |
|                                       | Connecting method, Standard length m(ft)            |   | flared type, 5.0(16.4)                         |         |            | flared type, 5.0(16.4)              |            |      | -      |       |
|                                       | Pipe length range m (ft)                            |   | 5 ~ 50 (16.4 ~ 164.0)                          |         |            | -                                   |            |      | -      |       |
|                                       | Indoor unit & Outdoor unit height difference m (ft) |   | 15 (OD located lower) / 30 (OD located higher) |         |            | (49.2/98.4)                         |            |      | -      |       |
| Add gas amount g/m (oz/ft)            |   | 50 (0.538)                                |  |         | -          |                                     |            | -    |        |       |
| Pipe length for additional gas m (ft) |   | 30 (98.4)                                 |  |         | -          |                                     |            | -    |        |       |

\*1: In case it is necessary to indicate the air flow volume in (l/s), the value in (m³/min.) shall be multiplied by 16.7 and rounded down the decimal point.

\*2: If the EUROVENT Certified models can be operated under the "extra-low" temperature condition, -7°C dry bulb and -8°C wet-bulb temperatures with rated voltage 230 V shall be used.

\*3: Network Impedance shall be applicable for EUROPE and CHINA models.

\*4: The annual consumption is calculated by multiplying the input power at 230 V (400 V) by an average of 500 hours per year in cooling mode.

\*5: EER and COP classification is at 230 V (400 V) only in accordance with EU directive 2002/31/EC.

\*6: SEER and SCOP classification is at 230V(400V) only in accordance with EN-14825. For heating, SCOP indicates the value of only Average heating season, Other fiche data indicates in an attached sheet.

# Simultaneous (Twin) -Type

## 1-1. Unit Specifications

**PEY1**

### 10. Low Silhouette Ducted Type S-50PF1E5A×2 / U-100PEY1E5

| INDOOR   |  | MODEL  | S-50PF1E5A×2                       |              |                                     | -              |             |          | -    |        |      |
|--|--|--|------------------------------------|--------------|-------------------------------------|----------------|-------------|----------|------|--------|------|
| PANEL  |  | MODEL  | -                                  |              |                                     | -              |             |          | -    |        |      |
| OUTDOOR  |  | MODEL  | -                                  |              |                                     | U-100PEY1E5    |             |          | -    |        |      |
| Branch pipe  |  | MODEL  | -                                  |              |                                     | CZ-P155BK1     |             |          | -    |        |      |
| Performance test condition                               |  | ISO13253 / EN14511 / EN14825 / EN12102         |                                    |              |                                     |                |             |          |      |        |      |
| Power supply   |  | Ø, Hz  | 1ø 50Hz                            |              |                                     | 1ø 50Hz        |             |          |      |        |      |
|  |  | V  | 220                                | 230          | 240                                 | 220            | 230         | 240      | Min  | Max    |      |
| C<br>O<br>O<br>L<br>I<br>N<br>G                          | Capacity                                 | kW   | 10.0                               | 10.0         | 10.0                                | -              | -           | -        | 2.7  | 11.5   |      |
|  |  | BTU/h  | 34100                              | 34100        | 34100                               | -              | -           | -        | 9200 | 39200  |      |
|  | Current                                  | A  | 0.77×2                             | 0.74×2       | 0.71×2                              | 15.1           | 14.5        | 13.9     | -    | -      |      |
|  |  | W  | 100×2                              | 100×2        | 100×2                               | 3.125k         | 3.125k      | 3.125k   | -    | -      |      |
|  | Input power                              | TOTAL W  | -                                  |              |                                     | 3.325k         | 3.325k      | 3.325k   | 530  | 4.200k |      |
|  |  | Annual consumption                             | TOTAL kWh *4                       | -            |                                     |                | -           | 1663     | -    | -      | -    |
|  | EER/EER CLASS                            | TOTAL (W/W) <sup>5</sup> ("A"~"G")             | -                                  | -            | -                                   | 3.01           | 3.01 / B    | 3.01     | 5.09 | 2.74   |      |
|  | E <sub>rp</sub> <sup>6</sup>             | Pdesign  | kW                                 | -            | -                                   | -              | -           | 10.0     | -    | -      | -    |
|  |  | SEER   | (W/W)                              | -            | -                                   | -              | -           | 5.4      | -    | -      | -    |
|  |  | Annual consumption                             | kWh                                | -            | -                                   | -              | -           | 648      | -    | -      | -    |
| Class  |  |  | -                                  | -            | -                                   | -              | A           | -        | -    | -      |      |
| Power factor   | %  | -  | -                                  | -            | 94                                  | 94             | 94          | -        | -    |        |      |
| Noise indoor   | dB-A (H/M/L)                             | 34/30/26                                       |                                    |              | -                                   |                |             | -        | -    |        |      |
|  | Power Level dB                           | 56/52/48                                       |                                    |              | -                                   |                |             | -        | -    |        |      |
| Noise outdoor  | dB-A (H/L)                               | -  |                                    |              | 54/-                                |                |             | -        | -    |        |      |
|  | Power Level dB                           | -  |                                    |              | 70/-                                |                |             | -        | -    |        |      |
| H<br>E<br>A<br>T<br>I<br>N<br>G                          | Capacity                                 | kW   | 10.0                               | 10.0         | 10.0                                | -              | -           | -        | 2.1  | 13.8   |      |
|  |  | BTU/h  | 34100                              | 34100        | 34100                               | -              | -           | -        | 7200 | 47100  |      |
|  | Current                                  | A  | 0.77×2                             | 0.74×2       | 0.71×2                              | 11.8           | 11.2        | 10.7     | -    | -      |      |
|  |  | W  | 100×2                              | 100×2        | 100×2                               | 2.430k         | 2.430k      | 2.430k   | -    | -      |      |
|  | Input power                              | TOTAL W  | -                                  |              |                                     | 2.630k         | 2.630k      | 2.630k   | 410  | 4.000k |      |
|  |  | COP/COP CLASS                                  | TOTAL (W/W) <sup>5</sup> ("A"~"G") | -            | -                                   | -              | 3.80        | 3.80 / A | 3.80 | 5.12   | 3.45 |
|  | E <sub>rp</sub> <sup>6</sup>             | Pdesign at -10°C                               | kW                                 | -            | -                                   | -              | -           | 9.5      | -    | -      | -    |
|  |  | Tbivalent                                      | °C                                 | -            | -                                   | -              | -           | -8       | -    | -      | -    |
|  |  | SCOP   | (W/W)                              | -            | -                                   | -              | -           | 3.8      | -    | -      | -    |
|  |  | Annual consumption                             | kWh                                | -            | -                                   | -              | -           | 3500     | -    | -      | -    |
| Class  |  | -  | -                                  | -            | -                                   | A              | -           | -        | -    |        |      |
| Power factor   | %  | -  | -                                  | -            | 94                                  | 94             | 95          | -        | -    |        |      |
| Noise indoor   | dB-A (H/M/L)                             | 34/30/26                                       |                                    |              | -                                   |                |             | -        | -    |        |      |
|  | Power Level dB                           | 56/52/48                                       |                                    |              | -                                   |                |             | -        | -    |        |      |
| Noise outdoor  | dB-A (H/L)                               | -  |                                    |              | 54/-                                |                |             | -        | -    |        |      |
|  | Power Level dB                           | -  |                                    |              | 70/-                                |                |             | -        | -    |        |      |
| EXTRA LOW TEMP Total capacity(kW) / Input power(W) / COP |  | -  |                                    |              |                                     |                |             |          |      |        |      |
| Max Current(A) / Max Input power(W)                      |  | 1.00×2/125×2                                   | 0.96×2/125×2                       | 0.92×2/125×2 | 25.0/5.300k                         | 25.0/5.500k    | 25.0/5.700k | -        |      |        |      |
| Starting current(A) / Comp output(W)                     |  | -  | -                                  | -            | 15.1/1.7k                           | 14.5/1.7k      | 13.9/1.7k   | -        |      |        |      |
| Network Impedance(ΩMAX.)                                 |  | -  |                                    |              |                                     |                |             |          |      |        |      |
| Fan motor output (Indoor/Outdoor) W                      |  | 120×2  |                                    |              | 90                                  |                |             | -        |      |        |      |
| Moisture removal volume                                  |  | L/h(Pt/h)                                      | 6.0                                | (3.0×2)      | (12.6)                              | -              |             |          | -    |        |      |
| External static pressure                                 |  | Pa   | 70 (MIN10 - MAX150)                |              |                                     | -              |             |          | -    |        |      |
| Indoor Air flow  | Cooling                                  | m³/min (ft³/min)                               | [16/15/12 (565/530/424)]×2         |              |                                     | -              |             |          | -    |        |      |
|  | Heating                                  | m³/min (ft³/min)                               | [16/15/12 (565/530/424)]×2         |              |                                     | -              |             |          | -    |        |      |
| Outdoor Air flow   | Cooling                                  | m³/min (ft³/min)                               | -                                  |              |                                     | 76             | (2684)      | -        |      |        |      |
|  | Heating                                  | m³/min (ft³/min)                               | -                                  |              |                                     | 67             | (2366)      | -        |      |        |      |
| Refrigerant type / amount g(oz)                          |  | -  |                                    |              | R410A                               | 2.60k          | (91.7)      | -        |      |        |      |
| Product dimension  | Height                                   | mm(inch)                                       | 290 (11-13/32)                     |              |                                     | 996 (39-7/32)  |             |          | -    |        |      |
|  | Width                                    | mm(inch)                                       | 800 (31-1/2)                       |              |                                     | 940 (37-1/32)  |             |          | -    |        |      |
|  | Depth                                    | mm(inch)                                       | 700 (27-9/16)                      |              |                                     | 340 (13-13/32) |             |          | -    |        |      |
| Packing dimension  | Height                                   | mm(inch)                                       | 355                                |              |                                     | 1136           |             |          | -    |        |      |
|  | Width                                    | mm(inch)                                       | 1014                               |              |                                     | 1055           |             |          | -    |        |      |
|  | Depth                                    | mm(inch)                                       | 850                                |              |                                     | 485            |             |          | -    |        |      |
| Weight   | (NET)                                    | kg(lb)   | 28 (62)                            |              |                                     | 73 (161)       |             |          | -    |        |      |
|  | (GROSS)                                  | kg(lb)   | 35 (78)                            |              |                                     | 81 (179)       |             |          | -    |        |      |
| Layers limit (actually)                                  |  | 9 (10)   |                                    |              | 2 (3)                               |                |             | -        |      |        |      |
| Operation condition                                      | Cool (DBT)                               | 18°C ~ 32°C                                    |                                    |              | -10°C ~ 43°C                        |                |             | -        |      |        |      |
|  | Heat (DBT)                               | 16°C ~ 30°C                                    |                                    |              | -15°C ~ 24°C                        |                |             | -        |      |        |      |
| P<br>I<br>P<br>I<br>N<br>G                               | Pipe diameter mm (inch)                  | (Liquid)ø6.35(1/4) (Gas)ø12.7(1/2)             |                                    |              | (Liquid)ø9.52(3/8) (Gas)ø15.88(5/8) |                |             | -        |      |        |      |
|  | Connecting method, Standard length m(ft) | flared type, 5.0(16.4)                         |                                    |              | flared type, 5.0(16.4)              |                |             | -        |      |        |      |
| Pipe length range  |  | m (ft)   |                                    |              | 5 ~ 50 (16.4 ~ 164.0)               |                |             | -        |      |        |      |
| Indoor unit & Outdoor unit height difference m (ft)      |  | 15 (OD located lower) / 30 (OD located higher) |                                    |              | (49.2/98.4)                         |                |             | -        |      |        |      |
| Add gas amount g/m (oz/ft)                               |  | 50   |                                    |              | (0.538)                             |                |             | -        |      |        |      |
| Pipe length for additional gas                           |  | m (ft)   |                                    |              | 30 (98.4)                           |                |             | -        |      |        |      |

\*1: In case it is necessary to indicate the air flow volume in (l/s), the value in (m³/min.) shall be multiplied by 16.7 and rounded down the decimal point.  
 \*2: If the EUROVENT Certified models can be operated under the "extra-low" temperature condition, -7°C dry bulb and -8°C wet-bulb temperatures with rated voltage 230 V shall be used.  
 \*3: Network Impedance shall be applicable for EUROPE and CHINA models.  
 \*4: The annual consumption is calculated by multiplying the input power at 230 V (400 V) by an average of 500 hours per year in cooling mode.  
 \*5: EER and COP classification is at 230 V (400 V) only in accordance with EU directive 2002/31/EC.  
 \*6: SEER and SCOP classification is at 230V(400V) only in accordance with EN-14825. For heating, SCOP indicates the value of only Average heating season, Other fiche data indicates in an attached sheet.

# Single-Type

## 1-1. Unit Specifications

**PEY2**

### 10. Low Silhouette Ducted Type S-60PF1E5A / U-60PEY2E5

| INDOOR                               |   | MODEL  | S-60PF1E5A                               |            |  |            |            |        |      |        |      |
|--------------------------------------|---|--|--|------------|--|------------|------------|--------|------|--------|------|
| PANEL                                |   | MODEL  |  |            |  |            |            |        |      |        |      |
| OUTDOOR                              |   | MODEL  |  |            |  | U-60PEY2E5 |            |        |      |        |      |
| Branch pipe                          |   | MODEL  |  |            |  |            |            |        |      |        |      |
| Performance test condition           |   |  |  |            | ISO13253 / EN14511 / EN12102 / EN14825 |            |            |        |      |        |      |
| Power supply                         |   | Ø, Hz  | 1ø 50Hz                                  |            |  | 1ø 50Hz    |            |        | Min  | Max    |      |
|                                      |   | V  | 220V                                     | 230V       | 240V                                   | 220V       | 230V       | 240V   |      |        |      |
| C<br>O<br>O<br>L<br>I<br>N<br>G      | Capacity  | kW   | 6.0                                      | 6.0        | 6.0                                    | -          | -          | -      | 2.0  | 7.1    |      |
|                                      |   | BTU/h  | 20500                                    | 20500      | 20500                                  | -          | -          | -      | 6800 | 24200  |      |
|                                      | Current   | A  | 0.91                                     | 0.89       | 0.87                                   | 8.40       | 8.10       | 7.75   | -    | -      |      |
|                                      |   | W  | 120                                      | 120        | 120                                    | 1.670k     | 1.670k     | 1.670k | -    | -      |      |
|                                      | Input power   | TOTAL W  |  |            |  | 1.790k     | 1.790k     | 1.790k | 335  | 2.490k |      |
|                                      |   | Annual consumption                               | TOTAL kWh *4                             |            |  |            | -          | 895    | -    | -      | -    |
|                                      | EER/EER CLASS                                       | TOTAL (W/W) <sup>5</sup> ("A"~"G")               | -  | -          | -                                      | 3.35       | 3.35/A     | 3.35   | 5.97 | 2.85   |      |
|                                      | Erp <sup>6</sup>                                    | Pdesign  | kW                                       | -          | -                                      | -          | -          | 6.0    | -    | -      | -    |
|                                      |   | SEER   | (W/W)                                    | -          | -                                      | -          | -          | 5.5    | -    | -      | -    |
|                                      |   | Annual consumption                               | kWh                                      | -          | -                                      | -          | -          | 382    | -    | -      | -    |
| Class                                |   |  | -  | -          | -                                      | -          | A          | -      | -    | -      |      |
| Power factor                         | %   | -  | -  | -          | 90                                     | 90         | 90         | -      | -    |        |      |
| Noise indoor                         | dB-A (H/M/L)  | 35/32/26   |  |            |  |            |            | -      | -    |        |      |
|                                      | Power Level dB                                      | 57/54/48   |  |            |  |            |            | -      | -    |        |      |
| Noise outdoor                        | dB-A (H/L)  |  |  |            | 46/-                                   |            |            | -      | -    |        |      |
|                                      | Power Level dB                                      |  |  |            | 65/-                                   |            |            | -      | -    |        |      |
| H<br>E<br>A<br>T<br>I<br>N<br>G      | Capacity  | kW   | 6.0                                      | 6.0        | 6.0                                    | -          | -          | -      | 1.8  | 7.0    |      |
|                                      |   | BTU/h  | 20500                                    | 20500      | 20500                                  | -          | -          | -      | 6100 | 23900  |      |
|                                      | Current   | A  | 0.87                                     | 0.89       | 0.87                                   | 6.30       | 6.05       | 5.80   | -    | -      |      |
|                                      |   | W  | 120                                      | 120        | 120                                    | 1.250k     | 1.250k     | 1.250k | -    | -      |      |
|                                      | Input power   | TOTAL W  |  |            |  | 1.370k     | 1.370k     | 1.370k | 285  | 1.700k |      |
|                                      |   | COP/COP CLASS                                    | TOTAL (W/W) <sup>5</sup> ("A"~"G")       | -          | -                                      | -          | 4.38       | 4.38/A | 4.38 | 6.32   | 4.12 |
|                                      | Erp <sup>6</sup>                                    | Pdesign at -10°C                                 | kW                                       | -          | -                                      | -          | -          | 6.0    | -    | -      | -    |
|                                      |   | Tbivalent  | °C                                       | -          | -                                      | -          | -          | -8     | -    | -      | -    |
|                                      |   | SCOP   | (W/W)                                    | -          | -                                      | -          | -          | 4.0    | -    | -      | -    |
|                                      |   | Annual consumption                               | kWh                                      | -          | -                                      | -          | -          | 2100   | -    | -      | -    |
| Class                                |   | -  | -  | -          | -                                      | A+         | -          | -      | -    |        |      |
| Power factor                         | %   | -  | -  | -          | 90                                     | 90         | 90         | -      | -    |        |      |
| Noise indoor                         | dB-A (H/M/L)  | 35/32/26   |  |            |  |            |            | -      | -    |        |      |
|                                      | Power Level dB                                      | 57/54/48   |  |            |  |            |            | -      | -    |        |      |
| Noise outdoor                        | dB-A (H/L)  |  |  |            | 48/-                                   |            |            | -      | -    |        |      |
|                                      | Power Level dB                                      |  |  |            | 68/-                                   |            |            | -      | -    |        |      |
| EXTRA LOW TEMP                       |   | Total capacity(kW) / Input power(W) / COP        |  |            |  |            |            |        |      |        |      |
| Max Current(A) / Max Input power(W)  |   | 1.26/160   | 1.20/160                                 | 1.15/160   | 16.5/3.27k                             | 16.5/3.42k | 16.5/3.57k |        |      |        |      |
| Starting current(A) / Comp output(W) |   | -  | -  | -          | 8.40/1.7k                              | 8.10/1.7k  | 7.75/1.7k  |        |      |        |      |
| Network Impedance(ΩMAX.)             |   |  |  |            |  |            |            |        |      |        |      |
| Fan motor output (Indoor/Outdoor) W  |   |  |  | 120        |  |            | 60         |        |      |        |      |
| Moisture removal volume              |   | L/h(Pt/h)  | 3.4                                      | (7.1)      |  |            |            |        |      |        |      |
| External static pressure             |   | Pa   | 70 (MIN10 - MAX150)                      |            |  |            |            |        |      |        |      |
| Indoor Air flow                      | Cooling   | m³/min (ft³/min)                                 | 21.0 / 19.0 / 15.0 (742) / (671) / (530) |            |  |            |            |        |      |        |      |
|                                      | Heating   | m³/min (ft³/min)                                 | 21.0 / 19.0 / 15.0 (742) / (671) / (530) |            |  |            |            |        |      |        |      |
| Outdoor Air flow                     | Cooling   | m³/min (ft³/min)                                 |  |            |  | 38         | (1342)     | -      | -    |        |      |
|                                      | Heating   | m³/min (ft³/min)                                 |  |            |  | 41         | (1448)     | -      | -    |        |      |
| Refrigerant type / amount g(oz)      |   |  |  |            | R410A                                  | 1.95k      | (68.8)     |        |      |        |      |
| Product dimension                    | Height  | mm(inch)   | 290                                      | (11-13/32) | 619                                    | (24-3/8)   |            |        |      |        |      |
|                                      | Width   | mm(inch)   | 1000                                     | (39-3/8)   | 799                                    | (31-29/64) |            |        |      |        |      |
|                                      | Depth   | mm(inch)   | 700                                      | (27-9/16)  | 299                                    | (11-49/64) |            |        |      |        |      |
| Product dimension (Panel)            |   | H×W×D mm, inch                                   |  |            |  |            |            |        |      |        |      |
| Packing dimension                    | Height  | mm(inch)   | 355                                      | (13-31/32) | 688                                    |            |            |        |      |        |      |
|                                      | Width   | mm(inch)   | 1214                                     | (47-13/16) | 931                                    |            |            |        |      |        |      |
|                                      | Depth   | mm(inch)   | 850                                      | (33-15/32) | 422                                    |            |            |        |      |        |      |
| Weight                               | (NET)   | kg(lb)   | 33                                       | (73)       | 40                                     | (88)       |            |        |      |        |      |
|                                      | (GROSS)   | kg(lb)   | 41                                       | (91)       | 45                                     | (99)       |            |        |      |        |      |
|                                      | Panel (NET)   | kg(lb)   |  |            |  |            |            |        |      |        |      |
| Layers limit (actually)              |   |  |  | 9 (10)     |  |            | 5 (6)      |        |      |        |      |
| Operation condition                  | Cool (DBT)  | 18°C ~ 32°C                                      |  |            | -10°C ~ 43°C                           |            |            |        |      |        |      |
|                                      | Heat (DBT)  | 16°C ~ 30°C                                      |  |            | -15°C ~ 24°C                           |            |            |        |      |        |      |
| P<br>I<br>P<br>E                     | Pipe diameter mm (inch)                             | (Liquid)ø9.52(3/8) (Gas)ø15.88(5/8)              |  |            | (Liquid)ø9.52(3/8) (Gas)ø15.88(5/8)    |            |            |        |      |        |      |
|                                      | Connecting method, Standard length m(ft)            | flared type, 5.0(16.4)                           |  |            | flared type, 5.0(16.4)                 |            |            |        |      |        |      |
| I<br>N<br>G                          | Pipe length range m (ft)                            | 3 ~ 40m (9.8 ~ 131.2)                            |  |            |  |            |            |        |      |        |      |
|                                      | Indoor unit & Outdoor unit height difference m (ft) | 15m (OD located lower) / 30m (OD located higher) |  |            | (49.2/98.4)                            |            |            |        |      |        |      |
| N<br>G                               | Add gas amount g/m (oz/ft)                          | 40g (0.430)                                      |  |            |  |            |            |        |      |        |      |
|                                      | Pipe length for additional gas m (ft)               | 30m (98.4)                                       |  |            |  |            |            |        |      |        |      |

\*1: In case it is necessary to indicate the air flow volume in (l/s), the value in (m³/min.) shall be multiplied by 16.7 and rounded down the decimal point.

\*2: If the EUROVENT Certified models can be operated under the "extra-low" temperature condition, -7°C dry bulb and -8°C wet-bulb temperatures with rated voltage 230 V shall be used.

\*3: Network Impedance shall be applicable for EUROPE and CHINA models.

\*4: The annual consumption is calculated by multiplying the input power at 230V (400V) by an average of 500 hours per year in cooling mode.

\*5: EER and COP classification is at 230V (400V) only in accordance with EU directive 2002/31/EC.

\*6: SEER and SCOP classification is at 230V (400V) only in accordance with EN-14825. For heating, SCOP indicates the value of only Average heating season, Other fiche data indicates in an attached sheet.

# Simultaneous (Twin) -Type

## 1-1. Unit Specifications

**PEY1**

### 10. Low Silhouette Ducted Type S-60PF1E5A×2 / U-125PEY1E5

|  |   |                  |  |              |  |                                     |             |       |        |       |
|--|---|------------------|--|--------------|--|-------------------------------------|-------------|-------|--------|-------|
| INDOOR   |   | MODEL            | S-60PF1E5A×2                                   |              |  | -                                   |             |       | -      |       |
| PANEL  |   | MODEL            | -  |              |  | -                                   |             |       | -      |       |
| OUTDOOR  |   | MODEL            | -  |              |  | U-125PEY1E5                         |             |       | -      |       |
| Branch pipe  |   | MODEL            | -  |              |  | CZ-P155BK1                          |             |       | -      |       |
| Performance test condition                                 |   |                  |  |              | ISO13253 / EN14511 / EN12102 / EN14825 |                                     |             |       |        |       |
| Power supply   |   | Ø, Hz            | 1ø 50Hz  |              |  | 1ø 50Hz                             |             |       |        |       |
|  |   | V                | 220  | 230          | 240                                    | 220                                 | 230         | 240   | Min    | Max   |
| Capacity   | kW  | 12.5             | 12.5   | 12.5         | -                                      | -                                   | -           | -     | 3.8    | 13.5  |
|  | BTU/h   | 42700            | 42700  | 42700        | -                                      | -                                   | -           | -     | 13000  | 46100 |
| Current  | A   | 0.91×2           | 0.89×2   | 0.87×2       | 18.8                                   | 18.0                                | 17.2        | -     | -      | -     |
| Input power  | W   | 120×2            | 120×2  | 120×2        | 3.885k                                 | 3.885k                              | 3.885k      | -     | -      | -     |
|  | TOTAL W   | -                |  |              | 4.125k                                 | 4.125k                              | 4.125k      | 900   | 5.000k | -     |
| Annual consumption   | TOTAL kWh *4  | -                |  |              | -                                      | 2063                                | -           | -     | -      | -     |
| EER/EER CLASS  | TOTAL (W/W) *5 ("A"~"G")                            | -                | -  | -            | 3.03                                   | 3.03 / B                            | 3.03        | 4.22  | 2.70   | -     |
| Erp *6   | Pdesign   | kW               | -  | -            | -                                      | -                                   | 12.5        | -     | -      | -     |
|  | η s,c   | %                | -  | -            | -                                      | -                                   | 213.5       | -     | -      | -     |
|  | Annual consumption                                  | kWh              | -  | -            | -                                      | -                                   | -           | -     | -      | -     |
|  | Class   |                  | -  | -            | -                                      | -                                   | -           | -     | -      | -     |
| Power factor   | %   | -                | -  | -            | 94                                     | 94                                  | 94          | -     | -      | -     |
| Noise indoor   | dB-A (H/M/L)  | 35/32/26         |  |              | -                                      |                                     |             | -     | -      | -     |
|  | Power Level dB                                      | 57/54/48         |  |              | -                                      |                                     |             | -     | -      | -     |
| Noise outdoor  | dB-A (H/L)  | -                |  |              | 56/-                                   |                                     |             | -     | -      | -     |
|  | Power Level dB                                      | -                |  |              | 73/-                                   |                                     |             | -     | -      | -     |
| Capacity   | kW  | 12.5             | 12.5   | 12.5         | -                                      | -                                   | -           | 3.4   | 15.0   | -     |
|  | BTU/h   | 42700            | 42700  | 42700        | -                                      | -                                   | -           | 11600 | 51200  | -     |
| Current  | A   | 0.91×2           | 0.89×2   | 0.87×2       | 14.6                                   | 14.0                                | 13.4        | -     | -      | -     |
| Input power  | W   | 120×2            | 120×2  | 120×2        | 3.060k                                 | 3.060k                              | 3.060k      | -     | -      | -     |
|  | TOTAL W   | -                |  |              | 3.300k                                 | 3.300k                              | 3.300k      | 730   | 4.400k | -     |
| COP/COP CLASS  | TOTAL (W/W) *5 ("A"~"G")                            | -                | -  | -            | 3.79                                   | 3.79 / A                            | 3.79        | 4.66  | 3.41   | -     |
| Erp *6   | Pdesign at -10°C                                    | kW               | -  | -            | -                                      | -                                   | 12.5        | -     | -      | -     |
|  | Tbivalent   | °C               | -  | -            | -                                      | -                                   | -7          | -     | -      | -     |
|  | η s,h   | %                | -  | -            | -                                      | -                                   | 141.6       | -     | -      | -     |
|  | Annual consumption                                  | kWh              | -  | -            | -                                      | -                                   | -           | -     | -      | -     |
| Class  |   | -                | -  | -            | -                                      | -                                   | -           | -     | -      | -     |
| Power factor   | %   | -                | -  | -            | 95                                     | 95                                  | 95          | -     | -      | -     |
| Noise indoor   | dB-A (H/M/L)  | 35/32/26         |  |              | -                                      |                                     |             | -     | -      | -     |
|  | Power Level dB                                      | 57/54/48         |  |              | -                                      |                                     |             | -     | -      | -     |
| Noise outdoor  | dB-A (H/L)  | -                |  |              | 56/-                                   |                                     |             | -     | -      | -     |
|  | Power Level dB                                      | -                |  |              | 73/-                                   |                                     |             | -     | -      | -     |
| EXTRA LOW TEMP   Total capacity(kW) / Input power(W) / COP |   |                  |  |              | -                                      |                                     |             |       |        |       |
| Max Current(A) / Max Input power(W)                        |   | 1.26×2/160×2     | 1.20×2/160×2                                   | 1.15×2/160×2 | 29.0/6.000k                            | 29.0/6.300k                         | 29.0/6.600k | -     |        |       |
| Starting current(A) / Comp output(W)                       |   | -                | -  | -            | 18.8/3.0k                              | 18.0/3.0k                           | 17.2/3.0k   | -     |        |       |
| Network Impedance(ΩMAX.)                                   |   | -                |  |              | -                                      |                                     |             | -     |        |       |
| Fan motor output (Indoor/Outdoor) W                        |   | 120×2            |  |              | 90                                     |                                     |             | -     |        |       |
| Moisture removal volume                                    |   | L/h(Pt/h)        | 7.9  | (3.95×2)     | (16.6)                                 | -                                   |             |       | -      |       |
| External static pressure                                   |   | Pa               | 70 (MIN10 - MAX150)                            |              |  | -                                   |             |       | -      |       |
| Indoor Air flow  | Cooling   | m³/min (ft³/min) | [21/19/15 (742/671/530)]×2                     |              |  | -                                   |             |       | -      |       |
|  | Heating   | m³/min (ft³/min) | [21/19/15 (742/671/530)]×2                     |              |  | -                                   |             |       | -      |       |
| Outdoor Air flow   | Cooling   | m³/min (ft³/min) | -  |              |  | 80                                  | (2825)      | -     |        |       |
|  | Heating   | m³/min (ft³/min) | -  |              |  | 73                                  | (2578)      | -     |        |       |
| Refrigerant type / amount g(oz)                            |   | -                |  |              | R410A                                  | 3.20k                               | (112.9)     | -     |        |       |
| Product dimension  | Height  | mm(inch)         | 290 (11-13/32)                                 |              |  | 996 (39-7/32)                       |             |       | -      |       |
|  | Width   | mm(inch)         | 1000 (39-3/8)                                  |              |  | 940 (37-1/32)                       |             |       | -      |       |
|  | Depth   | mm(inch)         | 700 (27-9/16)                                  |              |  | 340 (13-13/32)                      |             |       | -      |       |
| Packing dimension  | Height  | mm(inch)         | 355  |              |  | 1136                                |             |       | -      |       |
|  | Width   | mm(inch)         | 1214   |              |  | 1055                                |             |       | -      |       |
|  | Depth   | mm(inch)         | 850  |              |  | 485                                 |             |       | -      |       |
| Weight   | (NET)   | kg(lb)           | 33 (73)  |              |  | 85 (187)                            |             |       | -      |       |
|  | (GROSS)   | kg(lb)           | 41 (91)  |              |  | 93 (205)                            |             |       | -      |       |
| Layers limit (actually)                                    |   |                  | 9 (10)   |              |  | 2 (3)                               |             |       | -      |       |
| Operation condition  | Cool (DBT)  |                  | 18°C ~ 32°C                                    |              |  | -10°C ~ 43°C                        |             |       | -      |       |
|  | Heat (DBT)  |                  | 16°C ~ 30°C                                    |              |  | -15°C ~ 24°C                        |             |       | -      |       |
| P  | Pipe diameter mm (inch)                             |                  | (Liquid)ø9.52(3/8) (Gas)ø15.88(5/8)            |              |  | (Liquid)ø9.52(3/8) (Gas)ø15.88(5/8) |             |       | -      |       |
| I  | Connecting method, Standard length m(ft)            |                  | flared type, 5.0(16.4)                         |              |  | flared type, 5.0(16.4)              |             |       | -      |       |
| P  | Pipe length range m (ft)                            |                  | 5 ~ 50 (16.4 ~ 164.0)                          |              |  |                                     |             |       | -      |       |
| I  | Indoor unit & Outdoor unit height difference m (ft) |                  | 15 (OD located lower) / 30 (OD located higher) |              |  | (49.2/98.4)                         |             |       | -      |       |
| N  | Add gas amount g/m (oz/ft)                          |                  | 50 (0.538)                                     |              |  |                                     |             |       | -      |       |
| G  | Pipe length for additional gas m (ft)               |                  | 30 (98.4)                                      |              |  |                                     |             |       | -      |       |

\*1: In case it is necessary to indicate the air flow volume in (l/s), the value in (m³/min.) shall be multiplied by 16.7 and rounded down the decimal point.  
 \*2: If the EUROVENT Certified models can be operated under the "extra-low" temperature condition, -7°C dry bulb and -8°C wet-bulb temperatures with rated voltage 230 V shall be used.  
 \*3: Network Impedance shall be applicable for EUROPE and CHINA models.  
 \*4: The annual consumption is calculated by multiplying the input power at 230 V (400 V) by an average of 500 hours per year in cooling mode.  
 \*5: EER and COP classification is at 230 V (400 V) only in accordance with EU directive 2002/31/EC.  
 \*6: SEER and SCOP classification is at 230V(400V) only in accordance with EN-14825. For heating, SCOP indicates the value of only Average heating season.

# Single -Type

## 1-1. Unit Specifications

**PEY2**

### 10. Low Silhouette Ducted Type S-71PF1E5A / U-71PEY2E5

| INDOOR   |  | MODEL  | S-71PF1E5A                               |              |  |            |              |        |      |        |   |
|--|--|--|--|--------------|--|------------|--------------|--------|------|--------|---|
| PANEL  |  | MODEL  | -  |              |  | -          |              |        | -    |        |   |
| OUTDOOR  |  | MODEL  | -  |              |  | U-71PEY2E5 |              |        | -    |        |   |
| Branch pipe  |  | MODEL  | -  |              |  | -          |              |        | -    |        |   |
| Performance test condition                                 |  |  |  |              | ISO13253 / EN14511 / EN12102 / EN14825 |            |              |        |      |        |   |
| Power supply   |  | Ø, Hz  | 1ø 50Hz                                  |              |  | 1ø 50Hz    |              |        |      |        |   |
|  |  | V  | 220V                                     | 230V         | 240V                                   | 220V       | 230V         | 240V   | Min  | Max    |   |
| C<br>O<br>O<br>L<br>I<br>N<br>G                            | Capacity                                 | kW   | 7.1                                      | 7.1          | 7.1                                    | -          | -            | -      | 2.0  | 7.7    |   |
|  |  | BTU/h  | 24200                                    | 24200        | 24200                                  | -          | -            | -      | 6800 | 26300  |   |
|  | Current                                  | A  | 0.91                                     | 0.89         | 0.87                                   | 12.2       | 11.7         | 11.2   | -    | -      |   |
|  | Input power                              | W  | 120                                      | 120          | 120                                    | 2.450k     | 2.450k       | 2.450k | -    | -      |   |
|  |  | TOTAL W  | -  |              |  | 2.570k     | 2.570k       | 2.570k | 335  | 3.100k |   |
|  | Annual consumption                       | TOTAL kWh *4                                     | -  |              |  | -          | 1285         | -      | -    | -      |   |
|  | EER/EER CLASS                            | TOTAL (W/W) <sup>*5</sup> ("A"~"G")              | -  | -            | -                                      | 2.76       | 2.76/D       | 2.76   | 5.97 | 2.48   |   |
|  | Erp <sup>*6</sup>                        | Pdesign  | kW                                       | -            | -                                      | -          | -            | 7.1    | -    | -      | - |
|  |  | SEER   | (W/W)                                    | -            | -                                      | -          | -            | 5.4    | -    | -      | - |
|  |  | Annual consumption                               | kWh                                      | -            | -                                      | -          | -            | 460    | -    | -      | - |
| Class  |  |  | -  | -            | -                                      | -          | A            | -      | -    | -      |   |
| Power factor   | %  | -  | -  | -            | 91                                     | 91         | 91           | -      | -    |        |   |
| Noise indoor   | dB-A (H/M/L)                             | 35/32/26   |  |              | -                                      |            |              | -      | -    |        |   |
|  | Power Level dB                           | 57/54/48   |  |              | -                                      |            |              | -      | -    |        |   |
| Noise outdoor  | dB-A (H/L)                               | -  |  |              | 49/-                                   |            |              | -      | -    |        |   |
|  | Power Level dB                           | -  |  |              | 69/-                                   |            |              | -      | -    |        |   |
| H<br>E<br>A<br>T<br>I<br>N<br>G                            | Capacity                                 | kW   | 7.1                                      | 7.1          | 7.1                                    | -          | -            | -      | 1.8  | 8.1    |   |
|  |  | BTU/h  | 24200                                    | 24200        | 24200                                  | -          | -            | -      | 6100 | 27600  |   |
|  | Current                                  | A  | 0.91                                     | 0.89         | 0.87                                   | 8.15       | 7.80         | 7.45   | -    | -      |   |
|  | Input power                              | W  | 120                                      | 120          | 120                                    | 1.610k     | 1.610k       | 1.610k | -    | -      |   |
|  |  | TOTAL W  | -  |              |  | 1.730k     | 1.730k       | 1.730k | 285  | 2.200k |   |
|  | COP/COP CLASS                            | TOTAL (W/W) <sup>*5</sup> ("A"~"G")              | -  | -            | -                                      | 4.10       | 4.10/A       | 4.10   | 6.32 | 3.68   |   |
|  | Erp <sup>*6</sup>                        | Pdesign at -10°C                                 | kW                                       | -            | -                                      | -          | -            | 6.0    | -    | -      | - |
|  |  | Tbivalent  | °C                                       | -            | -                                      | -          | -            | -8     | -    | -      | - |
|  |  | SCOP   | (W/W)                                    | -            | -                                      | -          | -            | 4.0    | -    | -      | - |
|  |  | Annual consumption                               | kWh                                      | -            | -                                      | -          | -            | 2100   | -    | -      | - |
| Class  |  | -  | -  | -            | -                                      | A+         | -            | -      | -    |        |   |
| Power factor   | %  | -  | -  | -            | 90                                     | 90         | 90           | -      | -    |        |   |
| Noise indoor   | dB-A (H/M/L)                             | 35/32/26   |  |              | -                                      |            |              | -      | -    |        |   |
|  | Power Level dB                           | 57/54/48   |  |              | -                                      |            |              | -      | -    |        |   |
| Noise outdoor  | dB-A (H/L)                               | -  |  |              | 49/-                                   |            |              | -      | -    |        |   |
|  | Power Level dB                           | -  |  |              | 69/-                                   |            |              | -      | -    |        |   |
| EXTRA LOW TEMP   Total capacity(kW) / Input power(W) / COP |  |  |  |              |  |            |              |        |      |        |   |
| Max Current(A) / Max Input power(W)                        |  | 1.26/160   | 1.20/160                                 | 1.15/160     | 16.5/3.27k                             | 16.5/3.42k | 16.5/3.57k   |        |      |        |   |
| Starting current(A) / Comp output(W)                       |  | -  | -  | -            | 12.2/2.0k                              | 11.7/2.0k  | 11.2/2.0k    |        |      |        |   |
| Network Impedance(ΩMAX.)                                   |  |  |  |              |  |            |              |        |      |        |   |
| Fan motor output (Indoor/Outdoor) W                        |  |  |  | 120          |  | 60         |              |        |      |        |   |
| Moisture removal volume                                    |  | L/h(Pt/h)  | 4.2 (8.8)                                |              |  |            |              |        |      |        |   |
| External static pressure                                   |  | Pa   | 70 (MIN10 - MAX150)                      |              |  |            |              |        |      |        |   |
| Indoor Air flow  | Cooling                                  | m³/min (ft³/min)                                 | 21.0 / 19.0 / 15.0 (742) / (671) / (530) |              |  |            |              |        |      |        |   |
|  | Heating                                  | m³/min (ft³/min)                                 | 21.0 / 19.0 / 15.0 (742) / (671) / (530) |              |  |            |              |        |      |        |   |
| Outdoor Air flow   | Cooling                                  | m³/min (ft³/min)                                 | -  |              | 44 (1554)                              |            |              |        |      |        |   |
|  | Heating                                  | m³/min (ft³/min)                                 | -  |              | 41 (1448)                              |            |              |        |      |        |   |
| Refrigerant type / amount g(oz)                            |  |  |  |              |  | R410A      | 1.95k (68.8) |        |      |        |   |
| Product dimension  | Height                                   | mm(inch)   | 290 (11-13/32)                           |              | 619 (24-3/8)                           |            |              |        |      |        |   |
|  | Width                                    | mm(inch)   | 1000 (39-3/8)                            |              | 799 (31-29/64)                         |            |              |        |      |        |   |
|  | Depth                                    | mm(inch)   | 700 (27-9/16)                            |              | 299 (11-49/64)                         |            |              |        |      |        |   |
| Product dimension (Panel)                                  |  | H×W×D mm, inch                                   |  |              |  |            |              |        |      |        |   |
| Packing dimension  | Height                                   | mm(inch)   | 355 (13-31/32)                           |              | 688                                    |            |              |        |      |        |   |
|  | Width                                    | mm(inch)   | 1214 (47-13/16)                          |              | 931                                    |            |              |        |      |        |   |
|  | Depth                                    | mm(inch)   | 850 (33-15/32)                           |              | 422                                    |            |              |        |      |        |   |
| Weight   | (NET)                                    | kg(lb)   | 33 (73)                                  |              | 40 (88)                                |            |              |        |      |        |   |
|  | (GROSS)                                  | kg(lb)   | 41 (91)                                  |              | 45 (99)                                |            |              |        |      |        |   |
|  | Panel (NET)                              | kg(lb)   |  |              |  |            |              |        |      |        |   |
| Layers limit (actually)                                    |  | 9 (10)   |  | 5 (6)        |  |            |              |        |      |        |   |
| Operation condition  | Cool (DBT)                               | 18°C ~ 32°C                                      |  | -10°C ~ 43°C |  |            |              |        |      |        |   |
|  | Heat (DBT)                               | 16°C ~ 30°C                                      |  | -15°C ~ 24°C |  |            |              |        |      |        |   |
| P I P E I N G  | Pipe diameter mm (inch)                  | (Liquid)ø9.52(3/8) (Gas)ø15.88(5/8)              |  |              | (Liquid)ø9.52(3/8) (Gas)ø15.88(5/8)    |            |              |        |      |        |   |
|  | Connecting method, Standard length m(ft) | flared type, 5.0(16.4)                           |  |              | flared type, 5.0(16.4)                 |            |              |        |      |        |   |
| Pipe length range m (ft)                                   |  | 3 ~ 40m (9.8 ~ 131.2)                            |  |              |  |            |              |        |      |        |   |
| Indoor unit & Outdoor unit height difference m (ft)        |  | 15m (OD located lower) / 30m (OD located higher) |  | (49.2/98.4)  |  |            |              |        |      |        |   |
| Add gas amount g/m (oz/ft)                                 |  | 40g (0.430)                                      |  |              |  |            |              |        |      |        |   |
| Pipe length for additional gas m (ft)                      |  | 30m (98.4)                                       |  |              |  |            |              |        |      |        |   |

\*1: In case it is necessary to indicate the air flow volume in (l/s), the value in (m³/min.) shall be multiplied by 16.7 and rounded down the decimal point.

\*2: If the EUROVENT Certified models can be operated under the "extra-low" temperature condition, -7°C dry bulb and -8°C wet-bulb temperatures with rated voltage 230 V shall be used.

\*3: Network Impedance shall be applicable for EUROPE and CHINA models.

\*4: The annual consumption is calculated by multiplying the input power at 230 V (400 V) by an average of 500 hours per year in cooling mode.

\*5: EER and COP classification is at 230 V (400 V) only in accordance with EU directive 2002/31/EC.

\*6: SEER and SCOP classification is at 230V(400V) only in accordance with EN-14825. For heating, SCOP indicates the value of only Average heating season, Other fiche data indicates in an attached sheet.



# Single -Type

## 1-1. Unit Specifications

**PEY1**

### 10. Low Silhouette Ducted Type S-100PF1E5A / U-100PEY1E5

|  |   |  |                                     |          |                                     |                |             |          |      |        |      |
|--|---|--|-------------------------------------|----------|-------------------------------------|----------------|-------------|----------|------|--------|------|
| INDOOR   | MODEL   | S-100PF1E5A                                    |                                     |          | -                                   |                |             | -        |      |        |      |
| PANEL  | MODEL   | -  |                                     |          | -                                   |                |             | -        |      |        |      |
| OUTDOOR  | MODEL   | -  |                                     |          | U-100PEY1E5                         |                |             | -        |      |        |      |
| Branch pipe  | MODEL   | -  |                                     |          | -                                   |                |             | -        |      |        |      |
| Performance test condition                                 |   | ISO13253 / EN14511 / EN14825 / EN12102         |                                     |          |                                     |                |             |          |      |        |      |
| Power supply   |   | Ø, Hz  | 1ø 50Hz                             |          |                                     | 1ø 50Hz        |             |          | Min  | Max    |      |
|  |   | V  | 220                                 | 230      | 240                                 | 220            | 230         | 240      |      |        |      |
| C<br>O<br>O<br>L<br>I<br>N<br>G                            | Capacity  | kW   | 10.0                                | 10.0     | 10.0                                | -              | -           | -        | 2.7  | 11.5   |      |
|  |   | BTU/h  | 34100                               | 34100    | 34100                               | -              | -           | -        | 9200 | 39200  |      |
|  | Current   | A  | 1.35                                | 1.30     | 1.27                                | 15.1           | 14.5        | 13.9     | -    | -      |      |
|  |   | W  | 195                                 | 195      | 195                                 | 3.125k         | 3.125k      | 3.125k   | -    | -      |      |
|  | Input power   | TOTAL W  | -                                   |          |                                     | 3.320k         | 3.320k      | 3.320k   | 530  | 4.200k |      |
|  |   | Annual consumption                             | TOTAL kWh *4                        | -        |                                     |                | -           | 1660     | -    | -      | -    |
|  | EER/EER CLASS                                       | TOTAL (W/W) <sup>*5</sup> ("A"~"G")            | -                                   | -        | -                                   | 3.01           | 3.01 / B    | 3.01     | 5.09 | 2.74   |      |
|  | E<br>r<br>p<br>*6                                   | Pdesign  | kW                                  | -        | -                                   | -              | -           | 10.0     | -    | -      | -    |
|  |   | SEER   | (W/W)                               | -        | -                                   | -              | -           | 5.4      | -    | -      | -    |
|  |   | Annual consumption                             | kWh                                 | -        | -                                   | -              | -           | 648      | -    | -      | -    |
| Class  |   |  | -                                   | -        | -                                   | -              | A           | -        | -    | -      |      |
| Power factor   | %   | -  | -                                   | -        | 94                                  | 94             | 94          | -        | -    |        |      |
| Noise indoor   | dB-A (H/M/L)  | 38/34/31                                       |                                     |          | -                                   |                |             | -        | -    |        |      |
|  | Power Level dB                                      | 60/56/53                                       |                                     |          | -                                   |                |             | -        | -    |        |      |
| Noise outdoor  | dB-A (H/L)  | -  |                                     |          | 54/-                                |                |             | -        | -    |        |      |
|  | Power Level dB                                      | -  |                                     |          | 70/-                                |                |             | -        | -    |        |      |
| H<br>E<br>A<br>T<br>I<br>N<br>G                            | Capacity  | kW   | 10.0                                | 10.0     | 10.0                                | -              | -           | -        | 2.1  | 13.8   |      |
|  |   | BTU/h  | 34100                               | 34100    | 34100                               | -              | -           | -        | 7200 | 47100  |      |
|  | Current   | A  | 1.37                                | 1.34     | 1.29                                | 11.8           | 11.2        | 10.7     | -    | -      |      |
|  |   | W  | 200                                 | 200      | 200                                 | 2.430k         | 2.430k      | 2.430k   | -    | -      |      |
|  | Input power   | TOTAL W  | -                                   |          |                                     | 2.630k         | 2.630k      | 2.630k   | 410  | 4.000k |      |
|  |   | COP/COP CLASS                                  | TOTAL (W/W) <sup>*5</sup> ("A"~"G") | -        | -                                   | -              | 3.80        | 3.80 / A | 3.80 | 5.12   | 3.45 |
|  | E<br>r<br>p<br>*6                                   | Pdesign at -10°C                               | kW                                  | -        | -                                   | -              | -           | 9.5      | -    | -      | -    |
|  |   | Tbivalent                                      | °C                                  | -        | -                                   | -              | -           | -8       | -    | -      | -    |
|  |   | SCOP   | (W/W)                               | -        | -                                   | -              | -           | 3.8      | -    | -      | -    |
|  |   | Annual consumption                             | kWh                                 | -        | -                                   | -              | -           | 3500     | -    | -      | -    |
| Class  |   | -  | -                                   | -        | -                                   | A              | -           | -        | -    |        |      |
| Power factor   | %   | -  | -                                   | -        | 94                                  | 94             | 95          | -        | -    |        |      |
| Noise indoor   | dB-A (H/M/L)  | 38/34/31                                       |                                     |          | -                                   |                |             | -        | -    |        |      |
|  | Power Level dB                                      | 60/56/53                                       |                                     |          | -                                   |                |             | -        | -    |        |      |
| Noise outdoor  | dB-A (H/L)  | -  |                                     |          | 54/-                                |                |             | -        | -    |        |      |
|  | Power Level dB                                      | -  |                                     |          | 70/-                                |                |             | -        | -    |        |      |
| EXTRA LOW TEMP   Total capacity(kW) / Input power(W) / COP |   | -  |                                     |          |                                     |                |             |          |      |        |      |
| Max Current(A) / Max Input power(W)                        |   | 1.80/265                                       | 1.75/265                            | 1.70/265 | 25.0/5.300k                         | 25.0/5.500k    | 25.0/5.700k | -        |      |        |      |
| Starting current(A) / Comp output(W)                       |   | -  | -                                   | -        | 15.1/1.7k                           | 14.5/1.7k      | 13.9/1.7k   | -        |      |        |      |
| Network Impedance(ΩMAX.)                                   |   | -  |                                     |          |                                     |                |             |          |      |        |      |
| Fan motor output (Indoor/Outdoor) W                        |   | 200  |                                     |          | 90                                  |                |             | -        |      |        |      |
| Moisture removal volume                                    |   | L/h(Pt/h)                                      | 6.0 (12.6)                          |          |                                     | -              |             |          | -    |        |      |
| External static pressure                                   |   | Pa   | 100 (MIN10 - MAX150)                |          |                                     | -              |             |          | -    |        |      |
| Indoor Air flow  | Cooling   | m³/min (ft³/min)                               | 32/26/21 (1130/918/742)             |          |                                     | -              |             |          | -    |        |      |
|  | Heating   | m³/min (ft³/min)                               | 32/26/21 (1130/918/742)             |          |                                     | -              |             |          | -    |        |      |
| Outdoor Air flow   | Cooling   | m³/min (ft³/min)                               | -                                   |          |                                     | 76 (2684)      |             | -        |      |        |      |
|  | Heating   | m³/min (ft³/min)                               | -                                   |          |                                     | 67 (2366)      |             | -        |      |        |      |
| Refrigerant type / amount g(oz)                            |   | -  |                                     |          | R410A                               | 2.60k          | (91.7)      | -        |      |        |      |
| Product dimension  | Height  | mm(inch)                                       | 290 (11-13/32)                      |          |                                     | 996 (39-7/32)  |             |          | -    |        |      |
|  | Width   | mm(inch)                                       | 1400 (55-1/8)                       |          |                                     | 940 (37-1/32)  |             |          | -    |        |      |
|  | Depth   | mm(inch)                                       | 700 (27-9/16)                       |          |                                     | 340 (13-13/32) |             |          | -    |        |      |
| Packing dimension  | Height  | mm(inch)                                       | 355                                 |          |                                     | 1136           |             |          | -    |        |      |
|  | Width   | mm(inch)                                       | 1614                                |          |                                     | 1055           |             |          | -    |        |      |
|  | Depth   | mm(inch)                                       | 850                                 |          |                                     | 485            |             |          | -    |        |      |
| Weight   | (NET)   | kg(lb)   | 45 (99)                             |          |                                     | 73 (161)       |             |          | -    |        |      |
|  | (GROSS)   | kg(lb)   | 54 (119)                            |          |                                     | 81 (179)       |             |          | -    |        |      |
| Layers limit (actually)                                    |   | 9 (10)   |                                     |          | 2 (3)                               |                |             | -        |      |        |      |
| Operation condition  | Cool (DBT)  | 18°C ~ 32°C                                    |                                     |          | -10°C ~ 43°C                        |                |             | -        |      |        |      |
|  | Heat (DBT)  | 16°C ~ 30°C                                    |                                     |          | -15°C ~ 24°C                        |                |             | -        |      |        |      |
| P<br>I<br>P<br>I<br>N<br>G                                 | Pipe diameter mm (inch)                             | (Liquid)ø9.52(3/8) (Gas)ø15.88(5/8)            |                                     |          | (Liquid)ø9.52(3/8) (Gas)ø15.88(5/8) |                |             | -        |      |        |      |
|  | Connecting method, Standard length m(ft)            | flared type, 5.0(16.4)                         |                                     |          | flared type, 5.0(16.4)              |                |             | -        |      |        |      |
|  | Pipe length range                                   | m (ft)   |                                     |          | 5 ~ 50 (16.4 ~ 164.0)               |                |             | -        |      |        |      |
|  | Indoor unit & Outdoor unit height difference m (ft) | 15 (OD located lower) / 30 (OD located higher) |                                     |          | (49.2/98.4)                         |                |             | -        |      |        |      |
|  | Add gas amount g/m (oz/ft)                          | 50 (0.538)                                     |                                     |          | -                                   |                |             | -        |      |        |      |
|  | Pipe length for additional gas                      | m (ft)   |                                     |          | 30 (98.4)                           |                |             | -        |      |        |      |

\*1: In case it is necessary to indicate the air flow volume in (l/s), the value in (m³/min.) shall be multiplied by 16.7 and rounded down the decimal point.  
 \*2: If the EUROVENT Certified models can be operated under the "extra-low" temperature condition, -7°C dry bulb and -8°C wet-bulb temperatures with rated voltage 230 V shall be used.  
 \*3: Network Impedance shall be applicable for EUROPE and CHINA models.  
 \*4: The annual consumption is calculated by multiplying the input power at 230 V (400 V) by an average of 500 hours per year in cooling mode.  
 \*5: EER and COP classification is at 230 V (400 V) only in accordance with EU directive 2002/31/EC.  
 \*6: SEER and SCOP classification is at 230V(400V) only in accordance with EN-14825. For heating, SCOP indicates the value of only Average heating season, Other fiche data indicates in an attached sheet.

# Single -Type

## 1-1. Unit Specifications

**PEY1**

### 10. Low Silhouette Ducted Type S-125PF1E5A / U-125PEY1E5

| INDOOR   |   | MODEL                              | S-125PF1E5A                                    |          |          | -                                   |             |             | -     |        |      |
|--|---|------------------------------------|--|----------|----------|-------------------------------------|-------------|-------------|-------|--------|------|
| PANEL  |   | MODEL                              | -  |          |          | -                                   |             |             | -     |        |      |
| OUTDOOR  |   | MODEL                              | -  |          |          | U-125PEY1E5                         |             |             | -     |        |      |
| Branch pipe  |   | MODEL                              | -  |          |          | -                                   |             |             | -     |        |      |
| Performance test condition                                 |   |                                    | ISO13253 / EN14511 / EN12102 / EN14825         |          |          |                                     |             |             |       |        |      |
| Power supply   |   | Ø, Hz                              | 1ø 50Hz  |          |          | 1ø 50Hz                             |             |             |       |        |      |
|  |   | V                                  | 220  | 230      | 240      | 220                                 | 230         | 240         | Min   | Max    |      |
| C<br>O<br>O<br>L<br>I<br>N<br>G                            | Capacity  | kW                                 | 12.5   | 12.5     | 12.5     | -                                   | -           | -           | 3.8   | 13.5   |      |
|  |   | BTU/h                              | 42700  | 42700    | 42700    | -                                   | -           | -           | 13000 | 46100  |      |
|  | Current   | A                                  | 1.48   | 1.44     | 1.39     | 18.8                                | 18.0        | 17.2        | -     | -      |      |
|  |   | W                                  | 215  | 215      | 215      | 3.885k                              | 3.885k      | 3.885k      | -     | -      |      |
|  | Input power   | TOTAL W                            | -  |          |          | 4.100k                              | 4.100k      | 4.100k      | 900   | 5.000k |      |
|  |   | Annual consumption                 | TOTAL kWh *4                                   | -        |          |                                     | -           | 2050        | -     | -      | -    |
|  | EER/EER CLASS                                       | TOTAL (W/W) <sup>5</sup> ("A"~"G") | -  | -        | -        | 3.05                                | 3.05 / B    | 3.05        | 4.22  | 2.70   |      |
|  | E <sub>rp</sub> <sup>*6</sup>                       | Pdesign                            | kW   | -        | -        | -                                   | -           | 12.5        | -     | -      | -    |
|  |   | η <sub>s,c</sub>                   | %  | -        | -        | -                                   | -           | 201.4       | -     | -      | -    |
|  |   | Annual consumption                 | kWh  | -        | -        | -                                   | -           | -           | -     | -      | -    |
| Class  |   |                                    | -  | -        | -        | -                                   | -           | -           | -     | -      |      |
| Power factor   | %   | -                                  | -  | -        | 94       | 94                                  | 94          | -           | -     |        |      |
| Noise indoor   | dB-A (H/M/L)  | 39/35/32                           |  |          | -        |                                     |             | -           | -     | -      |      |
|  | Power Level dB                                      | 61/57/54                           |  |          | -        |                                     |             | -           | -     | -      |      |
| Noise outdoor  | dB-A (H/L)  | -                                  |  |          | 56/-     |                                     |             | -           | -     | -      |      |
|  | Power Level dB                                      | -                                  |  |          | 73/-     |                                     |             | -           | -     | -      |      |
| H<br>E<br>A<br>T<br>I<br>N<br>G                            | Capacity  | kW                                 | 12.5   | 12.5     | 12.5     | -                                   | -           | -           | 3.4   | 15.0   |      |
|  |   | BTU/h                              | 42700  | 42700    | 42700    | -                                   | -           | -           | 11600 | 51200  |      |
|  | Current   | A                                  | 1.46   | 1.42     | 1.38     | 14.6                                | 14.0        | 13.4        | -     | -      |      |
|  |   | W                                  | 210  | 210      | 210      | 3.060k                              | 3.060k      | 3.060k      | -     | -      |      |
|  | Input power   | TOTAL W                            | -  |          |          | 3.270k                              | 3.270k      | 3.270k      | 730   | 4.400k |      |
|  |   | COP/COP CLASS                      | TOTAL (W/W) <sup>5</sup> ("A"~"G")             | -        | -        | -                                   | 3.82        | 3.82 / A    | 3.82  | 4.66   | 3.41 |
|  | E <sub>rp</sub> <sup>*6</sup>                       | Pdesign at -10°C                   | kW   | -        | -        | -                                   | -           | 12.5        | -     | -      | -    |
|  |   | Tbivalent                          | °C   | -        | -        | -                                   | -           | -7          | -     | -      | -    |
|  |   | η <sub>s,h</sub>                   | %  | -        | -        | -                                   | -           | 140.9       | -     | -      | -    |
|  |   | Annual consumption                 | kWh  | -        | -        | -                                   | -           | -           | -     | -      | -    |
| Class  |   | -                                  | -  | -        | -        | -                                   | -           | -           | -     |        |      |
| Power factor   | %   | -                                  | -  | -        | 95       | 95                                  | 95          | -           | -     |        |      |
| Noise indoor   | dB-A (H/M/L)  | 39/35/32                           |  |          | -        |                                     |             | -           | -     | -      |      |
|  | Power Level dB                                      | 61/57/54                           |  |          | -        |                                     |             | -           | -     | -      |      |
| Noise outdoor  | dB-A (H/L)  | -                                  |  |          | 56/-     |                                     |             | -           | -     | -      |      |
|  | Power Level dB                                      | -                                  |  |          | 73/-     |                                     |             | -           | -     | -      |      |
| EXTRA LOW TEMP   Total capacity(kW) / Input power(W) / COP |   |                                    | -  |          |          | -                                   |             |             | -     |        |      |
| Max Current(A) / Max Input power(W)                        |   |                                    | 1.80/265                                       | 1.75/265 | 1.70/265 | 29.0/6.000k                         | 29.0/6.300k | 29.0/6.600k | -     |        |      |
| Starting current(A) / Comp output(W)                       |   |                                    | -  | -        | -        | 18.8/3.0k                           | 18.0/3.0k   | 17.2/3.0k   | -     |        |      |
| Network Impedance(ΩMAX.)                                   |   |                                    | -  |          |          | -                                   |             |             | -     |        |      |
| Fan motor output (Indoor/Outdoor) W                        |   |                                    | 200  |          |          | 90                                  |             |             | -     |        |      |
| Moisture removal volume                                    |   | L/h(Pt/h)                          | 7.9  | (16.6)   |          | -                                   |             |             | -     |        |      |
| External static pressure                                   |   | Pa                                 | 100 (MIN10 - MAX150)                           |          |          | -                                   |             |             | -     |        |      |
| Indoor Air flow  | Cooling   | m³/min (ft³/min)                   | 34/29/23 (1201/1024/812)                       |          |          | -                                   |             |             | -     |        |      |
|  | Heating   | m³/min (ft³/min)                   | 34/29/23 (1201/1024/812)                       |          |          | -                                   |             |             | -     |        |      |
| Outdoor Air flow   | Cooling   | m³/min (ft³/min)                   | -  |          |          | 80                                  | (2825)      |             | -     |        |      |
|  | Heating   | m³/min (ft³/min)                   | -  |          |          | 73                                  | (2578)      |             | -     |        |      |
| Refrigerant type / amount g(oz)                            |   |                                    | -  |          |          | R410A                               | 3.20k       | (112.9)     | -     |        |      |
| Product dimension  | Height  | mm(inch)                           | 290 (11-13/32)                                 |          |          | 996 (39-7/32)                       |             |             | -     |        |      |
|  | Width   | mm(inch)                           | 1400 (55-1/8)                                  |          |          | 940 (37-1/32)                       |             |             | -     |        |      |
|  | Depth   | mm(inch)                           | 700 (27-9/16)                                  |          |          | 340 (13-13/32)                      |             |             | -     |        |      |
| Packing dimension  | Height  | mm(inch)                           | 355  |          |          | 1136                                |             |             | -     |        |      |
|  | Width   | mm(inch)                           | 1614   |          |          | 1055                                |             |             | -     |        |      |
|  | Depth   | mm(inch)                           | 850  |          |          | 485                                 |             |             | -     |        |      |
| Weight   | (NET)   | kg(lb)                             | 45 (99)  |          |          | 85 (187)                            |             |             | -     |        |      |
|  | (GROSS)   | kg(lb)                             | 54 (119)                                       |          |          | 93 (205)                            |             |             | -     |        |      |
| Layers limit (actually)                                    |   |                                    | 9 (10)   |          |          | 2 (3)                               |             |             | -     |        |      |
| Operation condition  | Cool (DBT)  |                                    | 18°C ~ 32°C                                    |          |          | -10°C ~ 43°C                        |             |             | -     |        |      |
|  | Heat (DBT)  |                                    | 16°C ~ 30°C                                    |          |          | -15°C ~ 24°C                        |             |             | -     |        |      |
| P<br>I<br>P<br>I<br>N<br>G                                 | Pipe diameter mm (inch)                             |                                    | (Liquid)ø9.52(3/8) (Gas)ø15.88(5/8)            |          |          | (Liquid)ø9.52(3/8) (Gas)ø15.88(5/8) |             |             | -     |        |      |
|  | Connecting method, Standard length m(ft)            |                                    | flared type, 5.0(16.4)                         |          |          | flared type, 5.0(16.4)              |             |             | -     |        |      |
|  | Pipe length range                                   | m (ft)                             | 5 ~ 50 (16.4 ~ 164.0)                          |          |          | -                                   |             |             | -     |        |      |
|  | Indoor unit & Outdoor unit height difference m (ft) |                                    | 15 (OD located lower) / 30 (OD located higher) |          |          | (49.2/98.4)                         |             |             | -     |        |      |
|  | Add gas amount g/m (oz/ft)                          |                                    | 50 (0.538)                                     |          |          | -                                   |             |             | -     |        |      |
|  | Pipe length for additional gas                      | m (ft)                             | 30 (98.4)                                      |          |          | -                                   |             |             | -     |        |      |

\*1: In case it is necessary to indicate the air flow volume in (l/s), the value in (m³/min.) shall be multiplied by 16.7 and rounded down the decimal point.

\*2: If the EUROVENT Certified models can be operated under the "extra-low" temperature condition, -7°C dry bulb and -8°C wet-bulb temperatures with rated voltage 230 V shall be used.

\*3: Network Impedance shall be applicable for EUROPE and CHINA models.

\*4: The annual consumption is calculated by multiplying the input power at 230 V (400 V) by an average of 500 hours per year in cooling mode.

\*5: EER and COP classification is at 230 V (400 V) only in accordance with EU directive 2002/31/EC.

\*6: SEER and SCOP classification is at 230V(400V) only in accordance with EN-14825. For heating, SCOP indicates the value of only Average heating season.

# Simultaneous (Twin) -Type

## 1-1. Unit Specifications

**PEY1**

### 10. Low Silhouette Ducted Type S-50PF1E5A×2 / U-100PEY1E8

| INDOOR  |  | MODEL  | S-50PF1E5A×2                       |              |                                     | -              |            |          | -    |        |      |
|---|--|--|------------------------------------|--------------|-------------------------------------|----------------|------------|----------|------|--------|------|
| PANEL   |  | MODEL  | -                                  |              |                                     | -              |            |          | -    |        |      |
| OUTDOOR   |  | MODEL  | -                                  |              |                                     | U-100PEY1E8    |            |          | -    |        |      |
| Branch pipe   |  | MODEL  | -                                  |              |                                     | CZ-P155BK1     |            |          | -    |        |      |
| Performance test condition  |  | ISO13253 / EN14511 / EN14825 / EN12102         |                                    |              |                                     |                |            |          |      |        |      |
| Power supply  |  | Ø, Hz  | 1ø 50Hz                            |              |                                     | 3ø 50Hz        |            |          |      |        |      |
|   |  | V  | 220                                | 230          | 240                                 | 380            | 400        | 415      | Min  | Max    |      |
| C<br>O<br>O<br>L<br>I<br>N<br>G                                       | Capacity                                 | kW   | 10.0                               | 10.0         | 10.0                                | -              | -          | -        | 2.7  | 11.5   |      |
|   |  | BTU/h  | 34100                              | 34100        | 34100                               | -              | -          | -        | 9200 | 39200  |      |
|   | Current                                  | A  | 0.77×2                             | 0.74×2       | 0.71×2                              | 5.10           | 4.85       | 4.70     | -    | -      |      |
|   |  | W  | 100×2                              | 100×2        | 100×2                               | 3.125k         | 3.125k     | 3.125k   | -    | -      |      |
|   | Input power                              | TOTAL W  | -                                  |              |                                     | 3.325k         | 3.325k     | 3.325k   | 530  | 4.200k |      |
|   |  | Annual consumption                             | TOTAL kWh *4                       | -            |                                     |                | -          | 1663     | -    | -      | -    |
|   | EER/EER CLASS                            | TOTAL (W/W) <sup>5</sup> ("A"~"G")             | -                                  | -            | -                                   | 3.01           | 3.01 / B   | 3.01     | 5.09 | 2.74   |      |
|   | E <sub>rp</sub> <sup>6</sup>             | Pdesign  | kW                                 | -            | -                                   | -              | -          | 10.0     | -    | -      | -    |
|   |  | SEER   | (W/W)                              | -            | -                                   | -              | -          | 5.2      | -    | -      | -    |
|   |  | Annual consumption                             | kWh                                | -            | -                                   | -              | -          | 673      | -    | -      | -    |
| Class   |  |  | -                                  | -            | -                                   | -              | A          | -        | -    | -      |      |
| Power factor  | %  | -  | -                                  | -            | 93                                  | 93             | 93         | -        | -    |        |      |
| Noise indoor  | dB-A (H/M/L)                             | 34/30/26                                       |                                    |              | -                                   |                |            | -        | -    |        |      |
|   | Power Level dB                           | 56/52/48                                       |                                    |              | -                                   |                |            | -        | -    |        |      |
| Noise outdoor   | dB-A (H/L)                               | -  |                                    |              | 54/-                                |                |            | -        | -    |        |      |
|   | Power Level dB                           | -  |                                    |              | 70/-                                |                |            | -        | -    |        |      |
| H<br>E<br>A<br>T<br>I<br>N<br>G                                       | Capacity                                 | kW   | 10.0                               | 10.0         | 10.0                                | -              | -          | -        | 2.1  | 13.8   |      |
|   |  | BTU/h  | 34100                              | 34100        | 34100                               | -              | -          | -        | 7200 | 47100  |      |
|   | Current                                  | A  | 0.77×2                             | 0.74×2       | 0.71×2                              | 4.05           | 3.80       | 3.65     | -    | -      |      |
|   |  | W  | 100×2                              | 100×2        | 100×2                               | 2.430k         | 2.430k     | 2.430k   | -    | -      |      |
|   | Input power                              | TOTAL W  | -                                  |              |                                     | 2.630k         | 2.630k     | 2.630k   | 410  | 4.000k |      |
|   |  | COP/COP CLASS                                  | TOTAL (W/W) <sup>5</sup> ("A"~"G") | -            | -                                   | -              | 3.80       | 3.80 / A | 3.80 | 5.12   | 3.45 |
|   | E <sub>rp</sub> <sup>6</sup>             | Pdesign at -10°C                               | kW                                 | -            | -                                   | -              | -          | 9.5      | -    | -      | -    |
|   |  | Tbivalent                                      | °C                                 | -            | -                                   | -              | -          | -8       | -    | -      | -    |
|   |  | SCOP   | (W/W)                              | -            | -                                   | -              | -          | 3.8      | -    | -      | -    |
|   |  | Annual consumption                             | kWh                                | -            | -                                   | -              | -          | 3500     | -    | -      | -    |
| Class   |  | -  | -                                  | -            | -                                   | A              | -          | -        | -    |        |      |
| Power factor  | %  | -  | -                                  | -            | 91                                  | 92             | 93         | -        | -    |        |      |
| Noise indoor  | dB-A (H/M/L)                             | 34/30/26                                       |                                    |              | -                                   |                |            | -        | -    |        |      |
|   | Power Level dB                           | 56/52/48                                       |                                    |              | -                                   |                |            | -        | -    |        |      |
| Noise outdoor   | dB-A (H/L)                               | -  |                                    |              | 54/-                                |                |            | -        | -    |        |      |
|   | Power Level dB                           | -  |                                    |              | 70/-                                |                |            | -        | -    |        |      |
| EXTRA LOW TEMP <sup>1</sup> Total capacity(kW) / Input power(W) / COP |  | -  |                                    |              |                                     |                |            |          |      |        |      |
| Max Current(A) / Max Input power(W)                                   |  | 1.00×2/125×2                                   | 0.96×2/125×2                       | 0.92×2/125×2 | 9.0/5.550k                          | 9.0/5.800k     | 9.0/6.050k | -        |      |        |      |
| Starting current(A) / Comp output(W)                                  |  | -  | -                                  | -            | 5.10/1.7k                           | 4.85/1.7k      | 4.70/1.7k  | -        |      |        |      |
| Network Impedance(ΩMAX.)  |  | -  |                                    |              | -                                   |                |            | -        |      |        |      |
| Fan motor output (Indoor/Outdoor) W                                   |  | 120×2  |                                    |              | 90                                  |                |            | -        |      |        |      |
| Moisture removal volume   |  | L/h(Pt/h)                                      | 6.0                                | (3.0×2)      | (12.6)                              | -              |            |          | -    |        |      |
| External static pressure  |  | Pa   | 70 (MIN10 - MAX150)                |              |                                     | -              |            |          | -    |        |      |
| Indoor Air flow   | Cooling                                  | m³/min (ft³/min)                               | [16/15/12 (565/530/424)]×2         |              |                                     | -              |            |          | -    |        |      |
|   | Heating                                  | m³/min (ft³/min)                               | [16/15/12 (565/530/424)]×2         |              |                                     | -              |            |          | -    |        |      |
| Outdoor Air flow  | Cooling                                  | m³/min (ft³/min)                               | -                                  |              |                                     | 76             | (2684)     | -        |      |        |      |
|   | Heating                                  | m³/min (ft³/min)                               | -                                  |              |                                     | 67             | (2366)     | -        |      |        |      |
| Refrigerant type / amount g(oz)                                       |  | -  |                                    |              | R410A                               | 2.60k          | (91.7)     | -        |      |        |      |
| Product dimension   | Height                                   | mm(inch)                                       | 290 (11-13/32)                     |              |                                     | 996 (39-7/32)  |            |          | -    |        |      |
|   | Width                                    | mm(inch)                                       | 800 (31-1/2)                       |              |                                     | 940 (37-1/32)  |            |          | -    |        |      |
|   | Depth                                    | mm(inch)                                       | 700 (27-9/16)                      |              |                                     | 340 (13-13/32) |            |          | -    |        |      |
| Packing dimension   | Height                                   | mm(inch)                                       | 355                                |              |                                     | 1136           |            |          | -    |        |      |
|   | Width                                    | mm(inch)                                       | 1014                               |              |                                     | 1055           |            |          | -    |        |      |
|   | Depth                                    | mm(inch)                                       | 850                                |              |                                     | 485            |            |          | -    |        |      |
| Weight  | (NET)                                    | kg(lb)   | 28 (62)                            |              |                                     | 73 (161)       |            |          | -    |        |      |
|   | (GROSS)                                  | kg(lb)   | 35 (78)                            |              |                                     | 81 (179)       |            |          | -    |        |      |
| Layers limit (actually)   |  | 9 (10)   |                                    |              | 2 (3)                               |                |            | -        |      |        |      |
| Operation condition   | Cool (DBT)                               | 18°C ~ 32°C                                    |                                    |              | -10°C ~ 43°C                        |                |            | -        |      |        |      |
|   | Heat (DBT)                               | 16°C ~ 30°C                                    |                                    |              | -15°C ~ 24°C                        |                |            | -        |      |        |      |
| P<br>I<br>P<br>I<br>N<br>G  | Pipe diameter mm (inch)                  | (Liquid)ø6.35(1/4) (Gas)ø12.7(1/2)             |                                    |              | (Liquid)ø9.52(3/8) (Gas)ø15.88(5/8) |                |            | -        |      |        |      |
|   | Connecting method, Standard length m(ft) | flared type, 5.0(16.4)                         |                                    |              | flared type, 5.0(16.4)              |                |            | -        |      |        |      |
| Pipe length range   |  | m (ft)   |                                    |              | 5 ~ 50 (16.4 ~ 164.0)               |                |            | -        |      |        |      |
| Indoor unit & Outdoor unit height difference m (ft)                   |  | 15 (OD located lower) / 30 (OD located higher) |                                    |              | (49.2/98.4)                         |                |            | -        |      |        |      |
| Add gas amount g/m (oz/ft)  |  | 50   |                                    |              | (0.538)                             |                |            | -        |      |        |      |
| Pipe length for additional gas  |  | m (ft)   |                                    |              | 30 (98.4)                           |                |            | -        |      |        |      |

\*1: In case it is necessary to indicate the air flow volume in (l/s), the value in (m³/min.) shall be multiplied by 16.7 and rounded down the decimal point.  
 \*2: If the EUROVENT Certified models can be operated under the "extra-low" temperature condition, -7°C dry bulb and -8°C wet-bulb temperatures with rated voltage 230 V shall be used.  
 \*3: Network Impedance shall be applicable for EUROPE and CHINA models.  
 \*4: The annual consumption is calculated by multiplying the input power at 230 V (400 V) by an average of 500 hours per year in cooling mode.  
 \*5: EER and COP classification is at 230 V (400 V) only in accordance with EU directive 2002/31/EC.  
 \*6: SEER and SCOP classification is at 230V(400V) only in accordance with EN-14825. For heating, SCOP indicates the value of only Average heating season, Other fiche data indicates in an attached sheet.

# Simultaneous (Twin) -Type

## 1-1. Unit Specifications

**PEY1**

### 10. Low Silhouette Ducted Type S-60PF1E5A×2 / U-125PEY1E8

| INDOOR   |   | MODEL  | S-60PF1E5A×2               |              |                                     | -              |             |          | -     |        |      |
|--|---|--|----------------------------|--------------|-------------------------------------|----------------|-------------|----------|-------|--------|------|
| PANEL  |   | MODEL  | -                          |              |                                     | -              |             |          | -     |        |      |
| OUTDOOR  |   | MODEL  | -                          |              |                                     | U-125PEY1E8    |             |          | -     |        |      |
| Branch pipe  |   | MODEL  | -                          |              |                                     | CZ-P155BK1     |             |          | -     |        |      |
| Performance test condition                                 |   | ISO13253 / EN14511 / EN12102 / EN14825         |                            |              |                                     |                |             |          |       |        |      |
| Power supply   |   | Ø, Hz  | 1ø 50Hz                    |              |                                     | 3ø 50Hz        |             |          |       |        |      |
|  |   | V  | 220                        | 230          | 240                                 | 380            | 400         | 415      | Min   | Max    |      |
| C<br>O<br>L<br>O<br>R<br>I<br>N<br>G                       | Capacity  | kW   | 12.5                       | 12.5         | 12.5                                | -              | -           | -        | 3.8   | 13.5   |      |
|  |   | BTU/h  | 42700                      | 42700        | 42700                               | -              | -           | -        | 13000 | 46100  |      |
|  | Current   | A  | 0.91×2                     | 0.89×2       | 0.87×2                              | 6.20           | 5.90        | 5.70     | -     | -      |      |
|  |   | W  | 120×2                      | 120×2        | 120×2                               | 3.885k         | 3.885k      | 3.885k   | -     | -      |      |
|  | Input power   | TOTAL W  | -                          |              |                                     | 4.125k         | 4.125k      | 4.125k   | 900   | 5.000k |      |
|  |   | Annual consumption                             | TOTAL kWh *4               | -            |                                     |                | -           | 2063     | -     | -      | -    |
|  | EER/EER CLASS                                       | TOTAL (W/W) *5 ("A"~"G")                       | -                          | -            | -                                   | 3.03           | 3.03 / B    | 3.03     | 4.22  | 2.70   |      |
|  | E <sub>sp</sub> <sup>*6</sup>                       | Pdesign  | kW                         | -            | -                                   | -              | -           | 12.5     | -     | -      | -    |
|  |   | η <sub>s,c</sub>                               | %                          | -            | -                                   | -              | -           | 212.9    | -     | -      | -    |
|  |   | Annual consumption                             | kWh                        | -            | -                                   | -              | -           | -        | -     | -      | -    |
| Class  |   |  | -                          | -            | -                                   | -              | -           | -        | -     | -      |      |
| Power factor   | %   | -  | -                          | -            | 95                                  | 95             | 95          | -        | -     |        |      |
| Noise indoor   | dB-A (H/M/L)  | 35/32/26                                       |                            |              | -                                   |                |             | -        | -     |        |      |
|  | Power Level dB                                      | 57/54/48                                       |                            |              | -                                   |                |             | -        | -     |        |      |
| Noise outdoor  | dB-A (H/L)  | -  |                            |              | 56/-                                |                |             | -        | -     |        |      |
|  | Power Level dB                                      | -  |                            |              | 73/-                                |                |             | -        | -     |        |      |
| H<br>E<br>A<br>T<br>I<br>N<br>G                            | Capacity  | kW   | 12.5                       | 12.5         | 12.5                                | -              | -           | -        | 3.4   | 15.0   |      |
|  |   | BTU/h  | 42700                      | 42700        | 42700                               | -              | -           | -        | 11600 | 51200  |      |
|  | Current   | A  | 0.91×2                     | 0.89×2       | 0.87×2                              | 4.90           | 4.65        | 4.50     | -     | -      |      |
|  |   | W  | 120×2                      | 120×2        | 120×2                               | 3.060k         | 3.060k      | 3.060k   | -     | -      |      |
|  | Input power   | TOTAL W  | -                          |              |                                     | 3.300k         | 3.300k      | 3.300k   | 730   | 4.400k |      |
|  |   | COP/COP CLASS                                  | TOTAL (W/W) *5 ("A"~"G")   | -            | -                                   | -              | 3.79        | 3.79 / A | 3.79  | 4.66   | 3.41 |
|  | E <sub>sp</sub> <sup>*6</sup>                       | Pdesign at -10°C                               | kW                         | -            | -                                   | -              | -           | 12.5     | -     | -      | -    |
|  |   | Tbivalent                                      | °C                         | -            | -                                   | -              | -           | -7       | -     | -      | -    |
|  |   | η <sub>s,h</sub>                               | %                          | -            | -                                   | -              | -           | 141.6    | -     | -      | -    |
|  |   | Annual consumption                             | kWh                        | -            | -                                   | -              | -           | -        | -     | -      | -    |
| Class  |   | -  | -                          | -            | -                                   | -              | -           | -        | -     |        |      |
| Power factor   | %   | -  | -                          | -            | 95                                  | 95             | 95          | -        | -     |        |      |
| Noise indoor   | dB-A (H/M/L)  | 35/32/26                                       |                            |              | -                                   |                |             | -        | -     |        |      |
|  | Power Level dB                                      | 57/54/48                                       |                            |              | -                                   |                |             | -        | -     |        |      |
| Noise outdoor  | dB-A (H/L)  | -  |                            |              | 56/-                                |                |             | -        | -     |        |      |
|  | Power Level dB                                      | -  |                            |              | 73/-                                |                |             | -        | -     |        |      |
| EXTRA LOW TEMP   Total capacity(kW) / Input power(W) / COP |   | -  |                            |              |                                     |                |             |          |       |        |      |
| Max Current(A) / Max Input power(W)                        |   | 1.26×2/160×2                                   | 1.20×2/160×2               | 1.15×2/160×2 | 10.0/6.200k                         | 10.0/6.500k    | 10.0/6.750k | -        |       |        |      |
| Starting current(A) / Comp output(W)                       |   | -  | -                          | -            | 6.20/3.0k                           | 5.90/3.0k      | 5.70/3.0k   | -        |       |        |      |
| Network Impedance(ΩMAX.)                                   |   | -  |                            |              | -                                   |                |             | -        |       |        |      |
| Fan motor output (Indoor/Outdoor) W                        |   | 120×2  |                            |              | 90                                  |                |             | -        |       |        |      |
| Moisture removal volume                                    |   | L/h(Pt/h)                                      | 7.9                        | (3.95×2)     | (16.6)                              | -              |             |          | -     |        |      |
| External static pressure                                   |   | Pa   | 70 (MIN10 - MAX150)        |              |                                     | -              |             |          | -     |        |      |
| Indoor Air flow  | Cooling   | m³/min (ft³/min)                               | [21/19/15 (742/671/530)]×2 |              |                                     | -              |             |          | -     |        |      |
|  | Heating   | m³/min (ft³/min)                               | [21/19/15 (742/671/530)]×2 |              |                                     | -              |             |          | -     |        |      |
| Outdoor Air flow   | Cooling   | m³/min (ft³/min)                               | -                          |              |                                     | 80             | (2825)      | -        |       |        |      |
|  | Heating   | m³/min (ft³/min)                               | -                          |              |                                     | 73             | (2578)      | -        |       |        |      |
| Refrigerant type / amount g(oz)                            |   | -  |                            |              | R410A                               | 3.20k          | (112.9)     | -        |       |        |      |
| Product dimension  | Height  | mm(inch)                                       | 290 (11-13/32)             |              |                                     | 996 (39-7/32)  |             |          | -     |        |      |
|  | Width   | mm(inch)                                       | 1000 (39-3/8)              |              |                                     | 940 (37-1/32)  |             |          | -     |        |      |
|  | Depth   | mm(inch)                                       | 700 (27-9/16)              |              |                                     | 340 (13-13/32) |             |          | -     |        |      |
| Packing dimension  | Height  | mm(inch)                                       | 355                        |              |                                     | 1136           |             |          | -     |        |      |
|  | Width   | mm(inch)                                       | 1214                       |              |                                     | 1055           |             |          | -     |        |      |
|  | Depth   | mm(inch)                                       | 850                        |              |                                     | 485            |             |          | -     |        |      |
| Weight   | (NET)   | kg(lb)   | 33 (73)                    |              |                                     | 85 (187)       |             |          | -     |        |      |
|  | (GROSS)   | kg(lb)   | 41 (91)                    |              |                                     | 93 (205)       |             |          | -     |        |      |
| Layers limit (actually)                                    |   | 9 (10)   |                            |              | 2 (3)                               |                |             | -        |       |        |      |
| Operation condition  | Cool (DBT)  | 18°C ~ 32°C                                    |                            |              | -10°C ~ 43°C                        |                |             | -        |       |        |      |
|  | Heat (DBT)  | 16°C ~ 30°C                                    |                            |              | -15°C ~ 24°C                        |                |             | -        |       |        |      |
| P<br>I<br>P<br>I<br>N<br>G                                 | Pipe diameter mm (inch)                             | (Liquid)ø9.52(3/8) (Gas)ø15.88(5/8)            |                            |              | (Liquid)ø9.52(3/8) (Gas)ø15.88(5/8) |                |             | -        |       |        |      |
|  | Connecting method, Standard length m(ft)            | flared type, 5.0(16.4)                         |                            |              | flared type, 5.0(16.4)              |                |             | -        |       |        |      |
|  | Pipe length range                                   | m (ft)   |                            |              | 5 ~ 50 (16.4 ~ 164.0)               |                |             | -        |       |        |      |
|  | Indoor unit & Outdoor unit height difference m (ft) | 15 (OD located lower) / 30 (OD located higher) |                            |              | (49.2/98.4)                         |                |             | -        |       |        |      |
|  | Add gas amount g/m (oz/ft)                          | 50   |                            |              | (0.538)                             |                |             | -        |       |        |      |
|  | Pipe length for additional gas                      | m (ft)   |                            |              | 30 (98.4)                           |                |             | -        |       |        |      |

\*1: In case it is necessary to indicate the air flow volume in (l/s), the value in (m³/min.) shall be multiplied by 16.7 and rounded down the decimal point.

\*2: If the EUROVENT Certified models can be operated under the "extra-low" temperature condition, -7°C dry bulb and -8°C wet-bulb temperatures with rated voltage 230 V shall be used.

\*3: Network Impedance shall be applicable for EUROPE and CHINA models.

\*4: The annual consumption is calculated by multiplying the input power at 230 V (400 V) by an average of 500 hours per year in cooling mode.

\*5: EER and COP classification is at 230 V (400 V) only in accordance with EU directive 2002/31/EC.

\*6: SEER and SCOP classification is at 230V(400V) only in accordance with EN-14825. For heating, SCOP indicates the value of only Average heating season.

# Simultaneous (Twin) -Type

## 1-1. Unit Specifications

**PEY1**

### 10. Low Silhouette Ducted Type S-71PF1E5A×2 / U-140PEY1E8

|  |   |  |  |              |             |                                     |             |          |       |        |      |
|--|---|--|--|--------------|-------------|-------------------------------------|-------------|----------|-------|--------|------|
| INDOOR   |   | MODEL                                  | S-71PF1E5A×2                                   |              |             |                                     |             |          | -     | -      |      |
| PANEL  |   | MODEL                                  |  |              |             |                                     |             |          | -     | -      |      |
| OUTDOOR  |   | MODEL                                  |  |              |             | U-140PEY1E8                         |             |          | -     | -      |      |
| Branch pipe  |   | MODEL                                  |  |              |             | CZ-P155BK1                          |             |          | -     | -      |      |
| Performance test condition                                 |   | ISO13253 / EN14511 / EN12102 / EN14825 |  |              |             |                                     |             |          |       |        |      |
| Power supply   |   | Ø, Hz                                  | 1ø 50Hz  |              |             | 3ø 50Hz                             |             |          |       |        |      |
|  |   | V                                      | 220  | 230          | 240         | 380                                 | 400         | 415      | Min   | Max    |      |
| C<br>O<br>O<br>L<br>I<br>N<br>G                            | Capacity  | kW                                     | 14.0   | 14.0         | 14.0        | -                                   | -           | -        | 3.3   | 15.5   |      |
|  |   | BTU/h                                  | 47800  | 47800        | 47800       | -                                   | -           | -        | 11300 | 52900  |      |
|  | Current   | A                                      | 0.91×2   | 0.89×2       | 0.87×2      | 6.75                                | 6.45        | 6.25     | -     | -      |      |
|  |   | W                                      | 120×2  | 120×2        | 120×2       | 4.125k                              | 4.125k      | 4.125k   | -     | -      |      |
|  | Input power   | TOTAL W                                |  |              |             | 4.365k                              | 4.365k      | 4.365k   | 840   | 6.000k |      |
|  |   | Annual consumption                     | TOTAL kWh *4                                   |              |             |                                     | -           | 2183     | -     | -      | -    |
|  | EER/EER CLASS                                       | TOTAL (W/W) *5 / ("A"-G)               | -  | -            | -           | 3.21                                | 3.21 / A    | 3.21     | 3.93  | 2.58   |      |
|  | E <sub>rp</sub> <sup>*6</sup>                       | Pdesign                                | kW   | -            | -           | -                                   | -           | 14.0     | -     | -      | -    |
|  |   | η <sub>s.c</sub>                       | %  | -            | -           | -                                   | -           | 221.9    | -     | -      | -    |
|  |   | Annual consumption                     | kWh  | -            | -           | -                                   | -           | -        | -     | -      | -    |
| Class  |   |  | -  | -            | -           | -                                   | -           | -        | -     | -      |      |
| Power factor   | %   | -                                      | -  | -            | 93          | 92                                  | 92          | -        | -     |        |      |
| Noise indoor   | dB-A (H/M/L)  | 35/32/26                               |  |              |             |                                     |             | -        | -     | -      |      |
|  | Power Level dB                                      | 57/54/48                               |  |              |             |                                     |             | -        | -     | -      |      |
| Noise outdoor  | dB-A (H/L)  |  |  |              | 54/-        |                                     |             | -        | -     | -      |      |
|  | Power Level dB                                      |  |  |              | 71/-        |                                     |             | -        | -     | -      |      |
| H<br>E<br>A<br>T<br>I<br>N<br>G                            | Capacity  | kW                                     | 14.0   | 14.0         | 14.0        | -                                   | -           | -        | 4.1   | 16.0   |      |
|  |   | BTU/h                                  | 47800  | 47800        | 47800       | -                                   | -           | -        | 14000 | 54600  |      |
|  | Current   | A                                      | 0.91×2   | 0.89×2       | 0.87×2      | 5.60                                | 5.40        | 5.20     | -     | -      |      |
|  |   | W                                      | 120×2  | 120×2        | 120×2       | 3.355k                              | 3.355k      | 3.355k   | -     | -      |      |
|  | Input power   | TOTAL W                                |  |              |             | 3.595k                              | 3.595k      | 3.595k   | 900   | 5.200k |      |
|  |   | COP/COP CLASS                          | TOTAL (W/W) *5 / ("A"-G)                       | -            | -           | -                                   | 3.89        | 3.89 / A | 3.89  | 4.56   | 3.08 |
|  | E <sub>rp</sub> <sup>*6</sup>                       | Pdesign at -10°C                       | kW   | -            | -           | -                                   | -           | 14.0     | -     | -      | -    |
|  |   | Tbivalent                              | °C   | -            | -           | -                                   | -           | -7       | -     | -      | -    |
|  |   | η <sub>s.h</sub>                       | %  | -            | -           | -                                   | -           | 138.6    | -     | -      | -    |
|  |   | Annual consumption                     | kWh  | -            | -           | -                                   | -           | -        | -     | -      | -    |
| Class  |   | -                                      | -  | -            | -           | -                                   | -           | -        | -     |        |      |
| Power factor   | %   | -                                      | -  | -            | 91          | 90                                  | 90          | -        | -     |        |      |
| Noise indoor   | dB-A (H/M/L)  | 35/32/26                               |  |              |             |                                     |             | -        | -     | -      |      |
|  | Power Level dB                                      | 57/54/48                               |  |              |             |                                     |             | -        | -     | -      |      |
| Noise outdoor  | dB-A (H/L)  |  |  |              | 53/-        |                                     |             | -        | -     | -      |      |
|  | Power Level dB                                      |  |  |              | 70/-        |                                     |             | -        | -     | -      |      |
| EXTRA LOW TEMP   Total capacity(kW) / Input power(W) / COP |   |  |  |              |             |                                     |             |          |       |        |      |
| Max Current(A) / Max Input power(W)                        |   | 1.26×2/160×2                           | 1.20×2/160×2                                   | 1.15×2/160×2 | 10.0/6.200k | 10.0/6.500k                         | 10.0/6.750k |          |       |        |      |
| Starting current(A) / Comp output(W)                       |   | -                                      | -  | -            | 6.75/3.0k   | 6.45/3.0k                           | 6.25/3.0k   |          |       |        |      |
| Network Impedance(ΩMAX.)                                   |   |  |  |              |             |                                     |             |          |       |        |      |
| Fan motor output (Indoor/Outdoor) W                        |   | 120                                    |  |              | 90×2        |                                     |             |          |       |        |      |
| Moisture removal volume                                    |   | L/h(Pt/h)                              | 9.0  | (4.5×2)      | (18.9)      |                                     |             |          |       |        |      |
| External static pressure                                   |   | Pa                                     | 70 (MIN10 - MAX150)                            |              |             |                                     |             |          |       |        |      |
| Indoor Air flow  | Cooling   | m³/min (ft³/min)                       | [21/19/15 (742/671/530)]×2                     |              |             |                                     |             |          | -     | -      |      |
|  | Heating   | m³/min (ft³/min)                       | [21/19/15 (742/671/530)]×2                     |              |             |                                     |             |          | -     | -      |      |
| Outdoor Air flow   | Cooling   | m³/min (ft³/min)                       |  |              |             | 135                                 | (4767)      |          |       |        |      |
|  | Heating   | m³/min (ft³/min)                       |  |              |             | 120                                 | (4238)      |          |       |        |      |
| Refrigerant type / amount g(oz)                            |   |  |  |              | R410A       | 3.40k                               | (119.9)     |          |       |        |      |
| Product dimension  | Height  | mm(inch)                               | 290 (11-13/32)                                 |              |             | 1416 (55-3/4)                       |             |          |       |        |      |
|  | Width   | mm(inch)                               | 1000 (39-3/8)                                  |              |             | 940 (37-1/32)                       |             |          |       |        |      |
|  | Depth   | mm(inch)                               | 700 (27-9/16)                                  |              |             | 340 (13-13/32)                      |             |          |       |        |      |
| Packing dimension  | Height  | mm(inch)                               | 355  |              |             | 1556                                |             |          |       |        |      |
|  | Width   | mm(inch)                               | 1214   |              |             | 1055                                |             |          |       |        |      |
|  | Depth   | mm(inch)                               | 850  |              |             | 485                                 |             |          |       |        |      |
| Weight   | (NET)   | kg(lb)                                 | 33 (73)  |              |             | 98 (216)                            |             |          |       |        |      |
|  | (GROSS)   | kg(lb)                                 | 41 (91)  |              |             | 108 (238)                           |             |          |       |        |      |
| Layers limit (actually)                                    |   | 9 (10)                                 |  |              | 1 (2)       |                                     |             |          |       |        |      |
| Operation condition  |   | Cool (DBT)                             | 18°C ~ 32°C                                    |              |             | -10°C ~ 43°C                        |             |          |       |        |      |
|  |   | Heat (DBT)                             | 16°C ~ 30°C                                    |              |             | -15°C ~ 24°C                        |             |          |       |        |      |
| P<br>I<br>P<br>I<br>N<br>G                                 | Pipe diameter mm (inch)                             |  | (Liquid)ø9.52(3/8) (Gas)ø15.88(5/8)            |              |             | (Liquid)ø9.52(3/8) (Gas)ø15.88(5/8) |             |          |       |        |      |
|  | Connecting method, Standard length m(ft)            |  | flared type, 5.0(16.4)                         |              |             | flared type, 5.0(16.4)              |             |          |       |        |      |
|  | Pipe length range m (ft)                            |  | 5 ~ 50 (16.4 ~ 164.0)                          |              |             |                                     |             |          |       |        |      |
|  | Indoor unit & Outdoor unit height difference m (ft) |  | 15 (OD located lower) / 30 (OD located higher) |              |             | (49.2/98.4)                         |             |          |       |        |      |
|  | Add gas amount g/m (oz/ft)                          |  | 50 (0.538)                                     |              |             |                                     |             |          |       |        |      |
| Pipe length for additional gas m (ft)                      |   | 30 (98.4)                              |  |              |             |                                     |             |          |       |        |      |

\*1: In case it is necessary to indicate the air flow volume in (l/s), the value in (m³/min.) shall be multiplied by 16.7 and rounded down the decimal point.  
 \*2: If the EUROVENT Certified models can be operated under the "extra-low" temperature condition, -7°C dry bulb and -8°C wet-bulb temperatures with rated voltage 230 V shall be used.  
 \*3: Network Impedance shall be applicable for EUROPE and CHINA models.  
 \*4: The annual consumption is calculated by multiplying the input power at 230 V (400 V) by an average of 500 hours per year in cooling mode.  
 \*5: EER and COP classification is at 230 V (400 V) only in accordance with EU directive 2002/31/EC.  
 \*6: SEER and SCOP classification is at 230V(400V) only in accordance with EN-14825. For heating, SCOP indicates the value of only Average heating season.

# Single -Type

## 1-1. Unit Specifications

**PEY1**

### 10. Low Silhouette Ducted Type S-100PF1E5A / U-100PEY1E8

| INDOOR   |                    | MODEL  | S-100PF1E5A                            |          |                                     | -              |            |            | -      |       |   |
|--|--------------------|--|--|----------|-------------------------------------|----------------|------------|------------|--------|-------|---|
| PANEL  |                    | MODEL  | -                                      |          |                                     | -              |            |            | -      |       |   |
| OUTDOOR  |                    | MODEL  | -                                      |          |                                     | U-100PEY1E8    |            |            | -      |       |   |
| Branch pipe  |                    | MODEL  | -                                      |          |                                     | -              |            |            | -      |       |   |
| Performance test condition                                 |                    |  | ISO13253 / EN14511 / EN14825 / EN12102 |          |                                     |                |            |            |        |       |   |
| Power supply   |                    | Ø, Hz  | 1ø 50Hz                                |          |                                     | 3ø 50Hz        |            |            |        |       |   |
|  |                    | V  | 220                                    | 230      | 240                                 | 380            | 400        | 415        | Min    | Max   |   |
| Capacity   | kW                 | 10.0   | 10.0                                   | 10.0     | -                                   | -              | -          | -          | 2.7    | 11.5  |   |
|  | BTU/h              | 34100  | 34100                                  | 34100    | -                                   | -              | -          | -          | 9200   | 39200 |   |
| Current  |                    | A  | 1.35                                   | 1.30     | 1.27                                | 5.10           | 4.85       | 4.70       | -      | -     |   |
| Input power  | W                  | 195  | 195                                    | 195      | 3.125k                              | 3.125k         | 3.125k     | -          | -      | -     |   |
|  | TOTAL W            | -  | -                                      | -        | 3.320k                              | 3.320k         | 3.320k     | 530        | 4.200k | -     |   |
| Annual consumption   |                    | TOTAL kWh *4                                   | -                                      |          |                                     | 1660           |            |            | -      | -     | - |
| EER/EER CLASS  |                    | TOTAL (W/W) <sup>*5</sup> ("A"~"G")            | -                                      | -        | -                                   | 3.01           | 3.01 / B   | 3.01       | 5.09   | 2.74  |   |
| Erp <sup>*6</sup>  | Pdesign            | kW   | -                                      | -        | -                                   | -              | 10.0       | -          | -      | -     |   |
|  | SEER               | (W/W)  | -                                      | -        | -                                   | -              | 5.2        | -          | -      | -     |   |
|  | Annual consumption | kWh  | -                                      | -        | -                                   | -              | 673        | -          | -      | -     |   |
|  | Class              | -  | -                                      | -        | -                                   | -              | A          | -          | -      | -     |   |
| Power factor   |                    | %  | -                                      | -        | -                                   | 93             | 93         | 93         | -      | -     |   |
| Noise indoor   | dB-A (H/M/L)       | 38/34/31                                       |  |          | -                                   |                |            | -          | -      | -     |   |
|  | Power Level dB     | 60/56/53                                       |  |          | -                                   |                |            | -          | -      | -     |   |
| Noise outdoor  | dB-A (H/L)         | -  |  |          | 54/-                                |                |            | -          | -      | -     |   |
|  | Power Level dB     | -  |  |          | 70/-                                |                |            | -          | -      | -     |   |
| Capacity   | kW                 | 10.0   | 10.0                                   | 10.0     | -                                   | -              | -          | -          | 2.1    | 13.8  |   |
|  | BTU/h              | 34100  | 34100                                  | 34100    | -                                   | -              | -          | -          | 7200   | 47100 |   |
| Current  |                    | A  | 1.37                                   | 1.34     | 1.29                                | 4.05           | 3.80       | 3.65       | -      | -     |   |
| Input power  | W                  | 200  | 200                                    | 200      | 2.430k                              | 2.430k         | 2.430k     | -          | -      | -     |   |
|  | TOTAL W            | -  | -                                      | -        | 2.630k                              | 2.630k         | 2.630k     | 410        | 4.000k | -     |   |
| COP/COP CLASS  |                    | TOTAL (W/W) <sup>*5</sup> ("A"~"G")            | -                                      | -        | -                                   | 3.80           | 3.80 / A   | 3.80       | 5.12   | 3.45  |   |
| Erp <sup>*6</sup>  | Pdesign at -10°C   | kW   | -                                      | -        | -                                   | -              | 9.5        | -          | -      | -     |   |
|  | Tbivalent          | °C   | -                                      | -        | -                                   | -              | -8         | -          | -      | -     |   |
|  | SCOP               | (W/W)  | -                                      | -        | -                                   | -              | 3.8        | -          | -      | -     |   |
|  | Annual consumption | kWh  | -                                      | -        | -                                   | -              | 3500       | -          | -      | -     |   |
| Class  | -                  | -  | -                                      | -        | -                                   | A              | -          | -          | -      | -     |   |
| Power factor   |                    | %  | -                                      | -        | -                                   | 91             | 92         | 93         | -      | -     |   |
| Noise indoor   | dB-A (H/M/L)       | 38/34/31                                       |  |          | -                                   |                |            | -          | -      | -     |   |
|  | Power Level dB     | 60/56/53                                       |  |          | -                                   |                |            | -          | -      | -     |   |
| Noise outdoor  | dB-A (H/L)         | -  |  |          | 54/-                                |                |            | -          | -      | -     |   |
|  | Power Level dB     | -  |  |          | 70/-                                |                |            | -          | -      | -     |   |
| EXTRA LOW TEMP   Total capacity(kW) / Input power(W) / COP |                    |  | -                                      |          |                                     |                |            |            |        | -     |   |
| Max Current(A) / Max Input power(W)                        |                    |  | 1.80/265                               | 1.75/265 | 1.70/265                            | 9.0/5.550k     | 9.0/5.800k | 9.0/6.050k | -      |       |   |
| Starting current(A) / Comp output(W)                       |                    |  | -                                      | -        | -                                   | 5.10/1.7k      | 4.85/1.7k  | 4.70/1.7k  | -      |       |   |
| Network Impedance(ΩMAX.)                                   |                    |  | -                                      |          |                                     |                |            |            |        | -     |   |
| Fan motor output (Indoor/Outdoor) W                        |                    |  | 200                                    |          |                                     | 90             |            |            | -      |       |   |
| Moisture removal volume                                    |                    | L/h(Pt/h)                                      | 6.0 (12.6)                             |          |                                     | -              |            |            | -      |       |   |
| External static pressure                                   |                    | Pa   | 100 (MIN10 - MAX150)                   |          |                                     | -              |            |            | -      |       |   |
| Indoor Air flow  | Cooling            | m³/min (ft³/min)                               | 32/26/21 (1130/918/742)                |          |                                     | -              |            |            | -      | -     |   |
|  | Heating            | m³/min (ft³/min)                               | 32/26/21 (1130/918/742)                |          |                                     | -              |            |            | -      | -     |   |
| Outdoor Air flow   | Cooling            | m³/min (ft³/min)                               | -                                      |          |                                     | 76 (2684)      |            |            | -      | -     |   |
|  | Heating            | m³/min (ft³/min)                               | -                                      |          |                                     | 67 (2366)      |            |            | -      | -     |   |
| Refrigerant type / amount g(oz)                            |                    |  | -                                      |          |                                     | R410A          | 2.60k      | (91.7)     | -      |       |   |
| Product dimension  | Height             | mm(inch)                                       | 290 (11-13/32)                         |          |                                     | 996 (39-7/32)  |            |            | -      |       |   |
|  | Width              | mm(inch)                                       | 1400 (55-1/8)                          |          |                                     | 940 (37-1/32)  |            |            | -      |       |   |
|  | Depth              | mm(inch)                                       | 700 (27-9/16)                          |          |                                     | 340 (13-13/32) |            |            | -      |       |   |
| Packing dimension  | Height             | mm(inch)                                       | 355                                    |          |                                     | 1136           |            |            | -      |       |   |
|  | Width              | mm(inch)                                       | 1614                                   |          |                                     | 1055           |            |            | -      |       |   |
|  | Depth              | mm(inch)                                       | 850                                    |          |                                     | 485            |            |            | -      |       |   |
| Weight   | (NET)              | kg(lb)   | 45 (99)                                |          |                                     | 73 (161)       |            |            | -      |       |   |
|  | (GROSS)            | kg(lb)   | 54 (119)                               |          |                                     | 81 (179)       |            |            | -      |       |   |
| Layers limit (actually)                                    |                    |  | 9 (10)                                 |          |                                     | 2 (3)          |            |            | -      |       |   |
| Operation condition  |                    | Cool (DBT)                                     | 18°C ~ 32°C                            |          |                                     | -10°C ~ 43°C   |            |            | -      |       |   |
|  |                    | Heat (DBT)                                     | 16°C ~ 30°C                            |          |                                     | -15°C ~ 24°C   |            |            | -      |       |   |
| Pipe diameter mm (inch)                                    |                    | (Liquid)ø9.52(3/8) (Gas)ø15.88(5/8)            |  |          | (Liquid)ø9.52(3/8) (Gas)ø15.88(5/8) |                |            | -          |        |       |   |
| Connecting method, Standard length m(ft)                   |                    | flared type, 5.0(16.4)                         |  |          | flared type, 5.0(16.4)              |                |            | -          |        |       |   |
| Pipe length range m (ft)                                   |                    | 5 ~ 50 (16.4 ~ 164.0)                          |  |          | -                                   |                |            | -          |        |       |   |
| Indoor unit & Outdoor unit height difference m (ft)        |                    | 15 (OD located lower) / 30 (OD located higher) |  |          | (49.2/98.4)                         |                |            | -          |        |       |   |
| Add gas amount g/m (oz/ft)                                 |                    | 50 (0.538)                                     |  |          | -                                   |                |            | -          |        |       |   |
| Pipe length for additional gas m (ft)                      |                    | 30 (98.4)                                      |  |          | -                                   |                |            | -          |        |       |   |

\*1: In case it is necessary to indicate the air flow volume in (l/s), the value in (m³/min.) shall be multiplied by 16.7 and rounded down the decimal point.

\*2: If the EUROVENT Certified models can be operated under the "extra-low" temperature condition, -7°C dry bulb and -8°C wet-bulb temperatures with rated voltage 230 V shall be used.

\*3: Network Impedance shall be applicable for EUROPE and CHINA models.

\*4: The annual consumption is calculated by multiplying the input power at 230 V (400 V) by an average of 500 hours per year in cooling mode.

\*5: EER and COP classification is at 230 V (400 V) only in accordance with EU directive 2002/31/EC.

\*6: SEER and SCOP classification is at 230V(400V) only in accordance with EN-14825. For heating, SCOP indicates the value of only Average heating season, Other fiche data indicates in an attached sheet.

# Single -Type

## 1-1. Unit Specifications

**PEY1**

### 10. Low Silhouette Ducted Type S-125PF1E5A / U-125PEY1E8

| INDOOR   |  | MODEL  | S-125PF1E5A                            |                       |                      | -                                   |             |             | -     |        |      |
|--|--|--|--|-----------------------|----------------------|-------------------------------------|-------------|-------------|-------|--------|------|
| PANEL  |  | MODEL  | -                                      |                       |                      | -                                   |             |             | -     |        |      |
| OUTDOOR  |  | MODEL  | -                                      |                       |                      | U-125PEY1E8                         |             |             | -     |        |      |
| Branch pipe  |  | MODEL  | -                                      |                       |                      | -                                   |             |             | -     |        |      |
| Performance test condition                                 |  |  | ISO13253 / EN14511 / EN12102 / EN14825 |                       |                      |                                     |             |             |       |        |      |
| Power supply   |  | Ø, Hz  | 1ø 50Hz                                |                       |                      | 3ø 50Hz                             |             |             |       |        |      |
|  |  | V  | 220                                    | 230                   | 240                  | 380                                 | 400         | 415         | Min   | Max    |      |
| C<br>O<br>O<br>L<br>I<br>N<br>G                            | Capacity                                 | kW   | 12.5                                   | 12.5                  | 12.5                 | -                                   | -           | -           | 3.8   | 13.5   |      |
|  |  | BTU/h  | 42700                                  | 42700                 | 42700                | -                                   | -           | -           | 13000 | 46100  |      |
|  | Current                                  | A  | 1.48                                   | 1.44                  | 1.39                 | 6.20                                | 5.90        | 5.70        | -     | -      |      |
|  |  | W  | 215                                    | 215                   | 215                  | 3.885k                              | 3.885k      | 3.885k      | -     | -      |      |
|  | Input power                              | TOTAL W  | -                                      |                       |                      | 4.100k                              | 4.100k      | 4.100k      | 900   | 5.000k |      |
|  |  | Annual consumption                             | TOTAL kWh *4                           | -                     |                      |                                     | -           | 2050        | -     | -      | -    |
|  | EER/EER CLASS                            | TOTAL (W/W) <sup>*5</sup> ("A"~"G")            | -                                      | -                     | -                    | 3.05                                | 3.05 / B    | 3.05        | 4.22  | 2.70   |      |
|  | E <sub>rs</sub>                          | Pdesign  | kW                                     | -                     | -                    | -                                   | -           | 12.5        | -     | -      | -    |
|  |  | η <sub>s,c</sub>                               | %                                      | -                     | -                    | -                                   | -           | 200.8       | -     | -      | -    |
|  |  | Annual consumption                             | kWh                                    | -                     | -                    | -                                   | -           | -           | -     | -      | -    |
| Class  |  |  | -                                      | -                     | -                    | -                                   | -           | -           | -     | -      |      |
| Power factor   | %  | -  | -                                      | -                     | 95                   | 95                                  | 95          | -           | -     |        |      |
| Noise indoor   | dB-A (H/M/L)                             | 39/35/32                                       |  |                       | -                    |                                     |             | -           | -     |        |      |
|  | Power Level dB                           | 61/57/54                                       |  |                       | -                    |                                     |             | -           | -     |        |      |
| Noise outdoor  | dB-A (H/L)                               | -  |  |                       | 56/-                 |                                     |             | -           | -     |        |      |
|  | Power Level dB                           | -  |  |                       | 73/-                 |                                     |             | -           | -     |        |      |
| H<br>E<br>A<br>T<br>I<br>N<br>G                            | Capacity                                 | kW   | 12.5                                   | 12.5                  | 12.5                 | -                                   | -           | -           | 3.4   | 15.0   |      |
|  |  | BTU/h  | 42700                                  | 42700                 | 42700                | -                                   | -           | -           | 11600 | 51200  |      |
|  | Current                                  | A  | 1.46                                   | 1.42                  | 1.38                 | 4.90                                | 4.65        | 4.50        | -     | -      |      |
|  |  | W  | 210                                    | 210                   | 210                  | 3.060k                              | 3.060k      | 3.060k      | -     | -      |      |
|  | Input power                              | TOTAL W  | -                                      |                       |                      | 3.270k                              | 3.270k      | 3.270k      | 730   | 4.400k |      |
|  |  | COP/COP CLASS                                  | TOTAL (W/W) <sup>*5</sup> ("A"~"G")    | -                     | -                    | -                                   | 3.82        | 3.82 / A    | 3.82  | 4.66   | 3.41 |
|  | E <sub>rs</sub>                          | Pdesign at -10°C                               | kW                                     | -                     | -                    | -                                   | -           | 12.5        | -     | -      | -    |
|  |  | Tbivalent                                      | °C                                     | -                     | -                    | -                                   | -           | -7          | -     | -      | -    |
|  |  | η <sub>s,h</sub>                               | %                                      | -                     | -                    | -                                   | -           | 140.9       | -     | -      | -    |
|  |  | Annual consumption                             | kWh                                    | -                     | -                    | -                                   | -           | -           | -     | -      | -    |
| Class  |  | -  | -                                      | -                     | -                    | -                                   | -           | -           | -     |        |      |
| Power factor   | %  | -  | -                                      | -                     | 95                   | 95                                  | 95          | -           | -     |        |      |
| Noise indoor   | dB-A (H/M/L)                             | 39/35/32                                       |  |                       | -                    |                                     |             | -           | -     |        |      |
|  | Power Level dB                           | 61/57/54                                       |  |                       | -                    |                                     |             | -           | -     |        |      |
| Noise outdoor  | dB-A (H/L)                               | -  |  |                       | 56/-                 |                                     |             | -           | -     |        |      |
|  | Power Level dB                           | -  |  |                       | 73/-                 |                                     |             | -           | -     |        |      |
| EXTRA LOW TEMP   Total capacity(kW) / Input power(W) / COP |  |  | -                                      |                       |                      | -                                   |             |             | -     |        |      |
| Max Current(A) / Max Input power(W)                        |  |  | 1.80/265                               | 1.75/265              | 1.70/265             | 10.0/6.200k                         | 10.0/6.500k | 10.0/6.750k | -     |        |      |
| Starting current(A) / Comp output(W)                       |  |  | -                                      | -                     | -                    | 6.20/3.0k                           | 5.90/3.0k   | 5.70/3.0k   | -     |        |      |
| Network Impedance(ΩMAX.)                                   |  |  | -                                      |                       |                      | -                                   |             |             | -     |        |      |
| Fan motor output (Indoor/Outdoor) W                        |  |  | 200                                    |                       |                      | 90                                  |             |             | -     |        |      |
| Moisture removal volume                                    |  |  | L/h(Pt/h)                              |                       | 7.9                  | (16.6)                              |             | -           |       |        |      |
| External static pressure                                   |  |  | Pa                                     |                       | 100 (MIN10 - MAX150) |                                     |             | -           |       |        |      |
| Indoor Air flow  | Cooling                                  | m³/min (ft³/min)                               | 34/29/23 (1201/1024/812)               |                       |                      | -                                   |             |             | -     |        |      |
|  | Heating                                  | m³/min (ft³/min)                               | 34/29/23 (1201/1024/812)               |                       |                      | -                                   |             |             | -     |        |      |
| Outdoor Air flow   | Cooling                                  | m³/min (ft³/min)                               | -                                      |                       |                      | 80                                  |             | (2825)      |       |        |      |
|  | Heating                                  | m³/min (ft³/min)                               | -                                      |                       |                      | 73                                  |             | (2578)      |       |        |      |
| Refrigerant type / amount g(oz)                            |  |  | -                                      |                       |                      | R410A                               | 3.20k       | (112.9)     |       |        |      |
| Product dimension  | Height                                   | mm(inch)                                       | 290 (11-13/32)                         |                       |                      | 996 (39-7/32)                       |             |             | -     |        |      |
|  | Width                                    | mm(inch)                                       | 1400 (55-1/8)                          |                       |                      | 940 (37-1/32)                       |             |             | -     |        |      |
|  | Depth                                    | mm(inch)                                       | 700 (27-9/16)                          |                       |                      | 340 (13-13/32)                      |             |             | -     |        |      |
| Packing dimension  | Height                                   | mm(inch)                                       | 355                                    |                       |                      | 1136                                |             |             | -     |        |      |
|  | Width                                    | mm(inch)                                       | 1614                                   |                       |                      | 1055                                |             |             | -     |        |      |
|  | Depth                                    | mm(inch)                                       | 850                                    |                       |                      | 485                                 |             |             | -     |        |      |
| Weight   | (NET)                                    | kg(lb)   | 45 (99)                                |                       |                      | 85 (187)                            |             |             | -     |        |      |
|  | (GROSS)                                  | kg(lb)   | 54 (119)                               |                       |                      | 93 (205)                            |             |             | -     |        |      |
| Layers limit (actually)                                    |  |  | 9 (10)                                 |                       |                      | 2 (3)                               |             |             | -     |        |      |
| Operation condition  |  | Cool (DBT)                                     | 18°C ~ 32°C                            |                       |                      | -10°C ~ 43°C                        |             |             | -     |        |      |
|  |  | Heat (DBT)                                     | 16°C ~ 30°C                            |                       |                      | -15°C ~ 24°C                        |             |             | -     |        |      |
| P<br>I<br>P<br>I<br>N<br>G                                 | Pipe diameter mm (inch)                  |  | (Liquid)ø9.52(3/8) (Gas)ø15.88(5/8)    |                       |                      | (Liquid)ø9.52(3/8) (Gas)ø15.88(5/8) |             |             | -     |        |      |
|  | Connecting method, Standard length m(ft) |  | flared type, 5.0(16.4)                 |                       |                      | flared type, 5.0(16.4)              |             |             | -     |        |      |
| Pipe length range  |  | m (ft)   |  | 5 ~ 50 (16.4 ~ 164.0) |                      | -                                   |             |             |       |        |      |
| Indoor unit & Outdoor unit height difference m (ft)        |  | 15 (OD located lower) / 30 (OD located higher) |  |                       | (49.2/98.4)          |                                     |             | -           |       |        |      |
| Add gas amount g/m (oz/ft)                                 |  | 50 (0.538)                                     |  |                       | -                    |                                     |             |             |       |        |      |
| Pipe length for additional gas                             |  | m (ft)   |  | 30 (98.4)             |                      | -                                   |             |             |       |        |      |

\*1: In case it is necessary to indicate the air flow volume in (l/s), the value in (m³/min.) shall be multiplied by 16.7 and rounded down the decimal point.

\*2: If the EUROVENT Certified models can be operated under the "extra-low" temperature condition, -7°C dry bulb and -8°C wet-bulb temperatures with rated voltage 230 V shall be used.

\*3: Network Impedance shall be applicable for EUROPE and CHINA models.

\*4: The annual consumption is calculated by multiplying the input power at 230 V (400 V) by an average of 500 hours per year in cooling mode.

\*5: EER and COP classification is at 230 V (400 V) only in accordance with EU directive 2002/31/EC.

\*6: SEER and SCOP classification is at 230V(400V) only in accordance with EN-14825. For heating, SCOP indicates the value of only Average heating season.

# Single -Type

## 1-1. Unit Specifications

**PEY1**

### 10. Low Silhouette Ducted Type S-140PF1E5A / U-140PEY1E8

| INDOOR   |   | MODEL                    | S-140PF1E5A                                    |          |          | -                                   |             |             | -     |        |   |
|--|---|--------------------------|--|----------|----------|-------------------------------------|-------------|-------------|-------|--------|---|
| PANEL  |   | MODEL                    | -  |          |          | -                                   |             |             | -     |        |   |
| OUTDOOR  |   | MODEL                    | -  |          |          | U-140PEY1E8                         |             |             | -     |        |   |
| Branch pipe  |   | MODEL                    | -  |          |          | -                                   |             |             | -     |        |   |
| Performance test condition                                 |   |                          | ISO13253 / EN14511 / EN12102 / EN14825         |          |          |                                     |             |             |       |        |   |
| Power supply   |   | Ø, Hz                    | 1ø 50Hz  |          |          | 3ø 50Hz                             |             |             |       |        |   |
|  |   | V                        | 220  | 230      | 240      | 380                                 | 400         | 415         | Min   | Max    |   |
| Capacity   |   | kW                       | 14.0   | 14.0     | 14.0     | -                                   | -           | -           | 3.3   | 15.5   |   |
|  |   | BTU/h                    | 47800  | 47800    | 47800    | -                                   | -           | -           | 11300 | 52900  |   |
| Current  |   | A                        | 1.55   | 1.50     | 1.47     | 6.75                                | 6.45        | 6.25        | -     | -      |   |
| Input power  |   | W                        | 225  | 225      | 225      | 4.125k                              | 4.125k      | 4.125k      | -     | -      |   |
|  |   | TOTAL W                  | -  |          |          | 4.350k                              | 4.350k      | 4.350k      | 840   | 6.000k |   |
| Annual consumption   |   | TOTAL kWh *4             | -  |          |          | 2175                                |             |             | -     | -      |   |
| EER/EER CLASS  |   | TOTAL (W/W) *5/ ("A"-*G) | -  | -        | -        | 3.22                                | 3.22 / A    | 3.22        | 3.93  | 2.58   |   |
| C<br>O<br>O<br>L<br>I<br>N<br>G                            | Erp *6  | Pdesign                  | kW   | -        | -        | -                                   | -           | 14.0        | -     | -      |   |
|  |   | η <sub>s.c</sub>         | %  | -        | -        | -                                   | -           | 209.4       | -     | -      |   |
|  | Annual consumption                                  |                          | kWh  | -        | -        | -                                   | -           | -           | -     | -      |   |
|  | Class   |                          |  | -        | -        | -                                   | -           | -           | -     | -      |   |
|  | Power factor  |                          | %  | -        | -        | -                                   | 93          | 92          | 92    | -      | - |
| Noise indoor   |   | dB-A (H/M/L)             | 40/36/33                                       |          |          | -                                   |             |             | -     | -      |   |
|  |   | Power Level dB           | 62/58/55                                       |          |          | -                                   |             |             | -     | -      |   |
| Noise outdoor  |   | dB-A (H/L)               | -  |          |          | 54/-                                |             |             | -     | -      |   |
|  |   | Power Level dB           | -  |          |          | 71/-                                |             |             | -     | -      |   |
| Capacity   |   | kW                       | 14.0   | 14.0     | 14.0     | -                                   | -           | -           | 4.1   | 16.0   |   |
|  |   | BTU/h                    | 47800  | 47800    | 47800    | -                                   | -           | -           | 14000 | 54600  |   |
| Current  |   | A                        | 1.55   | 1.50     | 1.46     | 5.60                                | 5.40        | 5.20        | -     | -      |   |
| Input power  |   | W                        | 225  | 225      | 225      | 3.355k                              | 3.355k      | 3.355k      | -     | -      |   |
|  |   | TOTAL W                  | -  |          |          | 3.580k                              | 3.580k      | 3.580k      | 900   | 5.200k |   |
| COP/COP CLASS  |   | TOTAL (W/W) *5/ ("A"-*G) | -  | -        | -        | 3.91                                | 3.91 / A    | 3.91        | 4.56  | 3.08   |   |
| H<br>E<br>A<br>T<br>I<br>N<br>G                            | Erp *6  | Pdesign at -10°C         | kW   | -        | -        | -                                   | -           | 14.0        | -     | -      |   |
|  |   | Tbivalent                | °C   | -        | -        | -                                   | -           | -7          | -     | -      |   |
|  | η <sub>s.h</sub>                                    | %                        | -  | -        | -        | -                                   | 138.0       | -           | -     |        |   |
|  | Annual consumption                                  |                          | kWh  | -        | -        | -                                   | -           | -           | -     | -      |   |
|  | Class   |                          |  | -        | -        | -                                   | -           | -           | -     | -      |   |
| Power factor   |   | %                        | -  | -        | -        | 91                                  | 90          | 90          | -     | -      |   |
| Noise indoor   |   | dB-A (H/M/L)             | 40/36/33                                       |          |          | -                                   |             |             | -     | -      |   |
|  |   | Power Level dB           | 62/58/55                                       |          |          | -                                   |             |             | -     | -      |   |
| Noise outdoor  |   | dB-A (H/L)               | -  |          |          | 53/-                                |             |             | -     | -      |   |
|  |   | Power Level dB           | -  |          |          | 70/-                                |             |             | -     | -      |   |
| EXTRA LOW TEMP   Total capacity(kW) / Input power(W) / COP |   |                          | -  |          |          |                                     |             |             |       | -      |   |
| Max Current(A) / Max Input power(W)                        |   |                          | 1.91/285                                       | 1.86/285 | 1.81/285 | 10.0/6.200k                         | 10.0/6.500k | 10.0/6.750k | -     |        |   |
| Starting current(A) / Comp output(W)                       |   |                          | -  | -        | -        | 6.75/3.0k                           | 6.45/3.0k   | 6.25/3.0k   | -     |        |   |
| Network Impedance(ΩMAX.)                                   |   |                          | -  |          |          |                                     |             |             |       | -      |   |
| Fan motor output (Indoor/Outdoor) W                        |   |                          | 200  |          |          | 90×2                                |             |             | -     |        |   |
| Moisture removal volume                                    |   | L/h(Pt/h)                | 9.0  | (18.9)   |          | -                                   |             |             | -     |        |   |
| External static pressure                                   |   | Pa                       | 100 (MIN10 - MAX150)                           |          |          | -                                   |             |             | -     |        |   |
| Indoor Air flow  | Cooling   | m³/min (ft³/min)         | 36/32/25 (1271/1130/883)                       |          |          | -                                   |             |             | -     |        |   |
|  | Heating   | m³/min (ft³/min)         | 36/32/25 (1271/1130/883)                       |          |          | -                                   |             |             | -     |        |   |
| Outdoor Air flow   | Cooling   | m³/min (ft³/min)         | -  |          |          | 135                                 | (4767)      |             | -     |        |   |
|  | Heating   | m³/min (ft³/min)         | -  |          |          | 120                                 | (4238)      |             | -     |        |   |
| Refrigerant type / amount g(oz)                            |   |                          | -  |          |          | R410A                               | 3.40k       | (119.9)     | -     |        |   |
| Product dimension  |   | Height mm(inch)          | 290 (11-13/32)                                 |          |          | 1416 (55-3/4)                       |             |             | -     |        |   |
|  |   | Width mm(inch)           | 1400 (55-1/8)                                  |          |          | 940 (37-1/32)                       |             |             | -     |        |   |
|  |   | Depth mm(inch)           | 700 (27-9/16)                                  |          |          | 340 (13-13/32)                      |             |             | -     |        |   |
| Packing dimension  |   | Height mm(inch)          | 355  |          |          | 1556                                |             |             | -     |        |   |
|  |   | Width mm(inch)           | 1614   |          |          | 1055                                |             |             | -     |        |   |
|  |   | Depth mm(inch)           | 850  |          |          | 485                                 |             |             | -     |        |   |
| Weight   |   | (NET) kg(lb)             | 45 (99)  |          |          | 98 (216)                            |             |             | -     |        |   |
|  |   | (GROSS) kg(lb)           | 54 (119)                                       |          |          | 108 (238)                           |             |             | -     |        |   |
| Layers limit (actually)                                    |   |                          | 9 (10)   |          |          | 1 (2)                               |             |             | -     |        |   |
| Operation condition  |   | Cool (DBT)               | 18°C ~ 32°C                                    |          |          | -10°C ~ 43°C                        |             |             | -     |        |   |
|  |   | Heat (DBT)               | 16°C ~ 30°C                                    |          |          | -15°C ~ 24°C                        |             |             | -     |        |   |
| P<br>I<br>P<br>E<br>I<br>N<br>G                            | Pipe diameter mm (inch)                             |                          | (Liquid)ø9.52(3/8) (Gas)ø15.88(5/8)            |          |          | (Liquid)ø9.52(3/8) (Gas)ø15.88(5/8) |             |             | -     |        |   |
|  | Connecting method, Standard length m(ft)            |                          | flared type, 5.0(16.4)                         |          |          | flared type, 5.0(16.4)              |             |             | -     |        |   |
|  | Pipe length range m (ft)                            |                          | 5 ~ 50 (16.4 ~ 164.0)                          |          |          | -                                   |             |             | -     |        |   |
|  | Indoor unit & Outdoor unit height difference m (ft) |                          | 15 (OD located lower) / 30 (OD located higher) |          |          | (49.2/98.4)                         |             |             | -     |        |   |
|  | Add gas amount g/m (oz/ft)                          |                          | 50 (0.538)                                     |          |          | -                                   |             |             | -     |        |   |
| Pipe length for additional gas m (ft)                      |   | 30 (98.4)                |  |          | -        |                                     |             | -           |       |        |   |

\*1: In case it is necessary to indicate the air flow volume in (l/s), the value in (m³/min.) shall be multiplied by 16.7 and rounded down the decimal point.

\*2: If the EUROVENT Certified models can be operated under the "extra-low" temperature condition, -7°C dry bulb and -8°C wet-bulb temperatures with rated voltage 230 V shall be used.

\*3: Network Impedance shall be applicable for EUROPE and CHINA models.

\*4: The annual consumption is calculated by multiplying the input power at 230 V (400 V) by an average of 500 hours per year in cooling mode.

\*5: EER and COP classification is at 230 V (400 V) only in accordance with EU directive 2002/31/EC.

\*6: SEER and SCOP classification is at 230V(400V) only in accordance with EN-14825. For heating, SCOP indicates the value of only Average heating season.



# Simultaneous (Twin) -Type

## 1-1. Unit Specifications

**PEY1**

### 11. Ducted Type S-50PN1E5A×2 / U-100PEY1E5

|   |   |  |                            |                     |                                     |                |             |      |        |      |
|---|---|--|----------------------------|---------------------|-------------------------------------|----------------|-------------|------|--------|------|
| INDOOR  | MODEL   | S-50PN1E5A×2                                   |                            |                     | -                                   |                |             | -    |        |      |
| PANEL   | MODEL   | -  |                            |                     | -                                   |                |             | -    |        |      |
| OUTDOOR   | MODEL   | -  |                            |                     | U-100PEY1E5                         |                |             | -    |        |      |
| Branch pipe   | MODEL   | -  |                            |                     | CZ-P155BK1                          |                |             | -    |        |      |
| Performance test condition  |   | ISO13253 / EN14511 / EN14825 / EN12102         |                            |                     |                                     |                |             |      |        |      |
| Power supply  | Ø, Hz   | 1ø 50Hz  |                            |                     | 1ø 50Hz                             |                |             |      |        |      |
|   | V   | 220  | 230                        | 240                 | 220                                 | 230            | 240         | Min  | Max    |      |
| Capacity  | kW  | 10.0   | 10.0                       | 10.0                | -                                   | -              | -           | 2.7  | 11.5   |      |
|   | BTU/h   | 34100  | 34100                      | 34100               | -                                   | -              | -           | 9200 | 39200  |      |
| Current   | A   | 0.54×2   | 0.55×2                     | 0.56×2              | 15.9                                | 15.2           | 14.7        | -    | -      |      |
|   | W   | 115×2  | 120×2                      | 125×2               | 3.320k                              | 3.320k         | 3.320k      | -    | -      |      |
| Input power   | TOTAL W   | -  |                            |                     | 3.550k                              | 3.560k         | 3.570k      | 570  | 4.300k |      |
|   | Annual consumption                                  | -  |                            |                     | -                                   | 1780           | -           | -    | -      |      |
| EER/EER CLASS   | TOTAL (W/W) <sup>*2</sup> ("A"~"G")                 | -  | -                          | -                   | 2.82                                | 2.81 / C       | 2.80        | 4.74 | 2.67   |      |
| E <sub>rp</sub> <sup>*3</sup>   | Pdesign   | kW   | -                          | -                   | -                                   | 10.0           | -           | -    | -      |      |
|   | SEER  | (W/W)  | -                          | -                   | -                                   | 4.9            | -           | -    | -      |      |
|   | Annual consumption                                  | kWh  | -                          | -                   | -                                   | 715            | -           | -    | -      |      |
|   | Class   |  | -                          | -                   | -                                   | B              | -           | -    | -      |      |
| Power factor  | %   | -  | -                          | -                   | 95                                  | 95             | 94          | -    | -      |      |
| Noise indoor  | dB-A (H/M/L)  | 41/39/35                                       |                            |                     | -                                   |                |             | -    | -      |      |
|   | Power Level dB                                      | 58/56/52                                       |                            |                     | -                                   |                |             | -    | -      |      |
| Noise outdoor   | dB-A (H/L)  | -  |                            |                     | 54/-                                |                |             | -    | -      |      |
|   | Power Level dB                                      | -  |                            |                     | 70/-                                |                |             | -    | -      |      |
| Capacity  | kW  | 10.0   | 10.0                       | 10.0                | -                                   | -              | -           | 2.1  | 13.8   |      |
|   | BTU/h   | 34100  | 34100                      | 34100               | -                                   | -              | -           | 7200 | 47100  |      |
| Current   | A   | 0.54×2   | 0.55×2                     | 0.56×2              | 12.9                                | 12.3           | 11.9        | -    | -      |      |
|   | W   | 115×2  | 120×2                      | 125×2               | 2.690k                              | 2.690k         | 2.690k      | -    | -      |      |
| Input power   | TOTAL W   | -  |                            |                     | 2.920k                              | 2.930k         | 2.940k      | 450  | 4.100k |      |
|   | COP/COP CLASS                                       | TOTAL (W/W) <sup>*5</sup> ("A"~"G")            | -                          | -                   | -                                   | 3.42           | 3.41 / B    | 3.40 | 4.67   | 3.37 |
| E <sub>rp</sub> <sup>*3</sup>   | Pdesign at -10°C                                    | kW   | -                          | -                   | -                                   | 7.5            | -           | -    | -      |      |
|   | Tbivalent   | °C   | -                          | -                   | -                                   | -9             | -           | -    | -      |      |
|   | SCOP  | (W/W)  | -                          | -                   | -                                   | 3.8            | -           | -    | -      |      |
|   | Annual consumption                                  | kWh  | -                          | -                   | -                                   | 2761           | -           | -    | -      |      |
| Class   |   | -  | -                          | -                   | A                                   | -              | -           | -    | -      |      |
| Power factor  | %   | -  | -                          | -                   | 95                                  | 95             | 94          | -    | -      |      |
| Noise indoor  | dB-A (H/M/L)  | 41/39/35                                       |                            |                     | -                                   |                |             | -    | -      |      |
|   | Power Level dB                                      | 58/56/52                                       |                            |                     | -                                   |                |             | -    | -      |      |
| Noise outdoor   | dB-A (H/L)  | -  |                            |                     | 54/-                                |                |             | -    | -      |      |
|   | Power Level dB                                      | -  |                            |                     | 70/-                                |                |             | -    | -      |      |
| EXTRA LOW TEMP <sup>6</sup> Total capacity(kW) / Input power(W) / COP |   | -  |                            |                     |                                     |                |             |      |        |      |
| Max Current(A) / Max Input power(W)                                   |   | 0.74×2/165×2                                   | 0.76×2/180×2               | 0.78×2/190×2        | 25.0/5.300k                         | 25.0/5.500k    | 25.0/5.700k | -    |        |      |
| Starting current(A) / Comp output(W)                                  |   | -  | -                          | -                   | 15.9/1.7k                           | 15.2/1.7k      | 14.7/1.7k   | -    |        |      |
| Network Impedance(ΩMAX.)  |   | -  |                            |                     | -                                   |                |             | -    |        |      |
| Fan motor output (Indoor/Outdoor) W                                   |   | 85×2   |                            |                     | 90                                  |                |             | -    |        |      |
| Moisture removal volume   |   | L/h(Pt/h)                                      | 6.0                        | (3.0×2)             | (12.6)                              | -              |             |      | -      |      |
| External static pressure  |   | Pa   | 50 (MIN10 - MAX80)         |                     |                                     | -              |             |      | -      |      |
| Indoor Air flow   | Cooling   | m³/min (ft³/min)                               | [16/13/11 (565/459/388)]×2 |                     |                                     | -              |             |      | -      |      |
|   | Heating   | m³/min (ft³/min)                               | [16/13/11 (565/459/388)]×2 |                     |                                     | -              |             |      | -      |      |
| Outdoor Air flow  | Cooling   | m³/min (ft³/min)                               | -                          |                     |                                     | 76             | (2684)      | -    |        |      |
|   | Heating   | m³/min (ft³/min)                               | -                          |                     |                                     | 67             | (2366)      | -    |        |      |
| Refrigerant type / amount g(oz)                                       |   | -  |                            |                     | R410A                               | 2.60k          | (91.7)      | -    |        |      |
| Product dimension   | Height  | mm(inch)                                       | 250 (9-27/32)              |                     |                                     | 996 (39-7/32)  |             |      | -      |      |
|   | Width   | mm(inch)                                       | 780 (+100)                 | 30-23/32 (+3-15/16) |                                     | 940 (37-1/32)  |             |      | -      |      |
|   | Depth   | mm(inch)                                       | 650 (25-19/32)             |                     |                                     | 340 (13-13/32) |             |      | -      |      |
| Packing dimension   | Height  | mm(inch)                                       | 345                        |                     |                                     | 1136           |             |      | -      |      |
|   | Width   | mm(inch)                                       | 1007                       |                     |                                     | 1055           |             |      | -      |      |
|   | Depth   | mm(inch)                                       | 777                        |                     |                                     | 485            |             |      | -      |      |
| Weight  | (NET)   | kg(lb)   | 29 (64)                    |                     |                                     | 73 (161)       |             |      | -      |      |
|   | (GROSS)   | kg(lb)   | 34 (75)                    |                     |                                     | 81 (179)       |             |      | -      |      |
| Layers limit (actually)   |   | 8 (9)  |                            |                     | 2 (3)                               |                |             | -    |        |      |
| Operation condition   | Cool (DBT)  | 18°C ~ 32°C                                    |                            |                     | -10°C ~ 43°C                        |                |             | -    |        |      |
|   | Heat (DBT)  | 16°C ~ 30°C                                    |                            |                     | -15°C ~ 24°C                        |                |             | -    |        |      |
| P I P I N G   | Pipe diameter mm (inch)                             | (Liquid)ø6.35(1/4) (Gas)ø12.7(1/2)             |                            |                     | (Liquid)ø9.52(3/8) (Gas)ø15.88(5/8) |                |             | -    |        |      |
|   | Connecting method, Standard length m(ft)            | flared type, 5.0(16.4)                         |                            |                     | flared type, 5.0(16.4)              |                |             | -    |        |      |
| I N G   | Pipe length range                                   | m (ft)   |                            |                     | 5 ~ 50 (16.4 ~ 164.0)               |                |             | -    |        |      |
|   | Indoor unit & Outdoor unit height difference m (ft) | 15 (OD located lower) / 30 (OD located higher) |                            |                     | (49.2/98.4)                         |                |             | -    |        |      |
| N G   | Add gas amount g/m (oz/ft)                          | 50   |                            |                     | (0.538)                             |                |             | -    |        |      |
|   | Pipe length for additional gas                      | m (ft)   |                            |                     | 30 (98.4)                           |                |             | -    |        |      |

\*1: In case it is necessary to indicate the air flow volume in (l/s), the value in (m³/min.) shall be multiplied by 16.7 and rounded down the decimal point.  
 \*2: If the EUROVENT Certified models can be operated under the "extra-low" temperature condition, -7°C dry bulb and -8°C wet-bulb temperatures with rated voltage 230 V shall be used.  
 \*3: Network Impedance shall be applicable for EUROPE and CHINA models.  
 \*4: The annual consumption is calculated by multiplying the input power at 230 V (400 V) by an average of 500 hours per year in cooling mode.  
 \*5: EER and COP classification is at 230 V (400 V) only in accordance with EU directive 2002/31/EC.  
 \*6: SEER and SCOP classification is at 230V(400V) only in accordance with EN-14825. For heating, SCOP indicates the value of only Average heating season, Other fiche data indicates in an attached sheet.

# Single-Type

## 1-1. Unit Specifications

### PEY2

#### 11. Ducted Type S-60PN1E5A / U-60PEY2E5

| INDOOR   | MODEL                                    | S-60PN1E5A                                       |                                       |          | -                                   |              |            | -      |      |        |
|--|--|--|---------------------------------------|----------|-------------------------------------|--------------|------------|--------|------|--------|
| PANEL  | MODEL                                    | -  |                                       |          | -                                   |              |            | -      |      |        |
| OUTDOOR  | MODEL                                    | -  |                                       |          | U-60PEY2E5                          |              |            | -      |      |        |
| Branch pipe  | MODEL                                    | -  |                                       |          | -                                   |              |            | -      |      |        |
| Performance test condition                                 |  | ISO13253 / EN14511 / EN12102 / EN14825           |                                       |          |                                     |              |            |        |      |        |
| Power supply   |  | Ø, Hz  | 1ø 50Hz                               |          |                                     | 1ø 50Hz      |            |        | Min  | Max    |
|  |  | V  | 220V                                  | 230V     | 240V                                | 220V         | 230V       | 240V   |      |        |
| C<br>O<br>O<br>L<br>I<br>N<br>G                            | Capacity                                 | kW   | 6.0                                   | 6.0      | 6.0                                 | -            | -          | -      | 2.0  | 7.1    |
|  |  | BTU/h  | 20500                                 | 20500    | 20500                               | -            | -          | -      | 6800 | 24200  |
|  | Current                                  | A  | 1.12                                  | 1.08     | 1.04                                | 8.70         | 8.40       | 8.00   | -    | -      |
|  | Input power                              | W  | 140                                   | 140      | 140                                 | 1.730k       | 1.730k     | 1.730k | -    | -      |
|  |  | TOTAL W  | -                                     |          |                                     | 1.870k       | 1.870k     | 1.870k | 400  | 2.550k |
|  | Annual consumption                       | TOTAL kWh *4                                     | -                                     |          |                                     | -            | 935        | -      | -    | -      |
|  | EER/EER CLASS                            | TOTAL (W/W) <sup>25</sup> ("A"~"G")              | -                                     | -        | -                                   | 3.21         | 3.21/A     | 3.21   | 5.00 | 2.78   |
|  | Erp <sup>*6</sup>                        | Pdesign  | kW                                    | -        | -                                   | -            | -          | 6.0    | -    | -      |
|  |  | SEER   | (W/W)                                 | -        | -                                   | -            | -          | 4.8    | -    | -      |
|  |  | Annual consumption                               | kWh                                   | -        | -                                   | -            | -          | 437    | -    | -      |
| Class  |  |  | -                                     | -        | -                                   | -            | B          | -      | -    |        |
| Power factor   | %  | -  | -                                     | -        | 90                                  | 90           | 90         | -      | -    |        |
| Noise indoor   | dB-A (H/M/L)                             | 43/41/36   |                                       |          | -                                   |              |            | -      | -    |        |
|  | Power Level dB                           | 60/58/53   |                                       |          | -                                   |              |            | -      | -    |        |
| Noise outdoor  | dB-A (H/L)                               | -  |                                       |          | 46/-                                |              |            | -      | -    |        |
|  | Power Level dB                           | -  |                                       |          | 65/-                                |              |            | -      | -    |        |
| H<br>E<br>A<br>T<br>I<br>N<br>G                            | Capacity                                 | kW   | 6.0                                   | 6.0      | 6.0                                 | -            | -          | -      | 1.8  | 7.0    |
|  |  | BTU/h  | 20500                                 | 20500    | 20500                               | -            | -          | -      | 6100 | 23900  |
|  | Current                                  | A  | 1.12                                  | 1.08     | 1.04                                | 7.40         | 7.10       | 6.80   | -    | -      |
|  | Input power                              | W  | 140                                   | 140      | 140                                 | 1.470k       | 1.470k     | 1.470k | -    | -      |
|  |  | TOTAL W  | -                                     |          |                                     | 1.610k       | 1.610k     | 1.610k | 350  | 1.850k |
|  | COP/COP CLASS                            | TOTAL (W/W) <sup>25</sup> ("A"~"G")              | -                                     | -        | -                                   | 3.73         | 3.73/A     | 3.73   | 5.14 | 3.78   |
|  | Erp <sup>*6</sup>                        | Pdesign at -10°C                                 | kW                                    | -        | -                                   | -            | -          | 5.6    | -    | -      |
|  |  | Tbivalent  | °C                                    | -        | -                                   | -            | -          | -9     | -    | -      |
|  |  | SCOP   | (W/W)                                 | -        | -                                   | -            | -          | 3.8    | -    | -      |
|  |  | Annual consumption                               | kWh                                   | -        | -                                   | -            | -          | 2061   | -    | -      |
| Class  |  | -  | -                                     | -        | -                                   | A            | -          | -      |      |        |
| Power factor   | %  | -  | -                                     | -        | 90                                  | 90           | 90         | -      | -    |        |
| Noise indoor   | dB-A (H/M/L)                             | 43/41/36   |                                       |          | -                                   |              |            | -      | -    |        |
|  | Power Level dB                           | 60/58/53   |                                       |          | -                                   |              |            | -      | -    |        |
| Noise outdoor  | dB-A (H/L)                               | -  |                                       |          | 48/-                                |              |            | -      | -    |        |
|  | Power Level dB                           | -  |                                       |          | 68/-                                |              |            | -      | -    |        |
| EXTRA LOW TEMP   Total capacity(kW) / Input power(W) / COP |  | -  |                                       |          |                                     |              |            |        |      |        |
| Max Current(A) / Max Input power(W)                        |  | 1.28/160   | 1.24/160                              | 1.20/160 | 16.5/3.27k                          | 16.5/3.42k   | 16.5/3.57k | -      |      |        |
| Starting current(A) / Comp output(W)                       |  | -  | -                                     | -        | 8.70/1.7k                           | 8.40/1.7k    | 8.00/1.7k  | -      |      |        |
| Network Impedance(ΩMAX.)                                   |  | -  |                                       |          |                                     |              |            |        |      |        |
| Fan motor output (Indoor/Outdoor) W                        |  | 120  |                                       |          | 60                                  |              |            | -      |      |        |
| Moisture removal volume                                    |  | L/h(Pt/h)  | 3.4 (7.1)                             |          |                                     | -            |            |        | -    |        |
| External static pressure                                   |  | Pa   | 50 (MIN10 - MAX80)                    |          |                                     | -            |            |        | -    |        |
| Indoor Air flow  | Cooling                                  | m³/min (ft³/min)                                 | 22.0 /20.0/16.0 (777) / (706) / (565) |          |                                     | -            |            |        | -    |        |
|  | Heating                                  | m³/min (ft³/min)                                 | 22.0 /20.0/16.0 (777) / (706) / (565) |          |                                     | -            |            |        | -    |        |
| Outdoor Air flow   | Cooling                                  | m³/min (ft³/min)                                 | -                                     |          |                                     | 38 (1342)    |            |        | -    |        |
|  | Heating                                  | m³/min (ft³/min)                                 | -                                     |          |                                     | 41 (1448)    |            |        | -    |        |
| Refrigerant type / amount g(oz)                            |  | -  |                                       |          | R410A                               | 1.95k (68.8) |            | -      |      |        |
| Product dimension  | Height                                   | mm(inch)   | 250 (9-27/32)                         |          | 619 (24-3/8)                        |              | -          |        |      |        |
|  | Width                                    | mm(inch)   | 1000 [+100] (39-5/16) (+3-15/16)      |          | 799 (31-29/64)                      |              | -          |        |      |        |
|  | Depth                                    | mm(inch)   | 650 (25-19/32)                        |          | 299 (11-49/64)                      |              | -          |        |      |        |
| Product dimension (Panel)                                  |  | H×W×D mm, inch                                   | -                                     |          |                                     | -            |            |        | -    |        |
| Packing dimension  | Height                                   | mm(inch)   | 338                                   |          |                                     | 688          |            |        | -    |        |
|  | Width                                    | mm(inch)   | 1211                                  |          |                                     | 931          |            |        | -    |        |
|  | Depth                                    | mm(inch)   | 761                                   |          |                                     | 422          |            |        | -    |        |
| Weight   | (NET)                                    | kg(lb)   | 32 (71)                               |          | 40 (88)                             |              | -          |        |      |        |
|  | (GROSS)                                  | kg(lb)   | 38 (84)                               |          | 45 (99)                             |              | -          |        |      |        |
|  | Panel (NET)                              | kg(lb)   | -                                     |          |                                     | -            |            |        | -    |        |
| Layers limit (actually)                                    |  | 6 (7)  |                                       |          | 5 (6)                               |              |            | -      |      |        |
| Operation condition  | Cool (DBT)                               | 18°C ~ 32°C                                      |                                       |          | -10°C ~ 43°C                        |              |            | -      |      |        |
|  | Heat (DBT)                               | 16°C ~ 30°C                                      |                                       |          | -15°C ~ 24°C                        |              |            | -      |      |        |
| P I P I N G  | Pipe diameter mm (inch)                  | (Liquid)ø9.52(3/8) (Gas)ø15.88(5/8)              |                                       |          | (Liquid)ø9.52(3/8) (Gas)ø15.88(5/8) |              |            | -      |      |        |
|  | Connecting method, Standard length m(ft) | flared type, 5.0(16.4)                           |                                       |          | flared type, 5.0(16.4)              |              |            | -      |      |        |
| Pipe length range m (ft)                                   |  | 3 ~ 40m (9.8 ~ 131.2)                            |                                       |          | -                                   |              |            | -      |      |        |
| Indoor unit & Outdoor unit height difference m (ft)        |  | 15m (OD located lower) / 30m (OD located higher) |                                       |          | (49.2/98.4)                         |              |            | -      |      |        |
| Add gas amount g/m (oz/ft)                                 |  | 40g (0.430)                                      |                                       |          | -                                   |              |            | -      |      |        |
| Pipe length for additional gas m (ft)                      |  | 30m (98.4)                                       |                                       |          | -                                   |              |            | -      |      |        |

\*1: In case it is necessary to indicate the air flow volume in (l/s), the value in (m³/min.) shall be multiplied by 16.7 and rounded down the decimal point.

\*2: If the EUROVENT Certified models can be operated under the "extra-low" temperature condition, -7°C dry bulb and -8°C wet-bulb temperatures with rated voltage 230 V shall be used.

\*3: Network Impedance shall be applicable for EUROPE and CHINA models.

\*4: The annual consumption is calculated by multiplying the input power at 230 V (400 V) by an average of 500 hours per year in cooling mode.

\*5: EER and COP classification is at 230 V (400 V) only in accordance with EU directive 2002/31/EC.

\*6: SEER and SCOP classification is at 230V(400V) only in accordance with EN-14825. For heating, SCOP indicates the value of only Average heating season, Other fiche data indicates in an attached sheet.

# Simultaneous (Twin) -Type

## 1-1. Unit Specifications

**PEY1**

### 11. Ducted Type S-60PN1E5A×2 / U-125PEY1E5

|  |  |  |                                    |                    |                                     |                |             |          |       |        |
|--|--|--|------------------------------------|--------------------|-------------------------------------|----------------|-------------|----------|-------|--------|
| INDOOR   | MODEL                                    | S-60PN1E5A×2                                   |                                    |                    | -                                   |                |             | -        |       |        |
| PANEL  | MODEL                                    | -  |                                    |                    | -                                   |                |             | -        |       |        |
| OUTDOOR  | MODEL                                    | -  |                                    |                    | U-125PEY1E5                         |                |             | -        |       |        |
| Branch pipe  | MODEL                                    | -  |                                    |                    | CZ-P155BK1                          |                |             | -        |       |        |
| Performance test condition                                 |  | ISO13253 / EN14511 / EN12102 / EN14825         |                                    |                    |                                     |                |             |          |       |        |
| Power supply   |  | ∅, Hz  | 1∅ 50Hz                            |                    |                                     | 1∅ 50Hz        |             |          | Min   | Max    |
|  |  | V  | 220                                | 230                | 240                                 | 220            | 230         | 240      |       |        |
| C<br>O<br>O<br>L<br>I<br>N<br>G                            | Capacity                                 | kW   | 12.5                               | 12.5               | 12.5                                | -              | -           | -        | 3.8   | 13.5   |
|  |  | BTU/h  | 42700                              | 42700              | 42700                               | -              | -           | -        | 13000 | 46100  |
|  | Current                                  | A  | 1.12×2                             | 1.08×2             | 1.04×2                              | 19.9           | 19.0        | 18.4     | -     | -      |
|  |  | W  | 140×2                              | 140×2              | 140×2                               | 4.165k         | 4.165k      | 4.165k   | -     | -      |
|  | Input power                              | TOTAL W  | -                                  |                    |                                     | 4.445k         | 4.445k      | 4.445k   | 950   | 5.200k |
|  |  | Annual consumption                             | TOTAL kWh *4                       | -                  |                                     |                | -           | 2223     | -     | -      |
|  | EER/EER CLASS                            | TOTAL (W/W) <sup>5</sup> ("A"~"G")             | -                                  | -                  | -                                   | 2.81           | 2.81 / C    | 2.81     | 4.00  | 2.60   |
|  | E <sub>rs</sub>                          | Pdesign  | kW                                 | -                  | -                                   | -              | -           | 12.5     | -     | -      |
|  |  | η <sub>s,c</sub>                               | %                                  | -                  | -                                   | -              | -           | 206.9    | -     | -      |
|  |  | Annual consumption                             | kWh                                | -                  | -                                   | -              | -           | -        | -     | -      |
| Class  |  |  | -                                  | -                  | -                                   | -              | -           | -        | -     |        |
| Power factor   | %  | -  | -                                  | -                  | 95                                  | 95             | 94          | -        | -     |        |
| Noise indoor   | dB-A (H/M/L)                             | 43/41/36                                       |                                    |                    | -                                   |                |             | -        | -     |        |
|  | Power Level dB                           | 60/58/53                                       |                                    |                    | -                                   |                |             | -        | -     |        |
| Noise outdoor  | dB-A (H/L)                               | -  |                                    |                    | 56/-                                |                |             | -        | -     |        |
|  | Power Level dB                           | -  |                                    |                    | 73/-                                |                |             | -        | -     |        |
| H<br>E<br>A<br>T<br>I<br>N<br>G                            | Capacity                                 | kW   | 12.5                               | 12.5               | 12.5                                | -              | -           | -        | 3.4   | 15.0   |
|  |  | BTU/h  | 42700                              | 42700              | 42700                               | -              | -           | -        | 11600 | 51200  |
|  | Current                                  | A  | 1.12×2                             | 1.08×2             | 1.04×2                              | 16.2           | 15.5        | 15.0     | -     | -      |
|  |  | W  | 140×2                              | 140×2              | 140×2                               | 3.385k         | 3.385k      | 3.385k   | -     | -      |
|  | Input power                              | TOTAL W  | -                                  |                    |                                     | 3.665k         | 3.665k      | 3.665k   | 780   | 4.600k |
|  |  | COP/COP CLASS                                  | TOTAL (W/W) <sup>5</sup> ("A"~"G") | -                  | -                                   | -              | 3.41        | 3.41 / B | 3.41  | 4.36   |
|  | E <sub>rs</sub>                          | Pdesign at -10°C                               | kW                                 | -                  | -                                   | -              | -           | 12.5     | -     | -      |
|  |  | Tbivalent                                      | °C                                 | -                  | -                                   | -              | -           | -7       | -     | -      |
|  |  | η <sub>s,h</sub>                               | %                                  | -                  | -                                   | -              | -           | 138.5    | -     | -      |
|  |  | Annual consumption                             | kWh                                | -                  | -                                   | -              | -           | -        | -     | -      |
| Class  |  | -  | -                                  | -                  | -                                   | -              | -           | -        |       |        |
| Power factor   | %  | -  | -                                  | -                  | 95                                  | 95             | 94          | -        | -     |        |
| Noise indoor   | dB-A (H/M/L)                             | 43/41/36                                       |                                    |                    | -                                   |                |             | -        | -     |        |
|  | Power Level dB                           | 60/58/53                                       |                                    |                    | -                                   |                |             | -        | -     |        |
| Noise outdoor  | dB-A (H/L)                               | -  |                                    |                    | 56/-                                |                |             | -        | -     |        |
|  | Power Level dB                           | -  |                                    |                    | 73/-                                |                |             | -        | -     |        |
| EXTRA LOW TEMP   Total capacity(kW) / Input power(W) / COP |  | -  |                                    |                    |                                     |                |             |          |       |        |
| Max Current(A) / Max Input power(W)                        |  | 1.28×2/160×2                                   | 1.24×2/160×2                       | 1.20×2/160×2       | 29.0/6.000k                         | 29.0/6.300k    | 29.0/6.600k | -        |       |        |
| Starting current(A) / Comp output(W)                       |  | -  | -                                  | -                  | 19.9/3.0k                           | 19.0/3.0k      | 18.4/3.0k   | -        |       |        |
| Network Impedance(ΩMAX.)                                   |  | -  |                                    |                    | -                                   |                |             | -        |       |        |
| Fan motor output (Indoor/Outdoor) W                        |  | 120×2  |                                    |                    | 90                                  |                |             | -        |       |        |
| Moisture removal volume                                    |  | L/h(Pt/h)                                      | 7.9                                | (3.95×2)           | (16.6)                              | -              |             |          | -     |        |
| External static pressure                                   |  | Pa   | 50 (MIN10 ~ MAX80)                 |                    |                                     | -              |             |          | -     |        |
| Indoor Air flow  | Cooling                                  | m³/min (ft³/min)                               | [22/20/16 (777/706/565)]×2         |                    |                                     | -              |             |          | -     |        |
|  | Heating                                  | m³/min (ft³/min)                               | [22/20/16 (777/706/565)]×2         |                    |                                     | -              |             |          | -     |        |
| Outdoor Air flow   | Cooling                                  | m³/min (ft³/min)                               | -                                  |                    |                                     | 80             | (2825)      | -        |       |        |
|  | Heating                                  | m³/min (ft³/min)                               | -                                  |                    |                                     | 73             | (2578)      | -        |       |        |
| Refrigerant type / amount g(oz)                            |  | -  |                                    |                    | R410A                               | 3.20k          | (112.9)     | -        |       |        |
| Product dimension  | Height                                   | mm(inch)                                       | 250 (9-27/32)                      |                    |                                     | 996 (39-7/32)  |             |          | -     |        |
|  | Width                                    | mm(inch)                                       | 1000 (+100)                        | 39-5/16 (+3-15/16) |                                     | 940 (37-1/32)  |             |          | -     |        |
|  | Depth                                    | mm(inch)                                       | 650 (25-19/32)                     |                    |                                     | 340 (13-13/32) |             |          | -     |        |
| Packing dimension  | Height                                   | mm(inch)                                       | 338                                |                    |                                     | 1136           |             |          | -     |        |
|  | Width                                    | mm(inch)                                       | 1211                               |                    |                                     | 1055           |             |          | -     |        |
|  | Depth                                    | mm(inch)                                       | 761                                |                    |                                     | 485            |             |          | -     |        |
| Weight   | (NET)                                    | kg(lb)   | 32 (71)                            |                    |                                     | 85 (187)       |             |          | -     |        |
|  | (GROSS)                                  | kg(lb)   | 38 (84)                            |                    |                                     | 93 (205)       |             |          | -     |        |
| Layers limit (actually)                                    |  | 6 (7)  |                                    |                    | 2 (3)                               |                |             | -        |       |        |
| Operation condition  | Cool (DBT)                               | 18°C ~ 32°C                                    |                                    |                    | -10°C ~ 43°C                        |                |             | -        |       |        |
|  | Heat (DBT)                               | 16°C ~ 30°C                                    |                                    |                    | -15°C ~ 24°C                        |                |             | -        |       |        |
| P<br>I<br>P<br>I<br>N<br>G                                 | Pipe diameter mm (inch)                  | (Liquid)∅9.52(3/8) (Gas)∅15.88(5/8)            |                                    |                    | (Liquid)∅9.52(3/8) (Gas)∅15.88(5/8) |                |             | -        |       |        |
|  | Connecting method, Standard length m(ft) | flared type, 5.0(16.4)                         |                                    |                    | flared type, 5.0(16.4)              |                |             | -        |       |        |
| Pipe length range  |  | m (ft)   |                                    |                    | 5 ~ 50 (16.4 ~ 164.0)               |                |             | -        |       |        |
| Indoor unit & Outdoor unit height difference m (ft)        |  | 15 (OD located lower) / 30 (OD located higher) |                                    |                    | (49.2/98.4)                         |                |             | -        |       |        |
| Add gas amount g/m (oz/ft)                                 |  | 50   |                                    |                    | (0.538)                             |                |             | -        |       |        |
| Pipe length for additional gas                             |  | m (ft)   |                                    |                    | 30 (98.4)                           |                |             | -        |       |        |

\*1: In case it is necessary to indicate the air flow volume in (l/s), the value in (m³/min.) shall be multiplied by 16.7 and rounded down the decimal point.  
 \*2: If the EUROVENT Certified models can be operated under the "extra-low" temperature condition, -7°C dry bulb and -8°C wet-bulb temperatures with rated voltage 230 V shall be used.  
 \*3: Network Impedance shall be applicable for EUROPE and CHINA models.  
 \*4: The annual consumption is calculated by multiplying the input power at 230 V (400 V) by an average of 500 hours per year in cooling mode.  
 \*5: EER and COP classification is at 230 V (400 V) only in accordance with EU directive 2002/31/EC.  
 \*6: SEER and SCOP classification is at 230V(400V) only in accordance with EN-14825. For heating, SCOP indicates the value of only Average heating season.

# Single -Type

## 1-1. Unit Specifications

**PEY2**

### 11. Ducted Type S-71PN1E5A / U-71PEY2E5

| INDOOR   |   | MODEL                              | S-71PN1E5A                                       |                      |              | -                                   |            |            | -    |        |   |
|--|---|------------------------------------|--|----------------------|--------------|-------------------------------------|------------|------------|------|--------|---|
| PANEL  |   | MODEL                              | -  |                      |              | -                                   |            |            | -    |        |   |
| OUTDOOR  |   | MODEL                              | -  |                      |              | U-71PEY2E5                          |            |            | -    |        |   |
| Branch pipe  |   | MODEL                              | -  |                      |              | -                                   |            |            | -    |        |   |
| Performance test condition                                 |   |                                    | ISO13253 / EN14511 / EN12102 / EN14825           |                      |              |                                     |            |            |      |        |   |
| Power supply   |   | Ø, Hz                              | 1ø 50Hz  |                      |              | 1ø 50Hz                             |            |            | Min  | Max    |   |
|  |   | V                                  | 220V   | 230V                 | 240V         | 220V                                | 230V       | 240V       |      |        |   |
| C<br>O<br>O<br>L<br>I<br>N<br>G                            | Capacity  | kW                                 | 7.1  | 7.1                  | 7.1          | -                                   | -          | -          | 2.0  | 7.7    |   |
|  |   | BTU/h                              | 24200  | 24200                | 24200        | -                                   | -          | -          | 6800 | 26300  |   |
|  | Current   | A                                  | 1.12   | 1.08                 | 1.04         | 12.1                                | 11.6       | 11.2       | -    | -      |   |
|  | Input power   | W                                  | 140  | 140                  | 140          | 2.430k                              | 2.430k     | 2.430k     | -    | -      |   |
|  |   | TOTAL W                            | -  | -                    | -            | 2.570k                              | 2.570k     | 2.570k     | 400  | 3.100k |   |
|  | Annual consumption                                  | TOTAL kWh *4                       | -  | -                    | -            | -                                   | 1285       | -          | -    | -      |   |
|  | EER/EER CLASS                                       | TOTAL (W/W) <sup>5</sup> ("A"~"G") | -  | -                    | -            | 2.76                                | 2.76/D     | 2.76       | 5.00 | 2.48   |   |
|  | E <sub>rp</sub> <sup>*6</sup>                       | Pdesign                            | kW   | -                    | -            | -                                   | -          | 7.1        | -    | -      | - |
|  |   | SEER                               | (W/W)  | -                    | -            | -                                   | -          | 5.1        | -    | -      | - |
|  |   | Annual consumption                 | kWh  | -                    | -            | -                                   | -          | 487        | -    | -      | - |
|  |   | Class                              |  | -                    | -            | -                                   | -          | A          | -    | -      | - |
|  | Power factor  | %                                  | -  | -                    | -            | 91                                  | 91         | 91         | -    | -      |   |
|  | Noise indoor  | dB-A (H/M/L)                       | 43/41/36   |                      |              | -                                   |            |            | -    | -      |   |
|  |   | Power Level dB                     | 60/58/53   |                      |              | -                                   |            |            | -    | -      |   |
| Noise outdoor  | dB-A (H/L)  | -                                  |  |                      | 49/-         |                                     |            | -          | -    |        |   |
|  | Power Level dB                                      | -                                  |  |                      | 69/-         |                                     |            | -          | -    |        |   |
| H<br>E<br>A<br>T<br>I<br>N<br>G                            | Capacity  | kW                                 | 7.1  | 7.1                  | 7.1          | -                                   | -          | -          | 1.8  | 8.1    |   |
|  |   | BTU/h                              | 24200  | 24200                | 24200        | -                                   | -          | -          | 6100 | 27600  |   |
|  | Current   | A                                  | 1.12   | 1.08                 | 1.04         | 9.00                                | 8.60       | 8.25       | -    | -      |   |
|  | Input power   | W                                  | 140  | 140                  | 140          | 1.780k                              | 1.780k     | 1.780k     | -    | -      |   |
|  |   | TOTAL W                            | -  | -                    | -            | 1.920k                              | 1.920k     | 1.920k     | 350  | 2.450k |   |
|  | COP/COP CLASS                                       | TOTAL (W/W) <sup>5</sup> ("A"~"G") | -  | -                    | -            | 3.70                                | 3.70/A     | 3.70       | 5.14 | 3.31   |   |
|  | E <sub>rp</sub> <sup>*6</sup>                       | Pdesign at -10°C                   | kW   | -                    | -            | -                                   | -          | 5.6        | -    | -      | - |
|  |   | Tbivalent                          | °C   | -                    | -            | -                                   | -          | -9         | -    | -      | - |
|  |   | SCOP                               | (W/W)  | -                    | -            | -                                   | -          | 3.8        | -    | -      | - |
|  |   | Annual consumption                 | kWh  | -                    | -            | -                                   | -          | 2061       | -    | -      | - |
|  | Class   |                                    | -  | -                    | -            | -                                   | A          | -          | -    | -      |   |
|  | Power factor  | %                                  | -  | -                    | -            | 90                                  | 90         | 90         | -    | -      |   |
|  | Noise indoor  | dB-A (H/M/L)                       | 43/41/36   |                      |              | -                                   |            |            | -    | -      |   |
|  |   | Power Level dB                     | 60/58/53   |                      |              | -                                   |            |            | -    | -      |   |
| Noise outdoor  | dB-A (H/L)  | -                                  |  |                      | 49/-         |                                     |            | -          | -    |        |   |
|  | Power Level dB                                      | -                                  |  |                      | 69/-         |                                     |            | -          | -    |        |   |
| EXTRA LOW TEMP   Total capacity(kW) / Input power(W) / COP |   |                                    | -  |                      |              |                                     |            |            |      |        |   |
| Max Current(A) / Max Input power(W)                        |   |                                    | 1.28/160   | 1.24/160             | 1.20/160     | 16.5/3.27k                          | 16.5/3.42k | 16.5/3.57k | -    | -      |   |
| Starting current(A) / Comp output(W)                       |   |                                    | -  | -                    | -            | 12.1/2.0k                           | 11.6/2.0k  | 11.2/2.0k  | -    | -      |   |
| Network Impedance(ΩMAX.)                                   |   |                                    | -  |                      |              |                                     |            |            |      |        |   |
| Fan motor output (Indoor/Outdoor) W                        |   |                                    | 120  |                      |              | 60                                  |            |            | -    | -      |   |
| Moisture removal volume                                    |   | L/h(Pt/h)                          | 4.2  | (8.8)                |              | -                                   |            |            | -    | -      |   |
| External static pressure                                   |   | Pa                                 | 50 (MIN10 ~ MAX80)                               |                      |              | -                                   |            |            | -    | -      |   |
| Indoor Air flow  | Cooling   | m³/min (ft³/min)                   | 22.0 / 20.0 / 16.0 (777) / (706) / (565)         |                      |              | -                                   |            |            | -    | -      |   |
|  | Heating   | m³/min (ft³/min)                   | 22.0 / 20.0 / 16.0 (777) / (706) / (565)         |                      |              | -                                   |            |            | -    | -      |   |
| Outdoor Air flow   | Cooling   | m³/min (ft³/min)                   | -  |                      |              | 44                                  | (1554)     |            | -    | -      |   |
|  | Heating   | m³/min (ft³/min)                   | -  |                      |              | 41                                  | (1448)     |            | -    | -      |   |
| Refrigerant type / amount g(oz)                            |   |                                    | -  |                      |              | R410A                               | 1.95k      | (68.8)     |      |        |   |
| Product dimension  | Height  | mm(inch)                           | 250  | (9-27/32)            |              | 619                                 | (24-3/8)   |            | -    | -      |   |
|  | Width   | mm(inch)                           | 1000 [+100]                                      | (39-5/16) (+3-15/16) |              | 799                                 | (31-29/64) |            | -    | -      |   |
|  | Depth   | mm(inch)                           | 650  | (25-19/32)           |              | 299                                 | (11-49/64) |            | -    | -      |   |
| Product dimension (Panel)                                  |   |                                    | H×W×D mm, inch                                   |                      |              | -                                   |            |            | -    | -      |   |
| Packing dimension  | Height  | mm(inch)                           | 338  |                      |              | 688                                 |            |            | -    | -      |   |
|  | Width   | mm(inch)                           | 1211   |                      |              | 931                                 |            |            | -    | -      |   |
|  | Depth   | mm(inch)                           | 761  |                      |              | 422                                 |            |            | -    | -      |   |
| Weight   | (NET)   | kg(lb)                             | 32   | (71)                 |              | 40                                  | (88)       |            | -    | -      |   |
|  | (GROSS)   | kg(lb)                             | 38   | (84)                 |              | 45                                  | (99)       |            | -    | -      |   |
|  | Panel (NET)   | kg(lb)                             | -  |                      |              | -                                   |            |            | -    | -      |   |
| Layers limit (actually)                                    |   |                                    | 6 (7)  |                      |              | 5 (6)                               |            |            | -    | -      |   |
| Operation condition  | Cool (DBT)  | 18°C ~ 32°C                        |  |                      | -10°C ~ 43°C |                                     |            | -          | -    |        |   |
|  | Heat (DBT)  | 16°C ~ 30°C                        |  |                      | -15°C ~ 24°C |                                     |            | -          | -    |        |   |
| P<br>I<br>P<br>E<br>I<br>N<br>G                            | Pipe diameter mm (inch)                             |                                    | (Liquid)ø9.52(3/8) (Gas)ø15.88(5/8)              |                      |              | (Liquid)ø9.52(3/8) (Gas)ø15.88(5/8) |            |            | -    | -      |   |
|  | Connecting method, Standard length m(ft)            |                                    | flared type, 5.0(16.4)                           |                      |              | flared type, 5.0(16.4)              |            |            | -    | -      |   |
|  | Pipe length range m (ft)                            |                                    | 3 ~ 40m (9.8 ~ 131.2)                            |                      |              | -                                   |            |            | -    | -      |   |
|  | Indoor unit & Outdoor unit height difference m (ft) |                                    | 15m (OD located lower) / 30m (OD located higher) |                      |              | (49.2/98.4)                         |            |            | -    | -      |   |
|  | Add gas amount g/m (oz/ft)                          |                                    | 40g (0.430)                                      |                      |              | -                                   |            |            | -    | -      |   |
| Pipe length for additional gas m (ft)                      |   | 30m (98.4)                         |  |                      | -            |                                     |            | -          | -    |        |   |

\*1: In case it is necessary to indicate the air flow volume in (l/s), the value in (m³/min.) shall be multiplied by 16.7 and rounded down the decimal point.

\*2: If the EUROVENT Certified models can be operated under the "extra-low" temperature condition, -7°C dry bulb and -8°C wet-bulb temperatures with rated voltage 230 V shall be used.

\*3: Network Impedance shall be applicable for EUROPE and CHINA models.

\*4: The annual consumption is calculated by multiplying the input power at 230 V (400 V) by an average of 500 hours per year in cooling mode.

\*5: EER and COP classification is at 230 V (400 V) only in accordance with EU directive 2002/31/EC.

\*6: SEER and SCOP classification is at 230V(400V) only in accordance with EN-14825. For heating, SCOP indicates the value of only Average heating season, Other fiche data indicates in an attached sheet.

# Single -Type

## 1-1. Unit Specifications

**PEY1**

### 11. Ducted Type S-100PN1E5A / U-100PEY1E5

| INDOOR   |  | MODEL            | S-100PN1E5A                            |                                     |              | -              |             |      | -      |       |  |
|--|--|------------------|--|-------------------------------------|--------------|----------------|-------------|------|--------|-------|--|
| PANEL  |  | MODEL            | -                                      |                                     |              | -              |             |      | -      |       |  |
| OUTDOOR  |  | MODEL            | -                                      |                                     |              | U-100PEY1E5    |             |      | -      |       |  |
| Branch pipe  |  | MODEL            | -                                      |                                     |              | -              |             |      | -      |       |  |
| Performance test condition                                 |  |                  | ISO13253 / EN14511 / EN14825 / EN12102 |                                     |              |                |             |      |        |       |  |
| Power supply   |  | Ø, Hz            | 1ø 50Hz                                |                                     |              | 1ø 50Hz        |             |      |        |       |  |
|  |  | V                | 220                                    | 230                                 | 240          | 220            | 230         | 240  | Min    | Max   |  |
| Capacity   | kW   | 10.0             | 10.0                                   | 10.0                                | -            | -              | -           | -    | 2.7    | 11.5  |  |
|  | BTU/h  | 34100            | 34100                                  | 34100                               | -            | -              | -           | -    | 9200   | 39200 |  |
| Current  | A  | 1.54             | 1.48                                   | 1.42                                | 16.0         | 15.3           | 14.8        | -    | -      | -     |  |
| Input power  | W  | 205              | 205                                    | 205                                 | 3.350k       | 3.350k         | 3.350k      | -    | -      | -     |  |
|  | TOTAL W  | -                | -                                      | -                                   | 3.555k       | 3.555k         | 3.555k      | 570  | 4.300k | -     |  |
| Annual consumption   | TOTAL kWh *4                                   | -                | -                                      | -                                   | -            | 1778           | -           | -    | -      | -     |  |
| EER/EER CLASS  | TOTAL (W/W) <sup>*5</sup> ("A"~"G")            | -                | -                                      | -                                   | 2.81         | 2.81 / C       | 2.81        | 4.74 | 2.67   | -     |  |
| Erp *6   | Pdesign  | kW               | -                                      | -                                   | -            | -              | 10.0        | -    | -      | -     |  |
|  | SEER   | (W/W)            | -                                      | -                                   | -            | -              | 5.3         | -    | -      | -     |  |
|  | Annual consumption                             | kWh              | -                                      | -                                   | -            | -              | 661         | -    | -      | -     |  |
|  | Class  | -                | -                                      | -                                   | -            | -              | A           | -    | -      | -     |  |
| Power factor   | %  | -                | -                                      | -                                   | 95           | 95             | 94          | -    | -      | -     |  |
| Noise indoor   | dB-A (H/M/L)                                   | 44/42/37         |  |                                     | -            |                |             | -    |        |       |  |
|  | Power Level dB                                 | 65/63/58         |  |                                     | -            |                |             | -    |        |       |  |
| Noise outdoor  | dB-A (H/L)                                     | -                |  |                                     | 54/-         |                |             | -    |        |       |  |
|  | Power Level dB                                 | -                |  |                                     | 70/-         |                |             | -    |        |       |  |
| Capacity   | kW   | 10.0             | 10.0                                   | 10.0                                | -            | -              | -           | 2.1  | 13.8   | -     |  |
|  | BTU/h  | 34100            | 34100                                  | 34100                               | -            | -              | -           | 7200 | 47100  | -     |  |
| Current  | A  | 1.54             | 1.48                                   | 1.42                                | 13.0         | 12.5           | 12.1        | -    | -      | -     |  |
| Input power  | W  | 205              | 205                                    | 205                                 | 2.730k       | 2.730k         | 2.730k      | -    | -      | -     |  |
|  | TOTAL W  | -                | -                                      | -                                   | 2.935k       | 2.935k         | 2.935k      | 450  | 4.100k | -     |  |
| COP/COP CLASS  | TOTAL (W/W) <sup>*5</sup> ("A"~"G")            | -                | -                                      | -                                   | 3.41         | 3.41 / B       | 3.41        | 4.67 | 3.37   | -     |  |
| Erp *6   | Pdesign at -10°C                               | kW               | -                                      | -                                   | -            | -              | 7.6         | -    | -      | -     |  |
|  | Tbivalent                                      | °C               | -                                      | -                                   | -            | -              | -10         | -    | -      | -     |  |
|  | SCOP   | (W/W)            | -                                      | -                                   | -            | -              | 3.8         | -    | -      | -     |  |
|  | Annual consumption                             | kWh              | -                                      | -                                   | -            | -              | 2800        | -    | -      | -     |  |
| Class  | -  | -                | -                                      | -                                   | -            | A              | -           | -    | -      | -     |  |
| Power factor   | %  | -                | -                                      | -                                   | 95           | 95             | 94          | -    | -      | -     |  |
| Noise indoor   | dB-A (H/M/L)                                   | 44/42/37         |  |                                     | -            |                |             | -    |        |       |  |
|  | Power Level dB                                 | 65/63/58         |  |                                     | -            |                |             | -    |        |       |  |
| Noise outdoor  | dB-A (H/L)                                     | -                |  |                                     | 54/-         |                |             | -    |        |       |  |
|  | Power Level dB                                 | -                |  |                                     | 70/-         |                |             | -    |        |       |  |
| EXTRA LOW TEMP   Total capacity(kW) / Input power(W) / COP |  | -                |  |                                     |              |                |             |      |        |       |  |
| Max Current(A) / Max Input power(W)                        |  | 2.13/275         | 2.07/275                               | 2.01/275                            | 25.0/5.300k  | 25.0/5.500k    | 25.0/5.700k | -    |        |       |  |
| Starting current(A) / Comp output(W)                       |  | -                | -                                      | -                                   | 16.0/1.7k    | 15.3/1.7k      | 14.8/1.7k   | -    |        |       |  |
| Network Impedance(ΩMAX.)                                   |  | -                |  |                                     |              |                |             |      |        |       |  |
| Fan motor output (Indoor/Outdoor) W                        |  | 200              |  |                                     | 90           |                |             | -    |        |       |  |
| Moisture removal volume                                    |  | L/h(Pt/h)        | 6.0 (12.6)                             |                                     |              | -              |             |      | -      |       |  |
| External static pressure                                   |  | Pa               | 50 (MIN10 ~ MAX80)                     |                                     |              | -              |             |      | -      |       |  |
| Indoor Air flow  | Cooling  | m³/min (ft³/min) | 36/33/26 (1271/1165/918)               |                                     |              | -              |             |      | -      |       |  |
|  | Heating  | m³/min (ft³/min) | 36/33/26 (1271/1165/918)               |                                     |              | -              |             |      | -      |       |  |
| Outdoor Air flow   | Cooling  | m³/min (ft³/min) | -                                      |                                     |              | 76 (2684)      |             |      | -      |       |  |
|  | Heating  | m³/min (ft³/min) | -                                      |                                     |              | 67 (2366)      |             |      | -      |       |  |
| Refrigerant type / amount g(oz)                            |  | -                |  |                                     | R410A        | 2.60k          | (91.7)      | -    |        |       |  |
| Product dimension  | Height   | mm(inch)         | 250 (9-27/32)                          |                                     |              | 996 (39-7/32)  |             |      | -      |       |  |
|  | Width  | mm(inch)         | 1200 (+100) 47-1/4 (+3-15/16)          |                                     |              | 940 (37-1/32)  |             |      | -      |       |  |
|  | Depth  | mm(inch)         | 650 (25-19/32)                         |                                     |              | 340 (13-13/32) |             |      | -      |       |  |
| Packing dimension  | Height   | mm(inch)         | 338                                    |                                     |              | 1136           |             |      | -      |       |  |
|  | Width  | mm(inch)         | 1402                                   |                                     |              | 1055           |             |      | -      |       |  |
|  | Depth  | mm(inch)         | 761                                    |                                     |              | 485            |             |      | -      |       |  |
| Weight   | (NET)  | kg(lb)           | 41 (91)                                |                                     |              | 73 (161)       |             |      | -      |       |  |
|  | (GROSS)  | kg(lb)           | 48 (106)                               |                                     |              | 81 (179)       |             |      | -      |       |  |
| Layers limit (actually)                                    |  | 6 (7)            |  |                                     | 2 (3)        |                |             | -    |        |       |  |
| Operation condition  | Cool (DBT)                                     | 18°C ~ 32°C      |  |                                     | -10°C ~ 43°C |                |             | -    |        |       |  |
|  | Heat (DBT)                                     | 16°C ~ 30°C      |  |                                     | -15°C ~ 24°C |                |             | -    |        |       |  |
| Pipe diameter mm (inch)                                    | (Liquid)ø9.52(3/8) (Gas)ø15.88(5/8)            |                  |  | (Liquid)ø9.52(3/8) (Gas)ø15.88(5/8) |              |                | -           |      |        |       |  |
| Connecting method, Standard length m(ft)                   | flared type, 5.0(16.4)                         |                  |  | flared type, 5.0(16.4)              |              |                | -           |      |        |       |  |
| Pipe length range m (ft)                                   | 5 ~ 50 (16.4 ~ 164.0)                          |                  |  | -                                   |              |                | -           |      |        |       |  |
| Indoor unit & Outdoor unit height difference m (ft)        | 15 (OD located lower) / 30 (OD located higher) |                  |  | (49.2/98.4)                         |              |                | -           |      |        |       |  |
| Add gas amount g/m (oz/ft)                                 | 50 (0.538)                                     |                  |  | -                                   |              |                | -           |      |        |       |  |
| Pipe length for additional gas m (ft)                      | 30 (98.4)                                      |                  |  | -                                   |              |                | -           |      |        |       |  |

\*1: In case it is necessary to indicate the air flow volume in (l/s), the value in (m³/min.) shall be multiplied by 16.7 and rounded down the decimal point.  
 \*2: If the EUROVENT Certified models can be operated under the "extra-low" temperature condition, -7°C dry bulb and -8°C wet-bulb temperatures with rated voltage 230 V shall be used.  
 \*3: Network Impedance shall be applicable for EUROPE and CHINA models.  
 \*4: The annual consumption is calculated by multiplying the input power at 230 V (400 V) by an average of 500 hours per year in cooling mode.  
 \*5: EER and COP classification is at 230 V (400 V) only in accordance with EU directive 2002/31/EC.  
 \*6: SEER and SCOP classification is at 230V(400V) only in accordance with EN-14825. For heating, SCOP indicates the value of only Average heating season, Other fiche data indicates in an attached sheet.

# Single -Type

## 1-1. Unit Specifications

**PEY1**

### 11. Ducted Type S-125PN1E5A / U-125PEY1E5

| INDOOR   |                    | MODEL  | S-125PN1E5A                            |          |                                     | -              |             |             | -      |       |  |
|--|--------------------|--|--|----------|-------------------------------------|----------------|-------------|-------------|--------|-------|--|
| PANEL  |                    | MODEL  | -                                      |          |                                     | -              |             |             | -      |       |  |
| OUTDOOR  |                    | MODEL  | -                                      |          |                                     | U-125PEY1E5    |             |             | -      |       |  |
| Branch pipe  |                    | MODEL  | -                                      |          |                                     | -              |             |             | -      |       |  |
| Performance test condition                                 |                    |  | ISO13253 / EN14511 / EN12102 / EN14825 |          |                                     |                |             |             |        |       |  |
| Power supply   |                    | Ø, Hz  | 1ø 50Hz                                |          |                                     | 1ø 50Hz        |             |             |        |       |  |
|  |                    | V  | 220                                    | 230      | 240                                 | 220            | 230         | 240         | Min    | Max   |  |
| Capacity   | kW                 | 12.5   | 12.5                                   | 12.5     | -                                   | -              | -           | -           | 3.8    | 13.5  |  |
|  | BTU/h              | 42700  | 42700                                  | 42700    | -                                   | -              | -           | -           | 13000  | 48100 |  |
| Current  |                    | A  | 1.74                                   | 1.67     | 1.61                                | 20.1           | 19.3        | 18.7        | -      | -     |  |
| Input power  | W                  | 225  | 225                                    | 225      | 4.220k                              | 4.220k         | 4.220k      | -           | -      | -     |  |
|  | TOTAL W            | -  | -                                      | -        | 4.445k                              | 4.445k         | 4.445k      | 950         | 5.200k | -     |  |
| Annual consumption   |                    | TOTAL kWh *4                                   | -                                      |          |                                     | 2223           |             |             | -      | -     |  |
| EER/EER CLASS  |                    | TOTAL (W/W) <sup>5</sup> ("A"~"G")             | -                                      | -        | -                                   | 2.81           | 2.81 / C    | 2.81        | 4.00   | 2.60  |  |
| Erp *6   | Pdesign            | kW   | -                                      | -        | -                                   | -              | 12.5        | -           | -      | -     |  |
|  | η <sub>s,c</sub>   | %  | -                                      | -        | -                                   | -              | 195.0       | -           | -      | -     |  |
|  | Annual consumption | kWh  | -                                      | -        | -                                   | -              | -           | -           | -      | -     |  |
|  | Class              | -  | -                                      | -        | -                                   | -              | -           | -           | -      | -     |  |
| Power factor   |                    | %  | -                                      | -        | -                                   | 95             | 95          | 94          | -      | -     |  |
| Noise indoor   | dB-A (H/M/L)       | 45/43/38                                       |  |          | -                                   |                |             | -           | -      | -     |  |
|  | Power Level dB     | 66/64/59                                       |  |          | -                                   |                |             | -           | -      | -     |  |
| Noise outdoor  | dB-A (H/L)         | -  |  |          | 56/-                                |                |             | -           | -      | -     |  |
|  | Power Level dB     | -  |  |          | 73/-                                |                |             | -           | -      | -     |  |
| Capacity   | kW                 | 12.5   | 12.5                                   | 12.5     | -                                   | -              | -           | 3.4         | 15.0   |       |  |
|  | BTU/h              | 42700  | 42700                                  | 42700    | -                                   | -              | -           | 11600       | 51200  |       |  |
| Current  |                    | A  | 1.74                                   | 1.67     | 1.61                                | 16.5           | 15.8        | 15.2        | -      | -     |  |
| Input power  | W                  | 225  | 225                                    | 225      | 3.440k                              | 3.440k         | 3.440k      | -           | -      |       |  |
|  | TOTAL W            | -  | -                                      | -        | 3.665k                              | 3.665k         | 3.665k      | 780         | 4.600k |       |  |
| COP/COP CLASS  |                    | TOTAL (W/W) <sup>5</sup> ("A"~"G")             | -                                      | -        | -                                   | 3.41           | 3.41 / B    | 3.41        | 4.36   | 3.26  |  |
| Erp *6   | Pdesign at -10°C   | kW   | -                                      | -        | -                                   | -              | 12.5        | -           | -      | -     |  |
|  | Tbivalent          | °C   | -                                      | -        | -                                   | -              | -7          | -           | -      | -     |  |
|  | η <sub>s,h</sub>   | %  | -                                      | -        | -                                   | -              | 137.8       | -           | -      | -     |  |
|  | Annual consumption | kWh  | -                                      | -        | -                                   | -              | -           | -           | -      | -     |  |
| Power factor   |                    | %  | -                                      | -        | -                                   | 95             | 95          | 94          | -      | -     |  |
| Noise indoor   | dB-A (H/M/L)       | 45/43/38                                       |  |          | -                                   |                |             | -           | -      | -     |  |
|  | Power Level dB     | 66/64/59                                       |  |          | -                                   |                |             | -           | -      | -     |  |
| Noise outdoor  | dB-A (H/L)         | -  |  |          | 56/-                                |                |             | -           | -      | -     |  |
|  | Power Level dB     | -  |  |          | 73/-                                |                |             | -           | -      | -     |  |
| EXTRA LOW TEMP   Total capacity(kW) / Input power(W) / COP |                    |  | -                                      |          |                                     |                |             |             |        | -     |  |
| Max Current(A) / Max Input power(W)                        |                    |  | 2.36/300                               | 2.30/300 | 2.24/300                            | 29.0/6.000k    | 29.0/6.300k | 29.0/6.600k | -      |       |  |
| Starting current(A) / Comp output(W)                       |                    |  | -                                      | -        | -                                   | 20.1/3.0k      | 19.3/3.0k   | 18.7/3.0k   | -      |       |  |
| Network Impedance(ΩMAX.)                                   |                    |  | -                                      |          |                                     |                |             |             |        | -     |  |
| Fan motor output (Indoor/Outdoor) W                        |                    |  | 200                                    |          |                                     | 90             |             |             | -      |       |  |
| Moisture removal volume                                    |                    |  | L/h(Pt/h)                              |          | 7.9                                 | (16.6)         |             | -           |        |       |  |
| External static pressure                                   |                    |  | Pa                                     |          | 50 (MIN10 ~ MAX80)                  |                |             |             |        | -     |  |
| Indoor Air flow  | Cooling            | m³/min (ft³/min)                               | 38/35/28 (1342/1236/989)               |          |                                     | -              |             |             | -      |       |  |
|  | Heating            | m³/min (ft³/min)                               | 38/35/28 (1342/1236/989)               |          |                                     | -              |             |             | -      |       |  |
| Outdoor Air flow   | Cooling            | m³/min (ft³/min)                               | -                                      |          |                                     | 80             |             | (2825)      |        | -     |  |
|  | Heating            | m³/min (ft³/min)                               | -                                      |          |                                     | 73             |             | (2578)      |        | -     |  |
| Refrigerant type / amount g(oz)                            |                    |  | -                                      |          |                                     | R410A          | 3.20k       | (112.9)     |        | -     |  |
| Product dimension  | Height             | mm(inch)                                       | 250 (9-27/32)                          |          |                                     | 996 (39-7/32)  |             |             | -      |       |  |
|  | Width              | mm(inch)                                       | 1200 (+100) 47-1/4 (+3-15/16)          |          |                                     | 940 (37-1/32)  |             |             | -      |       |  |
|  | Depth              | mm(inch)                                       | 650 (25-19/32)                         |          |                                     | 340 (13-13/32) |             |             | -      |       |  |
| Packing dimension  | Height             | mm(inch)                                       | 338                                    |          |                                     | 1136           |             |             | -      |       |  |
|  | Width              | mm(inch)                                       | 1402                                   |          |                                     | 1055           |             |             | -      |       |  |
|  | Depth              | mm(inch)                                       | 761                                    |          |                                     | 485            |             |             | -      |       |  |
| Weight   | (NET)              | kg(lb)   | 41 (91)                                |          |                                     | 85 (187)       |             |             | -      |       |  |
|  | (GROSS)            | kg(lb)   | 48 (106)                               |          |                                     | 93 (205)       |             |             | -      |       |  |
| Layers limit (actually)                                    |                    |  | 6 (7)                                  |          |                                     | 2 (3)          |             |             | -      |       |  |
| Operation condition  |                    | Cool (DBT)                                     | 18°C ~ 32°C                            |          |                                     | -10°C ~ 43°C   |             |             | -      |       |  |
|  |                    | Heat (DBT)                                     | 16°C ~ 30°C                            |          |                                     | -15°C ~ 24°C   |             |             | -      |       |  |
| Pipe diameter mm (inch)                                    |                    | (Liquid)ø9.52(3/8) (Gas)ø15.88(5/8)            |  |          | (Liquid)ø9.52(3/8) (Gas)ø15.88(5/8) |                |             | -           |        |       |  |
| Connecting method, Standard length m(ft)                   |                    | flared type, 5.0(16.4)                         |  |          | flared type, 5.0(16.4)              |                |             | -           |        |       |  |
| Pipe length range m (ft)                                   |                    | 5 ~ 50 (16.4 ~ 164.0)                          |  |          | -                                   |                |             | -           |        |       |  |
| Indoor unit & Outdoor unit height difference m (ft)        |                    | 15 (OD located lower) / 30 (OD located higher) |  |          | (49.2/98.4)                         |                |             | -           |        |       |  |
| Add gas amount g/m (oz/ft)                                 |                    | 50 (0.538)                                     |  |          | -                                   |                |             | -           |        |       |  |
| Pipe length for additional gas m (ft)                      |                    | 30 (98.4)                                      |  |          | -                                   |                |             | -           |        |       |  |

\*1: In case it is necessary to indicate the air flow volume in (l/s), the value in (m³/min.) shall be multiplied by 16.7 and rounded down the decimal point.

\*2: If the EUROVENT Certified models can be operated under the "extra-low" temperature condition, -7°C dry bulb and -8°C wet-bulb temperatures with rated voltage 230 V shall be used.

\*3: Network Impedance shall be applicable for EUROPE and CHINA models.

\*4: The annual consumption is calculated by multiplying the input power at 230 V (400 V) by an average of 500 hours per year in cooling mode.

\*5: EER and COP classification is at 230 V (400 V) only in accordance with EU directive 2002/31/EC.

\*6: SEER and SCOP classification is at 230V(400V) only in accordance with EN-14825. For heating, SCOP indicates the value of only Average heating season.

# Simultaneous (Twin) -Type

## 1-1. Unit Specifications

**PEY1**

### 11. Ducted Type S-50PN1E5A×2 / U-100PEY1E8

|  |  |  |                            |                     |  |                |            |      |        |       |
|--|--|--|----------------------------|---------------------|--|----------------|------------|------|--------|-------|
| INDOOR   |  | MODEL  | S-50PN1E5A×2               |                     |  | -              |            |      | -      |       |
| PANEL  |  | MODEL  | -                          |                     |  | -              |            |      | -      |       |
| OUTDOOR  |  | MODEL  | -                          |                     |  | U-100PEY1E8    |            |      | -      |       |
| Branch pipe  |  | MODEL  | -                          |                     |  | CZ-P155BK1     |            |      | -      |       |
| Performance test condition                               |  |  |                            |                     | ISO13253 / EN14511 / EN14825 / EN12102 |                |            |      |        |       |
| Power supply   |  | ∅, Hz  | 1∅ 50Hz                    |                     |  | 3∅ 50Hz        |            |      |        |       |
|  |  | V  | 220                        | 230                 | 240                                    | 380            | 400        | 415  | Min    | Max   |
| Capacity   | kW                                       | 10.0   | 10.0                       | 10.0                | -                                      | -              | -          | -    | 2.7    | 11.5  |
|  | BTU/h                                    | 34100  | 34100                      | 34100               | -                                      | -              | -          | -    | 9200   | 39200 |
| Current  | A  | 0.54×2   | 0.55×2                     | 0.56×2              | 5.45                                   | 5.20           | 5.00       | -    | -      | -     |
|  | W  | 115×2  | 120×2                      | 125×2               | 3.320k                                 | 3.320k         | 3.320k     | -    | -      | -     |
| Input power  | TOTAL W                                  | -  |                            |                     | 3.550k                                 | 3.560k         | 3.570k     | 570  | 4.300k | -     |
|  | Annual consumption                       | TOTAL kWh *4                                   | -                          |                     |  | -              | 1780       | -    | -      | -     |
| EER/EER CLASS  | TOTAL (W/W) <sup>5</sup> ("A"~"G")       | -  | -                          | -                   | 2.82                                   | 2.81 / C       | 2.80       | 4.74 | 2.67   | -     |
| E <sub>rp</sub> *6                                       | Pdesign                                  | kW   | -                          | -                   | -                                      | -              | 10.0       | -    | -      | -     |
|  | SEER                                     | (W/W)  | -                          | -                   | -                                      | -              | 4.8        | -    | -      | -     |
|  | Annual consumption                       | kWh  | -                          | -                   | -                                      | -              | 728        | -    | -      | -     |
|  | Class                                    |  | -                          | -                   | -                                      | -              | B          | -    | -      | -     |
| Power factor   | %  | -  | -                          | -                   | 93                                     | 92             | 92         | -    | -      | -     |
| Noise indoor   | dB-A (H/M/L)                             | 41/39/35                                       |                            |                     | -                                      |                |            | -    | -      | -     |
|  | Power Level dB                           | 58/56/52                                       |                            |                     | -                                      |                |            | -    | -      | -     |
| Noise outdoor  | dB-A (H/L)                               | -  |                            |                     | 54/-                                   |                |            | -    | -      | -     |
|  | Power Level dB                           | -  |                            |                     | 70/-                                   |                |            | -    | -      | -     |
| Capacity   | kW                                       | 10.0   | 10.0                       | 10.0                | -                                      | -              | -          | 2.1  | 13.8   | -     |
|  | BTU/h                                    | 34100  | 34100                      | 34100               | -                                      | -              | -          | 7200 | 47100  | -     |
| Current  | A  | 0.54×2   | 0.55×2                     | 0.56×2              | 4.40                                   | 4.20           | 4.00       | -    | -      | -     |
|  | W  | 115×2  | 120×2                      | 125×2               | 2.690k                                 | 2.690k         | 2.690k     | -    | -      | -     |
| Input power  | TOTAL W                                  | -  |                            |                     | 2.920k                                 | 2.930k         | 2.940k     | 450  | 4.100k | -     |
|  | COP/COP CLASS                            | TOTAL (W/W) <sup>5</sup> ("A"~"G")             | -                          | -                   | -                                      | 3.42           | 3.41 / B   | 3.40 | 4.67   | 3.37  |
| E <sub>rp</sub> *6                                       | Pdesign at -10°C                         | kW   | -                          | -                   | -                                      | -              | 7.5        | -    | -      | -     |
|  | Tbivalent                                | °C   | -                          | -                   | -                                      | -              | -9         | -    | -      | -     |
|  | SCOP                                     | (W/W)  | -                          | -                   | -                                      | -              | 3.8        | -    | -      | -     |
|  | Annual consumption                       | kWh  | -                          | -                   | -                                      | -              | 2761       | -    | -      | -     |
| Class  |  | -  | -                          | -                   | -                                      | A              | -          | -    | -      |       |
| Power factor   | %  | -  | -                          | -                   | 93                                     | 93             | 94         | -    | -      | -     |
| Noise indoor   | dB-A (H/M/L)                             | 41/39/35                                       |                            |                     | -                                      |                |            | -    | -      | -     |
|  | Power Level dB                           | 58/56/52                                       |                            |                     | -                                      |                |            | -    | -      | -     |
| Noise outdoor  | dB-A (H/L)                               | -  |                            |                     | 54/-                                   |                |            | -    | -      | -     |
|  | Power Level dB                           | -  |                            |                     | 70/-                                   |                |            | -    | -      | -     |
| EXTRA LOW TEMP Total capacity(kW) / Input power(W) / COP |  |  |                            |                     | -                                      |                |            |      |        |       |
| Max Current(A) / Max Input power(W)                      |  | 0.74×2/165×2                                   | 0.76×2/180×2               | 0.78×2/190×2        | 9.0/5.550k                             | 9.0/5.800k     | 9.0/6.050k | -    |        |       |
| Starting current(A) / Comp output(W)                     |  | -  | -                          | -                   | 5.45/1.7k                              | 5.20/1.7k      | 5.00/1.7k  | -    |        |       |
| Network Impedance(ΩMAX.)                                 |  | -  |                            |                     | -                                      |                |            | -    |        |       |
| Fan motor output (Indoor/Outdoor) W                      |  | 85×2   |                            |                     | 90                                     |                |            | -    |        |       |
| Moisture removal volume                                  |  | L/h(Pt/h)                                      | 6.0                        | (3.0×2)             | (12.6)                                 | -              |            |      | -      |       |
| External static pressure                                 |  | Pa   | 50 (MIN10 - MAX80)         |                     |  | -              |            |      | -      |       |
| Indoor Air flow  | Cooling                                  | m³/min (ft³/min)                               | [16/13/11 (565/459/388)]×2 |                     |  | -              |            |      | -      |       |
|  | Heating                                  | m³/min (ft³/min)                               | [16/13/11 (565/459/388)]×2 |                     |  | -              |            |      | -      |       |
| Outdoor Air flow   | Cooling                                  | m³/min (ft³/min)                               | -                          |                     |  | 76             | (2684)     | -    |        |       |
|  | Heating                                  | m³/min (ft³/min)                               | -                          |                     |  | 67             | (2366)     | -    |        |       |
| Refrigerant type / amount g(oz)                          |  | -  |                            |                     | R410A                                  | 2.60k          | (91.7)     | -    |        |       |
| Product dimension  | Height                                   | mm(inch)                                       | 250 (9-27/32)              |                     |  | 996 (39-7/32)  |            |      | -      |       |
|  | Width                                    | mm(inch)                                       | 780 (+100)                 | 30-23/32 (+3-15/16) |  | 940 (37-1/32)  |            |      | -      |       |
|  | Depth                                    | mm(inch)                                       | 650 (25-19/32)             |                     |  | 340 (13-13/32) |            |      | -      |       |
| Packing dimension  | Height                                   | mm(inch)                                       | 345                        |                     |  | 1136           |            |      | -      |       |
|  | Width                                    | mm(inch)                                       | 1007                       |                     |  | 1055           |            |      | -      |       |
|  | Depth                                    | mm(inch)                                       | 777                        |                     |  | 485            |            |      | -      |       |
| Weight   | (NET)                                    | kg(lb)   | 29 (64)                    |                     |  | 73 (161)       |            |      | -      |       |
|  | (GROSS)                                  | kg(lb)   | 34 (75)                    |                     |  | 81 (179)       |            |      | -      |       |
| Layers limit (actually)                                  |  | 8 (9)  |                            |                     | 2 (3)                                  |                |            | -    |        |       |
| Operation condition                                      | Cool (DBT)                               | 18°C ~ 32°C                                    |                            |                     | -10°C ~ 43°C                           |                |            | -    |        |       |
|  | Heat (DBT)                               | 16°C ~ 30°C                                    |                            |                     | -15°C ~ 24°C                           |                |            | -    |        |       |
| P I P I N G  | Pipe diameter mm (inch)                  | (Liquid)∅6.35(1/4) (Gas)∅12.7(1/2)             |                            |                     | (Liquid)∅9.52(3/8) (Gas)∅15.88(5/8)    |                |            | -    |        |       |
|  | Connecting method, Standard length m(ft) | flared type, 5.0(16.4)                         |                            |                     | flared type, 5.0(16.4)                 |                |            | -    |        |       |
| Pipe length range  |  | m (ft)   |                            |                     | 5 ~ 50 (16.4 ~ 164.0)                  |                |            | -    |        |       |
| Indoor unit & Outdoor unit height difference m (ft)      |  | 15 (OD located lower) / 30 (OD located higher) |                            |                     | (49.2/98.4)                            |                |            | -    |        |       |
| Add gas amount g/m (oz/ft)                               |  | 50   |                            |                     | (0.538)                                |                |            | -    |        |       |
| Pipe length for additional gas                           |  | m (ft)   |                            |                     | 30 (98.4)                              |                |            | -    |        |       |

\*1: In case it is necessary to indicate the air flow volume in (l/s), the value in (m³/min.) shall be multiplied by 16.7 and rounded down the decimal point.

\*2: If the EUROVENT Certified models can be operated under the "extra-low" temperature condition, -7°C dry bulb and -8°C wet-bulb temperatures with rated voltage 230 V shall be used.

\*3: Network Impedance shall be applicable for EUROPE and CHINA models.

\*4: The annual consumption is calculated by multiplying the input power at 230 V (400 V) by an average of 500 hours per year in cooling mode.

\*5: EER and COP classification is at 230 V (400 V) only in accordance with EU directive 2002/31/EC.

\*6: SEER and SCOP classification is at 230V(400V) only in accordance with EN-14825. For heating, SCOP indicates the value of only Average heating season, Other fiche data indicates in an attached sheet.

# Simultaneous (Twin) -Type

## 1-1. Unit Specifications

**PEY1**

### 11. Ducted Type S-60PN1E5A×2 / U-125PEY1E8

| INDOOR   |  | MODEL  | S-60PN1E5A×2                       |              |                                     | -              |             |          | -     |        |      |
|--|--|--|------------------------------------|--------------|-------------------------------------|----------------|-------------|----------|-------|--------|------|
| PANEL  |  | MODEL  | -                                  |              |                                     | -              |             |          | -     |        |      |
| OUTDOOR  |  | MODEL  | -                                  |              |                                     | U-125PEY1E8    |             |          | -     |        |      |
| Branch pipe  |  | MODEL  | -                                  |              |                                     | CZ-P155BK1     |             |          | -     |        |      |
| Performance test condition                                 |  | ISO13253 / EN14511 / EN12102 / EN14825         |                                    |              |                                     |                |             |          |       |        |      |
| Power supply   |  | Ø, Hz  | 1ø 50Hz                            |              |                                     | 3ø 50Hz        |             |          |       |        |      |
|  |  | V  | 220                                | 230          | 240                                 | 380            | 400         | 415      | Min   | Max    |      |
| C<br>O<br>O<br>L<br>I<br>N<br>G                            | Capacity                                 | kW   | 12.5                               | 12.5         | 12.5                                | -              | -           | -        | 3.8   | 13.5   |      |
|  |  | BTU/h  | 42700                              | 42700        | 42700                               | -              | -           | -        | 13000 | 46100  |      |
|  | Current                                  | A  | 1.12×2                             | 1.08×2       | 1.04×2                              | 6.75           | 6.40        | 6.20     | -     | -      |      |
|  |  | W  | 140×2                              | 140×2        | 140×2                               | 4.165k         | 4.165k      | 4.165k   | -     | -      |      |
|  | Input power                              | TOTAL W  | -                                  |              |                                     | 4.445k         | 4.445k      | 4.445k   | 950   | 5.200k |      |
|  |  | Annual consumption                             | TOTAL kWh *4                       | -            |                                     |                | -           | 2223     | -     | -      | -    |
|  | EER/EER CLASS                            | TOTAL (W/W) <sup>5</sup> ("A"~"G")             | -                                  | -            | -                                   | 2.81           | 2.81 / C    | 2.81     | 4.00  | 2.60   |      |
|  | Erp *6                                   | Pdesign  | kW                                 | -            | -                                   | -              | -           | 12.5     | -     | -      | -    |
|  |  | η <sub>s,c</sub>                               | %                                  | -            | -                                   | -              | -           | 206.9    | -     | -      | -    |
|  |  | Annual consumption                             | kWh                                | -            | -                                   | -              | -           | -        | -     | -      | -    |
| Class  |  |  | -                                  | -            | -                                   | -              | -           | -        | -     | -      |      |
| Power factor   | %  | -  | -                                  | -            | 94                                  | 94             | 94          | -        | -     |        |      |
| Noise indoor   | dB-A (H/M/L)                             | 43/41/36                                       |                                    |              | -                                   |                |             | -        | -     |        |      |
|  | Power Level dB                           | 60/58/53                                       |                                    |              | -                                   |                |             | -        | -     |        |      |
| Noise outdoor  | dB-A (H/L)                               | -  |                                    |              | 56/-                                |                |             | -        | -     |        |      |
|  | Power Level dB                           | -  |                                    |              | 73/-                                |                |             | -        | -     |        |      |
| H<br>E<br>A<br>T<br>I<br>N<br>G                            | Capacity                                 | kW   | 12.5                               | 12.5         | 12.5                                | -              | -           | -        | 3.4   | 15.0   |      |
|  |  | BTU/h  | 42700                              | 42700        | 42700                               | -              | -           | -        | 11600 | 51200  |      |
|  | Current                                  | A  | 1.12×2                             | 1.08×2       | 1.04×2                              | 5.45           | 5.20        | 5.00     | -     | -      |      |
|  |  | W  | 140×2                              | 140×2        | 140×2                               | 3.385k         | 3.385k      | 3.385k   | -     | -      |      |
|  | Input power                              | TOTAL W  | -                                  |              |                                     | 3.665k         | 3.665k      | 3.665k   | 780   | 4.600k |      |
|  |  | COP/COP CLASS                                  | TOTAL (W/W) <sup>5</sup> ("A"~"G") | -            | -                                   | -              | 3.41        | 3.41 / B | 3.41  | 4.36   | 3.26 |
|  | Erp *6                                   | Pdesign at -10°C                               | kW                                 | -            | -                                   | -              | -           | 12.5     | -     | -      | -    |
|  |  | Tbivalent                                      | °C                                 | -            | -                                   | -              | -           | -7       | -     | -      | -    |
|  |  | η <sub>s,h</sub>                               | %                                  | -            | -                                   | -              | -           | 138.5    | -     | -      | -    |
|  |  | Annual consumption                             | kWh                                | -            | -                                   | -              | -           | -        | -     | -      | -    |
| Class  |  | -  | -                                  | -            | -                                   | -              | -           | -        | -     |        |      |
| Power factor   | %  | -  | -                                  | -            | 94                                  | 94             | 94          | -        | -     |        |      |
| Noise indoor   | dB-A (H/M/L)                             | 43/41/36                                       |                                    |              | -                                   |                |             | -        | -     |        |      |
|  | Power Level dB                           | 60/58/53                                       |                                    |              | -                                   |                |             | -        | -     |        |      |
| Noise outdoor  | dB-A (H/L)                               | -  |                                    |              | 56/-                                |                |             | -        | -     |        |      |
|  | Power Level dB                           | -  |                                    |              | 73/-                                |                |             | -        | -     |        |      |
| EXTRA LOW TEMP   Total capacity(kW) / Input power(W) / COP |  | -  |                                    |              |                                     |                |             |          |       |        |      |
| Max Current(A) / Max Input power(W)                        |  | 1.28×2/160×2                                   | 1.24×2/160×2                       | 1.20×2/160×2 | 10.0/6.200k                         | 10.0/6.500k    | 10.0/6.750k | -        |       |        |      |
| Starting current(A) / Comp output(W)                       |  | -  | -                                  | -            | 6.75/3.0k                           | 6.40/3.0k      | 6.20/3.0k   | -        |       |        |      |
| Network Impedance(ΩMAX.)                                   |  | -  |                                    |              |                                     |                |             |          |       |        |      |
| Fan motor output (Indoor/Outdoor) W                        |  | 120×2  |                                    |              | 90                                  |                |             | -        |       |        |      |
| Moisture removal volume                                    |  | L/h(Pt/h)                                      | 7.9                                | (3.95×2)     | (16.6)                              | -              |             |          | -     |        |      |
| External static pressure                                   |  | Pa   | 50 (MIN10 ~ MAX80)                 |              |                                     | -              |             |          | -     |        |      |
| Indoor Air flow  | Cooling                                  | m³/min (ft³/min)                               | [22/20/16 (777/706/565)]×2         |              |                                     | -              |             |          | -     |        |      |
|  | Heating                                  | m³/min (ft³/min)                               | [22/20/16 (777/706/565)]×2         |              |                                     | -              |             |          | -     |        |      |
| Outdoor Air flow   | Cooling                                  | m³/min (ft³/min)                               | -                                  |              |                                     | 80             | (2825)      | -        |       |        |      |
|  | Heating                                  | m³/min (ft³/min)                               | -                                  |              |                                     | 73             | (2578)      | -        |       |        |      |
| Refrigerant type / amount g(oz)                            |  | -  |                                    |              | R410A                               | 3.20k          | (112.9)     | -        |       |        |      |
| Product dimension  | Height                                   | mm(inch)                                       | 250 (9-27/32)                      |              |                                     | 996 (39-7/32)  |             |          | -     |        |      |
|  | Width                                    | mm(inch)                                       | 1000 (+100) (39-5/16) (+3-15/16)   |              |                                     | 940 (37-1/32)  |             |          | -     |        |      |
|  | Depth                                    | mm(inch)                                       | 650 (25-19/32)                     |              |                                     | 340 (13-13/32) |             |          | -     |        |      |
| Packing dimension  | Height                                   | mm(inch)                                       | 338                                |              |                                     | 1136           |             |          | -     |        |      |
|  | Width                                    | mm(inch)                                       | 1211                               |              |                                     | 1055           |             |          | -     |        |      |
|  | Depth                                    | mm(inch)                                       | 761                                |              |                                     | 485            |             |          | -     |        |      |
| Weight   | (NET)                                    | kg(lb)   | 32 (71)                            |              |                                     | 85 (188)       |             |          | -     |        |      |
|  | (GROSS)                                  | kg(lb)   | 38 (84)                            |              |                                     | 93 (205)       |             |          | -     |        |      |
| Layers limit (actually)                                    |  | 6 (7)  |                                    |              | 2 (3)                               |                |             | -        |       |        |      |
| Operation condition  | Cool (DBT)                               | 18°C ~ 32°C                                    |                                    |              | -10°C ~ 43°C                        |                |             | -        |       |        |      |
|  | Heat (DBT)                               | 16°C ~ 30°C                                    |                                    |              | -15°C ~ 24°C                        |                |             | -        |       |        |      |
| P<br>I<br>P<br>I<br>N<br>G                                 | Pipe diameter mm (inch)                  | (Liquid)ø9.52(3/8) (Gas)ø15.88(5/8)            |                                    |              | (Liquid)ø9.52(3/8) (Gas)ø15.88(5/8) |                |             | -        |       |        |      |
|  | Connecting method, Standard length m(ft) | flared type, 5.0(16.4)                         |                                    |              | flared type, 5.0(16.4)              |                |             | -        |       |        |      |
| Pipe length range  |  | m (ft)   |                                    |              | 5 ~ 50 (16.4 ~ 164.0)               |                |             | -        |       |        |      |
| Indoor unit & Outdoor unit height difference m (ft)        |  | 15 (OD located lower) / 30 (OD located higher) |                                    |              | (49.2/98.4)                         |                |             | -        |       |        |      |
| Add gas amount g/m (oz/ft)                                 |  | 50   |                                    |              | (0.538)                             |                |             | -        |       |        |      |
| Pipe length for additional gas                             |  | m (ft)   |                                    |              | 30 (98.4)                           |                |             | -        |       |        |      |

\*1: In case it is necessary to indicate the air flow volume in (l/s), the value in (m³/min.) shall be multiplied by 16.7 and rounded down the decimal point.

\*2: If the EUROVENT Certified models can be operated under the "extra-low" temperature condition, -7°C dry bulb and -8°C wet-bulb temperatures with rated voltage 230 V shall be used.

\*3: Network Impedance shall be applicable for EUROPE and CHINA models.

\*4: The annual consumption is calculated by multiplying the input power at 230 V (400 V) by an average of 500 hours per year in cooling mode.

\*5: EER and COP classification is at 230 V (400 V) only in accordance with EU directive 2002/31/EC.

\*6: SEER and SCOP classification is at 230V(400V) only in accordance with EN-14825. For heating, SCOP indicates the value of only Average heating season.



# Simultaneous (Twin) -Type

## 1-1. Unit Specifications

**PEY1**

### 11. Ducted Type S-71PN1E5A×2 / U-140PEY1E8

|  |  |  |                                  |              |                                     |                |             |       |        |       |
|--|--|--|----------------------------------|--------------|-------------------------------------|----------------|-------------|-------|--------|-------|
| INDOOR   |  | MODEL  | S-71PN1E5A×2                     |              |                                     | -              |             |       | -      |       |
| PANEL  |  | MODEL  | -                                |              |                                     | -              |             |       | -      |       |
| OUTDOOR  |  | MODEL  | -                                |              |                                     | U-140PEY1E8    |             |       | -      |       |
| Branch pipe  |  | MODEL  | -                                |              |                                     | CZ-P155BK1     |             |       | -      |       |
| Performance test condition                                 |  | ISO13253 / EN14511 / EN12102 / EN14825         |                                  |              |                                     |                |             |       |        |       |
| Power supply   |  | Ø, Hz  | 1ø 50Hz                          |              |                                     | 3ø 50Hz        |             |       |        |       |
|  |  | V  | 220                              | 230          | 240                                 | 380            | 400         | 415   | Min    | Max   |
| Capacity   | kW                                       | 14.0   | 14.0                             | 14.0         | -                                   | -              | -           | -     | 3.3    | 15.5  |
|  | BTU/h                                    | 47800  | 47800                            | 47800        | -                                   | -              | -           | -     | 11300  | 52900 |
| Current  | A  | 1.12×2   | 1.08×2                           | 1.04×2       | 7.05                                | 6.70           | 6.45        | -     | -      | -     |
|  | W  | 140×2  | 140×2                            | 140×2        | 4.450k                              | 4.450k         | 4.450k      | -     | -      | -     |
| Input power  | TOTAL W                                  | -  |                                  |              | 4.730k                              | 4.730k         | 4.730k      | 840   | 6.000k | -     |
|  | Annual consumption                       | TOTAL kWh *4                                   | -                                |              |                                     | -              | 2365        | -     | -      | -     |
| EER/EER CLASS  | TOTAL (W/W) *5 / ("A"-G)                 | -  | -                                | -            | 2.96                                | 2.96 / A       | 2.96        | 3.93  | 2.58   | -     |
| Erp *6   | Pdesign                                  | kW   | -                                | -            | -                                   | -              | 14.0        | -     | -      | -     |
|  | η s.c                                    | %  | -                                | -            | -                                   | -              | 215.9       | -     | -      | -     |
|  | Annual consumption                       | kWh  | -                                | -            | -                                   | -              | -           | -     | -      | -     |
|  | Class                                    |  | -                                | -            | -                                   | -              | -           | -     | -      | -     |
| Power factor   | %  | -  | -                                | -            | 96                                  | 96             | 96          | -     | -      | -     |
| Noise indoor   | dB-A (H/M/L)                             | 43/41/36                                       |                                  |              | -                                   |                |             | -     | -      | -     |
|  | Power Level dB                           | 60/58/53                                       |                                  |              | -                                   |                |             | -     | -      | -     |
| Noise outdoor  | dB-A (H/L)                               | -  |                                  |              | 54/-                                |                |             | -     | -      | -     |
|  | Power Level dB                           | -  |                                  |              | 71/-                                |                |             | -     | -      | -     |
| Capacity   | kW                                       | 14.0   | 14.0                             | 14.0         | -                                   | -              | -           | 4.1   | 16.0   | -     |
|  | BTU/h                                    | 47800  | 47800                            | 47800        | -                                   | -              | -           | 14000 | 54600  | -     |
| Current  | A  | 1.12×2   | 1.08×2                           | 1.04×2       | 5.90                                | 5.60           | 5.40        | -     | -      | -     |
|  | W  | 140×2  | 140×2                            | 140×2        | 3.730k                              | 3.730k         | 3.730k      | -     | -      | -     |
| Input power  | TOTAL W                                  | -  |                                  |              | 4.010k                              | 4.010k         | 4.010k      | 900   | 5.200k | -     |
|  | COP/COP CLASS                            | TOTAL (W/W) *5 / ("A"-G)                       | -                                | -            | -                                   | 3.49           | 3.49 / A    | 3.49  | 4.56   | 3.08  |
| Erp *6   | Pdesign at -10°C                         | kW   | -                                | -            | -                                   | -              | 14.0        | -     | -      | -     |
|  | Tbivalent                                | °C   | -                                | -            | -                                   | -              | -7          | -     | -      | -     |
|  | η s.h                                    | %  | -                                | -            | -                                   | -              | 138.2       | -     | -      | -     |
|  | Annual consumption                       | kWh  | -                                | -            | -                                   | -              | -           | -     | -      | -     |
| Class  |  | -  | -                                | -            | -                                   | -              | -           | -     | -      |       |
| Power factor   | %  | -  | -                                | -            | 96                                  | 96             | 96          | -     | -      | -     |
| Noise indoor   | dB-A (H/M/L)                             | 43/41/36                                       |                                  |              | -                                   |                |             | -     | -      | -     |
|  | Power Level dB                           | 60/58/53                                       |                                  |              | -                                   |                |             | -     | -      | -     |
| Noise outdoor  | dB-A (H/L)                               | -  |                                  |              | 53/-                                |                |             | -     | -      | -     |
|  | Power Level dB                           | -  |                                  |              | 70/-                                |                |             | -     | -      | -     |
| EXTRA LOW TEMP   Total capacity(kW) / Input power(W) / COP |  | -  |                                  |              |                                     |                |             |       |        |       |
| Max Current(A) / Max Input power(W)                        |  | 1.28×2/160×2                                   | 1.24×2/160×2                     | 1.20×2/160×2 | 10.0/6.200k                         | 10.0/6.500k    | 10.0/6.750k | -     |        |       |
| Starting current(A) / Comp output(W)                       |  | -  | -                                | -            | 7.05/3.0k                           | 6.70/3.0k      | 6.45/3.0k   | -     |        |       |
| Network Impedance(ΩMAX.)                                   |  | -  |                                  |              |                                     |                |             |       |        |       |
| Fan motor output (Indoor/Outdoor) W                        |  | 120  |                                  |              | 90×2                                |                |             | -     |        |       |
| Moisture removal volume                                    |  | L/h(Pt/h)                                      | 9.0                              | (4.5×2)      | (18.9)                              | -              |             |       | -      |       |
| External static pressure                                   |  | Pa   | 50 (MIN10 - MAX80)               |              |                                     | -              |             |       | -      |       |
| Indoor Air flow  | Cooling                                  | m³/min (ft³/min)                               | [22/20/16 (777/706/565)]×2       |              |                                     | -              |             |       | -      |       |
|  | Heating                                  | m³/min (ft³/min)                               | [22/20/16 (777/706/565)]×2       |              |                                     | -              |             |       | -      |       |
| Outdoor Air flow   | Cooling                                  | m³/min (ft³/min)                               | -                                |              |                                     | 135            | (4767)      | -     |        |       |
|  | Heating                                  | m³/min (ft³/min)                               | -                                |              |                                     | 120            | (4238)      | -     |        |       |
| Refrigerant type / amount g(oz)                            |  | -  |                                  |              | R410A                               | 3.40k          | (119.9)     | -     |        |       |
| Product dimension  | Height                                   | mm(inch)                                       | 250 (9-27/32)                    |              |                                     | 1416 (55-3/4)  |             |       | -      |       |
|  | Width                                    | mm(inch)                                       | 1000 (+100) (39-5/16) (+3-15/16) |              |                                     | 940 (37-1/32)  |             |       | -      |       |
|  | Depth                                    | mm(inch)                                       | 650 (25-19/32)                   |              |                                     | 340 (13-13/32) |             |       | -      |       |
| Packing dimension  | Height                                   | mm(inch)                                       | 338                              |              |                                     | 1556           |             |       | -      |       |
|  | Width                                    | mm(inch)                                       | 1211                             |              |                                     | 1055           |             |       | -      |       |
|  | Depth                                    | mm(inch)                                       | 761                              |              |                                     | 485            |             |       | -      |       |
| Weight   | (NET)                                    | kg(lb)   | 32 (71)                          |              |                                     | 98 (216)       |             |       | -      |       |
|  | (GROSS)                                  | kg(lb)   | 38 (84)                          |              |                                     | 108 (238)      |             |       | -      |       |
| Layers limit (actually)                                    |  | 6 (7)  |                                  |              | 1 (2)                               |                |             | -     |        |       |
| Operation condition  | Cool (DBT)                               | 18°C ~ 32°C                                    |                                  |              | -10°C ~ 43°C                        |                |             | -     |        |       |
|  | Heat (DBT)                               | 16°C ~ 30°C                                    |                                  |              | -15°C ~ 24°C                        |                |             | -     |        |       |
| P I P I N G  | Pipe diameter mm (inch)                  | (Liquid)ø9.52(3/8) (Gas)ø15.88(5/8)            |                                  |              | (Liquid)ø9.52(3/8) (Gas)ø15.88(5/8) |                |             | -     |        |       |
|  | Connecting method, Standard length m(ft) | flared type, 5.0(16.4)                         |                                  |              | flared type, 5.0(16.4)              |                |             | -     |        |       |
| Pipe length range  |  | m (ft)   |                                  |              | 5 ~ 50 (16.4 ~ 164.0)               |                |             | -     |        |       |
| Indoor unit & Outdoor unit height difference m (ft)        |  | 15 (OD located lower) / 30 (OD located higher) |                                  |              | (49.2/98.4)                         |                |             | -     |        |       |
| Add gas amount g/m (oz/ft)                                 |  | 50 (0.538)                                     |                                  |              | -                                   |                |             | -     |        |       |
| Pipe length for additional gas                             |  | m (ft)   |                                  |              | 30 (98.4)                           |                |             | -     |        |       |

\*1: In case it is necessary to indicate the air flow volume in (l/s), the value in (m³/min.) shall be multiplied by 16.7 and rounded down the decimal point.  
 \*2: If the EUROVENT Certified models can be operated under the "extra-low" temperature condition, -7°C dry bulb and -8°C wet-bulb temperatures with rated voltage 230 V shall be used.  
 \*3: Network Impedance shall be applicable for EUROPE and CHINA models.  
 \*4: The annual consumption is calculated by multiplying the input power at 230 V (400 V) by an average of 500 hours per year in cooling mode.  
 \*5: EER and COP classification is at 230 V (400 V) only in accordance with EU directive 2002/31/EC.  
 \*6: SEER and SCOP classification is at 230V(400V) only in accordance with EN-14825. For heating, SCOP indicates the value of only Average heating season.

# Single -Type

## 1-1. Unit Specifications

**PEY1**

### 11. Ducted Type S-100PN1E5A / U-100PEY1E8

| INDOOR   | MODEL   | S-100PN1E5A                                    |                                 |          | -                                   |                |            | -      |      |        |
|--|---|--|---------------------------------|----------|-------------------------------------|----------------|------------|--------|------|--------|
| PANEL  | MODEL   | -  |                                 |          | -                                   |                |            | -      |      |        |
| OUTDOOR  | MODEL   | -  |                                 |          | U-100PEY1E8                         |                |            | -      |      |        |
| Branch pipe  | MODEL   | -  |                                 |          | -                                   |                |            | -      |      |        |
| Performance test condition                                 |   | ISO13253 / EN14511 / EN14825 / EN12102         |                                 |          |                                     |                |            |        |      |        |
| Power supply   |   | Ø, Hz  | 1ø 50Hz                         |          |                                     | 3ø 50Hz        |            |        | Min  | Max    |
|  |   | V  | 220                             | 230      | 240                                 | 380            | 400        | 415    |      |        |
| C<br>O<br>O<br>L<br>I<br>N<br>G                            | Capacity  | kW   | 10.0                            | 10.0     | 10.0                                | -              | -          | -      | 2.7  | 11.5   |
|  |   | BTU/h  | 34100                           | 34100    | 34100                               | -              | -          | -      | 9200 | 39200  |
|  | Current   | A  | 1.54                            | 1.48     | 1.42                                | 5.45           | 5.20       | 5.05   | -    | -      |
|  | Input power   | W  | 205                             | 205      | 205                                 | 3.350k         | 3.350k     | 3.350k | -    | -      |
|  |   | TOTAL W  | -                               |          |                                     | 3.555k         | 3.555k     | 3.555k | 570  | 4.300k |
|  | Annual consumption                                  | TOTAL kWh *4                                   | -                               |          |                                     | -              | 1778       | -      | -    | -      |
|  | EER/EER CLASS                                       | TOTAL (W/W) <sup>*5</sup> ("A"~"G")            | -                               | -        | -                                   | 2.81           | 2.81 / C   | 2.81   | 4.74 | 2.67   |
|  | E <sub>rp</sub> <sup>*6</sup>                       | Pdesign  | kW                              | -        | -                                   | -              | -          | 10.0   | -    | -      |
|  |   | SEER   | (W/W)                           | -        | -                                   | -              | -          | 5.2    | -    | -      |
|  |   | Annual consumption                             | kWh                             | -        | -                                   | -              | -          | 677    | -    | -      |
| Class  |   |  | -                               | -        | -                                   | -              | A          | -      | -    |        |
| Power factor   | %   | -  | -                               | -        | 94                                  | 93             | 92         | -      | -    |        |
| Noise indoor   | dB-A (H/M/L)  | 44/42/37                                       |                                 |          | -                                   |                |            | -      | -    |        |
|  | Power Level dB                                      | 65/63/58                                       |                                 |          | -                                   |                |            | -      | -    |        |
| Noise outdoor  | dB-A (H/L)  | -  |                                 |          | 54/-                                |                |            | -      | -    |        |
|  | Power Level dB                                      | -  |                                 |          | 70/-                                |                |            | -      | -    |        |
| H<br>E<br>A<br>T<br>I<br>N<br>G                            | Capacity  | kW   | 10.0                            | 10.0     | 10.0                                | -              | -          | -      | 2.1  | 13.8   |
|  |   | BTU/h  | 34100                           | 34100    | 34100                               | -              | -          | -      | 7200 | 47100  |
|  | Current   | A  | 1.54                            | 1.48     | 1.42                                | 4.45           | 4.25       | 4.10   | -    | -      |
|  | Input power   | W  | 205                             | 205      | 205                                 | 2.730k         | 2.730k     | 2.730k | -    | -      |
|  |   | TOTAL W  | -                               |          |                                     | 2.935k         | 2.935k     | 2.935k | 450  | 4.100k |
|  | COP/COP CLASS                                       | TOTAL (W/W) <sup>*5</sup> ("A"~"G")            | -                               | -        | -                                   | 3.41           | 3.41 / B   | 3.41   | 4.67 | 3.37   |
|  | E <sub>rp</sub> <sup>*6</sup>                       | Pdesign at -10°C                               | kW                              | -        | -                                   | -              | -          | 7.6    | -    | -      |
|  |   | Tbivalent                                      | °C                              | -        | -                                   | -              | -          | -10    | -    | -      |
|  |   | SCOP   | (W/W)                           | -        | -                                   | -              | -          | 3.8    | -    | -      |
|  |   | Annual consumption                             | kWh                             | -        | -                                   | -              | -          | 2800   | -    | -      |
| Class  |   | -  | -                               | -        | -                                   | A              | -          | -      |      |        |
| Power factor   | %   | -  | -                               | -        | 93                                  | 93             | 93         | -      | -    |        |
| Noise indoor   | dB-A (H/M/L)  | 44/42/37                                       |                                 |          | -                                   |                |            | -      | -    |        |
|  | Power Level dB                                      | 65/63/58                                       |                                 |          | -                                   |                |            | -      | -    |        |
| Noise outdoor  | dB-A (H/L)  | -  |                                 |          | 54/-                                |                |            | -      | -    |        |
|  | Power Level dB                                      | -  |                                 |          | 70/-                                |                |            | -      | -    |        |
| EXTRA LOW TEMP   Total capacity(kW) / Input power(W) / COP |   | -  |                                 |          |                                     |                |            |        |      |        |
| Max Current(A) / Max Input power(W)                        |   | 2.13/275                                       | 2.07/275                        | 2.01/275 | 9.0/5.550k                          | 9.0/5.800k     | 9.0/6.050k | -      |      |        |
| Starting current(A) / Comp output(W)                       |   | -  | -                               | -        | 5.45/1.7k                           | 5.20/1.7k      | 5.05/1.7k  | -      |      |        |
| Network Impedance(ΩMAX.)                                   |   | -  |                                 |          |                                     |                |            |        |      |        |
| Fan motor output (Indoor/Outdoor) W                        |   | 200  |                                 |          | 90                                  |                |            | -      |      |        |
| Moisture removal volume                                    |   | L/h(Pt/h)                                      | 6.0 (12.6)                      |          |                                     | -              |            |        | -    |        |
| External static pressure                                   |   | Pa   | 50 (MIN10 ~ MAX80)              |          |                                     | -              |            |        | -    |        |
| Indoor Air flow  | Cooling   | m³/min (ft³/min)                               | 36/33/26 (1271/1165/918)        |          |                                     | -              |            |        | -    |        |
|  | Heating   | m³/min (ft³/min)                               | 36/33/26 (1271/1165/918)        |          |                                     | -              |            |        | -    |        |
| Outdoor Air flow   | Cooling   | m³/min (ft³/min)                               | -                               |          |                                     | 76 (2684)      |            |        | -    |        |
|  | Heating   | m³/min (ft³/min)                               | -                               |          |                                     | 67 (2366)      |            |        | -    |        |
| Refrigerant type / amount g(oz)                            |   | -  |                                 |          | R410A                               | 2.60k (91.7)   |            | -      |      |        |
| Product dimension  | Height  | mm(inch)                                       | 250 (9-27/32)                   |          |                                     | 996 (39-7/32)  |            |        | -    |        |
|  | Width   | mm(inch)                                       | 1200 (+100) (47-1/4) (+3-15/16) |          |                                     | 940 (37-1/32)  |            |        | -    |        |
|  | Depth   | mm(inch)                                       | 650 (25-19/32)                  |          |                                     | 340 (13-13/32) |            |        | -    |        |
| Packing dimension  | Height  | mm(inch)                                       | 338                             |          |                                     | 1136           |            |        | -    |        |
|  | Width   | mm(inch)                                       | 1402                            |          |                                     | 1055           |            |        | -    |        |
|  | Depth   | mm(inch)                                       | 761                             |          |                                     | 485            |            |        | -    |        |
| Weight   | (NET)   | kg(lb)   | 41 (91)                         |          |                                     | 73 (161)       |            |        | -    |        |
|  | (GROSS)   | kg(lb)   | 48 (106)                        |          |                                     | 81 (179)       |            |        | -    |        |
| Layers limit (actually)                                    |   | 6 (7)  |                                 |          | 2 (3)                               |                |            | -      |      |        |
| Operation condition  | Cool (DBT)  | 18°C ~ 32°C                                    |                                 |          | -10°C ~ 43°C                        |                |            | -      |      |        |
|  | Heat (DBT)  | 16°C ~ 30°C                                    |                                 |          | -15°C ~ 24°C                        |                |            | -      |      |        |
| P<br>I<br>P<br>I<br>N<br>G                                 | Pipe diameter mm (inch)                             | (Liquid)ø9.52(3/8) (Gas)ø15.88(5/8)            |                                 |          | (Liquid)ø9.52(3/8) (Gas)ø15.88(5/8) |                |            | -      |      |        |
|  | Connecting method, Standard length m(ft)            | flared type, 5.0(16.4)                         |                                 |          | flared type, 5.0(16.4)              |                |            | -      |      |        |
|  | Pipe length range                                   | m (ft)   |                                 |          | 5 ~ 50 (16.4 ~ 164.0)               |                |            | -      |      |        |
|  | Indoor unit & Outdoor unit height difference m (ft) | 15 (OD located lower) / 30 (OD located higher) |                                 |          | (49.2/98.4)                         |                |            | -      |      |        |
|  | Add gas amount g/m (oz/ft)                          | 50 (0.538)                                     |                                 |          | -                                   |                |            | -      |      |        |
|  | Pipe length for additional gas                      | m (ft)   |                                 |          | 30 (98.4)                           |                |            | -      |      |        |

\*1: In case it is necessary to indicate the air flow volume in (l/s), the value in (m³/min.) shall be multiplied by 16.7 and rounded down the decimal point.

\*2: If the EUROVENT Certified models can be operated under the "extra-low" temperature condition, -7°C dry bulb and -8°C wet-bulb temperatures with rated voltage 230 V shall be used.

\*3: Network Impedance shall be applicable for EUROPE and CHINA models.

\*4: The annual consumption is calculated by multiplying the input power at 230 V (400 V) by an average of 500 hours per year in cooling mode.

\*5: EER and COP classification is at 230 V (400 V) only in accordance with EU directive 2002/31/EC.

\*6: SEER and SCOP classification is at 230V(400V) only in accordance with EN-14825. For heating, SCOP indicates the value of only Average heating season, Other fiche data indicates in an attached sheet.

# Single -Type

## 1-1. Unit Specifications

**PEY1**

### 11. Ducted Type S-125PN1E5A / U-125PEY1E8

| INDOOR   |                   | MODEL  | S-125PN1E5A                            |          |                                     | -              |             |             | -     |        |      |
|--|-------------------|--|--|----------|-------------------------------------|----------------|-------------|-------------|-------|--------|------|
| PANEL  |                   | MODEL  | -                                      |          |                                     | -              |             |             | -     |        |      |
| OUTDOOR  |                   | MODEL  | -                                      |          |                                     | U-125PEY1E8    |             |             | -     |        |      |
| Branch pipe  |                   | MODEL  | -                                      |          |                                     | -              |             |             | -     |        |      |
| Performance test condition                                 |                   |  | ISO13253 / EN14511 / EN12102 / EN14825 |          |                                     |                |             |             |       |        |      |
| Power supply   |                   | Ø, Hz  | 1ø 50Hz                                |          |                                     | 3ø 50Hz        |             |             |       |        |      |
|  |                   | V  | 220                                    | 230      | 240                                 | 380            | 400         | 415         | Min   | Max    |      |
| C<br>O<br>O<br>L<br>I<br>N<br>G                            | Capacity          | kW   | 12.5                                   | 12.5     | 12.5                                | -              | -           | -           | 3.8   | 13.5   |      |
|  |                   | BTU/h  | 42700                                  | 42700    | 42700                               | -              | -           | -           | 13000 | 46100  |      |
|  | Current           | A  | 1.74                                   | 1.67     | 1.61                                | 6.85           | 6.50        | 6.25        | -     | -      |      |
|  |                   | W  | 225                                    | 225      | 225                                 | 4.220k         | 4.220k      | 4.220k      | -     | -      |      |
|  | Input power       | TOTAL W  | -                                      |          |                                     | 4.445k         | 4.445k      | 4.445k      | 950   | 5.200k |      |
|  |                   | Annual consumption                             | TOTAL kWh *4                           | -        |                                     |                | -           | 2223        | -     | -      | -    |
|  | EER/EER CLASS     | TOTAL (W/W) <sup>*5</sup> ("A"~"G")            | -                                      | -        | -                                   | 2.81           | 2.81 / C    | 2.81        | 4.00  | 2.60   |      |
|  | E<br>r<br>p<br>*6 | Pdesign  | kW                                     | -        | -                                   | -              | -           | 12.5        | -     | -      | -    |
|  |                   | η <sub>s,c</sub>                               | %                                      | -        | -                                   | -              | -           | 195.0       | -     | -      | -    |
|  |                   | Annual consumption                             | kWh                                    | -        | -                                   | -              | -           | -           | -     | -      | -    |
| Class  |                   |  | -                                      | -        | -                                   | -              | -           | -           | -     | -      |      |
| Power factor   | %                 | -  | -                                      | -        | 94                                  | 94             | 94          | -           | -     |        |      |
| Noise indoor   | dB-A (H/M/L)      | 45/43/38                                       |  |          | -                                   |                |             | -           | -     |        |      |
|  | Power Level dB    | 66/64/59                                       |  |          | -                                   |                |             | -           | -     |        |      |
| Noise outdoor  | dB-A (H/L)        | -  |  |          | 56/-                                |                |             | -           | -     |        |      |
|  | Power Level dB    | -  |  |          | 73/-                                |                |             | -           | -     |        |      |
| H<br>E<br>A<br>T<br>I<br>N<br>G                            | Capacity          | kW   | 12.5                                   | 12.5     | 12.5                                | -              | -           | -           | 3.4   | 15.0   |      |
|  |                   | BTU/h  | 42700                                  | 42700    | 42700                               | -              | -           | -           | 11600 | 51200  |      |
|  | Current           | A  | 1.74                                   | 1.67     | 1.61                                | 5.55           | 5.30        | 5.10        | -     | -      |      |
|  |                   | W  | 225                                    | 225      | 225                                 | 3.440k         | 3.440k      | 3.440k      | -     | -      |      |
|  | Input power       | TOTAL W  | -                                      |          |                                     | 3.665k         | 3.665k      | 3.665k      | 780   | 4.600k |      |
|  |                   | COP/COP CLASS                                  | TOTAL (W/W) <sup>*5</sup> ("A"~"G")    | -        | -                                   | -              | 3.41        | 3.41 / B    | 3.41  | 4.36   | 3.26 |
|  | E<br>r<br>p<br>*6 | Pdesign at -10°C                               | kW                                     | -        | -                                   | -              | -           | 12.5        | -     | -      | -    |
|  |                   | Tbivalent                                      | °C                                     | -        | -                                   | -              | -           | -7          | -     | -      | -    |
|  |                   | η <sub>s,h</sub>                               | %                                      | -        | -                                   | -              | -           | 137.8       | -     | -      | -    |
|  |                   | Annual consumption                             | kWh                                    | -        | -                                   | -              | -           | -           | -     | -      | -    |
| Class  |                   | -  | -                                      | -        | -                                   | -              | -           | -           | -     |        |      |
| Power factor   | %                 | -  | -                                      | -        | 94                                  | 94             | 94          | -           | -     |        |      |
| Noise indoor   | dB-A (H/M/L)      | 45/43/38                                       |  |          | -                                   |                |             | -           | -     |        |      |
|  | Power Level dB    | 66/64/59                                       |  |          | -                                   |                |             | -           | -     |        |      |
| Noise outdoor  | dB-A (H/L)        | -  |  |          | 56/-                                |                |             | -           | -     |        |      |
|  | Power Level dB    | -  |  |          | 73/-                                |                |             | -           | -     |        |      |
| EXTRA LOW TEMP   Total capacity(kW) / Input power(W) / COP |                   |  | -                                      |          |                                     |                |             |             |       | -      |      |
| Max Current(A) / Max Input power(W)                        |                   |  | 2.36/300                               | 2.30/300 | 2.24/300                            | 10.0/6.200k    | 10.0/6.500k | 10.0/6.750k | -     |        |      |
| Starting current(A) / Comp output(W)                       |                   |  | -                                      | -        | -                                   | 6.85/3.0k      | 6.50/3.0k   | 6.25/3.0k   | -     |        |      |
| Network Impedance(ΩMAX.)                                   |                   |  | -                                      |          |                                     |                |             |             |       | -      |      |
| Fan motor output (Indoor/Outdoor) W                        |                   |  | 200                                    |          |                                     | 90             |             |             | -     |        |      |
| Moisture removal volume                                    |                   |  | L/h(Pt/h)                              |          | 7.9                                 | (16.6)         |             | -           |       |        |      |
| External static pressure                                   |                   |  | Pa                                     |          | 50 (MIN10 ~ MAX80)                  |                |             |             |       | -      |      |
| Indoor Air flow  | Cooling           | m³/min (ft³/min)                               | 38/35/28 (1342/1236/989)               |          |                                     | -              |             |             | -     |        |      |
|  | Heating           | m³/min (ft³/min)                               | 38/35/28 (1342/1236/989)               |          |                                     | -              |             |             | -     |        |      |
| Outdoor Air flow   | Cooling           | m³/min (ft³/min)                               | -                                      |          |                                     | 80             |             | (2825)      |       | -      |      |
|  | Heating           | m³/min (ft³/min)                               | -                                      |          |                                     | 73             |             | (2578)      |       | -      |      |
| Refrigerant type / amount g(oz)                            |                   |  | -                                      |          |                                     | R410A          | 3.20k       | (112.9)     |       | -      |      |
| Product dimension  | Height            | mm(inch)                                       | 250 (9-27/32)                          |          |                                     | 996 (39-7/32)  |             |             | -     |        |      |
|  | Width             | mm(inch)                                       | 1200 (+100) (47-1/4) (+3-15/16)        |          |                                     | 940 (37-1/32)  |             |             | -     |        |      |
|  | Depth             | mm(inch)                                       | 650 (25-19/32)                         |          |                                     | 340 (13-13/32) |             |             | -     |        |      |
| Packing dimension  | Height            | mm(inch)                                       | 338                                    |          |                                     | 1136           |             |             | -     |        |      |
|  | Width             | mm(inch)                                       | 1402                                   |          |                                     | 1055           |             |             | -     |        |      |
|  | Depth             | mm(inch)                                       | 761                                    |          |                                     | 485            |             |             | -     |        |      |
| Weight   | (NET)             | kg(lb)   | 41 (91)                                |          |                                     | 85 (187)       |             |             | -     |        |      |
|  | (GROSS)           | kg(lb)   | 48 (106)                               |          |                                     | 93 (205)       |             |             | -     |        |      |
| Layers limit (actually)                                    |                   |  | 6 (7)                                  |          |                                     | 2 (3)          |             |             | -     |        |      |
| Operation condition  |                   | Cool (DBT)                                     | 18°C ~ 32°C                            |          |                                     | -10°C ~ 43°C   |             |             | -     |        |      |
|  |                   | Heat (DBT)                                     | 16°C ~ 30°C                            |          |                                     | -15°C ~ 24°C   |             |             | -     |        |      |
| Pipe diameter mm (inch)                                    |                   | (Liquid)ø9.52(3/8) (Gas)ø15.88(5/8)            |  |          | (Liquid)ø9.52(3/8) (Gas)ø15.88(5/8) |                |             | -           |       |        |      |
| Connecting method, Standard length m(ft)                   |                   | flared type, 5.0(16.4)                         |  |          | flared type, 5.0(16.4)              |                |             | -           |       |        |      |
| Pipe length range m (ft)                                   |                   | 5 ~ 50 (16.4 ~ 164.0)                          |  |          | -                                   |                |             | -           |       |        |      |
| Indoor unit & Outdoor unit height difference m (ft)        |                   | 15 (OD located lower) / 30 (OD located higher) |  |          | (49.2/98.4)                         |                |             | -           |       |        |      |
| Add gas amount g/m (oz/ft)                                 |                   | 50 (0.538)                                     |  |          | -                                   |                |             | -           |       |        |      |
| Pipe length for additional gas m (ft)                      |                   | 30 (98.4)                                      |  |          | -                                   |                |             | -           |       |        |      |

\*1: In case it is necessary to indicate the air flow volume in (l/s), the value in (m³/min.) shall be multiplied by 16.7 and rounded down the decimal point.  
 \*2: If the EUROVENT Certified models can be operated under the "extra-low" temperature condition, -7°C dry bulb and -8°C wet-bulb temperatures with rated voltage 230 V shall be used.  
 \*3: Network Impedance shall be applicable for EUROPE and CHINA models.  
 \*4: The annual consumption is calculated by multiplying the input power at 230 V (400 V) by an average of 500 hours per year in cooling mode.  
 \*5: EER and COP classification is at 230 V (400 V) only in accordance with EU directive 2002/31/EC.  
 \*6: SEER and SCOP classification is at 230V(400V) only in accordance with EN-14825. For heating, SCOP indicates the value of only Average heating season.

# Single -Type

## 1-1. Unit Specifications

**PEY1**

### 11. Ducted Type S-140PN1E5A / U-140PEY1E8

| INDOOR   |                    | MODEL  | S-140PN1E5A                            |          |                                     | -              |             |             | -      |       |  |
|--|--------------------|--|--|----------|-------------------------------------|----------------|-------------|-------------|--------|-------|--|
| PANEL  |                    | MODEL  | -                                      |          |                                     | -              |             |             | -      |       |  |
| OUTDOOR  |                    | MODEL  | -                                      |          |                                     | U-140PEY1E8    |             |             | -      |       |  |
| Branch pipe  |                    | MODEL  | -                                      |          |                                     | -              |             |             | -      |       |  |
| Performance test condition                                 |                    |  | ISO13253 / EN14511 / EN12102 / EN14825 |          |                                     |                |             |             |        |       |  |
| Power supply   |                    | Ø, Hz  | 1ø 50Hz                                |          |                                     | 3ø 50Hz        |             |             |        |       |  |
|  |                    | V  | 220                                    | 230      | 240                                 | 380            | 400         | 415         | Min    | Max   |  |
| Capacity   | kW                 | 14.0   | 14.0                                   | 14.0     | -                                   | -              | -           | -           | 3.3    | 15.5  |  |
|  | BTU/h              | 47800  | 47800                                  | 47800    | -                                   | -              | -           | -           | 11300  | 52900 |  |
| Current  |                    | A  | 1.89                                   | 1.82     | 1.74                                | 7.05           | 6.70        | 6.45        | -      | -     |  |
| Input power  | W                  | 250  | 250                                    | 250      | 4.450k                              | 4.450k         | 4.450k      | -           | -      |       |  |
|  | TOTAL W            | -  | -                                      | -        | 4.700k                              | 4.700k         | 4.700k      | 840         | 6.000k |       |  |
| Annual consumption   |                    | TOTAL kWh *4                                   | -                                      |          |                                     | 2350           |             |             | -      |       |  |
| EER/EER CLASS  |                    | TOTAL (W/W) <sup>*5</sup> ("A"~"G")            | -                                      | -        | -                                   | 2.98           | 2.98 / C    | 2.98        | 3.93   | 2.58  |  |
| Erp *6   | Pdesign            | kW   | -                                      | -        | -                                   | -              | 14.0        | -           | -      | -     |  |
|  | η <sub>s,c</sub>   | %  | -                                      | -        | -                                   | -              | 204.3       | -           | -      | -     |  |
|  | Annual consumption | kWh  | -                                      | -        | -                                   | -              | -           | -           | -      | -     |  |
|  | Class              | -  | -                                      | -        | -                                   | -              | -           | -           | -      | -     |  |
| Power factor   |                    | %  | -                                      | -        | -                                   | 96             | 96          | 96          | -      | -     |  |
| Noise indoor   | dB-A (H/M/L)       | 46/44/39                                       |  |          | -                                   |                |             | -           |        |       |  |
|  | Power Level dB     | 67/65/60                                       |  |          | -                                   |                |             | -           |        |       |  |
| Noise outdoor  | dB-A (H/L)         | -  |  |          | 54/-                                |                |             | -           |        |       |  |
|  | Power Level dB     | -  |  |          | 71/-                                |                |             | -           |        |       |  |
| Capacity   | kW                 | 14.0   | 14.0                                   | 14.0     | -                                   | -              | -           | 4.1         | 16.0   |       |  |
|  | BTU/h              | 47800  | 47800                                  | 47800    | -                                   | -              | -           | 14000       | 54600  |       |  |
| Current  |                    | A  | 1.89                                   | 1.82     | 1.74                                | 5.90           | 5.60        | 5.40        | -      | -     |  |
| Input power  | W                  | 250  | 250                                    | 250      | 3.730k                              | 3.730k         | 3.730k      | -           | -      |       |  |
|  | TOTAL W            | -  | -                                      | -        | 3.980k                              | 3.980k         | 3.980k      | 900         | 5.200k |       |  |
| COP/COP CLASS  |                    | TOTAL (W/W) <sup>*5</sup> ("A"~"G")            | -                                      | -        | -                                   | 3.52           | 3.52 / B    | 3.52        | 4.56   | 3.08  |  |
| Erp *6   | Pdesign at -10°C   | kW   | -                                      | -        | -                                   | -              | 14.0        | -           | -      | -     |  |
|  | Tbivalent          | °C   | -                                      | -        | -                                   | -              | -7          | -           | -      | -     |  |
|  | η <sub>s,h</sub>   | %  | -                                      | -        | -                                   | -              | 137.6       | -           | -      | -     |  |
|  | Annual consumption | kWh  | -                                      | -        | -                                   | -              | -           | -           | -      | -     |  |
| Power factor   |                    | %  | -                                      | -        | -                                   | 96             | 96          | 96          | -      | -     |  |
| Noise indoor   | dB-A (H/M/L)       | 46/44/39                                       |  |          | -                                   |                |             | -           |        |       |  |
|  | Power Level dB     | 67/65/60                                       |  |          | -                                   |                |             | -           |        |       |  |
| Noise outdoor  | dB-A (H/L)         | -  |  |          | 53/-                                |                |             | -           |        |       |  |
|  | Power Level dB     | -  |  |          | 70/-                                |                |             | -           |        |       |  |
| EXTRA LOW TEMP   Total capacity(kW) / Input power(W) / COP |                    |  | -                                      |          |                                     |                |             |             |        | -     |  |
| Max Current(A) / Max Input power(W)                        |                    |  | 2.59/345                               | 2.53/345 | 2.47/345                            | 10.0/6.200k    | 10.0/6.500k | 10.0/6.750k | -      |       |  |
| Starting current(A) / Comp output(W)                       |                    |  | -                                      | -        | -                                   | 7.05/3.0k      | 6.70/3.0k   | 6.45/3.0k   | -      |       |  |
| Network Impedance(ΩMAX.)                                   |                    |  | -                                      |          |                                     |                |             |             |        | -     |  |
| Fan motor output (Indoor/Outdoor) W                        |                    |  | 200                                    |          |                                     | 90×2           |             |             | -      |       |  |
| Moisture removal volume                                    |                    | L/h(Pt/h)                                      | 9.0                                    | (18.9)   |                                     | -              |             |             | -      |       |  |
| External static pressure                                   |                    | Pa   | 50 (MIN10 ~ MAX80)                     |          |                                     | -              |             |             | -      |       |  |
| Indoor Air flow  | Cooling            | m³/min (ft³/min)                               | 40/37/30 (1413/1307/1059)              |          |                                     | -              |             |             | -      |       |  |
|  | Heating            | m³/min (ft³/min)                               | 40/37/30 (1413/1307/1059)              |          |                                     | -              |             |             | -      |       |  |
| Outdoor Air flow   | Cooling            | m³/min (ft³/min)                               | -                                      |          |                                     | 135            | (4767)      |             | -      |       |  |
|  | Heating            | m³/min (ft³/min)                               | -                                      |          |                                     | 120            | (4238)      |             | -      |       |  |
| Refrigerant type / amount g(oz)                            |                    |  | -                                      |          |                                     | R410A          | 3.40k       | (119.9)     | -      |       |  |
| Product dimension  | Height             | mm(inch)                                       | 250 (9-27/32)                          |          |                                     | 1416 (55-3/4)  |             |             | -      |       |  |
|  | Width              | mm(inch)                                       | 1200 (+100) (47-1/4) (+3-15/16)        |          |                                     | 940 (37-1/32)  |             |             | -      |       |  |
|  | Depth              | mm(inch)                                       | 650 (25-19/32)                         |          |                                     | 340 (13-13/32) |             |             | -      |       |  |
| Packing dimension  | Height             | mm(inch)                                       | 338                                    |          |                                     | 1556           |             |             | -      |       |  |
|  | Width              | mm(inch)                                       | 1402                                   |          |                                     | 1055           |             |             | -      |       |  |
|  | Depth              | mm(inch)                                       | 761                                    |          |                                     | 485            |             |             | -      |       |  |
| Weight   | (NET)              | kg(lb)   | 41 (91)                                |          |                                     | 98 (216)       |             |             | -      |       |  |
|  | (GROSS)            | kg(lb)   | 48 (106)                               |          |                                     | 108 (238)      |             |             | -      |       |  |
| Layers limit (actually)                                    |                    |  | 6 (7)                                  |          |                                     | 1 (2)          |             |             | -      |       |  |
| Operation condition  |                    | Cool (DBT)                                     | 18°C ~ 32°C                            |          |                                     | -10°C ~ 43°C   |             |             | -      |       |  |
|  |                    | Heat (DBT)                                     | 16°C ~ 30°C                            |          |                                     | -15°C ~ 24°C   |             |             | -      |       |  |
| Pipe diameter mm (inch)                                    |                    | (Liquid)ø9.52(3/8) (Gas)ø15.88(5/8)            |  |          | (Liquid)ø9.52(3/8) (Gas)ø15.88(5/8) |                |             | -           |        |       |  |
| Connecting method, Standard length m(ft)                   |                    | flared type, 5.0(16.4)                         |  |          | flared type, 5.0(16.4)              |                |             | -           |        |       |  |
| Pipe length range m (ft)                                   |                    | 5 ~ 50 (16.4 ~ 164.0)                          |  |          | -                                   |                |             | -           |        |       |  |
| Indoor unit & Outdoor unit height difference m (ft)        |                    | 15 (OD located lower) / 30 (OD located higher) |  |          | (49.2/98.4)                         |                |             | -           |        |       |  |
| Add gas amount g/m (oz/ft)                                 |                    | 50 (0.538)                                     |  |          | -                                   |                |             | -           |        |       |  |
| Pipe length for additional gas m (ft)                      |                    | 30 (98.4)                                      |  |          | -                                   |                |             | -           |        |       |  |

\*1: In case it is necessary to indicate the air flow volume in (l/s), the value in (m³/min.) shall be multiplied by 16.7 and rounded down the decimal point.

\*2: If the EUROVENT Certified models can be operated under the "extra-low" temperature condition, -7°C dry bulb and -8°C wet-bulb temperatures with rated voltage 230 V shall be used.

\*3: Network Impedance shall be applicable for EUROPE and CHINA models.

\*4: The annual consumption is calculated by multiplying the input power at 230 V (400 V) by an average of 500 hours per year in cooling mode.

\*5: EER and COP classification is at 230 V (400 V) only in accordance with EU directive 2002/31/EC.

\*6: SEER and SCOP classification is at 230V(400V) only in accordance with EN-14825. For heating, SCOP indicates the value of only Average heating season.

# Simultaneous (Twin) -Type

## 1-1. Unit Specifications

**PEY1**

### 12. 4-Way Cassette 60x60 Type S-50PY2E5A×2 / U-100PEY1E5

|  |  |                          |  |                                       |             |                                     |            |            |      |             |      |
|--|--|--------------------------|--|---------------------------------------|-------------|-------------------------------------|------------|------------|------|-------------|------|
| INDOOR   |  | MODEL                    | S-50PY2E5A ×2                              |                                       |             |                                     |            |            | -    | -           |      |
| PANEL  |  | MODEL                    | (CZ-KPY3AW / CZ-KPY3BW) ×2                 |                                       |             |                                     |            |            | -    | -           |      |
| OUTDOOR  |  | MODEL                    |  |                                       |             | U-100PEY1E5                         |            |            | -    | -           |      |
| Branch pipe  |  | MODEL                    |  |                                       |             | CZ-P155BK1                          |            |            | -    | -           |      |
| Performance test condition                                 |  |                          |  | ISO5151 / EN14511 / EN14825 / EN12102 |             |                                     |            |            |      |             |      |
| Power supply   |  | ∅, Hz                    | 1∅ 50Hz                                    |                                       |             | 1∅ 50Hz                             |            |            |      |             |      |
|  |  | V                        | 220  | 230                                   | 240         | 220                                 | 230        | 240        | Min  | Max         |      |
| Capacity   |  | kW                       | 10.0                                       | 10.0                                  | 10.0        | -                                   | -          | -          | 2.7  | 11.0        |      |
|  |  | BTU/h                    | 34100                                      | 34100                                 | 34100       | -                                   | -          | -          | 9200 | 37500       |      |
| Current  |  | A                        | 0.35 × 2                                   |                                       |             | 17.1                                | 16.4       | 15.7       | -    | -           |      |
| Input power  |  | W                        | 45 × 2                                     |                                       |             | 3.540k                              | 3.540k     | 3.540k     | -    | -           |      |
|  |  | TOTAL W                  |  |                                       |             | 3.630k                              | 3.630k     | 3.630k     | 530  | 4.280k      |      |
| Annual consumption   |  | TOTAL kWh *4             | -  | -                                     | -           | -                                   | 1815       | -          | -    | -           |      |
| EER/EER CLASS  |  | TOTAL (W/W) *5 / ("A"-G) | -  | -                                     | -           | 2.75                                | 2.75/D     | 2.75       | 5.09 | 2.57        |      |
| C<br>O<br>O<br>L<br>I<br>N<br>G                            | Erp *6                                   | Pdesign                  | kW   | -                                     | -           | -                                   | 10.0       | -          | -    | -           |      |
|  |  | SEER                     | (W/W)                                      | -                                     | -           | -                                   | 6.1        | -          | -    | -           |      |
|  |  | Annual consumption       | kWh  | -                                     | -           | -                                   | 574        | -          | -    | -           |      |
|  | Power factor                             | %                        |  |                                       |             | 94                                  | 94         | 94         | -    | -           |      |
|  |  |                          | dB-A (H/M/L)                               |                                       | 40/37/33    |                                     |            | -          | -    | -           |      |
|  |  |                          | Power Level dB                             |                                       | 55/52/48    |                                     |            | -          | -    | -           |      |
| Noise outdoor  | dB-A (H/L)                               |                          |  |                                       |             | 54/-                                | -          | -          |      |             |      |
|  | Power Level dB                           |                          |  |                                       |             | 70/-                                | -          | -          |      |             |      |
| H<br>E<br>A<br>T<br>I<br>N<br>G                            | Capacity                                 | kW                       | 10.0                                       | 10.0                                  | 10.0        | -                                   | -          | -          | 2.1  | 12.4        |      |
|  |  | BTU/h                    | 34100                                      | 34100                                 | 34100       | -                                   | -          | -          | 7200 | 42300       |      |
|  | Current                                  | A                        | 0.35 × 2                                   |                                       |             | 13.8                                | 13.3       | 12.7       | -    | -           |      |
|  |  | W                        | 40 × 2                                     |                                       |             | 2.885k                              | 2.885k     | 2.885k     | -    | -           |      |
|  | Input power                              | W                        |  |                                       |             | 2.965k                              | 2.965k     | 2.965k     | 410  | 4.280k      |      |
|  |  | TOTAL W                  |  |                                       |             | -                                   | -          | -          | -    | -           |      |
|  | COP/COP CLASS                            |                          | TOTAL (W/W) *5 / ("A"-G)                   | -                                     | -           | -                                   | 3.37       | 3.37/C     | 3.37 | 5.12        | 2.90 |
|  | Erp *6                                   | Pdesign at -10°C         | kW   | -                                     | -           | -                                   | -          | 9.2        | -    | -           | -    |
|  |  | Tbivalent                | °C   | -                                     | -           | -                                   | -          | -9         | -    | -           | -    |
|  |  | SCOP                     | (W/W)                                      | -                                     | -           | -                                   | -          | 3.8        | -    | -           | -    |
|  |  | Annual consumption       | kWh  | -                                     | -           | -                                   | -          | 3389       | -    | -           | -    |
|  |  | Class                    |  | -                                     | -           | -                                   | -          | A          | -    | -           | -    |
| Power factor   |  | %                        | -  | -                                     | -           | 95                                  | 94         | 95         | -    | -           |      |
| Noise indoor   | dB-A (H/M/L)                             |                          | 40/37/33                                   |                                       |             | -                                   | -          | -          | -    |             |      |
|  | Power Level dB                           |                          | 55/52/48                                   |                                       |             | -                                   | -          | -          | -    |             |      |
| Noise outdoor  | dB-A (H/L)                               |                          |  |                                       |             | 54/-                                | -          | -          |      |             |      |
|  | Power Level dB                           |                          |  |                                       |             | 70/-                                | -          | -          |      |             |      |
| EXTRA LOW TEMP   Total capacity(kW) / Input power(W) / COP |  |                          |  |                                       |             |                                     |            |            |      | -           |      |
| Max Current(A) / Max Input power(W)                        |  |                          | 0.40/55 × 2                                | 0.40/55 × 2                           | 0.40/55 × 2 | 25.0/5.30k                          | 25.0/5.50k | 25.0/5.70k | -    | -           |      |
| Starting current(A) / Comp output(W)                       |  |                          | -  | -                                     | -           | 17.1/1.7k                           | 16.4/1.7k  | 15.7/1.7k  | -    | -           |      |
| Network Impedance(ΩMAX.)                                   |  |                          |  |                                       |             | -                                   | -          | -          | -    | -           |      |
| Fan motor output (Indoor/Outdoor) W                        |  |                          | 40 × 2                                     |                                       |             | 90                                  |            |            | -    | -           |      |
| Moisture removal volume                                    |  |                          | L/h(Pt/h)                                  | 6.0                                   | (3.0×2)     | (12.6)                              |            |            |      | -           |      |
| External static pressure                                   |  |                          | Pa   |                                       |             |                                     |            |            |      | -           |      |
| Indoor Air flow  | Cooling                                  | m³/min (ft³/min)         | 11.1×2/9.8×2/8.5×2 (392)×2/(346)×2/(300)×2 |                                       |             |                                     |            |            | -    | -           |      |
|  | Heating                                  | m³/min (ft³/min)         | 11.1×2/9.8×2/8.7×2 (392)×2/(346)×2/(307)×2 |                                       |             |                                     |            |            | -    | -           |      |
| Outdoor Air flow   | Cooling                                  | m³/min (ft³/min)         |  |                                       |             | 76                                  | (2684)     |            | -    | -           |      |
|  | Heating                                  | m³/min (ft³/min)         |  |                                       |             | 67                                  | (2366)     |            | -    | -           |      |
| Refrigerant type / amount g(oz)                            |  |                          |  |                                       |             | R410A                               | 2.60k      | (91.7)     | -    | -           |      |
| Product dimension  | Height                                   | mm(inch)                 | 260<265 + 23> (10-1/4)                     |                                       |             | 996 (39-7/32)                       |            |            | -    | -           |      |
|  | Width                                    | mm(inch)                 | 575<583> (22-21/32)                        |                                       |             | 940 (37-1/32)                       |            |            | -    | -           |      |
|  | Depth                                    | mm(inch)                 | 575<583> (22-21/32)                        |                                       |             | 340 (13-13/32)                      |            |            | -    | -           |      |
|  | Panel H×W×D                              | mm                       | 31 × 700 × 700 *                           |                                       |             |                                     |            |            | -    | * CZ-KPY3AW |      |
| Packing dimension  | Height                                   | mm(inch)                 | 345 (13-19/32)                             |                                       |             | 1136                                |            |            | -    | -           |      |
|  | Width                                    | mm(inch)                 | 691 (27-7/32)                              |                                       |             | 1055                                |            |            | -    | -           |      |
|  | Depth                                    | mm(inch)                 | 691 (27-7/32)                              |                                       |             | 485                                 |            |            | -    | -           |      |
| Weight   | (NET)                                    | kg(lb)                   | 18 (40)                                    |                                       |             | 73 (161)                            |            |            | -    | -           |      |
|  | (GROSS)                                  | kg(lb)                   | 23 (51)                                    |                                       |             | 81 (179)                            |            |            | -    | -           |      |
| Layers limit (actually)                                    |  |                          | 11 (12)                                    |                                       |             | 2 (3)                               |            |            | -    | -           |      |
| Operation condition  | Cool (DBT)                               |                          | 18°C ~ 32°C                                |                                       |             | -10°C ~ 43°C                        |            |            | -    | -           |      |
|  | Heat (DBT)                               |                          | 16°C ~ 30°C                                |                                       |             | -15°C ~ 24°C                        |            |            | -    | -           |      |
| P<br>I<br>P<br>I<br>N<br>G                                 | Pipe diameter mm (inch)                  |                          | (Liquid)∅6.35(1/4) (Gas)∅12.7(1/2)         |                                       |             | (Liquid)∅9.52(3/8) (Gas)∅15.88(5/8) |            |            | -    | -           |      |
|  | Connecting method, Standard length m(ft) |                          | flared type, 5.0 (16.4)                    |                                       |             | flared type, 5.0 (16.4)             |            |            | -    | -           |      |
| Pipe length range  |  | m (ft)                   | 5 ~ 50 (16.4 ~ 164.0)                      |                                       |             |                                     |            |            | -    | -           |      |
| Indoor unit & Outdoor unit height difference               |  | m (ft)                   | 15(OD located lower)/30(OD located higher) |                                       |             | (49.2/98.4)                         |            |            | -    | -           |      |
| Add gas amount   |  | g/m (oz/ft)              | 50 (0.538)                                 |                                       |             |                                     |            |            | -    | -           |      |
| Pipe length for additional gas                             |  | m (ft)                   | 30 (98.4)                                  |                                       |             |                                     |            |            | -    | -           |      |

\*1: In case it is necessary to indicate the air flow volume in (l/s), the value in (m³/min.) shall be multiplied by 16.7 and rounded down the decimal point.  
 \*2: If the EUROVENT Certified models can be operated under the "extra-low" temperature condition, -7°C dry bulb and -8°C wet-bulb temperatures with rated voltage 230V shall be used.  
 \*3: Network Impedance shall be applicable for EUROPE and CHINA models.  
 \*4: The annual consumption is calculated by multiplying the input power at 230V(400V) by an average of 500 hours per year in cooling mode.  
 \*5: EER and COP classification is at 230V(400V) only in accordance with EU directive 2002/31/EC.  
 \*6: SEER and SCOP classification is at 230V(400V) only in accordance with EN-14825. For heating, SCOP indicates the value of only Average heating season, Other fiche data indicates in an attached sheet.

# Simultaneous (Twin) -Type

## 1-1. Unit Specifications

**PEY1**

### 12. 4-Way Cassette 60×60 Type S-50PY2E5A×2 / U-100PEY1E8

| INDOOR   |   | MODEL                    | S-50PY2E5A ×2                              |                        |             | -                                   |                |           | -           |        |
|--|---|--------------------------|--|------------------------|-------------|-------------------------------------|----------------|-----------|-------------|--------|
| PANEL  |   | MODEL                    | (CZ-KPY3AW / CZ-KPY3BW) ×2                 |                        |             | -                                   |                |           | -           |        |
| OUTDOOR  |   | MODEL                    | -  |                        |             | U-100PEY1E8                         |                |           | -           |        |
| Branch pipe  |   | MODEL                    | -  |                        |             | CZ-P155BK1                          |                |           | -           |        |
| Performance test condition                               |   |                          | ISO5151 / EN14511 / EN14825 / EN12102      |                        |             |                                     |                |           |             |        |
| Power supply   |   | Ø, Hz                    | 1ø 50Hz                                    |                        |             | 3ø 50Hz                             |                |           |             |        |
|  |   | V                        | 220  | 230                    | 240         | 380                                 | 400            | 415       | Min         | Max    |
| Capacity   |   | kW                       | 10.0                                       | 10.0                   | 10.0        | -                                   | -              | -         | 2.7         | 11.0   |
|  |   | BTU/h                    | 34100                                      | 34100                  | 34100       | -                                   | -              | -         | 9200        | 37500  |
| Current  |   | A                        | 0.35 × 2                                   |                        |             | 5.85                                | 5.55           | 5.40      | -           | -      |
| Input power  |   | W                        | 45 × 2                                     |                        |             | 3.540k                              | 3.540k         | 3.540k    | -           | -      |
|  |   | TOTAL W                  | -  |                        |             | 3.630k                              | 3.630k         | 3.630k    | 530         | 4.280k |
| Annual consumption                                       |   | TOTAL kWh *4             | -  | -                      | -           | -                                   | 1815           | -         | -           | -      |
| EER/EER CLASS  |   | TOTAL (W/W) *5 / ("A"-G) | -  | -                      | -           | 2.75                                | 2.75/D         | 2.75      | 5.09        | 2.57   |
| C<br>O<br>O<br>L<br>I<br>N<br>G                          | Erp *6  | Pdesign                  | kW   | -                      | -           | -                                   | 10.0           | -         | -           | -      |
|  |   | SEER                     | (W/W)                                      | -                      | -           | -                                   | 6.0            | -         | -           | -      |
|  | Annual consumption                                  | kWh                      | -  | -                      | -           | -                                   | 583            | -         | -           | -      |
|  | Class   |                          | -  | -                      | -           | -                                   | A+             | -         | -           | -      |
| Power factor   |   | %                        | -  | -                      | -           | 92                                  | 92             | 91        | -           | -      |
| Noise indoor   |   | dB-A (H/M/L)             | 40/37/33                                   |                        |             | -                                   |                |           | -           | -      |
|  |   | Power Level dB           | 55/52/48                                   |                        |             | -                                   |                |           | -           | -      |
| Noise outdoor  |   | dB-A (H/L)               | -  |                        |             | 54/-                                |                |           | -           | -      |
|  |   | Power Level dB           | -  |                        |             | 70/-                                |                |           | -           | -      |
| Capacity   |   | kW                       | 10.0                                       | 10.0                   | 10.0        | -                                   | -              | -         | 2.1         | 12.4   |
|  |   | BTU/h                    | 34100                                      | 34100                  | 34100       | -                                   | -              | -         | 7200        | 42300  |
| Current  |   | A                        | 0.35 × 2                                   |                        |             | 4.75                                | 4.55           | 4.40      | -           | -      |
| Input power  |   | W                        | 40 × 2                                     |                        |             | 2.885k                              | 2.885k         | 2.885k    | -           | -      |
|  |   | TOTAL W                  | -  |                        |             | 2.965k                              | 2.965k         | 2.965k    | 410         | 4.280k |
| COP/COP CLASS  |   | TOTAL (W/W) *5 / ("A"-G) | -  | -                      | -           | 3.37                                | 3.37/C         | 3.37      | 5.12        | 2.90   |
| H<br>E<br>A<br>T<br>I<br>N<br>G                          | Erp *6  | Pdesign at -10°C         | kW   | -                      | -           | -                                   | 9.2            | -         | -           | -      |
|  |   | Tbivalent                | °C   | -                      | -           | -                                   | -9             | -         | -           | -      |
|  | SCOP  | (W/W)                    | -  | -                      | -           | -                                   | 3.8            | -         | -           | -      |
|  | Annual consumption                                  | kWh                      | -  | -                      | -           | -                                   | 3389           | -         | -           | -      |
| Class  |   | -                        | -  | -                      | -           | A                                   | -              | -         | -           |        |
| Power factor   |   | %                        | -  | -                      | -           | 92                                  | 92             | 91        | -           | -      |
| Noise indoor   |   | dB-A (H/M/L)             | 40/37/33                                   |                        |             | -                                   |                |           | -           | -      |
|  |   | Power Level dB           | 55/52/48                                   |                        |             | -                                   |                |           | -           | -      |
| Noise outdoor  |   | dB-A (H/L)               | -  |                        |             | 54/-                                |                |           | -           | -      |
|  |   | Power Level dB           | -  |                        |             | 70/-                                |                |           | -           | -      |
| EXTRA LOW TEMP Total capacity(kW) / Input power(W) / COP |   |                          |  |                        |             |                                     |                |           |             |        |
| Max Current(A) / Max Input power(W)                      |   |                          | 0.40/55 × 2                                | 0.40/55 × 2            | 0.40/55 × 2 | 9.0/5.55k                           | 9.0/5.80k      | 9.0/6.05k | -           |        |
| Starting current(A) / Comp output(W)                     |   |                          | -  | -                      | -           | 5.85/1.7k                           | 5.55/1.7k      | 5.40/1.7k | -           |        |
| Network Impedance(ΩMAX.)                                 |   |                          | -  |                        |             | -                                   |                |           | -           |        |
| Fan motor output (Indoor/Outdoor) W                      |   |                          | 40 × 2                                     |                        |             | 90                                  |                |           | -           |        |
| Moisture removal volume                                  |   |                          | L/h(Pt/h)                                  | 6.0                    | (3.0×2)     | (12.6)                              | -              |           |             | -      |
| External static pressure                                 |   |                          | Pa   | -                      |             |                                     | -              |           |             | -      |
| Indoor Air flow  | Cooling   | m³/min (ft³/min)         | 11.1×2/9.8×2/8.5×2 (392)×2/(346)×2/(300)×2 |                        |             | -                                   |                |           | -           | -      |
|  | Heating   | m³/min (ft³/min)         | 11.1×2/9.8×2/8.7×2 (392)×2/(346)×2/(307)×2 |                        |             | -                                   |                |           | -           | -      |
| Outdoor Air flow   | Cooling   | m³/min (ft³/min)         | -  |                        |             | 76 (2684)                           |                |           | -           | -      |
|  | Heating   | m³/min (ft³/min)         | -  |                        |             | 67 (2366)                           |                |           | -           | -      |
| Refrigerant type / amount g(oz)                          |   |                          | -  |                        |             | R410A                               | 2.60k          | (91.7)    | -           |        |
| Product dimension  |   | Height                   | mm(inch)                                   | 260<265 + 23> (10-1/4) |             |                                     | 996 (39-7/32)  |           |             | -      |
|  |   | Width                    | mm(inch)                                   | 575<583> (22-21/32)    |             |                                     | 940 (37-1/32)  |           |             | -      |
|  |   | Depth                    | mm(inch)                                   | 575<583> (22-21/32)    |             |                                     | 340 (13-13/32) |           |             | -      |
| Panel H×W×D mm   |   |                          | 31 × 700 × 700 *                           |                        |             | -                                   |                |           | * CZ-KPY3AW |        |
| Packing dimension  |   | Height                   | mm(inch)                                   | 345 (13-19/32)         |             |                                     | 1136           |           |             | -      |
|  |   | Width                    | mm(inch)                                   | 691 (27-7/32)          |             |                                     | 1055           |           |             | -      |
|  |   | Depth                    | mm(inch)                                   | 691 (27-7/32)          |             |                                     | 485            |           |             | -      |
| Weight   |   | (NET)                    | kg(lb)                                     | 18 (40)                |             |                                     | 73 (161)       |           |             | -      |
|  |   | (GROSS)                  | kg(lb)                                     | 23 (51)                |             |                                     | 81 (179)       |           |             | -      |
| Layers limit (actually)                                  |   |                          | 11 (12)                                    |                        |             | 2 (3)                               |                |           | -           |        |
| Operation condition                                      |   | Cool (DBT)               | 18°C ~ 32°C                                |                        |             | -10°C ~ 43°C                        |                |           | -           |        |
|  |   | Heat (DBT)               | 16°C ~ 30°C                                |                        |             | -15°C ~ 24°C                        |                |           | -           |        |
| P<br>I<br>P<br>E   | Pipe diameter mm (inch)                             |                          | (Liquid)ø6.35(1/4) (Gas)ø12.7(1/2)         |                        |             | (Liquid)ø9.52(3/8) (Gas)ø15.88(5/8) |                |           | -           |        |
|  | Connecting method, Standard length m(ft)            |                          | flared type, 5.0 (16.4)                    |                        |             | flared type, 5.0 (16.4)             |                |           | -           |        |
| I<br>N<br>D<br>O<br>O<br>R                               | Pipe length range m (ft)                            |                          | 5 ~ 50 (16.4 ~ 164.0)                      |                        |             | -                                   |                |           | -           |        |
|  | Indoor unit & Outdoor unit height difference m (ft) |                          | 15(OD located lower)/30(OD located higher) |                        |             | (49.2/98.4)                         |                |           | -           |        |
| Add gas amount g/m (oz/ft)                               |   |                          | 50 (0.538)                                 |                        |             | -                                   |                |           | -           |        |
| Pipe length for additional gas m (ft)                    |   |                          | 30 (98.4)                                  |                        |             | -                                   |                |           | -           |        |

\*1: In case it is necessary to indicate the air flow volume in (l/s), the value in (m³/min.) shall be multiplied by 16.7 and rounded down the decimal point.

\*2: If the EUROVENT Certified models can be operated under the "extra-low" temperature condition, -7°C dry bulb and -8°C wet-bulb temperatures with rated voltage 230V shall be used.

\*3: Network Impedance shall be applicable for EUROPE and CHINA models.

\*4: The annual consumption is calculated by multiplying the input power at 230V(400V) by an average of 500 hours per year in cooling mode.

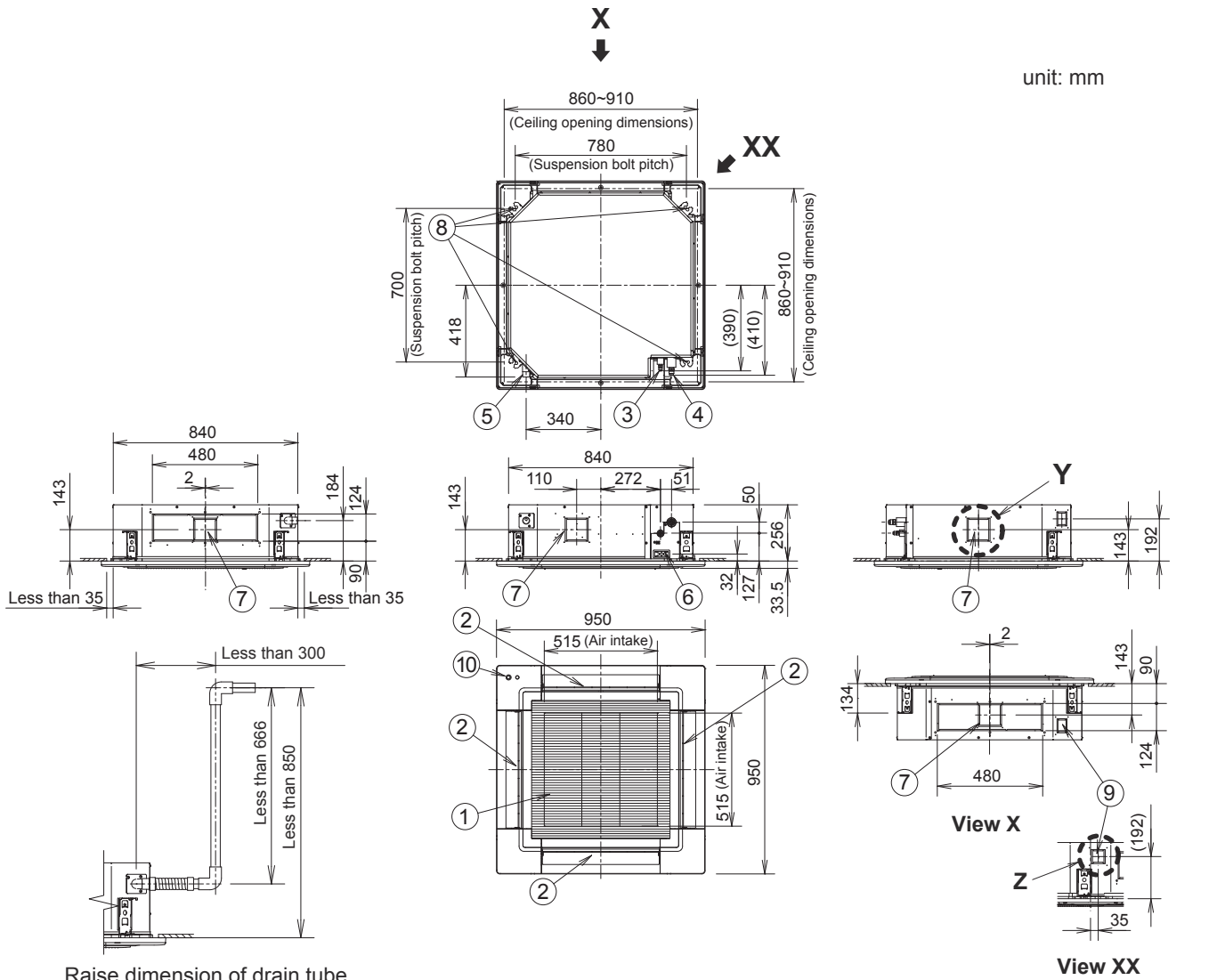
\*5: EER and COP classification is at 230V(400V) only in accordance with EU directive 2002/31/EC.

\*6: SEER and SCOP classification is at 230V(400V) only in accordance with EN-14825. For heating, SCOP indicates the value of only Average heating season, Other fiche data indicates in an attached sheet.

1-2. Dimensional Data

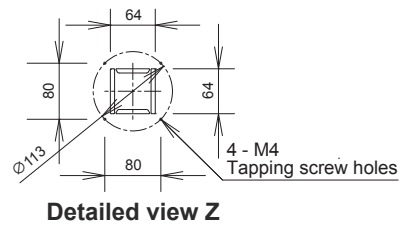
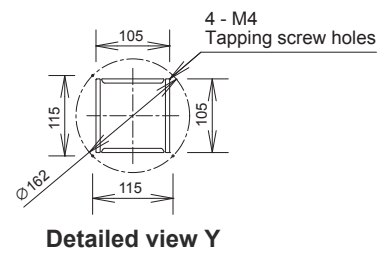
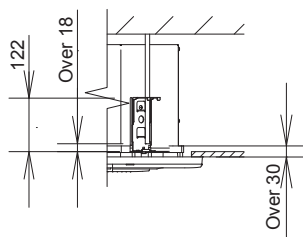
(A) Indoor Units: S-36PU2E5A / S-45PU2E5A / S-50PU2E5A / S-60PU2E5A / S-71PU2E5A

unit: mm



Raise dimension of drain tube

The length of the suspension bolts should be selected so that there is a gap of 30 mm or more below the lower surface of the ceiling (18 mm or more below the lower surface of the main unit), as shown in the figure at right. If the suspension bolt is too long, it will contact the ceiling panel and the unit cannot be installed.



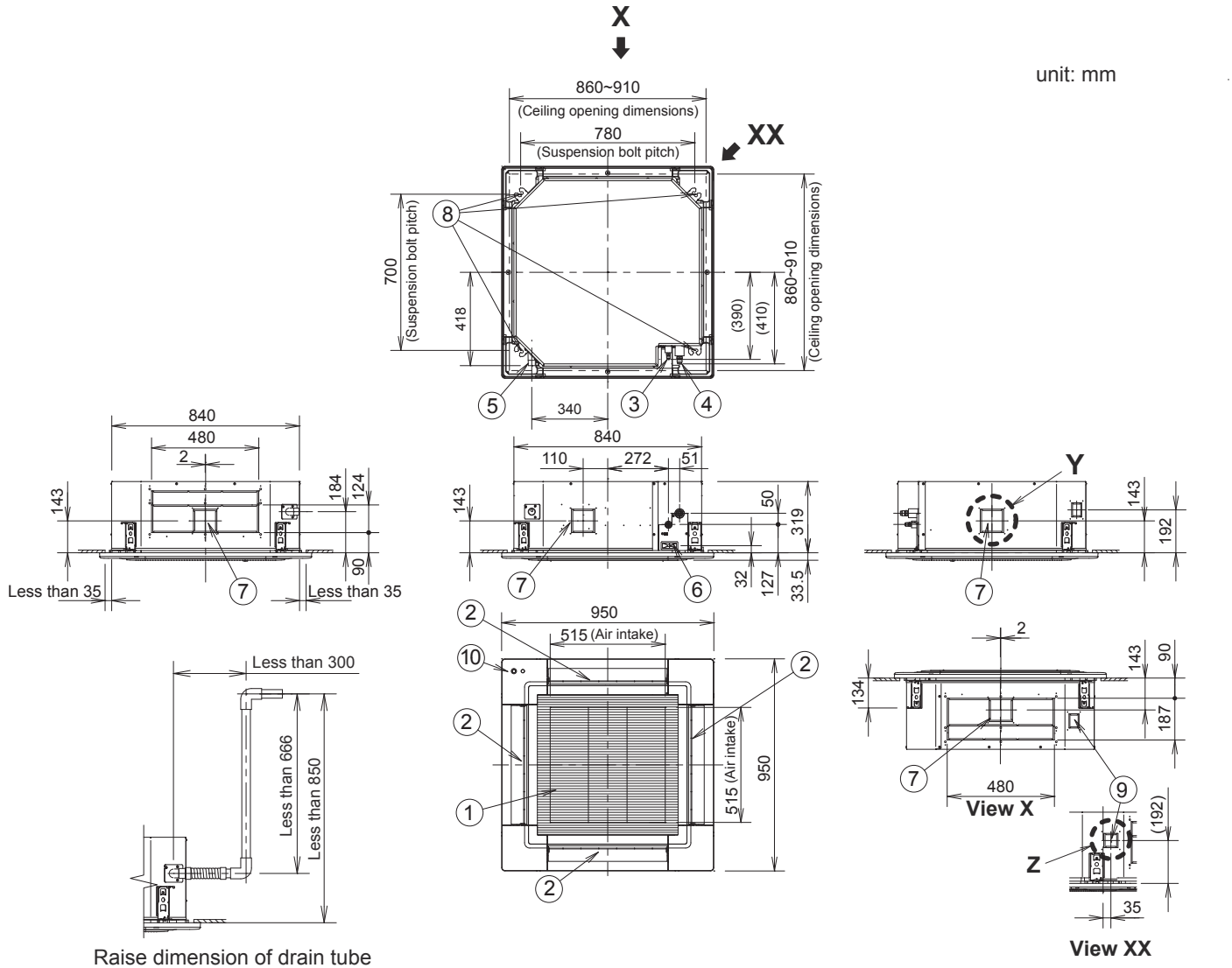
|   |   |
|---|---|
| ① | Air intake  |
| ② | Discharge outlet  |
| ③ | Refrigerant tubing (liquid tube) 36-50 type $\phi 6.35$ (flared), 60 • 71 type $\phi 9.52$ (flared) |
| ④ | Refrigerant tubing (gas tube) 36-50 type $\phi 12.7$ (flared), 60 • 71 type $\phi 15.88$ (flared)   |
| ⑤ | Drain tube connection port VP25 (outer dia. $\phi 32$ )   |
| ⑥ | Power supply port   |
| ⑦ | Discharge duct connection port ( $\phi 150$ )   |
| ⑧ | Suspension bolt hole (4-12×30 elongated hole)   |
| ⑨ | Fresh air intake duct connection port ( $\phi 100$ ) *  |
| ⑩ | ECONAVI sensor (Only CZ-KPU3A)  |

\* Necessary to attach duct connecting flange(field supplied).

<Filter dimension>  
520 x 520 x 15

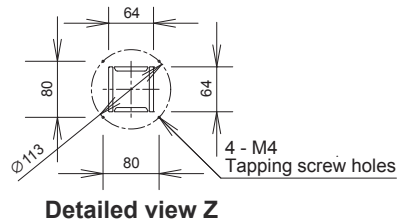
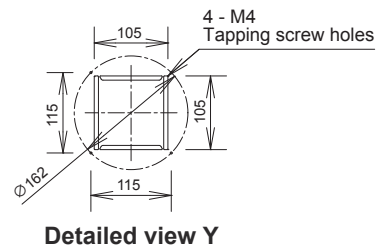
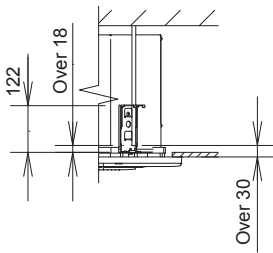
1-2. Dimensional Data

(A) Indoor Units: S-100PU2E5A / S-125PU2E5A / S-140PU2E5A



Raise dimension of drain tube

The length of the suspension bolts should be selected so that there is a gap of 30 mm or more below the lower surface of the ceiling (18 mm or more below the lower surface of the main unit), as shown in the figure at right. If the suspension bolt is too long, it will contact the ceiling panel and the unit cannot be installed.



|   |  |
|---|--|
| ① | Air intake                                       |
| ② | Discharge outlet                                 |
| ③ | Refrigerant tubing (liquid tube) ø9.52 (flared)  |
| ④ | Refrigerant tubing (gas tube) ø15.88 (flared)    |
| ⑤ | Drain tube connection port VP25 (outer dia. ø32) |
| ⑥ | Power supply port                                |
| ⑦ | Discharge duct connection port (ø150)            |
| ⑧ | Suspension bolt hole (4-12×30 elongated hole)    |
| ⑨ | Fresh air intake duct connection port (ø100) *   |
| ⑩ | ECONAVI sensor (Only CZ-KPU3A)                   |

\* Necessary to attach duct connecting flange(field supplied).

<Filter dimension>

520 x 520 x 15

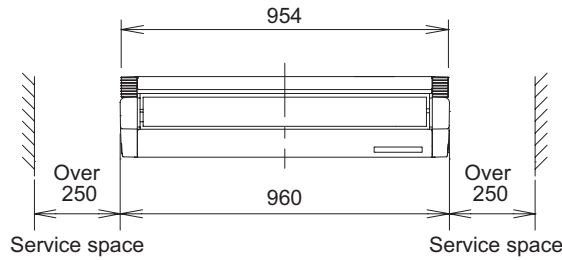
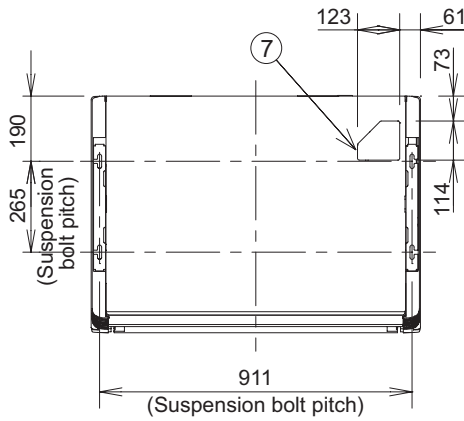
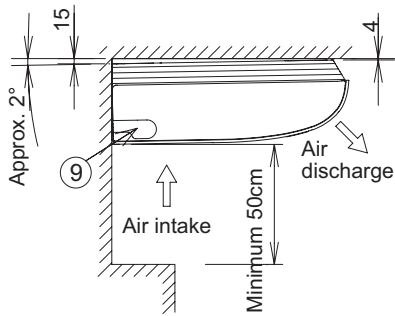
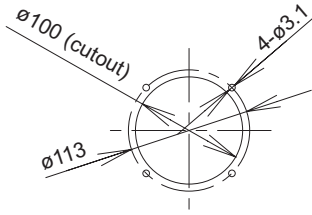


1-2. Dimensional Data

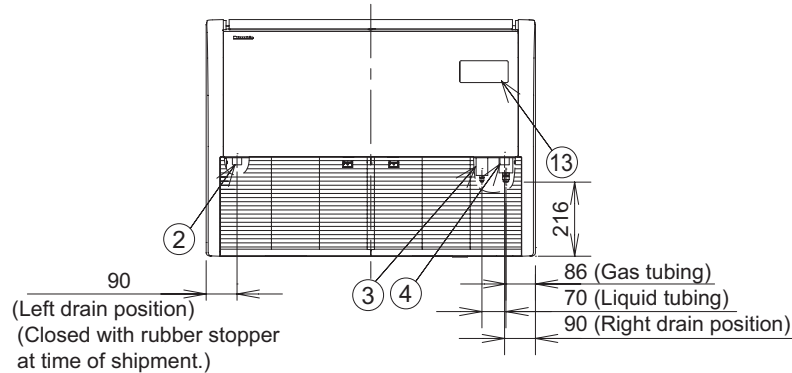
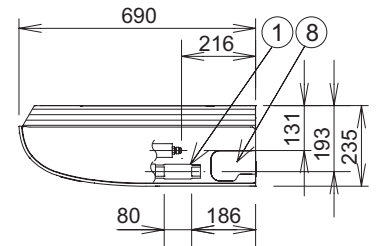
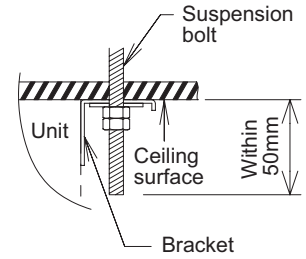
(A) Indoor Units: S-36PT2E5A, S-45PT2E5A, S-50PT2E5A

unit :mm

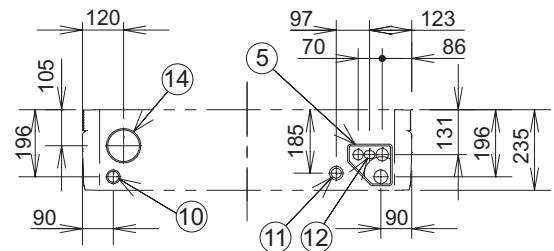
Detailed view of intaking outside air duct connection port



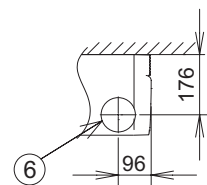
Distance of each exposed bolt must be of equal length within 50mm.



Hole position of indoor unit rear-side (Figure shows view from front)



Tubing hole position on wall surface (Figure shows view from front)



|   |  |
|---|--|
| ① | Drain port VP20 (inside diameter $\phi$ 26mm, drain hose supplied) |
| ② | Left drain position  |
| ③ | Refrigerant liquid tubing ( $\phi$ 6.35mm, flare connection)       |
| ④ | Refrigerant gas tubing ( $\phi$ 12.7mm, flare connection)          |
| ⑤ | Cover of rear tubing hole  |
| ⑥ | Tubing hole on wall surface ( $\phi$ 100mm)                        |
| ⑦ | Upper side tubing port   |
| ⑧ | Right side drain hose outlet port (cutout)                         |
| ⑨ | Left side drain hose outlet port (cutout)                          |
| ⑩ | Left-rear side drain hose outlet port (cutout)                     |
| ⑪ | Power inlet port   |
| ⑫ | Remote control wiring and inter-unit wiring inlet port             |
| ⑬ | Wireless remote controller receiver installation location          |
| ⑭ | Outside air intake duct connection port ( $\phi$ 100mm, cutout)    |

<Filter size>

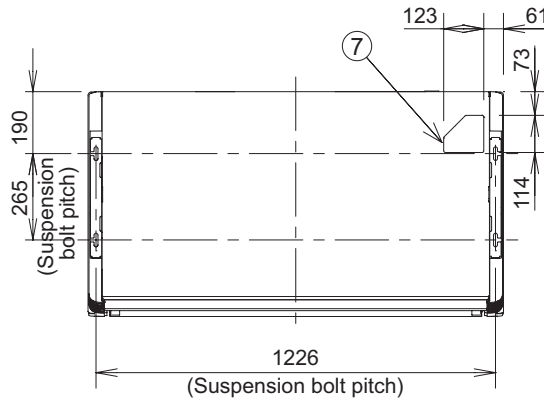
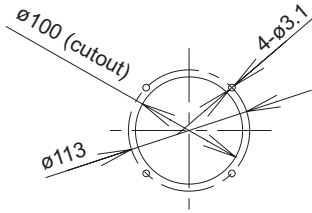
(421 x 250 x 16) x 2 pcs.

1-2. Dimensional Data

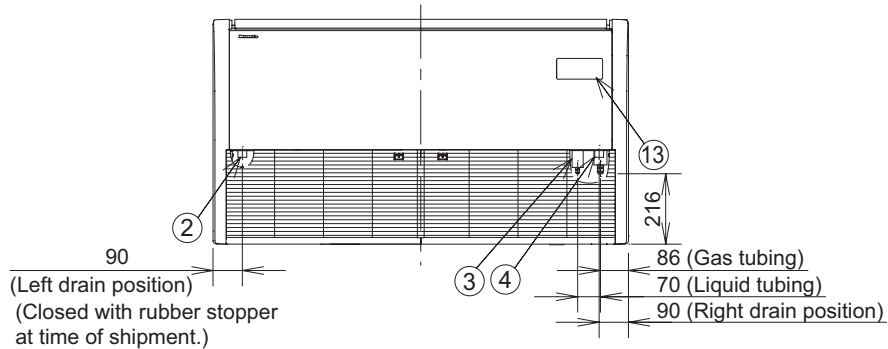
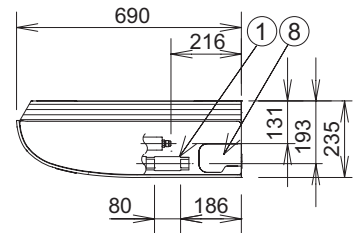
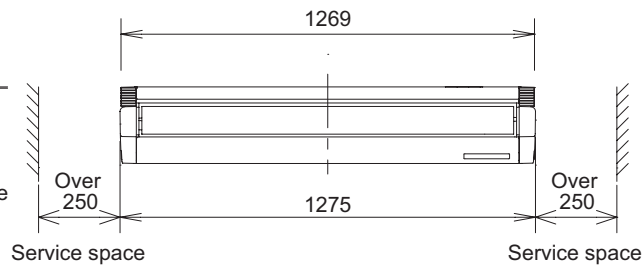
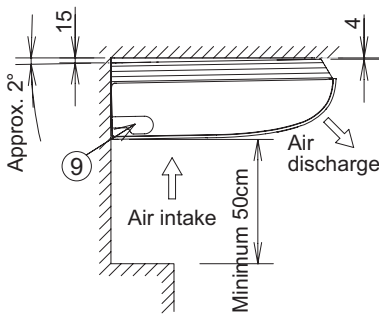
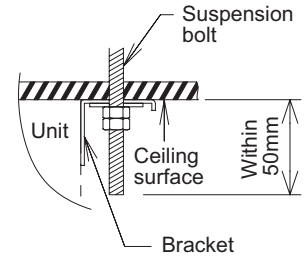
(A) Indoor Units: S-60PT2E5A, S-71PT2E5A

unit :mm

Detailed view of intaking outside air duct connection port

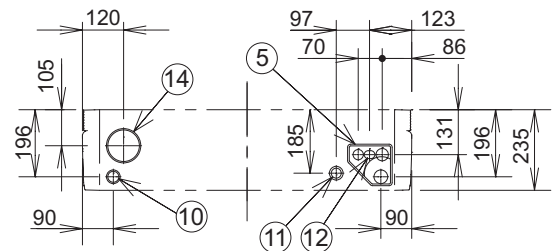


Distance of each exposed bolt must be of equal length within 50mm.

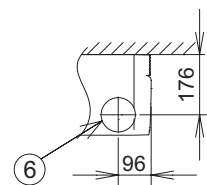


|   |  |
|---|--|
| ① | Drain port VP20 (inside diameter $\phi$ 26mm, drain hose supplied) |
| ② | Left drain position  |
| ③ | Refrigerant liquid tubing ( $\phi$ 9.52mm, flare connection)       |
| ④ | Refrigerant gas tubing ( $\phi$ 15.88mm, flare connection)         |
| ⑤ | Cover of rear tubing hole  |
| ⑥ | Tubing hole on wall surface ( $\phi$ 100mm)                        |
| ⑦ | Upper side tubing port   |
| ⑧ | Right side drain hose outlet port (cutout)                         |
| ⑨ | Left side drain hose outlet port (cutout)                          |
| ⑩ | Left-rear side drain hose outlet port (cutout)                     |
| ⑪ | Power inlet port   |
| ⑫ | Remote control wiring and inter-unit wiring inlet port             |
| ⑬ | Wireless remote controller receiver installation location          |
| ⑭ | Outside air intake duct connection port ( $\phi$ 100mm, cutout)    |

Hole position of indoor unit rear-side (Figure shows view from front)



Tubing hole position on wall surface (Figure shows view from front)



<Filter size>

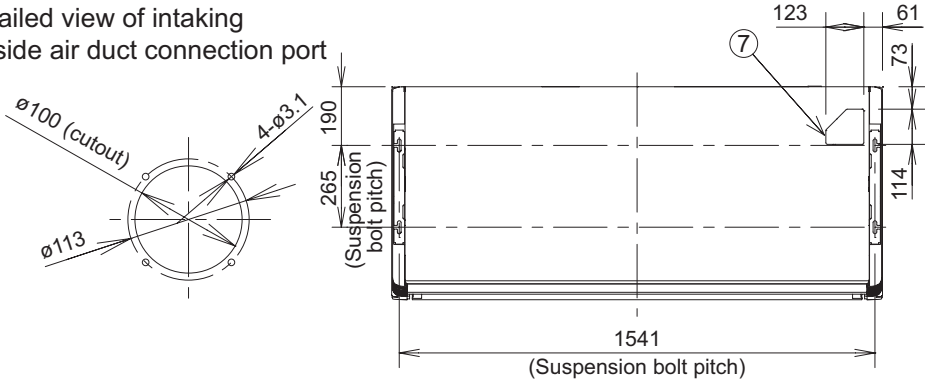
(579 x 250 x 16) x 2 pcs.

1-2. Dimensional Data

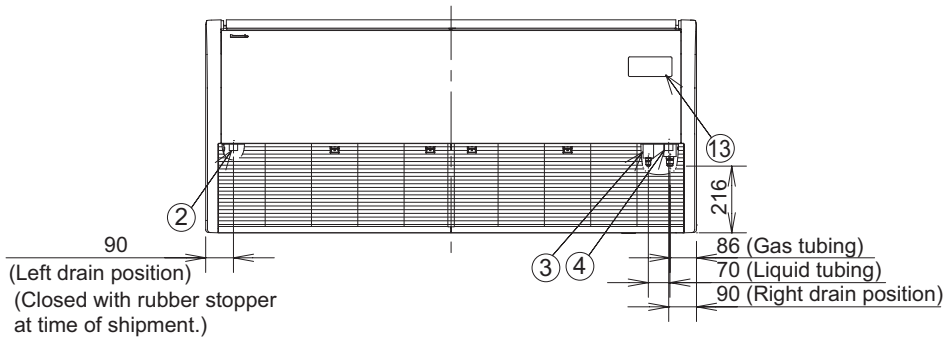
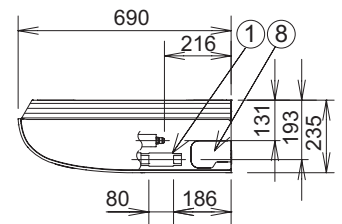
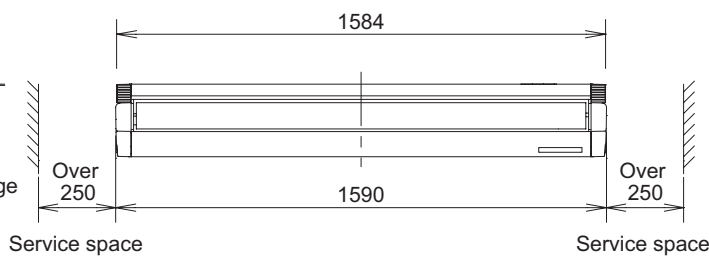
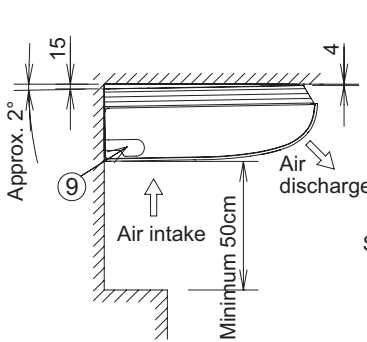
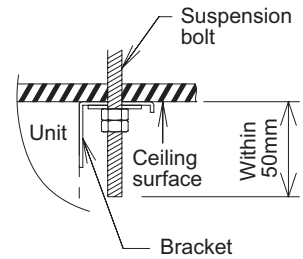
(A) Indoor Units: S-100PT2E5A, S-125PT2E5A, S-140PT2E5A

unit :mm

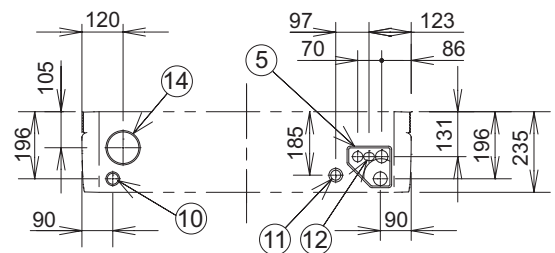
Detailed view of intaking outside air duct connection port



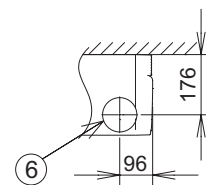
Distance of each exposed bolt must be of equal length within 50mm.



Hole position of indoor unit rear-side (Figure shows view from front)



Tubing hole position on wall surface (Figure shows view from front)



|   |  |
|---|--|
| ① | Drain port VP20 (inside diameter $\phi$ 26mm, drain hose supplied) |
| ② | Left drain position  |
| ③ | Refrigerant liquid tubing ( $\phi$ 9.52mm, flare connection)       |
| ④ | Refrigerant gas tubing ( $\phi$ 15.88mm, flare connection)         |
| ⑤ | Cover of rear tubing hole  |
| ⑥ | Tubing hole on wall surface ( $\phi$ 100mm)                        |
| ⑦ | Upper side tubing port   |
| ⑧ | Right side drain hose outlet port (cutout)                         |
| ⑨ | Left side drain hose outlet port (cutout)                          |
| ⑩ | Left-rear side drain hose outlet port (cutout)                     |
| ⑪ | Power inlet port   |
| ⑫ | Remote control wiring and inter-unit wiring inlet port             |
| ⑬ | Wireless remote controller receiver installation location          |
| ⑭ | Outside air intake duct connection port ( $\phi$ 100mm, cutout)    |

<Filter size>

(736 x 250 x 16) x 2 pcs.

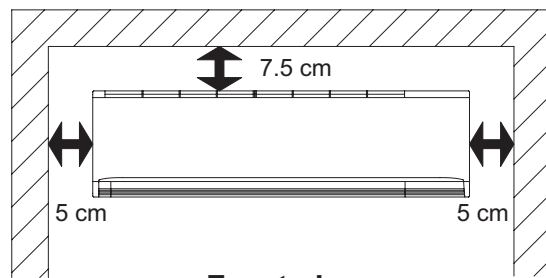
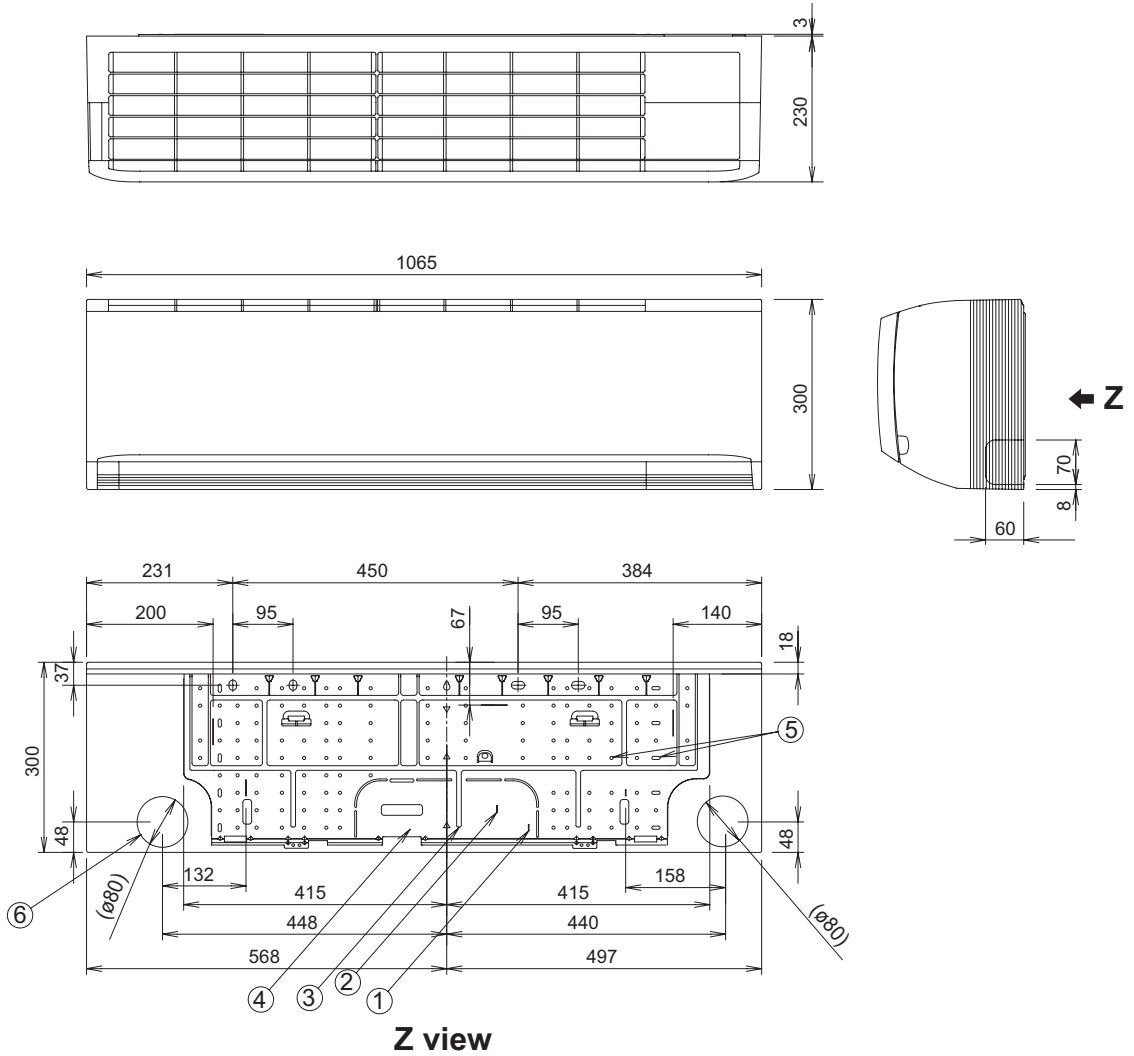
1-2. Dimensional Data

(A) Indoor Units: S-36PK1E5A, S-45PK1E5A, S-50PK1E5A, S-60PK1E5A, S-71PK1E5A, S-100PK1E5A

unit: mm

|   |   |                                 |                                   |
|---|---|---------------------------------|-----------------------------------|
| 1 | Refrigerant tubing (liquid tube)                                  | S36 - S50: $\phi 6.35$ (flared) | S60 - S100: $\phi 9.52$ (flared)  |
| 2 | Refrigerant tubing (gas tube)                                     | S36 - S50: $\phi 12.7$ (flared) | S60 - S100: $\phi 15.88$ (flared) |
| 3 | Drain hose  | VP13 (outer dia. $\phi 18$ )    |                                   |
| 4 | Rear panel (PL BACK)  |                                 |                                   |
| 5 | Rear panel fixing holes ( $\phi 5$ holes or 5X13 elongated holes) |                                 |                                   |
| 6 | Piping & coiring holes ( $\phi 80$ )                              |                                 |                                   |

《 FILTER SIZE 》  
(418.5 X 342 X 2) X 2 pcs.



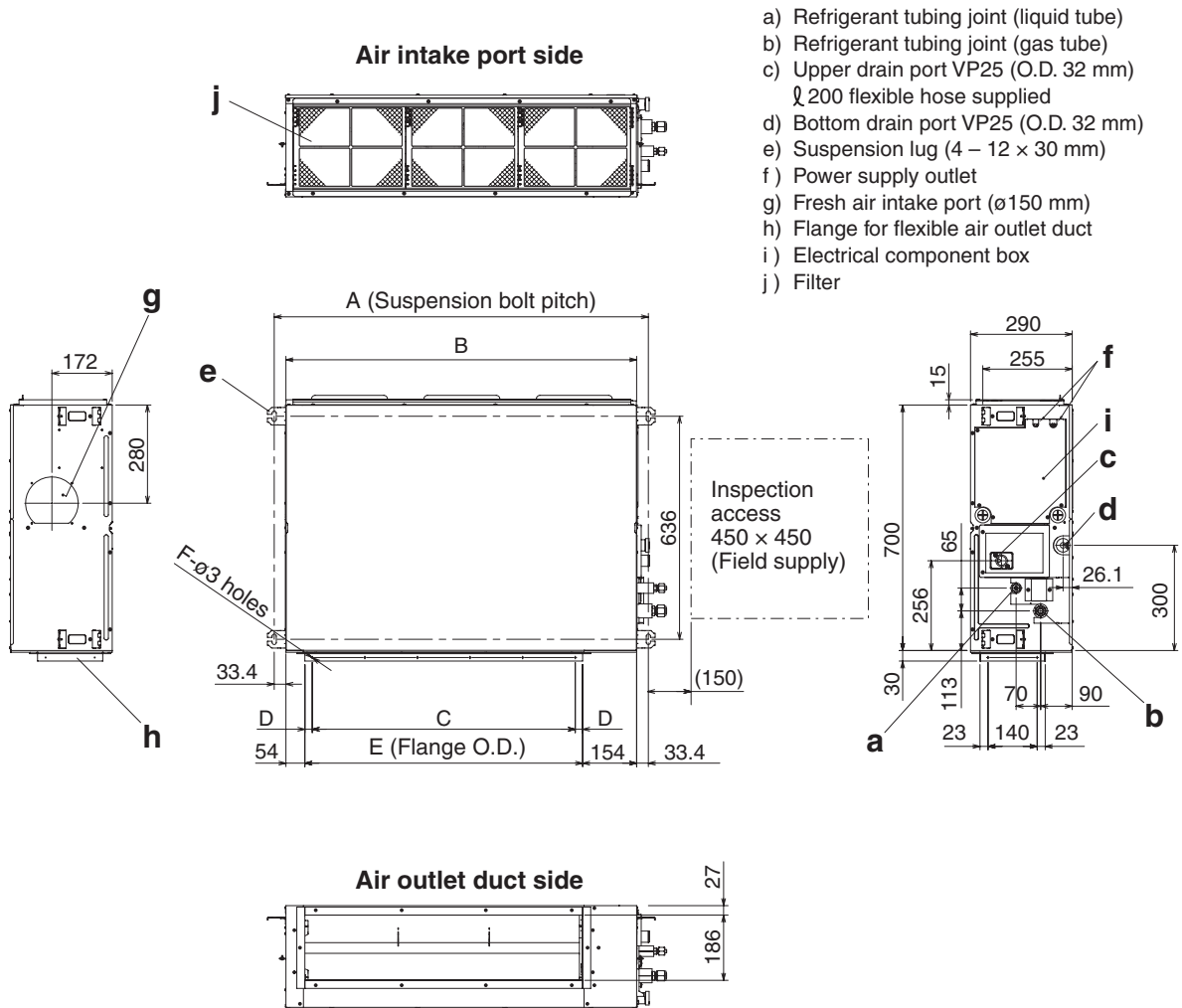
Front view  
Necessary minimum space for a installation

1-2. Dimensional Data

(A) Indoor Units: S-36PF1E5A, S-45PF1E5A, S-50PF1E5A, S-60PF1E5A, S-71PF1E5A, S-100PF1E5A, S-125PF1E5A, S-140PF1E5A

Unit: mm

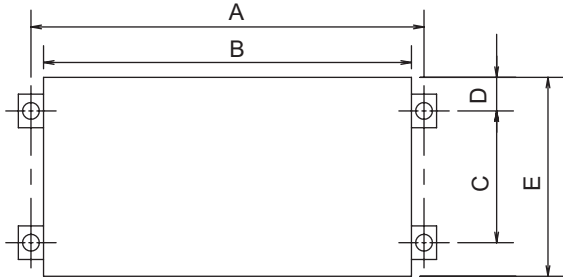
| Type          | A     | B     | C                     | D  | E     | F  |
|---------------|-------|-------|-----------------------|----|-------|----|
| 36, 45, 50    | 867   | 800   | 450 (Pitch 150 × 3)   | 71 | 592   | 12 |
| 60, 71        | 1,067 | 1,000 | 750 (Pitch 150 × 5)   | 21 | 792   | 16 |
| 100, 125, 140 | 1,467 | 1,400 | 1,050 (Pitch 150 × 7) | 71 | 1,192 | 20 |



1-2. Dimensional Data

(A) Indoor Units: S-36PN1E5A, S-45PN1E5A, S-50PN1E5A

POSITION OF SUSPENSION BOLT



(unit:mm)

| TYPE        | A    | B    | C   | D  | E   |
|-------------|------|------|-----|----|-----|
| S-36PN1E5A  | 840  | 780  | 523 | 64 | 650 |
| S-45PN1E5A  |      |      |     |    |     |
| S-50PN1E5A  |      |      |     |    |     |
| S-60PN1E5A  | 1060 | 1000 | 523 | 64 | 650 |
| S-71PN1E5A  |      |      |     |    |     |
| S-100PN1E5A | 1260 | 1200 | 523 | 64 | 650 |
| S-125PN1E5A |      |      |     |    |     |
| S-140PN1E5A |      |      |     |    |     |

| No. | NAME                     | Q'TY | NOTE              |
|-----|--------------------------|------|-------------------|
| 1   | Pipe connection (gas)    | 1    | O.D. Ø12.7 Flared |
| 2   | Pipe connection (liquid) | 1    | O.D. Ø6.35 Flared |
| 3   | Drain pipe connection    | 2    | Female screw PT1" |
| 4   | Duct connection          | 2    |                   |
| 5   | Hanger                   | 4    |                   |
| 6   | Control box              | 1    |                   |

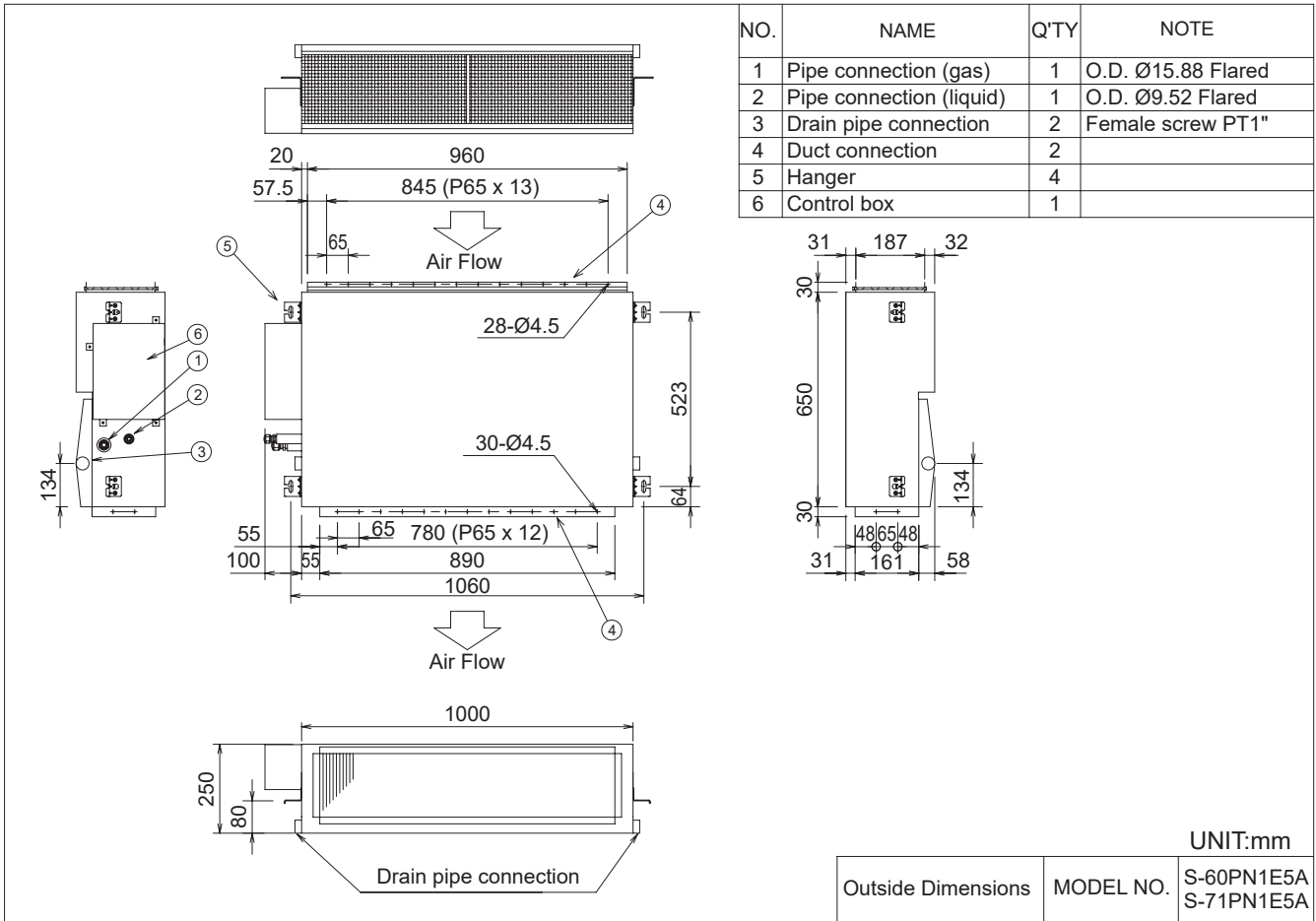
  

UNIT:mm

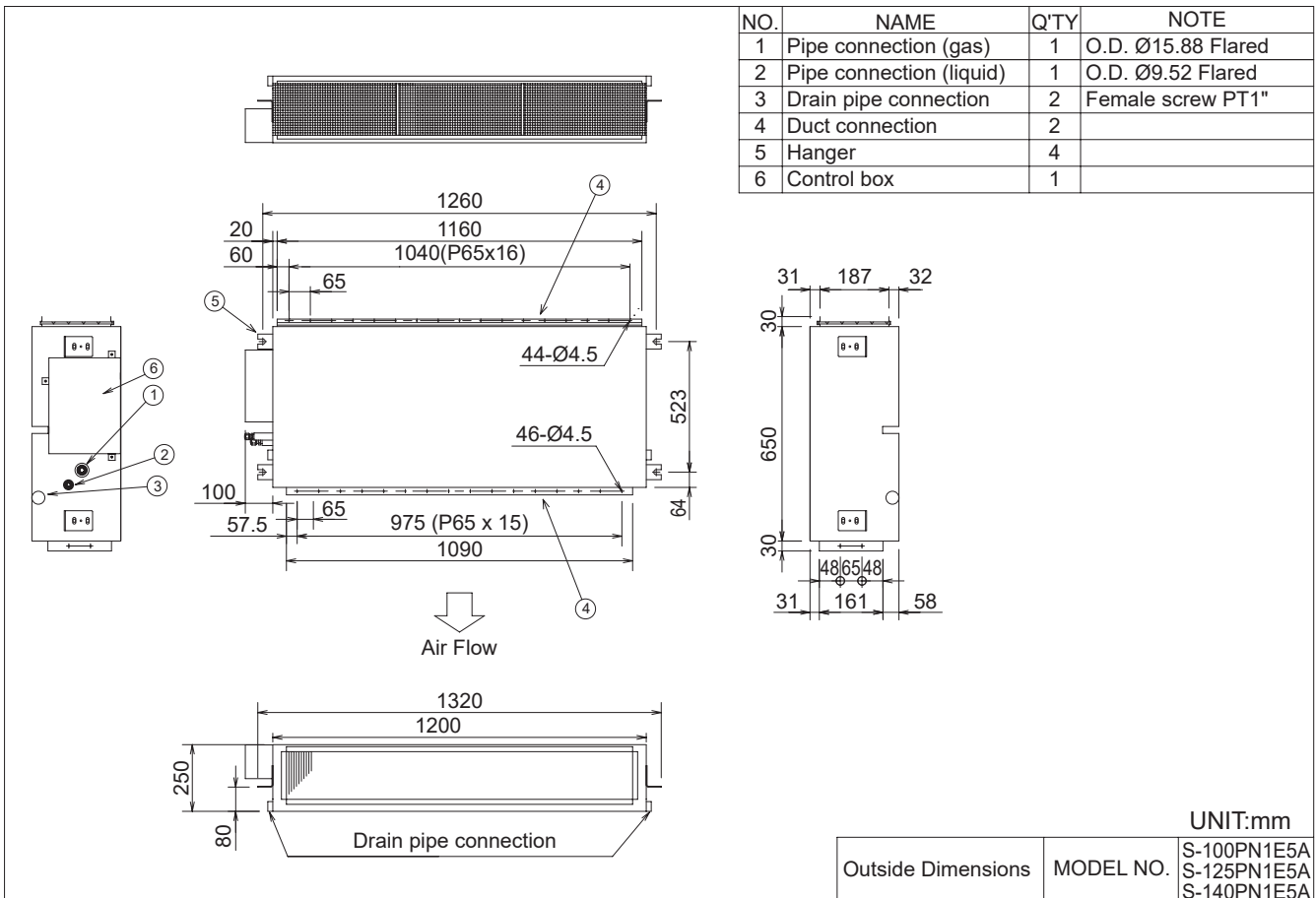
|                    |           |  |
|--------------------|-----------|--|
| Outside Dimensions | MODEL NO. | S-36PN1E5A<br>S-45PN1E5A<br>S-50PN1E5A |
|--------------------|-----------|--|

1-2. Dimensional Data

(A) Indoor Units: S-60PN1E5A, S-71PN1E5A



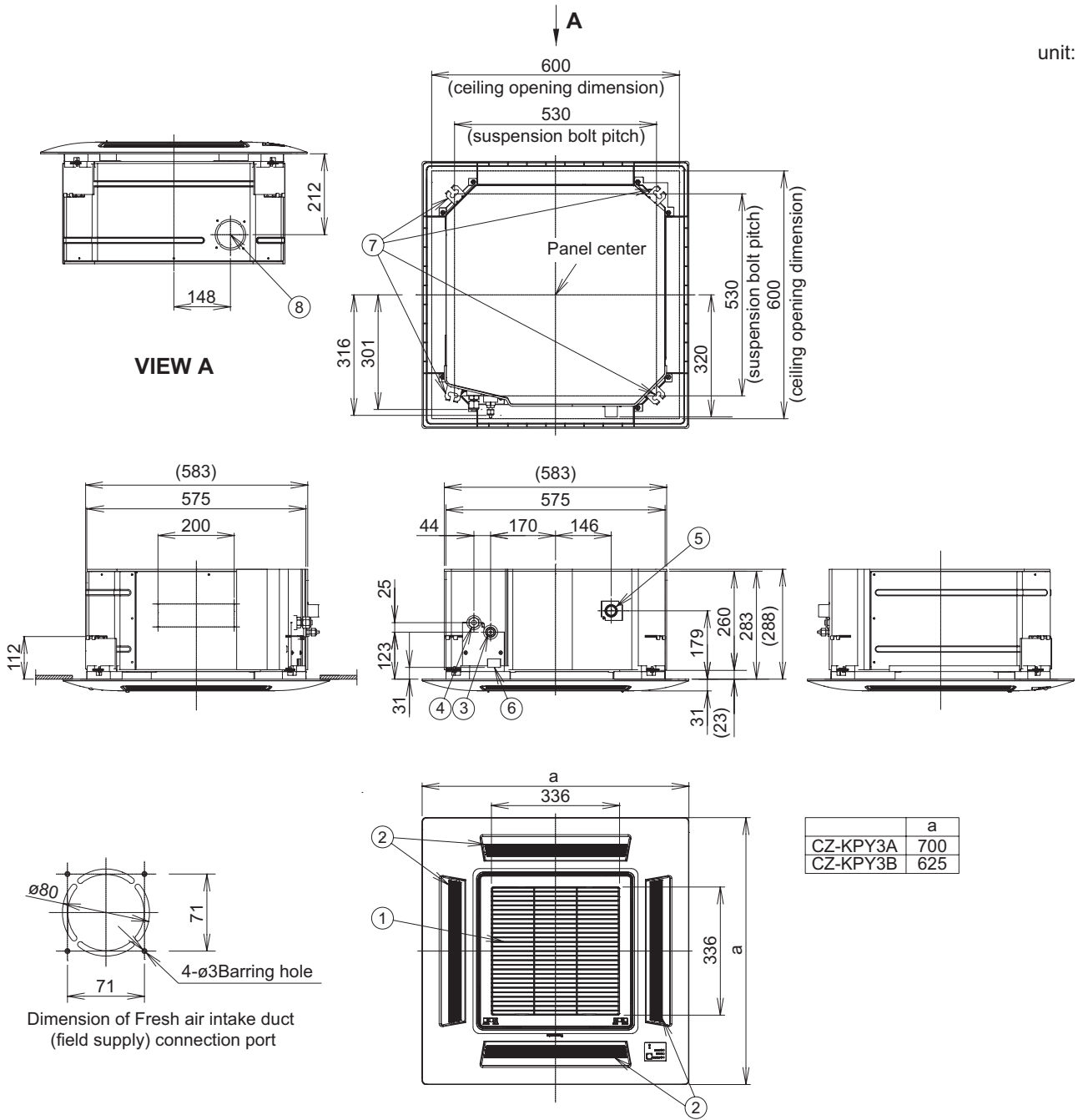
(A) Indoor Units: S-100PN1E5A, S-125PN1E5A, S-140PN1E5A



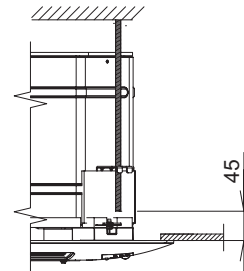
1-2. Dimensional Data

(A) Indoor Units: S-36PY2E5A, S-45PY2E5A, S-50PY2E5A

unit: mm



|   |   |
|---|---|
| ① | Air intake grille                                     |
| ② | Air outlet  |
| ③ | Refrigerant piping (liquid pipe) $\phi 6.35$ (flared) |
| ④ | Refrigerant piping (gas pipe) $\phi 12.7$ (flared)    |
| ⑤ | Drain tube connection port VP25 (outer $\phi 32$ )    |
| ⑥ | Power supply entry                                    |
| ⑦ | Suspension bolt hole (4-11 x 26 slot)                 |
| ⑧ | Fresh air intake duct connection port ( $\phi 80$ )   |

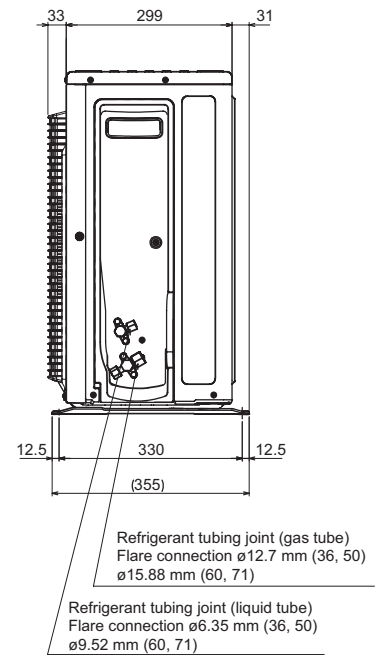
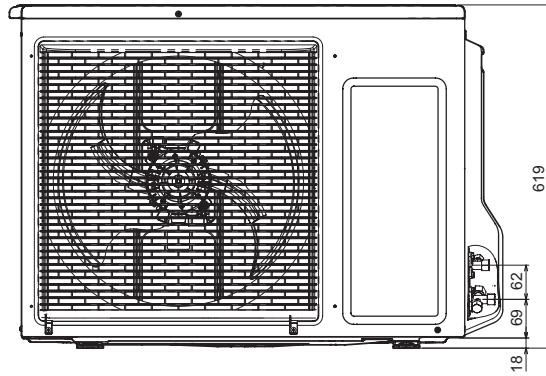
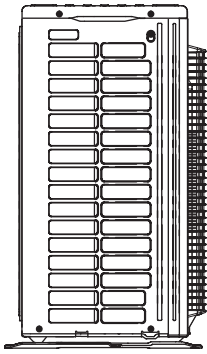
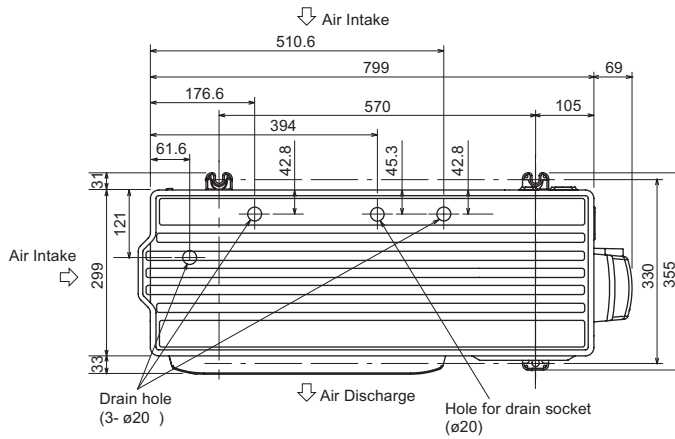


Adjust the suspension bolt length so that the gap from the lower ceiling surface becomes 45mm or more, as shown in the figure at right. If the suspension bolts is too long, it will contact the ceiling panel and the unit cannot be installed.



1-2. Dimensional Data

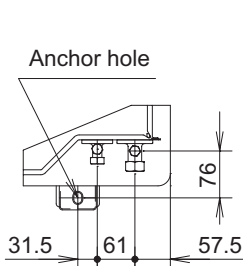
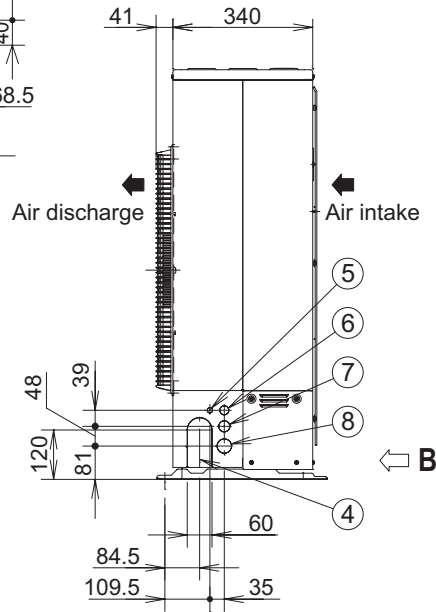
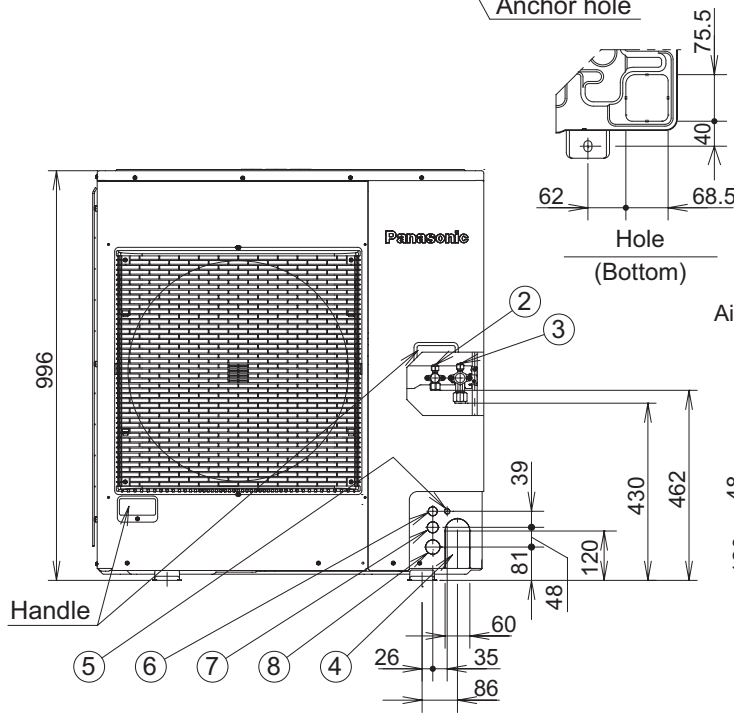
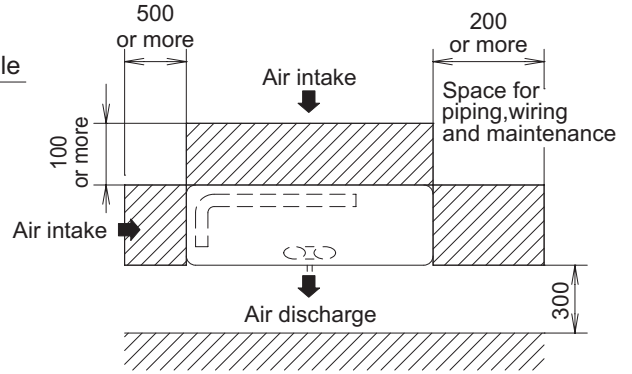
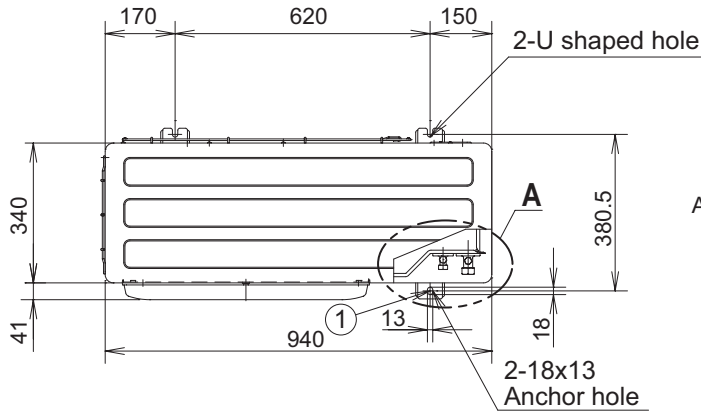
(B) Outdoor Unit: U-36PE2E5A / U-50PE2E5A / U-60PE2E5A  
 U-60PEY2E5 / U-71PEY2E5



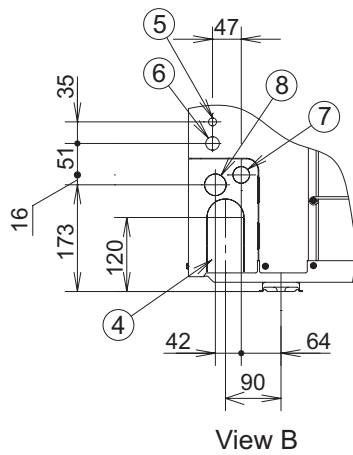
1-2. Dimensional Data

(B) Outdoor Units: U-71PE1E5A/ U-100PEY1E5/ U-125PEY1E5  
U-71PE1E8A / U-100PEY1E8/ U-125PEY1E8

Unit:mm



Enlarged view A  
Refrigerant piping end connection



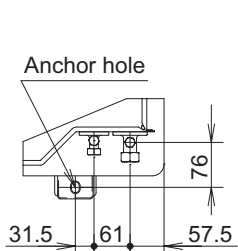
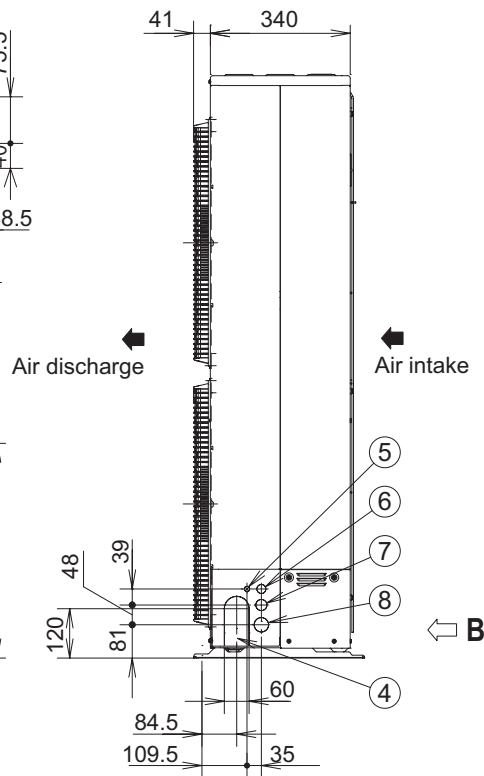
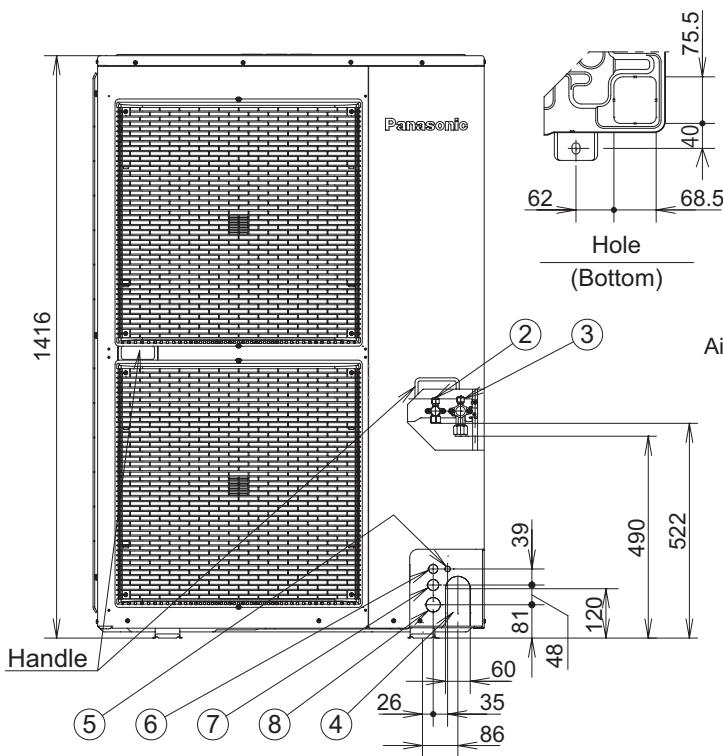
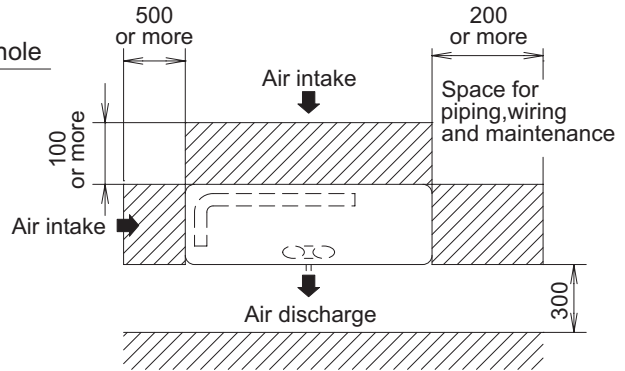
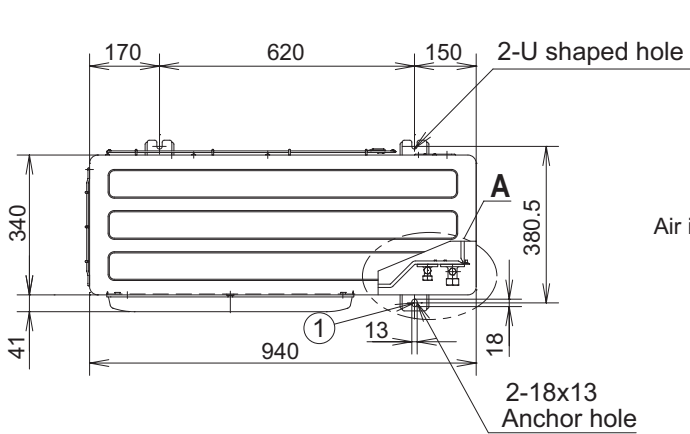
View B

unit: mm

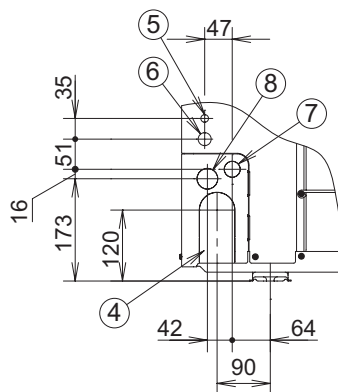
|   |   |
|---|---|
| ① | Mounting hole, anchor bolt:M10                              |
| ② | Refrigerant piping (liquid pipe), flared connection (ø9.52) |
| ③ | Refrigerant piping (gas pipe), flared connection (ø15.88)   |
| ④ | Refrigerant piping hole                                     |
| ⑤ | Electrical wiring port (ø13)                                |
| ⑥ | Electrical wiring port (ø22)                                |
| ⑦ | Electrical wiring port (ø27)                                |
| ⑧ | Electrical wiring port (ø35)                                |

1-2. Dimensional Data

(B) Outdoor Units: U-100PE1E5A / U-125PE1E5A / U-140PE1E5A  
 U-100PE1E8A / U-125PE1E8A / U-140PE1E8A / U-140PEY1E8



Enlarged view A  
 Refrigerant piping end connection



View B

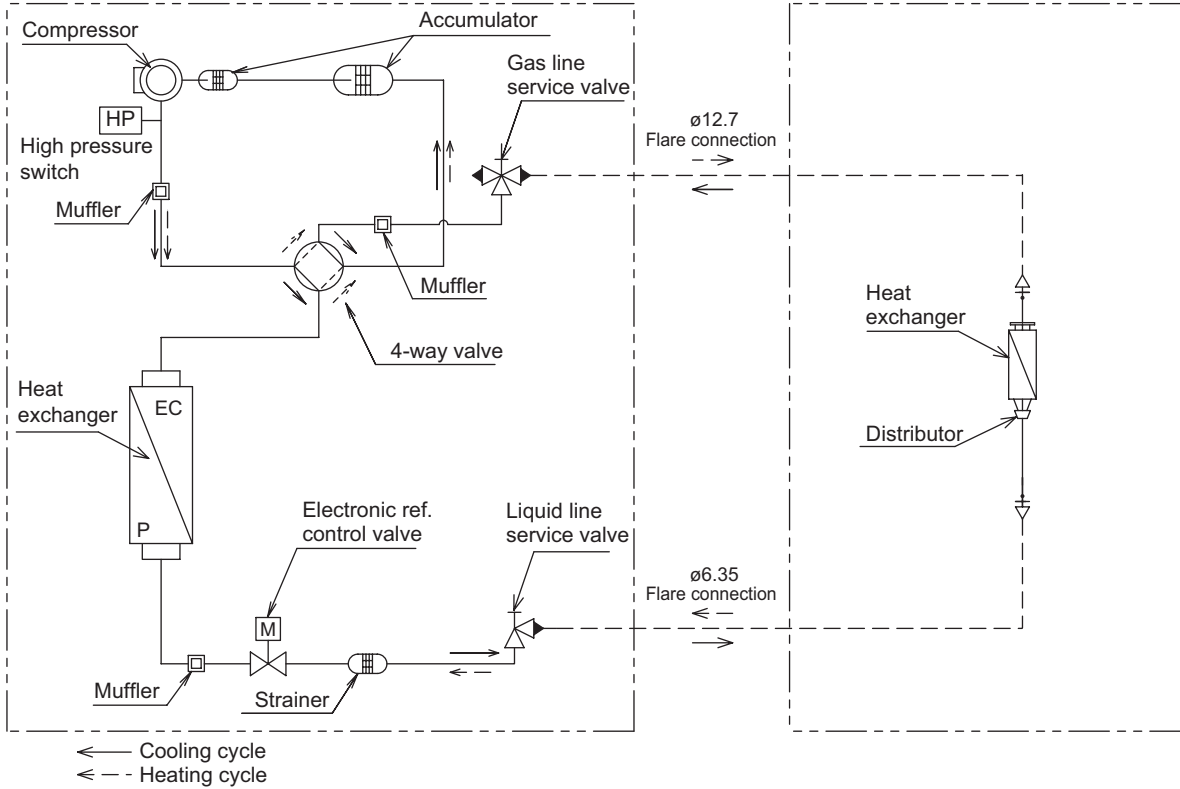
unit: mm

|   |  |
|---|--|
| ① | Mounting hole, anchor bolt:M10                             |
| ② | Refrigerant piping(liquid pipe), flared connection (ø9.52) |
| ③ | Refrigerant piping(gas pipe), flared connection (ø15.88)   |
| ④ | Refrigerant piping hole                                    |
| ⑤ | Electrical wiring port (ø13)                               |
| ⑥ | Electrical wiring port (ø22)                               |
| ⑦ | Electrical wiring port (ø27)                               |
| ⑧ | Electrical wiring port (ø35)                               |

1-3. Refrigerant Flow Diagram

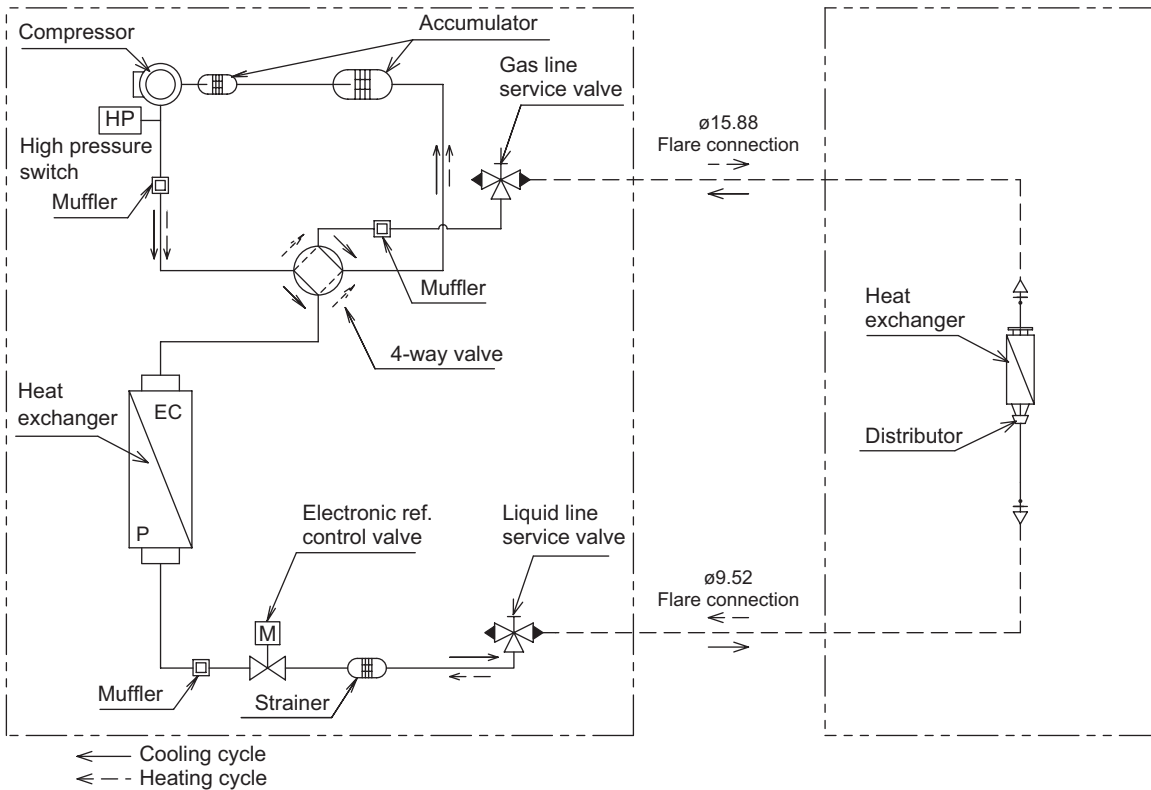
Outdoor Unit: U-36PE2E5A / U-50PE2E5A

Indoor Unit:



Outdoor Unit : U-60PE2E5A  
U-60PEY2E5 / U-71PEY2E5

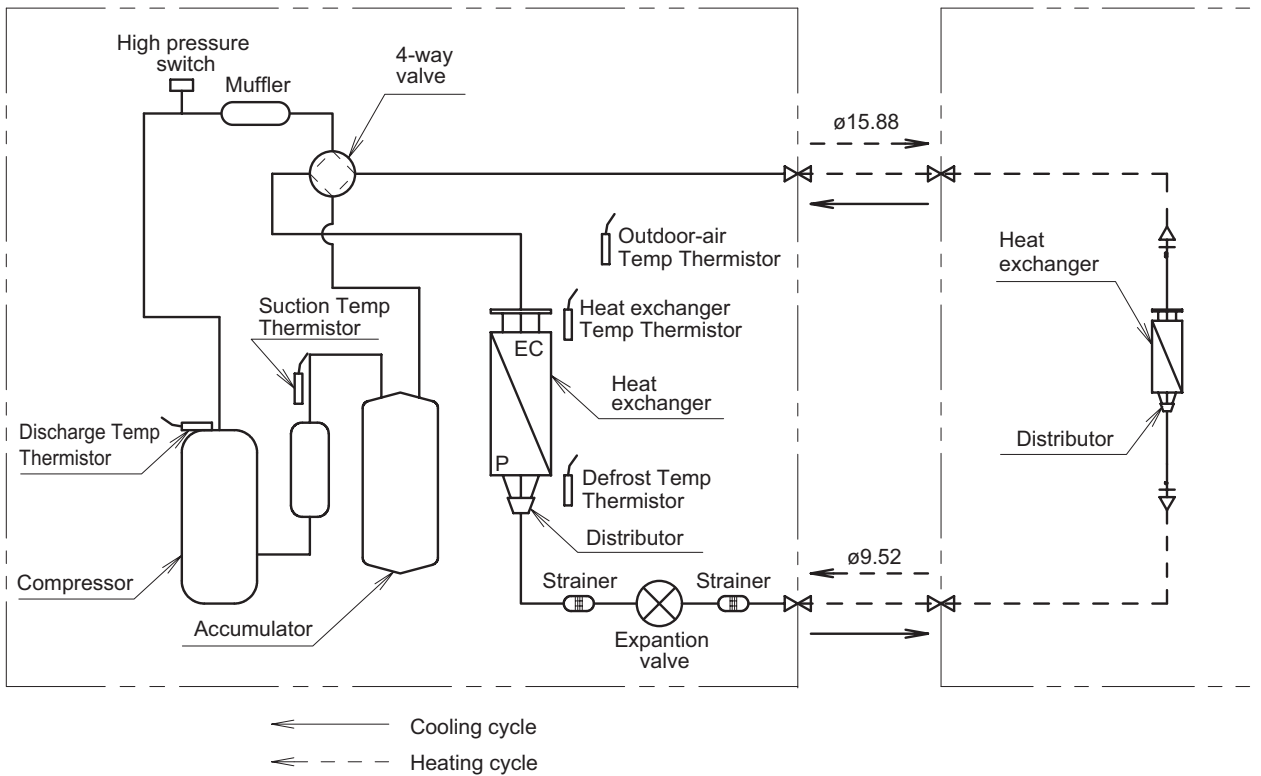
Indoor Unit:



1-3. Refrigerant Flow Diagram

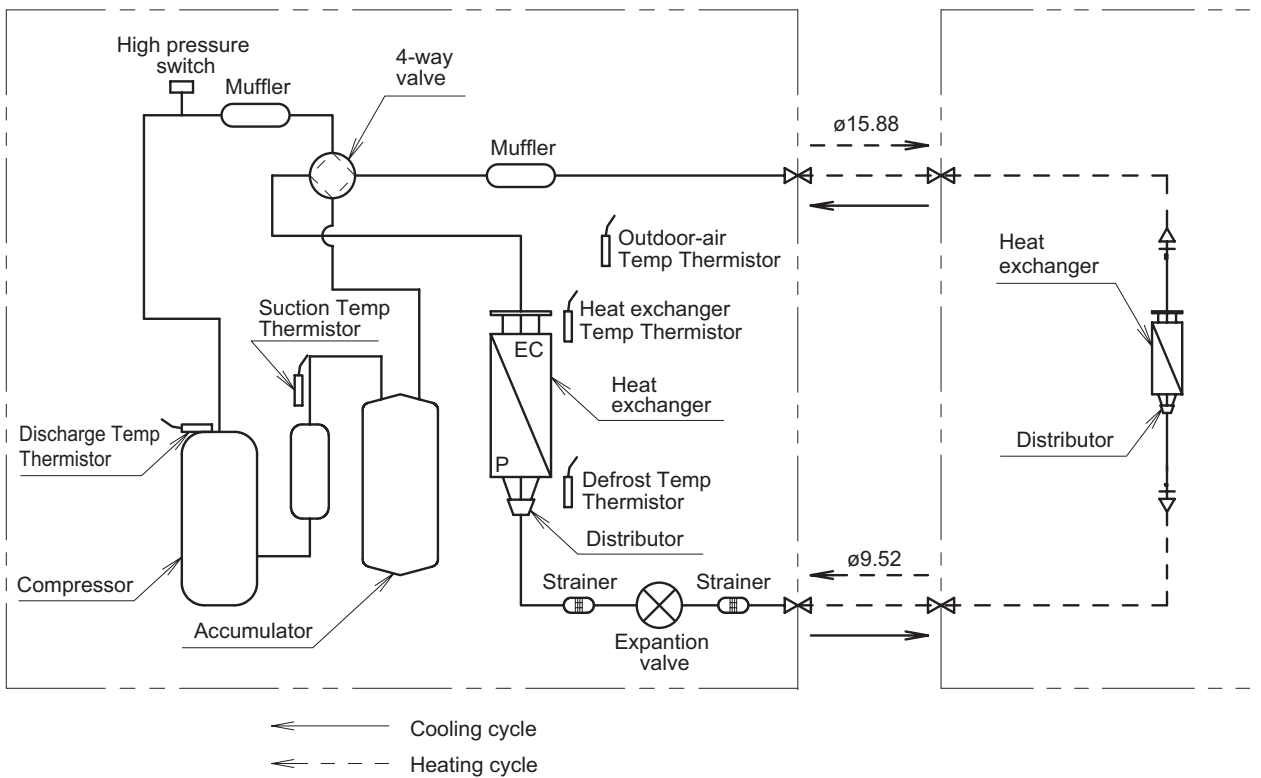
Outdoor Units: U-71PE1E5A  
U-71PE1E8A

Indoor Unit



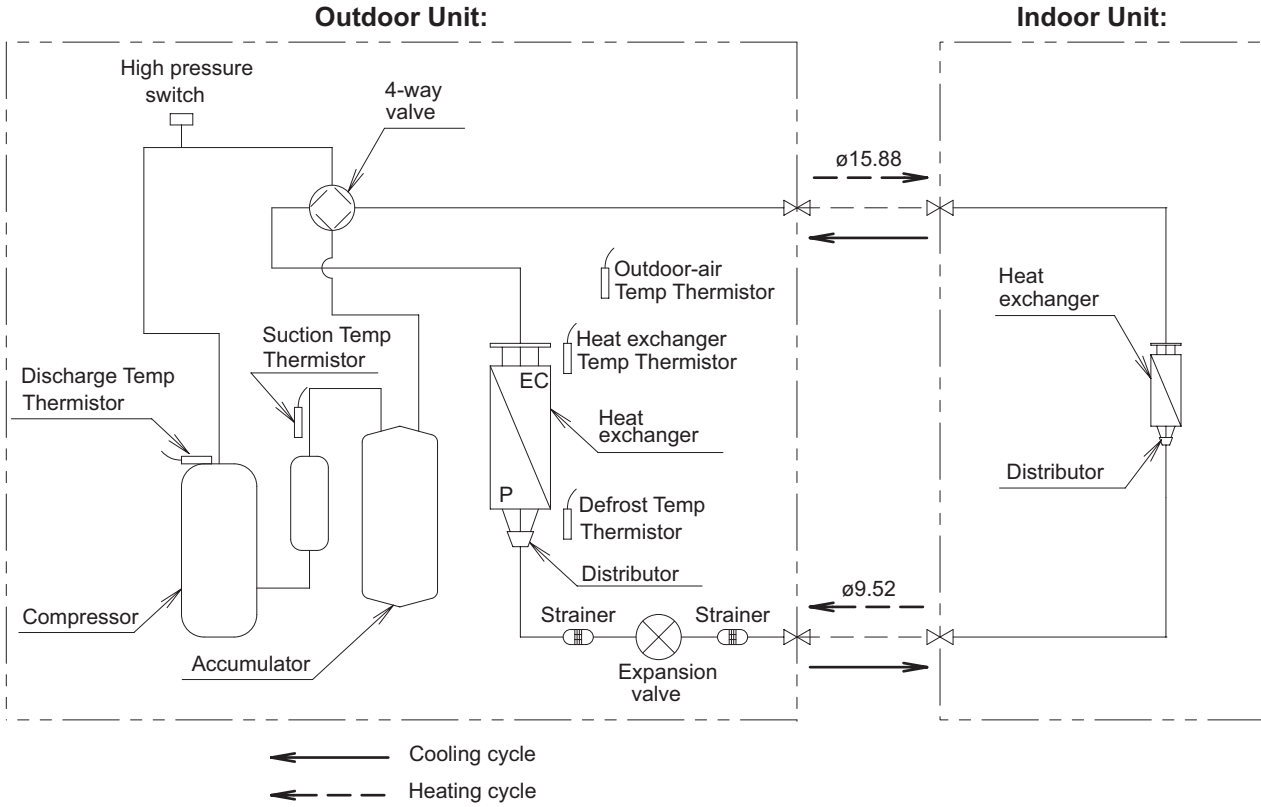
Outdoor Units: U-100PE1E5A / U-125PE1E5A / U-140PE1E5A  
U-100PE1E8A / U-125PE1E8A / U-140PE1E8A / U-140PEY1E8

Indoor Unit

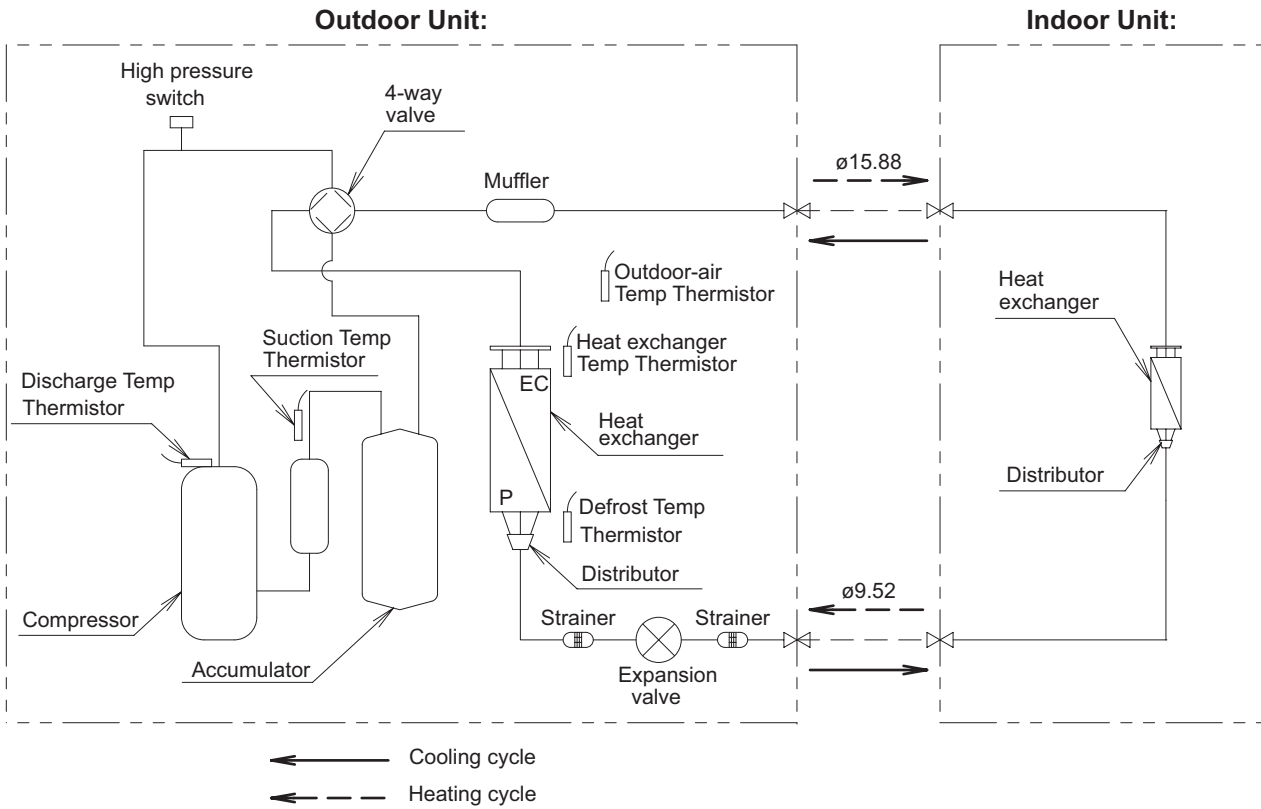


1-3. Refrigerant Flow Diagram

Outdoor Units: U-100PEY1E5 / U-100PEY1E8



Outdoor Units: U-125PEY1E5 / U-125PEY1E8



## 1-4. Operating Range

### Type PE1

|         | Temperature | Indoor air intake temp. | Outdoor air intake temp. |
|---------|-------------|-------------------------|--------------------------|
| Cooling | Maximum     | 32°C DB / 25°C WB       | 46°C DB                  |
|         | Minimum     | 18°C DB / 14°C WB       | -15°C DB                 |
| Heating | Maximum     | 30°C DB / – WB          | 24°C DB / 18°C WB        |
|         | Minimum     | 16°C DB / – WB          | -20°C DB / -20°C WB      |

### Type PEY1

|         | Temperature | Indoor air intake temp. | Outdoor air intake temp. |
|---------|-------------|-------------------------|--------------------------|
| Cooling | Maximum     | 32°C DB / 25°C WB       | 43°C DB                  |
|         | Minimum     | 18°C DB / 14°C WB       | -10°C DB                 |
| Heating | Maximum     | 30°C DB / – WB          | 24°C DB / 18°C WB        |
|         | Minimum     | 16°C DB / – WB          | -15°C DB / -15°C WB      |

### Type PE2

|         | Temperature | Indoor air intake temp. | Outdoor air intake temp. |
|---------|-------------|-------------------------|--------------------------|
| Cooling | Maximum     | 32°C DB / 25°C WB       | 46°C DB                  |
|         | Minimum     | 18°C DB / 14°C WB       | -15°C DB                 |
| Heating | Maximum     | 30°C DB / – WB          | 24°C DB / 18°C WB        |
|         | Minimum     | 16°C DB / – WB          | -20°C DB / -20°C WB      |

### Type PEY2

|         | Temperature | Indoor air intake temp. | Outdoor air intake temp. |
|---------|-------------|-------------------------|--------------------------|
| Cooling | Maximum     | 32°C DB / 25°C WB       | 43°C DB                  |
|         | Minimum     | 18°C DB / 14°C WB       | -10°C DB                 |
| Heating | Maximum     | 30°C DB / – WB          | 24°C DB / 18°C WB        |
|         | Minimum     | 16°C DB / – WB          | -15°C DB / -15°C WB      |

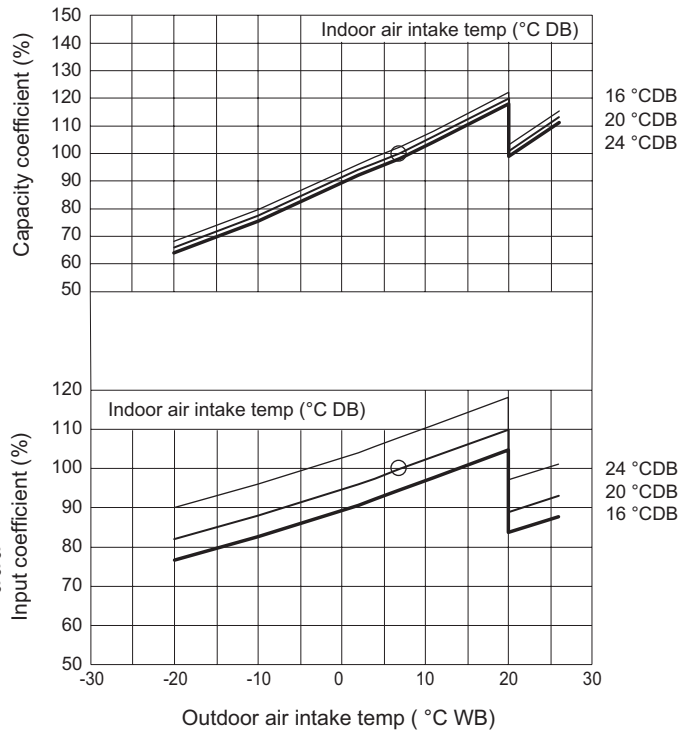
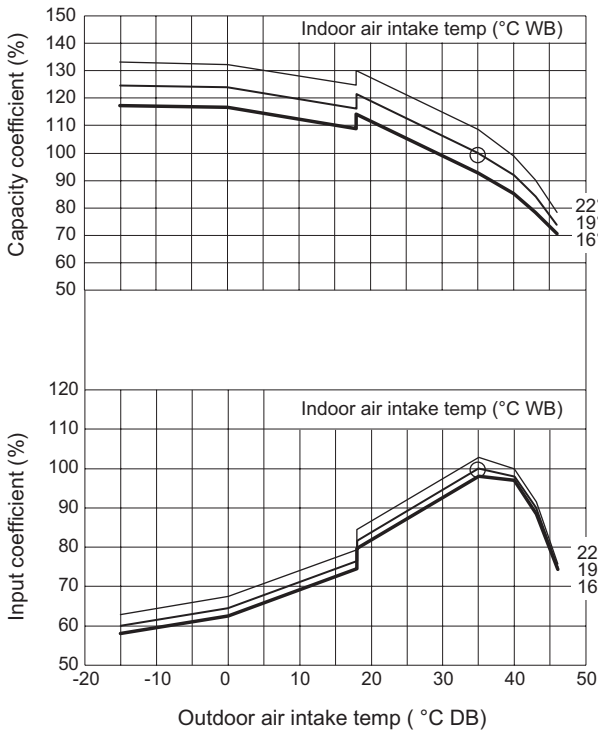
1-5. Capacity Correction Graph According to Temperature Condition

PE2

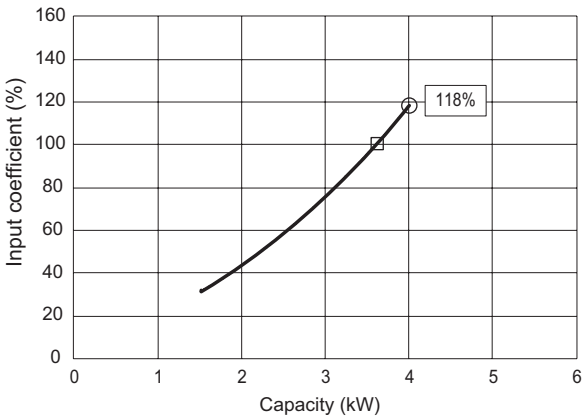
U-36PE2E5A (For 50 Hz)

Cooling capacity ratio (maximum capacity)

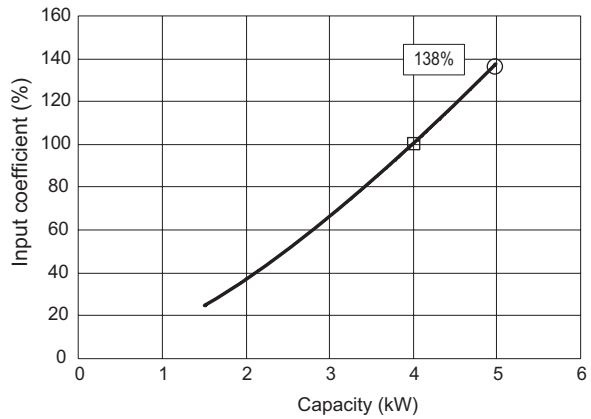
Heating capacity ratio (maximum capacity)



Cooling



Heating



Outdoor unit heating capacity correction coefficient during of frosting/defrosting (RH approximately 85%)

|                                      |       |       |       |       |       |       |       |       |       |       |       |       |       |       |       |       |       |       |       |
|--------------------------------------|-------|-------|-------|-------|-------|-------|-------|-------|-------|-------|-------|-------|-------|-------|-------|-------|-------|-------|-------|
| Outdoor intake air temperature °C WB | -20.0 | -19.0 | -18.0 | -17.0 | -16.0 | -15.0 | -14.0 | -13.0 | -12.0 | -11.0 | -10.0 | -9.0  | -8.0  | -7.0  | -6.0  | -5.0  | -4.0  | -3.0  | -2.0  |
| Correction coefficient               | 0.966 | 0.966 | 0.962 | 0.958 | 0.954 | 0.946 | 0.945 | 0.940 | 0.935 | 0.930 | 0.925 | 0.920 | 0.915 | 0.915 | 0.905 | 0.900 | 0.895 | 0.890 | 0.874 |

|                                      |       |       |       |       |       |       |       |       |       |
|--------------------------------------|-------|-------|-------|-------|-------|-------|-------|-------|-------|
| Outdoor intake air temperature °C WB | -1.0  | 0.0   | 1.0   | 2.0   | 3.0   | 4.0   | 5.0   | 6.0   | 7.0   |
| Correction coefficient               | 0.888 | 0.902 | 0.916 | 0.930 | 0.944 | 0.958 | 0.972 | 0.986 | 1.000 |

To calculate the heating capacity with consideration for frosting/defrosting operation, multiply the heating capacity found from the capacity graph by the correction coefficient from the table above.

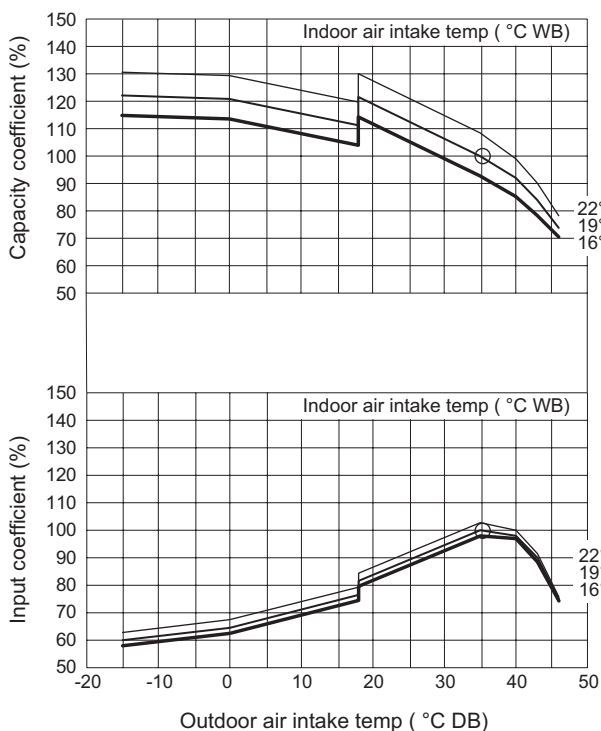


1-5. Capacity Correction Graph According to Temperature Condition

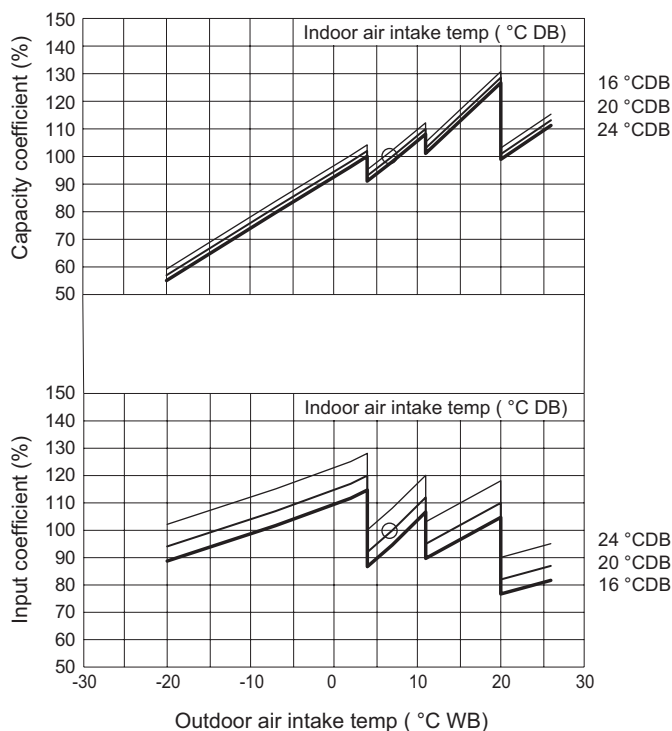
PE2

U-50PE2E5A (For 50 Hz)

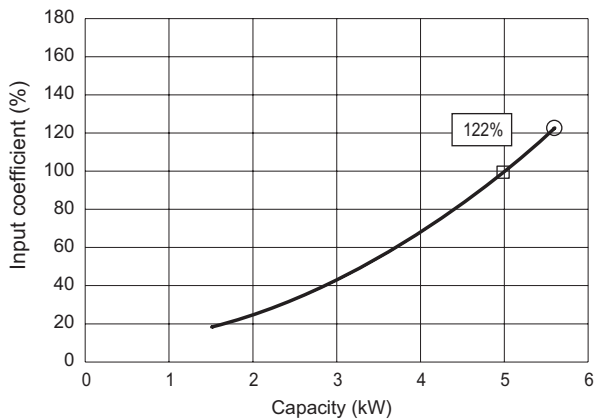
Cooling capacity ratio (maximum capacity)



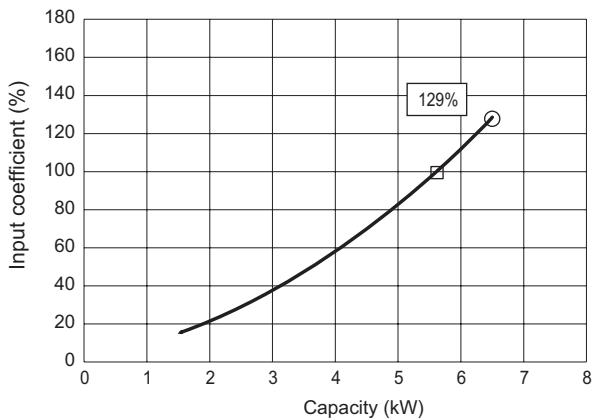
Heating capacity ratio (maximum capacity)



Cooling



Heating



Outdoor unit heating capacity correction coefficient during of frosting/defrosting (RH approximately 85%)

|                                      |       |       |       |       |       |       |       |       |       |       |       |       |       |       |       |       |       |       |       |
|--------------------------------------|-------|-------|-------|-------|-------|-------|-------|-------|-------|-------|-------|-------|-------|-------|-------|-------|-------|-------|-------|
| Outdoor intake air temperature °C WB | -20.0 | -19.0 | -18.0 | -17.0 | -16.0 | -15.0 | -14.0 | -13.0 | -12.0 | -11.0 | -10.0 | -9.0  | -8.0  | -7.0  | -6.0  | -5.0  | -4.0  | -3.0  | -2.0  |
| Correction coefficient               | 0.966 | 0.966 | 0.962 | 0.958 | 0.954 | 0.946 | 0.945 | 0.940 | 0.935 | 0.930 | 0.925 | 0.920 | 0.915 | 0.915 | 0.905 | 0.900 | 0.895 | 0.890 | 0.874 |

|                                      |       |       |       |       |       |       |       |       |       |
|--------------------------------------|-------|-------|-------|-------|-------|-------|-------|-------|-------|
| Outdoor intake air temperature °C WB | -1.0  | 0.0   | 1.0   | 2.0   | 3.0   | 4.0   | 5.0   | 6.0   | 7.0   |
| Correction coefficient               | 0.888 | 0.902 | 0.916 | 0.930 | 0.944 | 0.958 | 0.972 | 0.986 | 1.000 |

To calculate the heating capacity with consideration for frosting/defrosting operation, multiply the heating capacity found from the capacity graph by the correction coefficient from the table above.

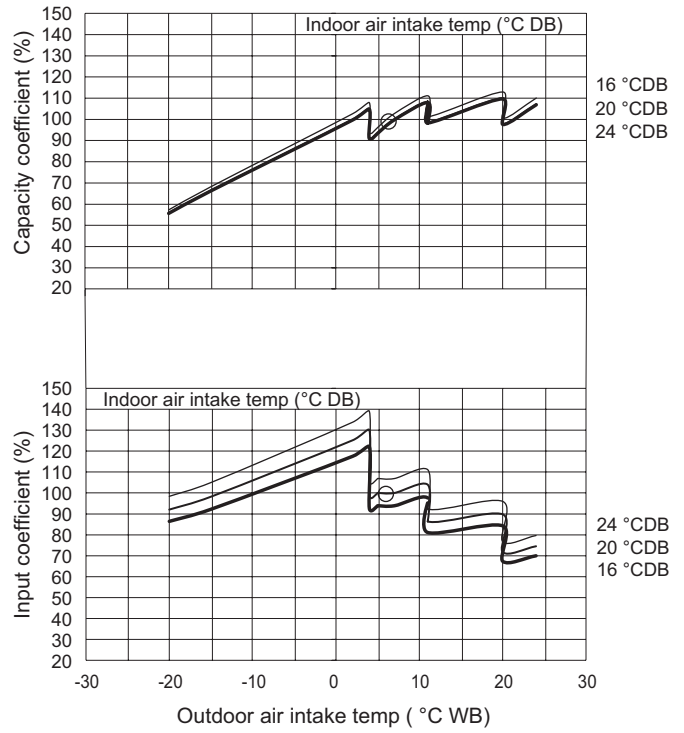
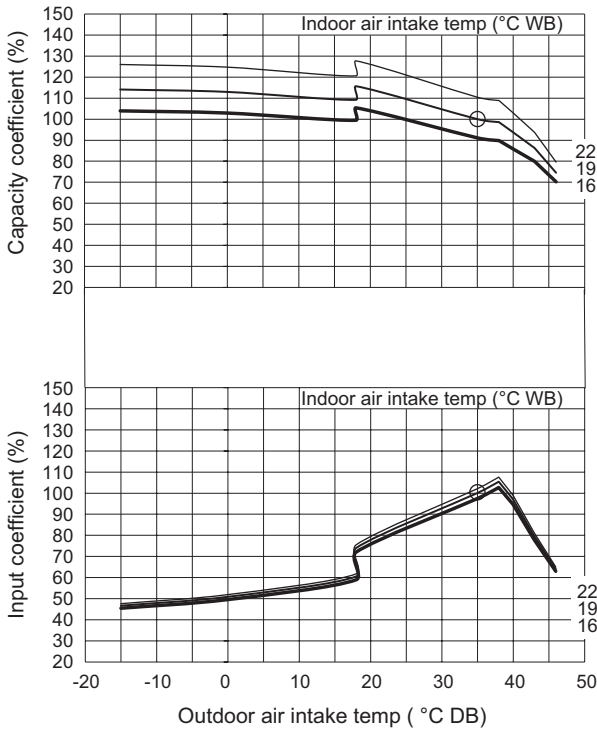
1-5. Capacity Correction Graph According to Temperature Condition

PE2

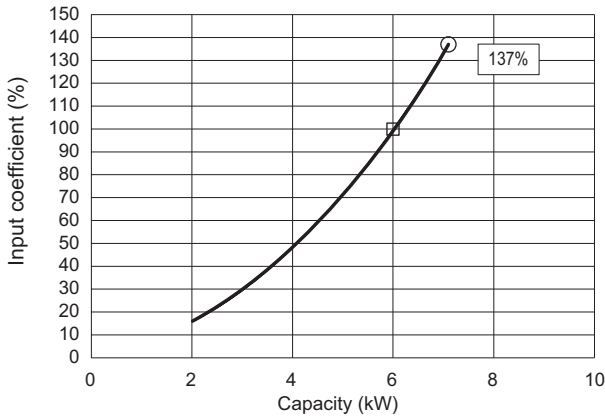
U-60PE2E5A (For 50 Hz)

Cooling capacity ratio (maximum capacity)

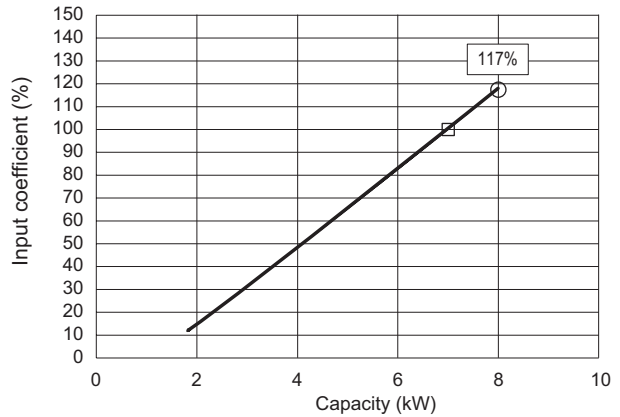
Heating capacity ratio (maximum capacity)



Cooling



Heating



Outdoor unit heating capacity correction coefficient during of frosting/defrosting (RH approximately 85%)

|                                      |       |       |       |       |       |       |       |       |       |       |       |       |       |       |       |       |       |       |       |
|--------------------------------------|-------|-------|-------|-------|-------|-------|-------|-------|-------|-------|-------|-------|-------|-------|-------|-------|-------|-------|-------|
| Outdoor intake air temperature °C WB | -20.0 | -19.0 | -18.0 | -17.0 | -16.0 | -15.0 | -14.0 | -13.0 | -12.0 | -11.0 | -10.0 | -9.0  | -8.0  | -7.0  | -6.0  | -5.0  | -4.0  | -3.0  | -2.0  |
| Correction coefficient               | 0.966 | 0.966 | 0.962 | 0.958 | 0.954 | 0.946 | 0.945 | 0.940 | 0.935 | 0.930 | 0.925 | 0.920 | 0.915 | 0.915 | 0.905 | 0.900 | 0.895 | 0.890 | 0.874 |

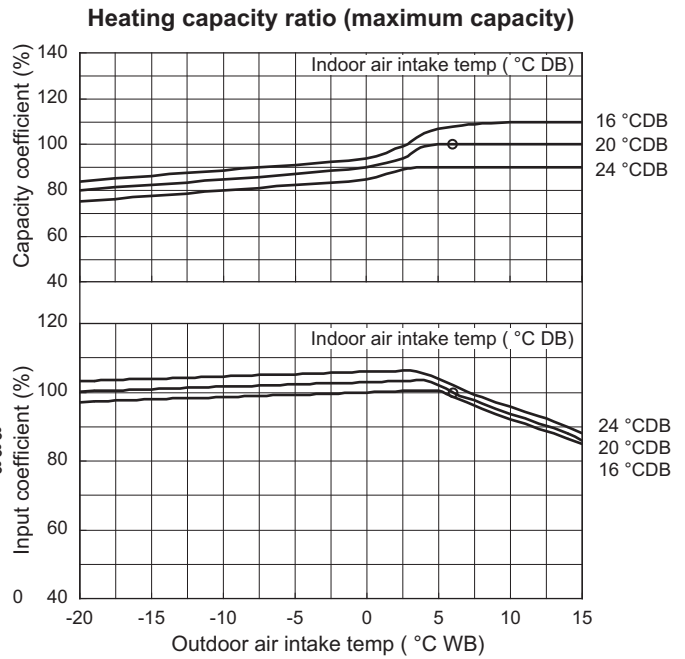
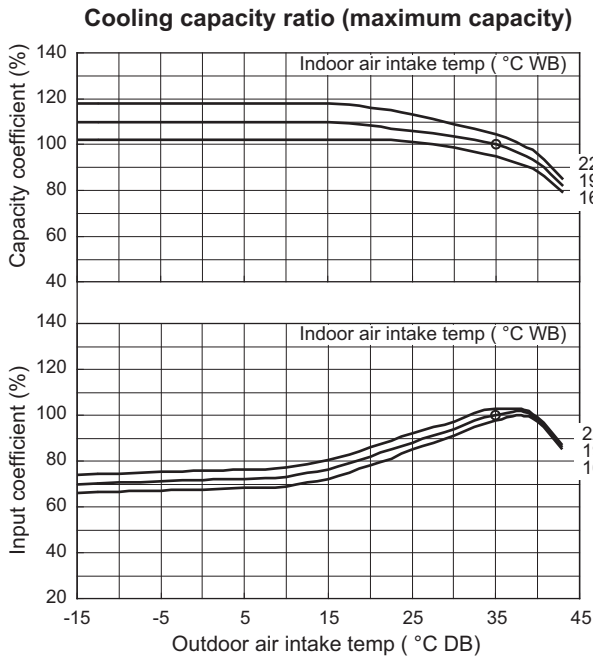
|                                      |       |       |       |       |       |       |       |       |       |
|--------------------------------------|-------|-------|-------|-------|-------|-------|-------|-------|-------|
| Outdoor intake air temperature °C WB | -1.0  | 0.0   | 1.0   | 2.0   | 3.0   | 4.0   | 5.0   | 6.0   | 7.0   |
| Correction coefficient               | 0.888 | 0.902 | 0.916 | 0.930 | 0.944 | 0.958 | 0.972 | 0.986 | 1.000 |

To calculate the heating capacity with consideration for frosting/defrosting operation, multiply the heating capacity found from the capacity graph by the correction coefficient from the table above.

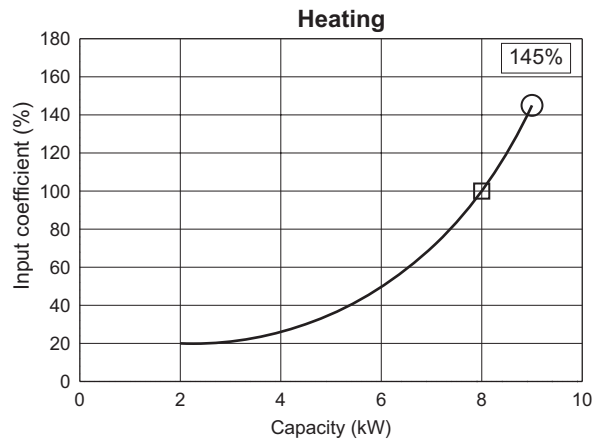
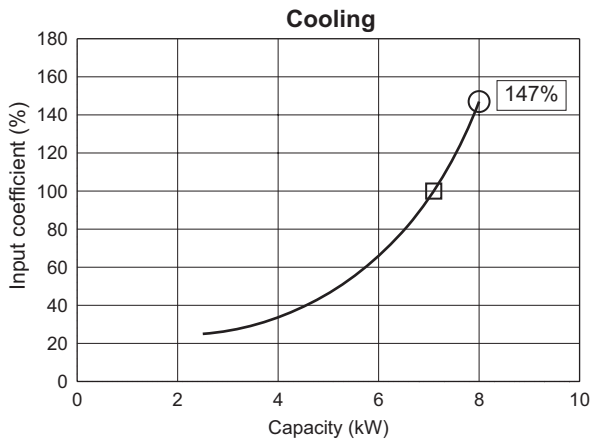
1-5. Capacity Correction Graph According to Temperature Condition

PE1

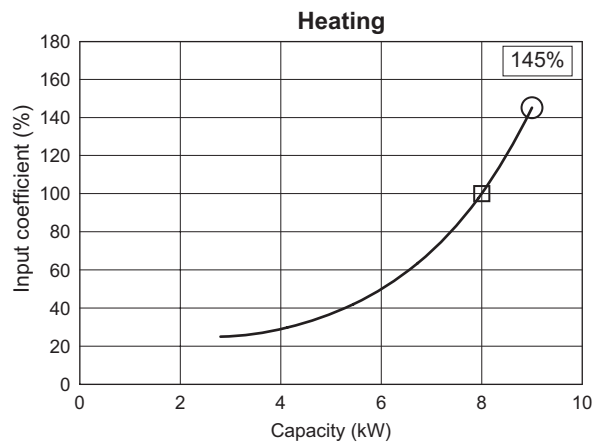
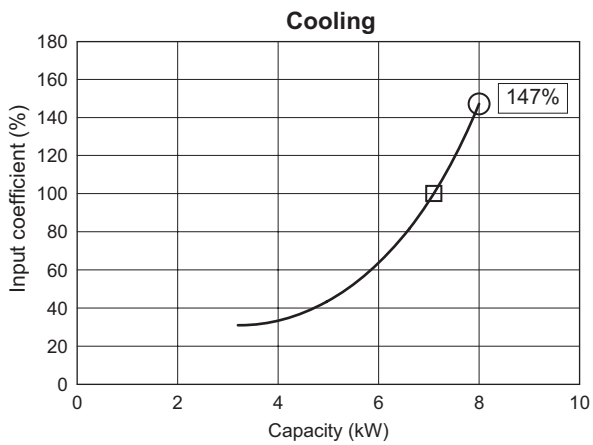
■ U-71PE1E5A (For 50 Hz) / U-71PE1E8A (For 50 Hz)



■ U-71PE1E5A (For 50 Hz)



■ U-71PE1E8A (For 50 Hz)



Outdoor unit heating capacity correction coefficient during of frosting/defrosting (RH approximately 85%)

|                                      |     |     |      |      |      |      |      |      |      |      |      |      |      |      |      |      |      |      |     |
|--------------------------------------|-----|-----|------|------|------|------|------|------|------|------|------|------|------|------|------|------|------|------|-----|
| Outdoor intake air temperature °C WB | -20 | -15 | -10  | -9   | -8   | -7   | -6   | -5   | -4   | -3   | -2   | -1   | 0    | 1    | 2    | 3    | 4    | 5    | 6   |
| Correction coefficient               | 1.0 | 1.0 | 0.97 | 0.96 | 0.96 | 0.95 | 0.94 | 0.91 | 0.89 | 0.88 | 0.87 | 0.87 | 0.87 | 0.88 | 0.89 | 0.91 | 0.92 | 0.95 | 1.0 |

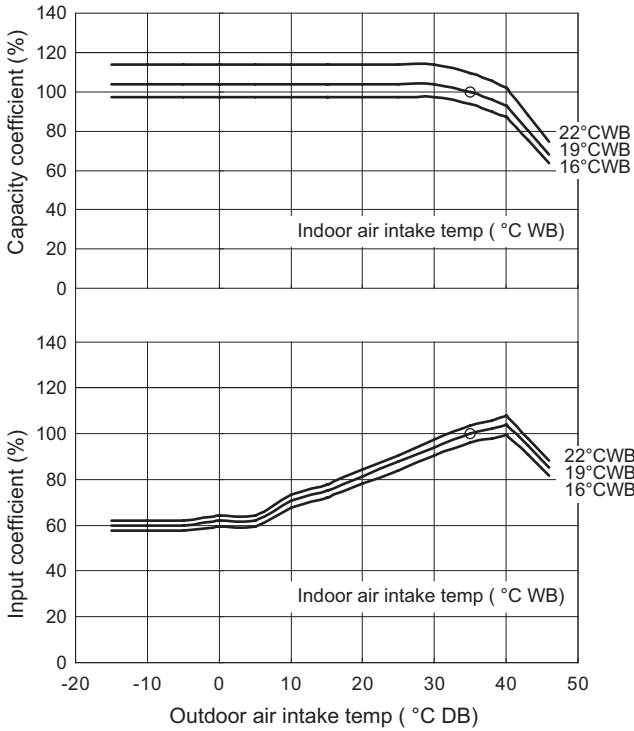
To calculate the heating capacity with consideration for frosting/defrosting operation, multiply the heating capacity found from the capacity graph by the correction coefficient from the table above.

1-5. Capacity Correction Graph According to Temperature Condition

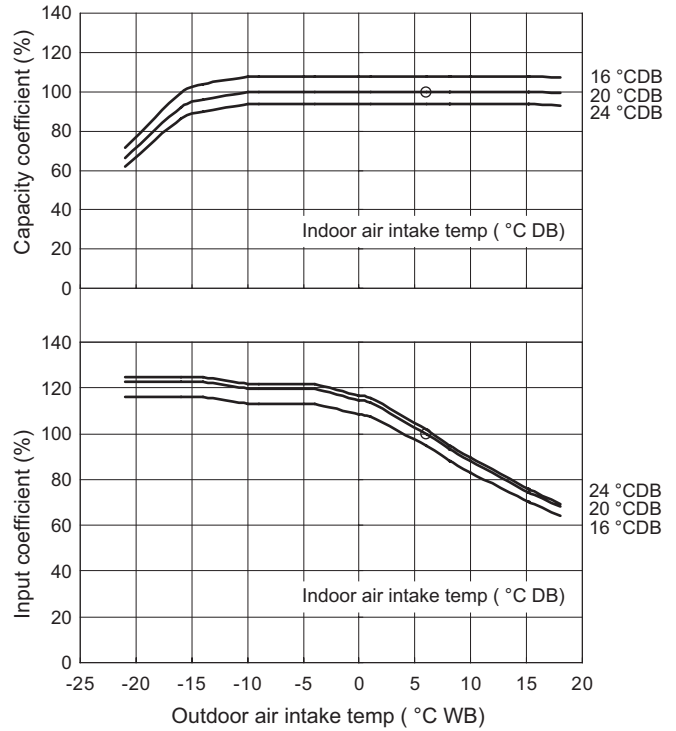
PE1

U-100PE1E5A (For 50 Hz) / U-100PE1E8A (For 50 Hz)

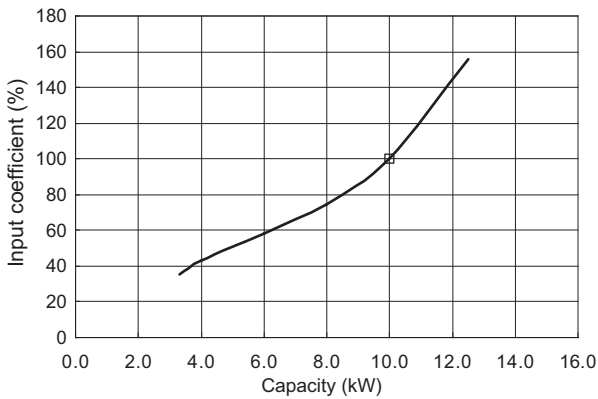
Cooling capacity ratio (maximum capacity)



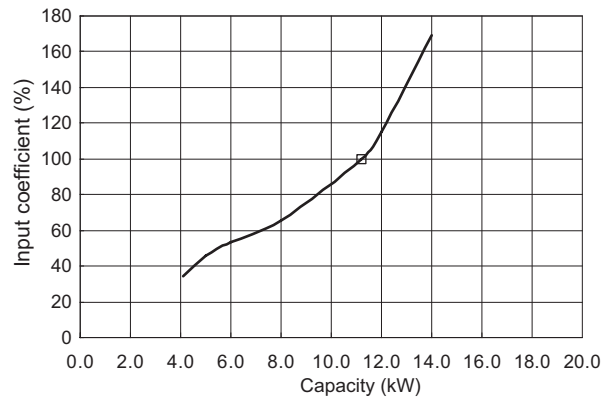
Heating capacity ratio (maximum capacity)



Cooling



Heating



Outdoor unit heating capacity correction coefficient during of frosting/defrosting

(RH approximately 85%)

| Outdoor intake air temperature °C WB | -20  | -15  | -10  | -9   | -8   | -7   | -6   | -5   | -4   | -3   | -2   | -1   | 0    | 1    | 2   | 3   | 4    | 5    | 6    | 7    | 8    | 9   | 10  |
|--------------------------------------|------|------|------|------|------|------|------|------|------|------|------|------|------|------|-----|-----|------|------|------|------|------|-----|-----|
| Correction coefficient               | 0.86 | 0.86 | 0.86 | 0.86 | 0.86 | 0.86 | 0.86 | 0.86 | 0.86 | 0.86 | 0.86 | 0.84 | 0.84 | 0.82 | 0.8 | 0.8 | 0.82 | 0.84 | 0.86 | 0.88 | 0.88 | 1.0 | 1.0 |

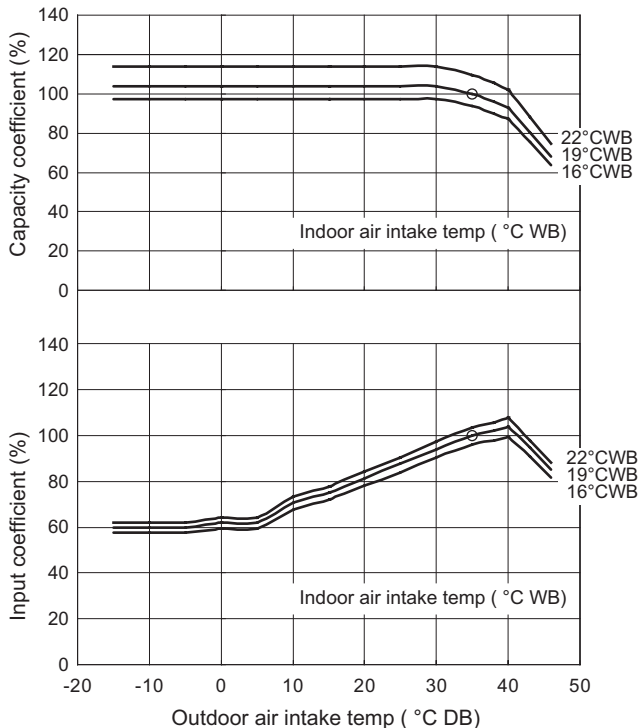
To calculate the heating capacity with consideration for frosting/defrosting operation, multiply the heating capacity found from the capacity graph by the correction coefficient from the table above.

1-5. Capacity Correction Graph According to Temperature Condition

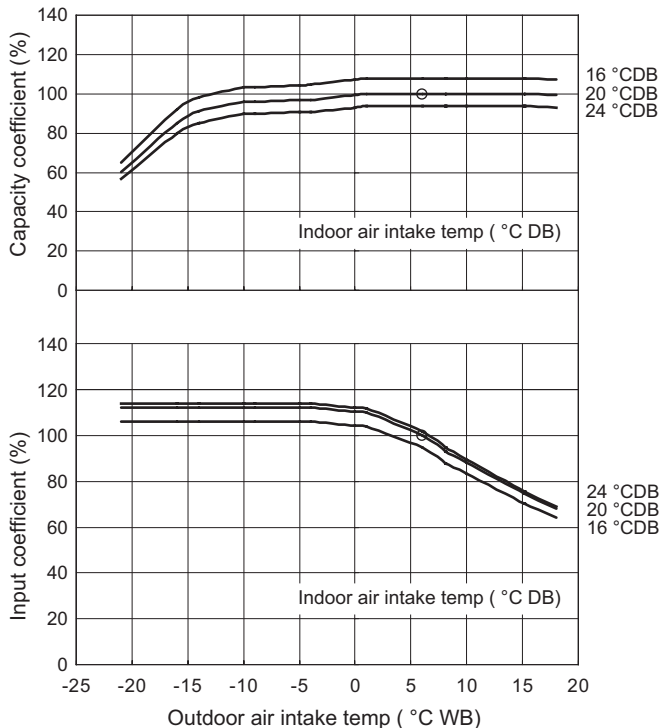
PE1

U-125PE1E5A (For 50 Hz) / U-125PE1E8A (For 50 Hz)

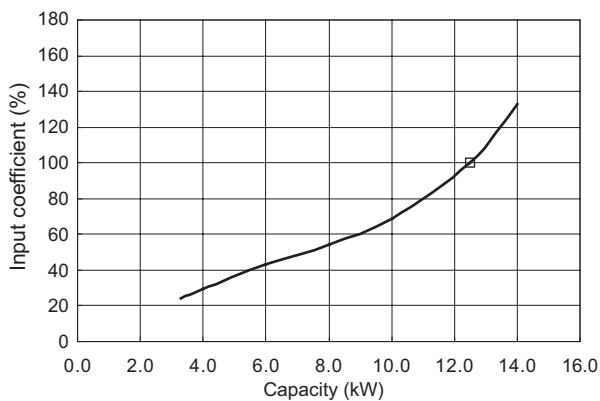
Cooling capacity ratio (maximum capacity)



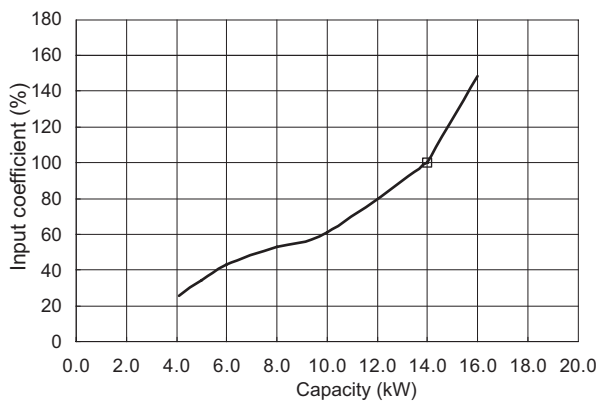
Heating capacity ratio (maximum capacity)



Cooling



Heating



Outdoor unit heating capacity correction coefficient during of frosting/defrosting (RH approximately 85%)

|                                      |      |      |      |      |      |      |      |      |      |      |      |      |      |      |     |     |      |      |      |      |      |     |     |
|--------------------------------------|------|------|------|------|------|------|------|------|------|------|------|------|------|------|-----|-----|------|------|------|------|------|-----|-----|
| Outdoor intake air temperature °C WB | -20  | -15  | -10  | -9   | -8   | -7   | -6   | -5   | -4   | -3   | -2   | -1   | 0    | 1    | 2   | 3   | 4    | 5    | 6    | 7    | 8    | 9   | 10  |
| Correction coefficient               | 0.86 | 0.86 | 0.86 | 0.86 | 0.86 | 0.86 | 0.86 | 0.86 | 0.86 | 0.86 | 0.86 | 0.84 | 0.84 | 0.82 | 0.8 | 0.8 | 0.82 | 0.84 | 0.86 | 0.88 | 0.88 | 1.0 | 1.0 |

To calculate the heating capacity with consideration for frosting/defrosting operation, multiply the heating capacity found from the capacity graph by the correction coefficient from the table above.

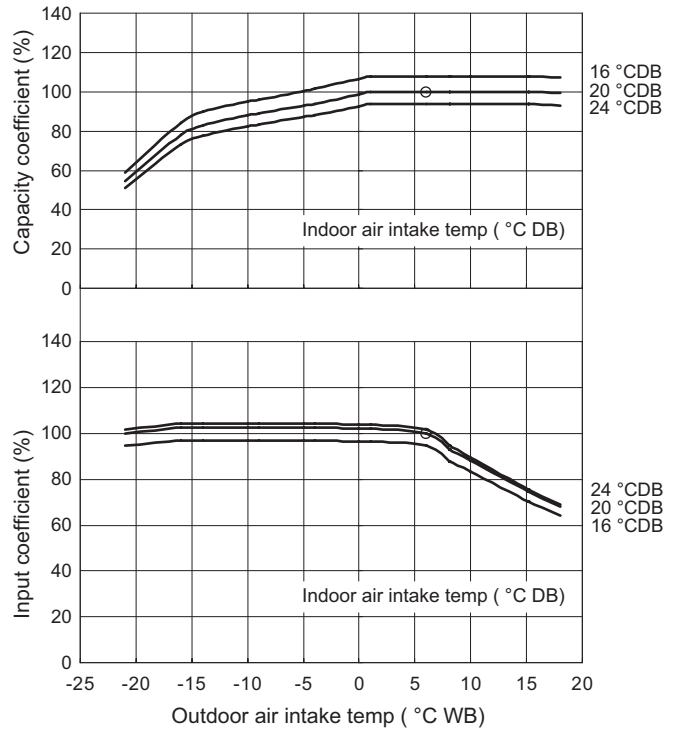
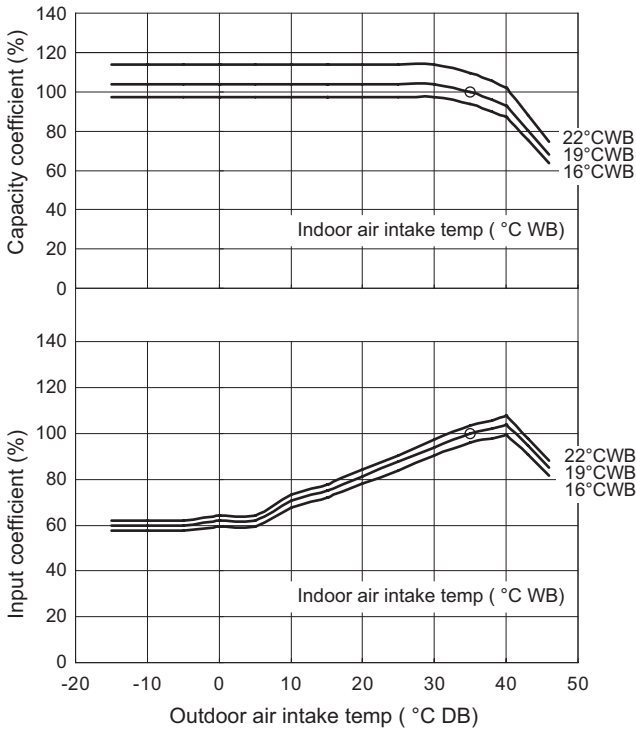
1-5. Capacity Correction Graph According to Temperature Condition

PE1

U-140PE1E5A (For 50 Hz) / U-140PE1E8A (For 50 Hz)

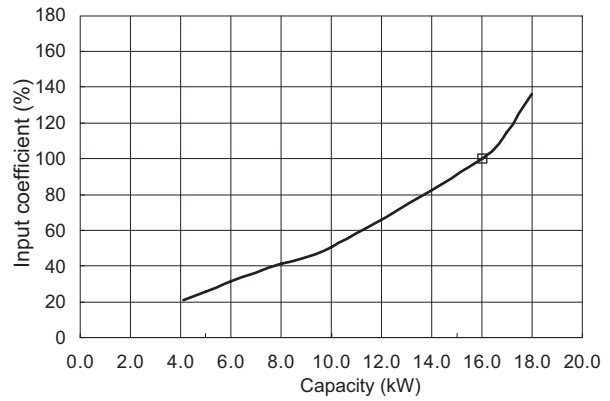
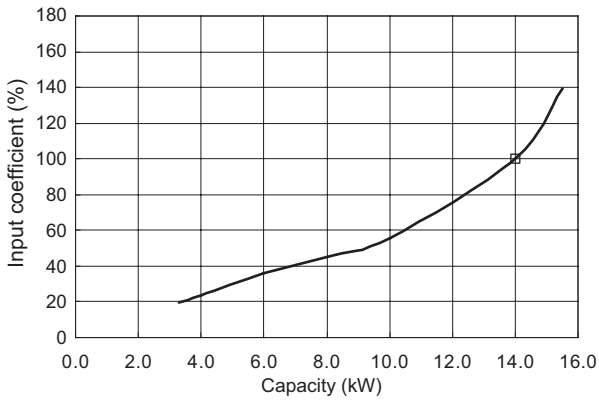
Cooling capacity ratio (maximum capacity)

Heating capacity ratio (maximum capacity)



Cooling

Heating



Outdoor unit heating capacity correction coefficient during of frosting/defrosting

(RH approximately 85%)

| Outdoor intake air temperature °C WB | -20  | -15  | -10  | -9   | -8   | -7   | -6   | -5   | -4   | -3   | -2   | -1   | 0    | 1    | 2   | 3   | 4    | 5    | 6    | 7    | 8    | 9   | 10  |
|--------------------------------------|------|------|------|------|------|------|------|------|------|------|------|------|------|------|-----|-----|------|------|------|------|------|-----|-----|
| Correction coefficient               | 0.86 | 0.86 | 0.86 | 0.86 | 0.86 | 0.86 | 0.86 | 0.86 | 0.86 | 0.86 | 0.86 | 0.84 | 0.84 | 0.82 | 0.8 | 0.8 | 0.82 | 0.84 | 0.86 | 0.88 | 0.88 | 1.0 | 1.0 |

To calculate the heating capacity with consideration for frosting/defrosting operation, multiply the heating capacity found from the capacity graph by the correction coefficient from the table above.

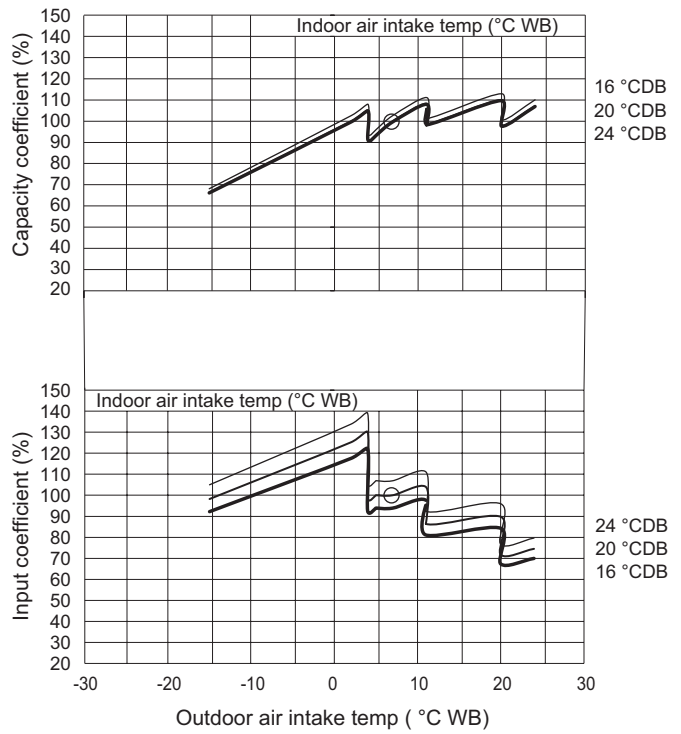
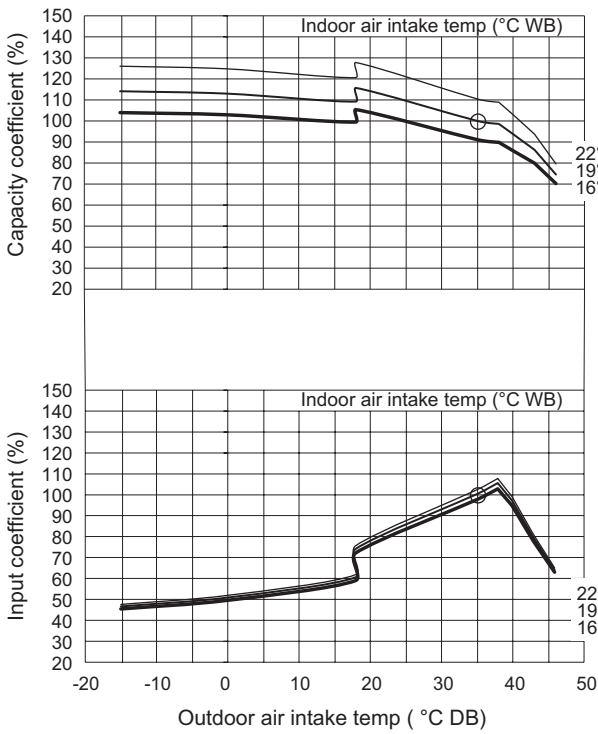
1-5. Capacity Correction Graph According to Temperature Condition

PEY2

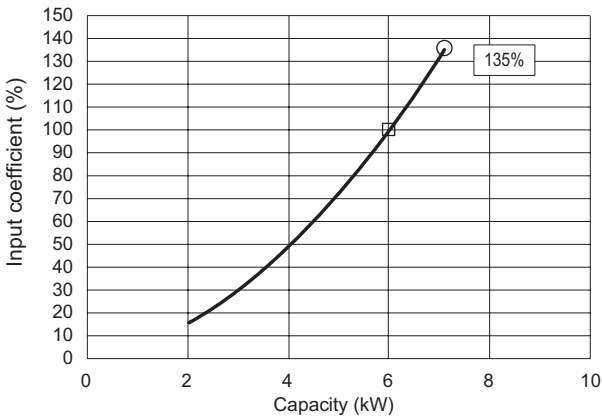
U-60PEY2E5 (For 50 Hz)

Cooling capacity ratio (maximum capacity)

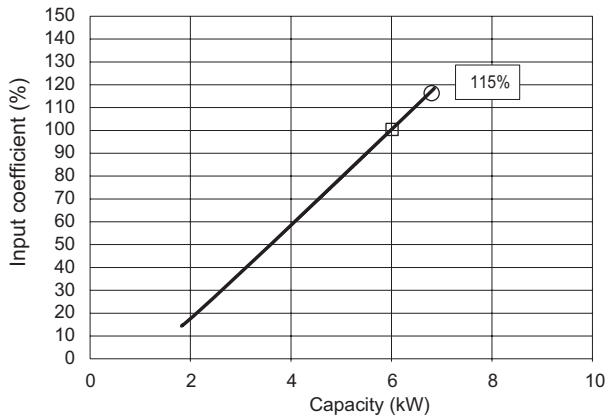
Heating capacity ratio (maximum capacity)



Cooling



Heating



Outdoor unit heating capacity correction coefficient during of frosting/defrosting (RH approximately 85%)

|                                      |       |       |       |       |       |       |       |       |       |       |       |       |       |       |       |       |       |       |       |
|--------------------------------------|-------|-------|-------|-------|-------|-------|-------|-------|-------|-------|-------|-------|-------|-------|-------|-------|-------|-------|-------|
| Outdoor intake air temperature °C WB | -20.0 | -19.0 | -18.0 | -17.0 | -16.0 | -15.0 | -14.0 | -13.0 | -12.0 | -11.0 | -10.0 | -9.0  | -8.0  | -7.0  | -6.0  | -5.0  | -4.0  | -3.0  | -2.0  |
| Correction coefficient               | 0.966 | 0.966 | 0.962 | 0.958 | 0.954 | 0.946 | 0.945 | 0.940 | 0.935 | 0.930 | 0.925 | 0.920 | 0.915 | 0.915 | 0.905 | 0.900 | 0.895 | 0.890 | 0.874 |

|                                      |       |       |       |       |       |       |       |       |       |
|--------------------------------------|-------|-------|-------|-------|-------|-------|-------|-------|-------|
| Outdoor intake air temperature °C WB | -1.0  | 0.0   | 1.0   | 2.0   | 3.0   | 4.0   | 5.0   | 6.0   | 7.0   |
| Correction coefficient               | 0.888 | 0.902 | 0.916 | 0.930 | 0.944 | 0.958 | 0.972 | 0.986 | 1.000 |

To calculate the heating capacity with consideration for frosting/defrosting operation, multiply the heating capacity found from the capacity graph by the correction coefficient from the table above.

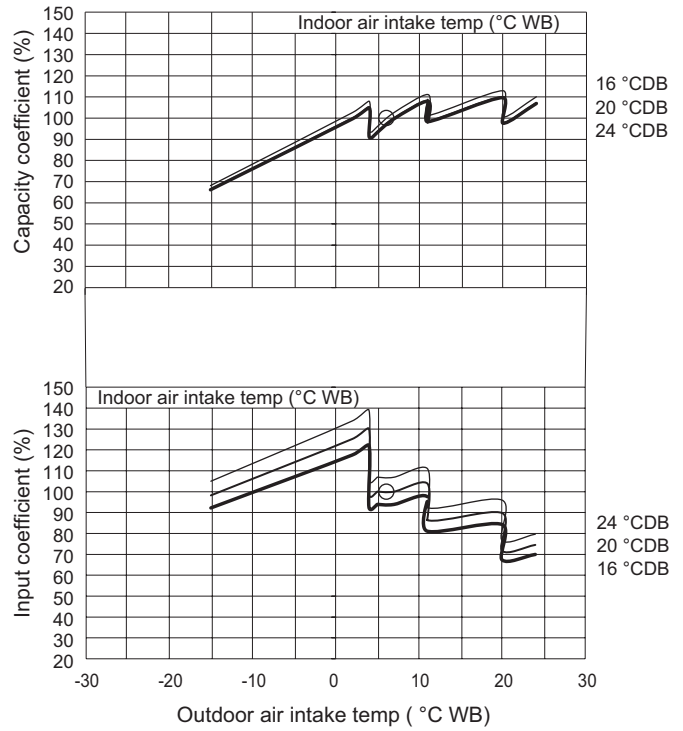
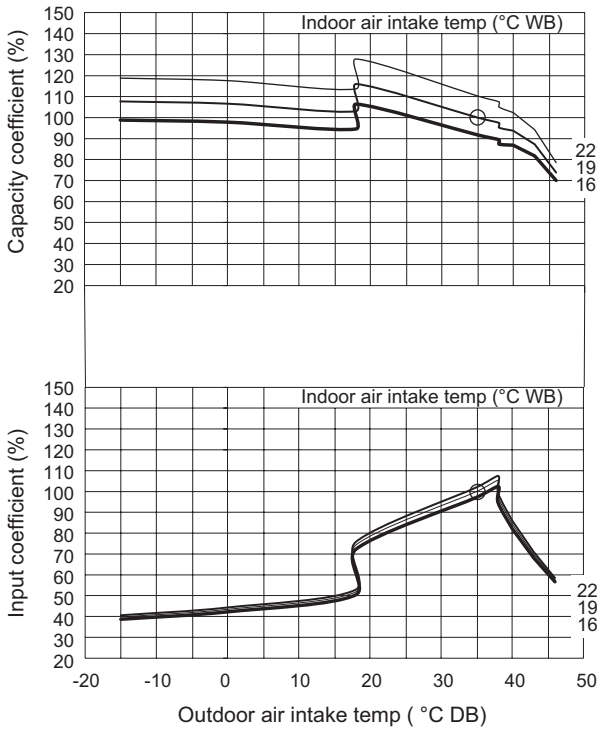
1-5. Capacity Correction Graph According to Temperature Condition

PEY2

U-71PEY2E5 (For 50 Hz)

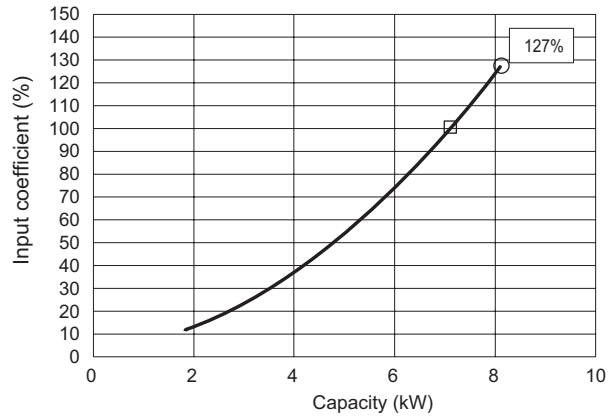
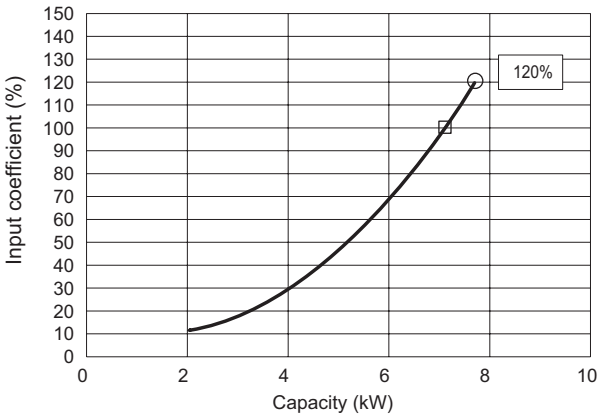
Cooling capacity ratio (maximum capacity)

Heating capacity ratio (maximum capacity)



Cooling

Heating



Outdoor unit heating capacity correction coefficient during of frosting/defrosting (RH approximately 85%)

|                                      |       |       |       |       |       |       |       |       |       |       |       |       |       |       |       |       |       |       |       |
|--------------------------------------|-------|-------|-------|-------|-------|-------|-------|-------|-------|-------|-------|-------|-------|-------|-------|-------|-------|-------|-------|
| Outdoor intake air temperature °C WB | -20.0 | -19.0 | -18.0 | -17.0 | -16.0 | -15.0 | -14.0 | -13.0 | -12.0 | -11.0 | -10.0 | -9.0  | -8.0  | -7.0  | -6.0  | -5.0  | -4.0  | -3.0  | -2.0  |
| Correction coefficient               | 0.966 | 0.966 | 0.962 | 0.958 | 0.954 | 0.946 | 0.945 | 0.940 | 0.935 | 0.930 | 0.925 | 0.920 | 0.915 | 0.915 | 0.905 | 0.900 | 0.895 | 0.890 | 0.874 |

|                                      |       |       |       |       |       |       |       |       |       |
|--------------------------------------|-------|-------|-------|-------|-------|-------|-------|-------|-------|
| Outdoor intake air temperature °C WB | -1.0  | 0.0   | 1.0   | 2.0   | 3.0   | 4.0   | 5.0   | 6.0   | 7.0   |
| Correction coefficient               | 0.888 | 0.902 | 0.916 | 0.930 | 0.944 | 0.958 | 0.972 | 0.986 | 1.000 |

To calculate the heating capacity with consideration for frosting/defrosting operation, multiply the heating capacity found from the capacity graph by the correction coefficient from the table above.

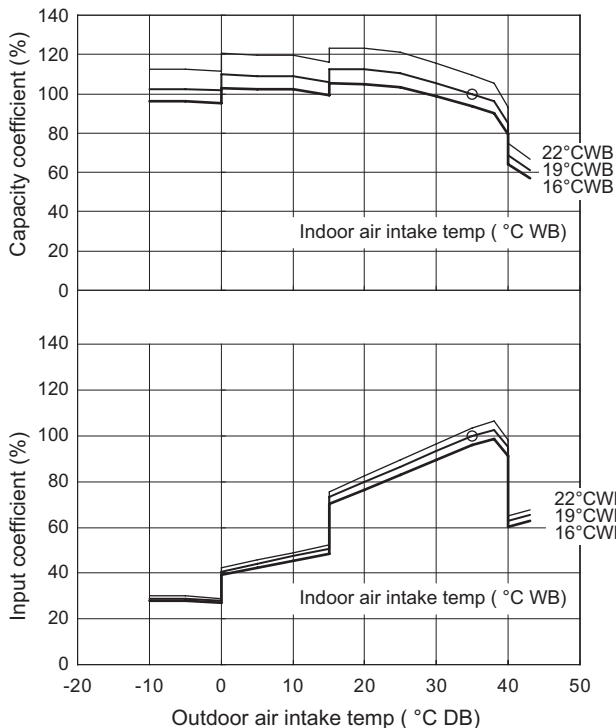


1-5. Capacity Correction Graph According to Temperature Condition

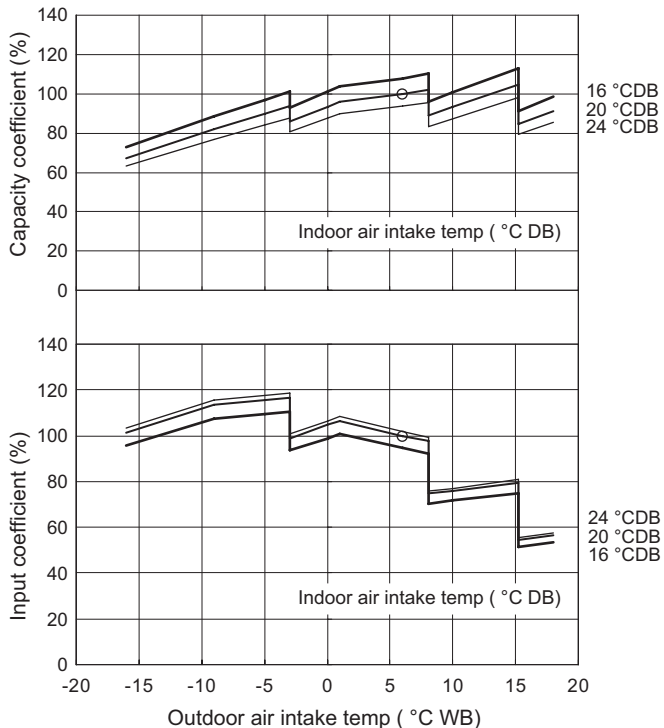
PEY1

U-100PEY1E5 (For 50 Hz) / U-100PEY1E8 (For 50 Hz)

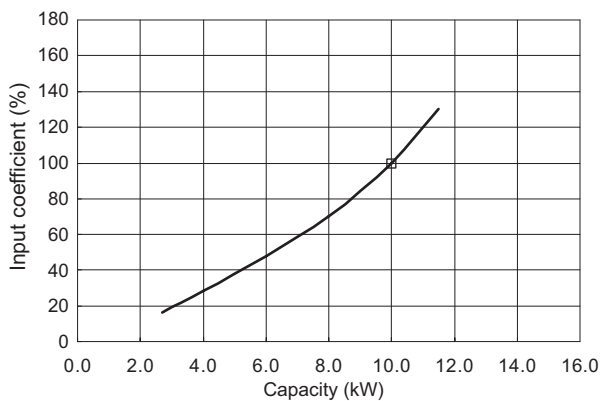
Cooling capacity ratio (maximum capacity)



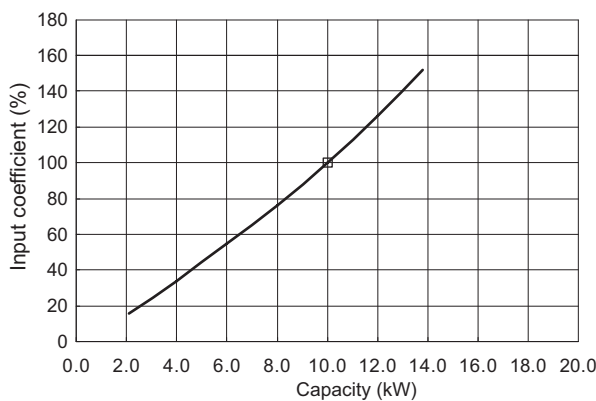
Heating capacity ratio (maximum capacity)



Cooling



Heating



Outdoor unit heating capacity correction coefficient during of frosting/defrosting

(RH approximately 85%)

|                                      |      |      |      |      |      |      |      |      |      |      |      |      |      |      |     |     |      |      |      |      |      |     |     |
|--------------------------------------|------|------|------|------|------|------|------|------|------|------|------|------|------|------|-----|-----|------|------|------|------|------|-----|-----|
| Outdoor intake air temperature °C WB | -20  | -15  | -10  | -9   | -8   | -7   | -6   | -5   | -4   | -3   | -2   | -1   | 0    | 1    | 2   | 3   | 4    | 5    | 6    | 7    | 8    | 9   | 10  |
| Correction coefficient               | 0.86 | 0.86 | 0.86 | 0.86 | 0.86 | 0.86 | 0.86 | 0.86 | 0.86 | 0.86 | 0.86 | 0.84 | 0.84 | 0.82 | 0.8 | 0.8 | 0.82 | 0.84 | 0.86 | 0.88 | 0.88 | 1.0 | 1.0 |

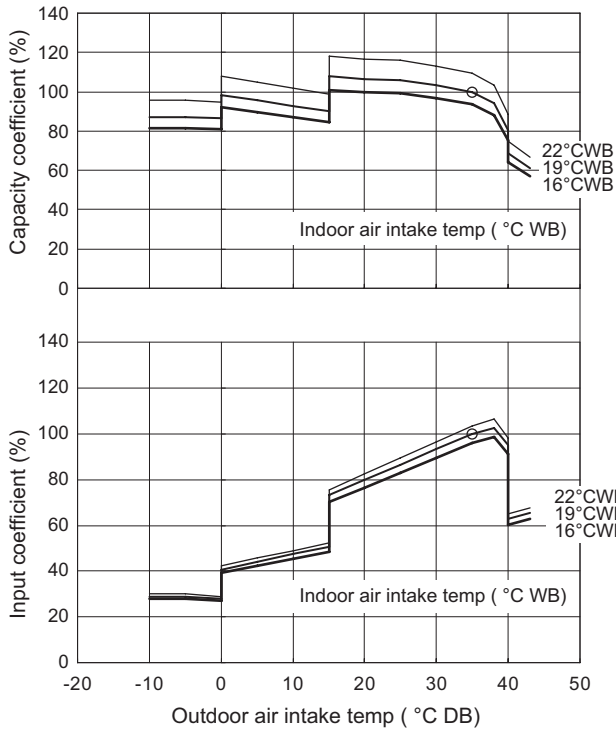
To calculate the heating capacity with consideration for frosting/defrosting operation, multiply the heating capacity found from the capacity graph by the correction coefficient from the table above.

1-5. Capacity Correction Graph According to Temperature Condition

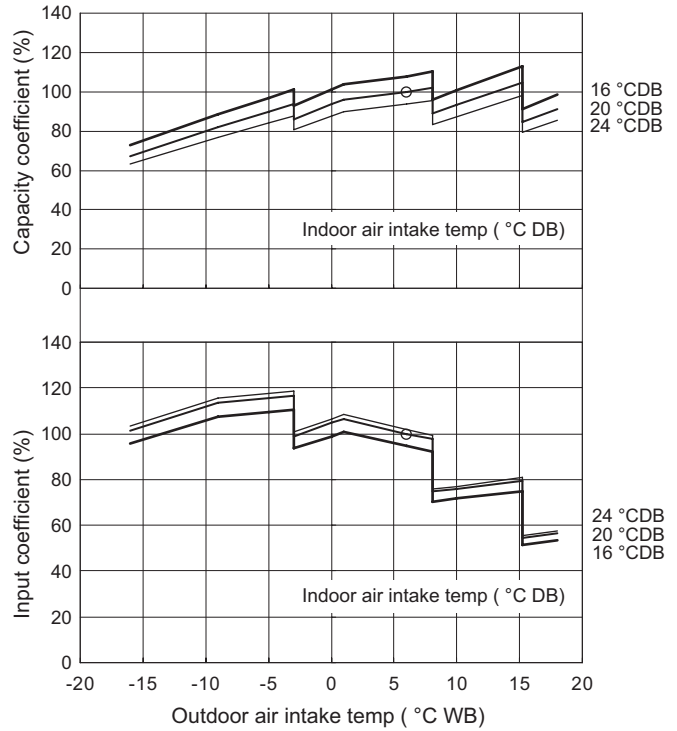
PEY1

U-125PEY1E5 (For 50 Hz) / U-125PEY1E8 (For 50 Hz)

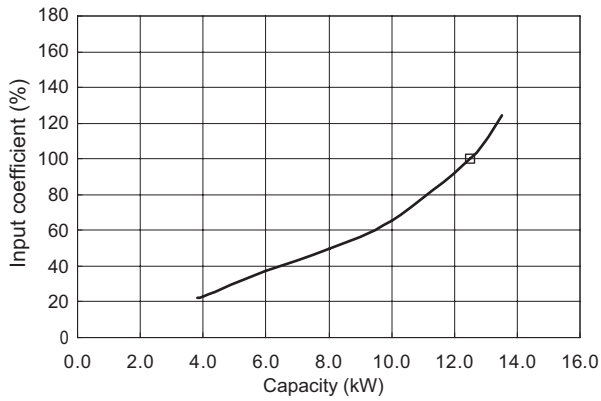
Cooling capacity ratio (maximum capacity)



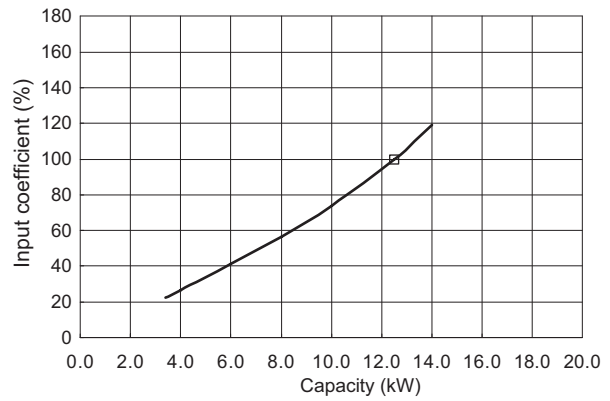
Heating capacity ratio (maximum capacity)



Cooling



Heating



Outdoor unit heating capacity correction coefficient during of frosting/defrosting

(RH approximately 85%)

| Outdoor intake air temperature °C WB | -20  | -15  | -10  | -9   | -8   | -7   | -6   | -5   | -4   | -3   | -2   | -1   | 0    | 1    | 2   | 3   | 4    | 5    | 6    | 7    | 8    | 9   | 10  |
|--------------------------------------|------|------|------|------|------|------|------|------|------|------|------|------|------|------|-----|-----|------|------|------|------|------|-----|-----|
| Correction coefficient               | 0.86 | 0.86 | 0.86 | 0.86 | 0.86 | 0.86 | 0.86 | 0.86 | 0.86 | 0.86 | 0.86 | 0.84 | 0.84 | 0.82 | 0.8 | 0.8 | 0.82 | 0.84 | 0.86 | 0.88 | 0.88 | 1.0 | 1.0 |

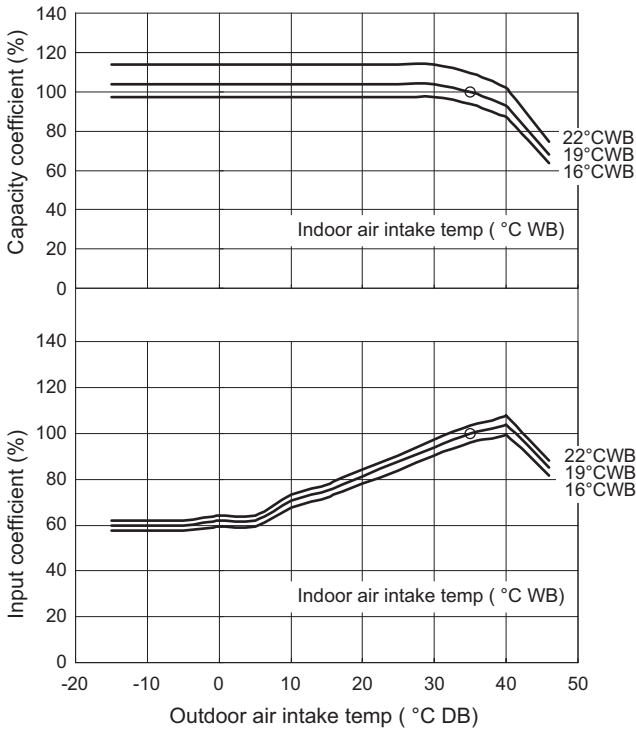
To calculate the heating capacity with consideration for frosting/defrosting operation, multiply the heating capacity found from the capacity graph by the correction coefficient from the table above.

1-5. Capacity Correction Graph According to Temperature Condition

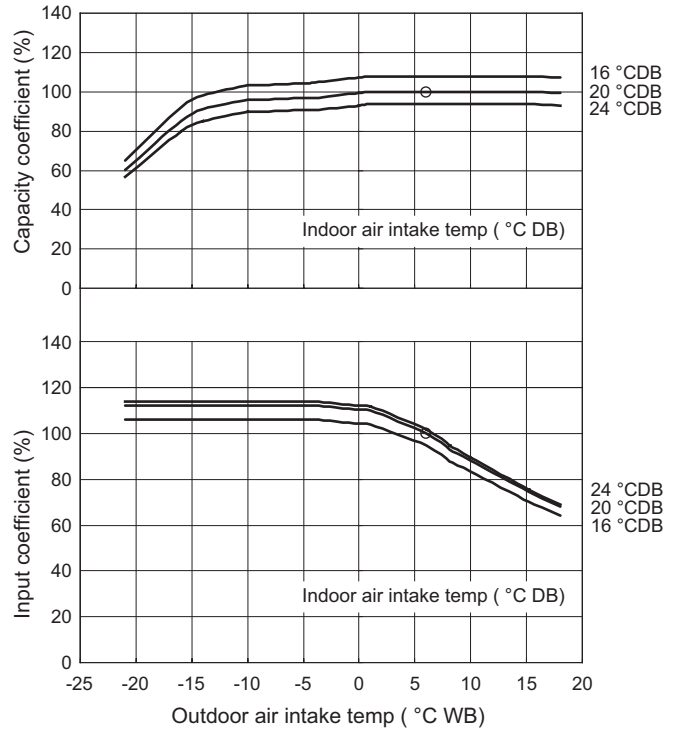
PEY1

U-140PEY1E8 (For 50 Hz)

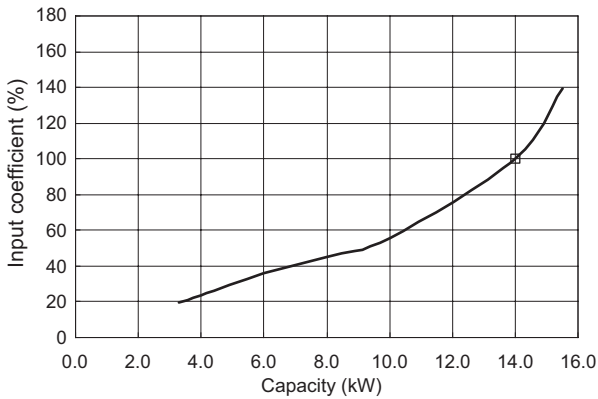
Cooling capacity ratio (maximum capacity)



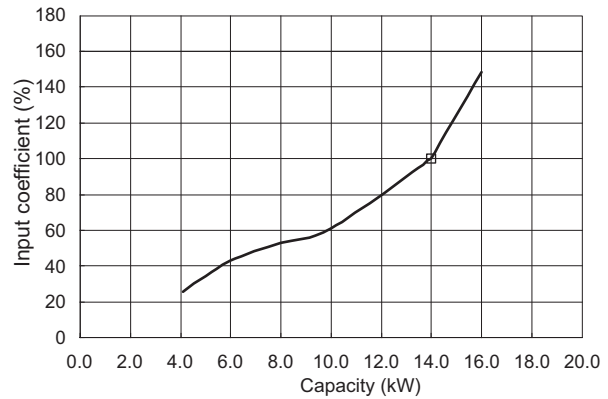
Heating capacity ratio (maximum capacity)



Cooling



Heating



Outdoor unit heating capacity correction coefficient during of frosting/defrosting

(RH approximately 85%)

| Outdoor intake air temperature °C WB | -20  | -15  | -10  | -9   | -8   | -7   | -6   | -5   | -4   | -3   | -2   | -1   | 0    | 1    | 2   | 3   | 4    | 5    | 6    | 7    | 8    | 9   | 10  |
|--------------------------------------|------|------|------|------|------|------|------|------|------|------|------|------|------|------|-----|-----|------|------|------|------|------|-----|-----|
| Correction coefficient               | 0.86 | 0.86 | 0.86 | 0.86 | 0.86 | 0.86 | 0.86 | 0.86 | 0.86 | 0.86 | 0.86 | 0.84 | 0.84 | 0.82 | 0.8 | 0.8 | 0.82 | 0.84 | 0.86 | 0.88 | 0.88 | 1.0 | 1.0 |

To calculate the heating capacity with consideration for frosting/defrosting operation, multiply the heating capacity found from the capacity graph by the correction coefficient from the table above.

1-6. Noise Criterion Curves

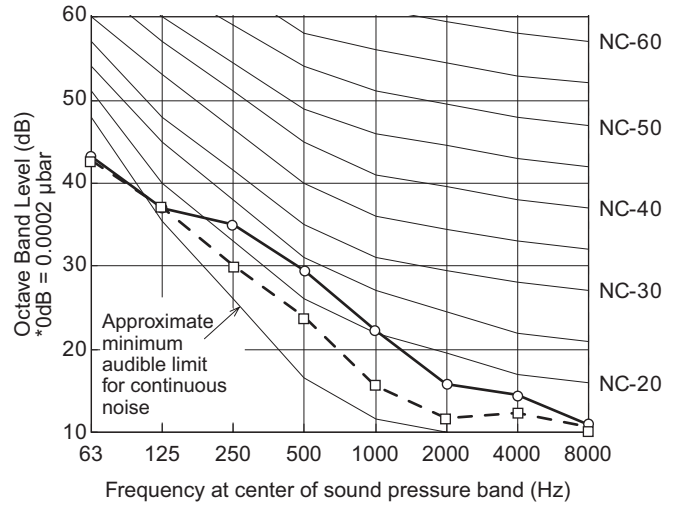
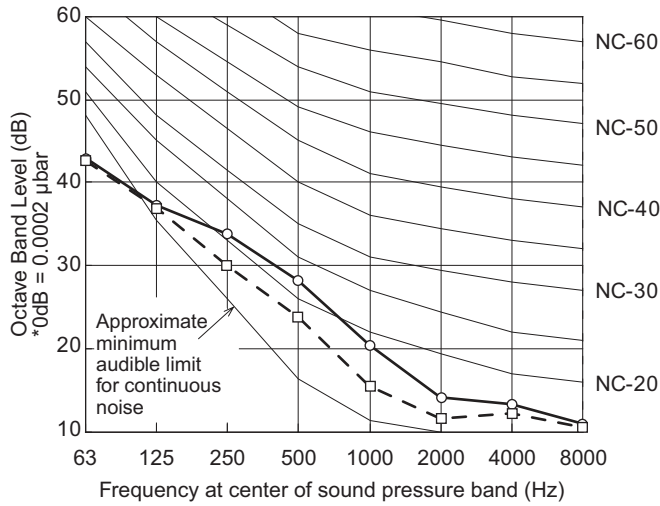
(A) Indoor Units:

4-Way Cassette Type

—○— High  
 - -□- - Low

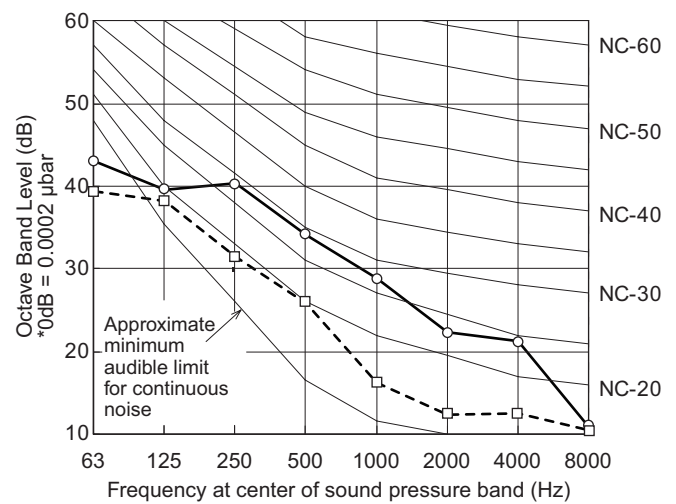
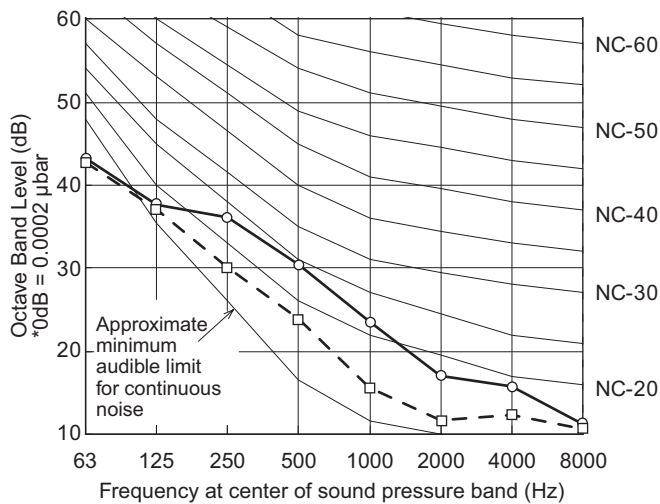
|             |                                 |
|-------------|---------------------------------|
| MODEL       | : S-36PU2E5A                    |
| SOUND LEVEL | : High 30 dB(A)<br>Low 27 dB(A) |
| CONDITION   | : Under the unit 1.5m           |
| SOURCE      | : 230-240V, 1 phase, 50Hz       |

|             |                                 |
|-------------|---------------------------------|
| MODEL       | : S-45PU2E5A                    |
| SOUND LEVEL | : High 31 dB(A)<br>Low 27 dB(A) |
| CONDITION   | : Under the unit 1.5m           |
| SOURCE      | : 230-240V, 1 phase, 50Hz       |



|             |                                 |
|-------------|---------------------------------|
| MODEL       | : S-50PU2E5A                    |
| SOUND LEVEL | : High 32 dB(A)<br>Low 27 dB(A) |
| CONDITION   | : Under the unit 1.5m           |
| SOURCE      | : 230-240V, 1 phase, 50Hz       |

|             |                                 |
|-------------|---------------------------------|
| MODEL       | : S-60PU2E5A                    |
| SOUND LEVEL | : High 36 dB(A)<br>Low 28 dB(A) |
| CONDITION   | : Under the unit 1.5m           |
| SOURCE      | : 230-240V, 1 phase, 50Hz       |



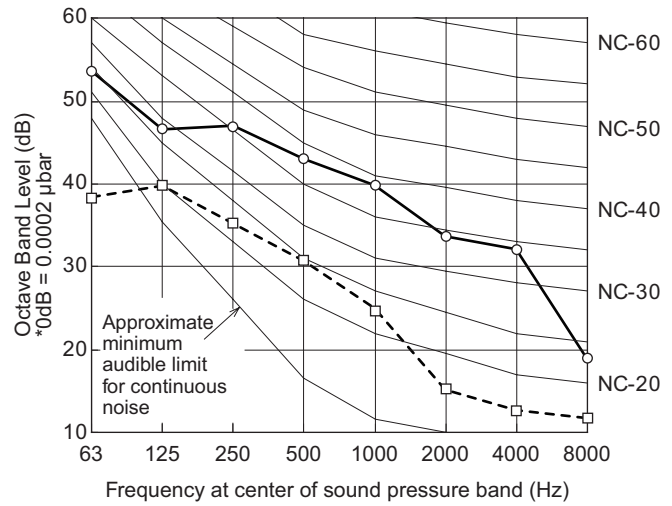
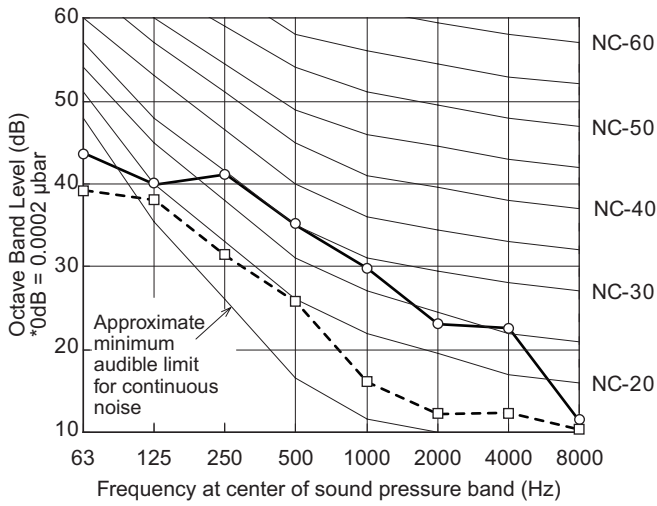
1-6. Noise Criterion Curves

(A) Indoor Units:

4-Way Cassette Type

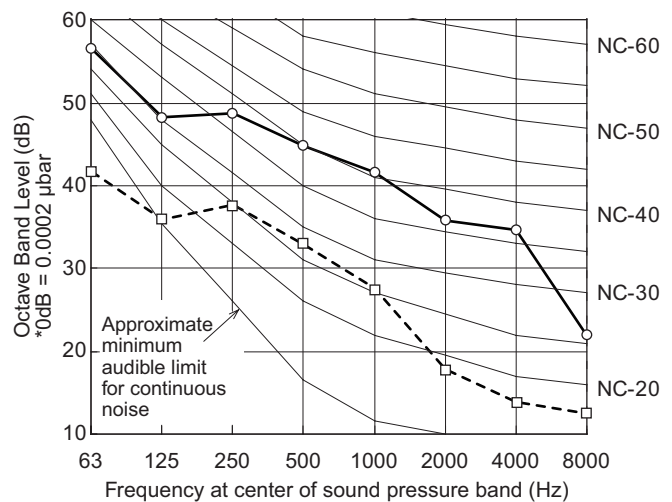
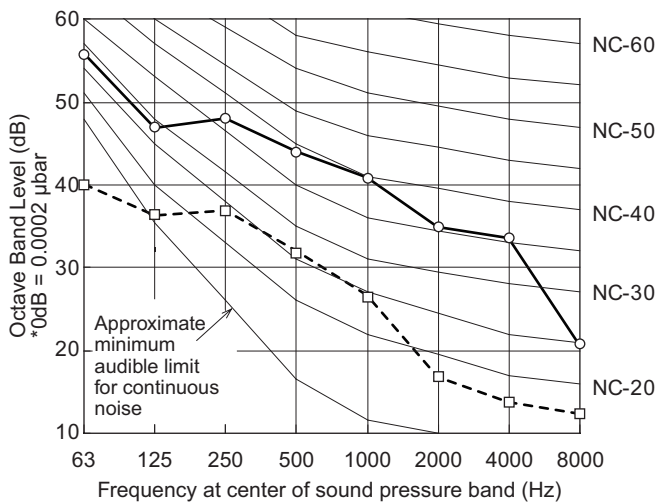
|             |                               |
|-------------|-------------------------------|
| MODEL       | : S-71PU2E5A                  |
| SOUND LEVEL | High 37 dB(A)<br>Low 28 dB(A) |
| CONDITION   | : Under the unit 1.5m         |
| SOURCE      | : 230-240V, 1 phase, 50Hz     |

|             |                               |
|-------------|-------------------------------|
| MODEL       | : S-100PU2E5A                 |
| SOUND LEVEL | High 45 dB(A)<br>Low 32 dB(A) |
| CONDITION   | : Under the unit 1.5m         |
| SOURCE      | : 230-240V, 1 phase, 50Hz     |



|             |                               |
|-------------|-------------------------------|
| MODEL       | : S-125PU2E5A                 |
| SOUND LEVEL | High 46 dB(A)<br>Low 33 dB(A) |
| CONDITION   | : Under the unit 1.5m         |
| SOURCE      | : 230-240V, 1 phase, 50Hz     |

|             |                               |
|-------------|-------------------------------|
| MODEL       | : S-140PU2E5A                 |
| SOUND LEVEL | High 47 dB(A)<br>Low 34 dB(A) |
| CONDITION   | : Under the unit 1.5m         |
| SOURCE      | : 230-240V, 1 phase, 50Hz     |



REMARKS:

- Value obtained in the actual place where the unit is installed may be slightly higher than the values shown in this graph because of the conditions of operation, the structure of the building, the background noise and other factors.
- The test results were obtained from an anechoic room.

NOTE

To evaluate "Noise level" the maximum number of the measured OCTAVE BAND SOUND PRESSURE LEVEL is used. Read the number on each BAND CENTER FREQUENCIES (horizontal axis) ranging from 63 Hz to 8000 Hz and select the maximum value (vertical axis) among them.

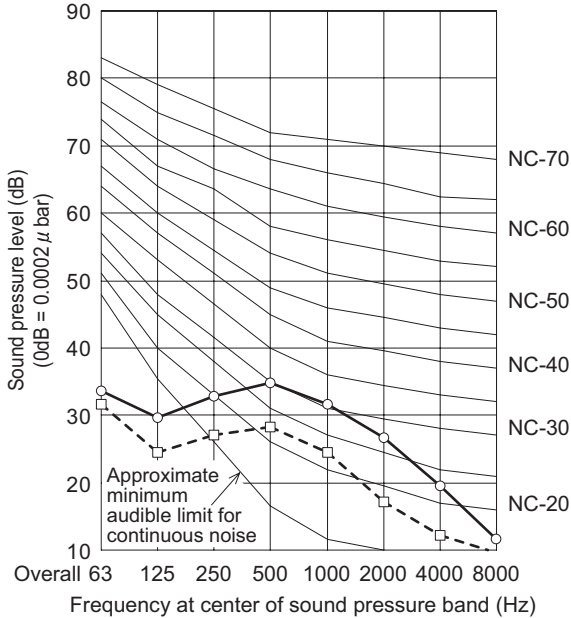
1-6. Noise Criterion Curves

(A) Indoor Units:

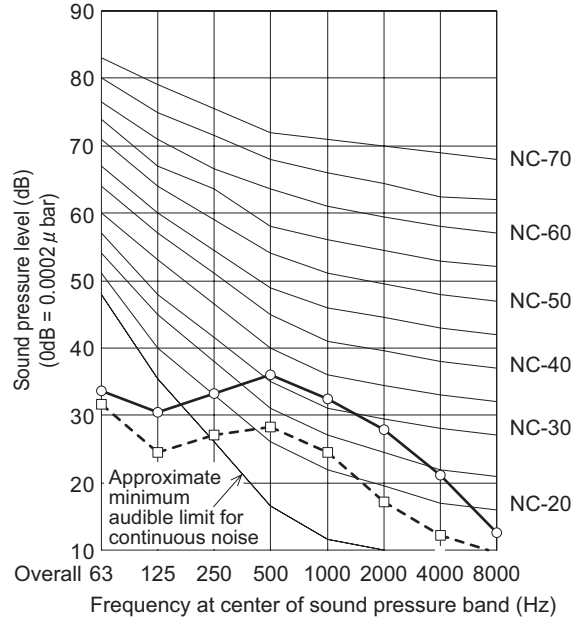
Ceiling Type

—○— High  
-□- Low

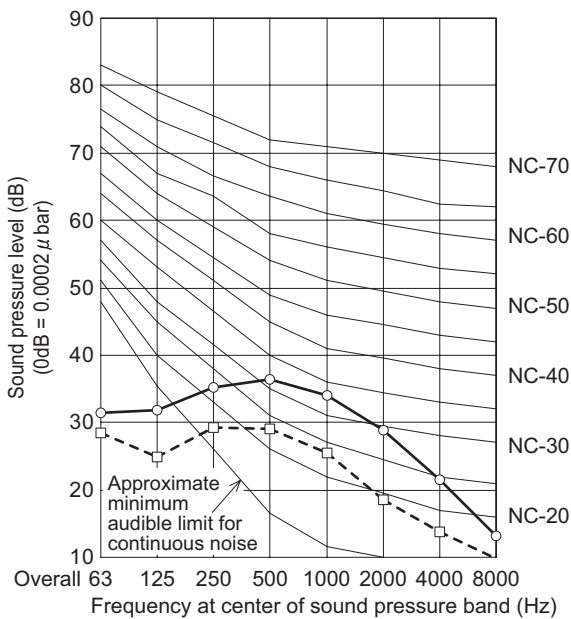
|                    |   |
|--------------------|---|
| MODEL              | : S-36PT2E5A                                |
| SOUND LEVEL : High | 36 dB(A)                                    |
| Low                | 29 dB(A)                                    |
| CONDITION          | : 1 m from front of outlet at height of 1 m |
| SOURCE             | : 220-230-240V, 1 phase, 50Hz               |



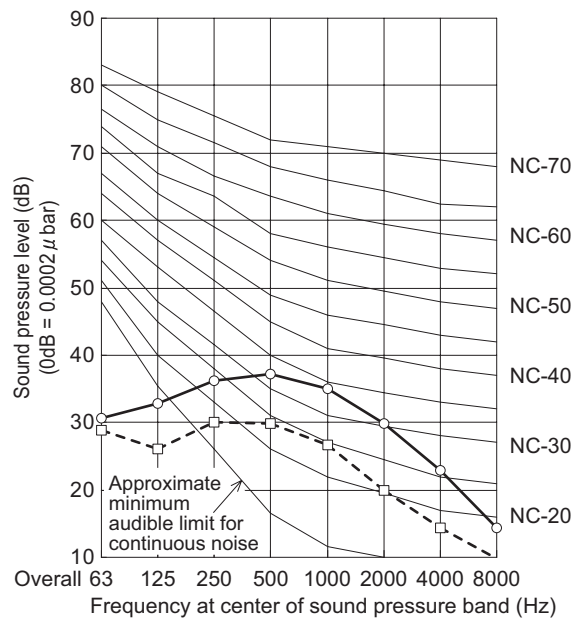
|                    |   |
|--------------------|---|
| MODEL              | : S-45PT2E5A<br>S-50PT2E5A                  |
| SOUND LEVEL : High | 37 dB(A)                                    |
| Low                | 29 dB(A)                                    |
| CONDITION          | : 1 m from front of outlet at height of 1 m |
| SOURCE             | : 220-230-240V, 1 phase, 50Hz               |



|                    |   |
|--------------------|---|
| MODEL              | : S-60PT2E5A                                |
| SOUND LEVEL : High | 38 dB(A)                                    |
| Low                | 30 dB(A)                                    |
| CONDITION          | : 1 m from front of outlet at height of 1 m |
| SOURCE             | : 220-230-240V, 1 phase, 50Hz               |



|                    |   |
|--------------------|---|
| MODEL              | : S-71PT2E5A                                |
| SOUND LEVEL : High | 39 dB(A)                                    |
| Low                | 31 dB(A)                                    |
| CONDITION          | : 1 m from front of outlet at height of 1 m |
| SOURCE             | : 220-230-240V, 1 phase, 50Hz               |



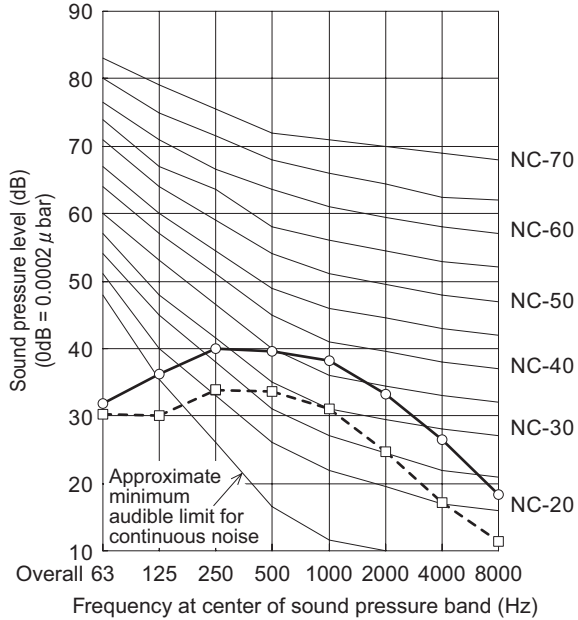
1-6. Noise Criterion Curves

(A) Indoor Units:

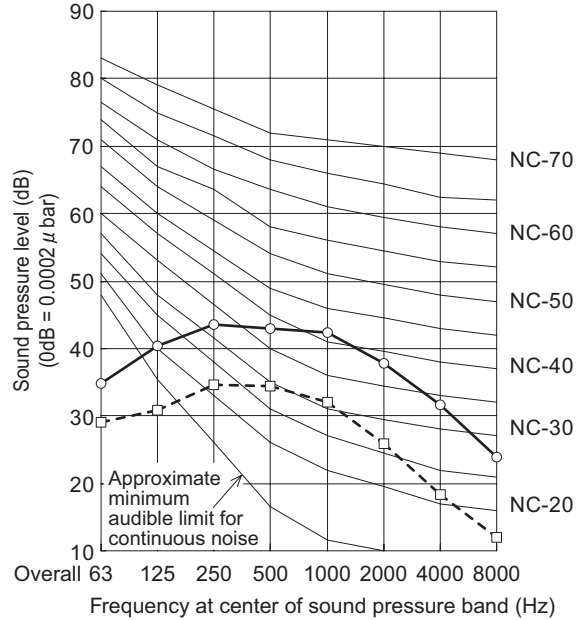
Ceiling Type

—○— High  
-□- Low

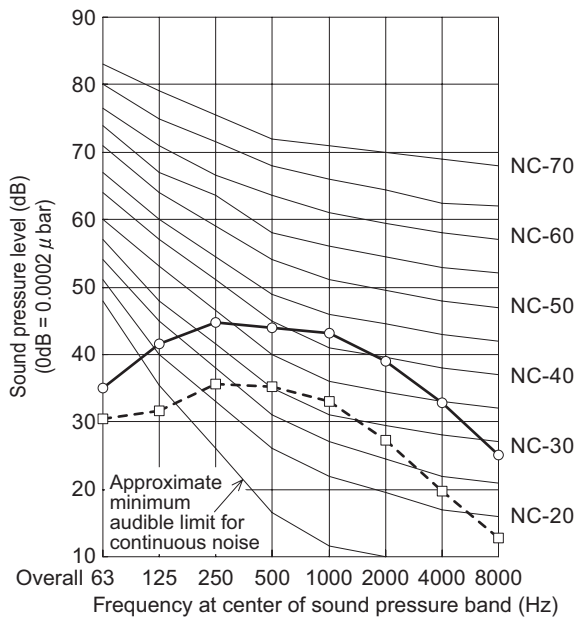
|                    |   |
|--------------------|---|
| MODEL              | : S-100PT2E5A                               |
| SOUND LEVEL : High | 42 dB(A)                                    |
| Low                | 35 dB(A)                                    |
| CONDITION          | : 1 m from front of outlet at height of 1 m |
| SOURCE             | : 220-230-240V, 1 phase, 50Hz               |



|                    |   |
|--------------------|---|
| MODEL              | : S-125PT2E5A                               |
| SOUND LEVEL : High | 46 dB(A)                                    |
| Low                | 36 dB(A)                                    |
| CONDITION          | : 1 m from front of outlet at height of 1 m |
| SOURCE             | : 220-230-240V, 1 phase, 50Hz               |



|                    |   |
|--------------------|---|
| MODEL              | : S-140PT2E5A                               |
| SOUND LEVEL : High | 47 dB(A)                                    |
| Low                | 37 dB(A)                                    |
| CONDITION          | : 1 m from front of outlet at height of 1 m |
| SOURCE             | : 220-230-240V, 1 phase, 50Hz               |



1-6. Noise Criterion Curves

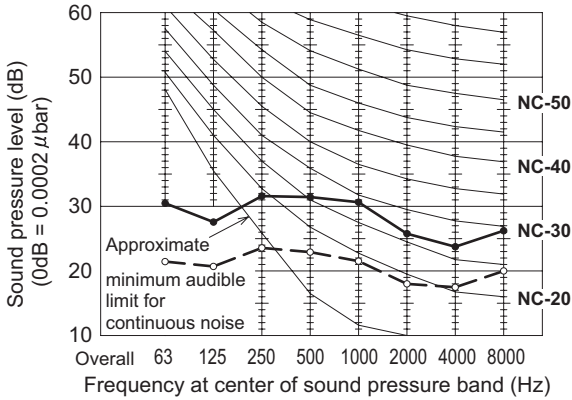
(A) Indoor Units:

Wall Mounted Type

—●— Strong  
 -○- Weak

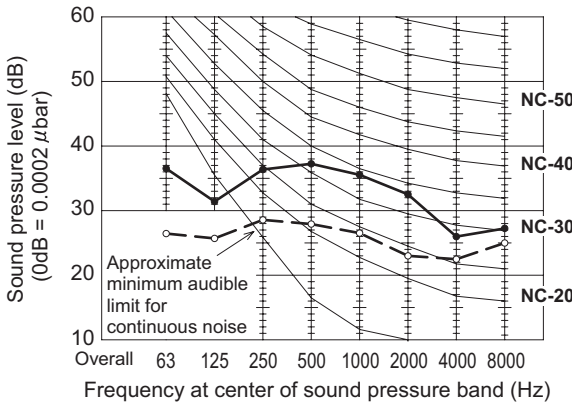
|             |                   |
|-------------|-------------------|
| MODEL       | : S-36PK1E5A      |
| SOUND LEVEL | : STRONG 35 dB(A) |
|             | High 31 dB(A)     |
|             | Low 27 dB(A)      |

CONDITION : 1m in front of air discharge and then 1m below



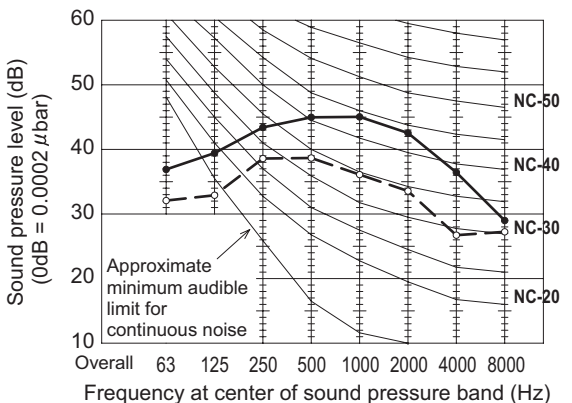
|             |                   |
|-------------|-------------------|
| MODEL       | : S-50PK1E5A      |
| SOUND LEVEL | : STRONG 40 dB(A) |
|             | High 36 dB(A)     |
|             | Low 32 dB(A)      |

CONDITION : 1m in front of air discharge and then 1m below



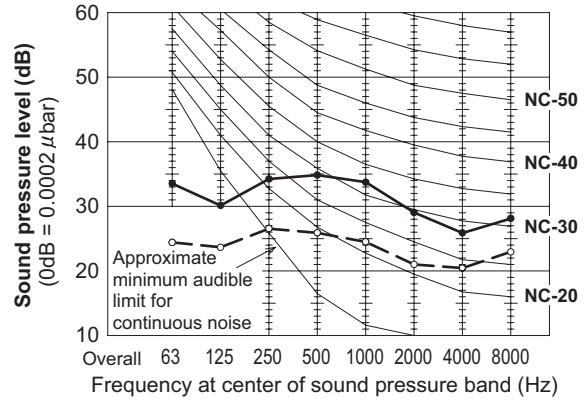
|             |                   |
|-------------|-------------------|
| MODEL       | : S-100PK1E5A     |
| SOUND LEVEL | : STRONG 49 dB(A) |
|             | High 45 dB(A)     |
|             | Low 41 dB(A)      |

CONDITION : 1m in front of air discharge and then 1m below



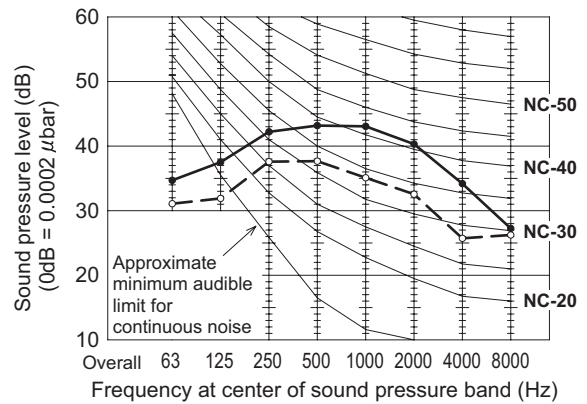
|             |                   |
|-------------|-------------------|
| MODEL       | : S-45PK1E5A      |
| SOUND LEVEL | : STRONG 38 dB(A) |
|             | High 34 dB(A)     |
|             | Low 30 dB(A)      |

CONDITION : 1m in front of air discharge and then 1m below



|             |                          |
|-------------|--------------------------|
| MODEL       | : S-60PK1E5A, S-71PK1E5A |
| SOUND LEVEL | : STRONG 47 dB(A)        |
|             | High 44 dB(A)            |
|             | Low 40 dB(A)             |

CONDITION : 1m in front of air discharge and then 1m below





1-6. Noise Criterion Curves

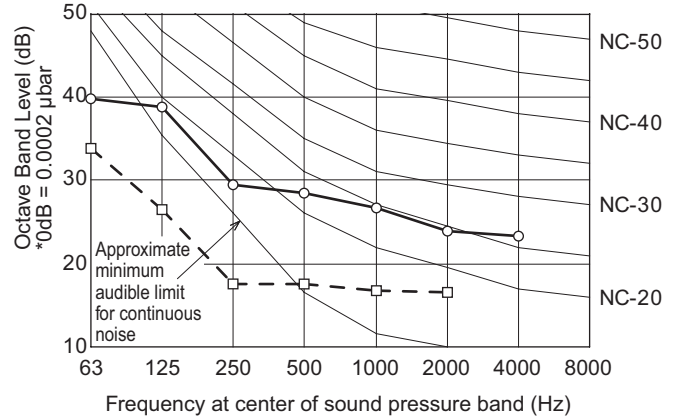
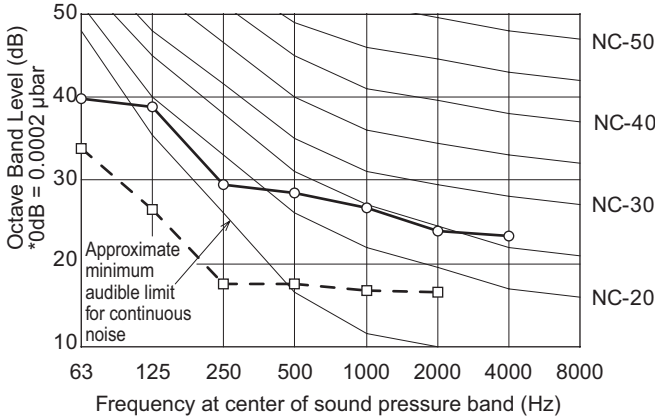
(A) Indoor Units

Low Silhouette Ducted Type

—○— High  
 - -□- - Low

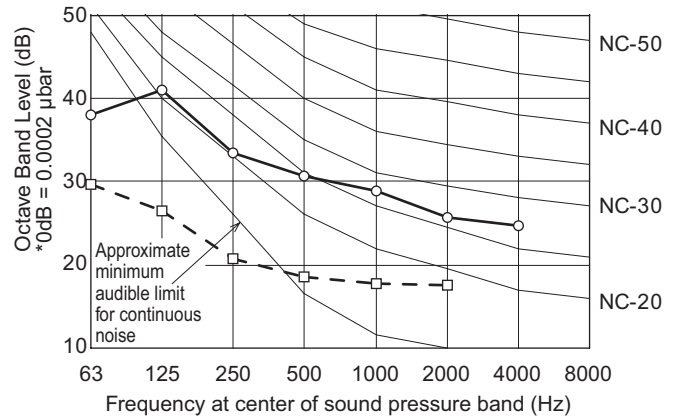
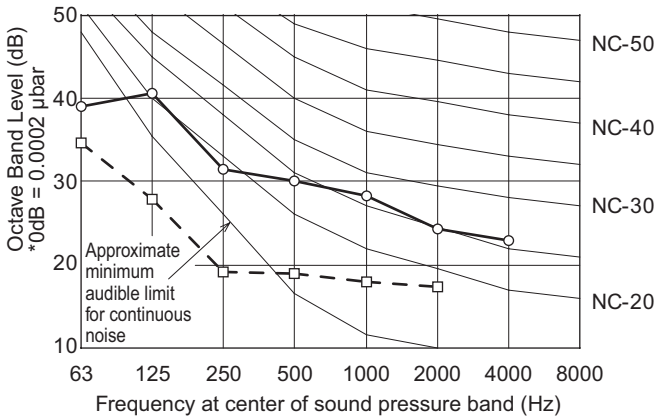
|             |                                 |
|-------------|---------------------------------|
| MODEL       | : S-36PF1E5A                    |
| SOUND LEVEL | : High 33 dB(A)<br>Low 25 dB(A) |
| CONDITION   | : Under the unit 1.5m           |
| SOURCE      | : 220-230-240V, 1 phase, 50Hz   |

|             |                                 |
|-------------|---------------------------------|
| MODEL       | : S-45PF1E5A                    |
| SOUND LEVEL | : High 33 dB(A)<br>Low 25 dB(A) |
| CONDITION   | : Under the unit 1.5m           |
| SOURCE      | : 220-230-240V, 1 phase, 50Hz   |

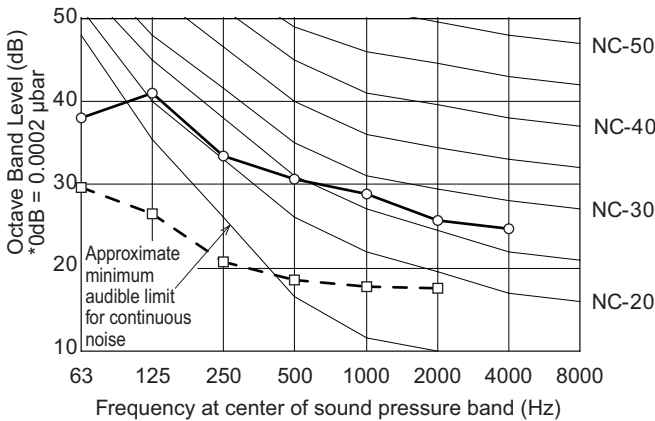


|             |                                 |
|-------------|---------------------------------|
| MODEL       | : S-50PF1E5A                    |
| SOUND LEVEL | : High 34 dB(A)<br>Low 26 dB(A) |
| CONDITION   | : Under the unit 1.5m           |
| SOURCE      | : 220-230-240V, 1 phase, 50Hz   |

|             |                                 |
|-------------|---------------------------------|
| MODEL       | : S-60PF1E5A                    |
| SOUND LEVEL | : High 35 dB(A)<br>Low 26 dB(A) |
| CONDITION   | : Under the unit 1.5m           |
| SOURCE      | : 220-230-240V, 1 phase, 50Hz   |



|             |                                 |
|-------------|---------------------------------|
| MODEL       | : S-71PF1E5A                    |
| SOUND LEVEL | : High 35 dB(A)<br>Low 26 dB(A) |
| CONDITION   | : Under the unit 1.5m           |
| SOURCE      | : 220-230-240V, 1 phase, 50Hz   |

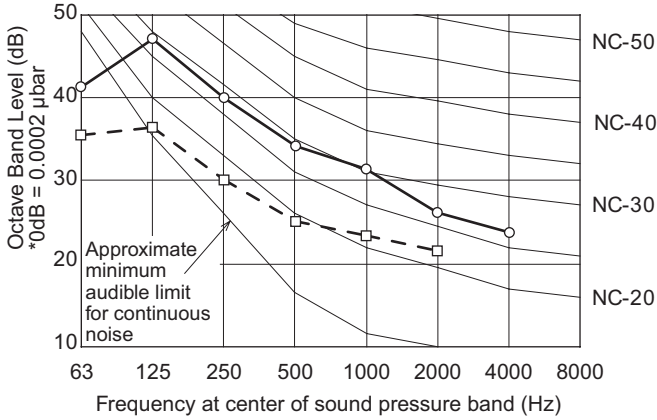


1-6. Noise Criterion Curves

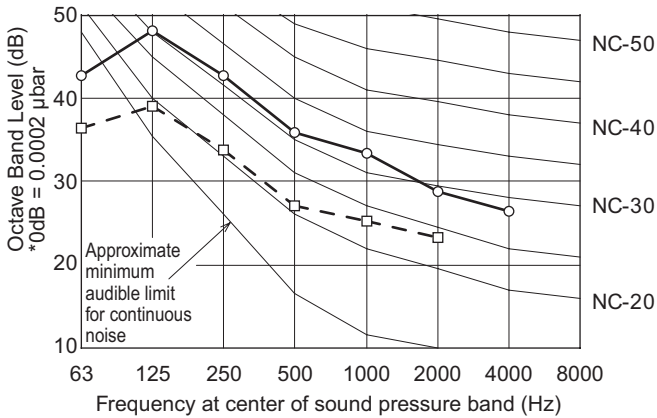
(A) Indoor Units

Low Silhouette Ducted Type

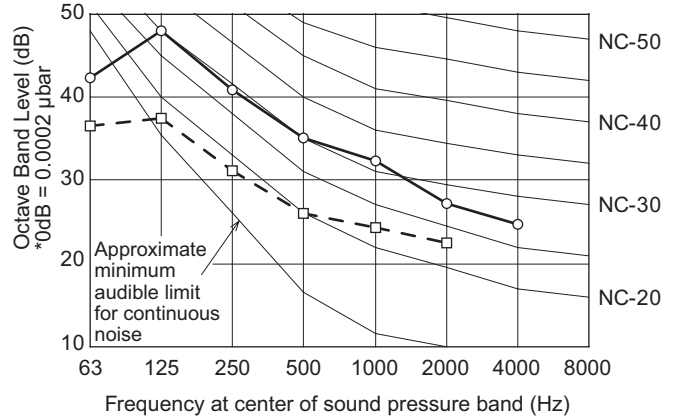
|             |                                 |
|-------------|---------------------------------|
| MODEL       | : S-100PF1E5A                   |
| SOUND LEVEL | : High 38 dB(A)<br>Low 31 dB(A) |
| CONDITION   | : Under the unit 1.5m           |
| SOURCE      | : 220-230-240V, 1 phase, 50Hz   |



|             |                                 |
|-------------|---------------------------------|
| MODEL       | : S-140PF1E5A                   |
| SOUND LEVEL | : High 40 dB(A)<br>Low 33 dB(A) |
| CONDITION   | : Under the unit 1.5m           |
| SOURCE      | : 220-230-240V, 1 phase, 50Hz   |



|             |                                 |
|-------------|---------------------------------|
| MODEL       | : S-125PF1E5A                   |
| SOUND LEVEL | : High 39 dB(A)<br>Low 32 dB(A) |
| CONDITION   | : Under the unit 1.5m           |
| SOURCE      | : 220-230-240V, 1 phase, 50Hz   |



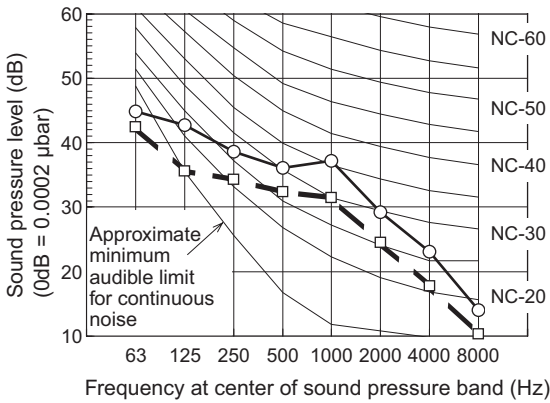
1-6. Noise Criterion Curves

(A) Indoor Units

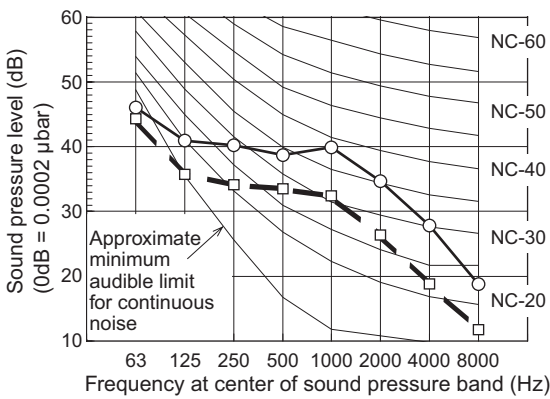
Ducted Type

—○— High  
 -□- Low

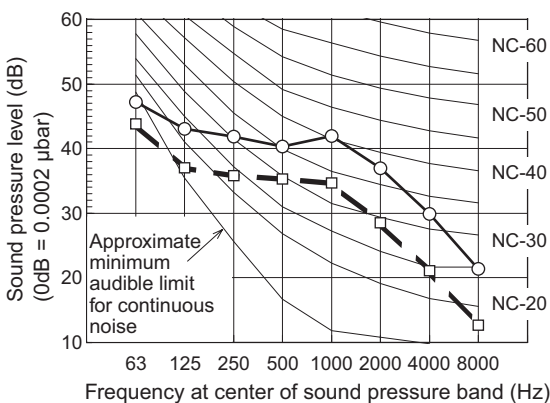
MODEL : S-36PN1E5A  
 SOUND LEVEL : HIGH 40 dB(A)  
 LOW 35 dB(A)  
 CONDITION : Under the unit 1.5m  
 SOURCE : 220-230-240V , Single Phase , 50Hz



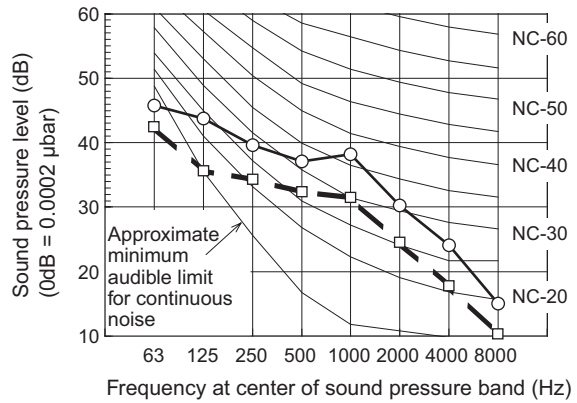
MODEL : S-60PN1E5A  
 S-71PN1E5A  
 SOUND LEVEL : HIGH 43 dB(A)  
 LOW 36 dB(A)  
 CONDITION : Under the unit 1.5m  
 SOURCE : 220-230-240V , Single Phase , 50Hz



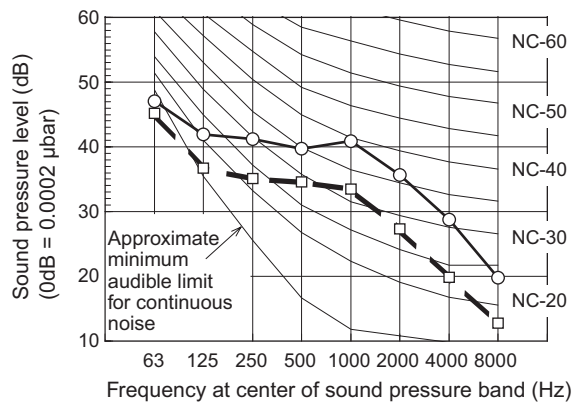
MODEL : S-125PN1E5A  
 SOUND LEVEL : HIGH 45 dB(A)  
 LOW 38 dB(A)  
 CONDITION : Under the unit 1.5m  
 SOURCE : 220-230-240V , Single Phase , 50Hz



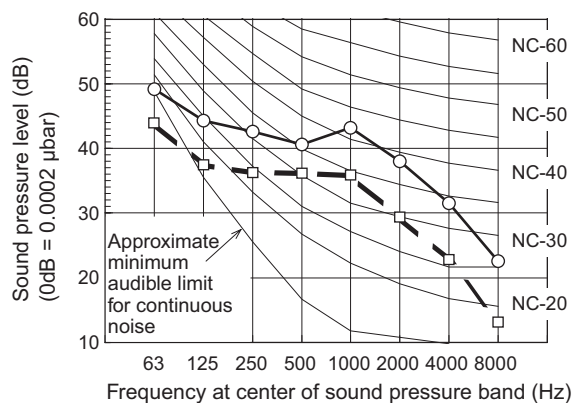
MODEL : S-45PN1E5A  
 S-50PN1E5A  
 SOUND LEVEL : HIGH 41 dB(A)  
 LOW 35 dB(A)  
 CONDITION : Under the unit 1.5m  
 SOURCE : 220-230-240V , Single Phase , 50Hz



MODEL : S-100PN1E5A  
 SOUND LEVEL : HIGH 44 dB(A)  
 LOW 37 dB(A)  
 CONDITION : Under the unit 1.5m  
 SOURCE : 220-230-240V , Single Phase , 50Hz



MODEL : S-140PN1E5A  
 SOUND LEVEL : HIGH 46 dB(A)  
 LOW 39 dB(A)  
 CONDITION : Under the unit 1.5m  
 SOURCE : 220-230-240V , Single Phase , 50Hz

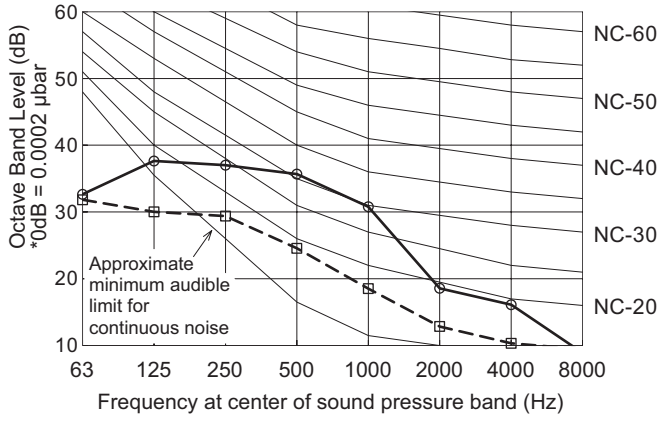


1-6. Noise Criterion Curves

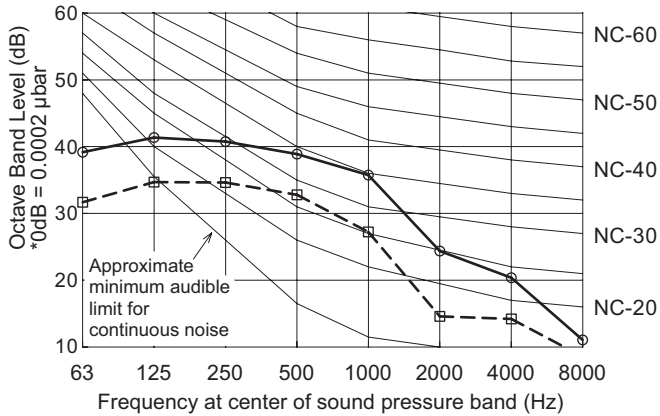
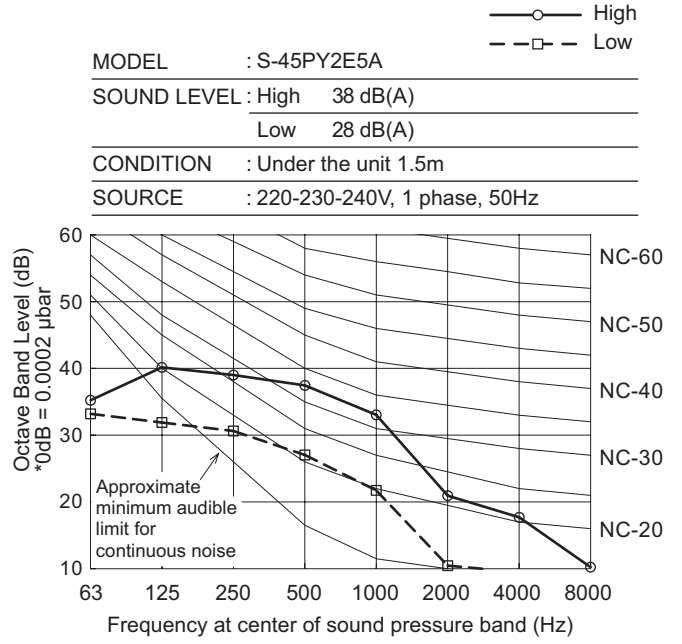
(A) Indoor Units

4-Way Cassette 60×60 Type

|             |                                 |
|-------------|---------------------------------|
| MODEL       | : S-36PY2E5A                    |
| SOUND LEVEL | : High 36 dB(A)<br>Low 26 dB(A) |
| CONDITION   | : Under the unit 1.5m           |
| SOURCE      | : 220-230-240V, 1 phase, 50Hz   |



|             |                                 |
|-------------|---------------------------------|
| MODEL       | : S-45PY2E5A                    |
| SOUND LEVEL | : High 38 dB(A)<br>Low 28 dB(A) |
| CONDITION   | : Under the unit 1.5m           |
| SOURCE      | : 220-230-240V, 1 phase, 50Hz   |

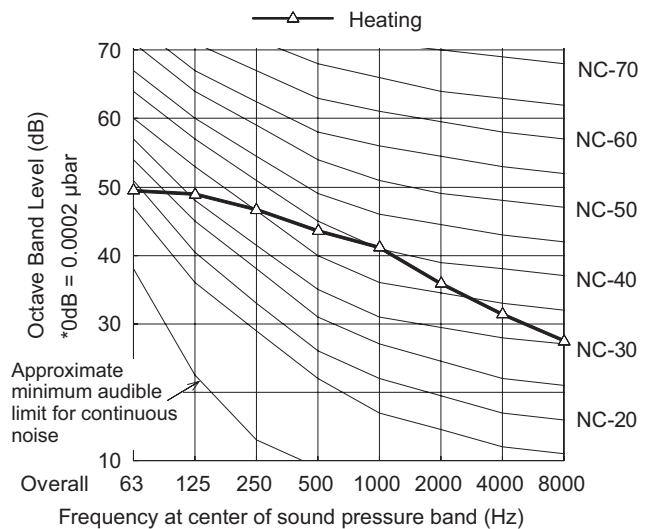
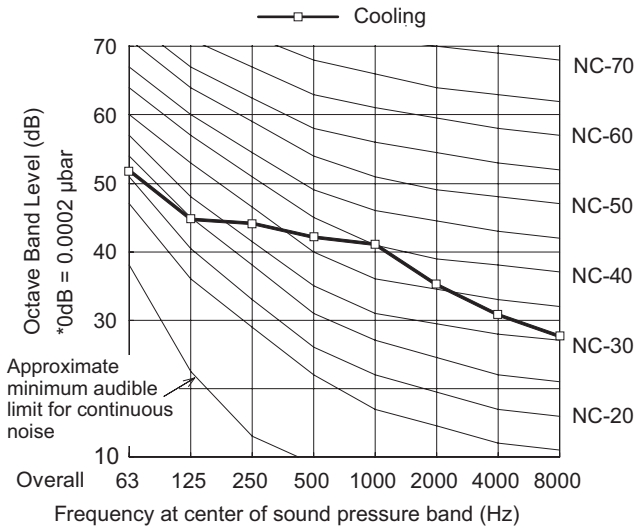


1-6. Noise Criterion Curves

(B) Outdoor Unit

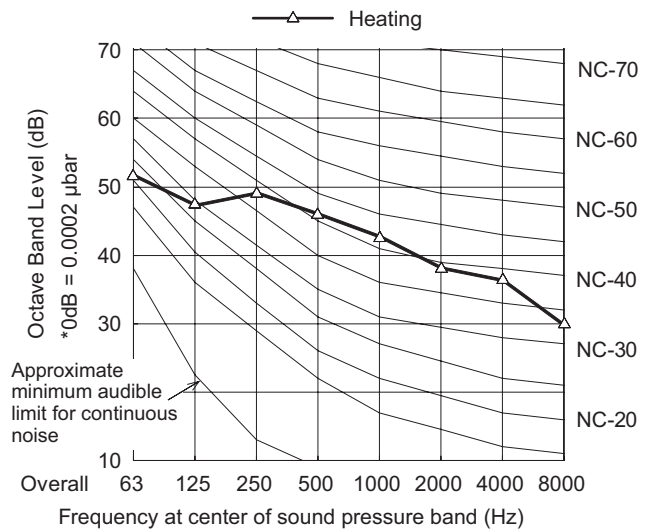
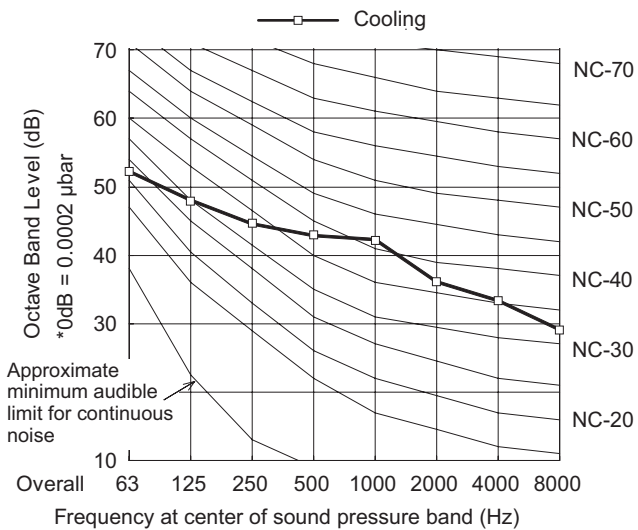
|             |                                   |
|-------------|-----------------------------------|
| MODEL       | : U-36PE2E5A                      |
| SOUND LEVEL | : Cooling 45 dB(A)                |
| CONDITION   | : 1 m in front at height of 1.5 m |
| SOURCE      | : 220-230-240V, 1 phase, 50Hz     |

|             |                                   |
|-------------|-----------------------------------|
| MODEL       | : U-36PE2E5A                      |
| SOUND LEVEL | : Heating 46 dB(A)                |
| CONDITION   | : 1 m in front at height of 1.5 m |
| SOURCE      | : 220-230-240V, 1 phase, 50Hz     |



|             |                                   |
|-------------|-----------------------------------|
| MODEL       | : U-50PE2E5A                      |
| SOUND LEVEL | : Cooling 46 dB(A)                |
| CONDITION   | : 1 m in front at height of 1.5 m |
| SOURCE      | : 220-230-240V, 1 phase, 50Hz     |

|             |                                   |
|-------------|-----------------------------------|
| MODEL       | : U-50PE2E5A                      |
| SOUND LEVEL | : Heating 48 dB(A)                |
| CONDITION   | : 1 m in front at height of 1.5 m |
| SOURCE      | : 220-230-240V, 1 phase, 50Hz     |

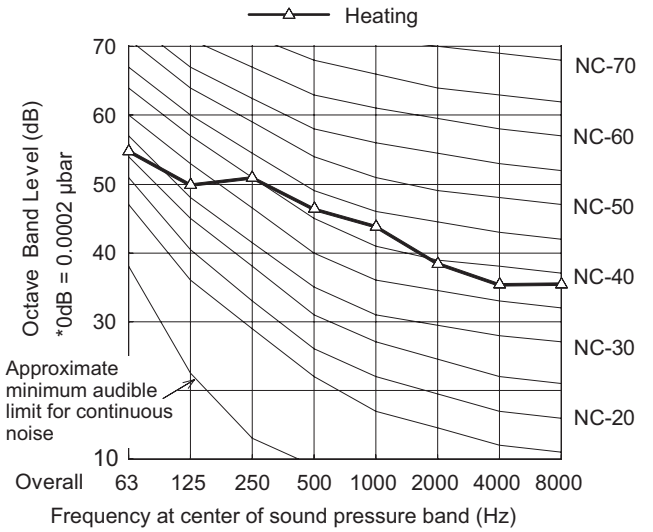
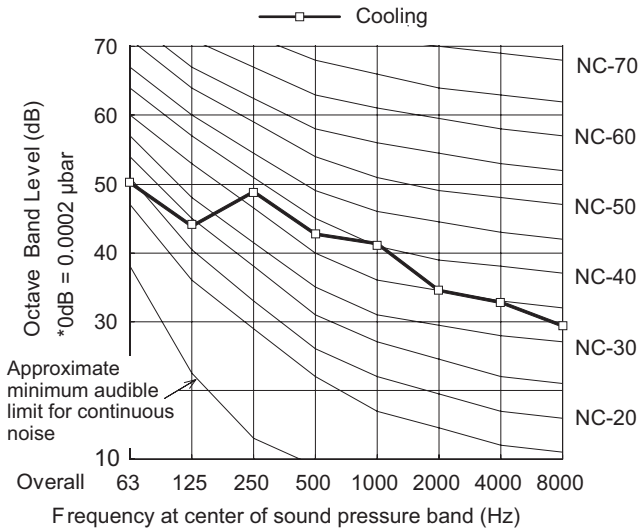


1-6. Noise Criterion Curves

(B) Outdoor Unit

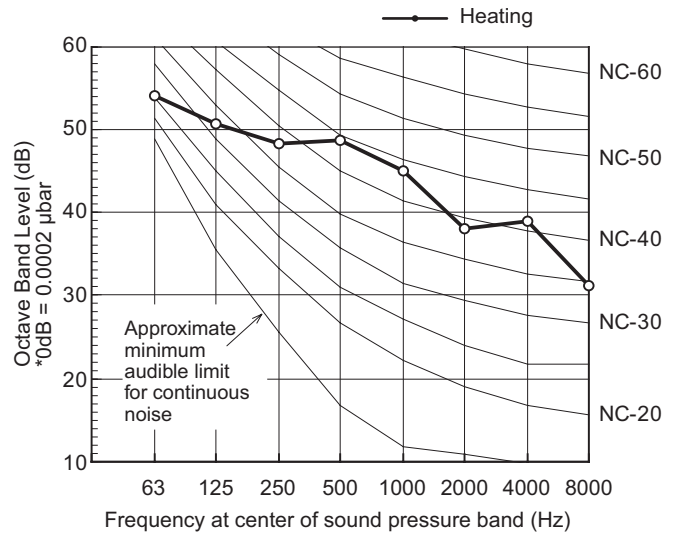
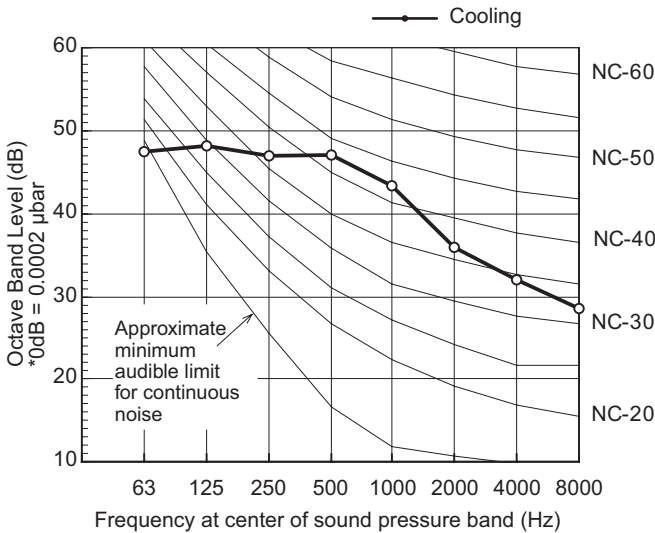
|             |                                   |
|-------------|-----------------------------------|
| MODEL       | : U-60PE2E5A                      |
| SOUND LEVEL | : Cooling 46 dB(A)                |
| CONDITION   | : 1 m in front at height of 1.5 m |
| SOURCE      | : 220-230-240V, 1 phase, 50Hz     |

|             |                                   |
|-------------|-----------------------------------|
| MODEL       | : U-60PE2E5A                      |
| SOUND LEVEL | : Heating 49 dB(A)                |
| CONDITION   | : 1 m in front at height of 1.5 m |
| SOURCE      | : 220-230-240V, 1 phase, 50Hz     |



|             |  |
|-------------|--|
| MODEL       | : U-71PE1E5A, U-71PE1E8A   |
| SOUND LEVEL | : Cooling 48 dB(A)   |
| CONDITION   | : 1 m in front at height of 1.5 m  |
| SOURCE      | 1 phase model : 220-230-240V, 1 phase, 50Hz<br>3 phase model : 380-400-415V, 3 phase, 50Hz |

|             |  |
|-------------|--|
| MODEL       | : U-71PE1E5A, U-71PE1E8A   |
| SOUND LEVEL | : Heating 50 dB(A)   |
| CONDITION   | : 1 m in front at height of 1.5 m  |
| SOURCE      | 1 phase model : 220-230-240V, 1 phase, 50Hz<br>3 phase model : 380-400-415V, 3 phase, 50Hz |

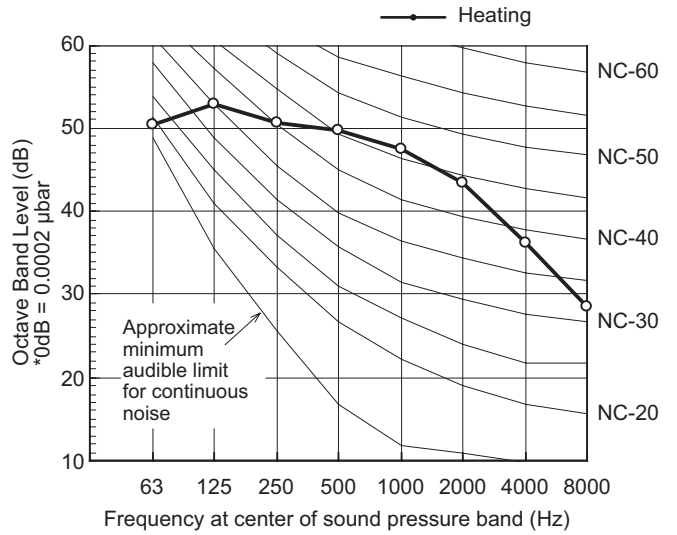
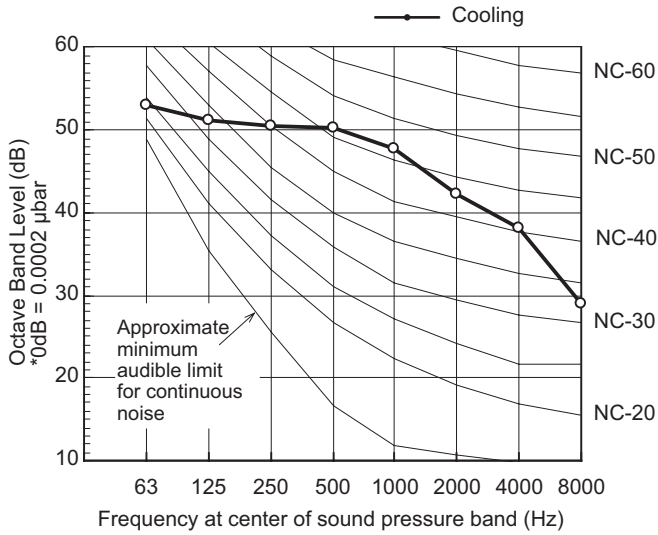


1-6. Noise Criterion Curves

(B) Outdoor Unit

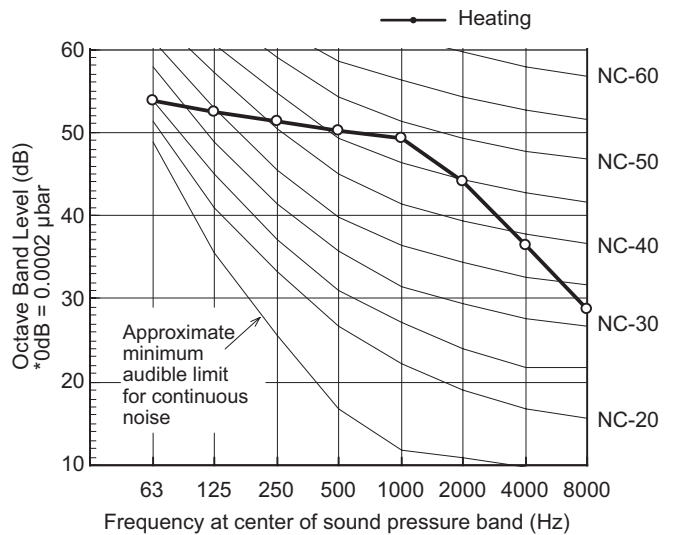
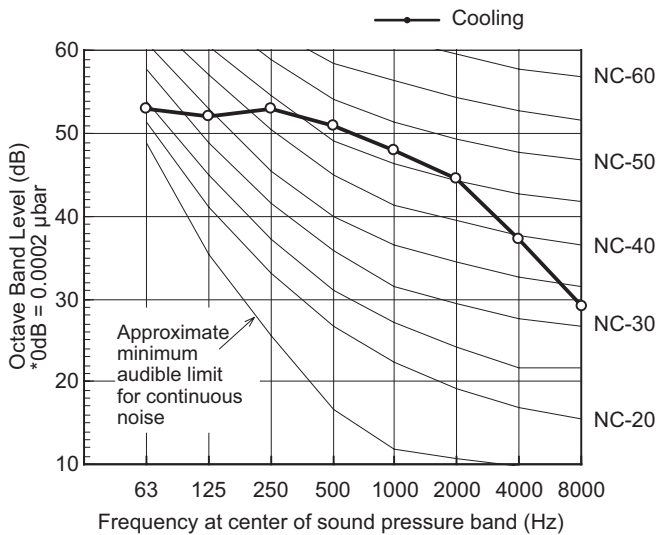
MODEL : U-100PE1E5A, U-100PE1E8A  
 SOUND LEVEL : Cooling 52 dB(A)  
 CONDITION : 1 m in front at height of 1.5 m  
 SOURCE 1 phase model : 220-230-240V, 1 phase, 50Hz  
 3 phase model : 380-400-415V, 3 phase, 50Hz

MODEL : U-100PE1E5A, U-100PE1E8A  
 SOUND LEVEL : Heating 52 dB(A)  
 CONDITION : 1 m in front at height of 1.5 m  
 SOURCE 1 phase model : 220-230-240V, 1 phase, 50Hz  
 3 phase model : 380-400-415V, 3 phase, 50Hz



MODEL : U-125PE1E5A, U-125PE1E8A  
 SOUND LEVEL : Cooling 53 dB(A)  
 CONDITION : 1 m in front at height of 1.5 m  
 SOURCE 1 phase model : 220-230-240V, 1 phase, 50Hz  
 3 phase model : 380-400-415V, 3 phase, 50Hz

MODEL : U-125PE1E5A, U-125PE1E8A  
 SOUND LEVEL : Heating 53 dB(A)  
 CONDITION : 1 m in front at height of 1.5 m  
 SOURCE 1 phase model : 220-230-240V, 1 phase, 50Hz  
 3 phase model : 380-400-415V, 3 phase, 50Hz

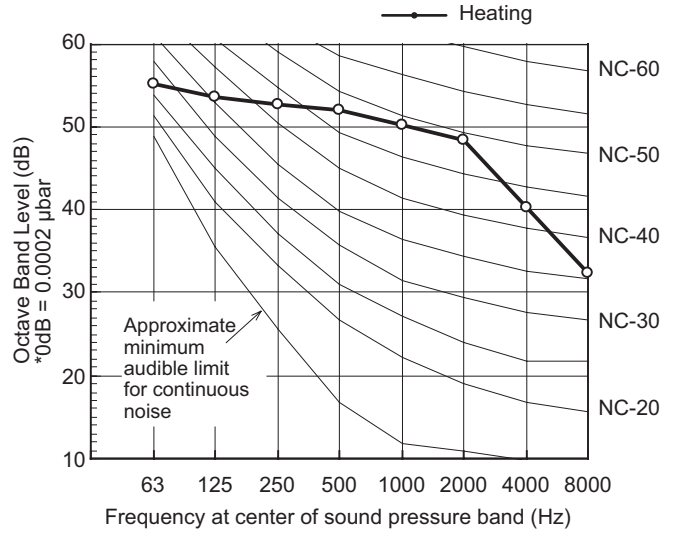
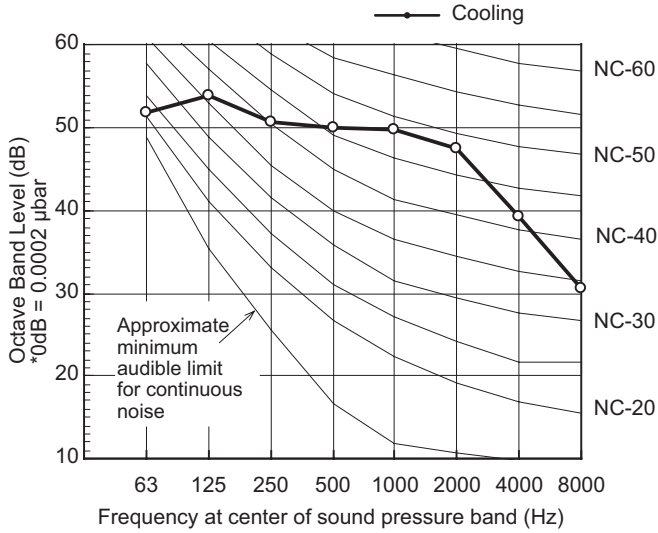


1-6. Noise Criterion Curves

(B) Outdoor Unit

MODEL : U-140PE1E5A, U-140PE1E8A  
 SOUND LEVEL : Cooling 54 dB(A)  
 CONDITION : 1 m in front at height of 1.5 m  
 SOURCE 1 phase model : 220-230-240V, 1 phase, 50Hz  
 3 phase model : 380-400-415V, 3 phase, 50Hz

MODEL : U-140PE1E5A, U-140PE1E8A  
 SOUND LEVEL : Heating 55 dB(A)  
 CONDITION : 1 m in front at height of 1.5 m  
 SOURCE 1 phase model : 220-230-240V, 1 phase, 50Hz  
 3 phase model : 380-400-415V, 3 phase, 50Hz

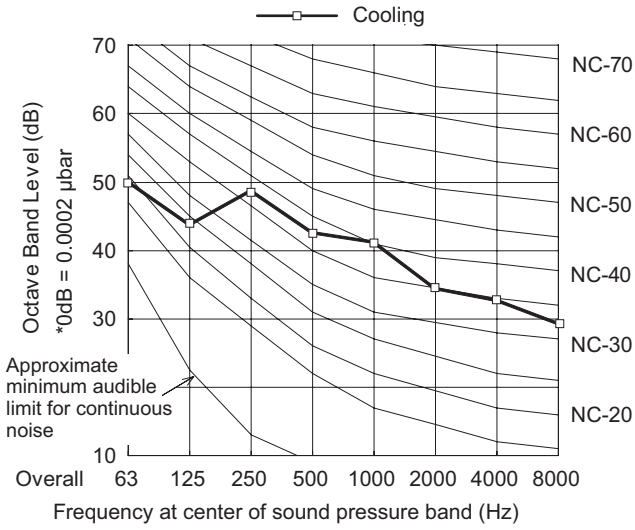




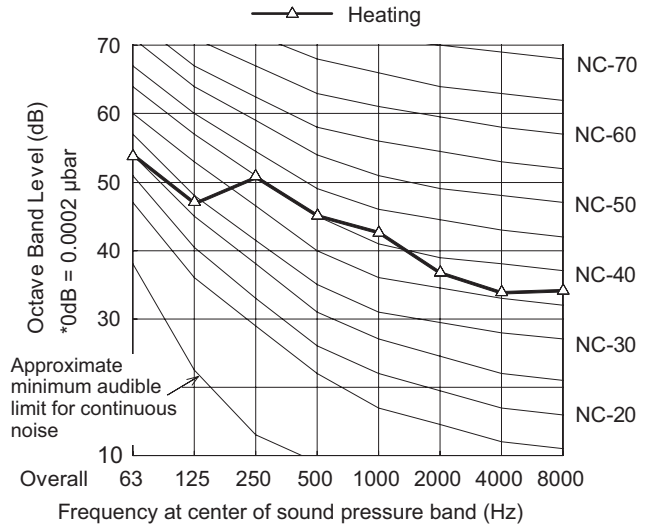
1-6. Noise Criterion Curves

(B) Outdoor Unit

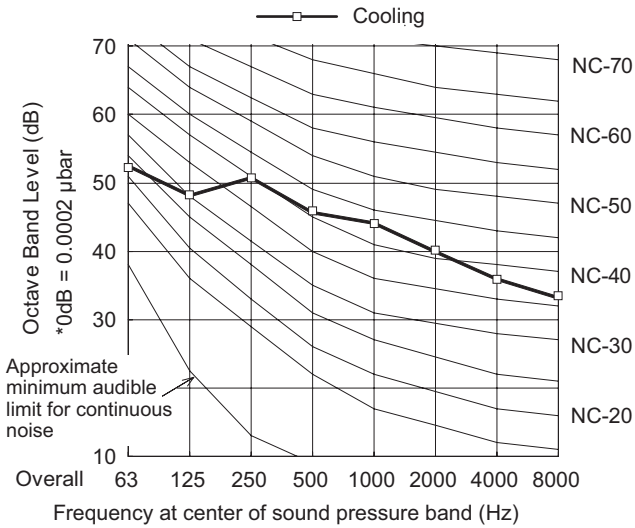
|             |                                   |
|-------------|-----------------------------------|
| MODEL       | : U-60PEY2E5                      |
| SOUND LEVEL | : Cooling 46 dB(A)                |
| CONDITION   | : 1 m in front at height of 1.5 m |
| SOURCE      | : 220-230-240V, 1 phase, 50Hz     |



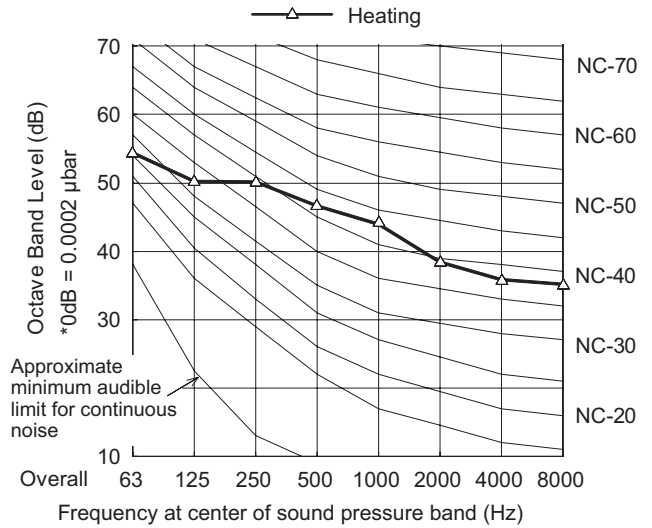
|             |                                   |
|-------------|-----------------------------------|
| MODEL       | : U-60PEY2E5                      |
| SOUND LEVEL | : Heating 48 dB(A)                |
| CONDITION   | : 1 m in front at height of 1.5 m |
| SOURCE      | : 220-230-240V, 1 phase, 50Hz     |



|             |                                   |
|-------------|-----------------------------------|
| MODEL       | : U-71PEY2E5                      |
| SOUND LEVEL | : Cooling 49 dB(A)                |
| CONDITION   | : 1 m in front at height of 1.5 m |
| SOURCE      | : 220-230-240V, 1 phase, 50Hz     |



|             |                                   |
|-------------|-----------------------------------|
| MODEL       | : U-71PEY2E5                      |
| SOUND LEVEL | : Heating 49 dB(A)                |
| CONDITION   | : 1 m in front at height of 1.5 m |
| SOURCE      | : 220-230-240V, 1 phase, 50Hz     |

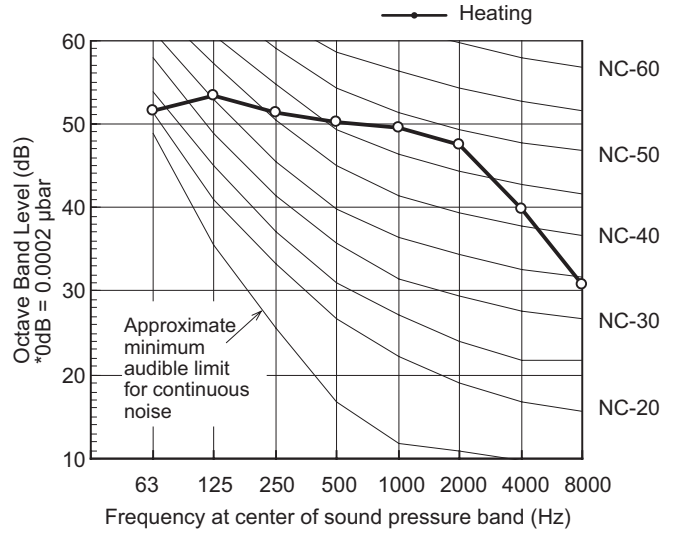
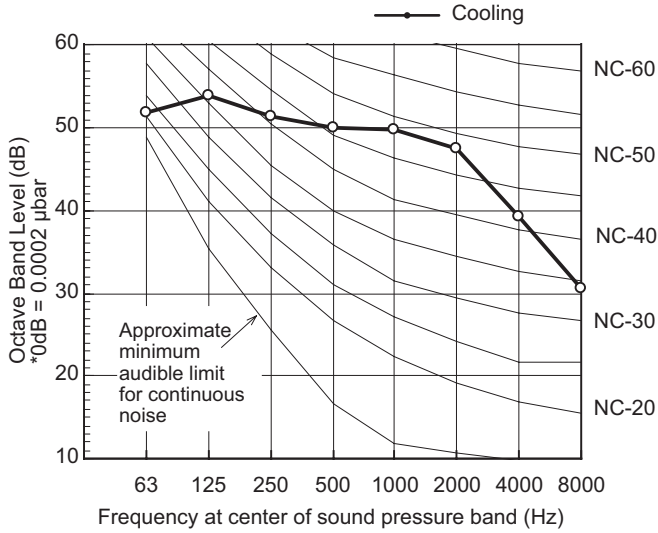


1-6. Noise Criterion Curves

(B) Outdoor Unit

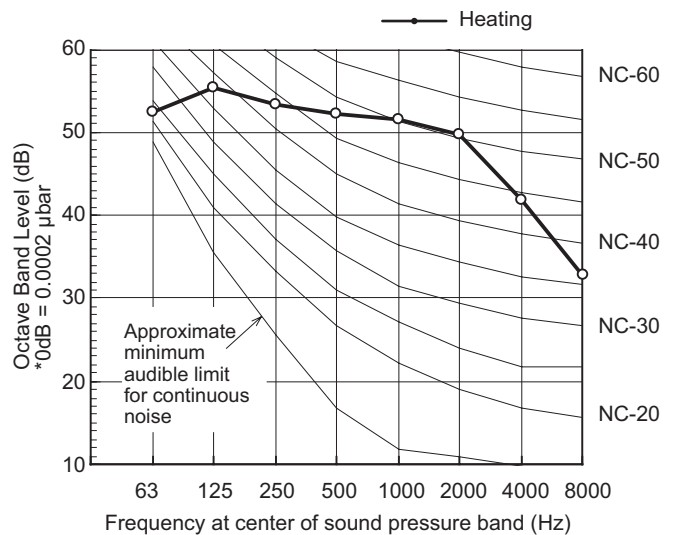
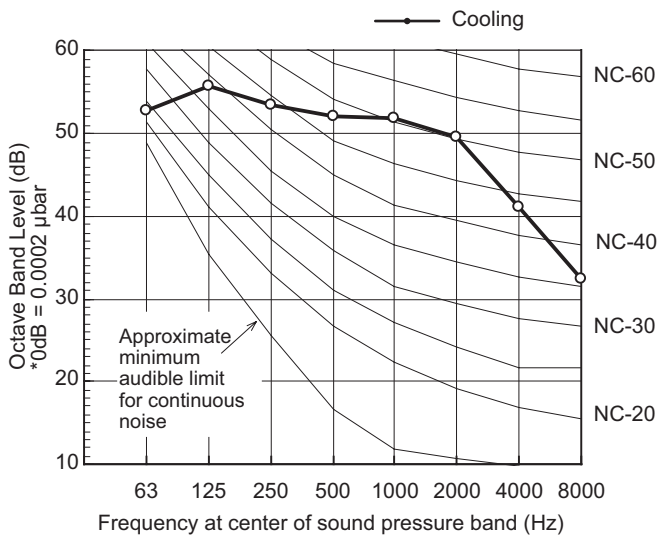
MODEL : U-100PEY1E5, U-100PEY1E8  
 SOUND LEVEL : Cooling 54 dB(A)  
 CONDITION : 1 m in front at height of 1.5 m  
 SOURCE 1 phase model : 220-230-240V, 1 phase, 50Hz  
 3 phase model : 380-400-415V, 3 phase, 50Hz

MODEL : U-100PEY1E5, U-100PEY1E8  
 SOUND LEVEL : Heating 54 dB(A)  
 CONDITION : 1 m in front at height of 1.5 m  
 SOURCE 1 phase model : 220-230-240V, 1 phase, 50Hz  
 3 phase model : 380-400-415V, 3 phase, 50Hz



MODEL : U-125PEY1E5, U-125PEY1E8  
 SOUND LEVEL : Cooling 56 dB(A)  
 CONDITION : 1 m in front at height of 1.5 m  
 SOURCE 1 phase model : 220-230-240V, 1 phase, 50Hz  
 3 phase model : 380-400-415V, 3 phase, 50Hz

MODEL : U-125PEY1E5, U-125PEY1E8  
 SOUND LEVEL : Heating 56 dB(A)  
 CONDITION : 1 m in front at height of 1.5 m  
 SOURCE 1 phase model : 220-230-240V, 1 phase, 50Hz  
 3 phase model : 380-400-415V, 3 phase, 50Hz

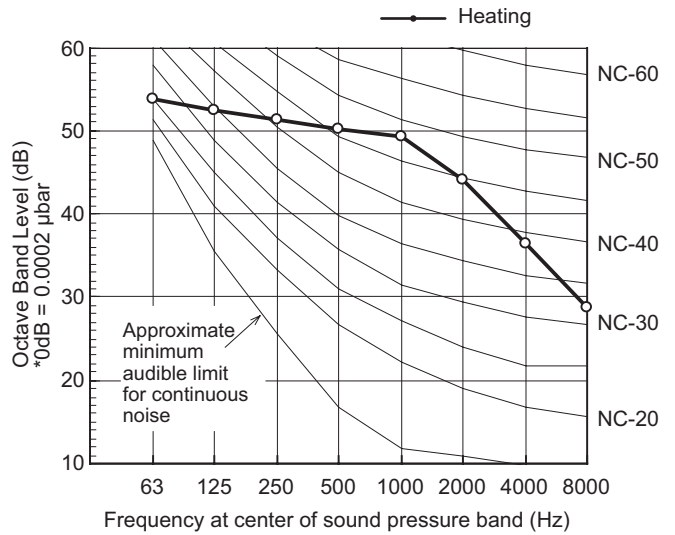
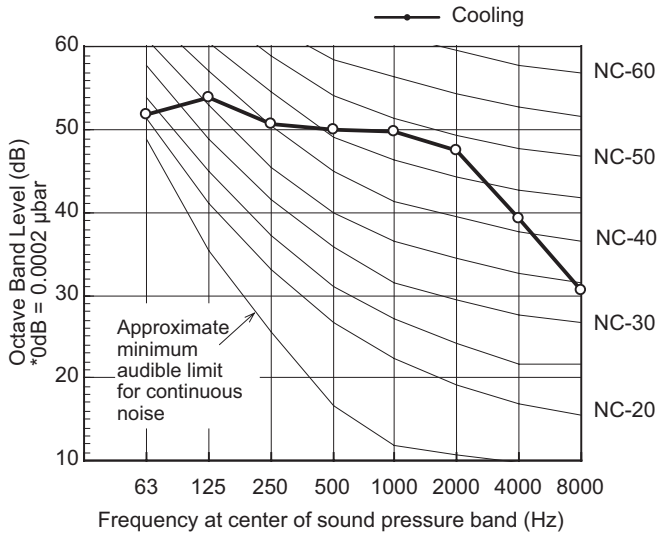


1-6. Noise Criterion Curves

(B) Outdoor Unit

|             |                                   |
|-------------|-----------------------------------|
| MODEL       | : U-140PEY1E8                     |
| SOUND LEVEL | : Cooling 54 dB(A)                |
| CONDITION   | : 1 m in front at height of 1.5 m |
| SOURCE      | : 380-400-415V, 3 phase, 50Hz     |

|             |                                   |
|-------------|-----------------------------------|
| MODEL       | : U-140PEY1E8                     |
| SOUND LEVEL | : Heating 53 dB(A)                |
| CONDITION   | : 1 m in front at height of 1.5 m |
| SOURCE      | : 380-400-415V, 3 phase, 50Hz     |



**1-7. Indoor Fan Performance**

External Static Pressure Setting for AC Fan Motor Model

To apply to following models

■ S-36PN1E5A , S-45PN1E5A , S-50PN1E5A

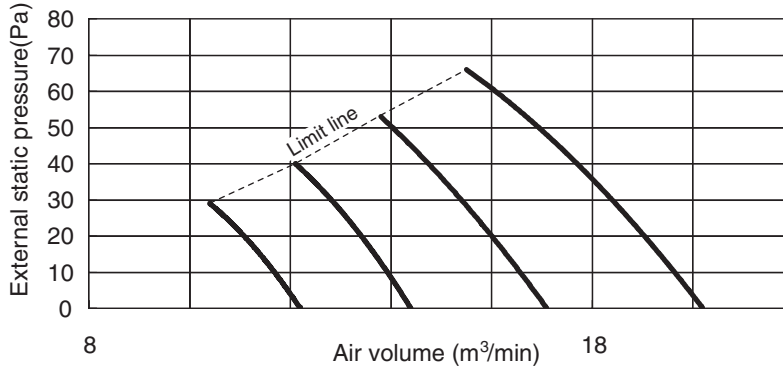
There are two tap connector located in indoor unit control box can be selected.

The "blue connector" is standard tap ,use-as-is at shipment.

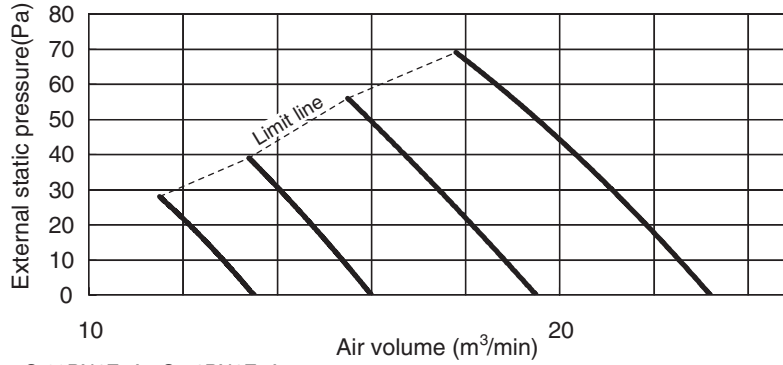
For high static pressure duct ,switch Fan Motor connector to plug in boost tap

"white connector" to elevate air volume.

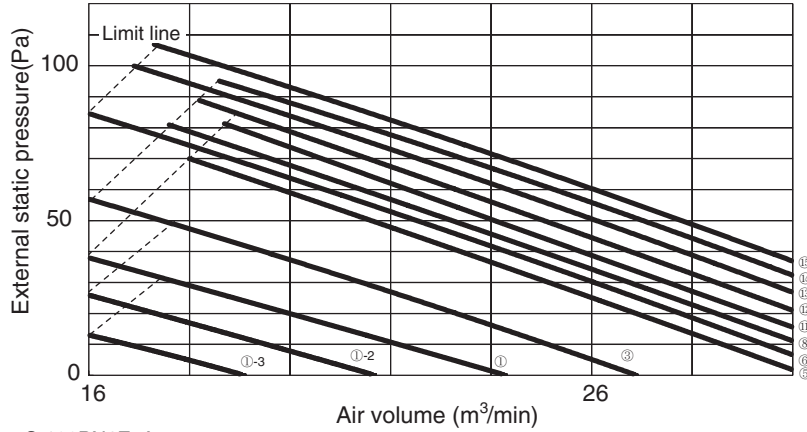
S-36PN1E5A P-Q CURVE



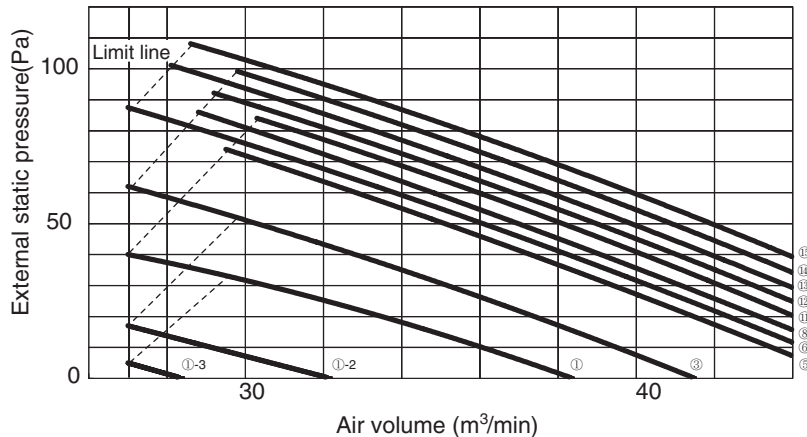
S-45PN1E5A, S-50PN1E5A P-Q CURVE



S-60PN1E5A • S-71PN1E5A



S-100PN1E5A

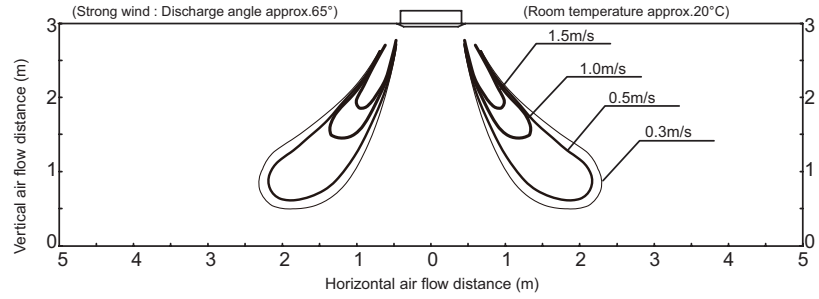


1-8. Airflow Distance Chart

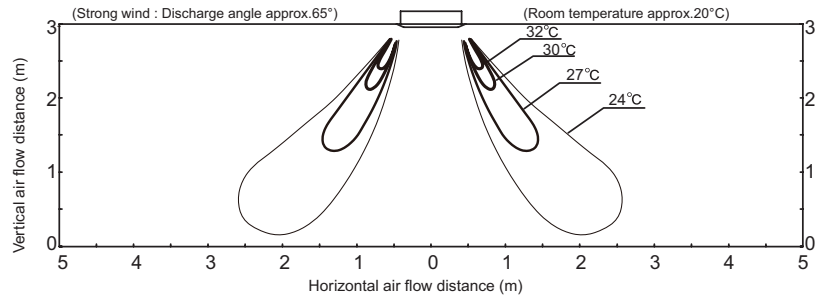
4-Way Cassette (Type U2)

S-36PU2E5A / 45PU2E5A / 50PU2E5A

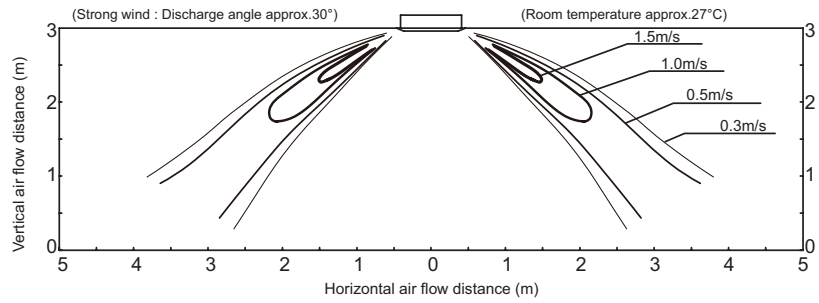
Heating : Distribution of wind velocity



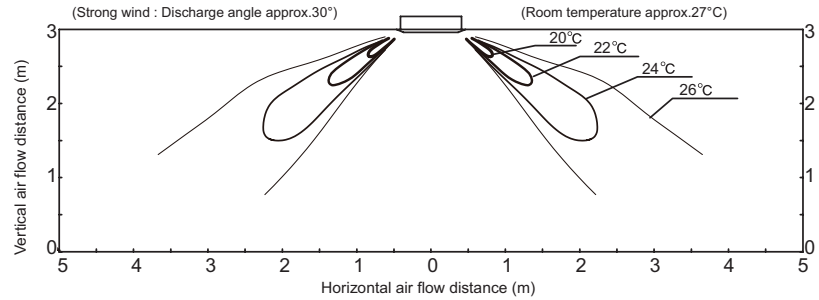
Heating : Distribution of temperature



Cooling : Distribution of wind velocity



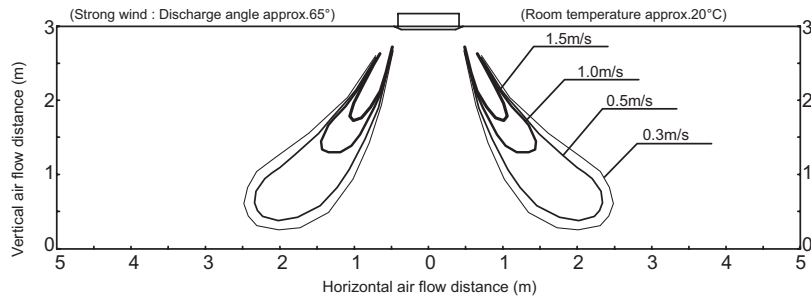
Cooling : Distribution of temperature



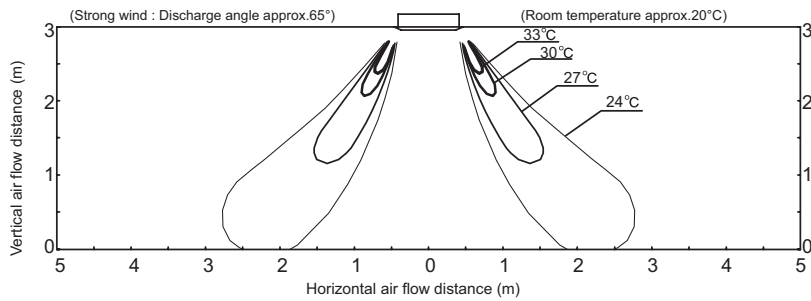
4-Way Cassette (Type U2)

S-60PU2E5A / 71PU2E5A

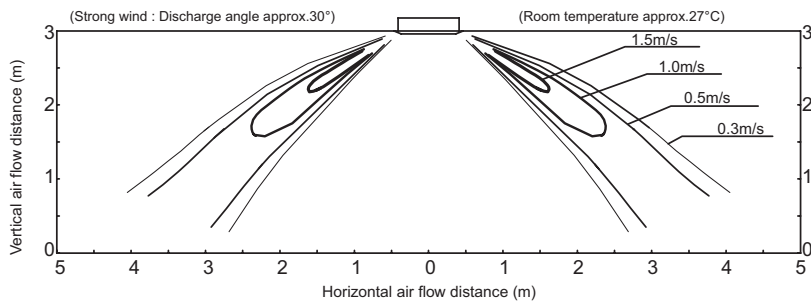
Heating : Distribution of wind velocity



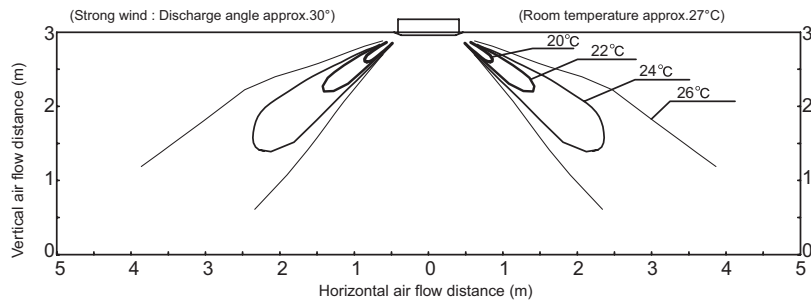
Heating : Distribution of temperature



Cooling : Distribution of wind velocity



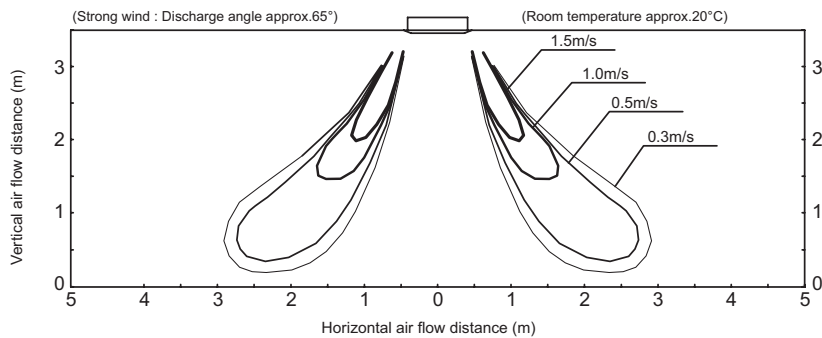
Cooling : Distribution of temperature



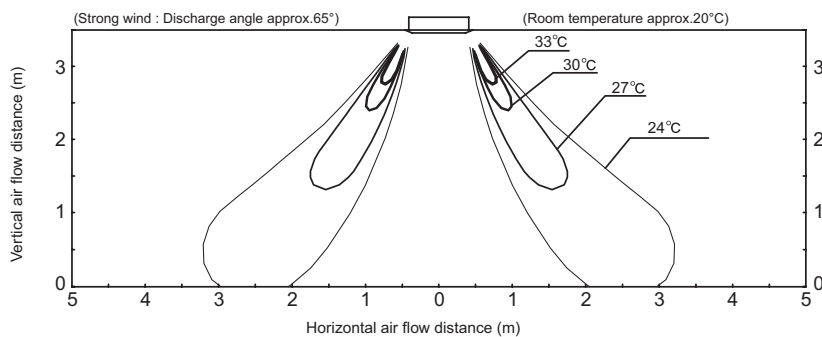
4-Way Cassette (Type U2)

S-100PU2E5A / 125PU2E5A / 140PU2E5A

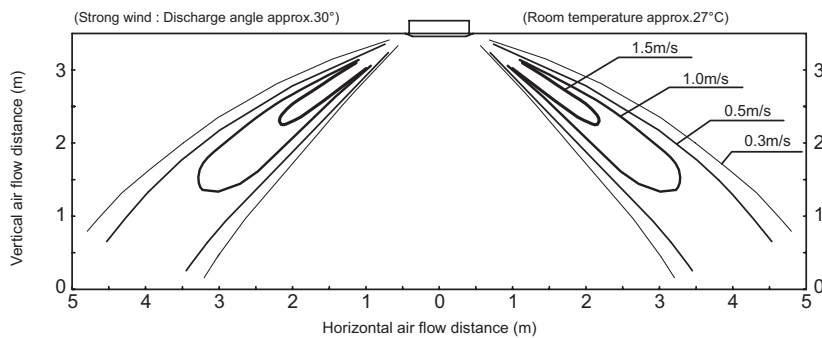
Heating : Distribution of wind velocity



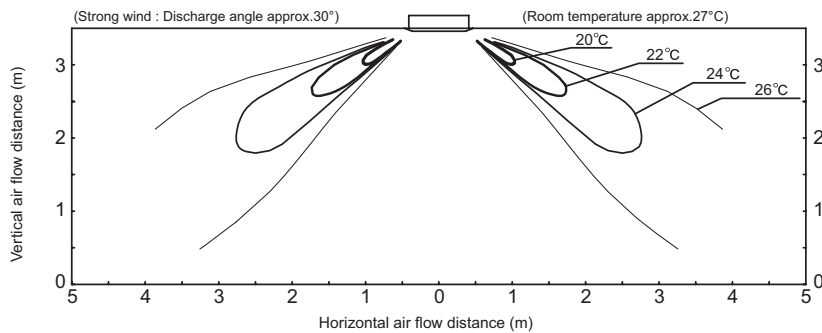
Heating : Distribution of temperature



Cooling : Distribution of wind velocity



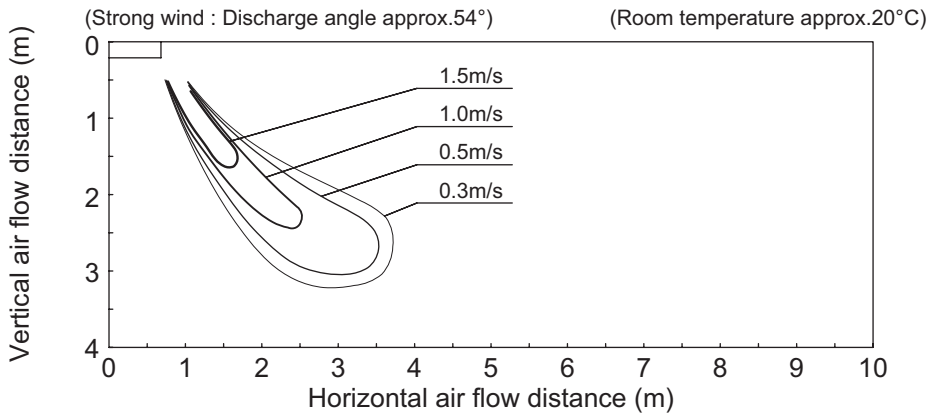
Cooling : Distribution of temperature



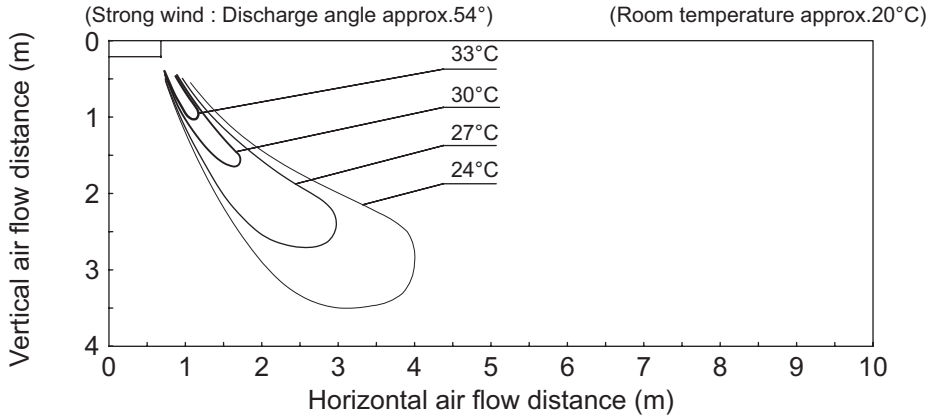
**Ceiling (Type T2)**

**S-36PT2E5A / 45PT2E5A / 50PT2E5A**

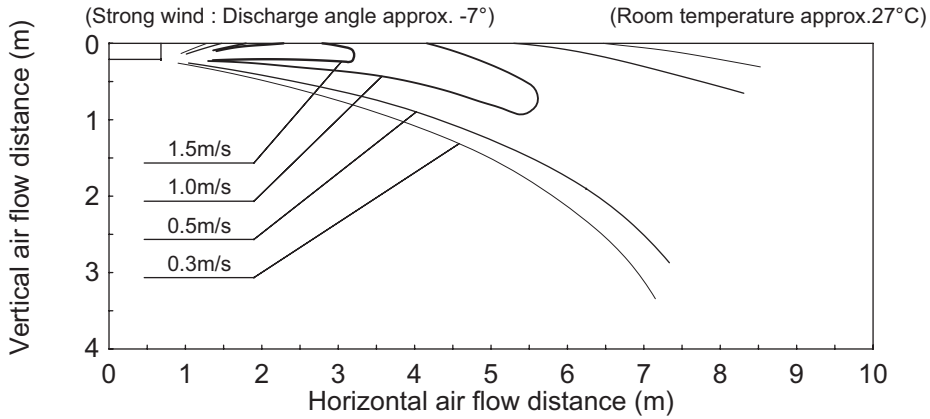
Heating : Distribution of wind velocity



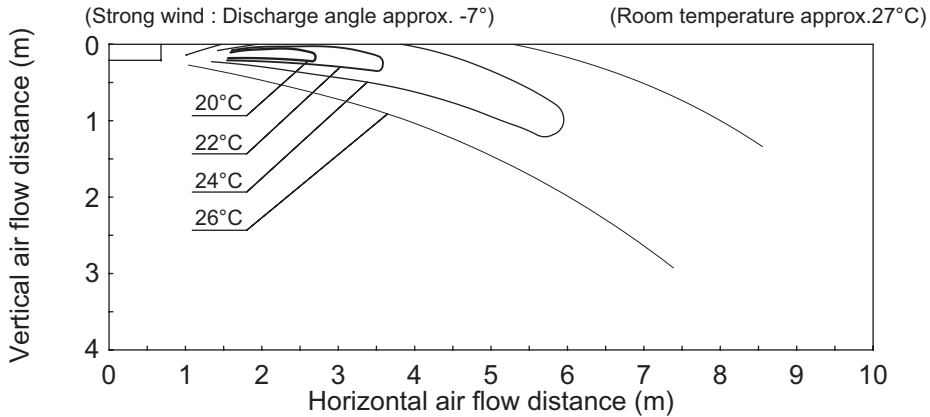
Heating : Distribution of temperature



Cooling : Distribution of wind velocity



Cooling : Distribution of temperature

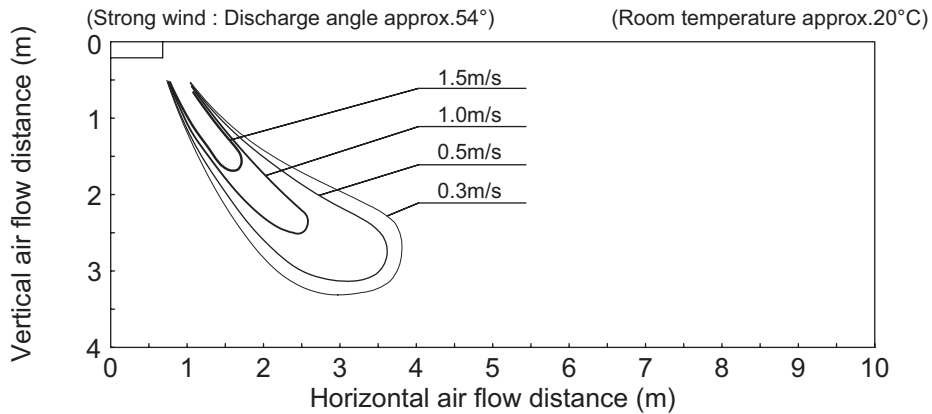




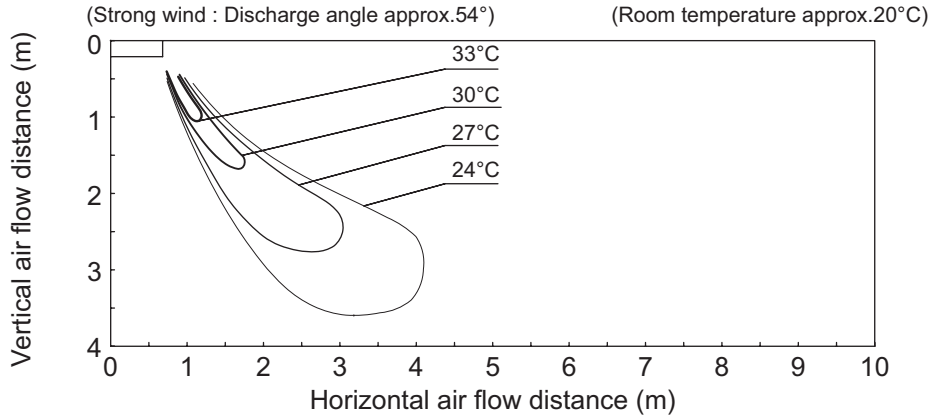
### Ceiling (Type T2)

#### S-60PT2E5A / 71PT2E5A

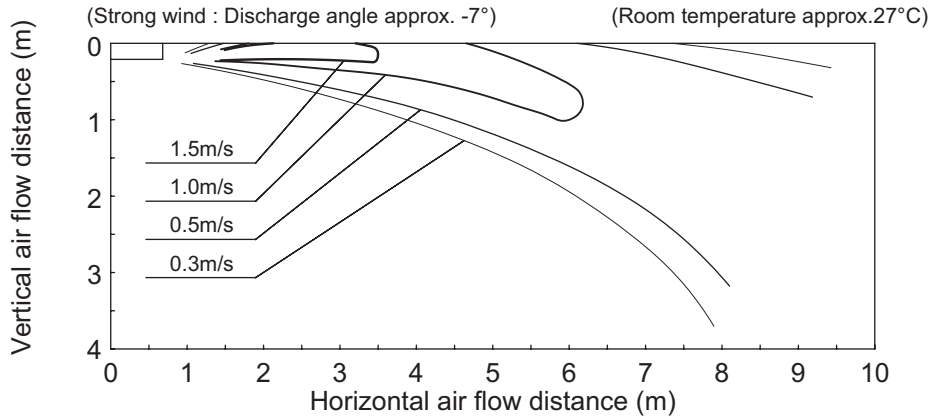
Heating : Distribution of wind velocity



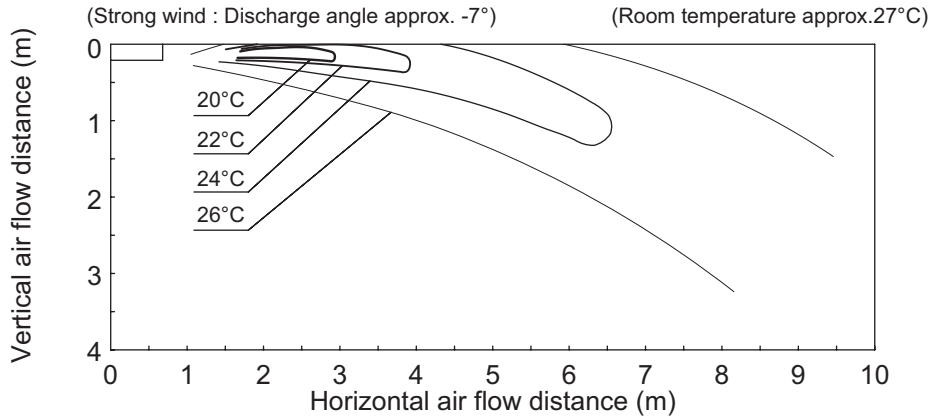
Heating : Distribution of temperature



Cooling : Distribution of wind velocity



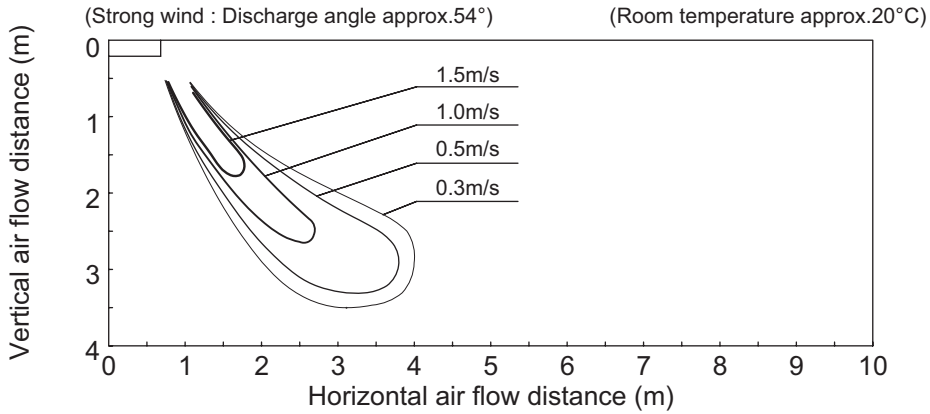
Cooling : Distribution of temperature



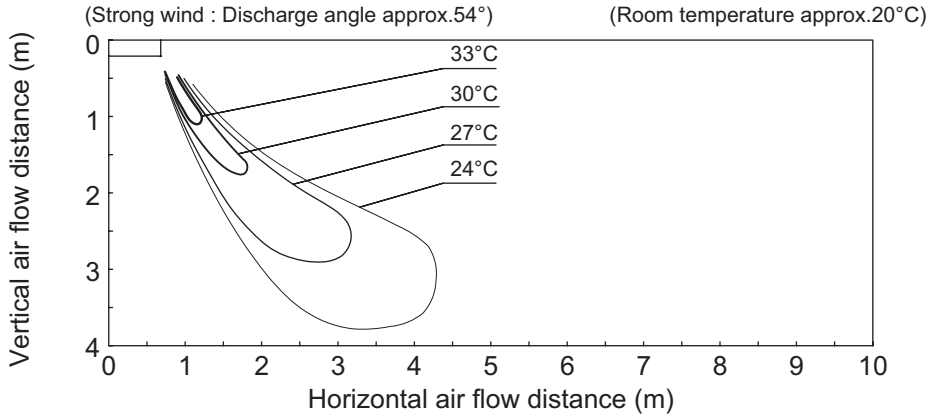
Ceiling (Type T2)

S-100PT2E5A / 125PT2E5A / 140PT2E5A

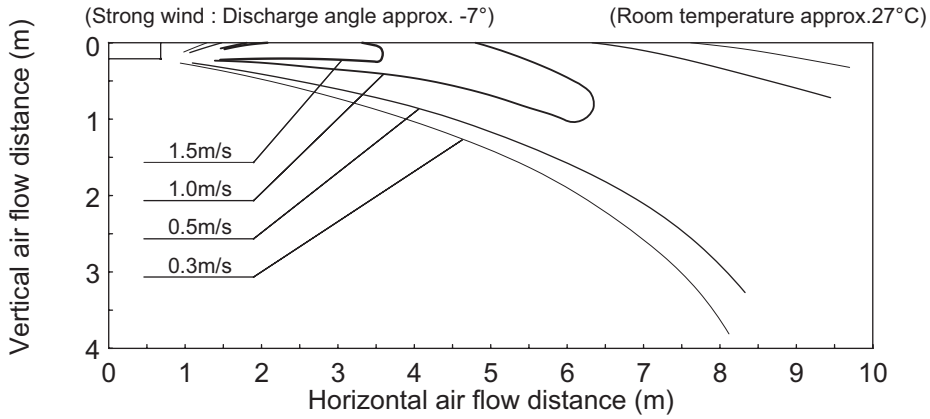
Heating : Distribution of wind velocity



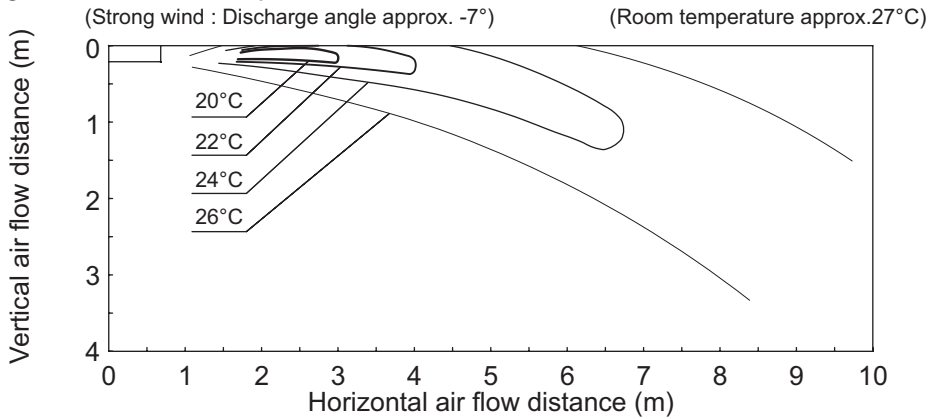
Heating : Distribution of temperature



Cooling : Distribution of wind velocity

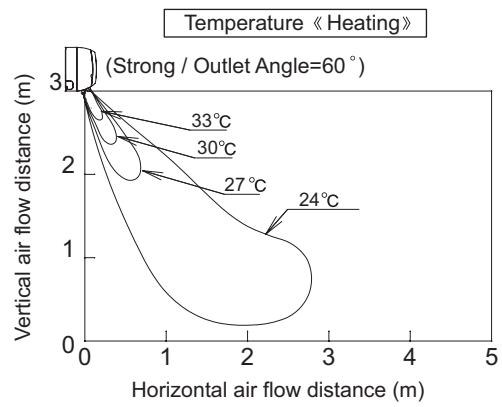
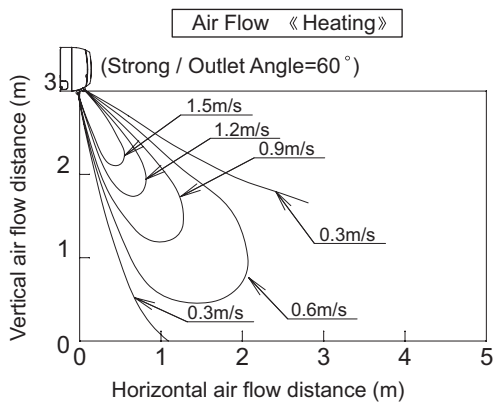
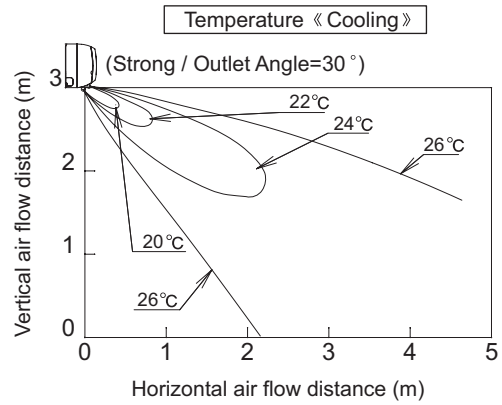
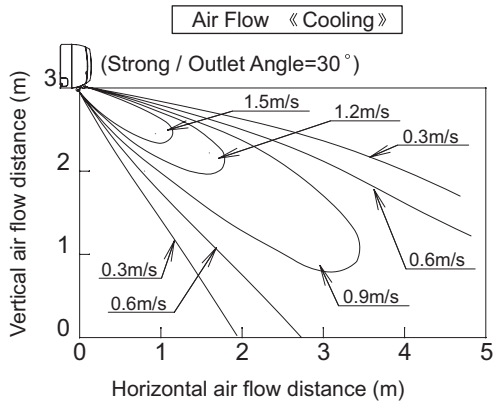


Cooling : Distribution of temperature



Wall Mounted (Type K1)

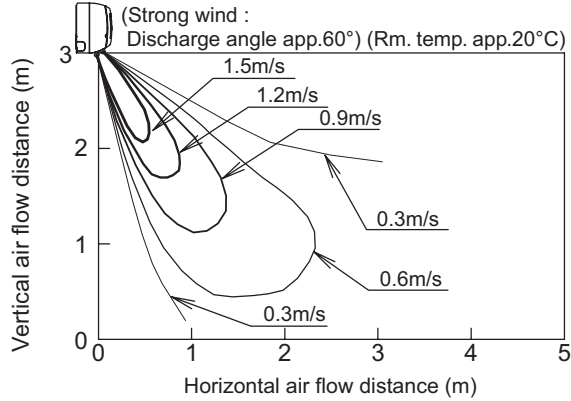
S-36PK1E5A



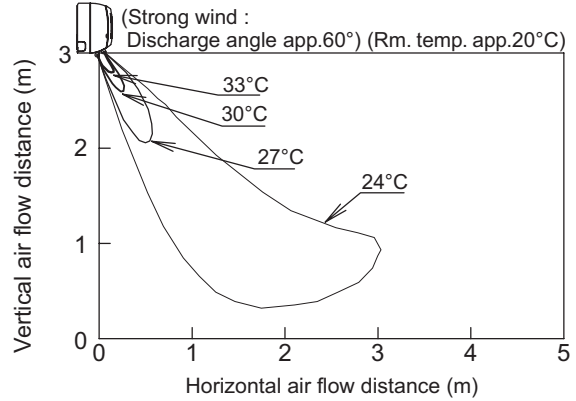
Wall Mounted (Type K1)

**S-45PK1E5A**

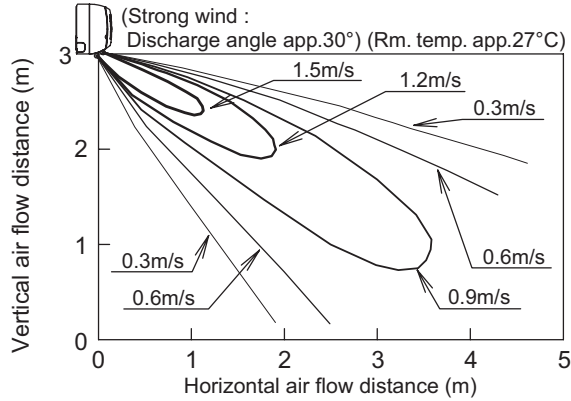
Heating : Distribution of wind velocity



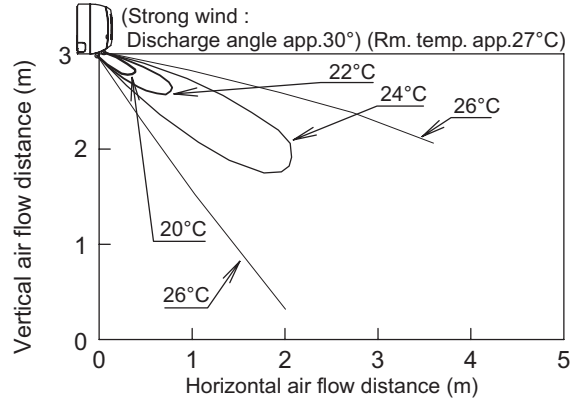
Heating : Distribution of temperature



Cooling : Distribution of wind velocity

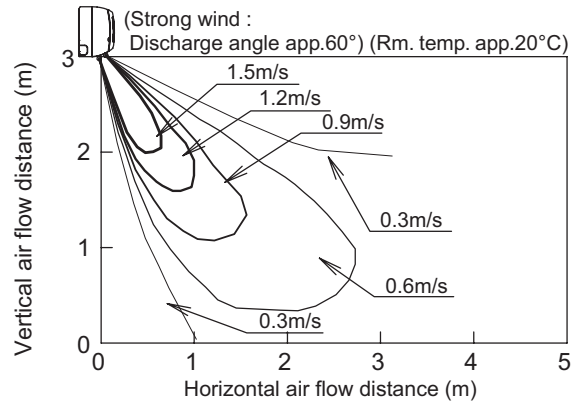


Cooling : Distribution of temperature

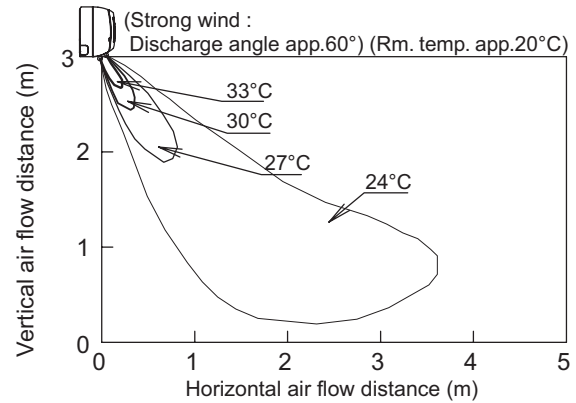


**S-50PK1E5A**

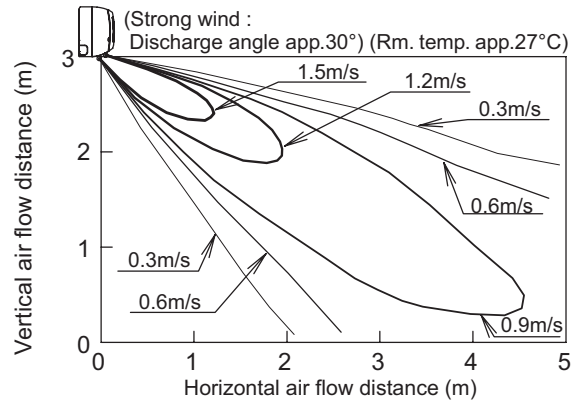
Heating : Distribution of wind velocity



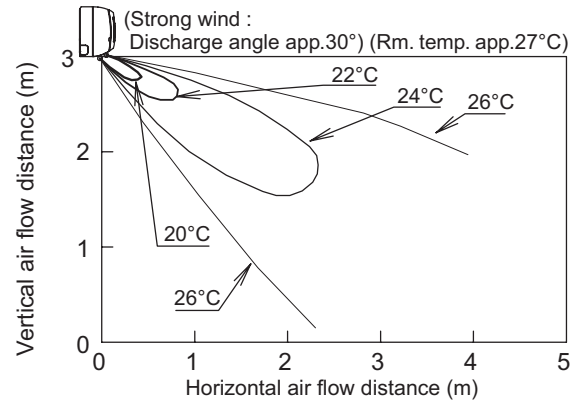
Heating : Distribution of temperature



Cooling : Distribution of wind velocity



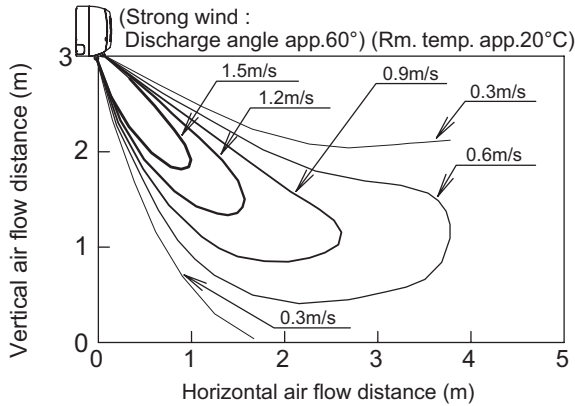
Cooling : Distribution of temperature



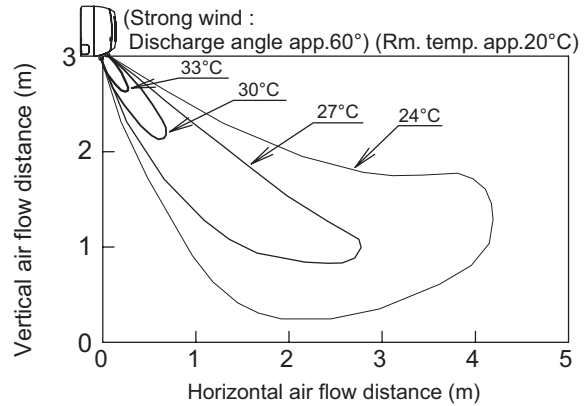
Wall Mounted (Type K1)

**S-60PK1E5A / 71PK1E5A**

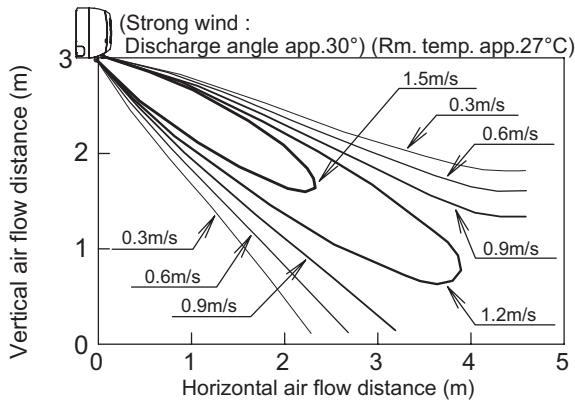
Heating : Distribution of wind velocity



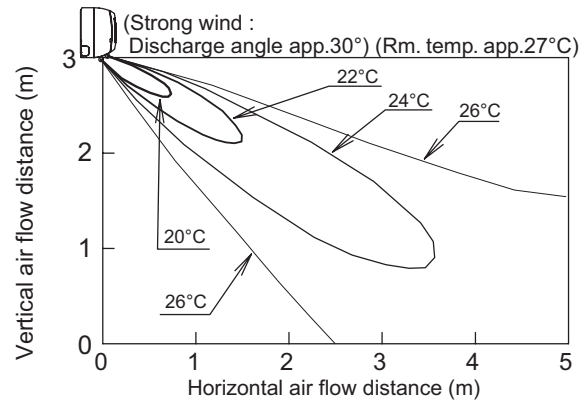
Heating : Distribution of temperature



Cooling : Distribution of wind velocity

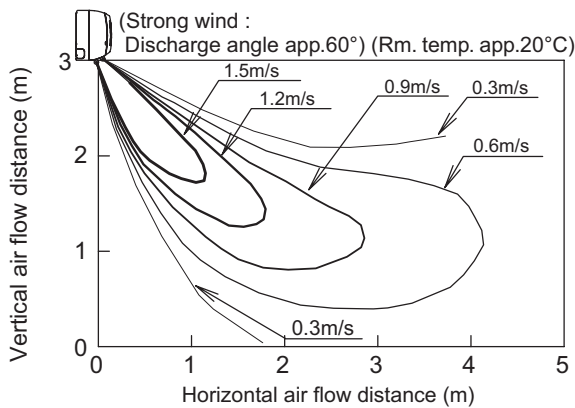


Cooling : Distribution of temperature

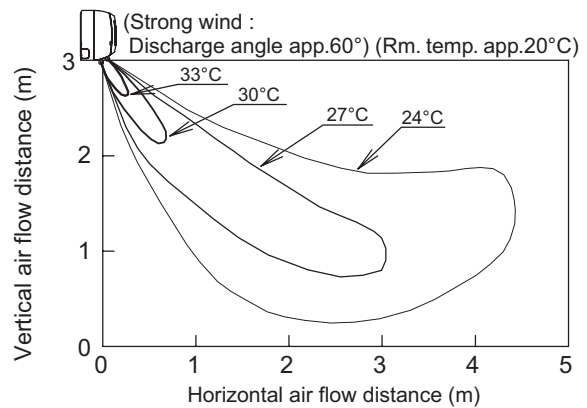


**S-100PK1E5A**

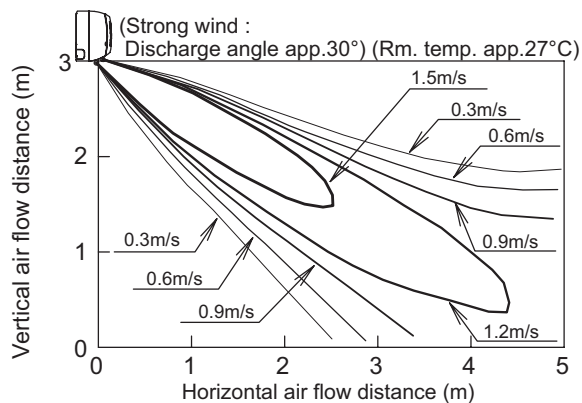
Heating : Distribution of wind velocity



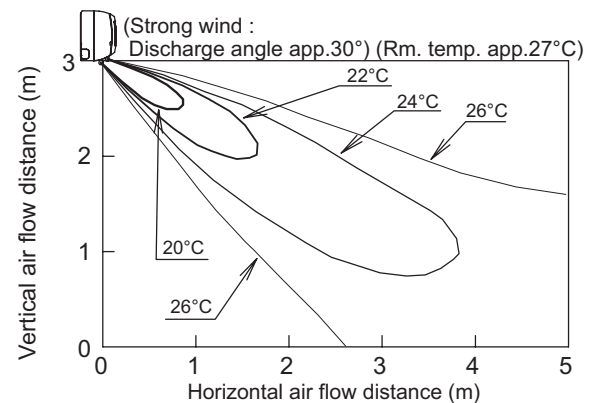
Heating : Distribution of temperature



Cooling : Distribution of wind velocity



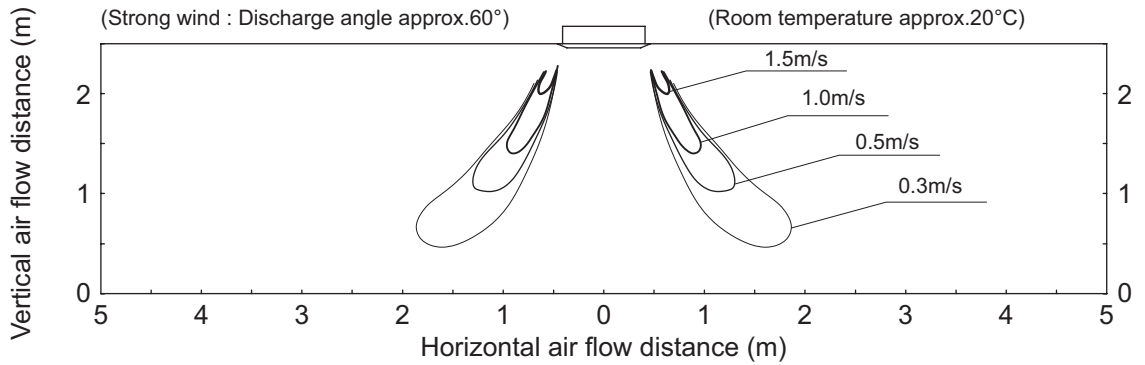
Cooling : Distribution of temperature



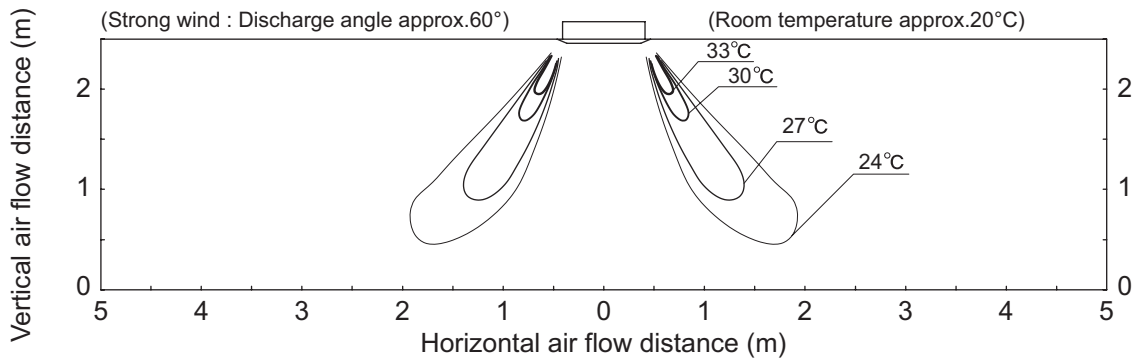
4-Way Cassette 60 x 60 (Type Y2)

S-36MY2E5A

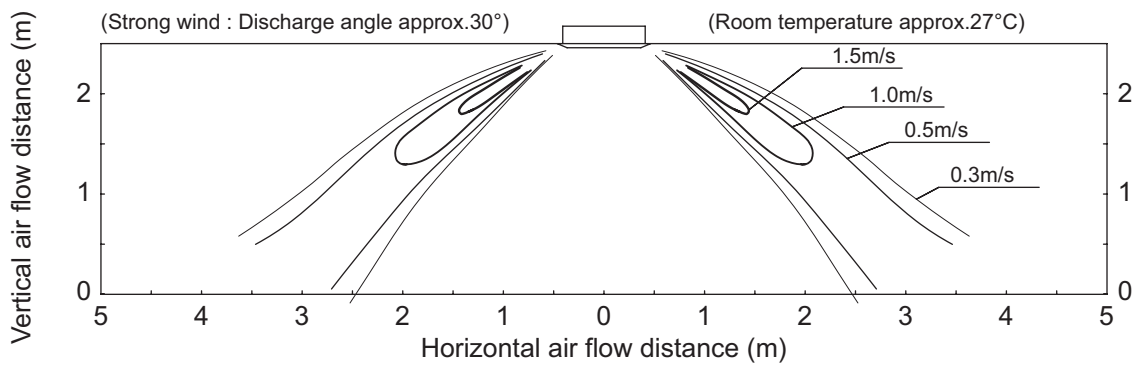
Heating : Distribution of wind velocity



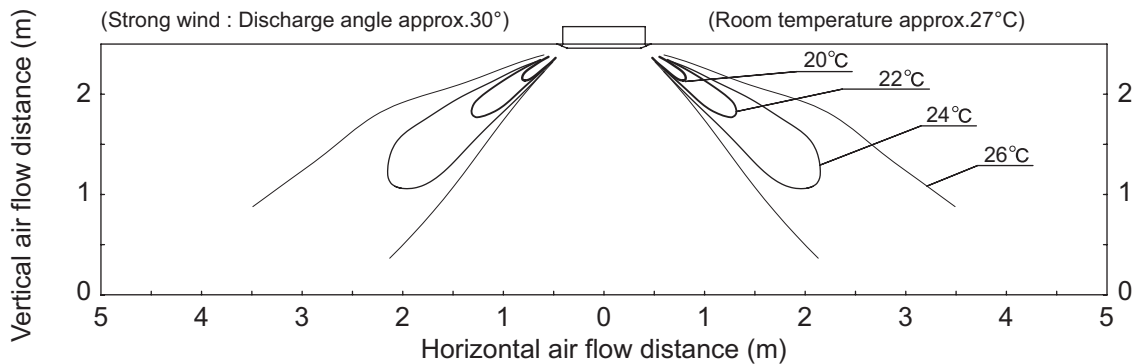
Heating : Distribution of temperature



Cooling : Distribution of wind velocity



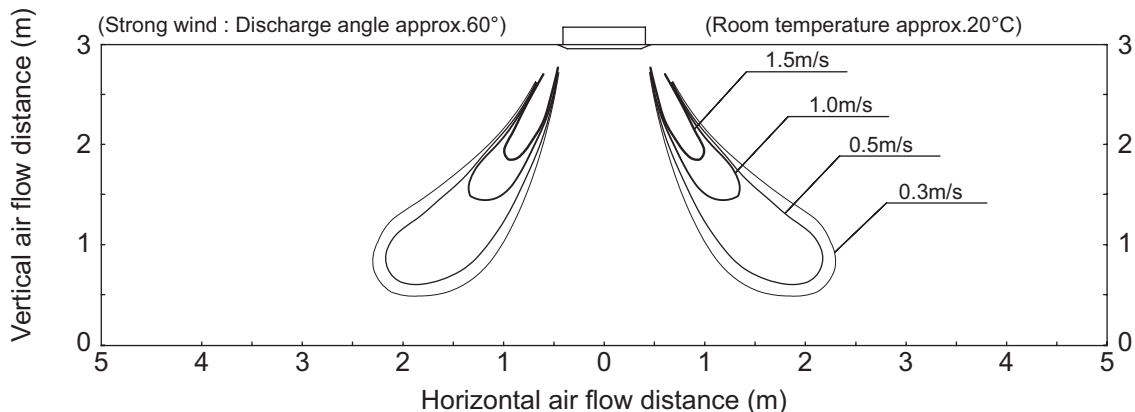
Cooling : Distribution of temperature



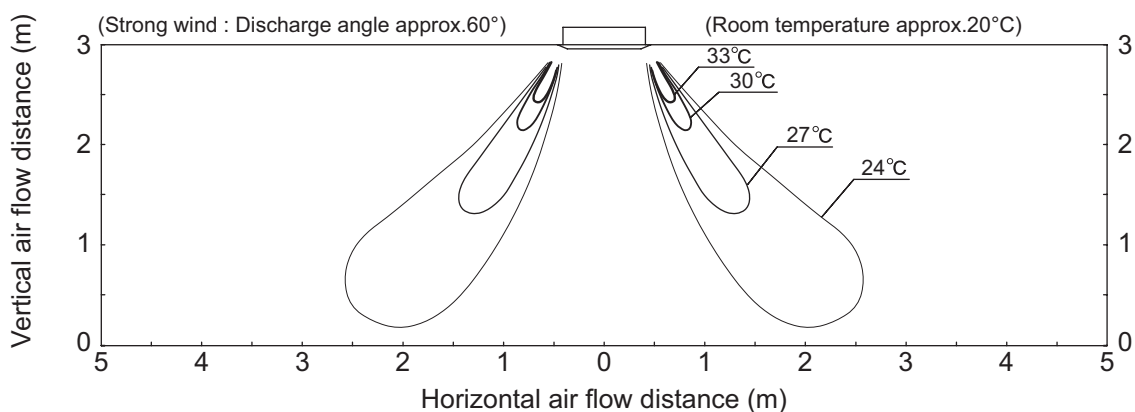
4-Way Cassette 60 x 60 (Type Y2)

S-45PY2E5A / 50PY2E5A

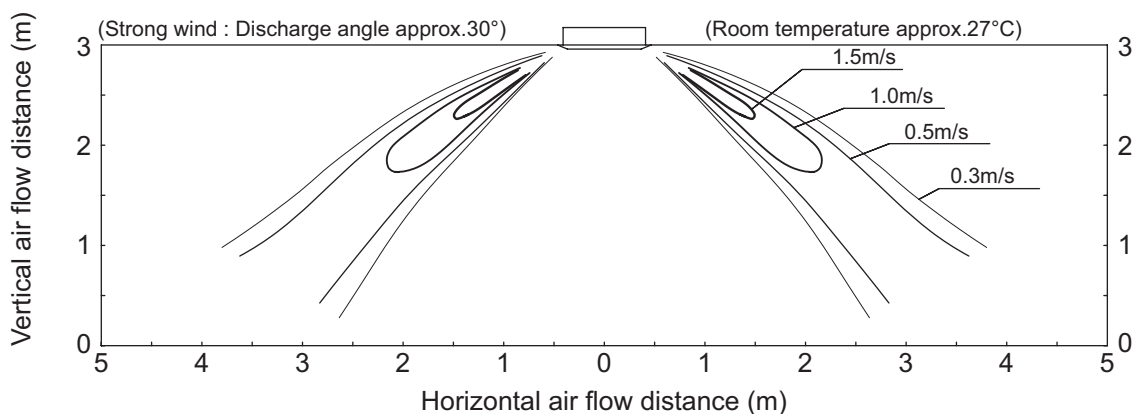
Heating : Distribution of wind velocity



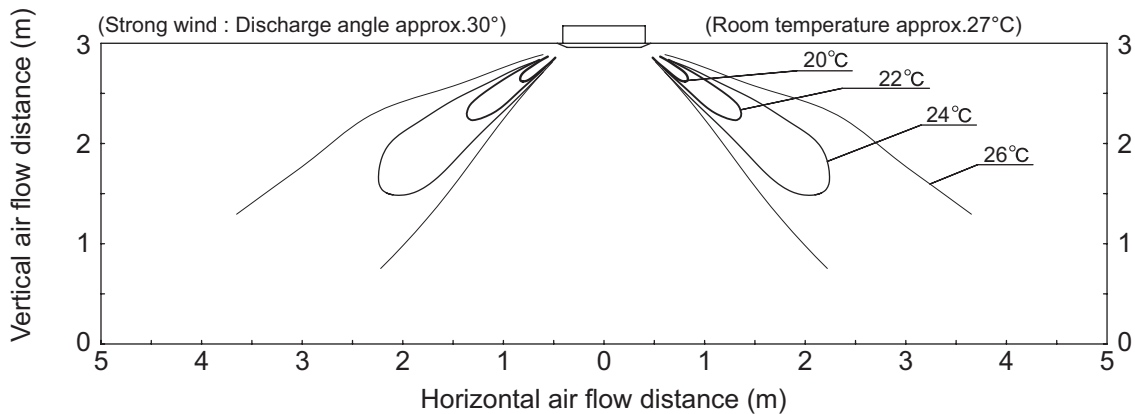
Heating : Distribution of temperature



Cooling : Distribution of wind velocity



Cooling : Distribution of temperature



## 1-9. Fresh Air Intake

### 1-9-1. Precautions Regarding External Air Intake

#### (1) Ventilation Load

Ensure that the design of the air-conditioner takes air-conditioning loads into consideration when external air intake is involved.

#### (2) Restrictions on External Air Intake

Ensure that the design conforms to the restrictions on air intake volume stipulated in accordance with the model of the indoor unit and the intake method. Consideration must also be taken to mixed air content listed in (3) below without fail.

\* If the air intake volume does not satisfy the required ventilation volume, air must be fed into the room separately with the use of a total heat exchanger or a fresh air processing air-conditioner, etc.

#### (3) Mixed Air

The amount of external air intake must be set within the scope of the unit's usage conditions when external air and internal air is mixed together. This is especially important in the following cases, in which it is necessary to either feed external air into the room after it has been processed or reduce the amount of external air that is fed in.

① When the external dew-point temperature is greater than the dry-bulb temperature of the air sucked into the unit  
Ensure that processing is performed so that the external dew-point temperature is lower than the temperature of the air sucked into the unit to prevent the risk of condensation building up.

② In the case of low external temperatures

There are cases in which the temperature of mixed air is lower than the operating range of the unit if excessive amounts of external air intake are used when the external temperature is low.

This problem is to be solved by either feeding external air into the room after it has been processed or reducing the amount of external air that is fed in.

③ When used in combination with humidifiers

External air must always be processed when the external air temperature reaches freezing point to prevent the risk of the humidifier freezing.

#### (4) Arranging Ducts and Filters in the Field

External air intake ducting must be arranged in the field.

External air filters must also be installed without fail in order to prevent the intake of dust and grit.

#### (5) Thermal Insulation for Ducts

Ensure that all external air intake ducting is heat-insulated without fail. Failure to observe this may result in the build-up of condensation.

#### (6) External Air Intake Coupling

Ensure that the design for external air intake is coupled with the fan blower operations of the indoor unit.

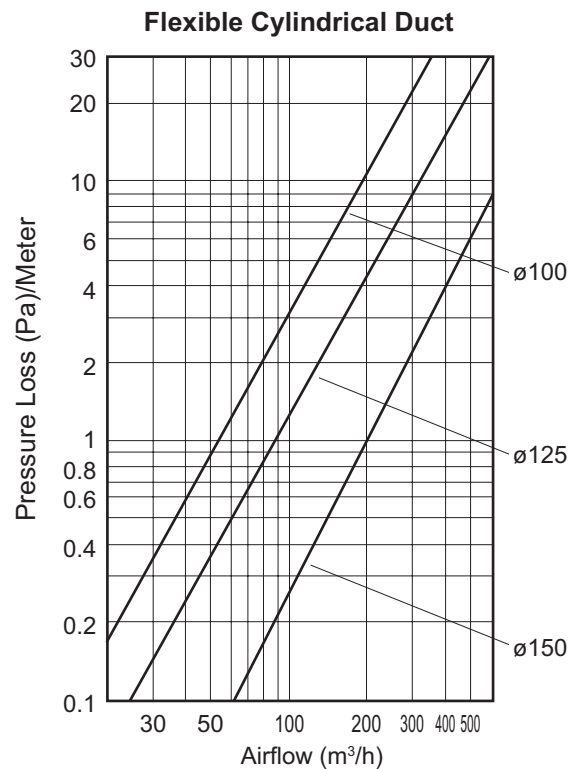
There are cases in which the dust that accumulates in the filter is blown into the room if the external air is fed from the filter. There are also cases in which the noise of external air being fed into the room can be heard from the indoor unit if external air is forcibly fed when the booster fan or other components on the indoor unit are not operating.

#### (7) Booster Fan Selection

Select the booster fan in accordance with the resistance of the external air intake duct (diagram on the pressure loss characteristics of the air flow volume for flexible cylindrical ducts) and the resistance prevalent inside the unit (external air intake volume & resistance within unit / operation noise characteristics).

#### (8) Attaching the External Air Intake Flange

Regarding the installation direction of the external air intake duct, refer to the Installation Instructions provided with the external air intake duct.



Air Flow Volume for Flexible Cylindrical Duct-Pressure Loss

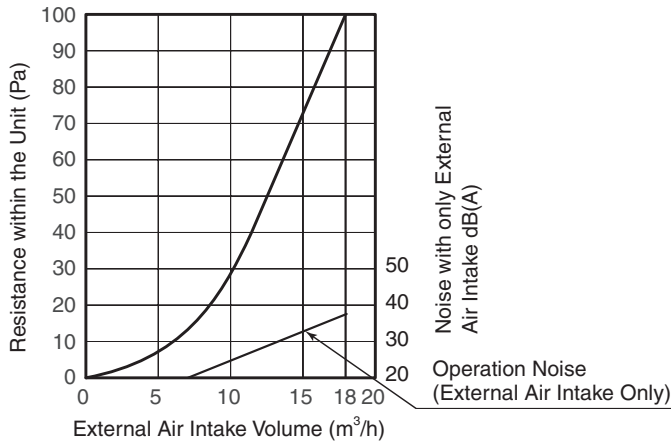


1-9-2. External Air Intake Volume & Resistance Within Unit / Operation Noise Characteristics

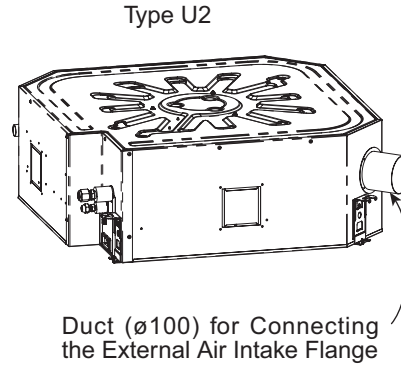
● 4-Way Cassette (Type U2)

When an External Air Intake Flange (ø100) is in Use

External Air Intake Volume and Resistance and Operation Noise Characteristics within the Unit



With the External Air Intake Flange Attached



- Calculate the operation noise when external air is being fed by combining the noise when only external air is being fed as shown in the graph for operation noise characteristics and the operation noise of the unit as stipulated in the catalogue.
- The operation noise conforms to JIS standards and constitute measurements taken in an anechoic chamber 1.5 m directly beneath the indoor unit. Under normal circumstances, the values shown here are greater owing to the effects of surrounding noise and reverberation when the unit is actually installed.

The amount of external air that is possible to feed when it is fed directly into the unit (ø100)

| Type                                 | 36 | 45 | 50 | 60 | 71 | 100 | 125 | 140 |
|--------------------------------------|----|----|----|----|----|-----|-----|-----|
| Permissible Air Intake Volume (m³/h) | 13 | 15 | 15 | 17 | 18 | 18  | 18  | 18  |

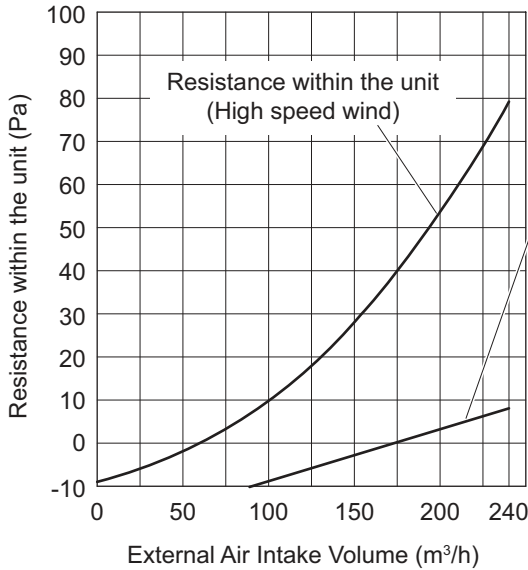
**NOTE**

The operation noise for models that use small units is lower, so use values that are within the range shown in the above table. Using values that exceed these will result in noise when only external air is fed being louder than the noise emitted from the unit.

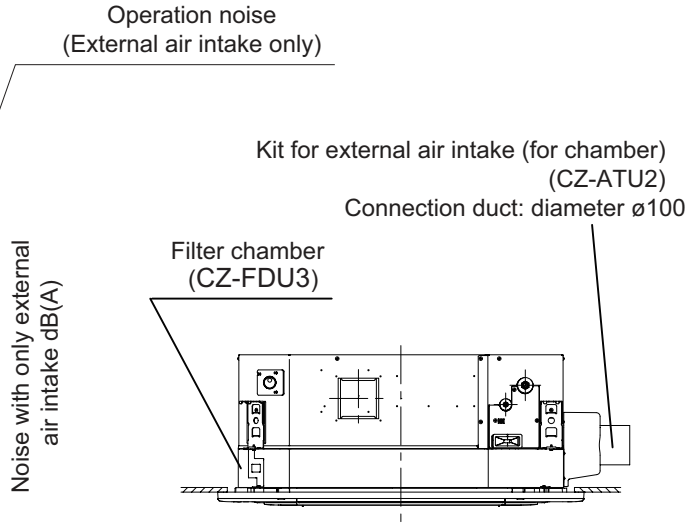


**CAUTION** Use the following diagram along with the section "1-9-1. Precautions Regarding External Air Intake"

1-9-2-1. In a Case of External Air Intake Using Air Intake Chamber (CZ-FDU3+CZ-ATU2)



**External Air Intake Volume & Resistance Within Unit/  
Operation Noise Characteristics**



**With the External Air Intake Chamber Attached**

1. Calculate the operation noise when external air is being fed by combining the noise when only external air is being fed as shown in the diagram for operation noise characteristics and the operation noise of the unit as stipulated in the catalogue.
2. The operation noise conforms to JIS standards and constitute measurements taken in an anechoic chamber 1.5m directly below the indoor unit. Under normal circumstances, the diagram shown above is greater owing to the effects of surrounding noise and reverberation when the unit is actually installed.

The amount of external air that is possible to feed when external air intake chamber is in use (CZ-FDU3+CZ-ATU2)

| Type                                 | 36  | 45  | 50  | 60  | 71  | 100 | 125 | 140 |
|--------------------------------------|-----|-----|-----|-----|-----|-----|-----|-----|
| Permissible air intake volume (m³/h) | 180 | 180 | 180 | 190 | 240 | 240 | 240 | 240 |

\* The operation noise for models that use small units is lower, so use values that are within the range shown in the above table. Using values that exceed these will result in noise when only external air is fed being louder than the noise emitted from the unit.

● Sample selection of booster fans

In a case of necessity at 200m³/h of external air intake:

1. Resistance within the unit      Diagram from "Resistance within the unit"    55 Pa
2. Duct resistance in case of duct with 4m length

Duct resistance      Diagram from "Air Flow Volume for Flexible Cylindrical Duct-Pressure Loss"      40 Pa    (=10 Pa/m x 4m)

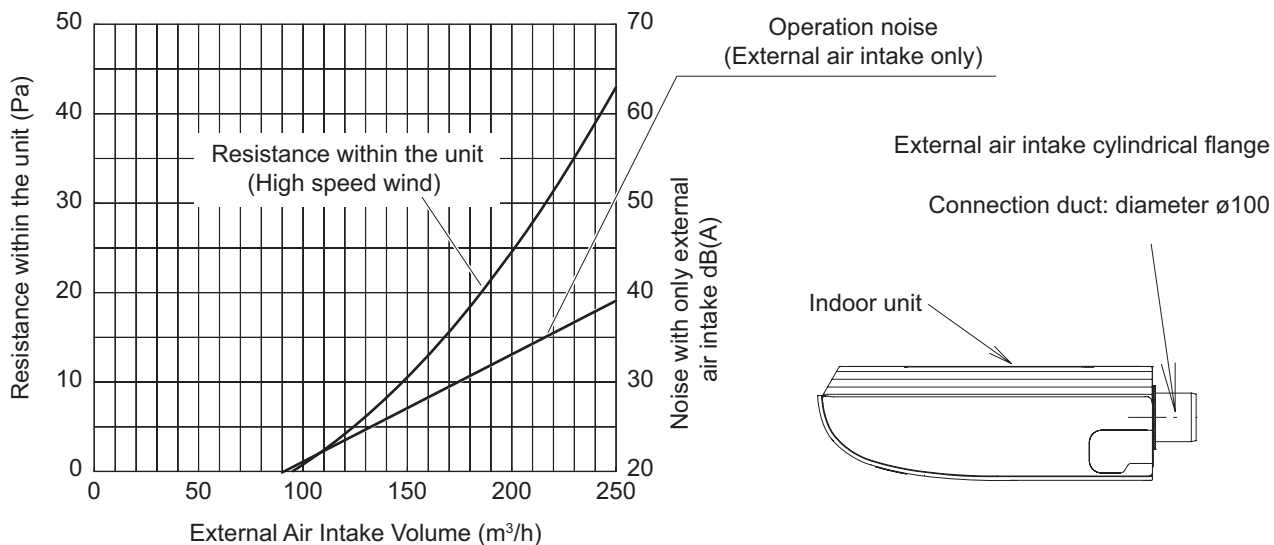
Total 95 Pa

Therefore, a booster is required to save a total 95 Pa of static pressure.

1-9-2. External Air Intake Volume & Resistance Within Unit / Operation Noise Characteristics (continued)

● Ceiling (Type T2)

1-9-2-1. In a Case of External Air Intake to Unit Directly (Using external air intake cylindrical flange)



External Air Intake Volume & Resistance Within Unit/  
Operation Noise Characteristics

With the External Air Intake Flange Attached

1. Calculate the operation noise when external air is being fed by combining the noise when only external air is being fed as shown in the diagram for operation noise characteristics and the operation noise of the unit as stipulated in the catalogue.
2. The operation noise conforms to JIS standards and constitute measurements taken in an anechoic chamber 1m front and 1m below the indoor unit. Under normal circumstances, the diagram shown above is greater owing to the effects of surrounding noise and reverberation when the unit is actually installed.

The amount of external air intake that is possible to feed when it is fed directly into the unit

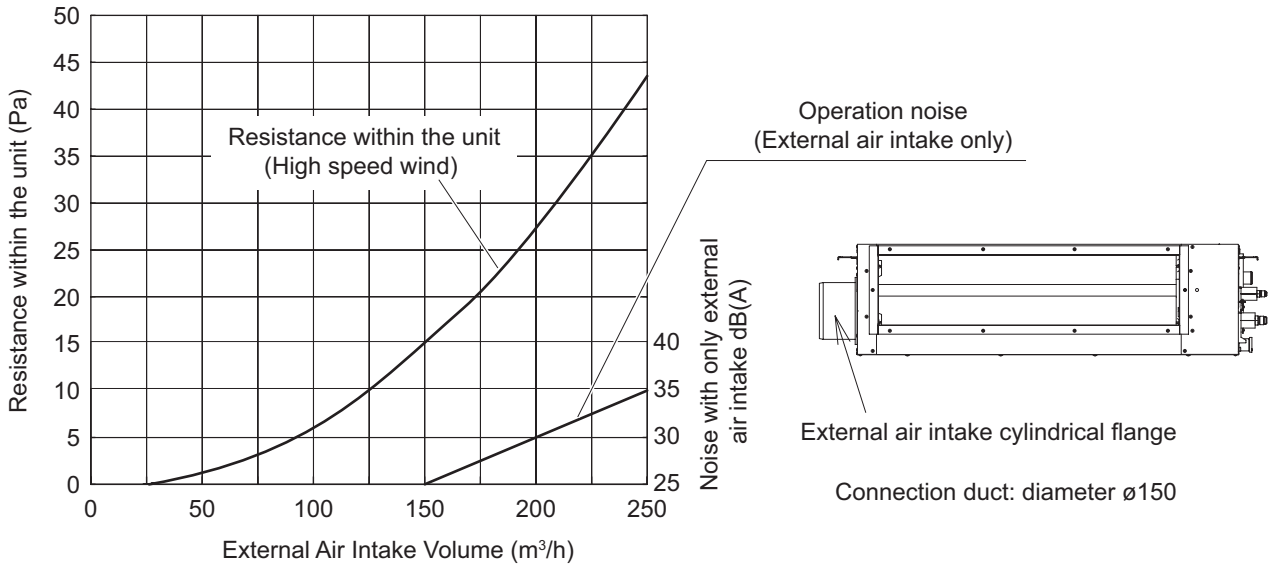
| Type                                 | 36  | 45  | 50  | 60  | 71  | 100 | 125 | 140 |
|--------------------------------------|-----|-----|-----|-----|-----|-----|-----|-----|
| Permissible air intake volume (m³/h) | 160 | 170 | 170 | 200 | 210 | 240 | 240 | 240 |

\* The operation noise for models that use small units is lower, so use values that are within the range shown in the above table. Using values that exceed these will result in noise when only external air is fed being louder than the noise emitted from the unit.

**1-9-2. External Air Intake Volume & Resistance Within Unit / Operation Noise Characteristics (continued)**

**● Low Silhouette Ducted (Type F1)**

1-9-2-2. In a Case of External Air Intake to Unit Directly (Using external air intake cylindrical flange)



**External Air Intake Volume & Resistance Within Unit/  
Operation Noise Characteristics**

**With the External Air Intake Flange Attached**

1. Calculate the operation noise if external air is being fed by combining the noise when only external air is being fed as shown in the diagram for operation noise characteristics and the operation noise of the unit as stipulated in the catalogue.
2. The operation noise conforms to JIS standards and constitute measurements taken in an anechoic chamber 1.5m directly below the indoor unit. Under normal circumstances, the diagram shown above is greater owing to the effects of surrounding noise and reverberation when the unit is actually installed.

The amount of external air intake that is possible to feed when it is fed directly into the unit

| Type                                 | 36  | 45  | 50  | 60  | 71  | 100 | 125 | 140 |
|--------------------------------------|-----|-----|-----|-----|-----|-----|-----|-----|
| Permissible air intake volume (m³/h) | 126 | 126 | 150 | 180 | 180 | 240 | 240 | 240 |

\* The operation noise for models that use small units is lower, so use values that are within the range shown in the above table. Using values that exceed these will result in noise when only external air is fed being louder than the noise emitted from the unit.

**● 4-Way Cassette 60×60 (Type Y2)**

1-9-2-3. In a Case of External Air Intake to Unit Directly (Using external air intake cylindrical flange (ø80))

- Calculate the operation noise if external air is being fed by combining the noise when only external air is being fed and the operation noise of the unit as stipulated in the catalogue.
- The operation noise conforms to JIS standards and constitute measurements taken in an anechoic chamber 1.5m directly beneath the indoor unit. Under normal circumstances, the values shown here are greater owing to the effects of surrounding noise and reverberation when the unit is actually installed.

The amount of external air that is possible to feed when it is fed directly into the unit (ø80)

| Type                                 | 36 | 45 | 50 |
|--------------------------------------|----|----|----|
| Permissible Air Intake Volume (m³/h) | 10 | 10 | 10 |

**NOTE**

Using values that exceed these will result in noise when only external air is fed being louder than the noise emitted from the unit.

## 1-10. Electrical Wiring

- U-36PE2E5A, U-50PE2E5A, U-60PE2E5A  
U-60PEY2E5, U71PEY2E5

### ■ General Precautions on Wiring

- (1) Before wiring, confirm the rated voltage of the unit as shown on its nameplate, then carry out the wiring closely following the wiring diagram.



- (2) This equipment is strongly recommended to be installed with Earth Leakage Circuit Breaker (ELCB) or Residual Current Device (RCD). Otherwise, it may cause electrical shock and fire in case of equipment breakdown or insulation breakdown. Earth Leakage Circuit Breaker (ELCB) must be incorporated in the fixed wiring in accordance with the wiring regulations. The Earth Leakage Circuit Breaker (ELCB) must be an approved 10-16 A, having a contact separation in all poles.
- (3) To prevent possible hazards from insulation failure, the unit must be grounded.
- (4) Each wiring connection must be done in accordance with the wiring system diagram. Wrong wiring may cause the unit to disorder or become damaged.
- (5) Do not allow wiring to touch the refrigerant tubing, compressor, or any moving parts of the fan.
- (6) Unauthorized changes in the internal wiring can be very dangerous. The manufacturer will accept no responsibility for any damage or malfunction that occurs as a result of such unauthorized changes.
- (7) Regulations on wire diameters differ from locality to locality. For field wiring rules, please refer to your LOCAL ELECTRICAL CODES before beginning.  
You must ensure that installation complies with all relevant rules and regulations.
- (8) To prevent malfunction of the air conditioner caused by electrical noise, care must be taken when wiring as follows:
  - The remote control wiring and the inter-unit control wiring should be wired apart from the inter-unit power wiring.
  - Use shielded wires for inter-unit control wiring between units and ground the shield on both sides.
- (9) If the power supply cord of this appliance is damaged, it must be replaced by a repair shop designated by the manufacturer, because special-purpose tools are required.

### ■ Recommended Wire Length and Wire Diameter for Power Supply System

#### Outdoor unit

|            | (A) Power supply    |             | Time delay fuse or circuit capacity | (A) Power supply  |             | Time delay fuse or circuit capacity | Ssc      |
|------------|---------------------|-------------|-------------------------------------|-------------------|-------------|-------------------------------------|----------|
|            | Wire size           | Max. length |                                     | Wire size         | Max. length |                                     |          |
| U-36PE2E5A | 2.5 mm <sup>2</sup> | 22 m        | 20 A                                | 4 mm <sup>2</sup> | 35 m        | 20 A                                | *1       |
| U-50PE2E5A | 2.5 mm <sup>2</sup> | 22 m        | 20 A                                | 4 mm <sup>2</sup> | 35 m        | 20 A                                | *1       |
| U-60PE2E5A | 2.5 mm <sup>2</sup> | 17 m        | 25 A                                | 4 mm <sup>2</sup> | 27 m        | 25 A                                | 2893 kVA |
| U-60PEY2E5 | 2.5 mm <sup>2</sup> | 17 m        | 25 A                                | 4 mm <sup>2</sup> | 27 m        | 25 A                                | 2893 kVA |
| U-71PEY2E5 | 2.5 mm <sup>2</sup> | 17 m        | 25 A                                | 4 mm <sup>2</sup> | 27 m        | 25 A                                | 2893 kVA |

\*1 U-36PE2E5A and U-50PE2E5A meet the technical requirements of EN/IEC 61000-3-2.

#### Indoor unit

| Type               | (B) Power supply    | Time delay fuse or circuit capacity |
|--------------------|---------------------|-------------------------------------|
|                    | 2.5 mm <sup>2</sup> |                                     |
| K1                 | Max. 150 m          | 10-16 A                             |
| U2, Y2, T2, F1, N1 | Max. 130 m          | 10-16 A                             |

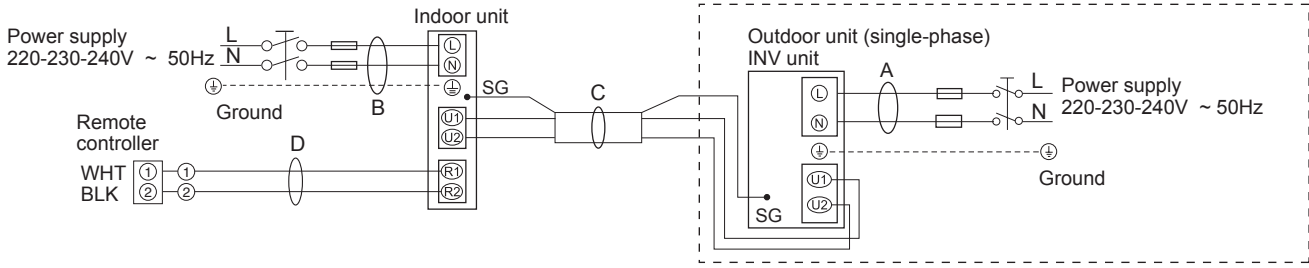
#### Control wiring

| (C) Inter-unit (between outdoor and indoor units) control wiring | (D) Remote control wiring                             |
|--|---|
| 0.75 mm <sup>2</sup> (AWG #18)<br>Use shielded wiring*1          | 0.75 mm <sup>2</sup> (AWG #18)<br>Use shielded wiring |
| Max. 1,000 m   | Max. 500 m  |

#### NOTE

\*1 With ring-type wire terminal.

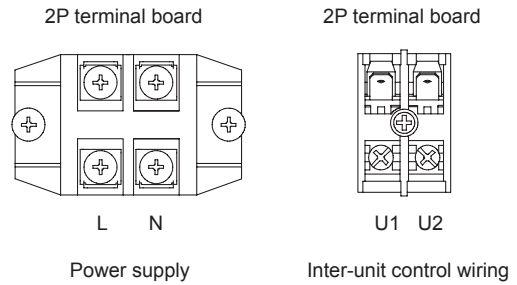
## ■ Wiring System Diagrams



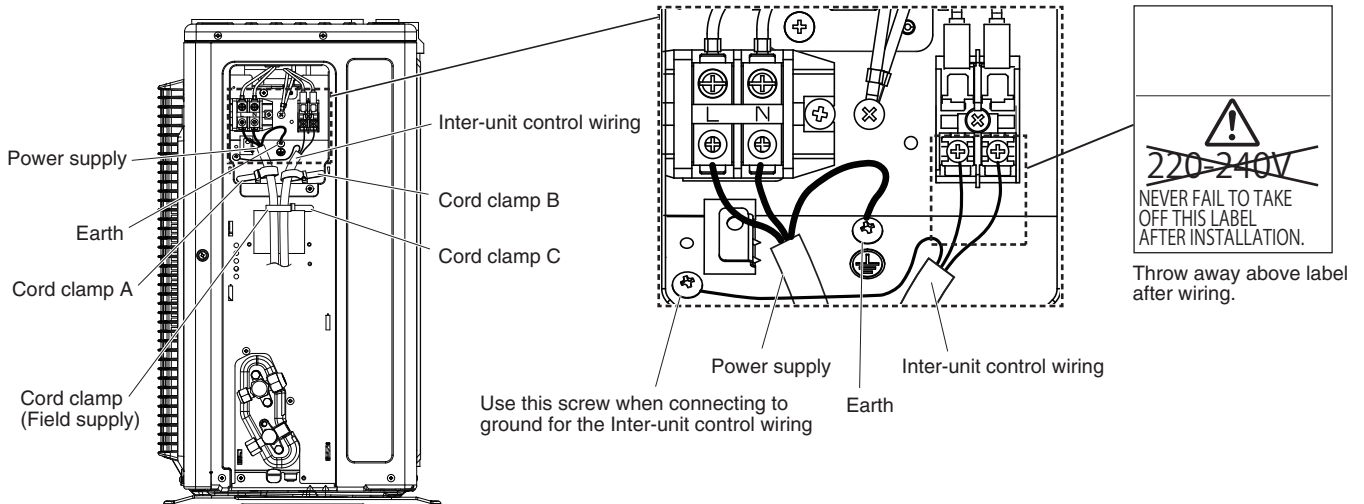
(SG : Shows the ground for the shielded cable.)

### NOTE

- (1) See the section “■ Recommended Wire Length and Wire Diameter for Power Supply System” for the explanation of “A”, “B”, “C” and “D” in the above diagrams.
- (2) The basic connection diagram of the indoor unit shows the terminal board, so the terminal boards in your equipment may differ from the diagram.
- (3) Refrigerant Circuit (R.C.) address should be set before turning the power on.
- (4) Regarding R.C. address setting, refer to the installation instructions supplied with the remote controller unit (Optional). Auto address setting can be executed by remote controller automatically. Refer to the installation instructions supplied with the remote controller unit (optional).



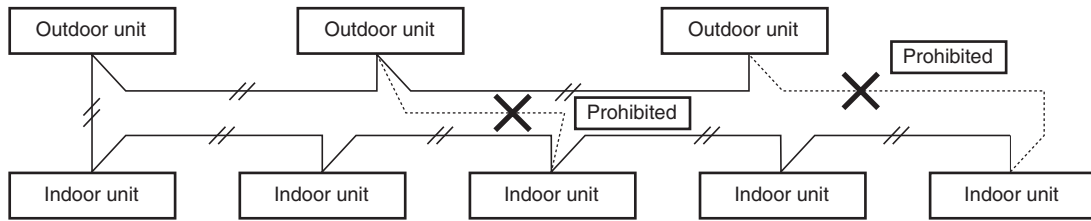
### ■ Wiring sample



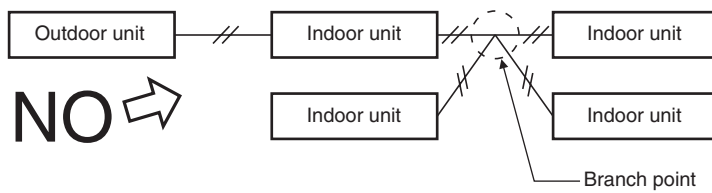


**CAUTION**

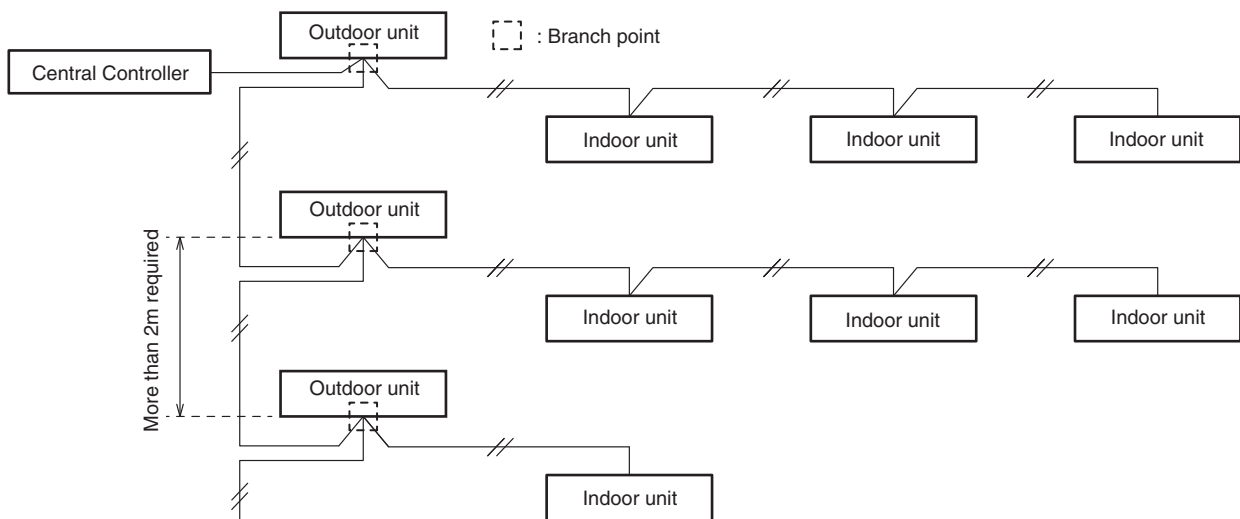
- (1) When linking the outdoor units in a network, disconnect the terminal extended from the short plug from all outdoor units except any one of the outdoor units.  
(When shipping: In shorted condition.)  
For a system without link (no wiring connection between outdoor units), do not remove the short plug.
- (2) Do not install the inter-unit control wiring in a way that forms a loop.



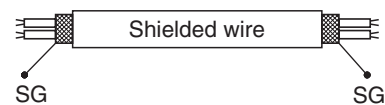
- (3) Do not install inter-unit control wiring such as star branch wiring. Star branch wiring causes mis-address setting.



- (4) If branching the inter-unit control wiring, the number of branch points should be 16 or fewer.



- (5) Use shielded wires for inter-unit control wiring (C) and ground the shield on both sides, otherwise misoperation from noise may occur. Connect wiring as shown in Section "■ Wiring System Diagrams".



- (6) Use the standard power supply cables for Europe (such as H05RN-F or H07RN-F which conform to CENELEC (HAR) rating specifications) or use the cables based on IEC standard. (60245 IEC57, 60245 IEC66)
- Connecting cable between indoor unit and outdoor unit shall be approved polychloroprene sheathed 5 or 3 \*1.5 mm<sup>2</sup> flexible cord. Type designation 60245 IEC 57 (H05RN-F, GP85PCP etc.) or heavier cord.



**WARNING**

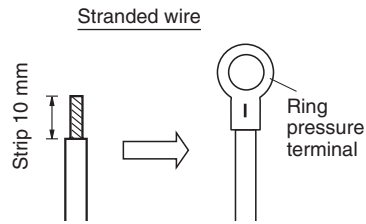
Loose wiring may cause the terminal to overheat or result in unit malfunction. A fire hazard may also occur. Therefore, ensure that all wiring is tightly connected.

When connecting each power wire to the terminal, follow the instructions on "How to connect wiring to the terminal" and fasten the wire securely with the terminal screw.

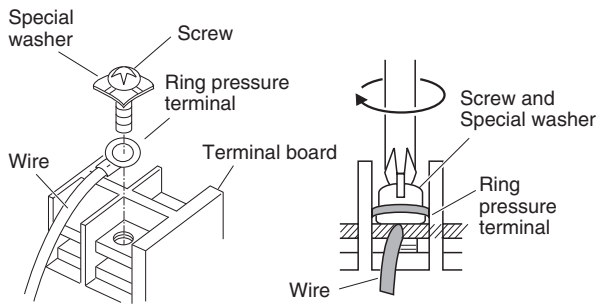
## How to connect wiring to the terminal

### ■ For stranded wires

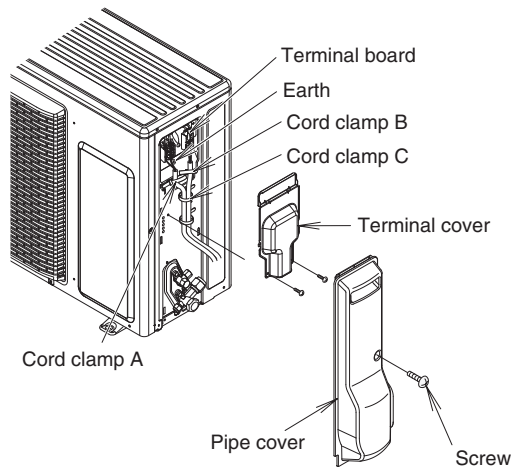
- (1) Cut the wire end with cutting pliers, then strip the insulation to expose the stranded wire about 10 mm and tightly twist the wire ends.



- (2) Using a Phillips head screwdriver, remove the terminal screw(s) on the terminal board.  
 (3) Using a ring connector fastener or pliers, securely clamp each stripped wire end with a ring pressure terminal.  
 (4) Put the removed terminal screw through the ring pressure terminal and then replace and tighten the terminal screw using a screwdriver.




### ■ Assembling parts for outdoor unit cover





■ U-71PE1E5A ~ U-140PE1E5A, U-71PE1E8A ~ U-140PE1E8A  
 U-100PEY1E5, U-125PEY1E5, U-100PEY1E8, U-125PEY1E8, U-140PEY1E8

**ELECTRICAL WIRING**

|                  |   |
|------------------|---|
| <b>⚠ WARNING</b> | This air conditioner must be installed in accordance with national wiring regulations.  |
|                  | Cables connected to outdoor unit must be approved polychloroprene sheathed type 60245 IEC 57 or H05RN-F/H07RN-F or heavier.   |
|                  | The units must be connected to the supply cables for fixed wiring by qualified technician. Circuit breaker must be incorporated in the fixed wiring in accordance with the national wiring regulations. The circuit breaker must be approved, suitable for the voltage and current ratings of equipment and have a contact separation by 3mm in all poles. When the supply cable is damaged, it must be replaced by qualified technician. |
|                  | Be sure to install a current leakage breaker, main switch and fuse to the main power supply, otherwise electric shocks may result.  |
|                  | Be sure to connect the unit to secure earth connection. If the earthing work is not carried out properly, electric shocks may result.    |
|                  | Wiring shall be connected securely by using specified cables and fix them securely so that external force of the cables may not transfer to the terminal connection section. Imperfect connection and fixing leads to fire, etc.  |

- Ensure to connect the electrical cable connections and clamp the wires securely to the terminal connections using cord clamps so that no undue force is placed on the wires (power source cable, indoor/outdoor connection cables, earth lead wire).
- Do not install a phase advance capacitor for power factor improvement. (It does not improve the power factor and will cause abnormal overheating.)
- Do not bind the excess cables together and place them inside this unit.
- Protect the electrical cable with the protective bushing provided so that the cables do not get damaged on the knock hole or etched portions. If there is space between the electrical cables and the protective bushing occurs, seal it accordingly.
- Tie the cables with the provided binding strap so that they do not touch the compressor and the pipes.
- When setting up the cables, inside of unit install properly so that the front panel will not lift up. Make sure that front panel mount correctly.
- Use a round type terminal with an insulation sleeve for connecting to the terminal block.
- Use the appropriate screwdriver for tightening the terminal screws. Small sized screwdriver damages the head of the screw and cannot tighten it properly.
- There is risk of damaging the screw if the terminal screw is over tightened. Tighten with the appropriate torque.

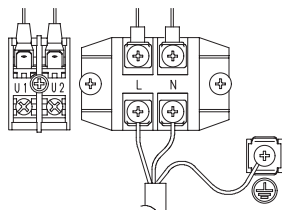
| Screw diameter name | Tightening torque N•m {kgf•m} |
|---------------------|-------------------------------|
| M4                  | 1.57 ~ 1.96 {0.16 ~ 0.2}      |
| M5                  | 1.96 ~ 2.45 {0.2 ~ 0.25}      |

- Direction to pull out wires

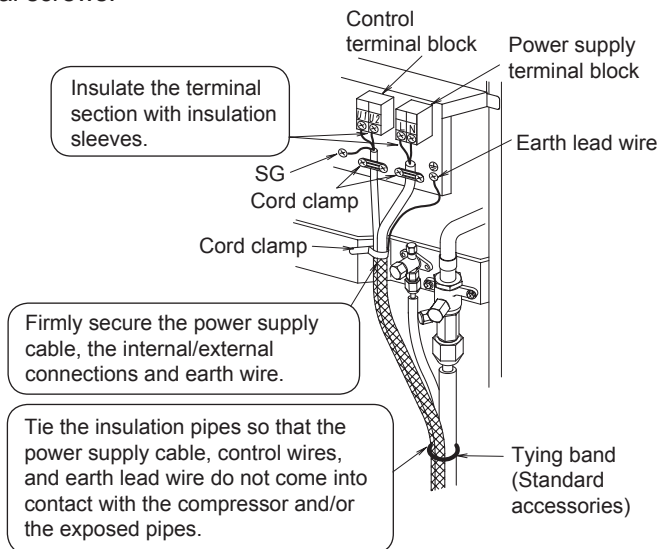


Seal wiring holes after wiring using included protection bush. (other holes are for connecting conduit pipe)

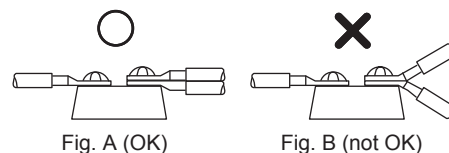
- Earth lead wire set up



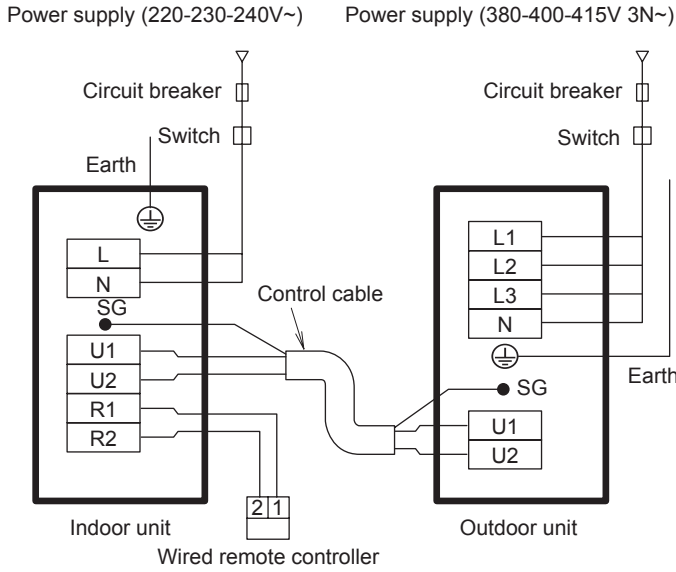
The earth lead wire shall be longer than other lead wires as shown in the figure for electrical safety in case it slips out of the cord from the anchorage.



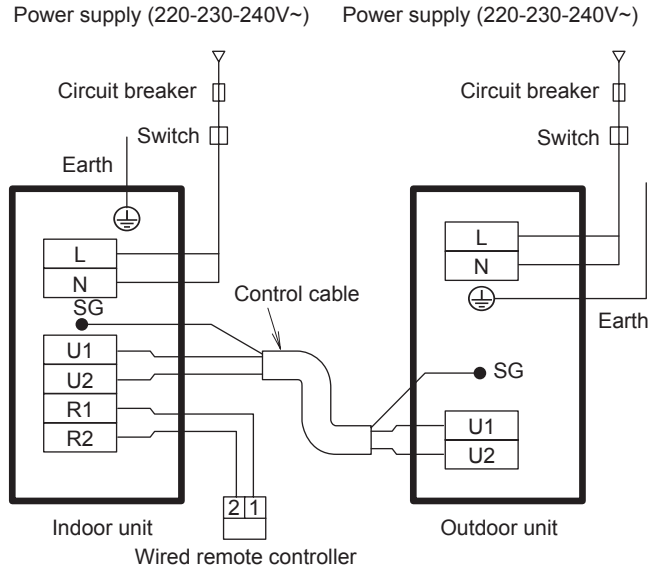
- Be sure to connect the wires correctly to terminal board with connecting the crimp type ring terminal to the wires.
- If connecting two separate wires to a single crimped terminal, place the two crimped terminal wires together as shown in Fig. A. (If the arrangement shown in Fig. B is used, poor contacts or contact damage may result.)



OUTDOOR UNIT/3-PHASE MODEL



OUTDOOR UNIT/SINGLE-PHASE MODEL



This equipment complies with EN/IEC 31000-3-12 provided that the short-circuit power  $S_{sc}$  is greater than or equals to \*2 kVA at the interface point between the user's supply and the public system. It is the responsibility of the installer or user of the equipment to ensure; by consultation with the distribution network operator if necessary that the equipment is connected only to supply with a short-circuit power  $S_{sc}$  greater than or equals to \*2 kVA.

$S_{sc}$ : Short circuit power

SG : Shows the earth for the shielded cable.

| Model name  | Power supply (single-phase) | Maximum electric current (A) | *1 Control cable (mm <sup>2</sup> ) | *2 $S_{sc}$ (kVA) | Model name  | Power supply (3N~) | Maximum electric current (A) | *1 Control cable (mm <sup>2</sup> ) | *2 $S_{sc}$ (kVA) |
|-------------|-----------------------------|------------------------------|-------------------------------------|-------------------|-------------|--------------------|------------------------------|-------------------------------------|-------------------|
| U-71PE1E5A  | 220-230-240V~               | 18                           | 0.75                                | 4050              | U-71PE1E8A  | 380-400-415V       | 7                            | 0.75                                | *3                |
| U-100PE1E5A | 220-230-240V~               | 25                           | 0.75                                | 6000              | U-100PE1E8A | 380-400-415V       | 9                            | 0.75                                | *3                |
| U-125PE1E5A | 220-230-240V~               | 28                           | 0.75                                | 6000              | U-125PE1E8A | 380-400-415V       | 10                           | 0.75                                | *3                |
| U-140PE1E5A | 220-230-240V~               | 30                           | 0.75                                | 6000              | U-140PE1E8A | 380-400-415V       | 11                           | 0.75                                | *3                |
| U-100PEY1E5 | 220-230-240V~               | 25                           | 0.75                                | 5200              | U-100PEY1E8 | 380-400-415V       | 9                            | 0.75                                | *3                |
| U-125PEY1E5 | 220-230-240V~               | 29                           | 0.75                                | 5800              | U-125PEY1E8 | 380-400-415V       | 10                           | 0.75                                | *3                |
|             |                             |                              |                                     |                   | U-140PEY1E8 | 380-400-415V       | 10                           | 0.75                                | *3                |

\*1 Use a shielded cable for the control cable. Overall extension less than 500m

\*3 The following models are intended for professional use.

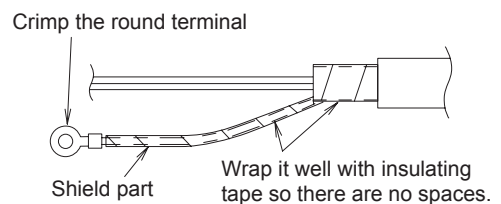
U-71PE1E8A, U-100PE1E8A, U-125PE1E8A, U-140PE1E8A, U-100PEY1E8, U-125PEY1E8, U-140PEY1E8

Consult with the supply utility for permission of electrical connection.

- Decide the length and size of the power supply cable based on the maximum ampere tabulated above in accordance with the national wiring regulations.
- Select the fuse(s) and/or circuit breaker(s) from the types and ratings suitable for the maximum ampere tabulated above in accordance with the national wiring regulations.
- If capacity of power supply circuit and enforcement are not enough, it can causes the electric shock and a fire.

For the shield part of the shielded cable, twist the end out, crimp it with a round terminal, and connect it to the SG screw. After crimping it with a round terminal, wrap it with insulating tape so there are no spaces and adjust it so the shield part does not touch any live parts.

**CAUTION** Be sure that the shield part of the shielded cable does not touch the terminal block or any live parts. Failure to do so may lead to electric shock or fire.



## Electrical Wiring

### ■ General Precautions on Wiring

- (1) Before wiring, confirm the rated voltage of the unit as shown on its nameplate, then carry out the wiring closely following the wiring diagram.
- (2) Provide a power outlet to be used exclusively for each unit and a circuit breaker for overcurrent protection should be provided in the exclusive line.
- (3) To prevent possible hazards from insulation failure, the unit must be grounded.
- (4) Each wiring connection must be done in accordance with the wiring system diagram. Wrong wiring may cause the unit to misoperate or become damaged.
- (5) Do not allow wiring to touch the refrigerant tubing, compressor, or any moving parts of the fan.
- (6) Unauthorized changes in the internal wiring can be very dangerous. The manufacturer will accept no responsibility for any damage or misoperation that occurs as a result of such unauthorized changes.
- (7) Regulations on wire diameters differ from locality to locality. For field wiring rules, please refer to your LOCAL ELECTRICAL CODES before beginning.

You must ensure that installation complies with all relevant rules and regulations.

- (8) To prevent malfunction of the air conditioner caused by electrical noise, care must be taken when wiring as follows:
  - The remote control wiring and the inter-unit control wiring should be wired apart from the inter-unit power wiring.
  - Use shielded wires for inter-unit control wiring between units and ground the shield on both sides.
- (9) If the power supply cord of this appliance is damaged, it must be replaced by a repair shop designated by the manufacturer, because special-purpose tools are required.



**CAUTION** Check local electrical codes and regulations before wiring. Also, check any specified instruction or limitations.

### ■ Recommended Wire Length and Wire Diameter for Power Supply System

#### Indoor unit

| Type | (B) Power supply    | Time delay fuse or circuit capacity |
|------|---------------------|-------------------------------------|
|      | 2.5 mm <sup>2</sup> |                                     |
| U2   | Max. 130 m          | 10-16 A                             |
| Y2   | Max. 130 m          | 10-16 A                             |

#### Indoor unit

| Type   | (B) Power supply    | Time delay fuse or circuit capacity |
|--------|---------------------|-------------------------------------|
|        | 2.5 mm <sup>2</sup> |                                     |
| K1     | Max. 150 m          | 10A                                 |
| F1     | Max. 130 m          | 10A                                 |
| T2, N1 | Max. 130 m          | 10-16A                              |

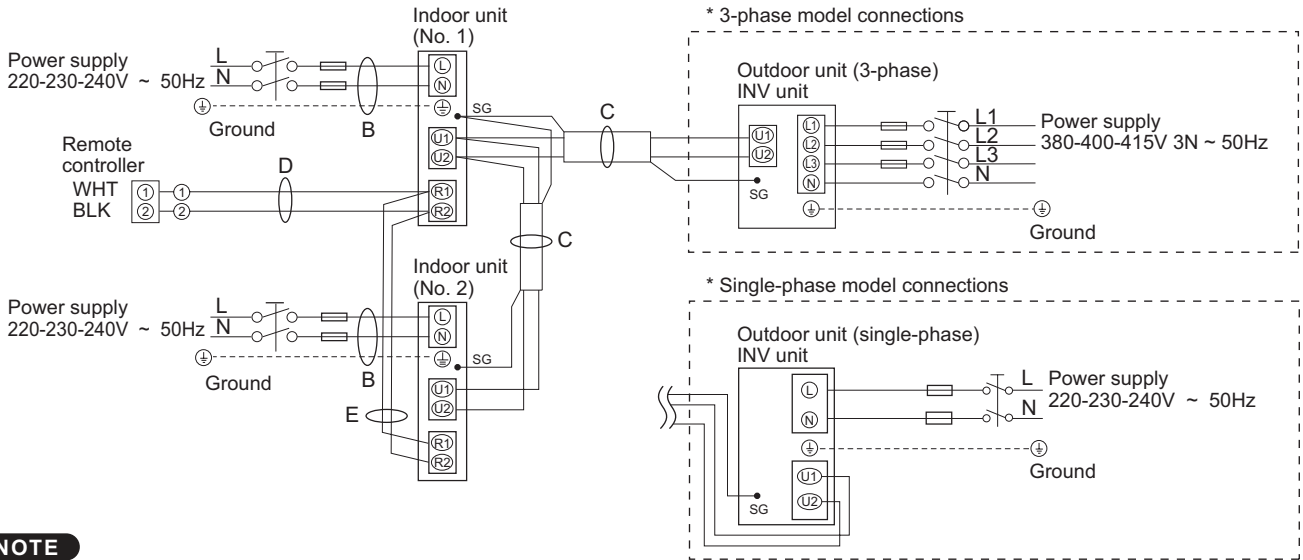
#### Control wiring

| (C) Inter-unit (between outdoor and indoor units) control wiring | (D) Remote control wiring      | (E) Control wiring for group control |
|--|--------------------------------|--------------------------------------|
| 0.75 mm <sup>2</sup> (AWG #18)<br>Use shielded wiring*           | 0.75 mm <sup>2</sup> (AWG #18) | 0.75 mm <sup>2</sup> (AWG #18)       |
| Max. 1,000 m   | Max. 500 m                     | Max. 200 m (Total)                   |

**NOTE**

\* With ring-type wire terminal.

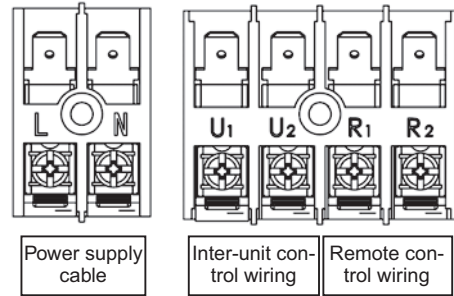
■ Wiring System Diagrams



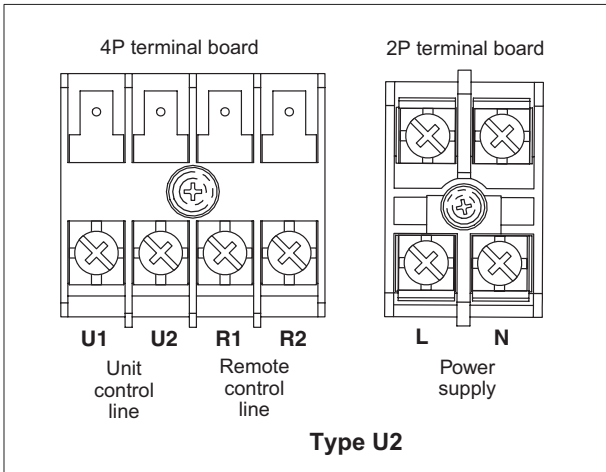
**NOTE**

- (1) Refer to “Recommended Wire Length and Wire Diameter for Power Supply System” for the explanation of “B”, “C”, “D” and “E” in the above diagram.
- (2) The basic connection diagram of the indoor unit shows the terminal boards, so the terminal boards in your equipment may differ from the diagram.
- (3) Refrigerant Circuit (R.C.) address should be set before turning the power on.
- (4) Regarding R.C. address setting, refer to the installation instructions supplied with the remote controller (optional). Auto address setting can be executed by remote controller automatically. Refer to the installation instructions supplied with the remote controller (optional).

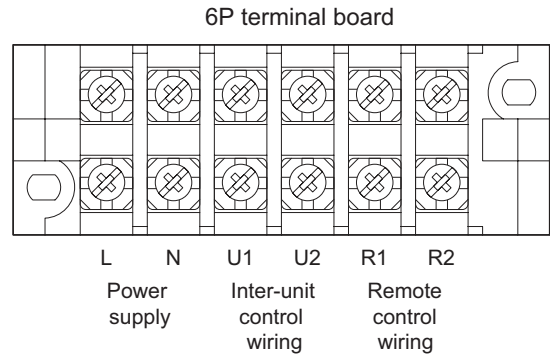
Terminal Board



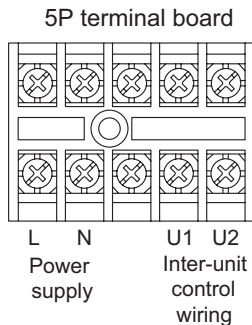
**Type Y2**



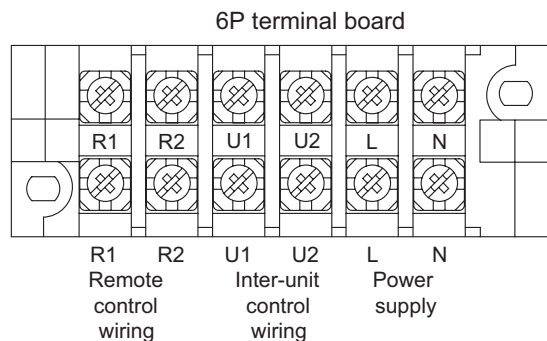
**Type U2**



**Type T2, F1**



**Type K1**

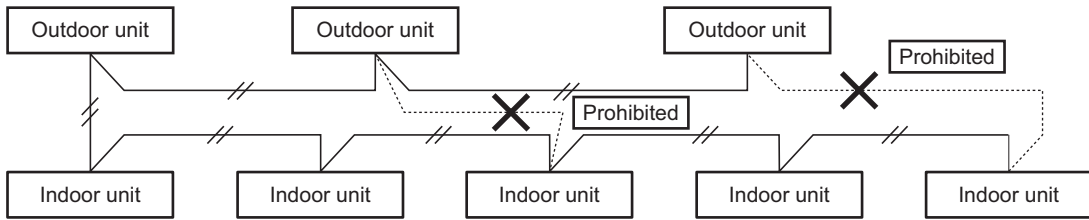


**Type N1**

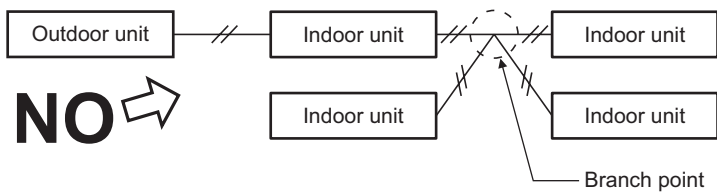


**CAUTION**

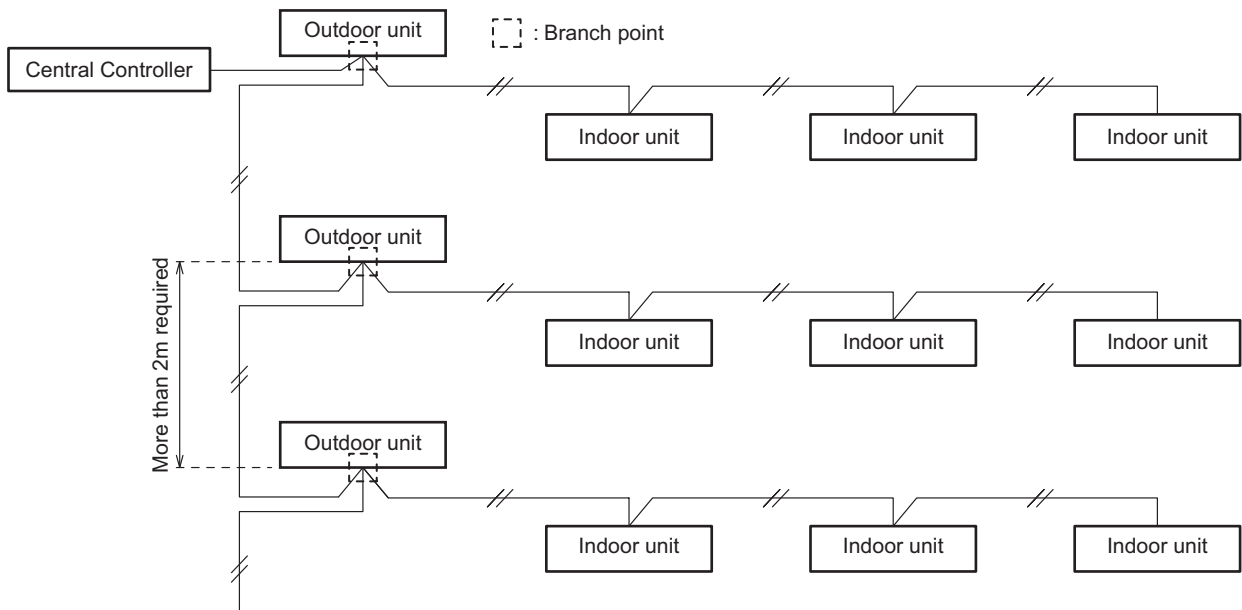
- (1) When linking the outdoor units in a network, disconnect the terminal extended from the short plug from all outdoor units except any one of the outdoor units.  
(When shipping: In shorted condition.)  
For a system without link (no wiring connection between outdoor units), do not remove the short plug.
- (2) Do not install the inter-unit control wiring in a way that forms a loop.



- (3) Do not install inter-unit control wiring such as star branch wiring. Star branch wiring causes mis-address setting.

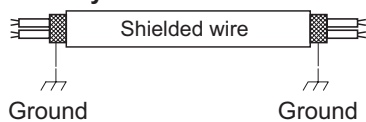


- (4) If branching the inter-unit control wiring, the number of branch points should be 16 or fewer.



- (5) Use shielded wires for inter-unit control wiring (c) and ground the shield on both sides, otherwise misoperation from noise may occur.

Connect wiring as shown in Section "■ Wiring System Diagrams".



- (6) • Connecting cable between indoor unit and outdoor unit shall be approved polychloroprene sheathed 5 or 3 \*1.5 mm<sup>2</sup> flexible cord. Type designation 60245 IEC 57 (H05RN-F, GP85PCP etc.) or heavier cord.
- Use the standard power supply cables for Europe (such as H05RN-F or H07RN-F which conform to CENELEC (HAR) rating specifications) or use the cables based on IEC standard. (60245 IEC57, 60245 IEC66)



**WARNING**

Loose wiring may cause the terminal to overheat or result in unit malfunction. A fire hazard may also occur. Therefore, ensure that all wiring is tightly connected.

When connecting each power wire to the terminal, follow the instructions on "How to connect wiring to the terminal" and fasten the wire securely with the terminal screw.

## How to connect wiring to the terminal

### ■ For stranded wiring

- (1) Cut the wire end with cutting pliers, then strip the insulation to expose the stranded wiring about 10 mm and tightly twist the wire ends. (Fig. 1-10-1)
- (2) Using a Phillips head screwdriver, remove the terminal screw(s) on the terminal plate.
- (3) Using a ring connector fastener or pliers, securely clamp each stripped wire end with a ring pressure terminal.
- (4) Place the ring pressure terminal, and replace and tighten the removed terminal screw using a screwdriver. (Fig. 1-10-2)

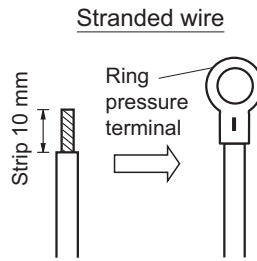


Fig. 1-10-1

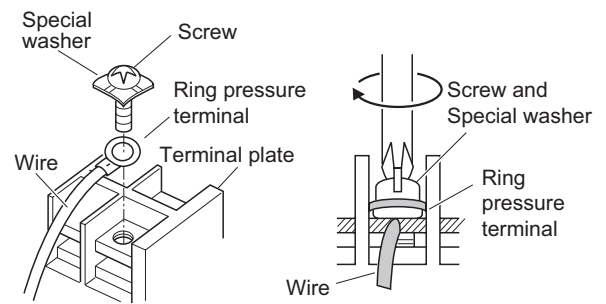


Fig. 1-10-2

### ■ Examples of shield wires

- (1) Remove cable coat not to scratch braided shield. (Fig. 1-10-3)
- (2) Unbraid the braided shield carefully and twist the unbraided shield wires tightly together. Insulate the shield wires by covering them with an insulation tube or wrapping insulation tape around them. (Fig. 1-10-4)
- (3) Remove coat of signal wire. (Fig. 1-10-5)
- (4) Attach ring pressure terminals to the signal wires and the shield wires insulated in Step (2). (Fig. 1-10-6)



Fig. 1-10-3

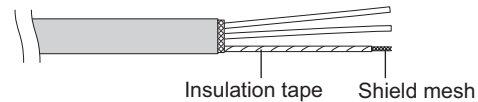


Fig. 1-10-4

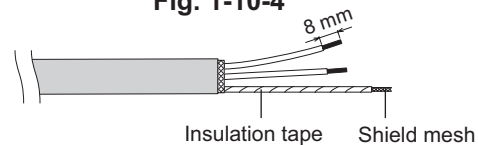


Fig. 1-10-5

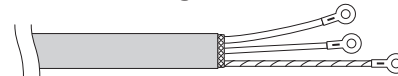
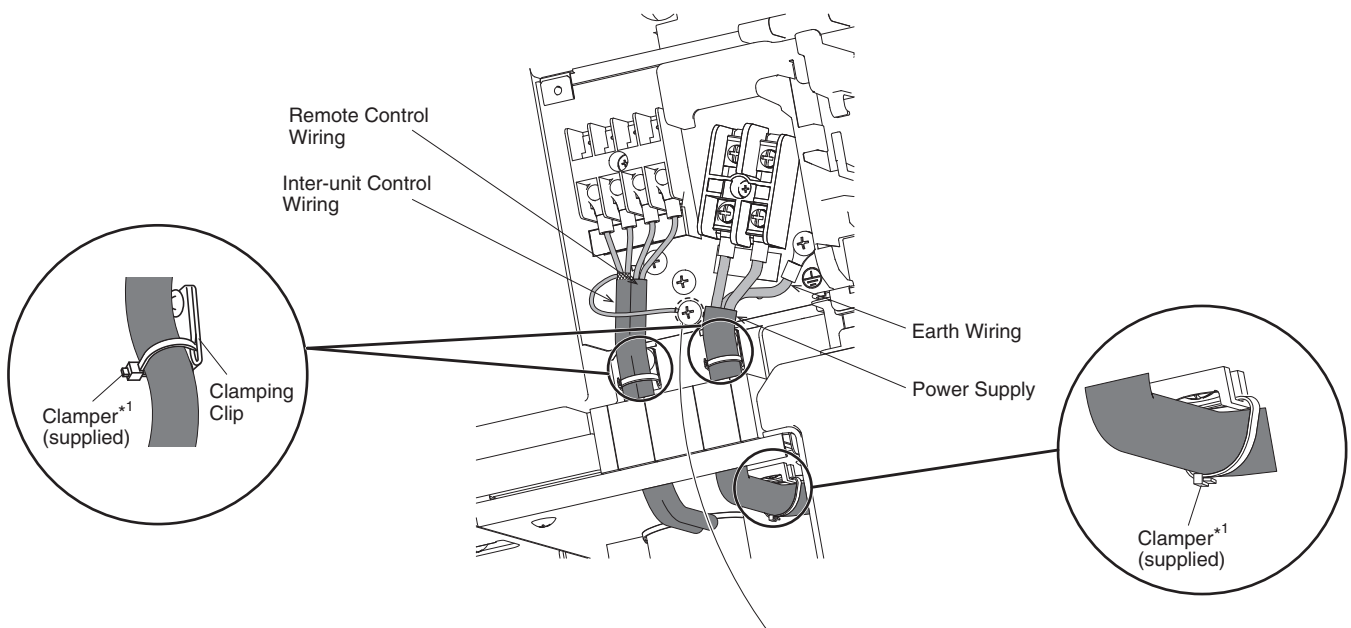


Fig. 1-10-6

### ■ Wiring samples

#### Type U2



\*1 Fasten tightly.

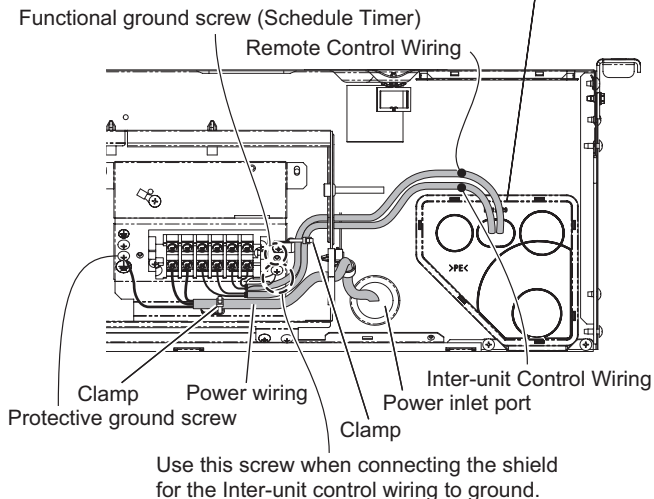
Ground terminal fixing for SG  
(SG: Shows the ground for the shielded cable.)

■ Wiring samples

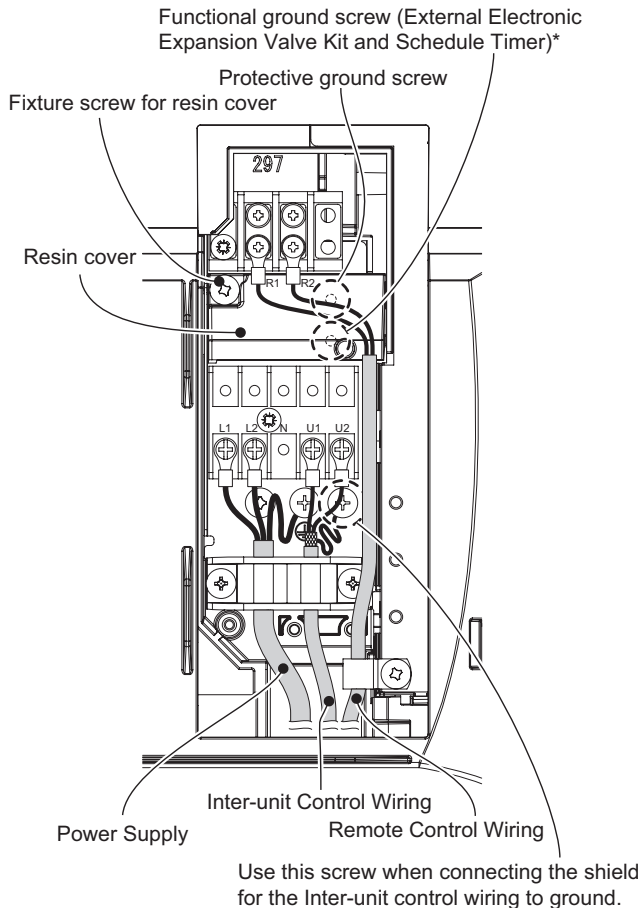
Type T2

Remote control wiring and inter-unit control wiring inlet port

\* Insert the remote control wiring and inter-unit control wiring into the electrical component box from the inlet port as shown in the figure. This is done regardless of whether the wiring was inserted from the top, rear, or left side of the main unit.



Type K1



\* As to functional ground screw and protective ground screw, remove the fixture screw and resin cover. Then, carry out earth ground work.

How to carry out power supply wiring

(1) Wiring connection ports

The power inlet port is located at the rear.  
The remote control wiring inlet port is located at the rear (for use with the wired remote controller).

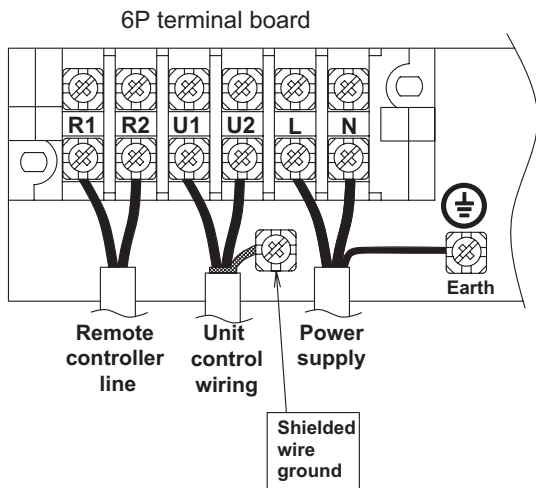
(2) How to carry out wiring

- Insert the power wiring into the indoor unit through the rubber at the side of the electrical component box.
- For wiring connection to the outdoor unit and remote control wiring, open the elongated hole of the piping cover and pass the wires through the hole.

**NOTE**

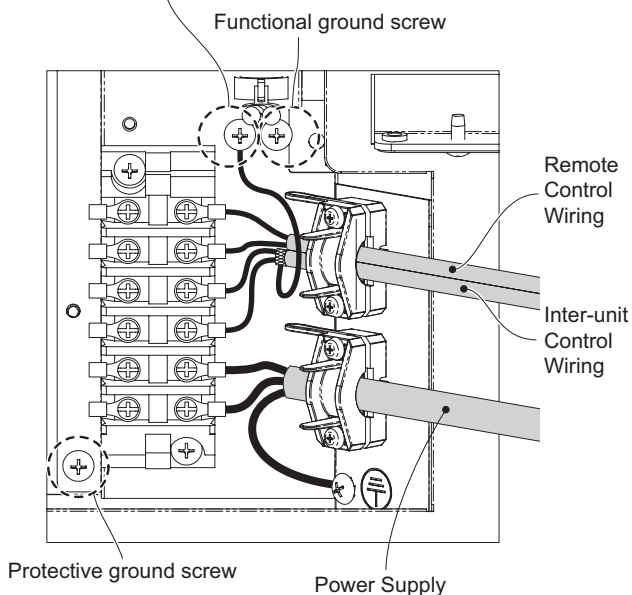
Be sure to use sealing putty to seal off the opening to prevent dust.

Type N1



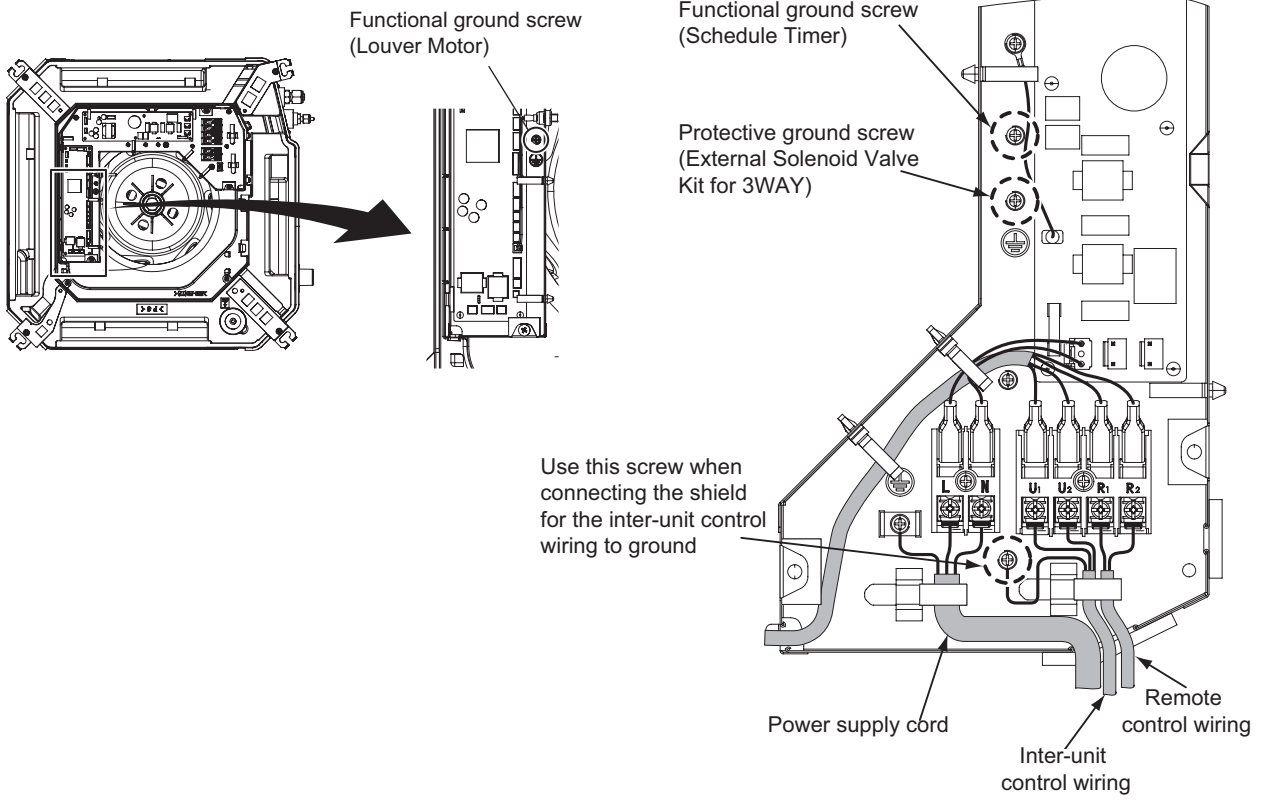
Type F1

Use this screw when connecting the shield for the Inter-unit control wiring to ground.



■ Wiring samples

Type Y2







1-11. Installation instructions

1. U-36PE2E5A, U-50PE2E5A, U-60PE2E5A, U-60PEY2E5, U-71PEY2E5

ACCESSORIES SUPPLIED WITH OUTDOOR UNIT

| Part Name              | Figure  | Q'ty | Remarks | Part Name                 | Figure  | Q'ty | Remarks                    |
|------------------------|---|------|---------|---------------------------|---|------|----------------------------|
| Operating Instructions |  | 1    |         | Installation Instructions |  | 1    | Included this instructions |

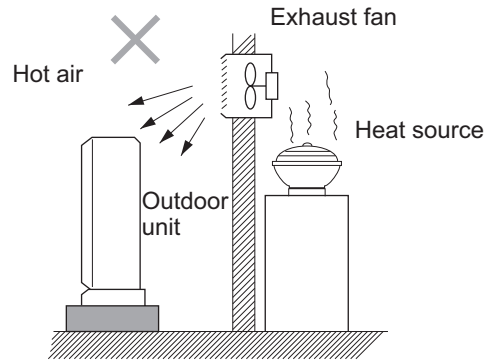
SELECTING THE INSTALLATION SITE

AVOID:

- heat sources and exhaust fans, etc.
- damp, humid or uneven locations.

DO:

- choose a place as cool as possible.
- choose a place that is well ventilated and outside air temperature does not exceed maximum 45°C constantly.
- allow enough room around the unit for air intake/exhaust and possible maintenance.
- use lug bolts or equal to bolt down unit, reducing vibration and noise.
- If cooling operation is to be used when the outdoor air temperature is -5°C or below, install a duct on the outdoor unit.



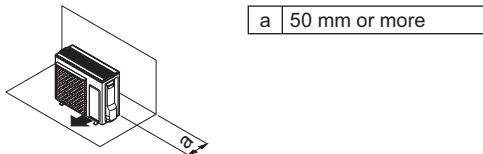
Installation space for outdoor unit

Install the outdoor unit with a sufficient space around the outdoor unit for operation and maintenance.

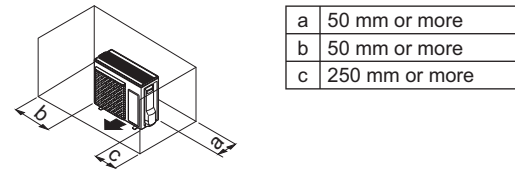
(A) When an obstruction is present on the air inlet side

- When the upward area is open

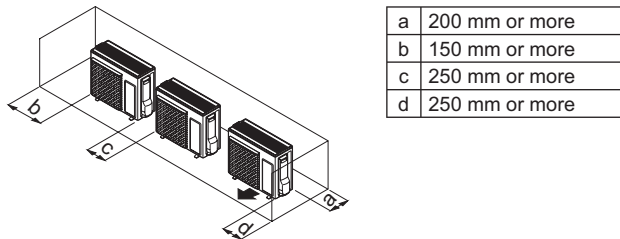
(1) One outdoor unit installed individually  
Obstruction only on air inlet side



Obstruction on both sides

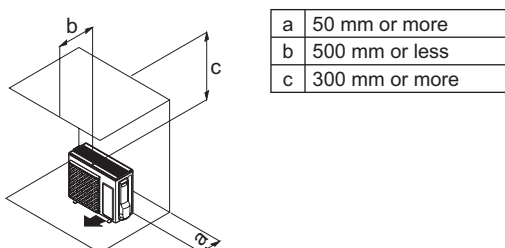


(2) Two or more outdoor units installed side by side  
Obstructions on both sides

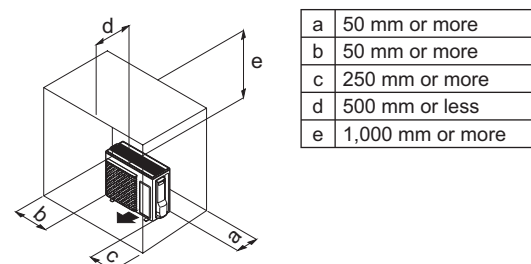


- When an obstruction is present also in the upward area (Do not use the air-discharge chamber.)

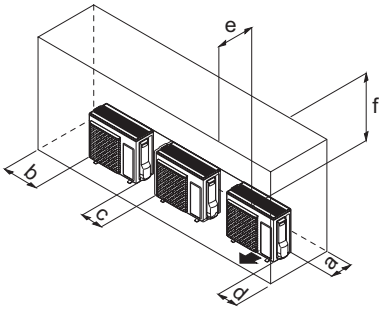
(1) One outdoor unit installed individually  
Obstruction only on air inlet side



Obstruction also on the air inlet side and both sides



(2) Two or more outdoor units installed side by side  
Obstruction also on the air inlet side and both sides

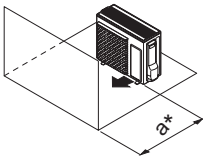


|   |                  |
|---|------------------|
| a | 400 mm or more   |
| b | 1,000 mm or more |
| c | 250 mm or more   |
| d | 250 mm or more   |
| e | 500 mm or less   |
| f | 1,000 mm or more |

(B) When an obstruction is present on the air outlet side

● When the upward area is open

(1) One outdoor unit installed individually

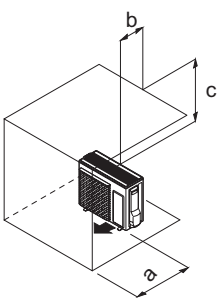


|   |                |
|---|----------------|
| a | 500 mm or more |
|---|----------------|

\* When also using the air-discharge chamber, provide a space of 500 mm or more.

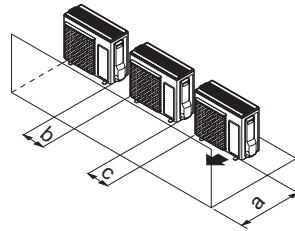
● When an obstruction is present also in the upward area

(1) One outdoor unit installed individually



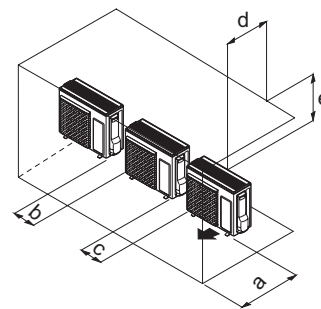
|   |                |
|---|----------------|
| a | 500 mm or more |
| b | 500 mm or less |
| c | 300 mm or more |

(2) Two or more units installed side by side



|   |                  |
|---|------------------|
| a | 1,000 mm or more |
| b | 250 mm or more   |
| c | 250 mm or more   |

(2) Two or more units installed side by side



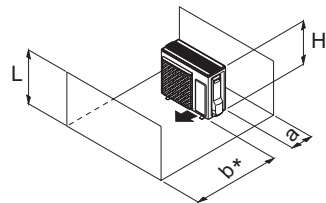
|   |                  |
|---|------------------|
| a | 500 mm or more   |
| b | 250 mm or more   |
| c | 250 mm or more   |
| d | 500 mm or less   |
| e | 1,000 mm or more |

(C) When an obstruction is present on both the air inlet and air outlet sides

Case 1: When an obstruction on the air outlet side is higher than the outdoor unit ( $L > H$ )  
(There is no height restriction on the air inlet side.)

● When the upward area is open

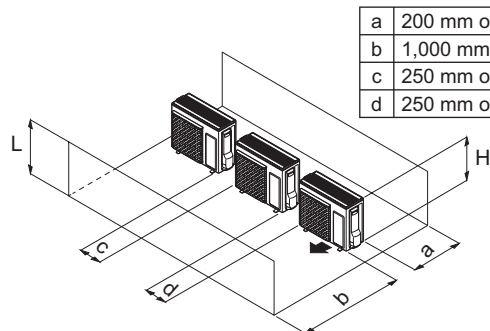
(1) One outdoor unit installed individually



|   |                |
|---|----------------|
| a | 50 mm or more  |
| b | 500 mm or more |

\* When using the air-discharge chamber, provide a space of 300 mm or more.

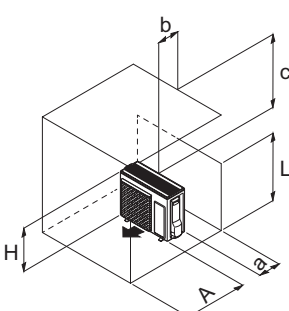
(2) Two or more units installed side by side



|   |                  |
|---|------------------|
| a | 200 mm or more   |
| b | 1,000 mm or more |
| c | 250 mm or more   |
| d | 250 mm or more   |

● When an obstruction is present also in the upward area (Do not use the air-discharge chamber.)

(1) One outdoor unit installed individually



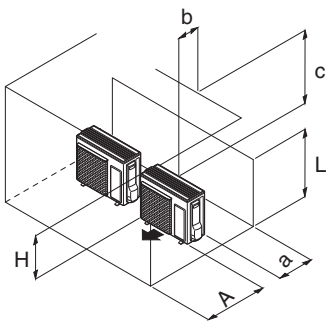
|   |                  |
|---|------------------|
| a | 200 mm or more   |
| b | 500 mm or less   |
| c | 1,000 mm or more |

The dimensional relationship between H, A, and L is as shown in the following table.

| Unit: mm   |   |     |
|------------|---|-----|
|            | L   | A   |
| $L \leq H$ | $0 < L \leq 1/2H$                         | 300 |
|            | $1/2H < L \leq H$                         | 500 |
| $H < L$    | Install the frame to achieve $L \leq H$ . |     |

Close the area under the frame so that the outlet air does not bypass there.

(2) Only two outdoor units installed side by side



|   |                  |
|---|------------------|
| a | 200 mm or more   |
| b | 500 mm or less   |
| c | 1,000 mm or more |

The dimensional relationship between H, A, and L is as shown in the following table.

| Unit: mm   |   |     |
|------------|---|-----|
|            | L   | A   |
| $L \leq H$ | $0 < L \leq 1/2H$                         | 500 |
|            | $1/2H < L \leq H$                         | 750 |
| $H < L$    | Install the frame to achieve $L \leq H$ . |     |

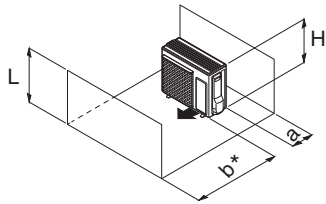
Close the area under the frame so that the outlet air does not bypass there.

Only two outdoor units can be installed side by side.

Case 2: When an obstruction on the air outlet side is lower than the outdoor unit ( $L \leq H$ )  
(There is no height restriction on the air inlet side.)

● When the upward area is open

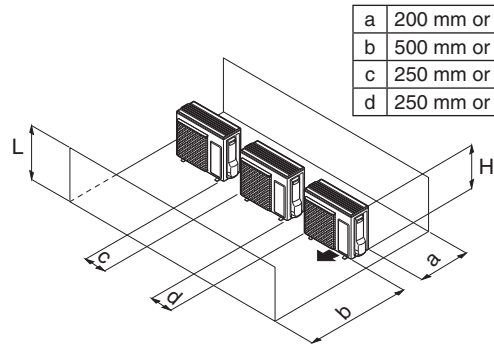
(1) One outdoor unit installed individually



|   |                |
|---|----------------|
| a | 100 mm or more |
| b | 500 mm or more |

\* When using the air-discharge chamber, provide a space of 300 mm or more.

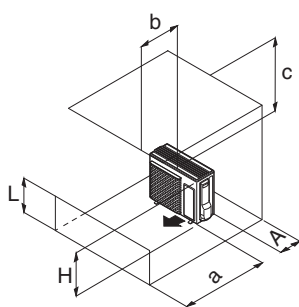
(2) Two or more units installed side by side



|   |                |
|---|----------------|
| a | 200 mm or more |
| b | 500 mm or more |
| c | 250 mm or more |
| d | 250 mm or more |

● When an obstruction is present also in the upward area (Do not use the air-discharge chamber.)

(1) One outdoor unit installed individually



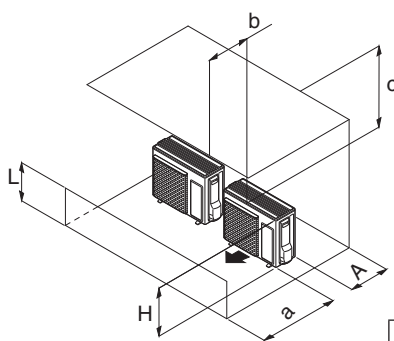
|   |                  |
|---|------------------|
| a | 500 mm or more   |
| b | 500 mm or less   |
| c | 1,000 mm or more |

The dimensional relationship between H, A, and L is as shown in the following table.

| Unit: mm   |   |  |
|------------|---|--|
|            | A   |  |
| $L \leq H$ | 100                                       |  |
| $H < L$    | Install the frame to achieve $L \leq H$ . |  |

Close the area under the frame so that the outlet air does not bypass there.

(2) Only two outdoor units installed side by side



|   |                  |
|---|------------------|
| a | 1,000 mm or more |
| b | 500 mm or less   |
| c | 1,000 mm or more |

The dimensional relationship between H, A, and L is as shown in the following table.

| Unit: mm   |   |  |
|------------|---|--|
|            | A   |  |
| $L \leq H$ | 200                                       |  |
| $H < L$    | Install the frame to achieve $L \leq H$ . |  |

Close the area under the frame so that the outlet air does not bypass there.

Only two outdoor units can be installed side by side.

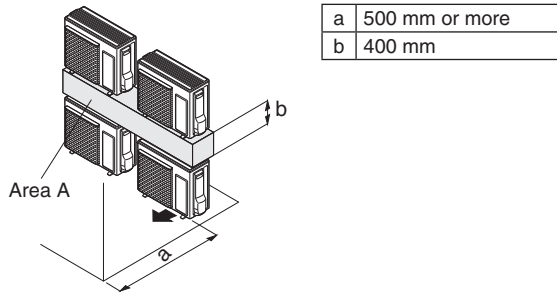
(D) When outdoor units are stacked

Only two outdoor units can be stacked.

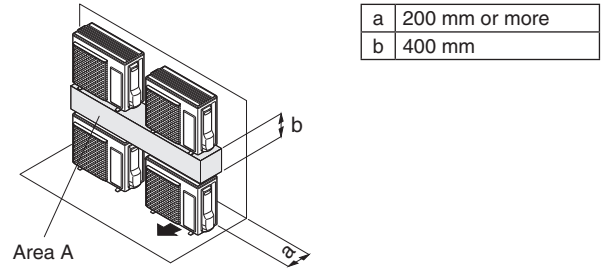
For drain treatment, a space of at least 400 mm is required between the upper and lower outdoor units.

Close the area A (gap between the upper outdoor unit and lower outdoor unit) so that the outlet air does not bypass there.

(1) Obstruction on the air outlet side

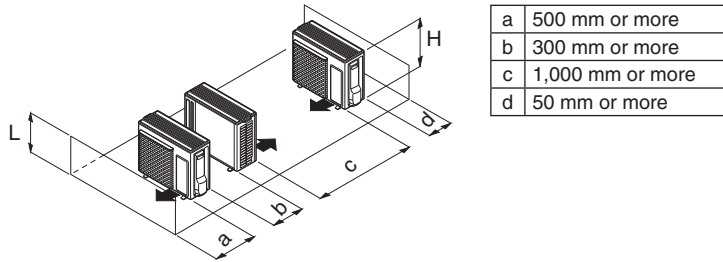


(2) Obstruction on the air inlet side

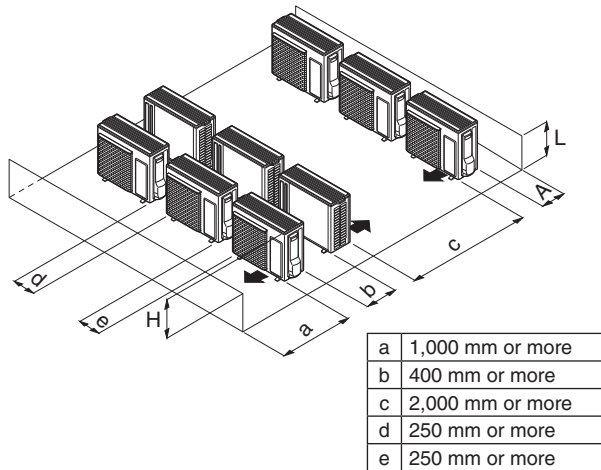


(E) When outdoor units are installed in rows, such as on a rooftop (L < H)

(1) One outdoor unit installed in each row



(2) Only two outdoor units can be installed side by side.



The dimensional relationship between H, A, and L is as shown in the following table.

Unit: mm

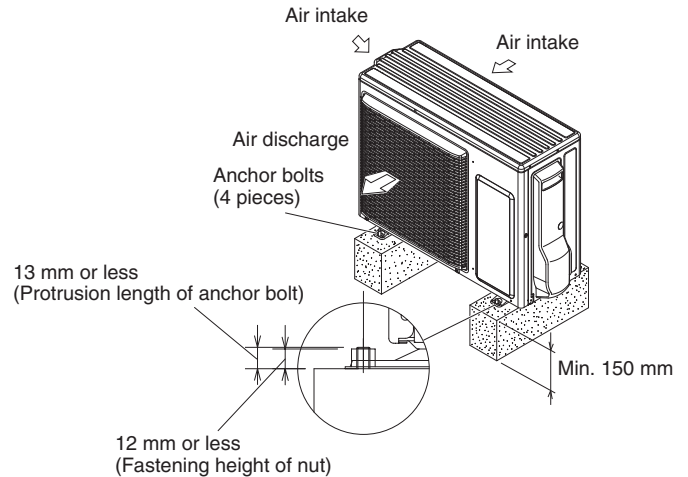
|       | A                            |
|-------|------------------------------|
| L ≤ H | 150                          |
| H < L | Installation is not allowed. |

The values described above are the least space to optimize application performance.

If any service area is needed for service according to field circumstance, obtain enough service space.

**In case of multiple installations**

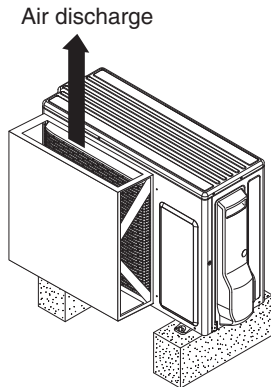
- Concrete block foundation should be used and well drained. Be sure that the foundation height is kept at least more than 50 mm from the ground.
- Base leg should be fixed by inserting the flat washer (field supply) and single nut (field supply) onto the anchor bolt (M8, field supply). Protrusion length of anchor bolt should be 13 mm or less and fastening height of nut should be 12 mm or less.  
Note: If the anchor bolt is longer and the fastening height of nut is higher, the front panel may be damaged when installing or removing it.
- Use lug bolts or equal to bolt down unit, reducing vibration and noise.



### Air-Discharge Chamber for Top Discharge

Be sure to install the air-discharge chamber in the field when:

- it is difficult to keep a space of min. 50 cm between the air discharge outlet and an obstacle.
- the air discharge outlet is facing a sidewalk and discharged hot air annoys passers-by.



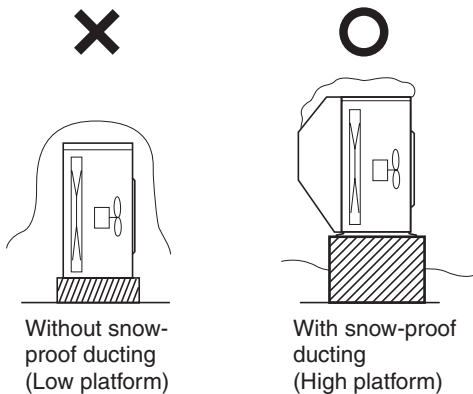
In regions with significant snowfall, the outdoor unit should be provided with a platform and snow-proof duct.

### Installing the Unit in Heavy Snow Areas

In locations with strong wind, snow-proof ducting should likewise be fitted and direct exposure to the wind should be avoided as much as possible.

#### ■ Countermeasures against snow and wind

In regions with snow and strong wind, the following problems may occur when the outdoor unit is not provided with a platform and snow-proof ducting:

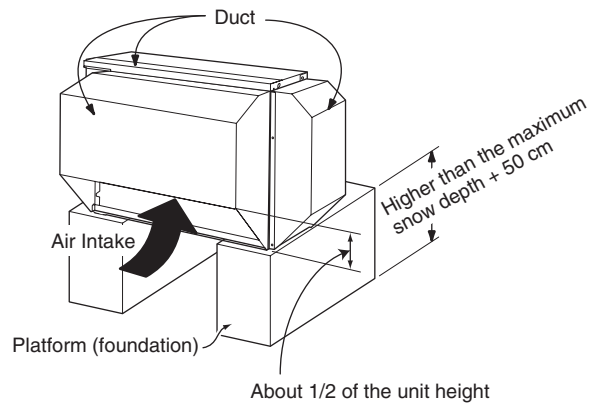
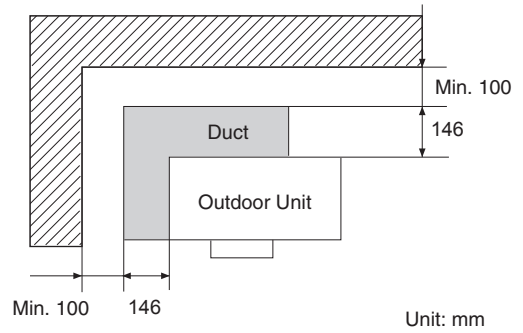


- The outdoor fan may not run and damage of the unit may be caused.
- There may be no airflow.
- The tubing may freeze and burst.
- The condenser pressure may drop because of strong wind, and the indoor unit may freeze.

### Precautions for Installation in Heavy Snow Areas

- (1) The platform should be higher than the maximum snow depth +50 cm.
- (2) The 2 anchoring feet of the outdoor unit should be used for the platform, and the platform should be installed beneath the air intake side of outdoor unit.
- (3) The platform foundation must be firm and the unit must be secured with anchor bolts.
- (4) In case of installation on a roof subject to strong wind, countermeasures must be taken to prevent the unit from being blown over.

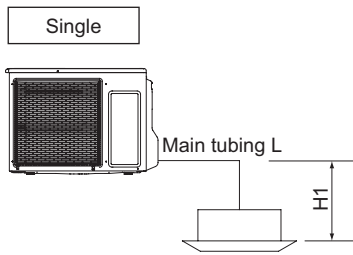
### Dimensions of Snow / Wind-proof Ducting and Refrigerant Tubing Space for Installation



## Tubing Size

### (A) Single type

- Refrigerant tubing between the indoor and outdoor units should be kept as short as possible.
- The lengths of the refrigerant tubes between the indoor and outdoor units are limited by the elevation difference between the 2 units. During tubing work, try to make both the tubing length (L) and the difference in elevation (H1) as short as possible.



| Outdoor unit type                            | U-36PE2E5A<br>U-50PE2E5A | U-60PE2E5A<br>U-60PEY2E5<br>U-71PEY2E5 |
|--|--------------------------|--|
| Maximum allowable tubing length              | 40 m                     | 40 m                                   |
| Charge-less tubing length<br>(actual length) | 3 – 30 m                 | 3 – 30 m                               |
| Additional charge per 1 m                    | 20 g                     | 40 g                                   |

### Tubing Data for Models

| Tubing Data  |                               | Models   | U-36PE2E5A<br>U-50PE2E5A | U-60PE2E5A<br>U-60PEY2E5<br>U-71PEY2E5 |
|--|-------------------------------|----------|--------------------------|--|
| Tubing size outer diameter                           | Liquid tube                   | mm (in.) | 6.35 (1/4)               | 9.52 (3/8)                             |
|  | Gas tube                      | mm (in.) | 12.7 (1/2)               | 15.88 (5/8)                            |
| Limit of tubing length                               |                               | (m)      | 40                       | 40                                     |
| Limit of elevation difference<br>between the 2 units | Outdoor unit is placed higher | (m)      | 30                       | 30                                     |
|  | Outdoor unit is placed lower  | (m)      | 15                       | 15                                     |
| Max. allowable tubing length at shipment             |                               | (m)      | 3 – 30                   | 3 – 30                                 |
| Required additional refrigerant                      |                               | (g/m)    | 20                       | 40                                     |
| Refrigerant charged at shipment                      |                               | (kg)     | 1.40                     | 1.95                                   |

## ■ Check of Density Limit

Check the amount of refrigerant in the system and floor space of the room according to the legislation on refrigerant drainage. If there is no applicable legislation, follow the standards described below.

The room in which the air conditioner is to be installed requires a design that in the event of refrigerant gas leaking out, its density will not exceed a set limit.

The refrigerant (R410A), which is used in the air conditioner, is safe, without the toxicity or combustibility of ammonia, and is not restricted by laws imposed to protect the ozone layer. However, since it contains more than air, it poses the risk of suffocation if its density should rise excessively. Suffocation from leakage of refrigerant is almost non-existent. With the recent increase in the number of high density buildings, however, the installation of multi air conditioner systems is on the increase because of the need for effective use of floor space, individual control, energy conservation by curtailing heat and carrying power, etc.

Most importantly, the multi air conditioner system is able to replenish a large amount of refrigerant compared to conventional individual air conditioners. If a single unit of the multi air conditioner system is to be installed in a small room, select a suitable model and installation procedure so that if the refrigerant accidentally leaks out, its density does not reach the limit (and in the event of an emergency, measures can be made before injury can occur).

In a room where the density may exceed the limit, create an opening with adjacent rooms, or install mechanical ventilation combined with a gas leak detection device. The density is as given below.

### Total amount of refrigerant (kg)

#### Min. volume of the indoor unit installed room (m<sup>3</sup>)

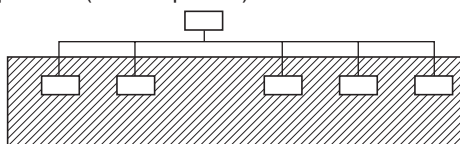
#### ≤ Density limit (kg/m<sup>3</sup>)

The density limit of refrigerant which is used in multi air conditioners is 0.44 kg/m<sup>3</sup> (ISO 5149).

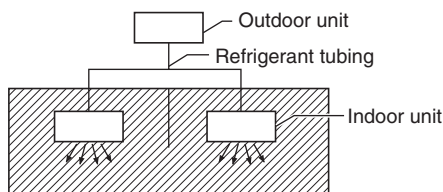
#### NOTE

1. The standards for minimum room volume are as follows.

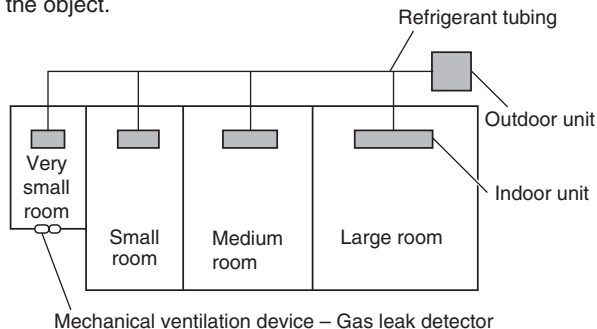
(1) No partition (shaded portion)



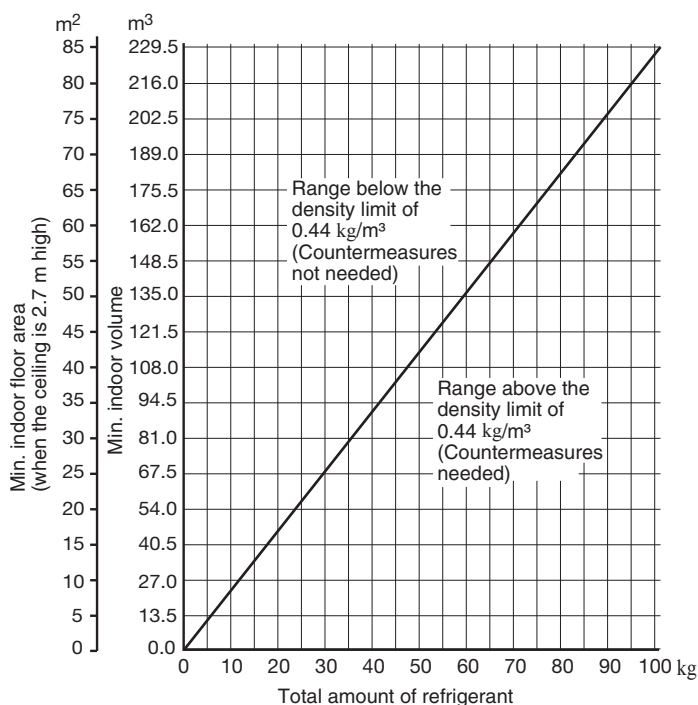
(2) When there is an effective opening with the adjacent room for ventilation of leaking refrigerant gas (opening without a door, or an opening 0.15% or larger than the respective floor spaces at the top or bottom of the door).



(3) If an indoor unit is installed in each partitioned room and the refrigerant tubing is interconnected, the smallest room of course becomes the object. But when mechanical ventilation is installed interlocked with a gas leakage detector in the smallest room where the density limit is exceeded, the volume of the next smallest room becomes the object.



2. The minimum indoor floor space compared with the amount of refrigerant is roughly as follows: (When the ceiling is 2.7 m high)



## HOW TO INSTALL THE OUTDOOR UNIT

### Installing the Outdoor Unit

- Use concrete or a similar material to make the base, and ensure good drainage.
- Ordinarily, ensure a base height of 5 cm or more. If a drain pipe is used, or for use in cold-weather regions, ensure a height of 15 cm or more at the feet on both sides of the unit. (In this case, leave clearance below the unit for the drain pipe, and to prevent freezing of drainage water in cold-weather regions.)
- See Fig. 1-11-1-1 for the anchor bolt dimensions.
- Be sure to anchor the feet with anchor bolts (M8). In addition, use anchoring washers on the top side. (Use large square 32 × 32 SUS washers with nominal diameter of 8.) (Field supply)

Unit: mm

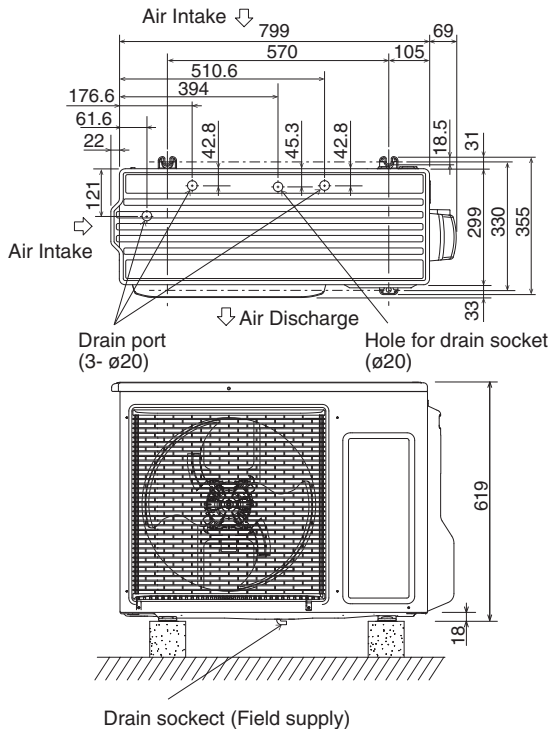


Fig. 1-11-1-1

### Drainage Work

The drain water will be discharged from the unit during heating or defrosting operation mode.

Select an appropriate location with good drainage system. (In winter, there is a risk of slipping caused by freezing depending on the installation location.)

- Ensure a height of 15 cm or more at the feet on both sides of the unit.
- Precautions for Installation in Heavy Snow Areas. The platform should be higher than the maximum snow depth. (In this case, leave clearance below the unit for the drain pipe, and to prevent freezing of drainage water in cold-weather regions.)
- When using a drain pipe, install the drain socket (field supply) onto the drain hole. Seal the other drain hole with the rubber cap (field supply). For details, refer to the instruction manual of the drain socket (field supply). After completing the installation work of the drain socket, make sure that the water does not leak from any part of connection.
- In cold regions (where the outdoor temperature can drop to below 0° for 2 to 3 consecutive days), the drain water may freeze and may prevent the fan from operating. For this case, do not use the drain elbow.

### Routing the Tubing and Wiring

- See Fig. 1-11-1-1.



#### CAUTION

- Route the tubing so that it does not contact the compressor, panel, or other parts inside the unit. Increased noise will result if the tubing contacts these parts.
- When routing the tubing, use a tube bender to bend the tubes.
- In cold-weather regions, in order to prevent drainage water from freezing, do not install the drain socket cap. Also take steps to prevent water from accumulating around the unit.



## HOW TO PROCESS TUBING

Both the liquid and the gas tubing sides are connected by flare nuts.

### Connecting the Refrigerant Tubing

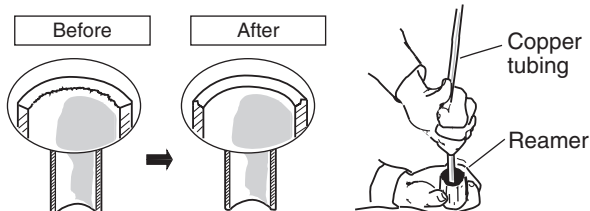
#### Use of the Flaring Method

Many of conventional split system air conditioners employ the flaring method to connect refrigerant tubes that run between indoor and outdoor units. In this method, the copper tubes are flared at each end and connected with flare nuts.

#### Flaring Procedure with a Flare Tool

- (1) Cut the copper tube to the required length with a tube cutter. It is recommended to cut approx. 30 – 50 cm longer than the tubing length you estimate.
- (2) Remove burrs at each end of the copper tubing with a tube reamer or a similar tool. This process is important and should be done carefully to make a good flare. Be sure to keep any contaminants (moisture, dirt, metal filings, etc.) from entering the tubing.

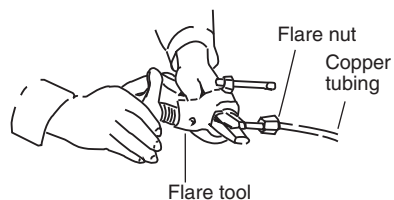
#### Deburring



#### NOTE

When reaming, hold the tube end downward and be sure that no copper scraps fall into the tube.

- (3) Remove the flare nut from the unit and be sure to mount it on the copper tube.
- (4) Make a flare at the end of the copper tube with a flare tool.

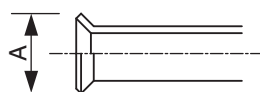


#### NOTE

A good flare should have the following characteristics:

- inside surface is glossy and smooth
- edge is smooth
- tapered sides are of uniform length

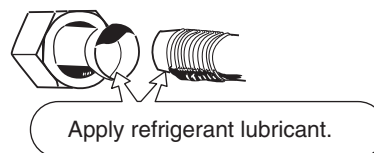
Flare size: A (mm)



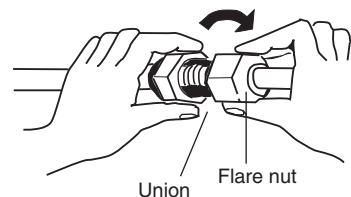
| Copper tubing (Outer dia.) | A <sub>-0.4</sub> <sup>0</sup> |
|----------------------------|--------------------------------|
| ø6.35                      | 9.1                            |
| ø9.52                      | 13.2                           |
| ø12.7                      | 16.6                           |
| ø15.88                     | 19.7                           |

#### Caution Before Connecting Tubes Tightly

- (1) Apply a sealing cap or water-proof tape to prevent dust or water from entering the tubes before they are used.
- (2) Be sure to apply refrigerant lubricant to the matching surfaces of the flare and union before connecting them together. This is effective for reducing gas leaks.



- (3) For proper connection, align the union tube and flare tube straight with each other, then screw on the flare nut lightly at first to obtain a smooth match.



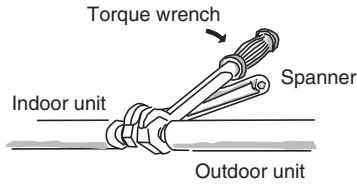
- Adjust the shape of the liquid tube using a tube bender at the installation site and connect it to the liquid tubing side valve using a flare.

#### Cautions During Brazing

- Replace air inside the tube with nitrogen gas to prevent copper oxide film from forming during the brazing process. (Oxygen, carbon dioxide and Freon are not acceptable.)
- Do not allow the tubing to get too hot during brazing. The nitrogen gas inside the tubing may overheat, causing refrigerant system valves to become damaged. Therefore allow the tubing to cool when brazing.
- Use a reducing valve for the nitrogen cylinder.
- Do not use agents intended to prevent the formation of oxide film. These agents adversely affect the refrigerant and refrigerant oil, and may cause damage or malfunctions.

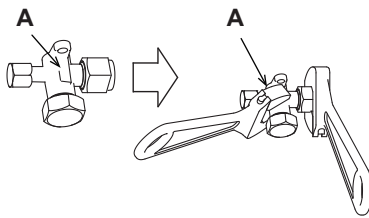
## Connecting Tubing Between Indoor and Outdoor Units

- (1) Tightly connect the indoor-side refrigerant tubing extended from the wall with the outdoor-side tubing.
- (2) To fasten the flare nuts, apply specified torque.
  - When removing the flare nuts from the tubing connections, or when tightening them after connecting the tubing, be sure to use a torque wrench and a spanner.



If the flare nuts are over-tightened, the flare may be damaged, which could result in refrigerant leakage and cause injury or asphyxiation to room occupants.

- When removing or tightening the gas tube flare nut, use 2 adjustable wrenches together: one at the gas tube flare nut, and the other at part A.

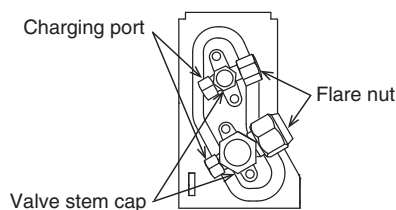


- For the flare nuts at tubing connections, be sure to use the flare nuts that were supplied with the unit, or else flare nuts for R410A (type 2). The refrigerant tubing that is used must be of the correct wall thickness as shown in the table below.

| Tube diameter | Tightening torque (approx.)           | Tube thickness |
|---------------|---------------------------------------|----------------|
| ø6.35 (1/4")  | 14 – 18 N · m<br>{140 – 180 kgf · cm} | 0.8 mm         |
| ø9.52 (3/8")  | 34 – 42 N · m<br>{340 – 420 kgf · cm} | 0.8 mm         |
| ø12.7 (1/2")  | 49 – 55 N · m<br>{490 – 550 kgf · cm} | 0.8 mm         |
| ø15.88 (5/8") | 68 – 82 N · m<br>{680 – 820 kgf · cm} | 1.0 mm         |

Because the pressure is approximately 1.6 times higher than conventional refrigerant pressure, the use of ordinary flare nuts (type 1) or thin-walled tubes may result in tube rupture, injury, or asphyxiation caused by refrigerant leakage.

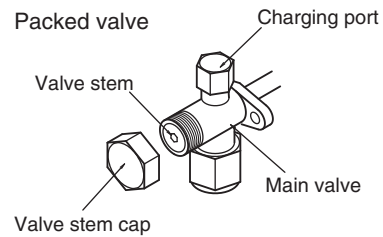
- In order to prevent damage to the flare caused by over-tightening of the flare nuts, use the table above as a guide when tightening.
- When tightening the flare nut on the liquid tube, use a adjustable wrench with a nominal handle length of 200 mm.
- When tightening the flare nut with the adjustable wrench, do not apply to the valve stem cap with the other one. If doing so, the valve will be damaged.



- Depending on the installation conditions, applying excessive torque may cause the nuts to crack.

## Precautions for Packed Valve Operation

- If the packed valve is left for a long time with the valve stem cap removed, refrigerant will leak from the valve. Therefore, do not leave the valve stem cap removed.



- Use a torque wrench to securely tighten the valve stem cap.
- Tightening torque:

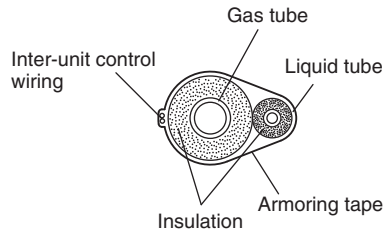
|                |                          | Tightening torque (approx.)            |
|----------------|--------------------------|--|
| Charging port  |                          | 10.7 – 14.7 N · m {107 – 147 kgf · cm} |
| Valve stem cap | ø6.35 (Liquid side)      | 14.0 – 20.0 N · m {140 – 200 kgf · cm} |
|                | ø9.52 (Liquid side)      | 20.6 – 28.4 N · m {206 – 284 kgf · cm} |
|                | ø12.7, ø15.88 (Gas side) | 48.0 – 59.8 N · m {480 – 598 kgf · cm} |

## Insulating the Refrigerant Tubing

### Tubing Insulation

- Thermal insulation must be applied to all units tubing, including distribution joint (purchased separately).

#### Two tubes arranged together



\* For gas tubing, the insulation material must be heat resistant to 120°C or above. For other tubing, it must be heat resistant to 80°C or above.

Insulation material thickness must be 10 mm or greater.

If the conditions inside the ceiling exceed DB 30°C and RH 70%, increase the thickness of the gas tubing insulation material by 1 step.

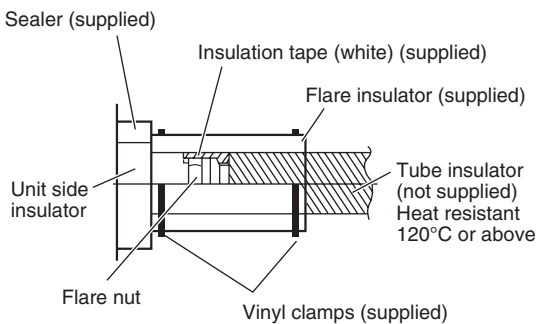


#### CAUTION

If the exterior of the outdoor unit valves has been finished with a square duct covering, make sure you allow sufficient space to access the valves and to allow the panels to be attached and removed.

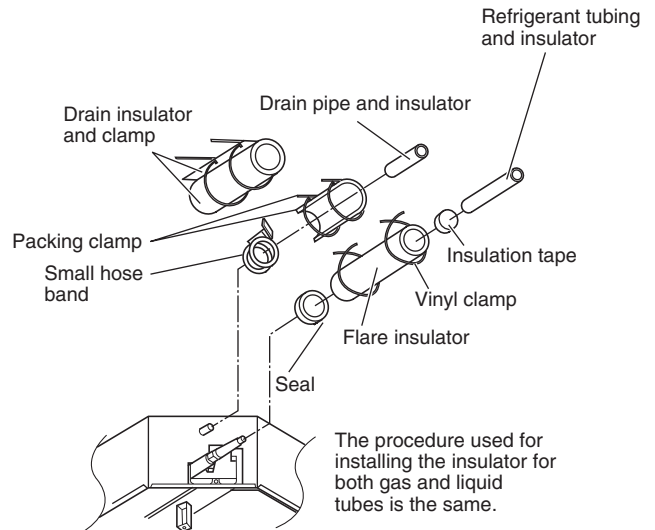
#### Taping the flare nuts

Wind the white insulation tape around the flare nuts at the gas tube connections. Then cover up the tubing connections with the flare insulator, and fill the gap at the union with the supplied black insulation tape. Finally, fasten the insulator at both ends with the supplied vinyl clamps.



### Insulation material

The material used for insulation must have good insulation characteristics, be easy to use, be age resistant, and must not easily absorb moisture.



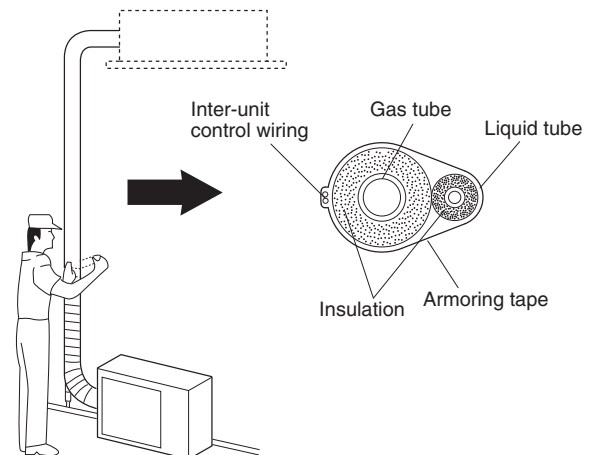
#### CAUTION

After a tube has been insulated, never try to bend it into a narrow curve because it can cause the tube to break or crack.

Never grasp the drain or refrigerant connecting outlets when moving the unit.

#### Taping the Tubes

- (1) At this time, the refrigerant tubes (and electrical wiring if local codes permit) should be taped together with armoring tape in 1 bundle. To prevent condensation from overflowing the drain pan, keep the drain hose separate from the refrigerant tubing.
- (2) Wrap the armoring tape from the bottom of the outdoor unit to the top of the tubing where it enters the wall. As you wrap the tubing, overlap half of each previous tape turn.
- (3) Clamp the tubing bundle to the wall, using 1 clamp approx. each meter.

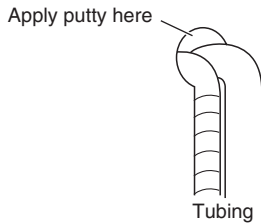


#### NOTE

Do not wind the armoring tape too tightly since this will decrease the heat insulation effect. Also ensure that the condensation drain hose splits away from the bundle and drips clear of the unit and the tubing.

## Finishing the Installation

After finishing insulating and taping over the tubing, use sealing putty to seal off the hole in the wall to prevent rain and draft from entering.



## LEAK TEST, EVACUATION AND ADDITIONAL REFRIGERANT CHARGE

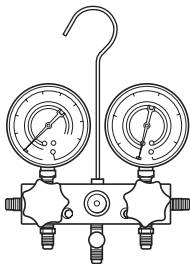
Perform an air-tightness test for this package A/C. Check that there is no leakage from any of the connections.

Air and moisture in the refrigerant system may have undesirable effects as indicated below.

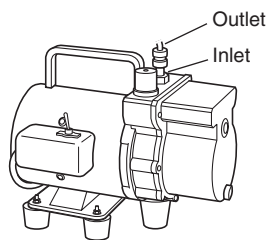
- pressure in the system rises
- operating current rises
- cooling (or heating) efficiency drops
- moisture in the refrigerant circuit may freeze and block capillary tubing
- water may lead to corrosion of parts in the refrigerant system

Therefore, the indoor unit and tubing between the indoor and outdoor unit must be leak tested and evacuated to remove any noncondensables and moisture from the system.

Manifold gauge

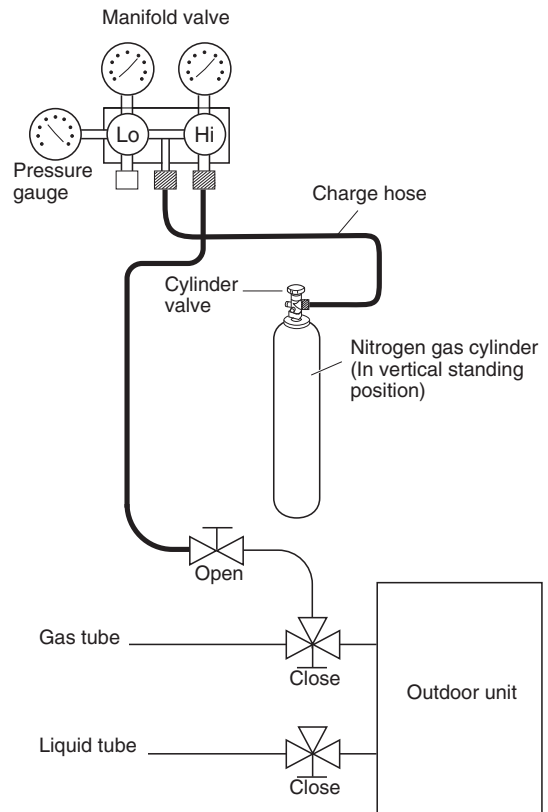


Vacuum pump



### ■ Air Purging with a Vacuum Pump (for Test Run) Preparation

Check that each tube (both liquid and gas tubes) between the indoor and outdoor units has been properly connected and all wiring for the test run has been completed. Remove the valve caps from both the gas and liquid service valves on the outdoor unit. Note that both liquid and gas tube service valves on the outdoor unit are kept closed at this stage.



- The refrigerant charge at the time of shipment is only guaranteed sufficient for a tubing length of up to 30 m. The tubing may exceed this length, up to the maximum permitted length; however, an additional charge is necessary for the amount that the tubing exceeds 30 m. (No additional refrigerating machine oil is needed.)

### Leak Test

- (1) With the service valves on the outdoor unit closed, remove the 6.35 mm flare nut and its bonnet on the gas tube service valve. (Save for reuse.)
- (2) Attach a manifold valve (with pressure gauges) and dry nitrogen gas cylinder to this service port with charge hoses.



**Use a manifold valve for air purging. If it is not available, use a stop valve for this purpose. The “Lo” knob of the manifold valve must always be kept closed.**

- (3) Pressurize the system up to 4.15 MPa {42 kgf/cm<sup>2</sup>G} with dry nitrogen gas and close the cylinder valve when the gauge reading reaches 4.15 MPa {42 kgf/cm<sup>2</sup>G}. Then, test for leaks with liquid soap.



**To avoid nitrogen entering the refrigerant system in a liquid state, the top of the cylinder must be higher than the bottom when you pressurize the system. Usually, the cylinder is used in a vertical standing position.**

- (4) Do a leak test of all joints of the tubing (both indoor and outdoor) and both gas and liquid service valves. Bubbles indicate a leak. Wipe off the soap with a clean cloth after a leak test.
- (5) After the system is found to be free of leaks, relieve the nitrogen pressure by loosening the charge hose connector at the nitrogen cylinder. When the system pressure is reduced to normal, disconnect the hose from the cylinder.

### Evacuation

Be sure to use a vacuum pump that includes a function for prevention of back-flow, in order to prevent back-flow of pump oil into the unit tubing when the pump is stopped.

- Perform vacuuming of the indoor unit and tubing. Connect the vacuum pump to the gas tube valve and apply vacuum at a pressure of  $-101\text{kPa}$   $\{-755\text{ mmHg}, 5\text{ Torr}\}$  or below. Continue vacuum application for a minimum of 1 hour after the pressure reaches  $-101\text{kPa}$   $\{-755\text{ mmHg}, 5\text{ Torr}\}$ .
- (1) Attach the charge hose end described in the preceding steps to the vacuum pump to evacuate the tubing and indoor unit. Confirm that the “Lo” knob of the manifold valve is open. Then, run the vacuum pump.
- (2) When the desired vacuum is reached, close the “Lo” knob of the manifold valve and turn off the vacuum pump. Confirm that the gauge pressure is under  $-101\text{ kPa}$   $\{-755\text{ mmHg}, 5\text{ Torr}\}$  after 4 to 5 minutes of vacuum pump operation.



**CAUTION**

Use a cylinder specifically designed for use with R410A.

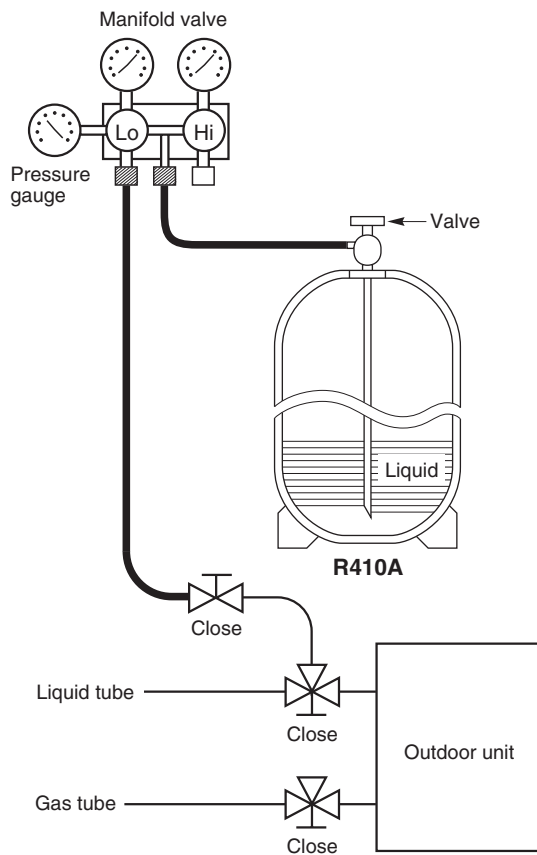


Fig. 1-11-1-2

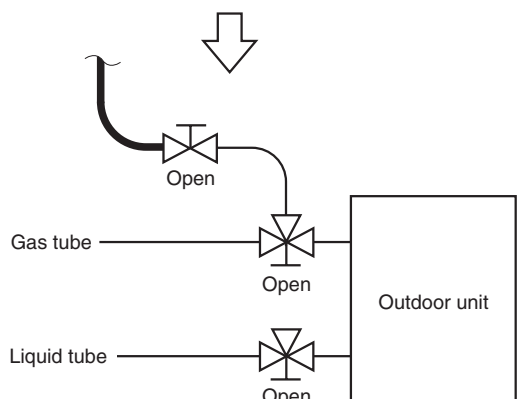
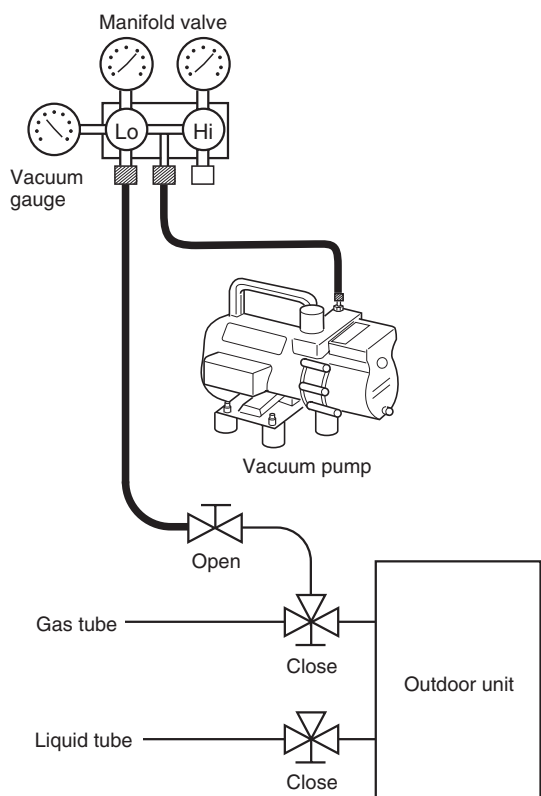


Fig. 1-11-1-3

### Charging Additional Refrigerant

- Charge additional refrigerant (calculated from the liquid tube length as shown in “Tubing Size” on page 1-11-1-6) using the liquid tube service valve. (Fig. 1-11-1-2)
  - Use a balance to measure the refrigerant accurately.
  - If the additional refrigerant charge amount cannot be charged at once, charge the remaining refrigerant in liquid form by using the gas tube service valve with the system in Cooling mode at the time of test run. (Fig. 1-11-1-3)
- \* If an additional refrigerant charge has been performed, list the refrigerant tubing length and amount of additional refrigerant charge on the product label (inside the panel).

### Finishing the Job

- (1) With a hex wrench, turn the liquid tube service valve stem counterclockwise to fully open the valve.
- (2) Turn the gas tube service valve stem counterclockwise to fully open the valve.



**CAUTION**

To avoid gas from leaking when removing the charge hose, make sure the stem of the gas tube is turned all the way out (“BACK SEAT”) position.

- (3) Loosen the charge hose connected to the gas tube service port (7.94 mm) slightly to release the pressure, and then remove the hose.
- (4) Replace the 7.94 mm flare nut and its bonnet on the gas tube service port and fasten the flare nut securely with an adjustable wrench or box wrench. This process is very important to prevent gas from leaking from the system.
- (5) Replace the valve caps at both gas and liquid service valves and fasten them securely.

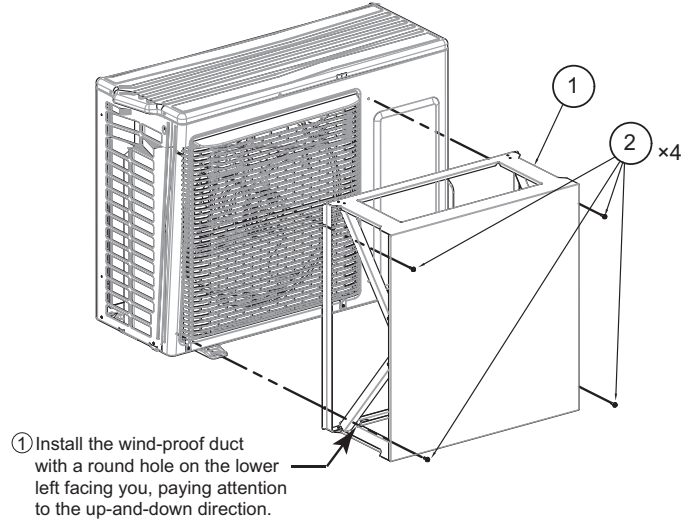
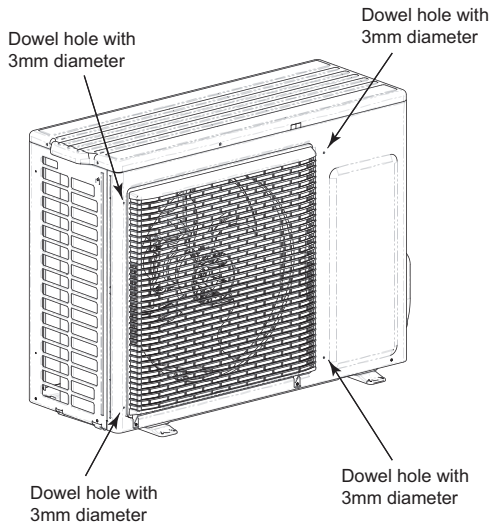
Supplement

1. Dimensions of Wind-proof Duct

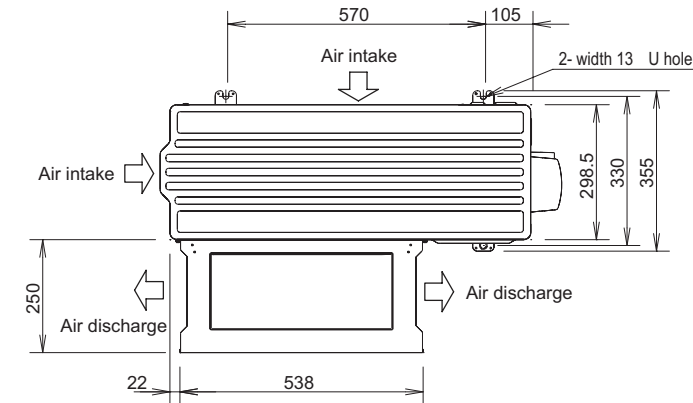
Reference diagram

| RMK | PART NAME                |      | Q'ty |
|-----|--------------------------|------|------|
| ①   | Wind-proof duct          | t0.7 | 1    |
| ②   | Tapping Screw (4mm×12mm) |      | 4    |

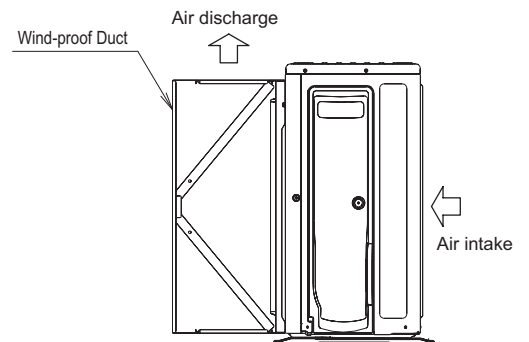
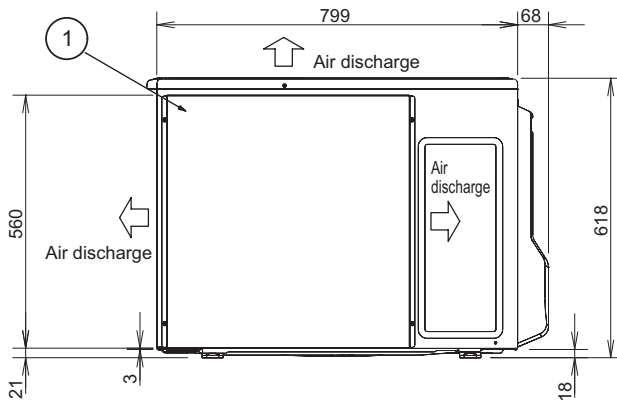
\*Do not use greater than 12mm length of screw.



At first, drill holes for installation.  
When drilling holes, adjust the blade length to be 16mm or less.



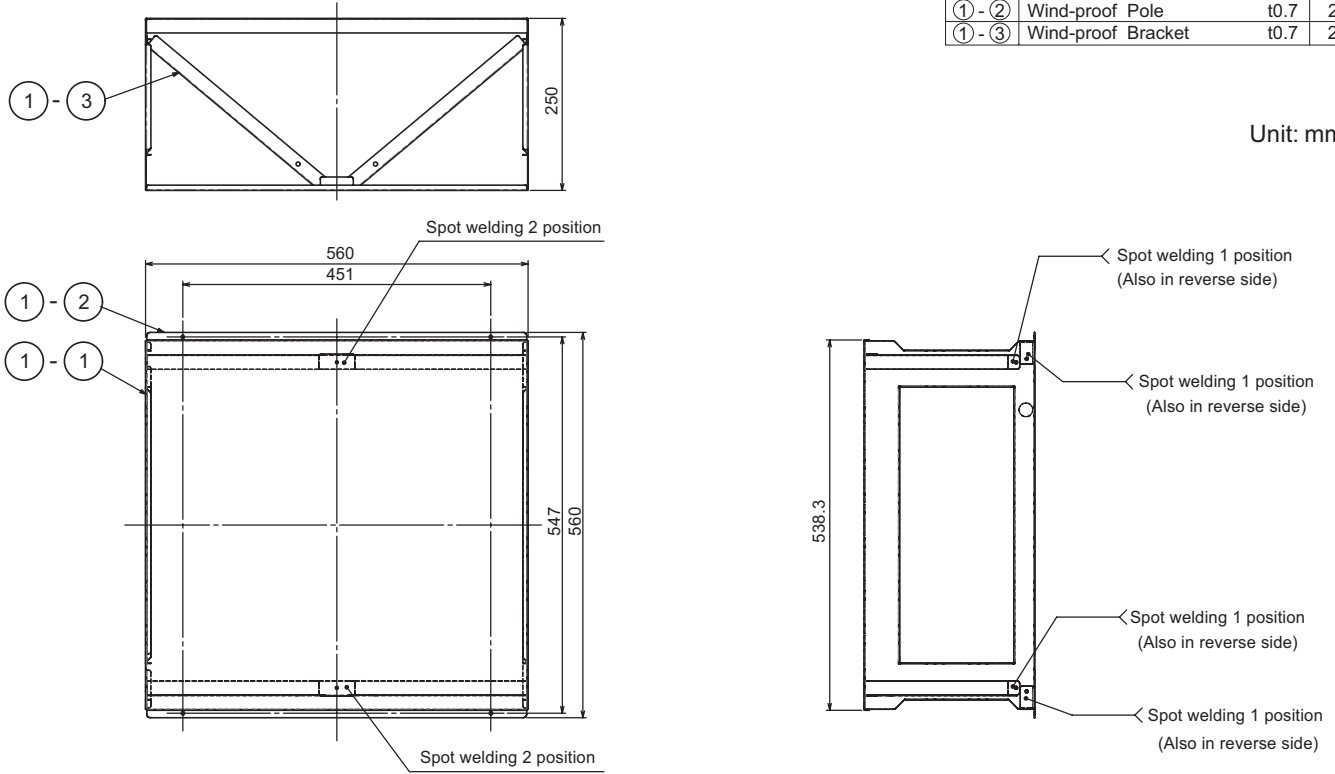
Unit: mm



① Reference diagram for wind-proof duct (field supply)

| RMK   | PART NAME              | t    | Q'ty |
|-------|------------------------|------|------|
| ① - ① | Wind-proof Front Panel | t0.7 | 1    |
| ① - ② | Wind-proof Pole        | t0.7 | 2    |
| ① - ③ | Wind-proof Bracket     | t0.7 | 2    |

Unit: mm



① - ① Reference diagram for wind-proof Front Panel (field supply)

Unit: mm

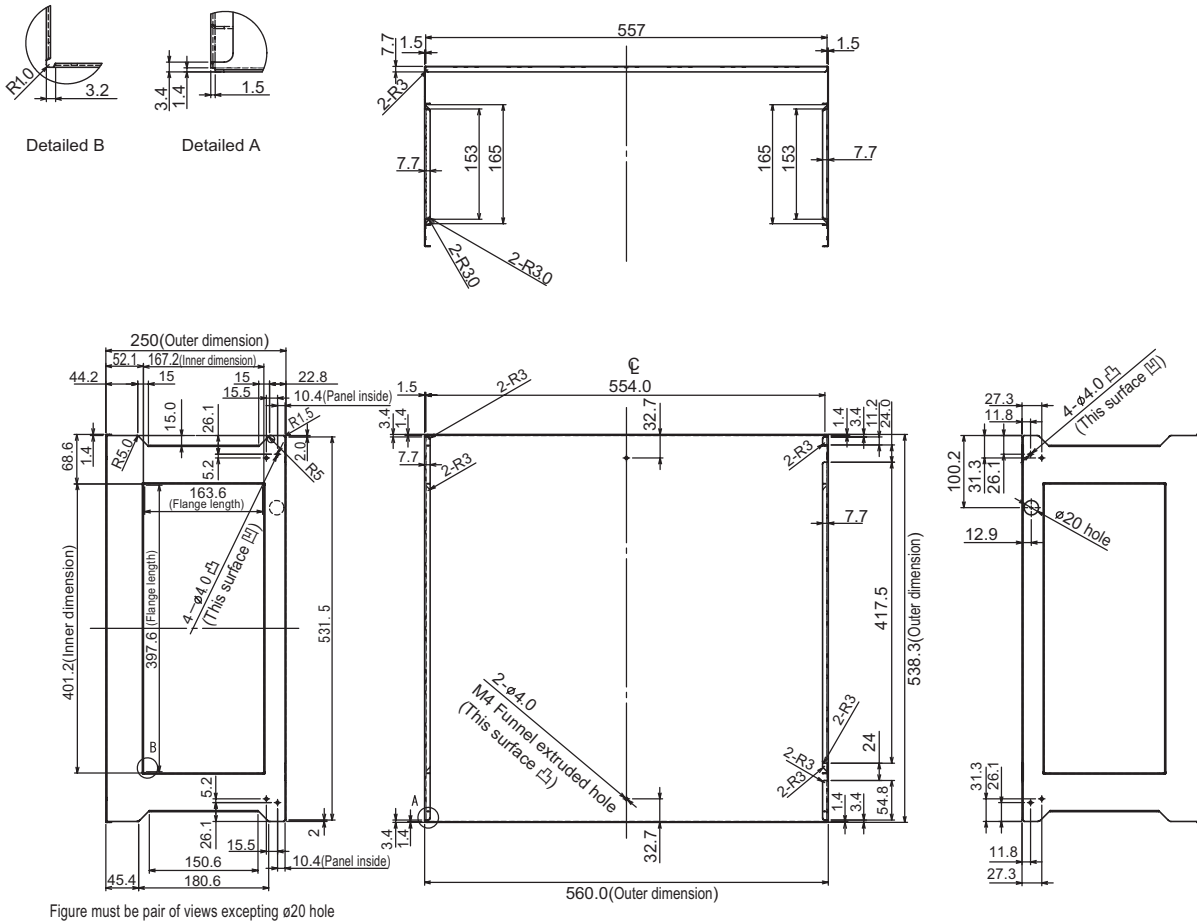
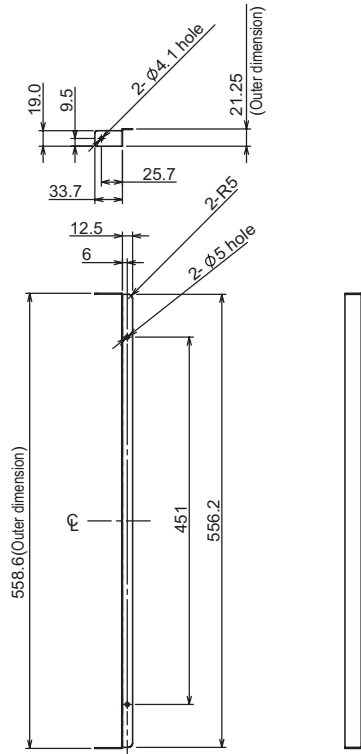


Figure must be pair of views excepting φ20 hole

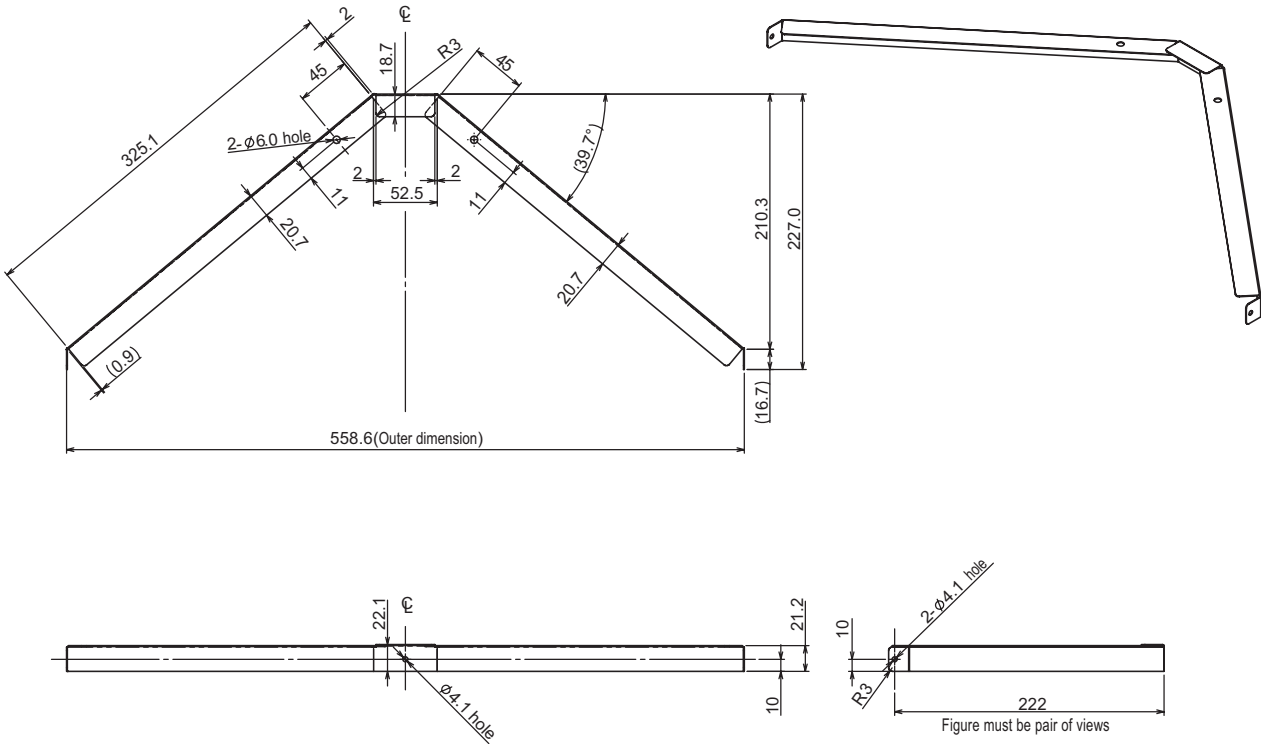
① - ② Reference diagram for wind-proof Pole (field supply)

Unit: mm



① - ③ Reference diagram for wind-proof Bracket (field supply)

Unit: mm

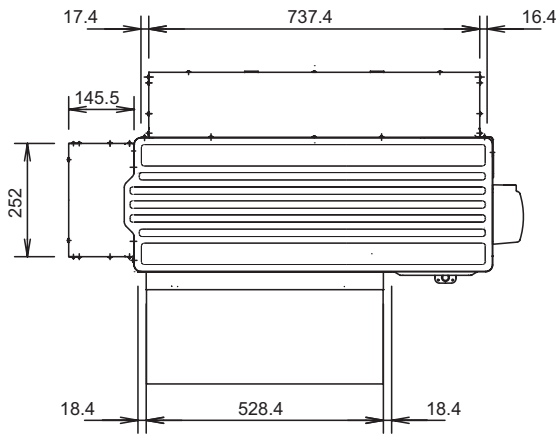




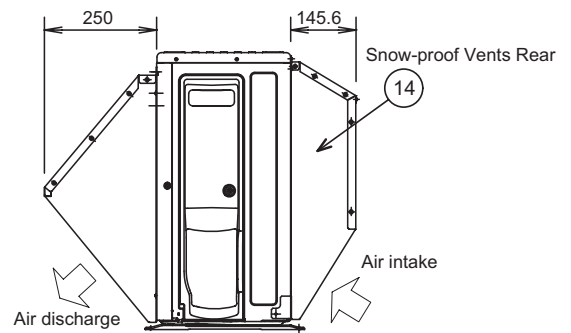
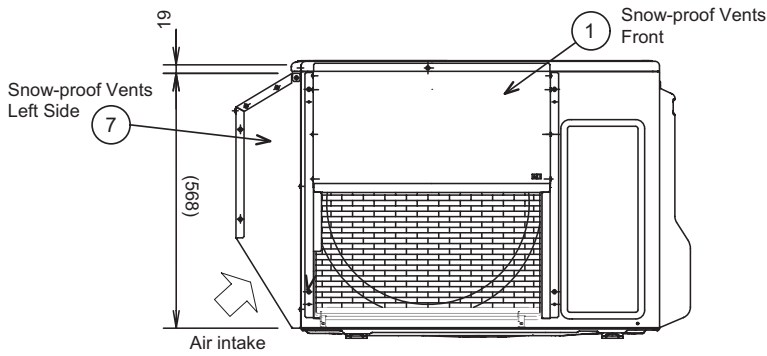
## 2. Dimensions of Snow-proof Vents

### Reference diagram

| RMK | PART NAME            | Q'ty |
|-----|----------------------|------|
| ①   | Snow-proof Front     | 1    |
| ⑦   | Snow-proof Left Side | 1    |
| ⑭   | Snow-proof Rear      | 1    |

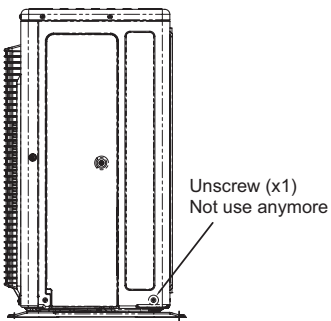


Unit: mm

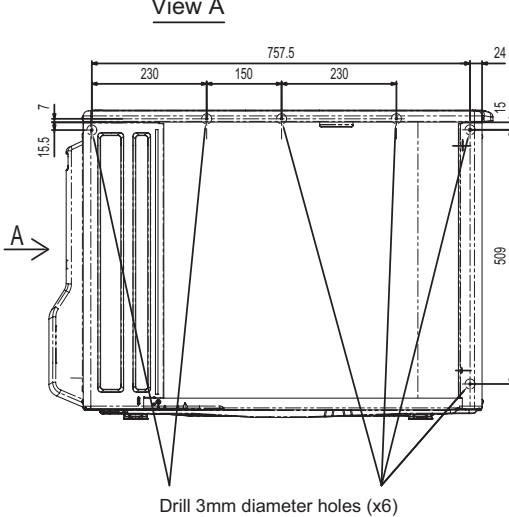


At first, drill holes for installation.

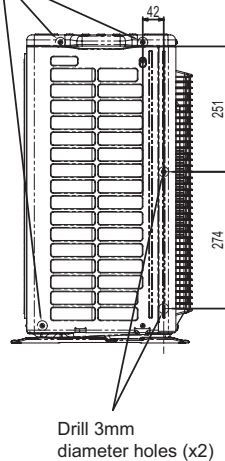
When drilling holes, adjust the blade length to be 16mm or less.



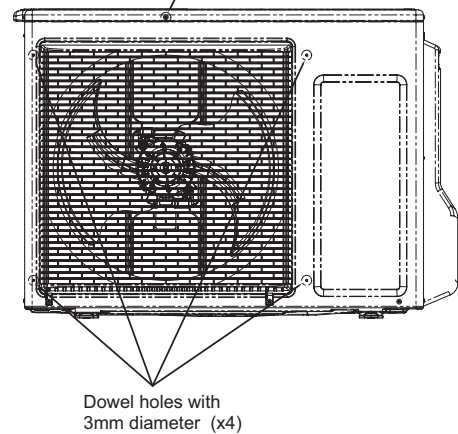
View A



Unscrew (x3)  
Not use anymore

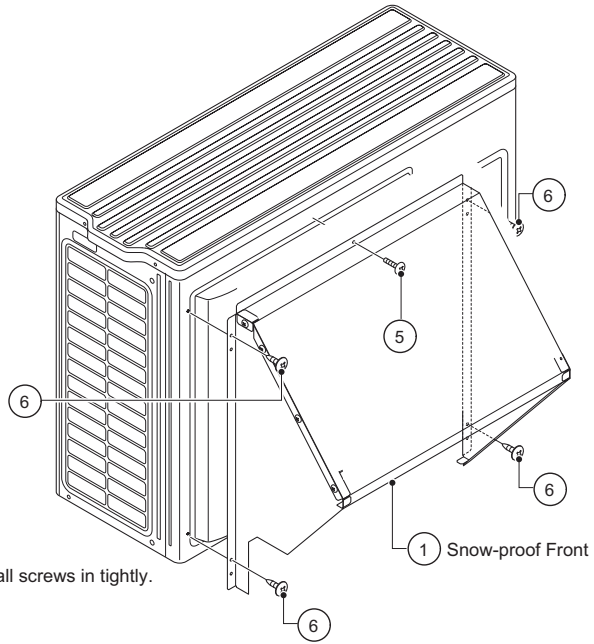
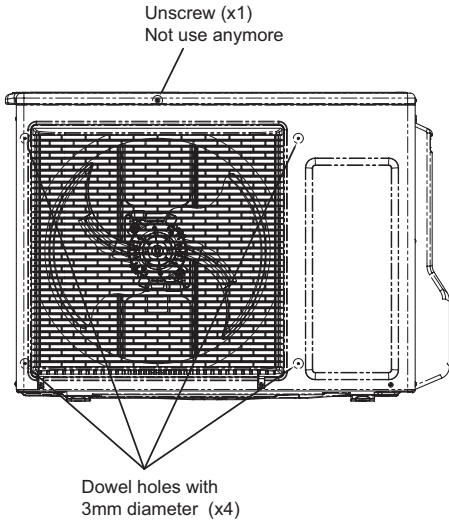


Unscrew (x1)  
Not use anymore



| RMK | PART NAME                                  | Q'ty |
|-----|--|------|
| ①   | Snow-proof Front                           | 1    |
| ⑤   | Snow-proof Front, Tapping Screw (4mm×12mm) | 1    |
| ⑥   | Snow-proof Front, Tapping Screw (4mm×10mm) | 4    |

\*Do not use greater than 12mm length of screw.

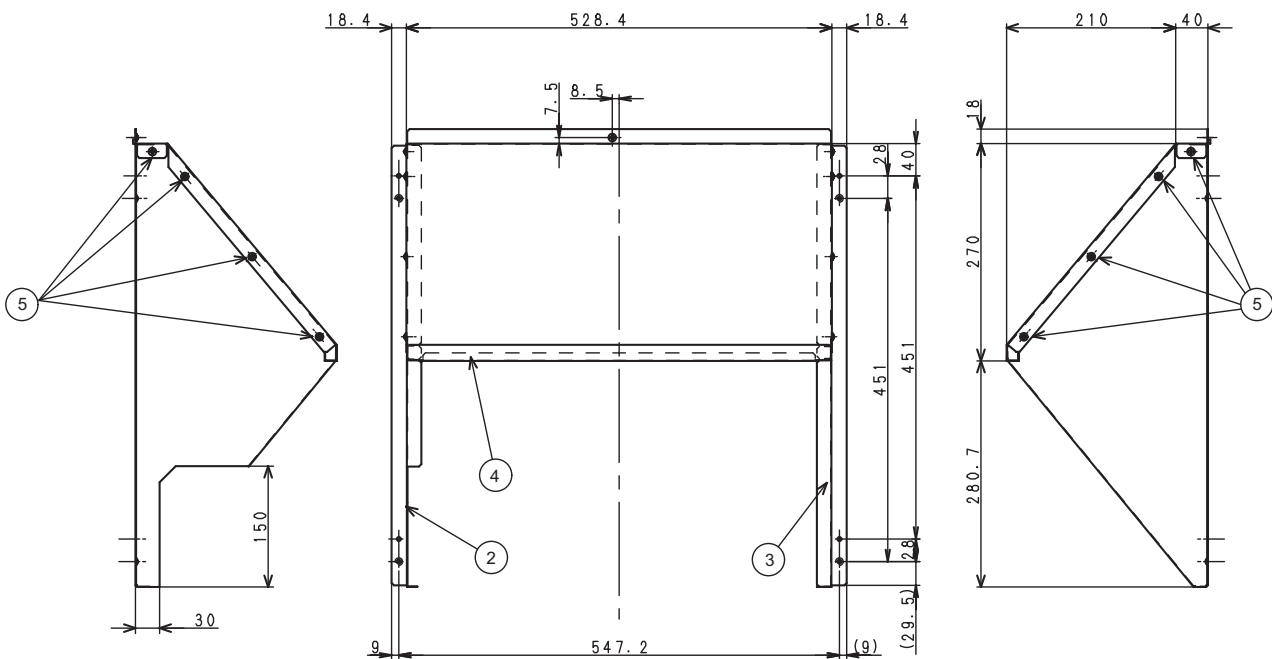


**At first, drill holes for installation.**  
**When drilling holes, adjust the blade length to be 16mm or less.**

**① Reference diagram for Snow-proof Front (field supply)**

| RMK | PART NAME                                  | Q'ty   |
|-----|--|--------|
| ②   | Snow-proof Front, Left Side                | t0.8 1 |
| ③   | Snow-proof Front, Right Side               | t0.8 1 |
| ④   | Snow-proof Front, Upward                   | 1      |
| ⑤   | Snow-proof Front, Tapping Screw (4mm×12mm) | 8      |

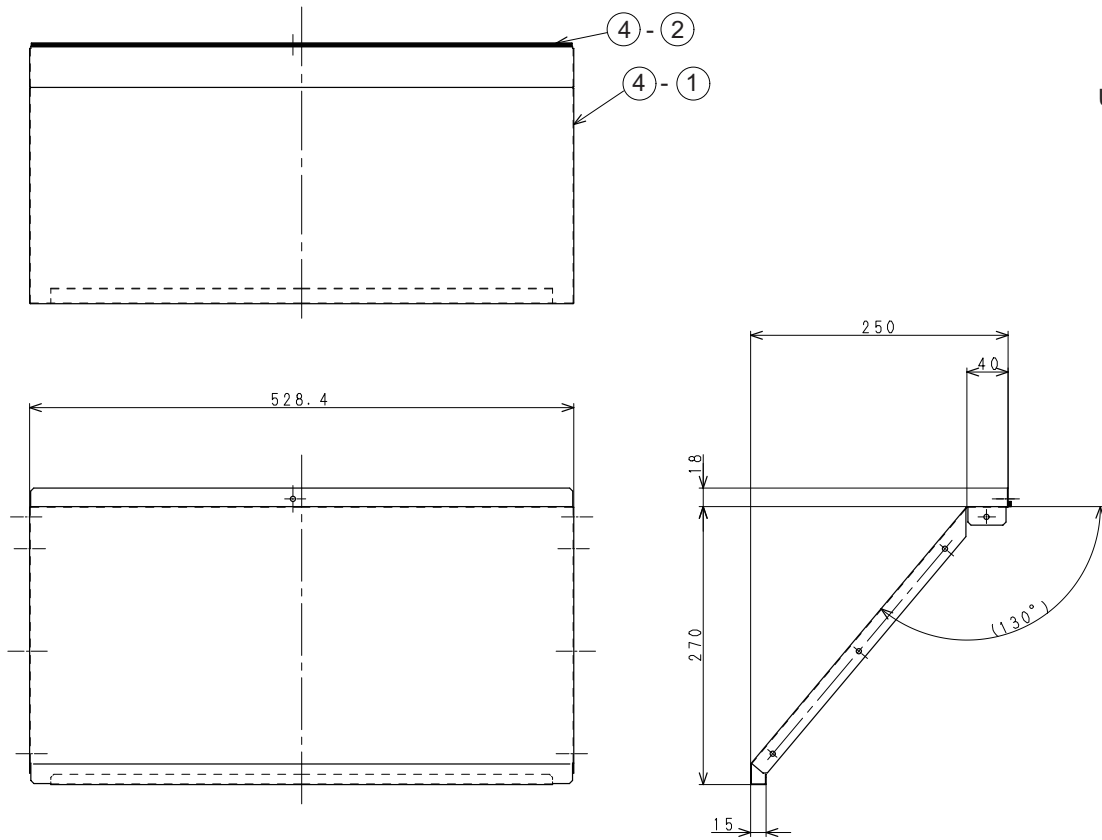
Unit: mm





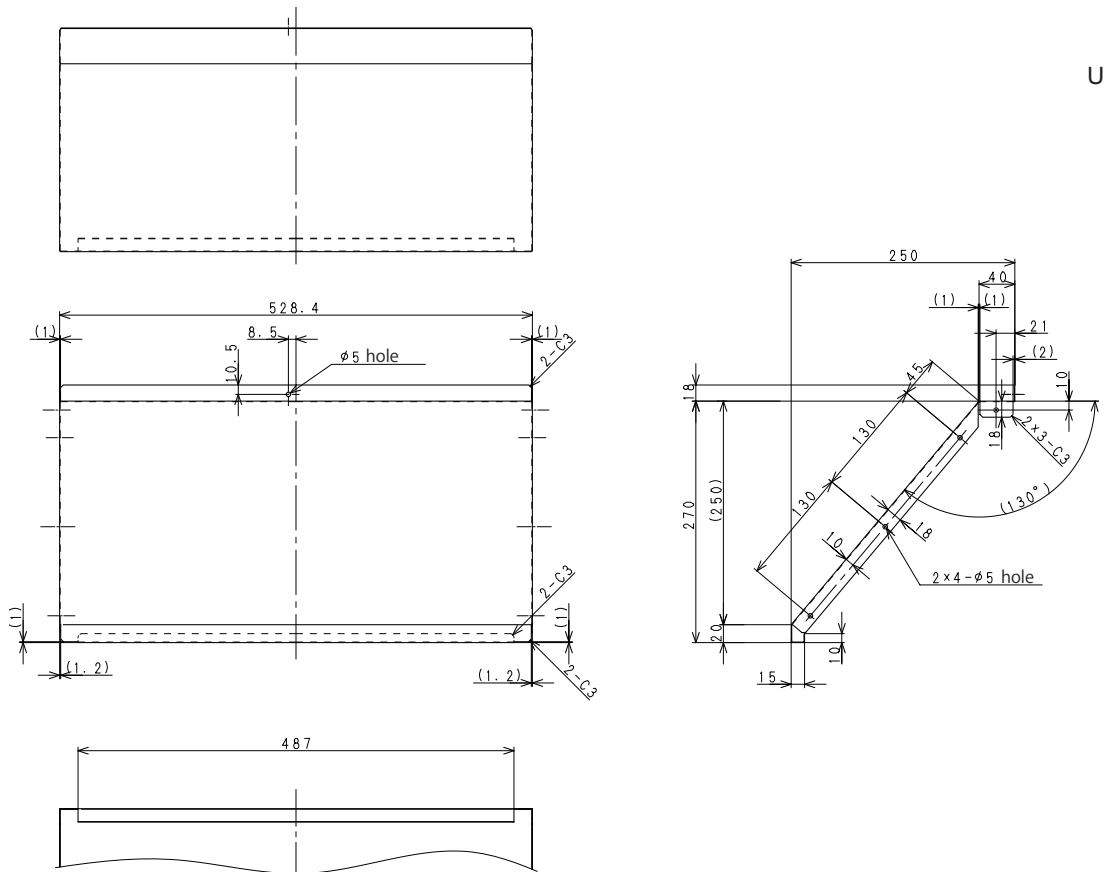
④ Reference diagram for Snow-proof Front, Upward (field supply)

| RMK   | PART NAME                     | t    | Q'ty |
|-------|-------------------------------|------|------|
| ④ - ① | Snow-proof Front, Upward      | t0.6 | 1    |
| ④ - ② | Snow-proof Front, Upward EPDM | t3   | 1    |



Unit: mm

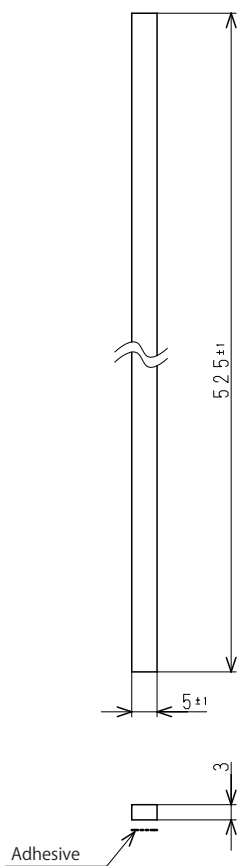
④ - ① Reference diagram for Snow-proof Front, Upward (field supply)



Unit: mm

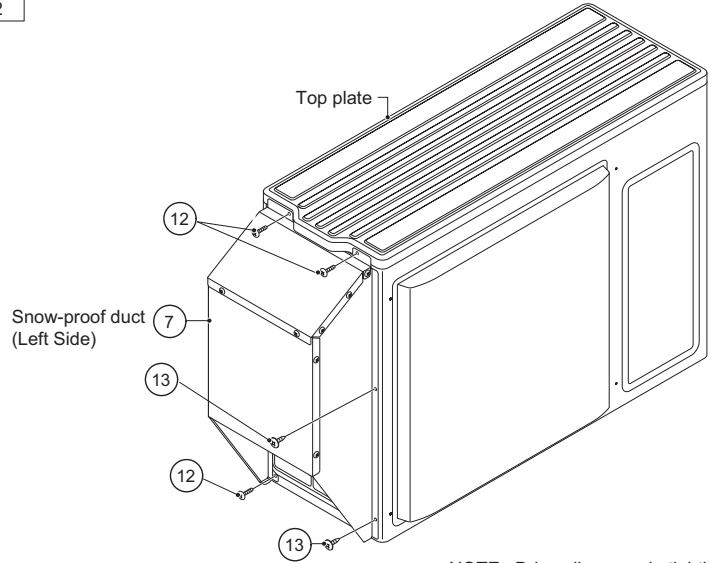
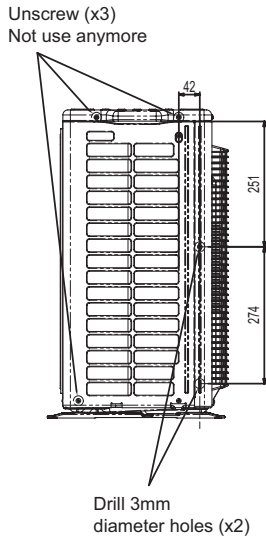
④ - ② Reference diagram for Front Snow-proof Front, Upward EPDM (field supply)

Unit: mm



| RMK | PART NAME                                      | Q'ty |
|-----|--|------|
| ⑦   | Snow-proof Left Side                           | 1    |
| ⑫   | Snow-proof Left Side, Tapping Screw (4mm×12mm) | 3    |
| ⑬   | Snow-proof Left Side, Tapping Screw (4mm×10mm) | 2    |

\*Do not use greater than 12mm length of screw.

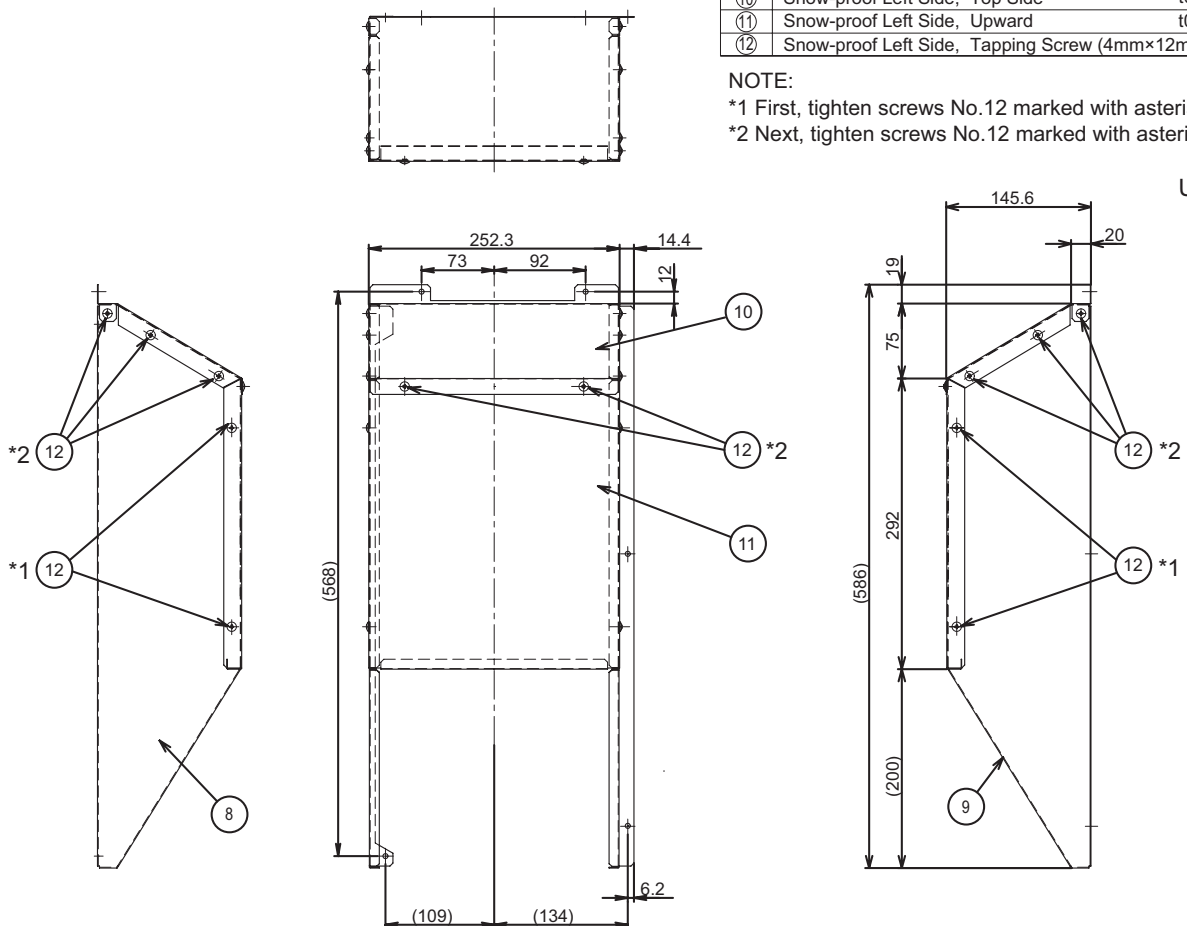


**At first, drill holes for installation.**  
**When drilling holes, adjust the blade length to be 16mm or less.**

**⑦ Reference diagram for Snow-proof Left Side (field supply)**

| RMK | PART NAME                                      | Q'ty   |
|-----|--|--------|
| ⑧   | Snow-proof Left Side, Left Side                | t0.8 1 |
| ⑨   | Snow-proof Left Side, Right Side               | t0.8 1 |
| ⑩   | Snow-proof Left Side, Top Side                 | t0.6 1 |
| ⑪   | Snow-proof Left Side, Upward                   | t0.6 1 |
| ⑫   | Snow-proof Left Side, Tapping Screw (4mm×12mm) | 12     |

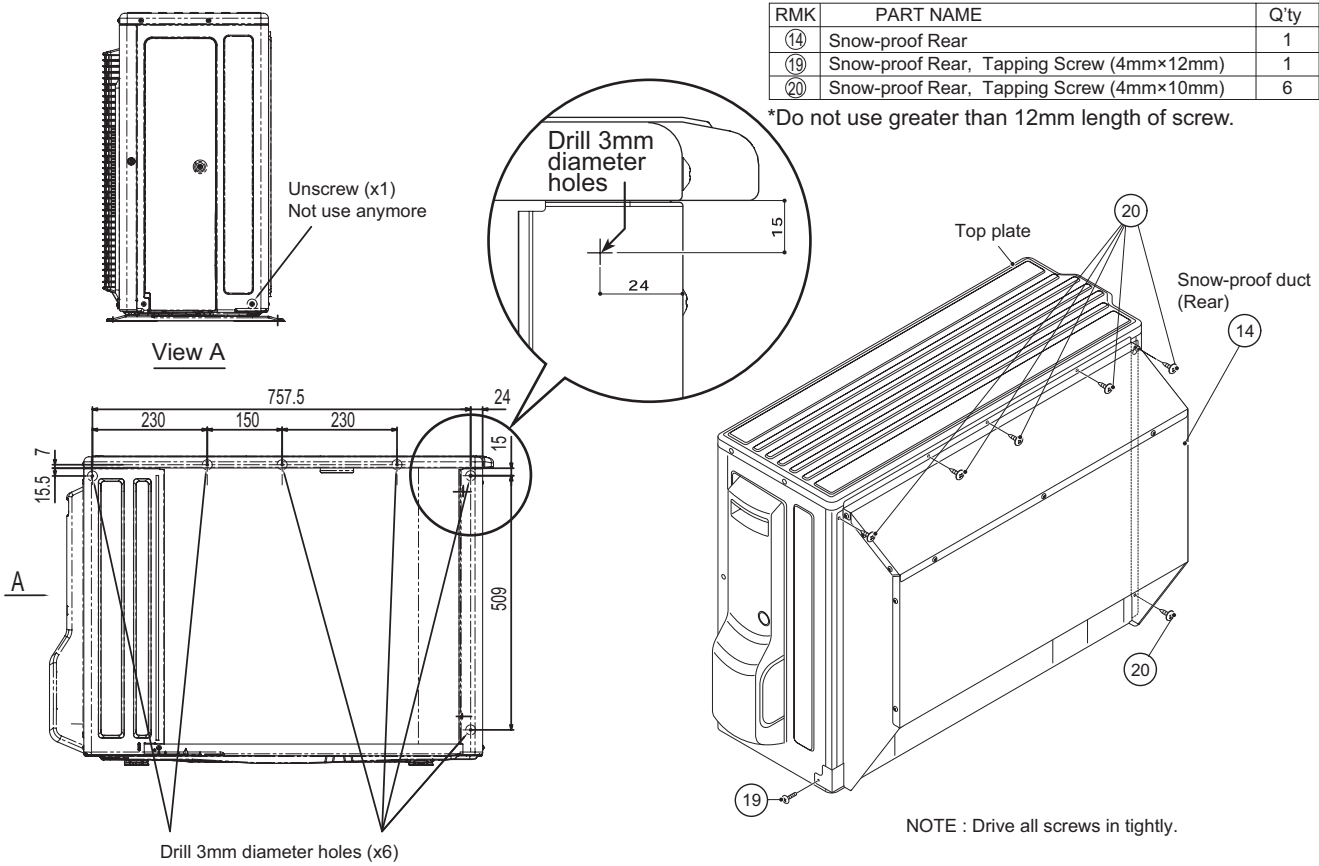
NOTE:  
 \*1 First, tighten screws No.12 marked with asterisk (\*1).  
 \*2 Next, tighten screws No.12 marked with asterisk (\*2).











| RMK | PART NAME                                 | Q'ty |
|-----|---|------|
| 14  | Snow-proof Rear                           | 1    |
| 19  | Snow-proof Rear, Tapping Screw (4mm×12mm) | 1    |
| 20  | Snow-proof Rear, Tapping Screw (4mm×10mm) | 6    |

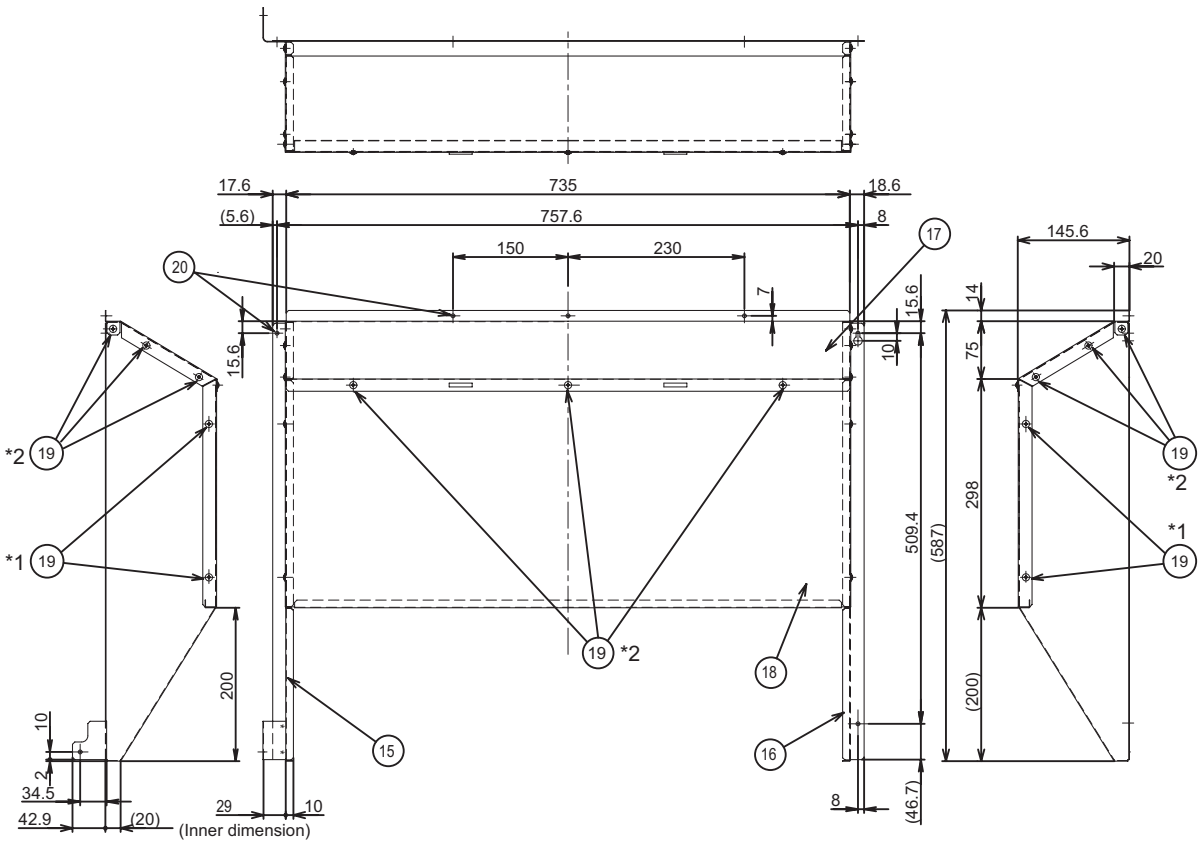
\*Do not use greater than 12mm length of screw.

14 Reference diagram for Snow-proof Rear (field supply)

| RMK | PART NAME                                 | Q'ty   |
|-----|---|--------|
| 15  | Snow-proof Rear, Left Side                |        |
| 16  | Snow-proof Rear, Right Side               | t0.8 1 |
| 17  | Snow-proof Rear, Top Side                 | t0.6 1 |
| 18  | Snow-proof Rear, Upward                   |        |
| 19  | Snow-proof Rear, Tapping Screw (4mm×12mm) | 13     |

NOTE:  
 \*1 First, tighten screws No.12 marked with asterisk (\*1).  
 \*2 Next, tighten screws No.12 marked with asterisk (\*2).

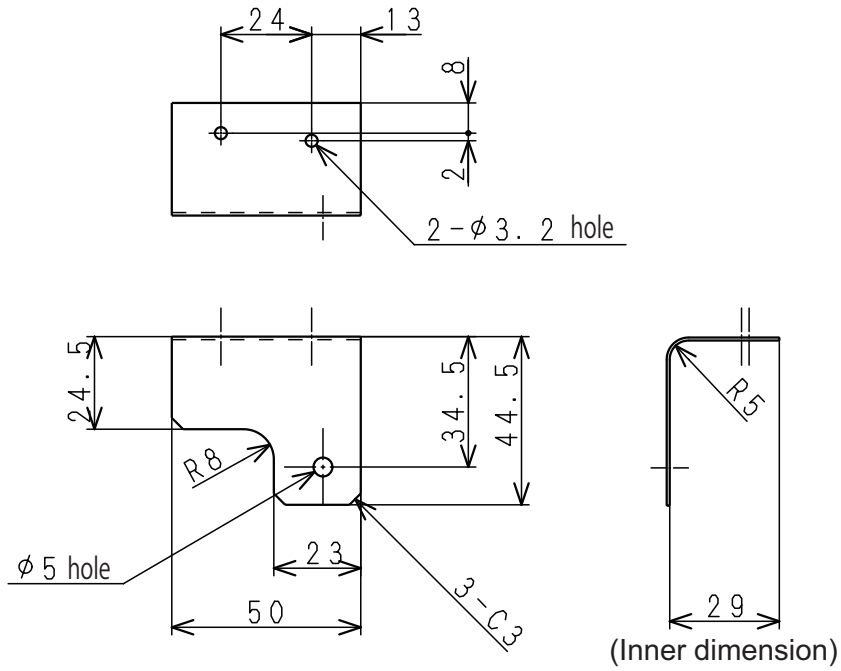
Unit: mm





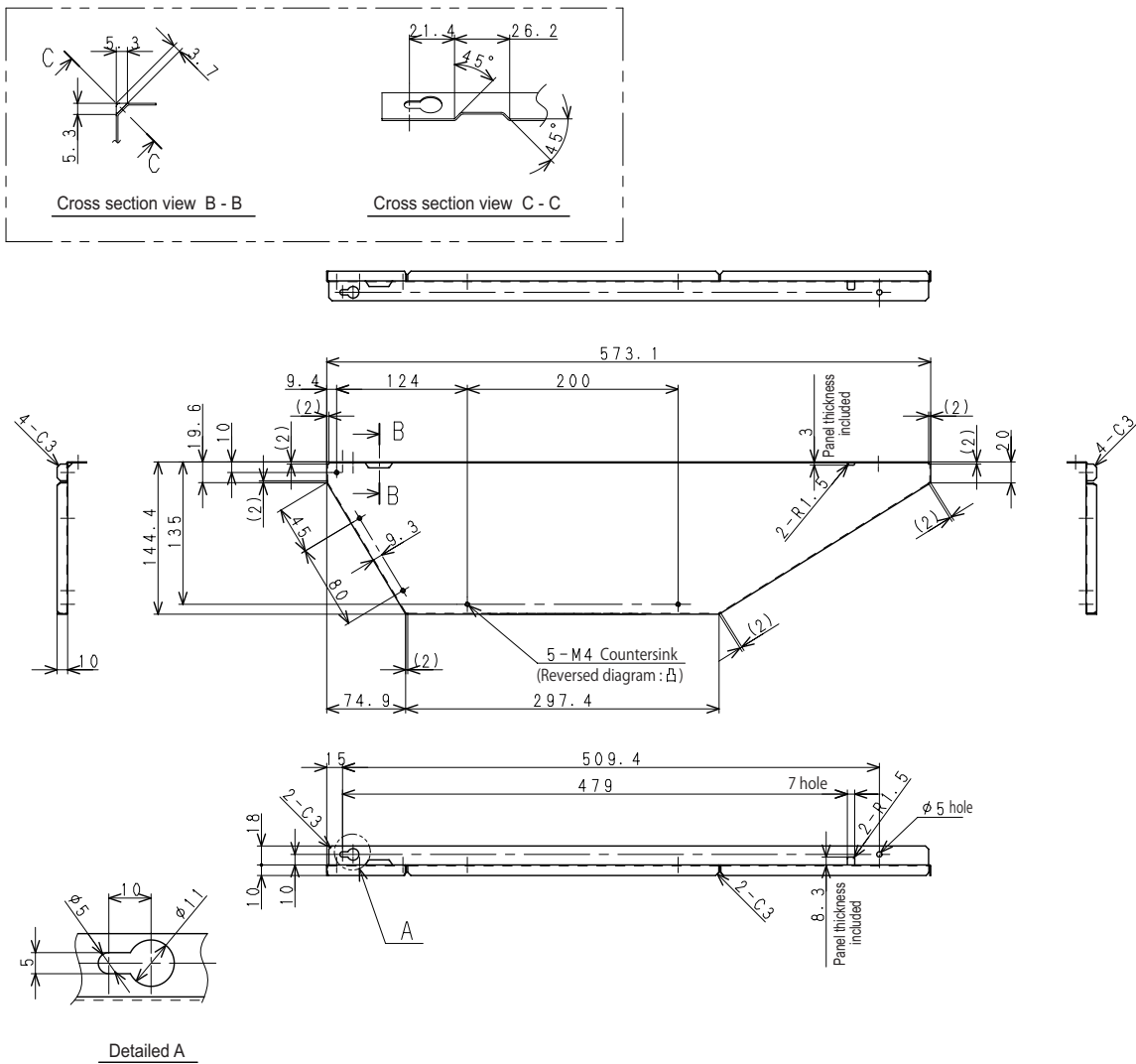
⑮ - ② Reference diagram for Snow-proof Rear, Left Side Bracket (field supply)

Unit: mm



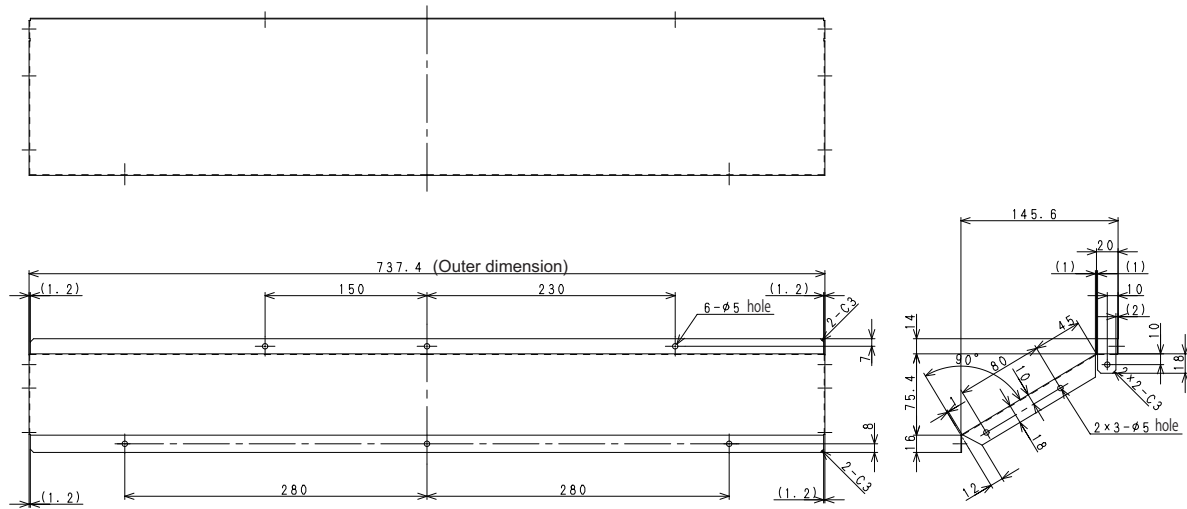
⑯ Reference diagram for Snow-proof Rear, Right Side (field supply)

Unit: mm



⑰ Reference diagram for Snow-proof Rear, Top Side (field supply)

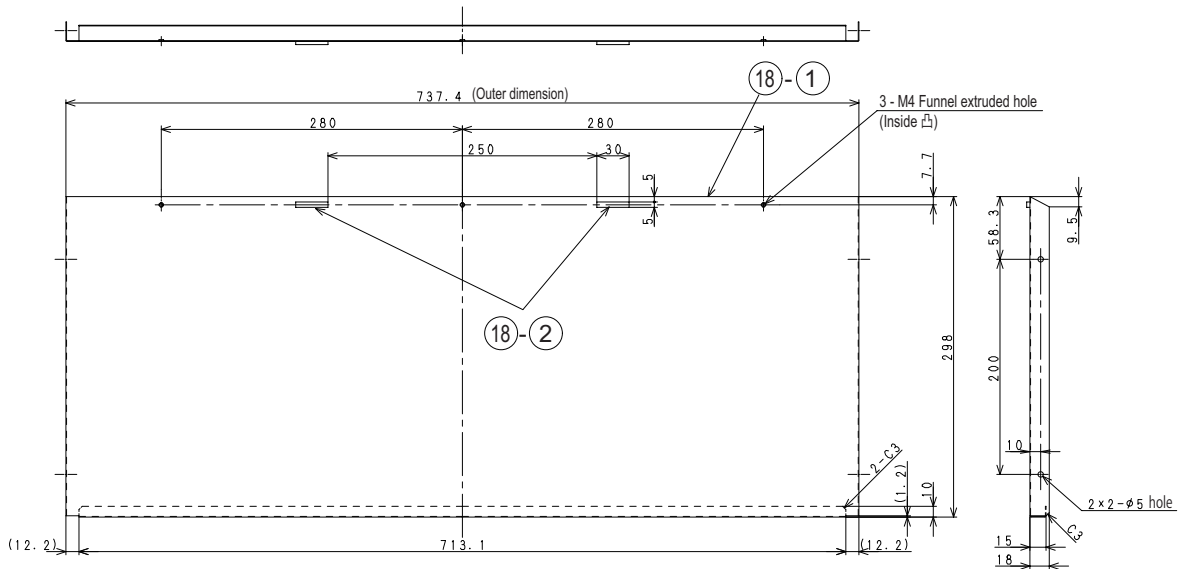
Unit: mm



⑱ Reference diagram for Snow-proof Rear, Upward (field supply)

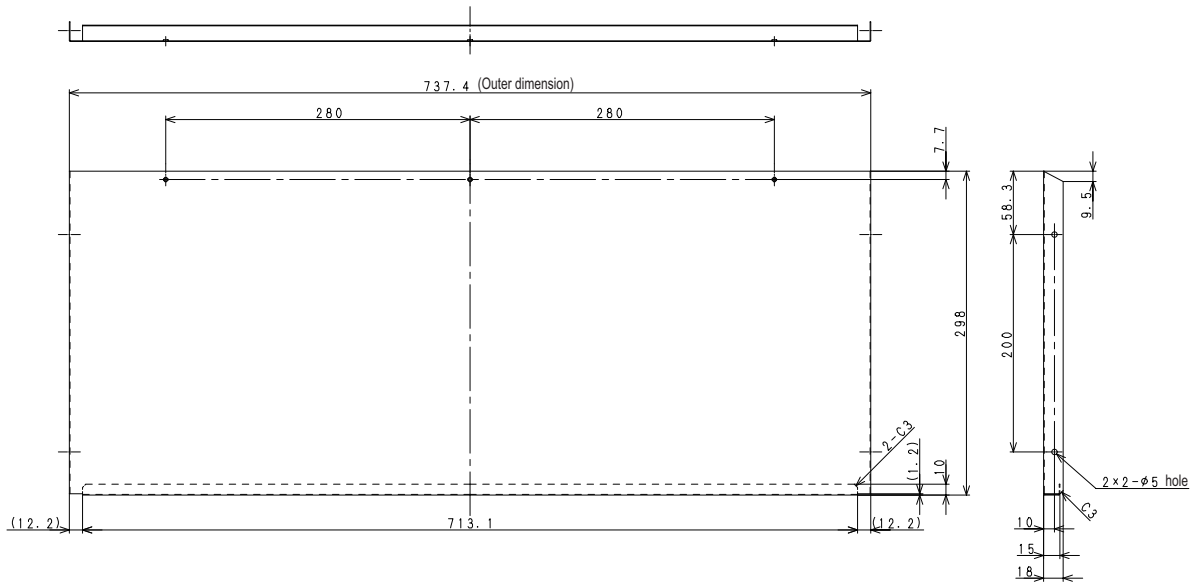
Unit: mm

| RMK | PART NAME                    | Q'ty   |
|-----|------------------------------|--------|
| ⑱-① | Snow-proof Rear, Upward      | t0.6 1 |
| ⑱-② | Snow-proof Rear, Upward EPDM | t3 2   |



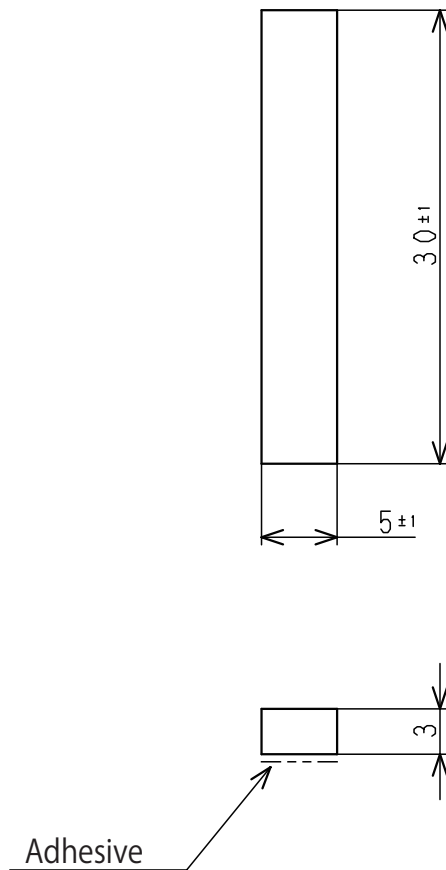
⑱ - ① Reference diagram for Snow-proof Rear, Upward (field supply)

Unit: mm



⑱ - ② Reference diagram for Snow-proof Rear, Upward EPDM (field supply)

Unit: mm






## 2. U-71PE1E5A ~ U-140PE1E5A, U-71PE1E8A ~ U-140PE1E8A U-100PEY1E5, U-125PEY1E5, U-100PEY1E8, U-125PEY1E8, U-140PEY1E8

### ACCESSORIES SUPPLIED WITH OUTDOOR UNIT

The following parts are supplied as accessories with each outdoor unit.

Check that all accessory parts are present before installing the outdoor unit.

| Part name          | Q'ty | Diagram   | Application                         |
|--------------------|------|---|-------------------------------------|
| Protective bushing | 2    |  | For protecting electrical wires     |
| Banding strap      | 4    |  | For tying electrical wires together |

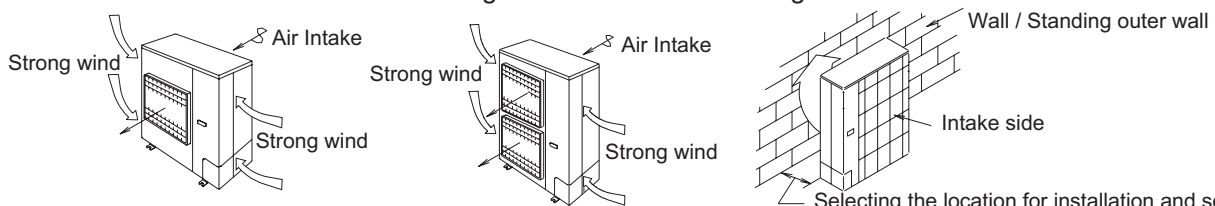
| Part name                 | Q'ty | Diagram  | Application |
|---------------------------|------|--|-------------|
| Installation Instructions |      |  | This manual |

### SELECT THE OUTDOOR UNIT INSTALLATION LOCATION

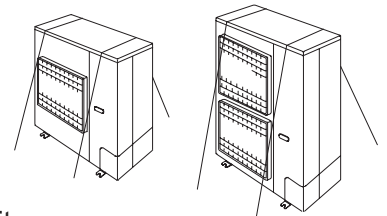


Be careful when picking up and moving the indoor and outdoor units. Get a partner to help, and bend your knees when lifting to reduce strain on your back. Sharp edges or thin aluminum fins on the air conditioner can cut your fingers.

- Install the unit once you have checked that the installation location matches the following conditions.
  - A location with sufficient ventilation.
  - Possibly a location that is sheltered from rain or direct sunlight and is well-ventilated so that hot and cool air does not build up.
  - A location where the area around the discharge is not exposed to animals or plants which could adversely affect the release of hot or cool air from the unit.
  - A location where the discharge and operation noise will not be a nuisance to the neighbours.
  - A location that can support the product's weight or vibrations and secured for horizontal installation wherever possible.
  - A location that does not obstruct the air discharge or intake.
  - A location where there is no danger of flammable or corrosive gas leaks.
  - A location that provides space for installation and service.
  - A location that allows the pipe and cable length fixture for internal and external connections.
  - It may need two or more people to carry out the installation work.
- Refer to the diagram below for the installation location which is exposed to strong wind.
  - If a strong wind of more than 5 m/s blows to the area directly in front of the discharge, the outdoor unit's air flow is reduced and the outflow may re-enter (short circuit) causing the following outcome: "Reduced capacity", "Increased frost formation during heating" or "Operation stopped due to increased pressure".  
Should an exceptionally strong wind blow to the area directly in front of the discharge of the outdoor unit; there is the risk of damage due to the fan's high-speed reverse rotation.
  - If the direction of the prevailing wind is known when operating the unit, place the unit at an appropriate angle to the wind's direction so that the discharge faces towards a building or a wall.



- If installing at locations prone to snowfall, install the unit as high as possible with suitable roofing which shelters the unit from snow.
- Avoid installing the unit in locations where there are petroleum products (such as machine oil), saline content (such as coastal areas), sulphurous gas and where high frequency noise is generated.
- Place the indoor and outdoor unit, power cords and indoor/outdoor unit connection cables at a minimum distance of 1 meter or more away from televisions and radios. This is to avoid interference to picture and/or sound. (However, depending on the electromagnetic waves, noise interference may still occur even with the 1 meter separation.)
- For restaurants and kitchens, avoid installing at locations which draws oil and steam. Plastic parts can deteriorate from droplets of oil and steam or it can cause falling parts or water leakage.
- Avoid installing at the location where cutting oil mist or iron powder is present.
- If there is an immense voltage fluctuation due to the location's problem, ensure to split the power supply.
- When installing the product in a place where it will be affected by typhoon or strong wind such as wind blowing between buildings, including the rooftop of a building and a place where there is no building in surroundings, fix the product with an overturn prevention wire, etc.
- Ensure to assign several people or use a mechanical lift, etc. to transport the unit.



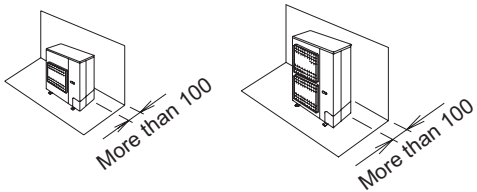
**SELECTING THE LOCATION FOR INSTALLATION SERVICE**

When installing multiple units, allow enough space in between the units and the side of the building.

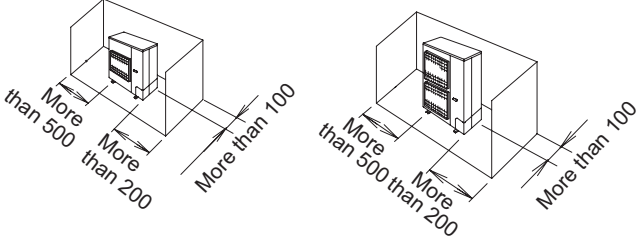
(A) If there are obstacles at the intake

- If the upper part is open
- ① For separate installation location
  - Only if there are obstacles at the intake

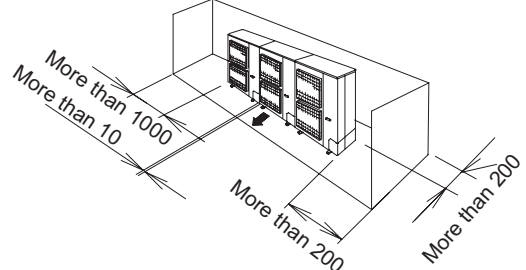
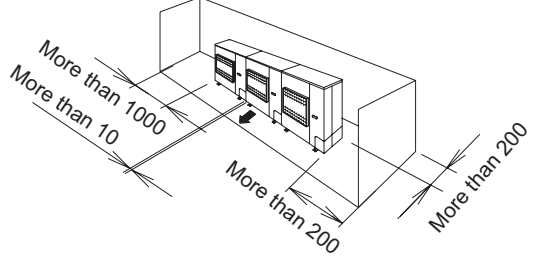
(unit: mm)



- If there are obstacles on both sides

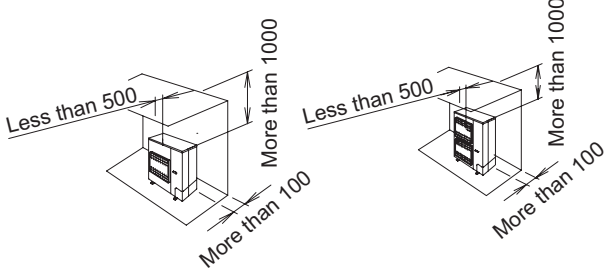


- ② For multiple units (more than 2 units)
  - If there are obstacles on both sides

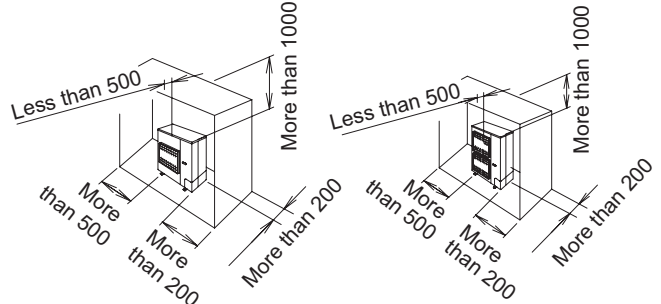


- If there are obstacles above the unit
- ① For separate installation location
  - Only if there are obstacles at the intake

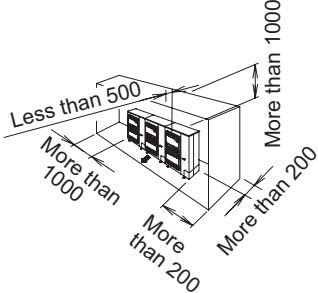
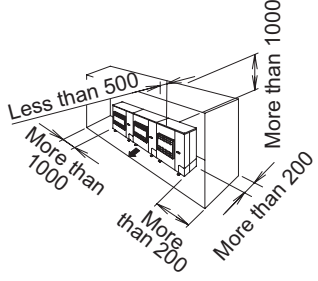
(unit: mm)



- If there are obstacles on the intake and the other side



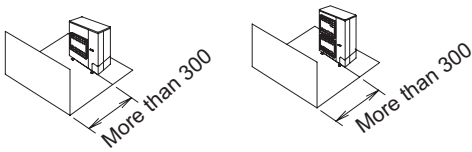
- ② For multiple units (more than 2 units)
  - If there are obstacles on both sides



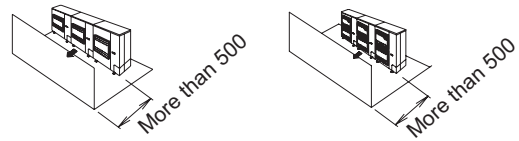
(B) If there are obstacles at the discharge

- If the upper part is open

① For separate installation location



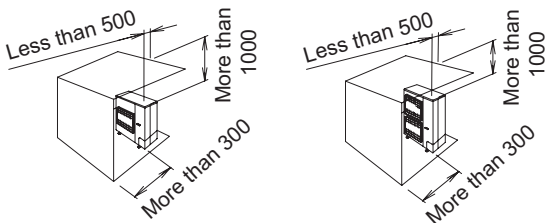
② For multiple units (more than 2 units)



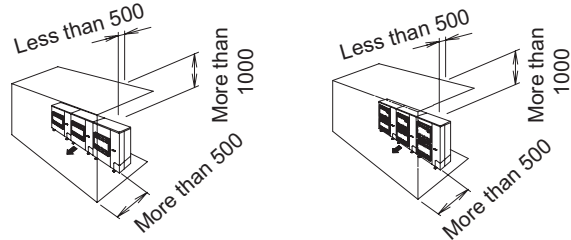
(unit: mm)

- If there are obstacles above the unit

① For separate installation location



② For multiple units (more than 2 units)



(unit: mm)

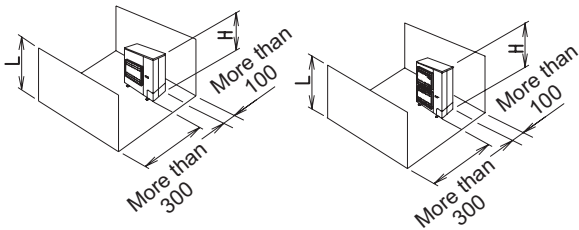
(C) If there are obstacles on both the intake and discharge

Pattern 1

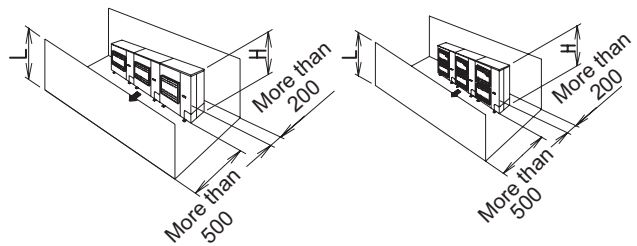
If there is an obstacle that is higher than the unit on the intake side.  
(There is no limit to the height of the obstacle above the discharge.)

- If the upper part is open

① For separate installation location



② For multiple units (more than 2 units)



(unit: mm)

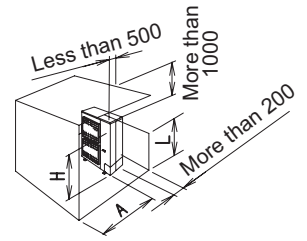
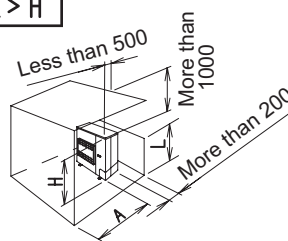
- If there are obstacles above the unit

① For separate installation location

- The dimensions for H, A and L are shown in the following table.

|       | L   | A   |
|-------|---|-----|
| L ≤ H | 0 < L ≤ 1/2 H                             | 300 |
|       | 1/2 H < L ≤ H                             | 500 |
| H < L | Install a pedestal or mount so that L ≤ H |     |

L > H



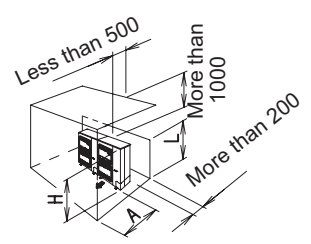
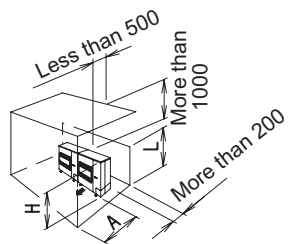
(unit: mm)

- Cover the bottom part of the pedestal or mount so that air does not go through it.

② For multiple units (up to 2 units)

- The dimensions for H, A and L are shown in the following table.

|       | L   | A   |
|-------|---|-----|
| L ≤ H | 0 < L ≤ 1/2 H                             | 500 |
|       | 1/2 H < L ≤ H                             | 750 |
| H < L | Install a pedestal or mount so that L ≤ H |     |



- Cover the bottom part of the pedestal or mount so that air does not bypass it.
- A limit of only 2 units can be installed.



**Pattern 2**

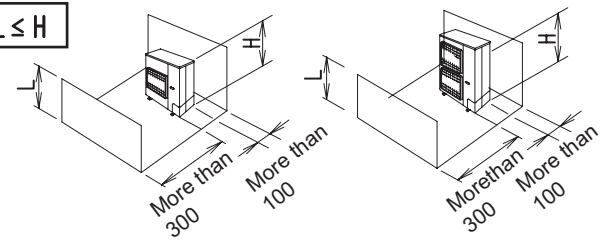
If there is an obstacle that is higher than the unit on the discharge side.  
(There is no limit to the height of the obstacle above the discharge.)

- If the upper part is open

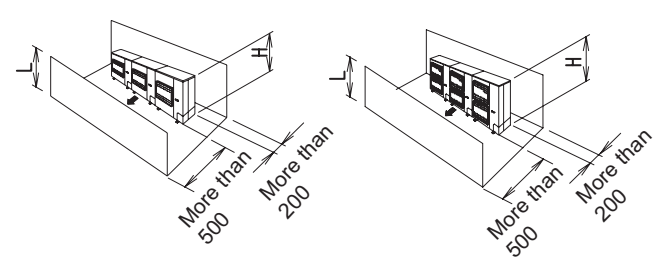
(unit: mm)

- ① For separate installation location

**L ≤ H**



- ② For multiple units (more than 2 units)



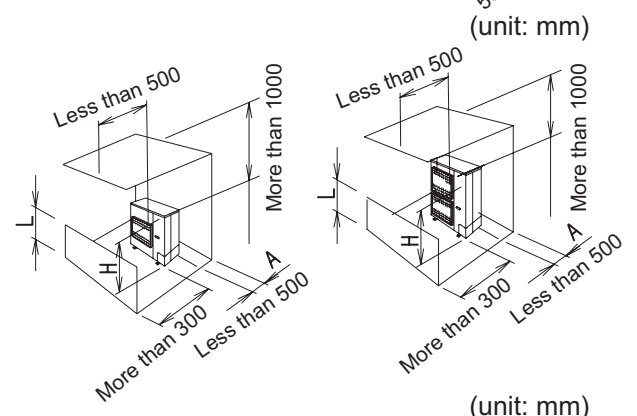
- If there are obstacles above the unit

- ① For separate installation location

- The dimensions for H, A and L are shown in the following table.

|       |   |
|-------|---|
|       | A   |
| L ≤ H | 100                                       |
| H < L | Install a pedestal or mount so that L ≤ H |

- Cover the bottom part of the pedestal or mount so that air does not go through it.

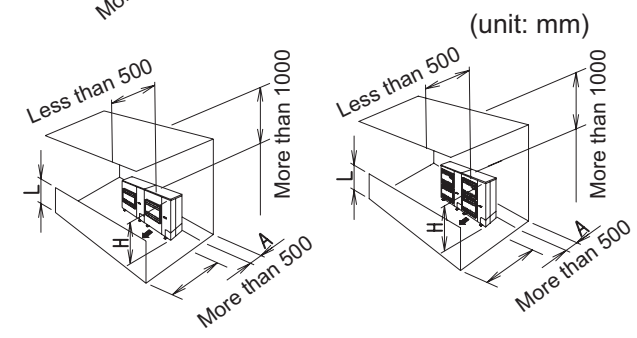


- ② For multiple units (up to 2 units)

- The dimensions for H, A and L are shown in the following table.

|       |   |
|-------|---|
|       | A   |
| L ≤ H | 200                                       |
| H < L | Install a pedestal or mount so that L ≤ H |

- Cover the bottom part of the pedestal or mount so that air does not bypass it.
- A limit of only 2 units can be installed.

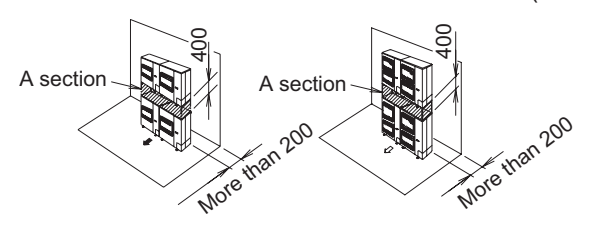
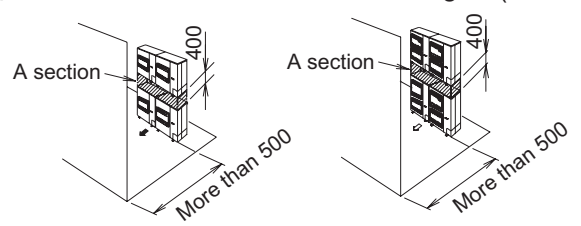


**(D) Stacking installation setup**

- Stack up to 2 tiers.
- A dimension of approximately 400 mm is required for the second tier outdoor unit's drain pipe and space for maintenance of the first tier outdoor unit.
- Close A section (the space between the upper and lower level outdoor units) so the outtake air does not bypass it.

- ① If there are obstacles at the discharge (unit: mm)

- ② If there are obstacles at the intake (unit: mm)



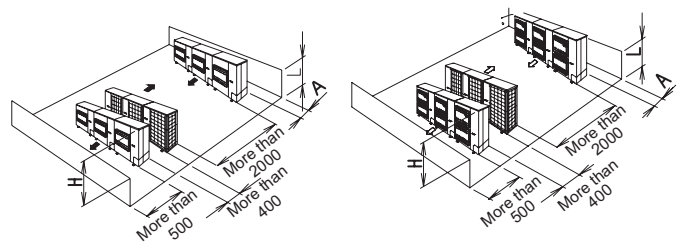
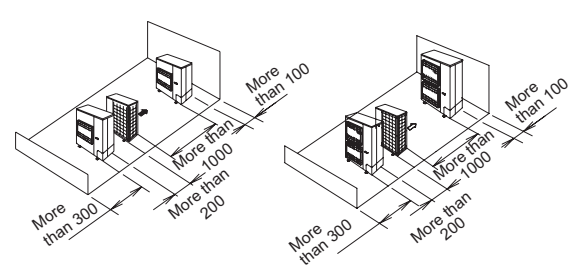
**(E) For multiple row installation (on the roof, etc.)**

- ① For one row installation setup (unit: mm)

(unit: mm)

- ② For multiple units (more than 2 units) (unit: mm)

(unit: mm)



- The dimensions for H, A and L are shown in the following table.

|       |                           |
|-------|---------------------------|
|       | A                         |
| L ≤ H | 200                       |
| H < L | Installation not possible |

- The above mentioned distance is required for optimal unit performance. Allow as much space as possible in order to obtain the best performance from the units.

## TRANSPORT AND INSTALL THE OUTDOOR UNIT

### • Transporting

1. Transport the outdoor unit in its original packaging as close as possible to the installation location.
2. In the event that the unit needs to be lifted or suspended, use a rope or belt and use cloth or wood as padding to avoid damaging the unit.
3. Use the side handles to carry the unit and be careful not to touch the fan with your hand or any objects.

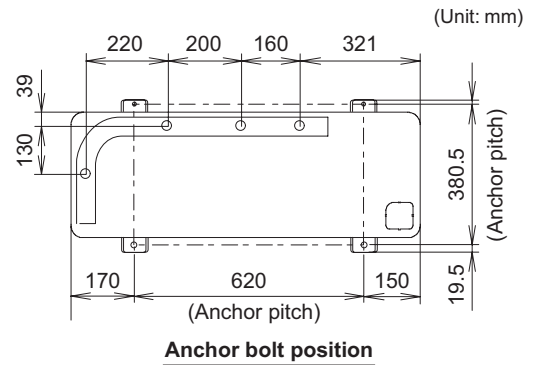
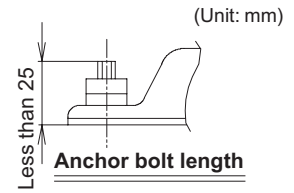
### • Installation

1. Read the "Select the outdoor unit installation location" thoroughly before installing the outdoor unit.
2. When installing to a concrete or solid surface, use M10 or a W 3/8 bolts and nuts to secure the unit. Ensure that it installed upright on a horizontal plane. (Use an anchor bolt for the installation as shown in the diagram at right.)
3. Avoid installing on the slanted roof.
4. In the even where the roof is at risk of receiving oscillations or vibrations, secure the unit with a seismic isolating mount or vibration absorbing rubber.
5. The drain water will be discharged from the unit during heating or defrosting operation mode.

Select an appropriate location with good drainage system. (In the winter, there is risk of slipping due to freezing, and depending on the installation set up there is risk of drain water running overhead.)

× Please consult us if installing drain elbows.

× In cold regions (where the outdoor temperature can drop to below 0° for 2 to 3 consecutive days), the drain water may freeze and may prevent the fan from operating. For this case, do not use the drain elbow.



## REFRIGERANT INSTALLATION

For indoor unit refrigerant piping installation, refer to the Installation Instruction manual that comes with that indoor unit. Do not reuse existing piping, install new piping.

### 1. Precautions during refrigerant installation.

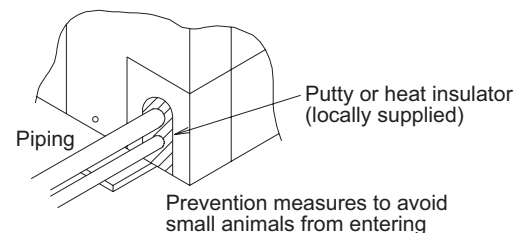
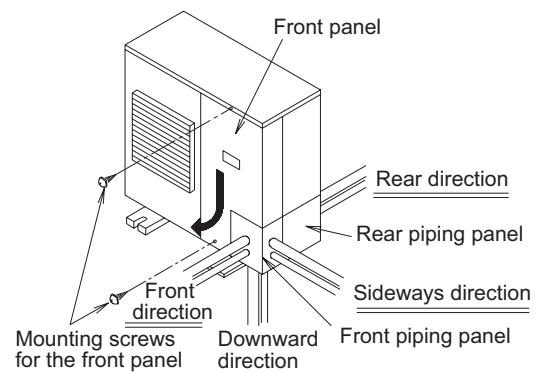
- Use clean pipes with no dust inside.

The pipe may corrode with the presence of fluorine dust which will adversely affect the refrigerant piping system due to deterioration of the refrigerant oil, etc.

- This unit is specifically for R410A. Ensure to adhere to the following items and install accordingly:
  - Use pipe cutters and flaring tools which are specially designed for use with R410A.
  - When connecting with flaring tools, coat the flare section with ether-based oil.
  - Ensure to use flare nuts supplied with the unit when connecting this unit.
  - Only for storing or for open pipes.
  - Set the lower limit of the allowable pipe length to 5m. If the pipe is shorter than 5m, the refrigerant may become overfilled and a problem such as abnormal high pressure could occur.

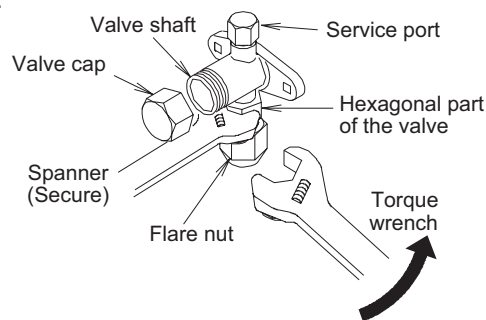
### 2. The local pipes can protrude from any four directions.

- Make holes in the pipe panel for the pipes to penetrate it and lay the pipes accordingly.
  - It is recommended to apply additional substance to the cut area for anti-rust protection.
- Ensure to install pipe panels to prevent rain water from getting into the unit.
- Close the gap at the pipe connected area with putty or heat insulator (locally supplied).
  - If an insect or small animal enters the outdoor unit, there is the risk of shorting in the product electronic casing. [Remove the front panel]
    - (1) Remove the 2 mounting screws.
    - (2) Slide the front panel using your hands downwards to release the pawls. Then remove by pulling the panel towards you.

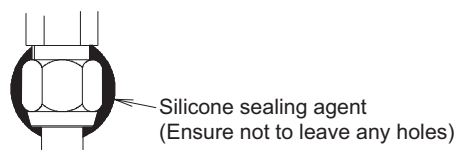


**Precautions when operating the 3-way valve for piping installation**

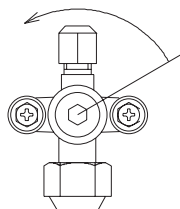
- Do not open the 3-way valve until the piping installation is completed.
  - It is closed during shipment.
  - During installation the side panel may warp if only the flare nut is loosened and tightened with a torque wrench. As a result, always be sure to secure to the hexagonal part of the 3-way valve with a spanner, or other tool.
- Refer to the following table for the tightening torque of the 3-way valve flare nuts.
  - If the nuts are over tightened, they may cause the flares to break or leak.
- Do not add additional force to the valve's cover.
  - Using spanners on the cover or valve itself (other than the hexagonal parts) may cause gas leakage. Avoid using spanners on the cover or parts other than the hexagonal part of the valve.



- During the cooling mode operation under low ambient pressure, the low pressure side of the valve can be prone to freezing. Secure the flare nut (shared gas side / liquid side) section of the valve with a silicone sealing agent to prevent this from occurring.



[3-way valve operation method] • Use an Allen wrench (Size 4 mm or 6 mm).  
Direction to open



Opening : Open the cover and turn the Allen wrench counter-clockwise until it stops.  
Closing : Open the cover and turn the Allen wrench clockwise until it stops.

**Precautions for handling the valve cap**

- Ensure not to scratch the inner surface of the valve or the end of the valve shaft.
- Once adjustments to the valve are completed, ensure to tighten the valve cap according to the prescribed torque.

| Valve size | Tightening torque                      |
|------------|--|
| ø9.52      | 20.6N•m~28.4N•m<br>{2.1kgf•m~2.8kgf•m} |
| ø15.88     | 48.0N•m~59.8N•m<br>{4.8kgf•m~6.0kgf•m} |

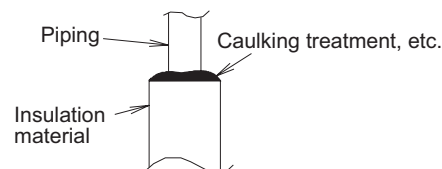
**Precautions for handling the service ports**

- Use a push-rod with a charge hose.
- Once adjustments to the valve are completed, ensure to tighten the valve cap according to the prescribed torque.

| Tightening torque                      |
|--|
| 10.7N•m~14.7N•m<br>{1.1kgf•m~1.5kgf•m} |

**Precautions for connecting the pipes**

- Ensure that the pipes do not come into contact with the compressor's bolts or exterior panel.
- There is a risk of condensation from the 3-way valve coming out between the insulation material and the indoor unit's piping when you install the outdoor unit above then the indoor unit. Ensure to caulk the connection parts.

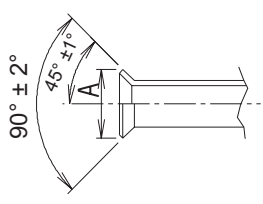


**Precautions for insulation installation**    **Maximum temperature limit of gas or liquid piping exceeds 120 °C**

- In high humidity environment, reinforce the insulation material for the refrigerant piping. Failure to do so may result in condensation on the surface of the insulation material.
- Use materials with good heat-resistant properties as the heat insulator for the pipes. Ensure to insulate both the gas side and liquid side pipes. If the pipes are not adequately insulated, condensation and water leakages may occur.
- Ensure that the current insulation covers the pipes up to the unit's connecting part. If the piping is exposed , it may cause condensation or burn (when touch the pipe).

## Precautions for flare nut installation

- Dimensions when adding flare nuts and the tightening torque (unit: mm)

| Piping size | Tightening torque                          | Flare section dimensions A | Flare configuration   |
|-------------|--|----------------------------|---|
| ø 6.35      | 14.2N·m ~ 17.2N·m<br>{1.4kgf·m ~ 1.7kgf·m} | 8.7 ~ 9.1                  |  |
| ø 9.52      | 32.7N·m ~ 39.9N·m<br>{3.3kgf·m ~ 4.0kgf·m} | 12.8 ~ 13.2                |   |
| ø 12.7      | 49.5N·m ~ 60.3N·m<br>{5.0kgf·m ~ 6.0kgf·m} | 16.2 ~ 16.6                |   |
| ø 15.88     | 68.0N·m ~ 75.5N·m<br>{6.8kgf·m ~ 7.6kgf·m} | 19.3 ~ 19.7                |   |

After piping connection has completed, ensure there is no gas leakage.

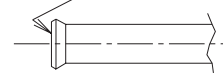
- When tightening the flare nut, coat the flares (inner surface only) with refrigerant oil on the flares

Firstly, screw in 3-4 turns by hand.

※ Ensure not to get oil on the screw part.

Refrigerant oil used is ether-based.

Application for ether-based oil



- Once the piping connections are completed, perform leakage inspection using nitrogen gas.

## VACUUM PURGING

- Once the piping connections are completed, perform leakage inspection using nitrogen gas (leak tightness test) using the 3-way valve for the outdoor unit and then close it.

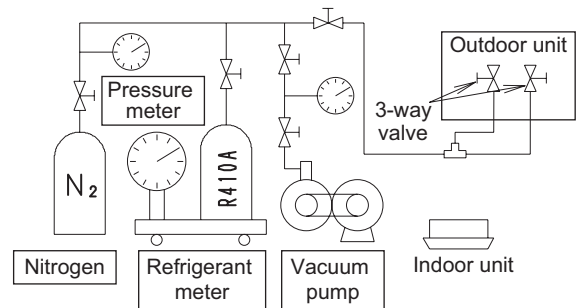
Test the pressure :

3.8 MPa : Type PE1

4.15 MPa : Type PEY1

- Ensure to use a vacuum pump (with a back-flow prevention device) for inside the refrigerant system.
- Vacuuming process will take place after the leak test.

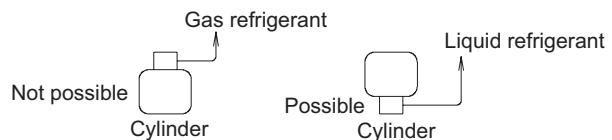
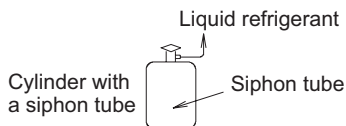
Use nitrogen gas for the leak tightness test.  
Using flammable gas can cause an explosion.



## REGARDING REFRIGERANT FILLING

### Precautions during refrigerant filling

- Ensure to fill only with liquid refrigerant when refilling. If gas refrigerant is filled, the refrigerant composition will not be balanced and will cause abnormal operation.
- If using cylinders as shown in the bottom left diagram; without a siphon tube inside, turn it upside down and use it. (It is recommended to use the manifold with the side glass.)



- Use tools that are designed specifically for R410A, for pressure resistance and to prevent mixing impurities.
- Fill the refrigerant from the 3-way valve's service port on the liquid-side.

For filling and replacing all refrigerant (For refilling due to a leak)

- For refilling refrigerant, first collect all residual refrigerant and after vacuum dehydration using the vacuum pump. Refill the refrigerant according to the prescribed amount stated on the placard affixed to this unit.

Precautions after the pipes' connection have completed

- Ensure to open the 3-way valve after completing the piping installation, leak test and vacuuming. If it is closed during operation, it can lead to compressor failure.

## Charging with refrigerant

### For Type PE1

- At the time of shipment from the factory, this unit is charged with enough refrigerant for an equivalent pipe length of 30m. If the equivalent pipe length used will be 30m or less, no additional charging will be necessary.
- If the equivalent pipe length will be between 30 and 50 / 75m, charge with additional refrigerant according to the equivalent length given in the table below.


|                  | Additional charging amount | Equivalent length | Minimum length |
|------------------|----------------------------|-------------------|----------------|
| U-71PE1          | 50g/m                      | 50m               | 5m             |
| U-100/125/140PE1 | 50g/m                      | 75m               | 5m             |

### For Type PEY1

- At the time of shipment from the factory, this unit is charged with enough refrigerant for an equivalent pipe length of 30m. If the equivalent pipe length used will be 30m or less, no additional charging will be necessary.
- If the equivalent pipe length will be between 30 and 50m, charge with additional refrigerant according to the equivalent length given in the table below.

|                   | Additional charging amount | Equivalent length | Minimum length |
|-------------------|----------------------------|-------------------|----------------|
| U-100/125/140PEY1 | 50g/m                      | 50m               | 5m             |

- Pump down operation
  - Operate the pump down according to the following procedures.

|   | Procedure   | Remarks  |
|---|---|--|
| 1 | Stop operation both outdoor and indoor units.   |  |
| 2 | Remove the cap and hood (bonnet) on the service port of the gas (wide tube) side from the outdoor unit. Then connect the pressure gauge (local supply) to the service port of the gas (wide tube) side.   | <ul style="list-style-type: none"> <li>• Be sure to use the pressure gauge (local supply) which is specific to low pressure measurable.</li> </ul>   |
| 3 | Short-circuit the pump down pin (PUMPDOWN) on the control PCB of the outdoor unit for 1 second or longer. Use a flathead screwdriver and short-circuit the pin.   | <ul style="list-style-type: none"> <li>• If the pump down pin (PUMPDOWN) on the control PCB of the outdoor unit is short circuit, refrigerant recovery control is started in the cooling operation.</li> <li>• The indoor fan is operated in High mode during pump down operation and the compressor drives in 60Hz.</li> </ul>  |
| 4 | When 2 or 3 minutes have passed after the start of outdoor unit operation, fully close the liquid (narrow tube) side valve of the outdoor unit.   | <ul style="list-style-type: none"> <li>• Refrigerant recovery will start.</li> <li>• The LED 1 on the control PCB of the outdoor unit blinks and LED 2 illuminates.</li> <li>• Maintenance function indication (  ) will blink on the LCD display of the wired remote controller (CZ-RTC2).</li> </ul>  |
| 5 | When the pressure gauge installed at the service port reaches the desired pressure of 0.2MPa - 0.1MPa, fully close the gas (wide tube) side valve of the outdoor unit. Then again short-circuit the pump down pin (PUMPDOWN) on the control PCB of the outdoor unit for 1 second or longer. | <ul style="list-style-type: none"> <li>• If the pump down operation has continued for over 10 minutes or the pump down pin (PUMPDOWN) on the control PCB of the outdoor unit is short circuit for 1 second or longer, the outdoor and indoor units will stop even though the pump down has not completed yet.</li> <li>• Do not operate the outdoor unit until the pressure value reaches negative pressure. Otherwise, this will cause the compressor trouble.</li> </ul> |
| 6 | Remove the pressure gauge installed at the gas (wide tube) side of the outdoor unit. Then reinstall the cap and hood (bonnet) in the original position once removed in the Step 2 described above.  | <ul style="list-style-type: none"> <li>• The pump down operation is completed.</li> </ul>  |

### NOTE

If you normally operate the refrigerant recovery unit, fully open both the liquid and gas valves of the outdoor unit.

**COMBINATION OF INDOOR UNIT CONNECTION**

**Twin, Triple and Double Twin Type Connections for Type PE1**

- Two, three or four indoor units can be operated simultaneously with a single remote controller. Note that individual operation is not possible.
- Master unit and slave unit can be set automatically in twin and triple system. No address setting is necessary.
- Applicable “TWIN” and “TRIPLE” combination table.

|             | Outdoor unit | Type 71 | Type 100 | Type 125 | Type 140 |
|-------------|--------------|---------|----------|----------|----------|
| TWIN        | combination  |         |          |          |          |
| TRIPLE      | combination  | —       |          |          |          |
| DOUBLE TWIN | combination  | —       | —        |          | —        |

**Twin Type Connections for Type PEY1**

- This unit cannot make triple or double twin connections.
- Two indoor units can be operated simultaneously with a single remote control unit. Note that individual operation is not possible.
- Master unit and slave unit can be set automatically in twin system. No address setting is necessary.
- Applicable “TWIN” combination table.

|      | Outdoor unit | Type 100 | Type 125 | Type 140 |
|------|--------------|----------|----------|----------|
| TWIN | combination  |          |          |          |

## Piping Connections

**For Type PE1**

- The following table shows the pipe diameter. (Branch pipe kit should be used) (unit: mm)

| Outdoor unit main pipe diameter (mm)                 | Branch pipe diameter | Indoor unit combination |             |             |              |              |
|--|----------------------|-------------------------|-------------|-------------|--------------|--------------|
|  |                      | S-36                    | S-45        | S-50        | S-60         | S-71         |
| Liquid side : $\phi 9.52$<br>Gas side : $\phi 15.88$ | Liquid side          | $\phi 6.35$             | $\phi 6.35$ | $\phi 6.35$ | $\phi 9.52$  | $\phi 9.52$  |
|  | Gas side             | $\phi 12.7$             | $\phi 12.7$ | $\phi 12.7$ | $\phi 15.88$ | $\phi 15.88$ |
| Branch pipe kit (option)                             | TWIN, DOUBLE TWIN    | CZ-P155BK1              |             |             |              |              |
|  | TRIPLE               | CZ-P3HPC2               |             |             |              |              |

- The following table shows the equivalent pipe lengths and height differences.

|   | SYMBOLS                             |   |   | SPEC                                   |
|---|-------------------------------------|---|---|--|
|   | TWIN                                | TRIPLE  | DOUBLE TWIN   |  |
| Total pipe length   | $L+La+Lb$                           | $L+La+Lb+Lc$  | $L+La+Lb+Lc+Ld+Le+Lf$   | U-60/71P : 50m<br>U-100/125/140P : 75m |
| Maximum branch pipe length                                    | $La$ or $Lb$                        | $La$ or $Lb$ or $Lc$                                  | $La+Lc$ or $La+Ld$ or $Lb+Le$ or $Lb+Lf$  | Less than 15m                          |
| Maximum branch pipe length difference                         | $La > Lb$<br>$La - Lb$              | $La > Lb > Lc$<br>$La - Lb$<br>$Lb - Lc$<br>$La - Lc$ | $Lb+Lf \rightarrow \text{MAX}$<br>$La+Lc \rightarrow \text{MIN}$<br>$(Lb + Lf) - (La + Lc)$ | Less than 10m                          |
| Maximum pipe length difference of branch pipe 1 (DOUBLE TWIN) | —                                   | —   | $Lb > La$<br>$Lb - La$  | Less than 10m                          |
| Maximum pipe length difference of branch pipe 2 (DOUBLE TWIN) | —                                   | —   | $Ld > Lc$<br>$Lf > Le$<br>$Ld - Lc$<br>$Lf - Le$  | Less than 10m                          |
| Height difference   | Outdoor located higher installation | H1  |   | Less than 30m                          |
|   | Outdoor located lower installation  | H1  |   | Less than 15m                          |
| Height difference between indoor units                        | H2                                  | H2 or H3 or H4  | H2 or H3 or H4 or H5 or H6 or H7  | Less than 0.5m                         |

**For Type PEY1**

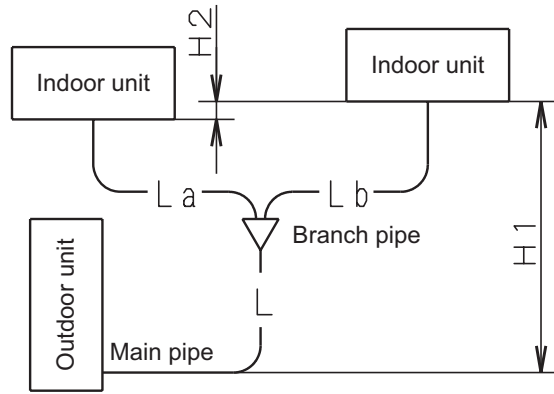
- The following table shows the pipe diameter. (Branch pipe kit should be used) (unit: mm)

| Outdoor unit main pipe diameter (mm)                 | Branch pipe diameter | Indoor unit combination |              |              |
|--|----------------------|-------------------------|--------------|--------------|
|  |                      | S-50                    | S-60         | S-71         |
| Liquid side : $\phi 9.52$<br>Gas side : $\phi 15.88$ | Liquid side          | $\phi 6.35$             | $\phi 9.52$  | $\phi 9.52$  |
|  | Gas side             | $\phi 12.7$             | $\phi 15.88$ | $\phi 15.88$ |
| Branch pipe kit (option)                             | TWIN                 | CZ-P155BK1              |              |              |

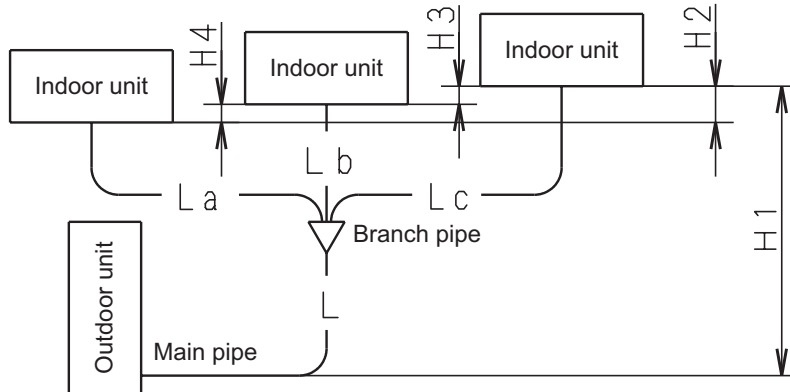
- The following table shows the equivalent pipe lengths and height differences.

|  | SYMBOLS                             |    | SPEC           |
|--|-------------------------------------|----|----------------|
|  | TWIN                                |    |                |
| Total pipe length                      | $L+La+Lb$                           |    | Less than 50m  |
| Maximum branch pipe length             | $La$ or $Lb$                        |    | Less than 15m  |
| Maximum branch pipe length difference  | $La > Lb$<br>$La - Lb$              |    | Less than 10m  |
| Height difference                      | Outdoor located higher installation | H1 | Less than 30m  |
|  | Outdoor located lower installation  | H1 | Less than 15m  |
| Height difference between indoor units | H2                                  |    | Less than 0.5m |

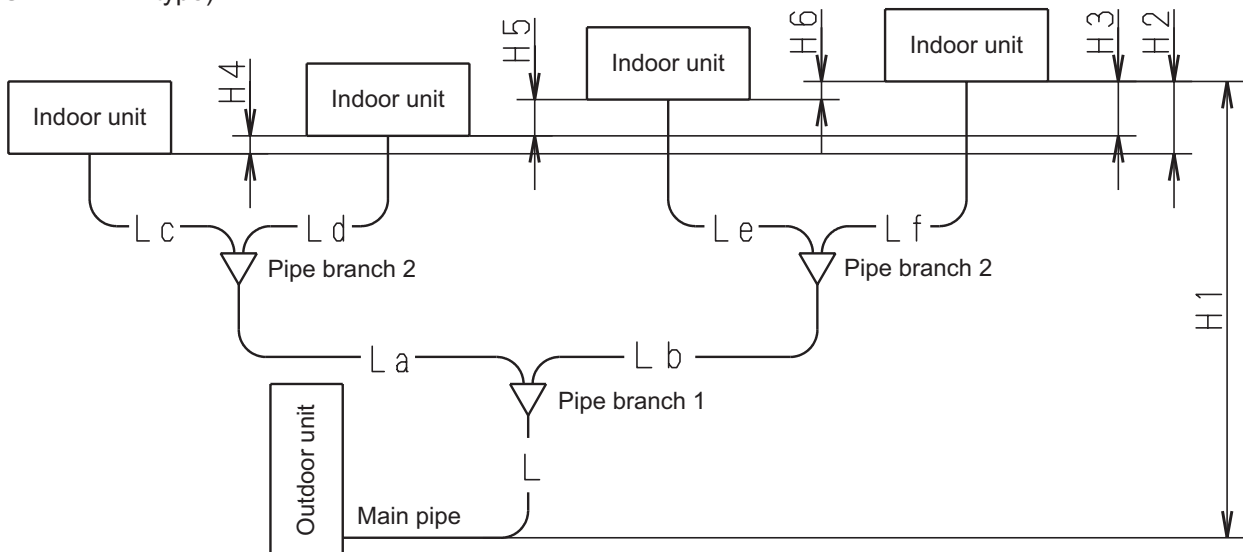
(TWIN type)



(TRIPLE type)



(DOUBLE TWIN type)



- Use the main pipe to gain any rise or fall required for the pipes.
- The number of bends should be 8 or less in a single system, and 15 or less overall.
- Branch pipes should be positioned horizontally.



Refrigerant charging

**For Type PE1**

- For the twin connection, the amount of refrigerant required for pipe length 30m has been included in this unit at the factory while that required for pipe length 20m has been included for the triple/double-twin connections. No additional charge is required for the first 30m pipe length in the case of the twin connection and for the first 20m in the case of the triple/double-twin connections. The amount of included refrigerant for each model is listed on NAME PLATE.

Make additional charges by adding up pipe length in an order of main pipe (L) → branch pipe (La → Lb → Lc wide diameter) and then selecting the amount of refrigerant corresponding to the remaining (after 30m for the twin connection and after 20m for the triple/double-twin connections) liquid side pipe diameter and pipe length from the below table.

(unit: mm)

| Liquid pipe diameter | Addition amount of refrigerant [g/m] |
|----------------------|--------------------------------------|
| ø6.35                | 20                                   |
| ø9.52                | 50                                   |

**For Type PEY1**

- For the twin connection, the amount of refrigerant required for pipe length 30m has been included in this unit at the factory. No additional charge is required for the first 30m pipe length in the case of the twin connection. The amount of included refrigerant for each model is listed on NAME PLATE.

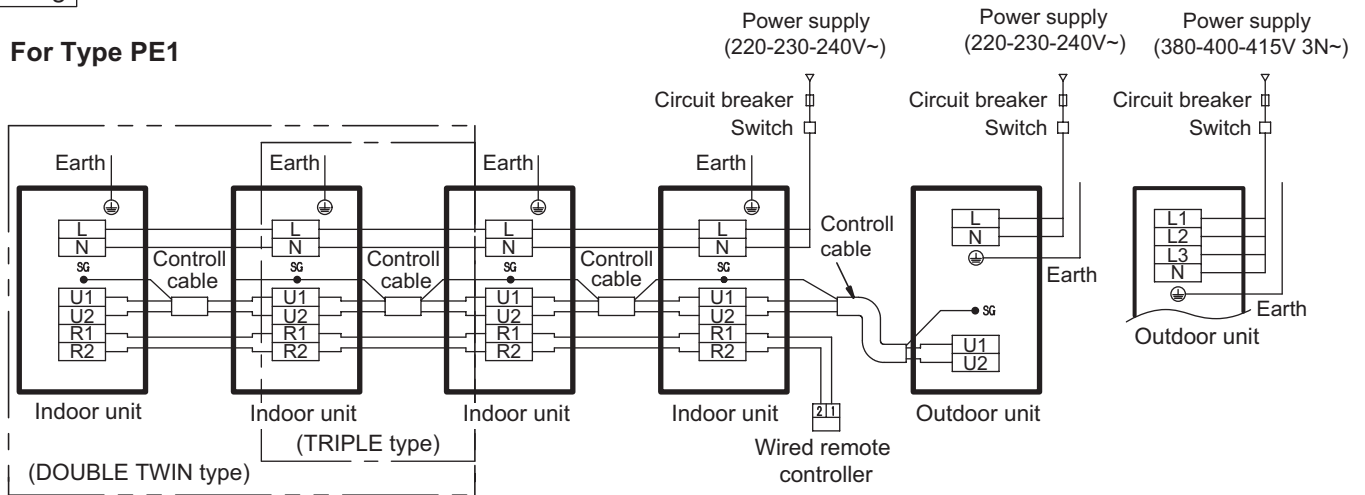
Make additional charges by adding up pipe length in an order of main pipe (L) → branch pipe (La → Lb wide diameter) and then selecting the amount of refrigerant corresponding to the remaining (after 30m for the twin connection) liquid side pipe diameter and pipe length from the below table.

(unit: mm)

| Liquid pipe diameter | Addition amount of refrigerant [g/m] |
|----------------------|--------------------------------------|
| ø6.35                | 20                                   |
| ø9.52                | 50                                   |

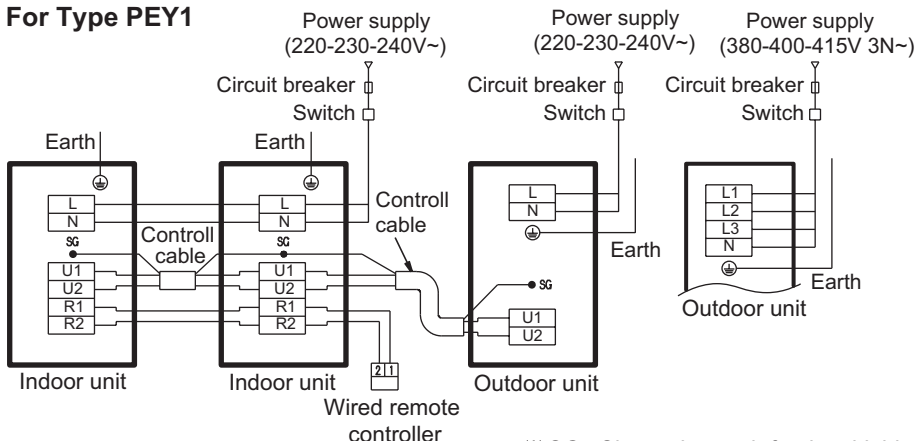
Wiring

**For Type PE1**



※ SG : Shows the earth for the shielded cable.

**For Type PEY1**



※ SG : Shows the earth for the shielded cable.

■ **Optional Distribution Joint Kits**

● CZ-P155BK1

- Prior to undertaking the installation work, read carefully through the “Installation Instructions” for the air conditioner and this “Installation Instructions”.
- This line branch pipe is used for the R410A refrigerant.

**1. Details of parts supplied**

Unit : mm (in.)

|  |                                   |                             |
|--|-----------------------------------|-----------------------------|
| 1 Liquid side branch pipe (inner diameter) |                                   |                             |
|  |                                   |                             |
| 2 Gas side branch pipe (inner diameter)    |                                   |                             |
|  |                                   |                             |
| 3 Thermal insulator (Gas side)             | 4 Thermal insulator (Liquid side) | 5 Installation Instructions |
| 1 pc                                       | 1 pc                              | 1 sheet                     |
|  |                                   |                             |

**2. Indoor/Outdoor unit piping installation**

- For details on the allowable amount of refrigerant, allowable pipe lengths and allowable elevation difference, refer to the Installation Instructions provided with the outdoor unit.
- The diameter of the piping for the indoor and outdoor units differs depending on the model of the unit. (Refer to respective diameter of the piping for the indoor and the outdoor units and install accordingly.) Use pipe cutters to cut the appropriate connecting section of the branch pipe to match the diameter of piping for the indoor and outdoor units.

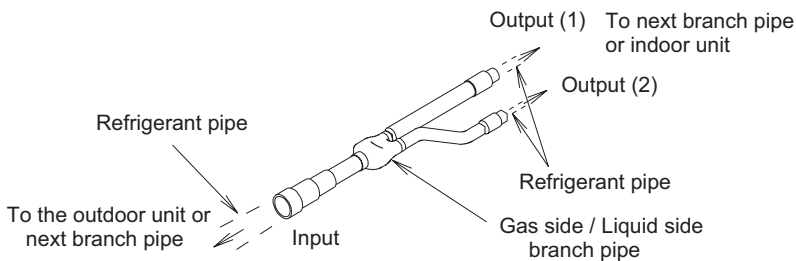
**Pipe diameter for indoor unit**

| Cooling capacity of the indoor unit | Liquid side pipe diameter | Gas side pipe diameter |
|-------------------------------------|---------------------------|------------------------|
| < 6.0 kW                            | ø6.35                     | ø12.7                  |
| 6.0 kW ≤                            | ø9.52                     | ø15.88                 |

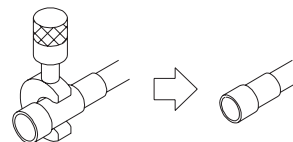
**Pipe diameter for outdoor unit**

| Cooling capacity of the outdoor unit | Liquid side pipe diameter | Gas side pipe diameter |
|--------------------------------------|---------------------------|------------------------|
| 7.1 kW - 15.5 kW                     | ø9.52                     | ø15.88                 |

2-1 Installation Instructions

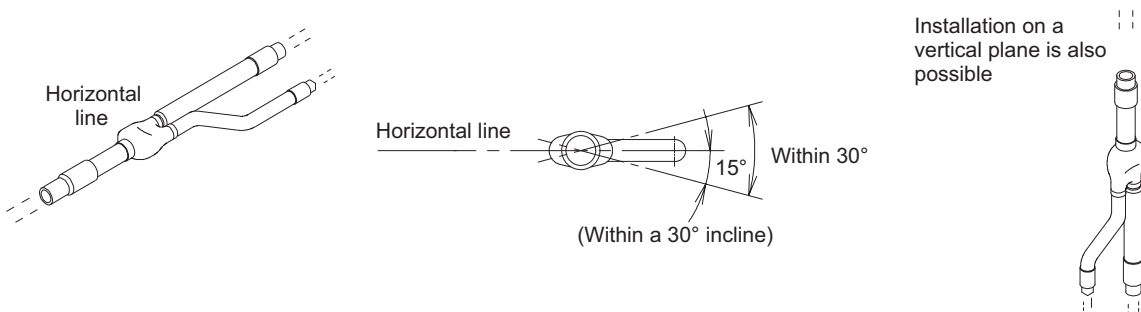


- If the size of the selected refrigerant pipe and the size of the branch pipe differ, cut the connecting section with pipe cutters per the illustration at right. (Be sure to deburr and remove any impurities on the cutting surface.)



2-2 Installation precaution

Position the branch pipe on the appropriate horizontal and vertical plane so that branch flow is even.



2-3 Precautions at connecting points

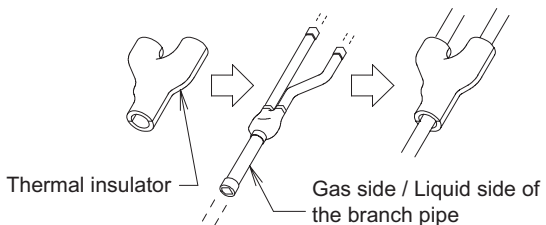
After removing any impurities at the mouth of the pipe or the connecting points, be sure to clean the inside of the pipe with nitrogen gas (nitrogen displacement) to prevent oxide scale forming on the inner surface of the pipe. This step is extremely important when making the connections in the refrigerant piping. (Do not use an antioxidant)

3. Insulation directions

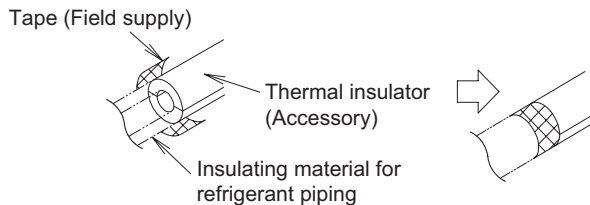
Gas side / Liquid side branch pipe insulation.

Note: Use insulating material that can tolerate 120°C on the gas side.

- 1) Insulate the gas side / liquid side of the branch pipe with thermal insulator.

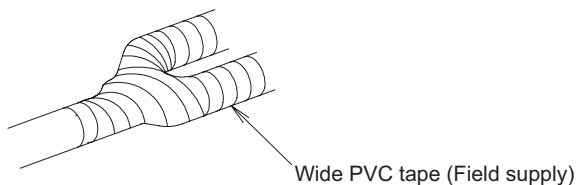


- 2) Wrap tape all around the areas where the insulating materials are joined in order to seal it.



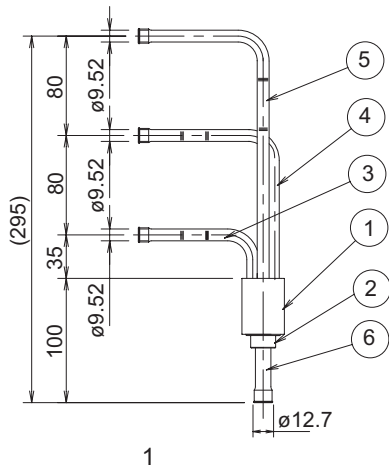
- 3) Wrap a wide PVC tape all around the surfaces where the ends of the branch pipe and insulating materials are abutted so as to close any gaps.

Note: Do not use any adhesive agents on the connections between thermal insulator.

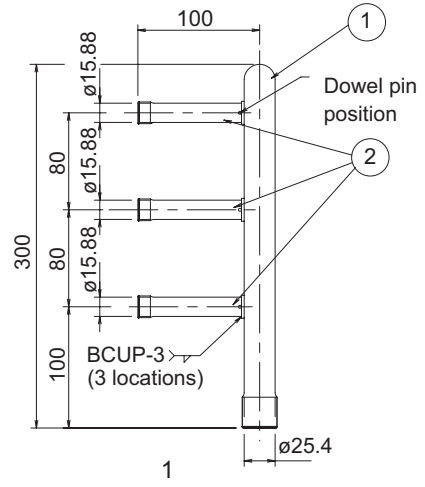


**CZ-P3HPC2 (for simultaneous Triple)**

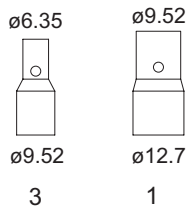
Liquid distribution joint for liquid tube



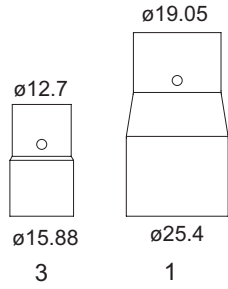
Gas distribution joint for gas tube



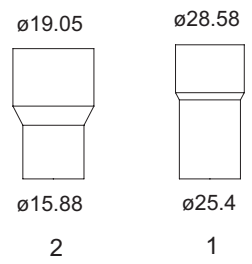
Liquid-tube side tube connector



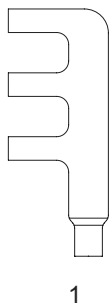
Gas-tube side tube connector



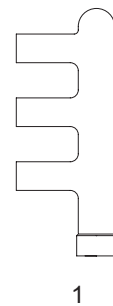
Gas-tube side tube connector



Thermal insulation for liquid distribution joints



Thermal insulation for gas distribution joints



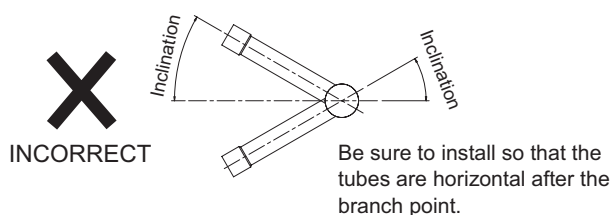
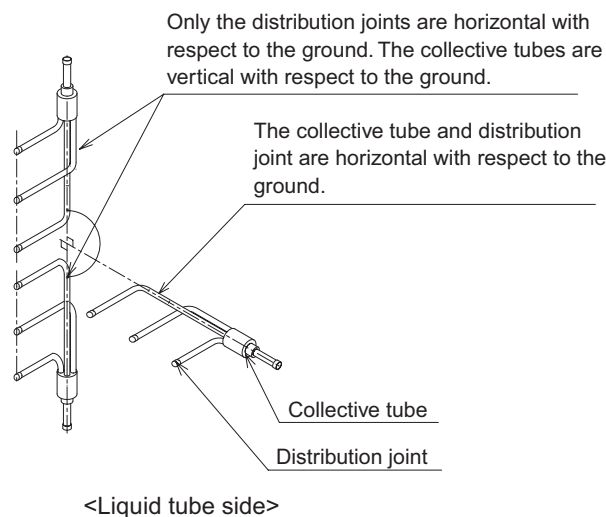
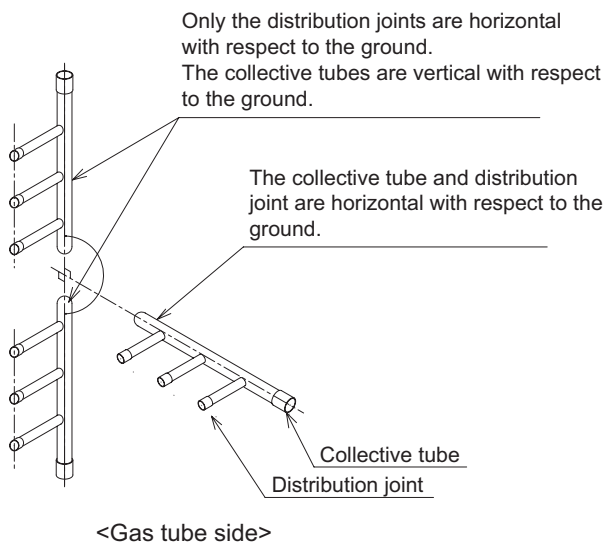
**■ Installing Distribution Joint Kit (for Triple) (CZ-P3HPC2)**

- Check the system combination before installing the distribution joints.
- Three indoor units must be installed within the same room.
- Use the supplied tube connectors to adjust the tube sizes of the distribution joints.

**How to Install Distribution Joints**

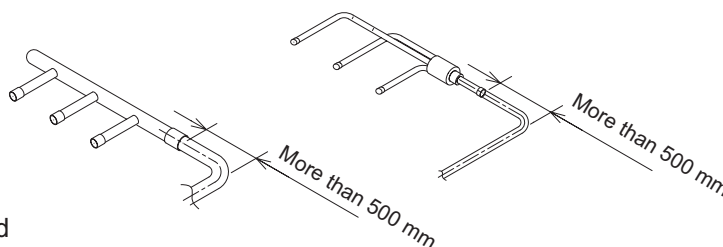
Use the supplied distribution joints to complete refrigerant tubing work. Install distribution joints so that the tubes are horizontal after the branch point.

**Orientation of distribution joints**



**Length requirement for strainer on main distribution tube side**

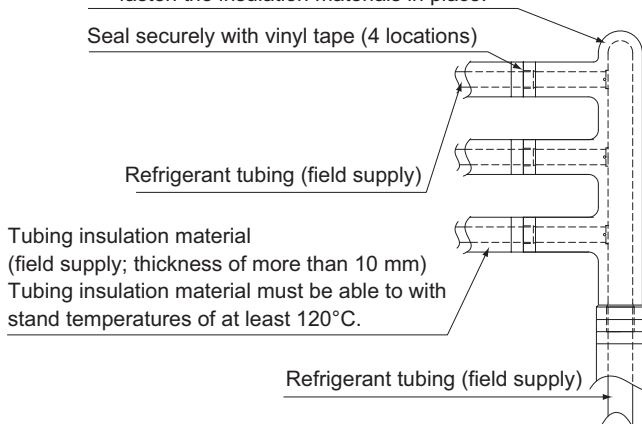
Attach a straight tube 500 mm or longer to the main tubing side of the distribution joint (for both liquid and gas tubing).



**Tubing insulation**

Be sure to apply thermal insulation to both the liquid and gas tubing. Depending on the conditions inside the ceiling, condensation may form on the insulation material. If high temperatures and high humidity are expected to occur inside the ceiling, add glass wool (16-20 kg/m<sup>3</sup>, with a thickness of 10 mm or more) to the below insulation materials and apply sufficient thermal insulation.

- Distribution joint insulation material (supplied)
- Use the supplied insulation material.
  - The supplied insulation material include only a tape for temporarily fastening.
  - Use insulation material or other material to seal the joining lines so that there are no gaps.
  - Use vinyl tape or similar means to seal and fasten the insulation materials in place.



### 3. 4-Way Cassette Type (U2)

#### ■ SELECTING THE INSTALLATION SITE

##### Indoor Unit

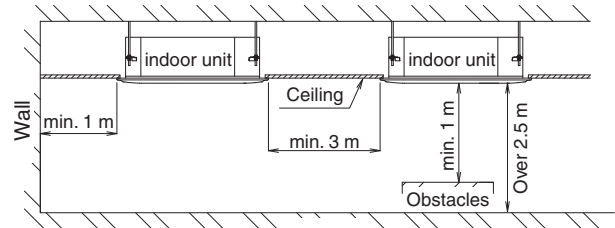
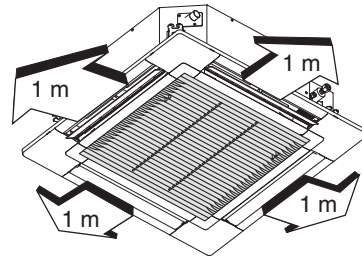
##### AVOID:

- areas where leakage of flammable gas may be expected.
- places where large amounts of oil mist exist.
- direct sunlight.
- locations near heat sources which may affect the performance of the unit.
- locations where external air may enter the room directly. This may cause “condensation” on the air discharge ports, causing them to spray or drip water.
- locations where the remote controller will be splashed with water or affected by dampness or humidity.
- installing the remote controller behind curtains or furniture.
- locations where high-frequency emissions are generated.

##### DO:

- select an appropriate position from which every corner of the room can be uniformly cooled.
- select a location where the ceiling is strong enough to support the weight of the unit.
- select a location where tubing and drain pipe have the shortest run to the outdoor unit.
- allow room for operation and maintenance as well as unrestricted air flow around the unit.
- the limitation of the tubing length between the indoor and the outdoor units should be referred to the Installation Instructions of the outdoor unit.
- allow room for mounting the remote controller about 1 m off the floor, in an area that is not in direct sunlight or in the flow of cool air from the indoor unit.

##### 4-Way Cassette Type



■ HOW TO INSTALL THE INDOOR UNIT

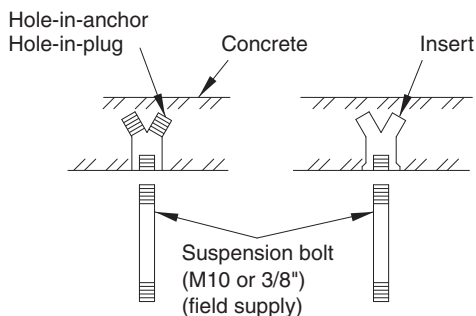
■ 4-Way Cassette Type (Type U2)

Preparation for Suspending

This unit uses a drain pump. Use a carpenter's level to check that the unit is level.

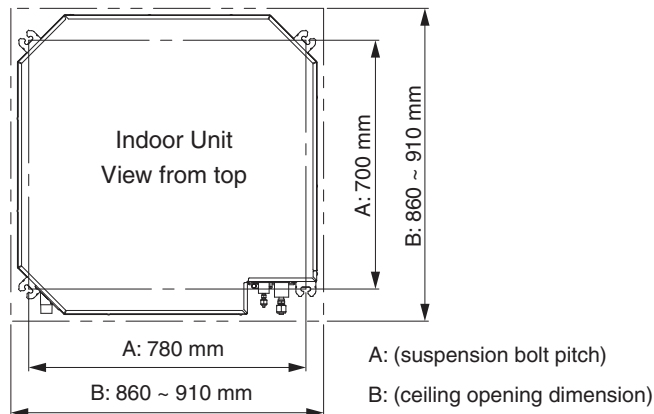
Suspending the Indoor Unit

(1) Fix the suspension bolts securely in the ceiling using the method shown in the diagrams, by attaching them to the ceiling support structure, or by any other method that ensures that the unit will be securely and safely suspended.

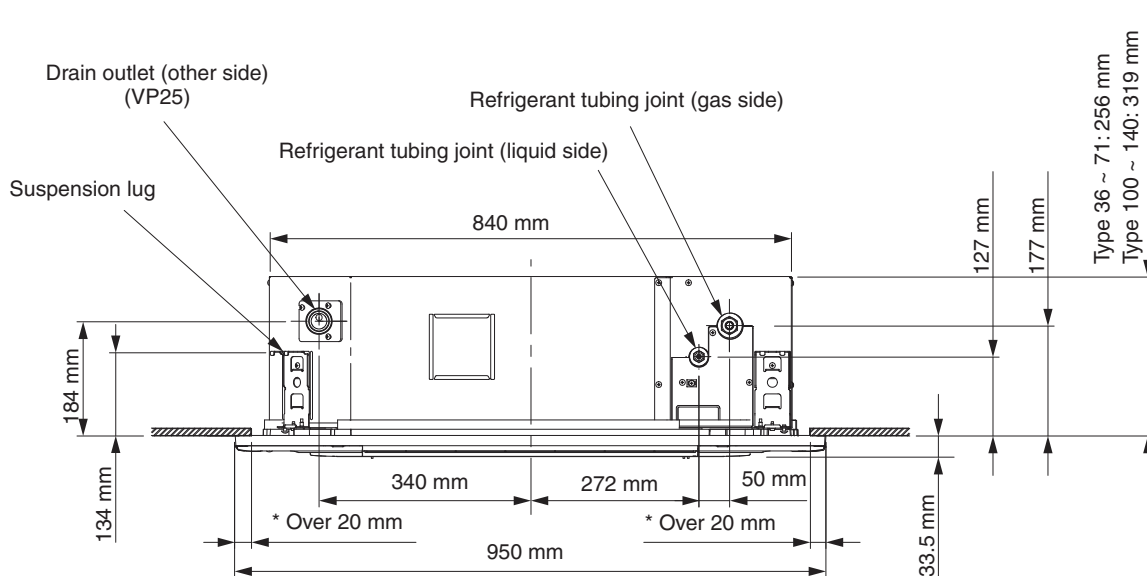


Note: For DC Fan Tap Change Procedure for 4-Way Cassette, see page 1-11-3-13.

(2) Follow the diagram to make the holes in the ceiling.



(3) Determine the pitch of the suspension bolts using the supplied full-scale installation diagram (printed on container box). The diagram shows the relationship between the positions of the suspension fitting, unit, and panel. Use the nut (field supply) and washer (supplied) for upper and lower position of the suspension lug.



\* The overlapping portion between the ceiling and panel for cassette should be kept over 20 mm.

## Placing the Unit Inside the Ceiling

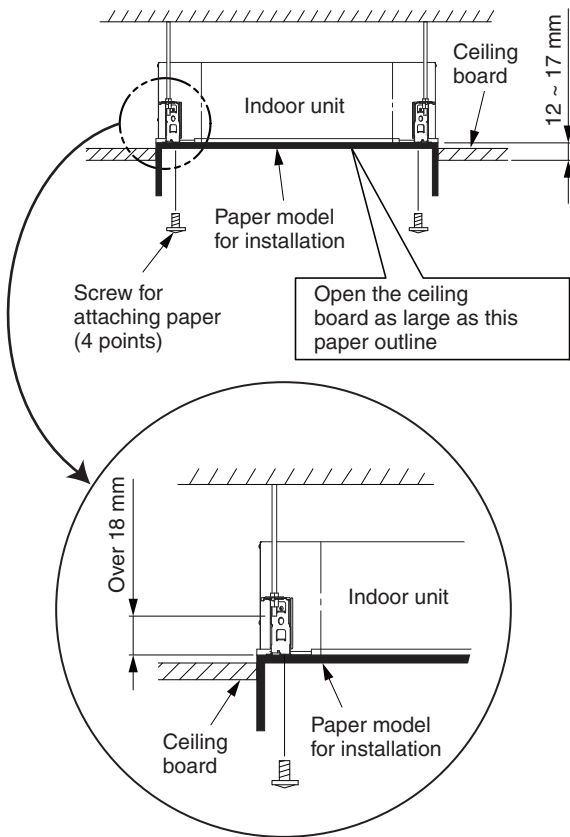
This unit is equipped with the drain pump. Check a tape measure or carpenter's level.

Before installing the panel for cassette, complete the work of drain pipe and refrigerant pipe installation.

- (1) When placing the unit inside the ceiling, determine the pitch of the suspension bolts using the supplied full-scale installation diagram.

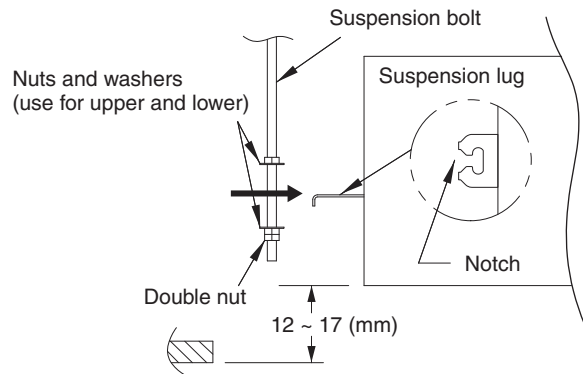
Tubing and wiring must be laid inside the ceiling when suspending the unit. If the ceiling is already constructed, lay the tubing and wiring into position for connection to the unit before placing the unit inside the ceiling.

- (2) The length of suspension bolts must be appropriate for a distance between the bottom of the bolt and the bottom of the unit of more than 18 mm.



Full-scale installation diagram  
(printed on top of container box)

- (3) Thread the 3 hexagonal nuts and 2 washers onto each of the 4 suspension bolts. Use 1 nut and 1 washer for the upper side, and 2 nuts and 1 washer for the lower side, so that the unit will not fall off the suspension lugs.



- (4) Adjust so that the distance between the unit and the ceiling bottom is 12 to 17 mm. Tighten the nuts on the upper side and lower side of the suspension lug.
- (5) Remove the protective polyethylene used to protect the fan parts during transport.
- (6) Check with a tape measure or carpenter's level.



## Installing the Drain Pipe

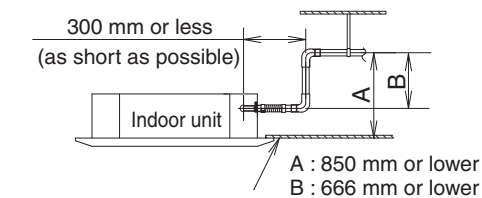
### Before Performing the Installation Drain Piping

#### (1) Limitations of Raising the Drain Pipe Connection



#### CAUTION

- The drain pipe can be raised to a maximum height of 850 mm from the bottom of the ceiling. Do not attempt to raise it higher than 850 mm. Doing so will result in water leakage.



Bottom of the Ceiling board

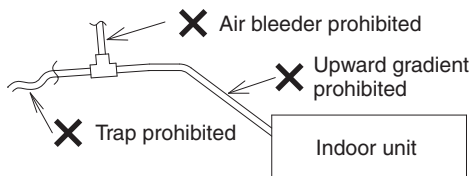
\* Length of supplied drain pipe = 250 mm

#### (2) Limitations of Drain Pipe Connection

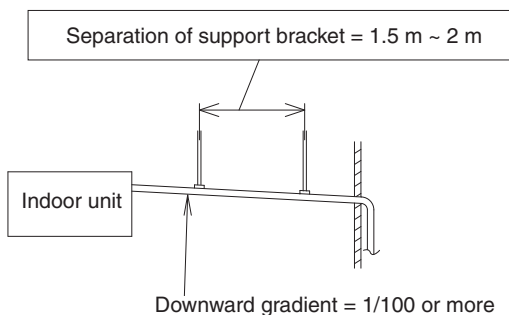


#### CAUTION

- Do not install the drain pipe with an upward gradient from the drain port connection. This will cause the drain water to flow backward and leak when the unit is not operating.
- Do not install an air bleeder as this may cause water to spray from the drain pipe outlet.
- Do not provide U-trap or bell-shaped trap in the middle of the drain pipe. Doing so will cause abnormal sound.



- Make sure the drain pipe has a downward gradient (1/100 or more; downward from drain port connection).

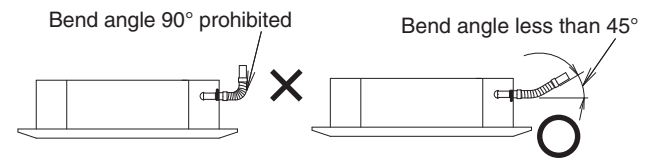


#### (3) Limitations of Drain Hose Connection

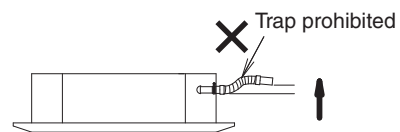


#### CAUTION

- Do not bend the supplied drain hose 90° or more. Bend it less than 45°.



- Do not make a trap in the middle of the supplied drain hose. Doing so will cause abnormal sound.



## Installing the Drain Pipe



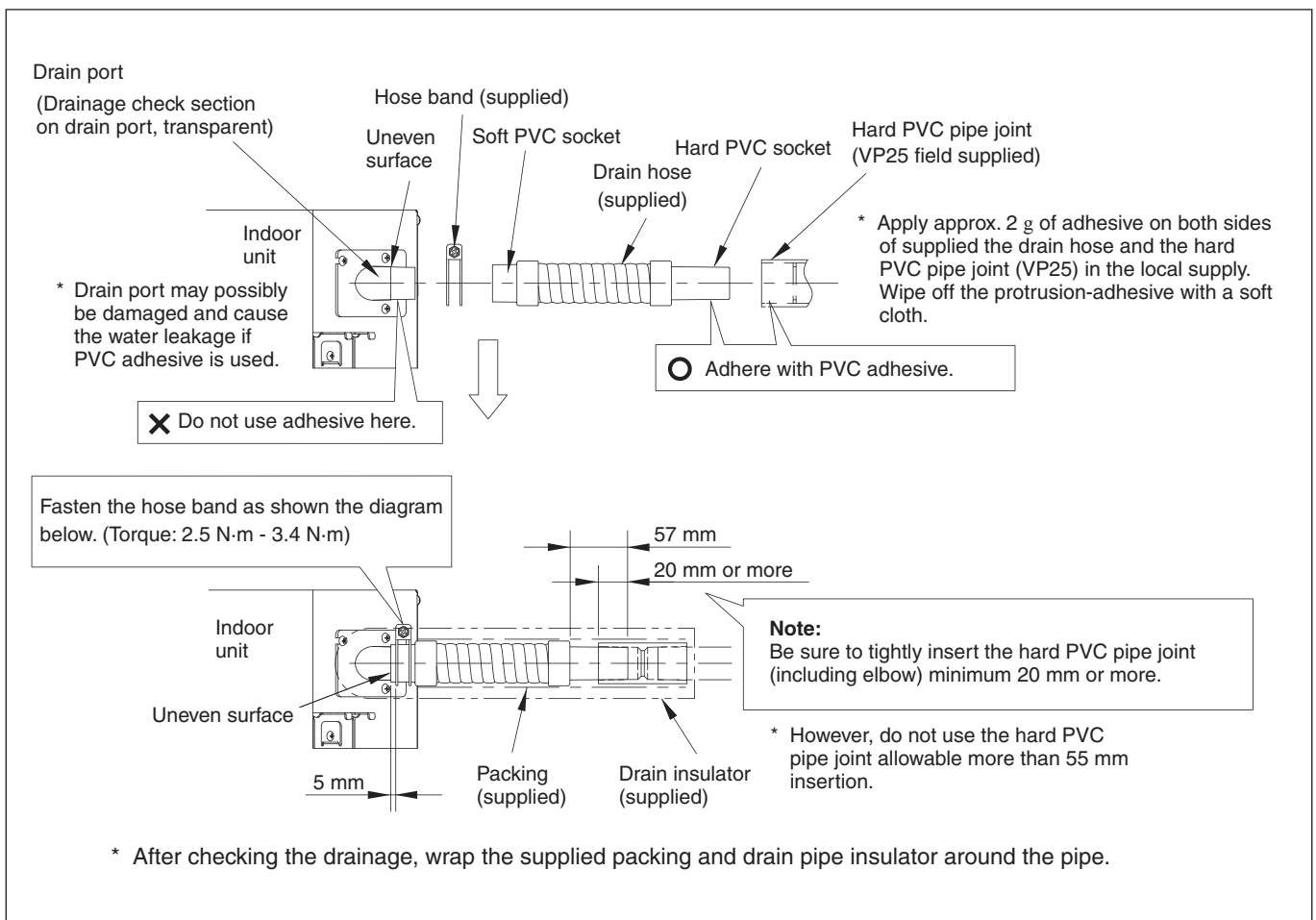
### CAUTION

- Do not apply force to the drain port when connecting the drain pipe. Install and fix it near the indoor unit as close as possible.
- Do not use adhesive when connecting the drain port pipe and the drain hose.

#### (1) How to Install the Drain Pipe

- 1) First insert the supplied hose band into the drain port pipe. Then make sure the head of the screw is facing toward a technical engineer when placing the screw of the hose band at an upward angle.
- 2) Insert the soft PVC socket of the supplied drain hose to the drain port pipe. Do not use adhesive when connecting the drain hose to the drain port pipe. Insert it until the tip of the drain hose contacts the uneven surface of the drain port pipe.

- 3) Move the hose band so that the center position of the hose band can be placed approx. 30 mm away from the external plate of the indoor unit. See diagram below.
- 4) Screw the drain hose tightly facing the screw of the hose band upward. (Torque: 2.5 N·m - 3.4 N·m) (If the screw is tightened beneath the drain hose, the troubles will be generated.)
- 5) Apply approx. 2 g of adhesive on both sides of the drain hose without connection of the hard PVC socket and the hard PVC pipe joint (VP25) in the local supply.
- 6) Connect the drain hose and the hard PVC pipe joint so that the adhesive area of both sides can be overlapped. Wipe off the protrusion-adhesive with a soft cloth.



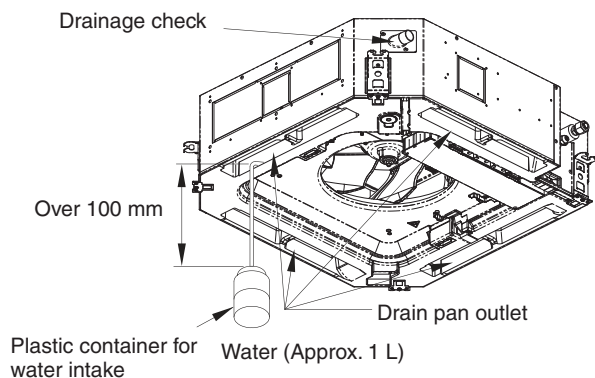
**Checking the Drainage**



**CAUTION** Be careful since the fan will start when you short the pin on the indoor control board.

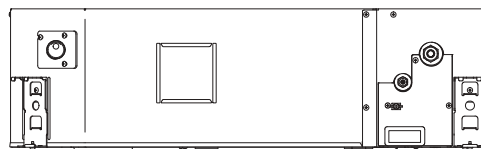
After wiring (refer to 1-10. Electrical Wiring.) and drain piping are completed, use the following procedure to check that the water will drain smoothly. For this, prepare a bucket and wiping cloth to catch and wipe up spilled water.

- (1) Connect power to the power terminal board (L, N terminals) inside the electrical component box.
- (2) Slowly pour about 1 L of water into the drain pan to check drainage.



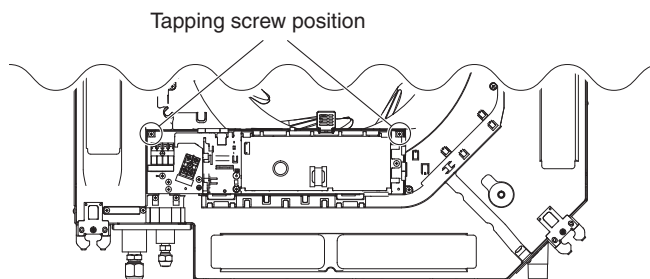
- (3) Short the check pin (CHK) (6P : 5-6) on the indoor control board and operate the drain pump. Check the water flow through the transparent drain pipe and see if there is any leakage.
  - \* If the check pin (CHK) (6P:5-6) is shorted, the fan starts rotating at high speed and could cause injury.
- (4) When the check of drainage is complete, open the check pin (CHK) (6P : 5-6) and remount the tube cover.
- (5) Checkpoint after installation  
After installation of indoor and outdoor units, panels and electrical wiring, check the following items.

**Important Note for Wiring 4-Way Cassette Type**



Power supply inlet

- (1) The power supply inlet is located at the lower area of the refrigerant tubing side of the unit. The electrical component box is located at the air intake of the bottom of the unit.
- (2) Before installing the panel for cassette, be sure to carry out the wiring connection.
- (3) Remove the lid located on the bottom of the indoor unit attaching the electrical component box by unscrewing the Phillips head tapping screws (x2).



- (4) Lead the wires from the power supply inlet to the unit. Be sure to lead the wires through the power supply inlet. Make sure that no wire is caught between the indoor unit and panel for cassette. Otherwise, the unit may cause a fire.
- (5) Connect the wires into the terminals through the power supply inlet for the electrical component box. Fix the wires with a clamping clip.
- (6) Reinstall the lid of the electrical component box in its original position with paying attention not to have the wires caught in the lid. Refer to "1-10. Electrical Wiring".

## ■ HOW TO PROCESS TUBING

### Connecting the Refrigerant Tubing

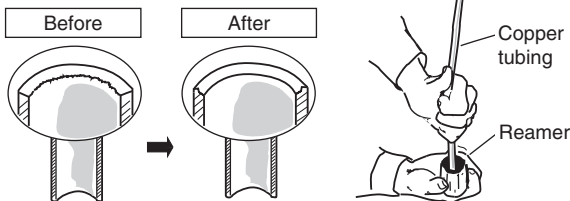
#### Use of the Flaring Method

Many of conventional split system air conditioners employ the flaring method to connect refrigerant tubes that run between indoor and outdoor units. In this method, the copper tubes are flared at each end and connected with flare nuts.

#### Flaring Procedure with a Flare Tool

- (1) Cut the copper tube to the required length with a tube cutter. It is recommended to cut approx. 30 – 50 cm longer than the tubing length you estimate.
- (2) Remove burrs at each end of the copper tubing with a tube reamer or a similar tool. This process is important and should be done carefully to make a good flare. Be sure to keep any contaminants (moisture, dirt, metal filings, etc.) from entering the tubing.

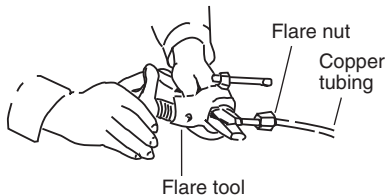
#### Deburring



#### NOTE

When reaming, hold the tube end downward and be sure that no copper scraps fall into the tube.

- (3) Remove the flare nut from the unit and be sure to mount it on the copper tube.
- (4) Make a flare at the end of the copper tube with a flare tool.



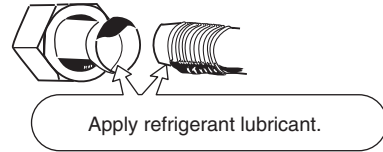
#### NOTE

A good flare should have the following characteristics:

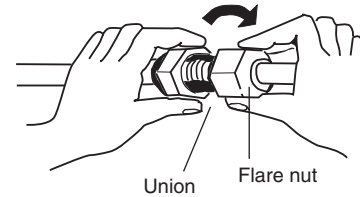
- inside surface is glossy and smooth
- edge is smooth
- tapered sides are of uniform length

#### Caution Before Connecting Tubes Tightly

- (1) Apply a sealing cap or water-proof tape to prevent dust or water from entering the tubes before they are used.
- (2) Be sure to apply refrigerant lubricant (ether oil) to the inside of the flare nut before making piping connections. This is effective for reducing gas leaks.



- (3) For proper connection, align the union tube and flare tube straight with each other, then screw on the flare nut lightly at first to obtain a smooth match.



- Adjust the shape of the liquid tube using a tube bender at the installation site and connect it to the liquid tubing side valve using a flare.

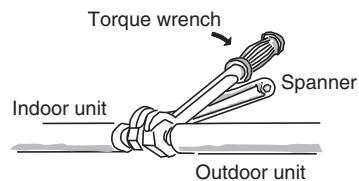
### Connecting Tubing Between Indoor and Outdoor Units

- (1) Tightly connect the indoor-side refrigerant tubing extended from the wall with the outdoor-side tubing.

#### Indoor Unit Tubing Connection ( $\varnothing_1, \varnothing_2 \dots \varnothing_{n-1}$ )

| Indoor unit type   | 36                 | 45 | 50 | 60                  | 71 | 100 | 125 | 140 |
|--------------------|--------------------|----|----|---------------------|----|-----|-----|-----|
| Gas tubing (mm)    | $\varnothing 12.7$ |    |    | $\varnothing 15.88$ |    |     |     |     |
| Liquid tubing (mm) | $\varnothing 6.35$ |    |    | $\varnothing 9.52$  |    |     |     |     |

- (2) To fasten the flare nuts, apply specified torque.
- When removing the flare nuts from the tubing connections, or when tightening them after connecting the tubing, be sure to use a torque wrench and a spanner. If the flare nuts are over-tightened, the flare may be damaged, which could result in refrigerant leakage and cause injury or asphyxiation to room occupants.



- For the flare nuts at tubing connections, be sure to use the flare nuts that were supplied with the unit, or else flare nuts for R410A (type 2). The refrigerant tubing that is used must be of the correct wall thickness as shown in the table below.

| Tube diameter | Tightening torque (approximate)       | Tube thickness |
|---------------|---------------------------------------|----------------|
| ø6.35 (1/4")  | 14 – 18 N · m<br>{140 – 180 kgf · cm} | 0.8 mm         |
| ø9.52 (3/8")  | 34 – 42 N · m<br>{340 – 420 kgf · cm} | 0.8 mm         |
| ø12.7 (1/2")  | 49 – 61 N · m<br>{490 – 610 kgf · cm} | 0.8 mm         |
| ø15.88 (5/8") | 68 – 82 N · m<br>{680 – 820 kgf · cm} | 1.0 mm         |

Because the pressure is approximately 1.6 times higher than conventional refrigerant (R22) pressure, the use of ordinary flare nuts (type 1) or thin-walled tubes may result in tube rupture, injury, or asphyxiation caused by refrigerant leakage.

- In order to prevent damage to the flare caused by over-tightening of the flare nuts, use the table above as a guide when tightening.
- When tightening the flare nut on the liquid tube, use an adjustable wrench with a nominal handle length of 200 mm.

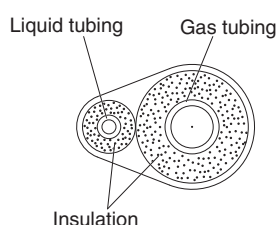
### Insulating the Refrigerant Tubing

#### Tubing Insulation

- Thermal insulation must be applied to all units tubing, including distribution joint (field supply).
  - \* For gas tubing, the insulation material must be heat resistant to 120°C or above. For other tubing, it must be heat resistant to 80°C or above.

Insulation material thickness must be 10 mm or greater. If the conditions inside the ceiling exceed DB 30°C and RH 70%, increase the thickness of the gas tubing insulation material by 1 step.

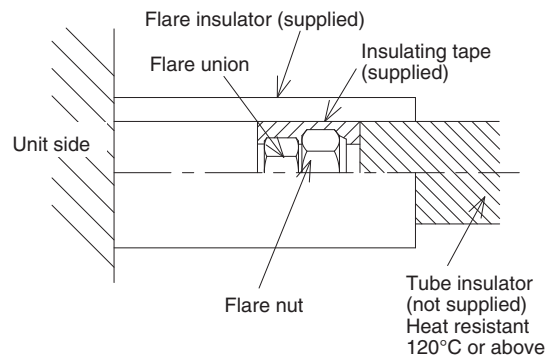
#### Two tubes arranged together



**If the exterior of the outdoor unit valves has been finished with a square duct covering, make sure you allow sufficient space to access the valves and to allow the panels to be attached and removed.**

#### Taping the flare nuts

Wind the white insulating tape around the flare nuts at the gas tube connections. Then cover up the tubing connections with the flare insulator, and fill the gap at the union with the supplied black insulating tape. Finally, fasten the insulator at both ends with the supplied vinyl clamps.



#### Insulation material

The material used for insulation must have good insulation characteristics, be easy to use, be age resistant, and must not easily absorb moisture.



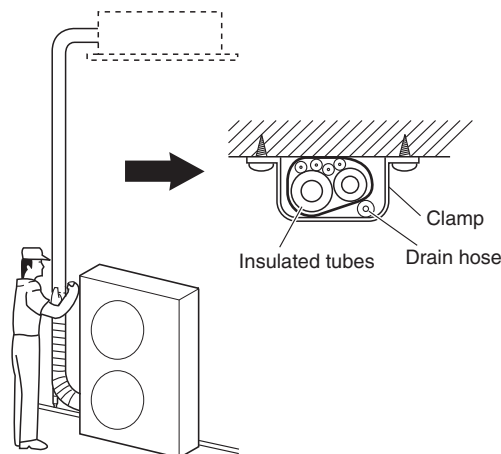
#### CAUTION

**After a tube has been insulated, never try to bend it into a narrow curve because it can cause the tube to break or crack.**

**Never grasp the drain or refrigerant connecting outlets when moving the unit.**

#### Taping the Tubes

- (1) At this time, the refrigerant tubes (and electrical wiring if local codes permit) should be taped together with armoring tape in 1 bundle. To prevent condensation from overflowing the drain pan, keep the drain hose separate from the refrigerant tubing.
- (2) Wrap the armoring tape from the bottom of the outdoor unit to the top of the tubing where it enters the wall. As you wrap the tubing, overlap half of each previous tape turn.
- (3) Clamp the tubing bundle to the wall, using 1 clamp approx. each meter.

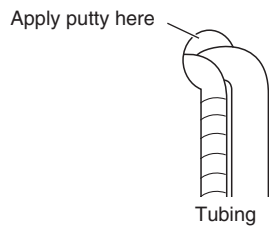


#### NOTE

Do not wind the armoring tape too tightly since this will decrease the heat insulation effect. Also ensure that the condensation drain hose splits away from the bundle and drips clear of the unit and the tubing.

## Finishing the Installation

After finishing insulating and taping over the tubing, use sealing putty to seal off the hole in the wall to prevent rain and draft from entering.



## ■ HOW TO INSTALL THE TIMER REMOTE CONTROLLER OR HIGH-SPEC WIRED REMOTE CONTROLLER (OPTIONAL PART)

### NOTE

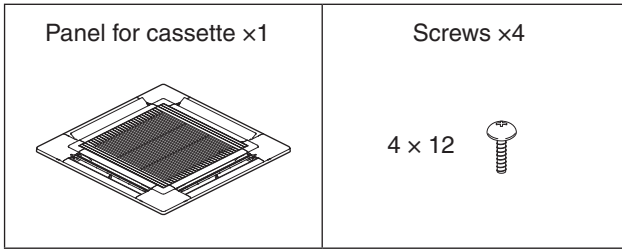
Refer to the Operating Instructions attached to the optional Timer Remote Controller or optional High-spec Wired Remote Controller.

■ HOW TO INSTALL THE CEILING PANEL

■ 4-Way Cassette Type (Type U2)

CZ-KPU3

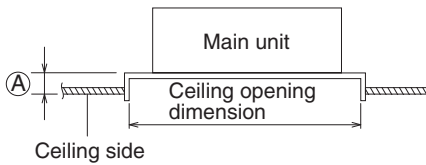
Accessories



**Preparation for Panel for Cassette Installation**

(1) Checking the unit position

- 1) Check that the ceiling hole is within this range:  
860 mm x 860 mm to 910 mm x 910 mm
- 2) Confirm that the position of the indoor unit and the ceiling as shown in the diagram. If the positions of the ceiling surface and unit do not match, air leakage, water leakage, flap operation failure, or other problems may occur.



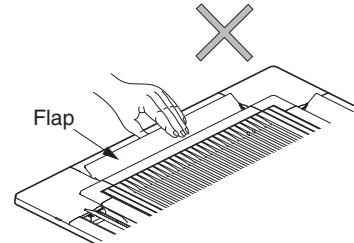
Ⓐ : Be sure to necessarily make a space within the range of 12 mm ~ 17 mm.

If not within this range, malfunction or other trouble may occur.



**CAUTION**

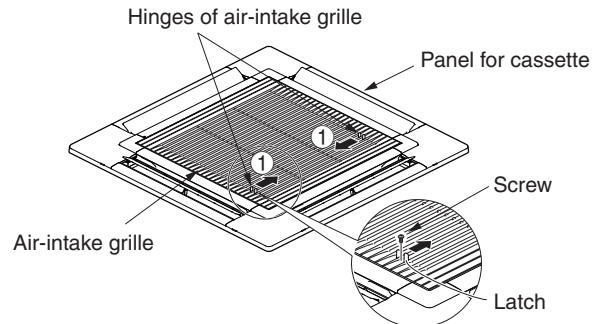
- Never place the panel face-down. Either hang it vertically or place it on top of a projecting object. Placing it face-down will damage the surface.
- Do not touch the flap or apply force to it. (This may cause flap malfunction.)



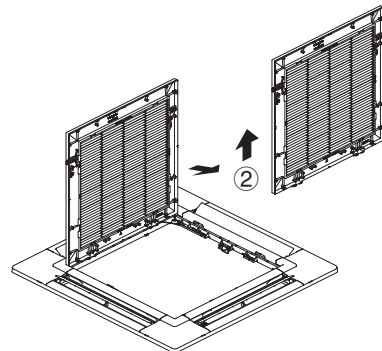
**How to Install the Panel for Cassette**

(1) Removing the air-intake grille

- 1) Remove the 2 screws on the latch of the air-intake grille. (Reattach the air-intake grille after installation of the panel for cassette.)
- 2) Slide the air-intake grille catches in the direction shown by the arrows ① to open the grille.

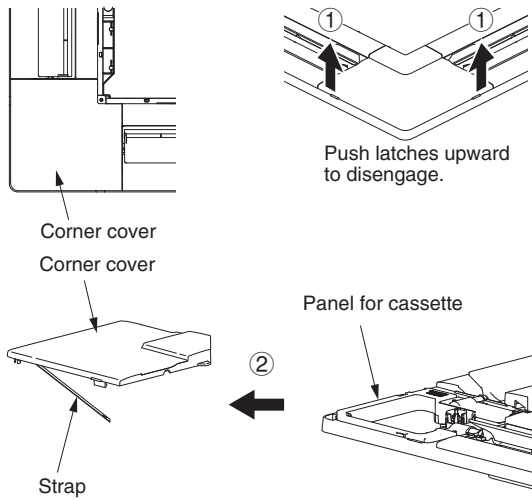


- 3) With the air-intake grille opened, remove the grille hinge from the panel for cassette by sliding it in the direction shown by the arrow ②. (Reattach the air-intake grille after installation of the panel for cassette.)



(2) Removing the corner cover

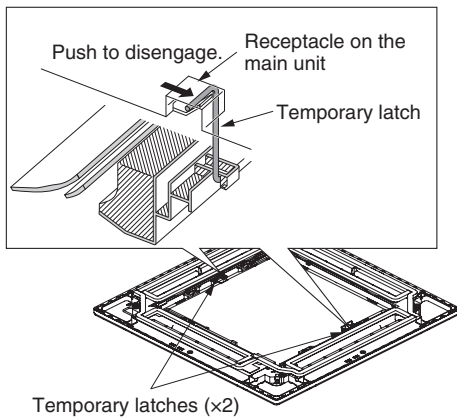
Push the latches on the corner cover in the direction of the arrow ① and remove them by sliding in the direction of the arrow ②.



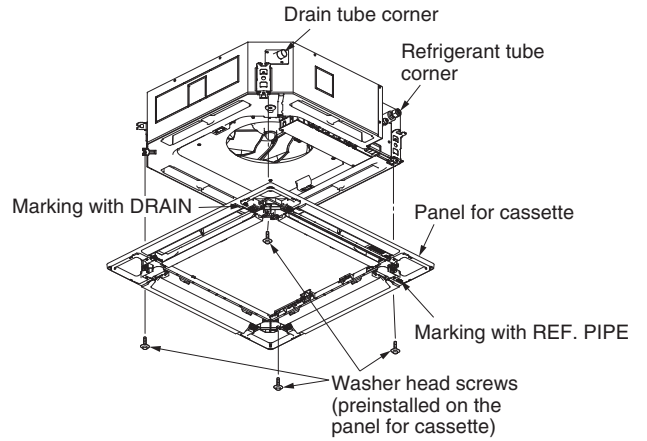
(3) Installing the panel for cassette

The power must be turned ON in order to change the flap angle. (Do not attempt to move the flap by hand. Doing so may damage the flap.)

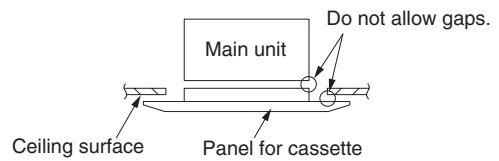
- 1) Hang the temporary latches on the inside of the panel for cassette to the receptacle on the unit to temporarily attach the panel for cassette in place.
  - The panel for cassette must be installed in the correct direction relative to the unit. Align the REF. PIPE and DRAIN marks on the panel for cassette corner with the correct positions on the unit.
  - When removing the panel for cassette, push the temporary latches outward while holding the panel for cassette.



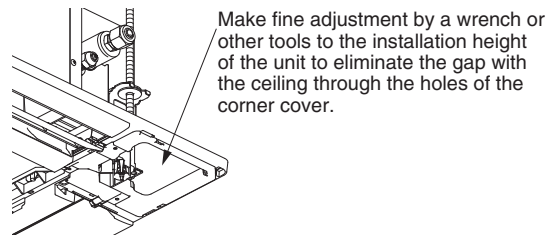
- 2) Align the panel installation holes and the unit screw holes.
- 3) Tighten the provided washer head screws at the 4 panel installation locations so that the panel is attached tightly to the unit.



- 4) Check that the panel is attached tightly to the ceiling.
  - At this time, make sure that there are no gaps between the unit and the panel for cassette, or between the panel for cassette and the ceiling surface.

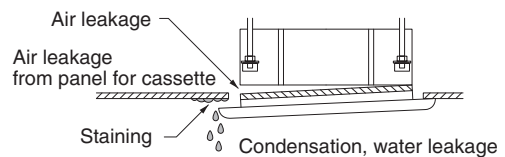


- If there is a gap between the panel and the ceiling, leave the panel for cassette attached and make fine adjustments to the installation height of the unit to eliminate the gap with the ceiling.

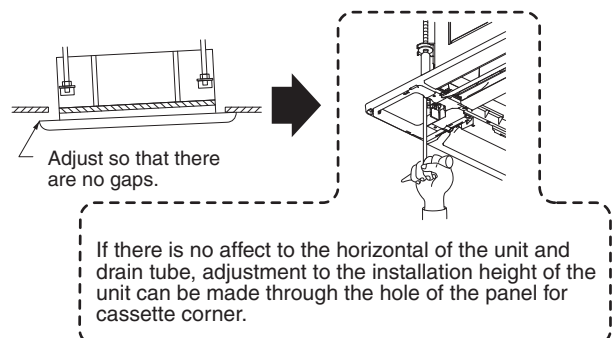


**CAUTION**

- If the screws are not sufficiently tightened, trouble such as that shown in the figure below may occur. Be sure to tighten the screws securely.



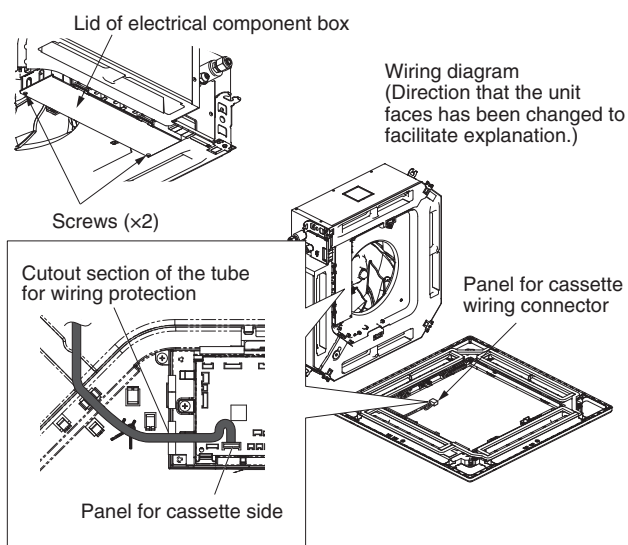
- If a gap remains between the ceiling surface and the panel for cassette even after the screws are tightened, adjust the height of the unit again.





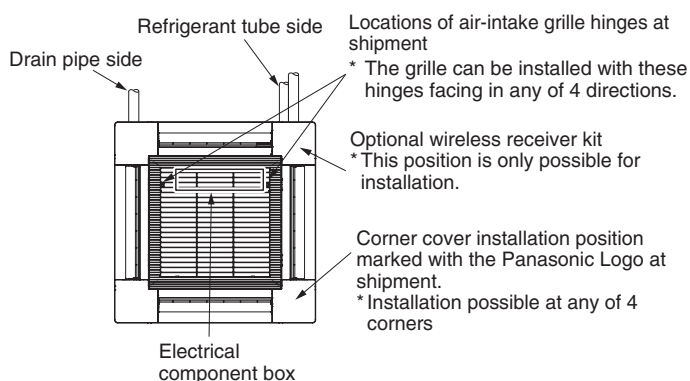
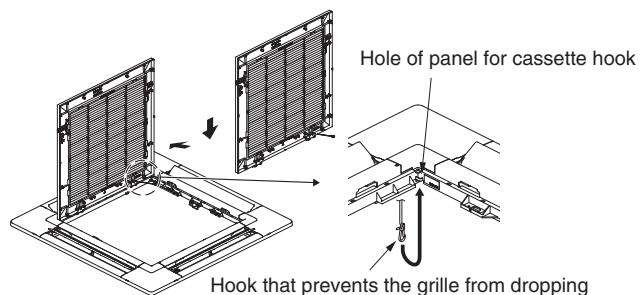
(4) Wiring the Panel for Cassette

- 1) Open the cover of the electrical component box for control PCB.
  - 2) Connect the 22P connector (white) from the panel for cassette to the connector on the control PCB in the unit electrical component box. In this case, expose the cutout section of the tube for the wiring protection to the outside from the electrical component box and fix it with the clamber attached to the electrical component box.
- If the connectors are not connected, the Auto Flap will not operate. Be sure to connect them securely. (If not connected completely, "P09" will be displayed on the remote controller.)
  - Check that the wiring connector is not caught between the electrical component box and the cover.
  - Check that the wiring connector is not caught between the unit and the panel for cassette.



B. Attaching the air-intake grille

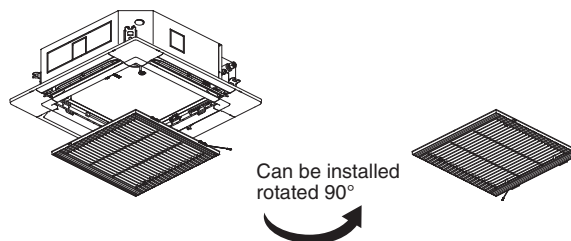
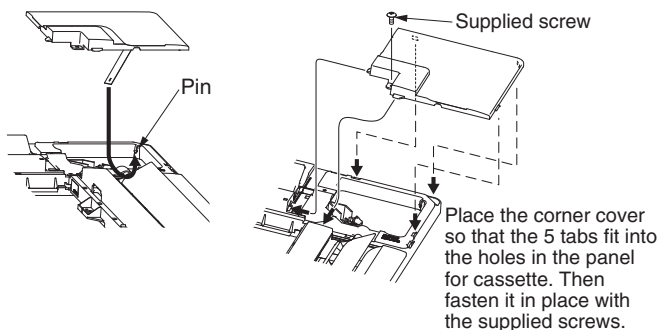
- To install the air-intake grille, follow the steps for "Removing the grille" in the reverse order. By rotating the air-intake grille, it is possible to attach the grille onto the panel for cassette from any of 4 directions. Coordinate the directions of the air-intake grilles when installing multiple units, and change the directions according to customer's requests.
- When attaching the air-intake grille, be careful that the flap lead wire does not become caught.
- Be sure to attach the safety cord that prevents the air-intake grille from dropping off to the panel for cassette unit as shown in the figure below.
- With this panel for cassette, the directions of the air-intake grille lattices when installing multiple units, and the position of the label showing the company name on the corner panel, can be changed according to customer's requests, as shown in the figure below. However, the wireless signal receiver can only be installed at the refrigerant-tubing corner of the ceiling unit.



(5) How to Attach the Corner & Air-Intake Grille

A. Attaching the corner cover

- 1) Check that the safety cord from the corner cover is fastened to the panel for cassette pin, as shown in the figure below.
- 2) Use the supplied screws to attach the corner cover to the panel for cassette.



■ Others

(1) Checking After Installation

- 1) Check that there are no gaps between the unit and the panel for cassette, or between the panel for cassette and the ceiling surface.

\* Gaps may cause water leakage and condensation.

- 2) Check that the wiring is securely connected.

\* If it is not securely connected, the auto flap will not operate.

("P09" is displayed on the remote controller.)

In addition, the water leakage and condensation may occur.

(2) Operating the Wireless Remote Controller

For details of installation, refer to the section "Wireless Signal Receiver" in the supplied installation instructions.

(3) Selecting DC Fan Motor Tap (4-Way Cassette)

Check the optional parts accordingly in the following table.

**Table for DC Fan Motor Tap Settings**

| Setting No. | Remote controller setting data<br>Item code 5d | Contents & optional parts name                    |
|-------------|--|---|
| (1)         | 0001   | Air-flow blocking kit (for 3-way air flow)*2      |
|             |  | Air-flow blocking kit (when a duct is connected.) |
|             |  | High-ceiling setting 1*2                          |
| (3)         | 0003   | High-ceiling setting 2*2                          |
| (6)         | 0006   | Air-flow blocking kit (for 2-way air flow)*2      |

\*1 When using optional parts in different setting No. in combination with multiple units, conform it to the larger setting No.

\*2 Ceiling height (m)

| Indoor unit type                           | 36,45,50 | 60,71 | 100,125,140 |
|--|----------|-------|-------------|
| Standard (factory setting)                 | 2.7      | 3.0   | 3.6         |
| High-ceiling setting 1                     | 3.2      | 3.3   | 4.3         |
| High-ceiling setting 2                     | 3.5      | 3.6   | 5.0         |
| Air-flow blocking kit (for 3-way air flow) | 3.8      | 3.8   | 4.7         |
| Air-flow blocking kit (for 2-way air flow) | 4.2      | 4.2   | 5.0         |

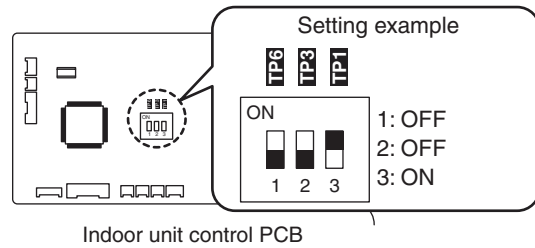
- 1) When setting on the P.C. Board

<Procedure>

**Stop the system before performing these steps.**

- ① Open the electrical component box cover, then check the indoor unit control PCB.
- ② Change the DIP switch on the indoor unit control PCB in accordance with the setting number which was confirmed in Table for DC Fan Motor Tap Settings.

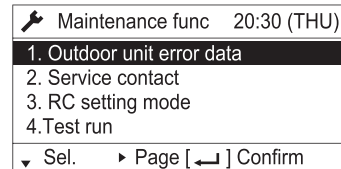
| Setting No. | DIP switch | Setting No. | DIP switch |
|-------------|------------|-------------|------------|
| (1)         |            | (6)         |            |
| (3)         |            |             |            |



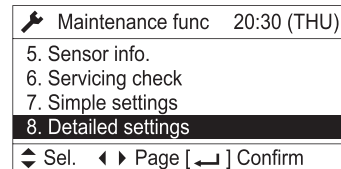
**<Procedure of CZ-RTC5A>**

**Stop the system before performing these steps.**

- ① Keep pressing the , and buttons simultaneously for 4 or more seconds. The "Maintenance func" screen appears on the LCD display.

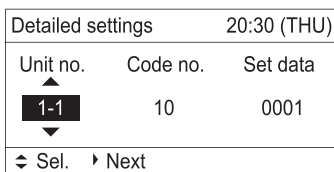


- ② Press the or button to see each menu. If you wish to see the next screen instantly, press the or button. Select "8. Detailed settings" on the LCD display and press the button.



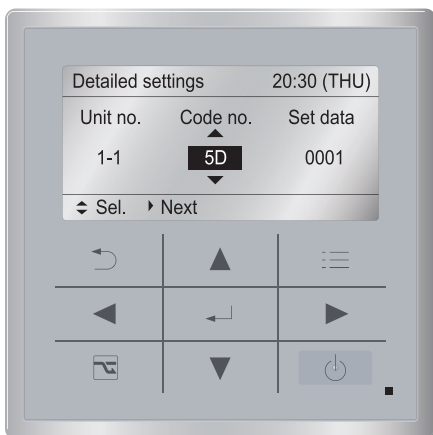
The "Detailed settings" screen appears on the LCD display.

- ③ Select the "Unit no." by pressing the or button for changes.



- ④ Select the "Code no." by pressing the or button.

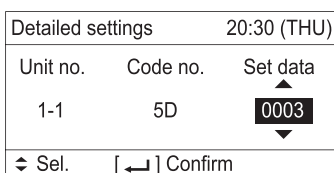
Change the "Code no." to "5D" by pressing the or button (or keeping it pressed).



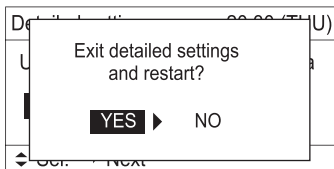
- ⑤ Select the "Set data" by pressing the or button.

Select one of the "Set data" in "Table for DC Fan Motor Tap Settings" by pressing the or button.

Then press the button.



- ⑥ Press the button. The "Exit detailed settings and restart?" (Detailed setting-end) screen appears on the LCD display. Select "YES" and press the button.

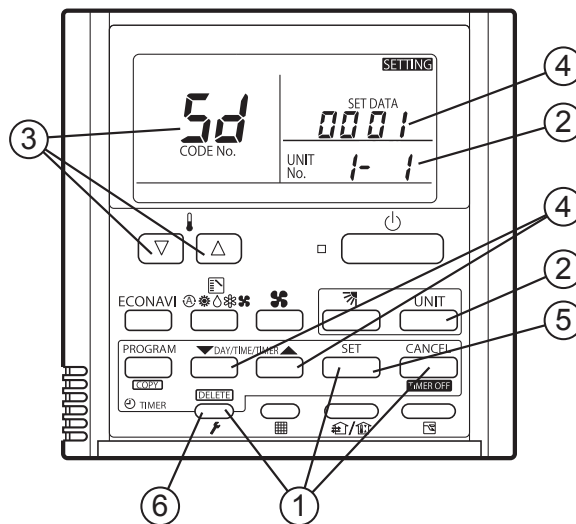


If you wish to change the selected indoor unit, follow the step ②.

<Procedure of CZ-RTC4>

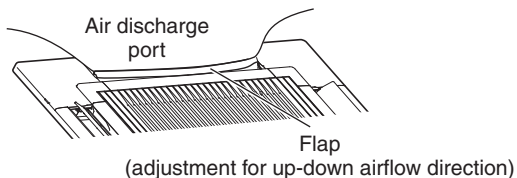
Stop the system before performing these steps.

- ① Press and hold the , , and buttons simultaneously for 4 seconds or longer.
- ② If group control is in effect, press the button to set. At this time, the fan at the indoor unit begins and select the address (unit No.) of the indoor unit operating.
- ③ Designate the item code **5d** by adjusting the Temperature Setting / buttons.
- ④ Press the timer time buttons to select the desired setting data.  
\*For item codes and setting data, refer to "Table for DC Fan Motor Tap Settings".
- ⑤ Press the button. (The display stops blinking and remains lit, and setting is completed.)  
If you wish to change the selected indoor unit, follow the step ②.
- ⑥ Press the button to return to normal remote controller display.



(4) Setting the Flap Separately

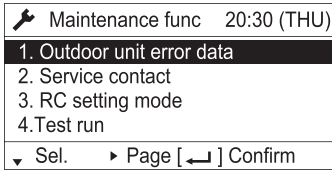
- 1) The 4-air outlet flap can be adjusted separately during operation. When not adjusted separately, all flaps operate in the same manner.



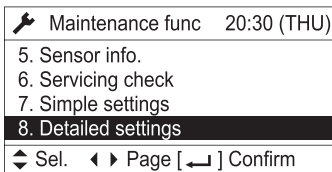
<Procedure of CZ-RTC5A>

Stop the system before performing these steps.

- (1) Keep pressing the and buttons simultaneously for 4 or more seconds.  
The "Maintenance func" screen appears on the LCD display.

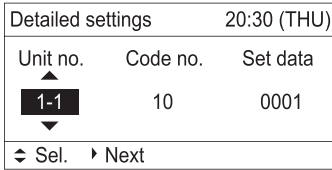


- (2) Press the or button to see each menu. If you wish to see the next screen instantly, press the or button. Select "8. Detailed settings" on the LCD display and press the button.

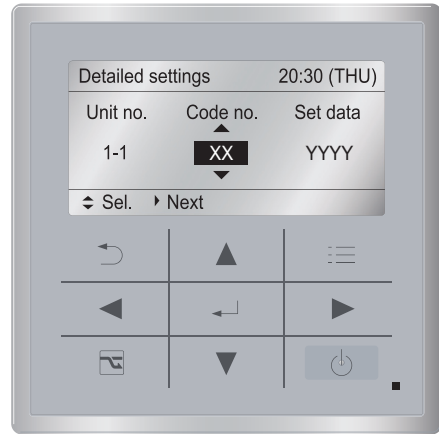
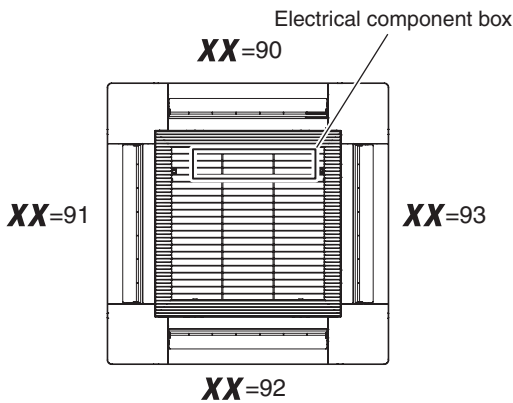


The "Detailed settings" screen appears on the LCD display.

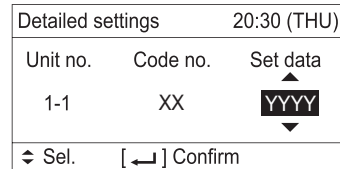
- (3) Select the "Unit no." by pressing the or button for changes.



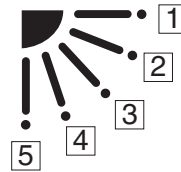
- (4) Select the "Code no." by pressing the or button. Change the "Code no." to "XX" by pressing the or button (or keeping it pressed).



- (5) Select the "Set data" by pressing the or button. Select one of the Setting Data "YYYY" by pressing the or button. Then press the button.



Flap position



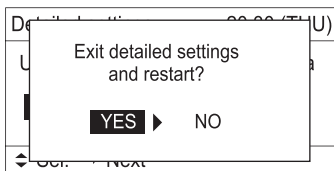
\* Setting data "YYYY"

| Setting data | Flap position during operation |
|--------------|--------------------------------|
| 0000         | Without separate setting       |
| 0001         | Swing                          |
| 0002         | Move to position 1 and stay    |
| 0003         | Move to position 2 and stay    |
| 0004         | Move to position 3 and stay    |
| 0005         | Move to position 4 and stay    |
| 0006         | Move to position 5 and stay    |

**NOTE**

The flap swings during the operation under "Setting the Flap Separately".  
At this time, the unselected flaps are moved to the position 1.

- (6) Press the button. The "Exit detailed settings and restart?" (Detailed setting-end) screen appears on the LCD display. Select "YES" and press the button.

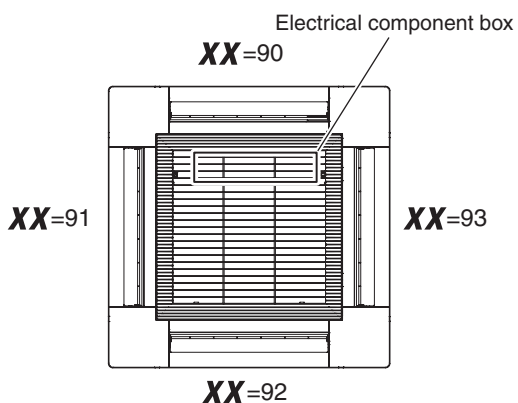


If you wish to change the selected indoor unit, follow the step (2).

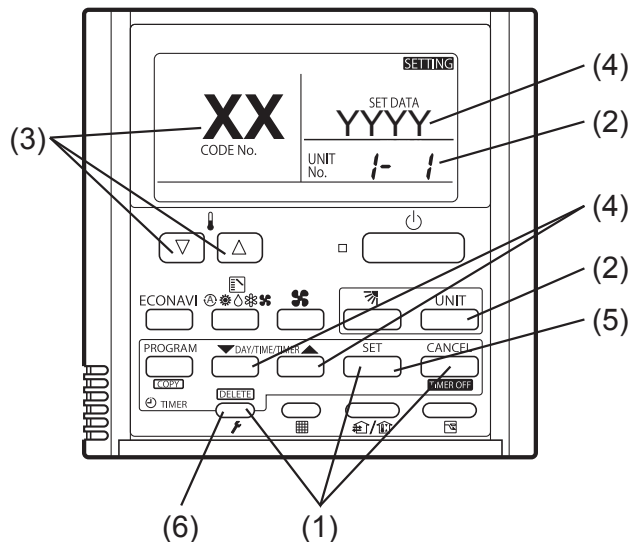
**<Procedure of CZ-RTC4>**

**Stop the system before performing these steps.**

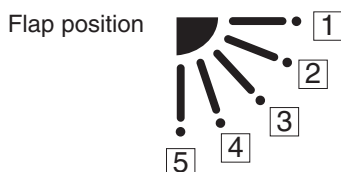
- (1) Press and hold the , and buttons simultaneously for 4 seconds or longer.
- (2) If group control is in effect, press the button to set. At this time, the fan at the indoor unit begins and select the address (unit No.) of the indoor unit operating.
- (3) Designate the item code "XX" by adjusting the Temperature Setting / buttons.



- (5) Press the button.  
(The display stops blinking and remains lit, and setting is completed.)  
If you wish to change the selected indoor unit, follow the step (2).
- (6) Press the button to return to normal remote controller display.



- (4) Press the timer time / buttons to select the desired setting data.



\* Setting data "YYYY"

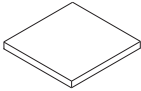
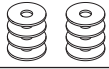


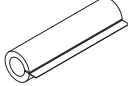
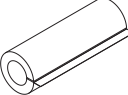
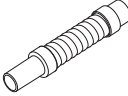

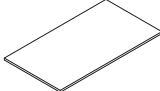
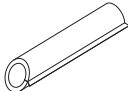
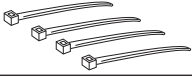


| Setting data | Flap position during operation |
|--------------|--------------------------------|
| 0000         | Without separate setting       |
| 0001         | Swing                          |
| 0002         | Move to position 1 and stay    |
| 0003         | Move to position 2 and stay    |
| 0004         | Move to position 3 and stay    |
| 0005         | Move to position 4 and stay    |
| 0006         | Move to position 5 and stay    |

**NOTE**

The flap swings during the operation under "Setting the Flap Separately".  
At this time, the unselected flaps are moved to the position 1.

## Accessories Supplied with Unit

### (4-Way Cassette)

| Part Name                       | Figure  | Q'ty | Remarks                             |
|---------------------------------|---|------|-------------------------------------|
| Full-scale installation diagram |    | 1    | Printed on container box            |
| Washer                          |    | 8    | For suspension bolts                |
| Screw                           |    | 4    | For full-scale installation diagram |
| Insulating tape                 |    | 2    | For gas and liquid tube flare nuts  |
| Flare insulator                 |    | 1    | For liquid tube                     |
| Flare insulator                 |    | 1    | For gas tube                        |
| Drain hose                      |    | 1    |                                     |
| Hose band                       |    | 1    | For securing drain hose             |
| Packing                         |   | 1    |                                     |
| Drain insulator                 |  | 1    |                                     |
| Clamper                         |  | 4    | For electrical wiring               |
| Operating Instructions          |  | 1    |                                     |
| Installation Instructions       |  | 1    |                                     |

- Use M10 for suspension bolts.
- Field supply for suspension bolts and nuts.

## Type of Copper Tube and Insulation Material

If you wish to purchase these materials separately from a local source, you will need:

1. Deoxidized annealed copper tube for refrigerant tubing.
2. Foamed polyethylene insulation for copper tubes as required to precise length of tubing. Wall thickness of the insulation should be not less than 8 mm.
3. Use insulated copper wire for field wiring. Wire size varies with the total length of wiring. Refer to Electrical Wiring for details on page 1-10-7.



### CAUTION

**Check local electrical codes and regulations before obtaining wire. Also, check any specified instructions or limitations.**

### Additional Materials Required for Installation

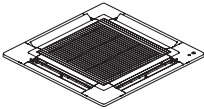



1. Refrigeration (armored) tape
2. Insulated staples or clamps for connecting wire (See your local codes.)
3. Putty
4. Refrigeration tubing lubricant
5. Clamps or saddles to secure refrigerant tubing
6. Scale for weighing

**■ Panel for Cassette (ECONAVI type)**

**CZ-KPU3A**

**Applicable indoor unit : 4-Way Cassette**

**Accessories Supplied**

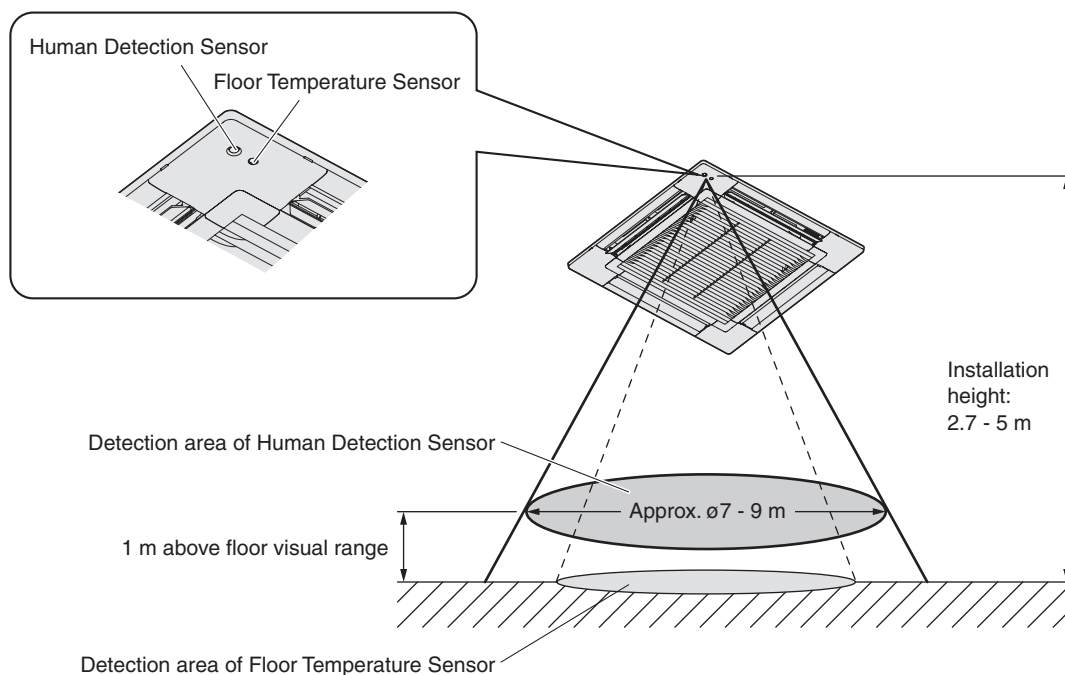
| Part Name                 | Figure  | Q'ty | Remarks      |
|---------------------------|---|------|--------------|
| ECONAVI panel             |  | 1    | ECONAVI type |
| Screw                     |  | 4    | 4 × 12       |
| Operating Instructions    |  | 1    |              |
| Installation Instructions |  | 1    |              |

Since the accessories need for installation work, do not dispose of them until the unit of work is complete.

**■ CAUTION ON INSTALLATION**

**Criteria for Human Detection Area**

- A place where the blind angle of the Human Detection Sensor cannot detect human.  
Install the panel for cassette (ECONAVI type) so that human motion can be detected.
- If there is a heat source or cooling unit in the detection area, the sensor cannot occasionally detect properly.
- The Floor Temperature Sensor detects within the sensor area of Human Detection Sensor.



Criteria of human detection sensor area  
 Installation height of indoor unit 2.7 m : Approx. ø7 m  
 Installation height of indoor unit 4 m : Approx. ø8 m  
 Installation height of indoor unit 5 m : Approx. ø9 m

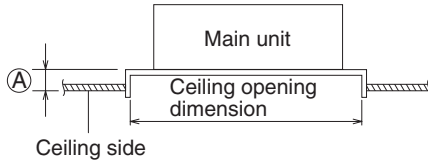
Do not install at the following locations. (Cause of trouble and malfunction)

- Humid, oily, frequent vibration
- Direct sunlight and near by heat source
- Frost

## Preparation for Panel for Cassette Installation

### (1) Checking the unit position

- 1) Check that the ceiling hole is within this range:  
860 × 860 mm to 910 × 910 mm
- 2) Confirm that the position of the indoor unit and the ceiling as shown in the diagram. If the positions of the ceiling surface and unit do not match, air leakage, water leakage, flap operation failure, or other problems may occur.



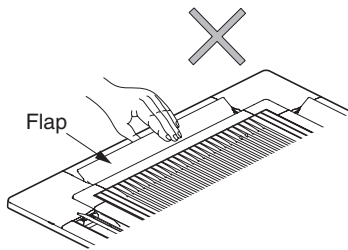
Ⓐ : Be sure to necessarily make a space within the range of 12 ~ 17 mm.

If not within this range, malfunction or other trouble may occur.



### CAUTION

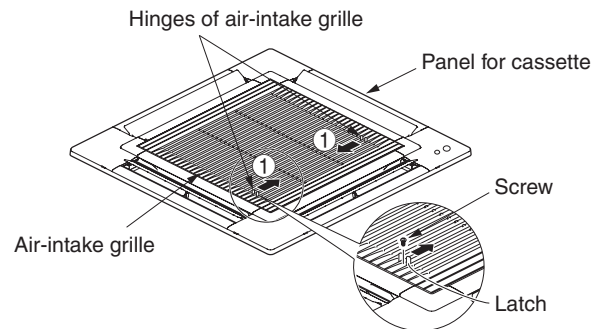
- Never place the panel face-down. Either hang it vertically or place it on top of a projecting object. Placing it face-down will damage the surface.
- Do not touch the flap or apply force to it. (This may cause flap malfunction.)



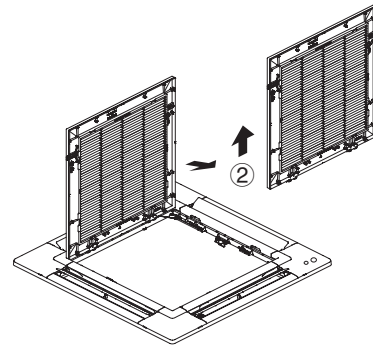
## How to Install the Panel for Cassette

### (1) Removing the air-intake grille

- 1) Remove the 2 screws on the latch of the air-intake grille. (Reattach the air-intake grille after installation of the panel for cassette.)
- 2) Slide the air-intake grille catches in the direction shown by the arrows ① to open the grille.

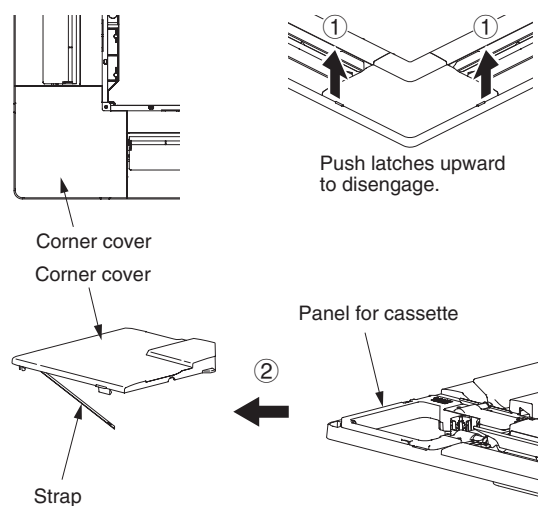


- 3) With the air-intake grille opened, remove the grille hinge from the panel for cassette by sliding it in the direction shown by the arrow ②. (Reattach the air-intake grille after installation of the panel for cassette.)



### (2) Removing the corner cover

Push the latches on the corner cover in the direction of the arrow ① and remove them by sliding in the direction of the arrow ②.



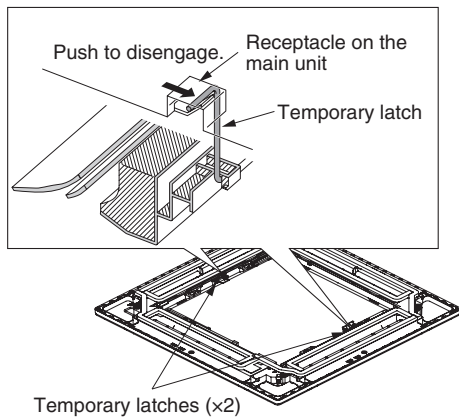


(3) Installing the panel for cassette

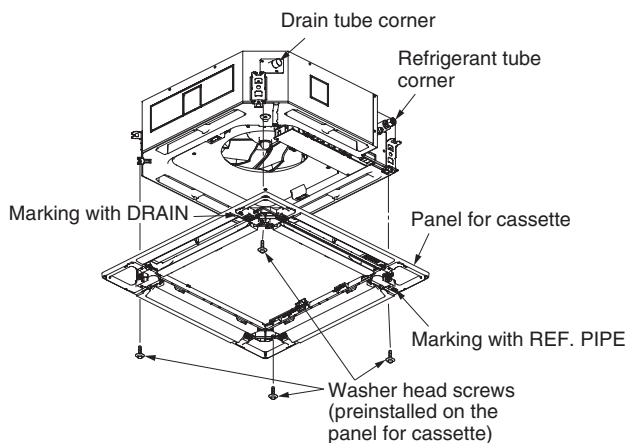
The power must be turned ON in order to change the flap angle. (Do not attempt to move the flap by hand. Doing so may damage the flap.)

1) Hang the temporary latches on the inside of the panel for cassette to the receptacle on the unit to temporarily attach the panel for cassette in place.

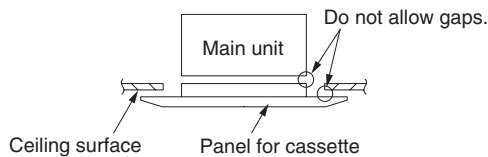
- The panel for cassette must be installed in the correct direction relative to the unit. Align the REF. PIPE and DRAIN marks on the panel for cassette corner with the correct positions on the unit.
- When removing the panel for cassette, push the temporary latches outward while holding the panel for cassette.



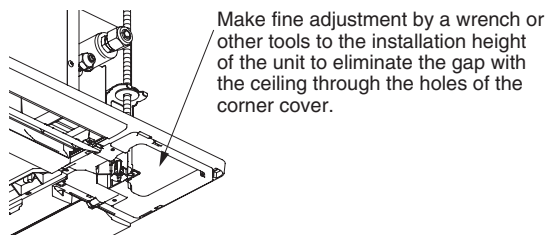
- 2) Align the panel installation holes and the unit screw holes.
- 3) Tighten the provided washer head screws at the 4 panel installation locations so that the panel is attached tightly to the unit.



- 4) Check that the panel is attached tightly to the ceiling.
- At this time, make sure that there are no gaps between the unit and the panel for cassette, or between the panel for cassette and the ceiling surface.

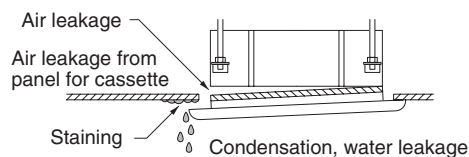


- If there is a gap between the panel and the ceiling, leave the panel for cassette attached and make fine adjustments to the installation height of the unit to eliminate the gap with the ceiling.

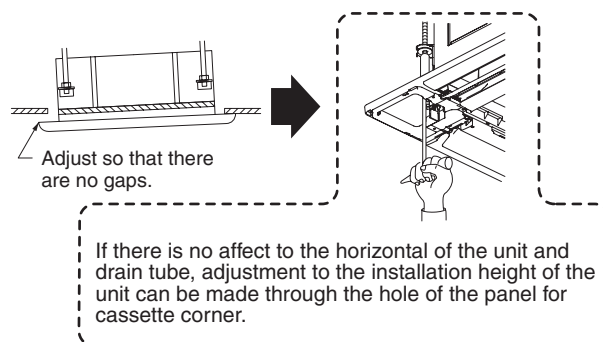


**CAUTION**

- If the screws are not sufficiently tightened, trouble such as that shown in the figure below may occur. Be sure to tighten the screws securely.

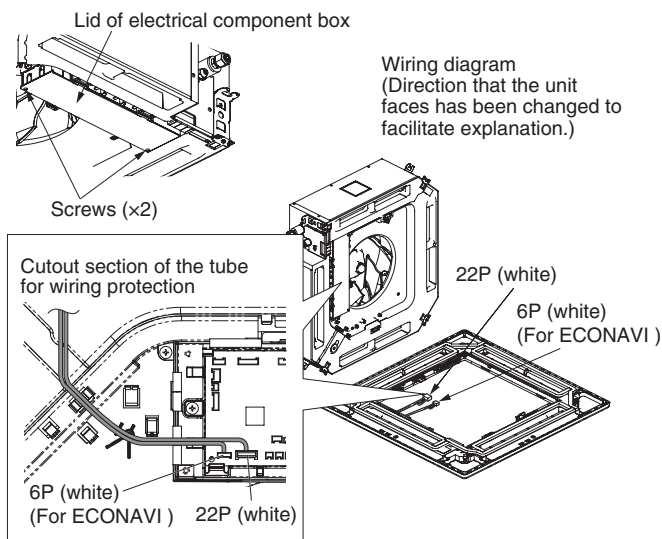


- If a gap remains between the ceiling surface and the panel for cassette even after the screws are tightened, adjust the height of the unit again.



#### (4) Wiring the Panel for Cassette

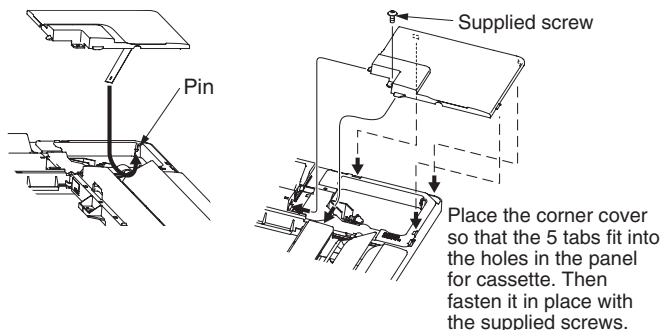
- 1) Open the cover of the electrical component box for control PCB.
  - 2) Connect the 22P connector (white) and 6P connector (white) from the panel for cassette to the connector on the control PCB in the unit electrical component box. In this case, expose the cutout section of the tube for the wiring protection to the outside from the electrical component box and fix it with the clasper attached to the electrical component box.
- **If the connectors are not connected, the Auto Flap will not operate. Be sure to connect them securely. (If not connected completely, "P09" will be displayed on the remote controller.)**
  - **Check that the wiring connector is not caught between the electrical component box and the cover.**
  - **Check that the wiring connector is not caught between the unit and the panel for cassette.**



#### (5) How to Attach the Corner & Air-Intake Grille

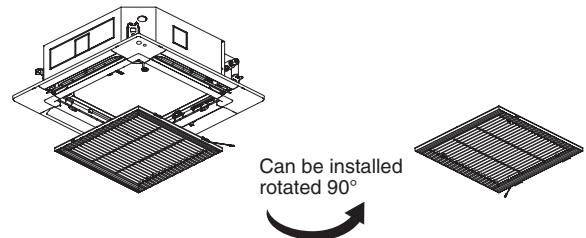
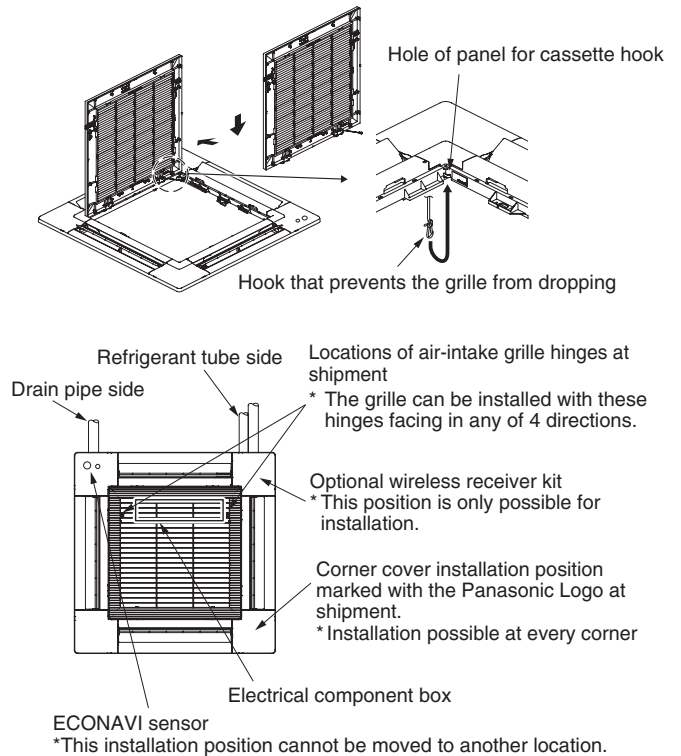
##### A. Attaching the corner cover

- 1) Check that the safety cord from the corner cover is fastened to the panel for cassette pin, as shown in the figure below.
- 2) Use the supplied screws to attach the corner cover to the panel for cassette.



##### B. Attaching the air-intake grille

- To install the air-intake grille, follow the steps for "Removing the grille" in the reverse order. By rotating the air-intake grille, it is possible to attach the grille onto the panel for cassette from any of 4 directions. Coordinate the directions of the air-intake grilles when installing multiple units, and change the directions according to customer's requests.
- When attaching the air-intake grille, be careful that the flap lead wire does not become caught.
- Be sure to attach the safety cord that prevents the air-intake grille from dropping off to the panel for cassette unit as shown in the figure below.
- With this panel for cassette, the directions of the air-intake grille lattices when installing multiple units, and the position of the label showing the company name on the corner panel, can be changed according to customer's requests, as shown in the figure below. However, the wireless signal receiver can only be installed at the refrigerant-tubing corner of the ceiling unit.



■ Others

(1) Checking After Installation

- 1) Check that there are no gaps between the unit and the panel for cassette, or between the panel for cassette and the ceiling surface.

\* Gaps may cause water leakage and condensation.

- 2) Check that the wiring is securely connected.

\* If it is not securely connected, the auto flap will not operate.

("P09" is displayed on the remote controller.)

In addition, the water leakage and condensation may occur.

(2) Operating the Wireless Remote Controller

For details of installation, refer to the section "Wireless Signal Receiver" in the supplied installation instructions.

(3) Selecting DC Fan Motor Tap (4-Way Cassette)

Check the optional parts accordingly in the following table.

**Table for DC Fan Motor Tap Settings**

| Setting No. | Remote controller setting data Item code 5d | Contents & optional parts name                    |
|-------------|---|---|
| (1)         | 0001  | Air-flow blocking kit (for 3-way air flow)*2      |
|             |   | Air-flow blocking kit (when a duct is connected.) |
|             |   | High-ceiling setting 1*2                          |
| (3)         | 0003  | High-ceiling setting 2*2                          |
| (6)         | 0006  | Air-flow blocking kit (for 2-way air flow)*2      |

\*1 When using optional parts in different setting No. in combination with multiple units, conform it to the larger setting No.

\*2 Ceiling height (m)

| Indoor unit type                           | 36,45,50 | 60,71 | 100,125,140 |
|--|----------|-------|-------------|
| Standard (factory setting)                 | 2.7      | 3.0   | 3.6         |
| High-ceiling setting 1                     | 3.2      | 3.3   | 4.3         |
| High-ceiling setting 2                     | 3.5      | 3.6   | 5.0         |
| Air-flow blocking kit (for 3-way air flow) | 3.8      | 3.8   | 4.7         |
| Air-flow blocking kit (for 2-way air flow) | 4.2      | 4.2   | 5.0         |

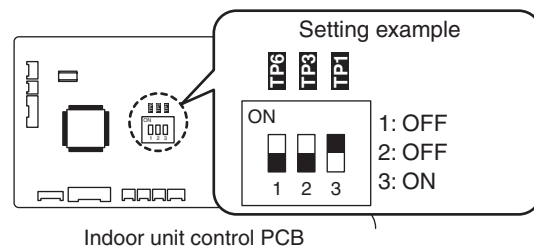
1) When setting on the P.C. Board

<Procedure>

**Stop the system before performing these steps.**

- ① Open the electrical component box cover, then check the indoor unit control PCB.
- ② Change the DIP switch on the indoor unit control PCB in accordance with the setting number which was confirmed in Table for DC Fan Motor Tap Settings.

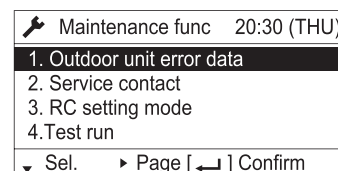
| Setting No. | DIP switch | Setting No. | DIP switch |
|-------------|------------|-------------|------------|
| (1)         |            | (6)         |            |
| (3)         |            |             |            |



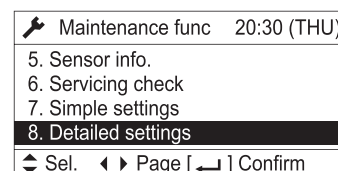
**<Procedure of CZ-RTC5A>**

**Stop the system before performing these steps.**



- ① Keep pressing the , and buttons simultaneously for 4 or more seconds. The "Maintenance func" screen appears on the LCD display.





- ② Press the or button to see each menu. If you wish to see the next screen instantly, press the or button. Select "8. Detailed settings" on the LCD display and press the button.





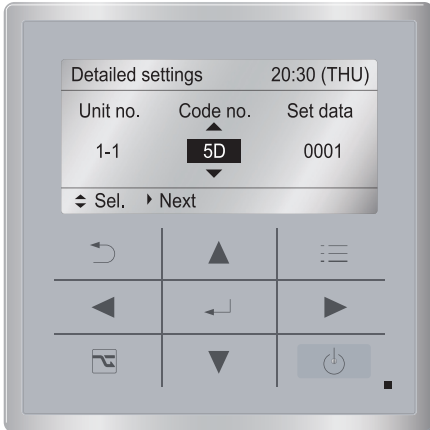
The "Detailed settings" screen appears on the LCD display.



- ③ Select the "Unit no." by pressing the  or  button for changes.



| Detailed settings |          | 20:30 (THU) |
|-------------------|----------|-------------|
| Unit no.          | Code no. | Set data    |
| 1-1               | 10       | 0001        |
| Sel.              |          | Next        |

- ④ Select the "Code no." by pressing the  or  button.

Change the "Code no." to "5D" by pressing the  or  button (or keeping it pressed).





- ⑤ Select the "Set data" by pressing the  or  button.

Select one of the "Set data" in "Table for DC Fan Motor Tap Settings" by pressing the  or  button.

Then press the  button.

| Detailed settings |          | 20:30 (THU)       |
|-------------------|----------|-------------------|
| Unit no.          | Code no. | Set data          |
| 1-1               | 5D       | 0003              |
| Sel.              |          | [confirm] Confirm |











- ⑥ Press the  button.  
The "Exit detailed settings and restart?" (Detailed setting-end) screen appears on the LCD display.  
Select "YES" and press the  button.

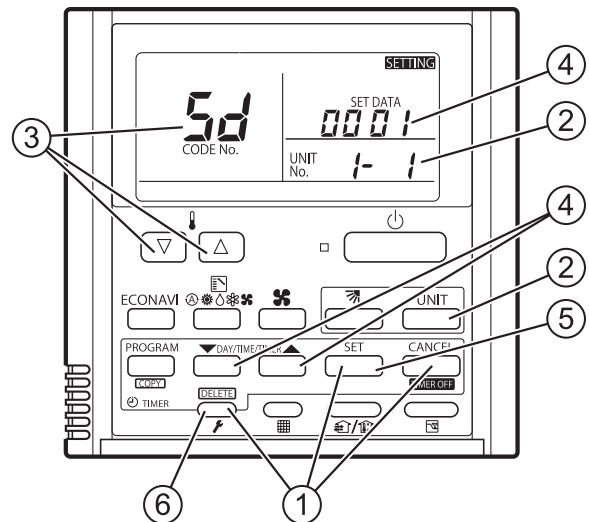
| Detailed settings                   |  | 20:30 (THU) |
|-------------------------------------|--|-------------|
| Exit detailed settings and restart? |  |             |
| YES                                 |  | NO          |
| Sel.                                |  | Next        |

If you wish to change the selected indoor unit, follow the step ②.

#### <Procedure of CZ-RTC4>

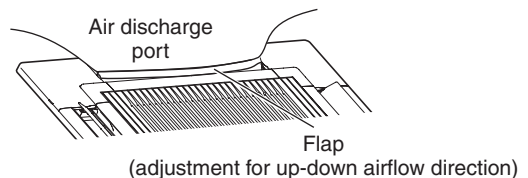
**Stop the system before performing these steps.**

- ① Press and hold the ,  and  buttons simultaneously for 4 seconds or longer.
- ② If group control is in effect, press the  button to set. At this time, the fan at the indoor unit begins and select the address (unit No.) of the indoor unit operating.
- ③ Designate the item code **5d** by adjusting the Temperature Setting / buttons.
- ④ Press the timer time / buttons to select the desired setting data.  
\*For item codes and setting data, refer to "Table for DC Fan Motor Tap Settings".
- ⑤ Press the  button.  
(The display stops blinking and remains lit, and setting is completed.)  
If you wish to change the selected indoor unit, follow the step ②.
- ⑥ Press the  button to return to normal remote controller display.



#### (4) Setting the Flap Separately

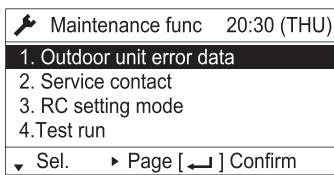
- 1) The 4-air outlet flap can be adjusted separately during operation. When not adjusted separately, all flaps operate in the same manner.



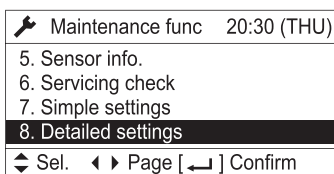
<Procedure of CZ-RTC5A>

Stop the system before performing these steps.

- ① Keep pressing the , and buttons simultaneously for 4 or more seconds. The "Maintenance func" screen appears on the LCD display.

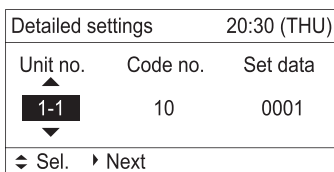


- ② Press the or button to see each menu. If you wish to see the next screen instantly, press the or button. Select "8. Detailed settings" on the LCD display and press the button.

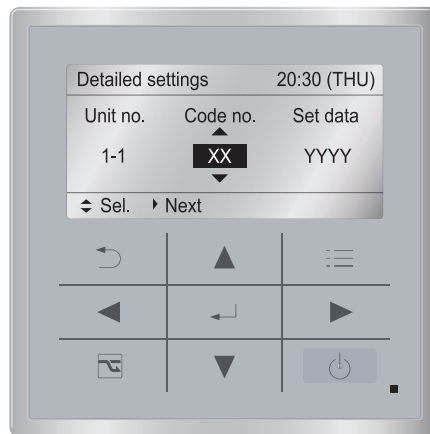
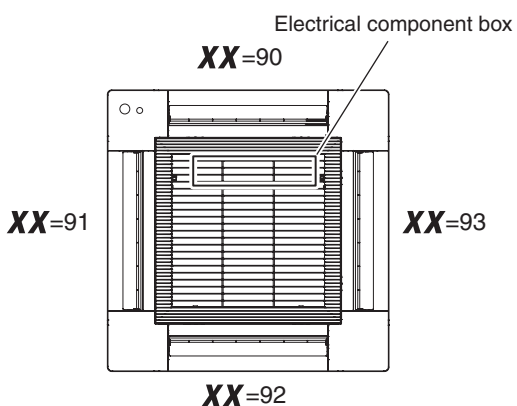


The "Detailed settings" screen appears on the LCD display.

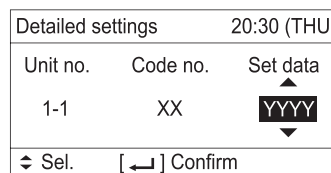
- ③ Select the "Unit no." by pressing the or button for changes.



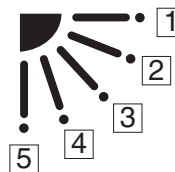
- ④ Select the "Code no." by pressing the or button. Change the "Code no." to "XX" by pressing the or button (or keeping it pressed).



- ⑤ Select the "Set data" by pressing the or button. Select one of the Setting Data "YYYY" by pressing the or button. Then press the button.



Flap position



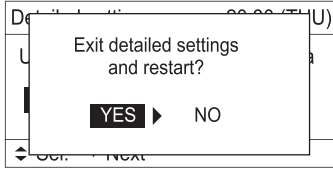
\* Setting data "YYYY"

| Setting data | Flap position during operation |
|--------------|--------------------------------|
| 0000         | Without separate setting       |
| 0001         | Swing                          |
| 0002         | Move to position 1 and stay    |
| 0003         | Move to position 2 and stay    |
| 0004         | Move to position 3 and stay    |
| 0005         | Move to position 4 and stay    |
| 0006         | Move to position 5 and stay    |

**NOTE**

The flap swings during the operation under "Setting the Flap Separately". At this time, the unselected flaps are moved to the position 1.

- ⑥ Press the button. The "Exit detailed settings and restart?" (Detailed setting-end) screen appears on the LCD display. Select "YES" and press the button.

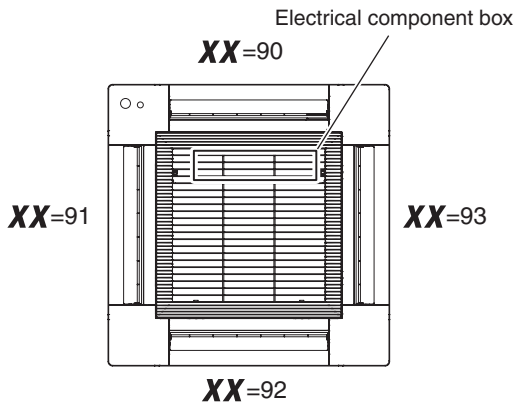


If you wish to change the selected indoor unit, follow the step (2).

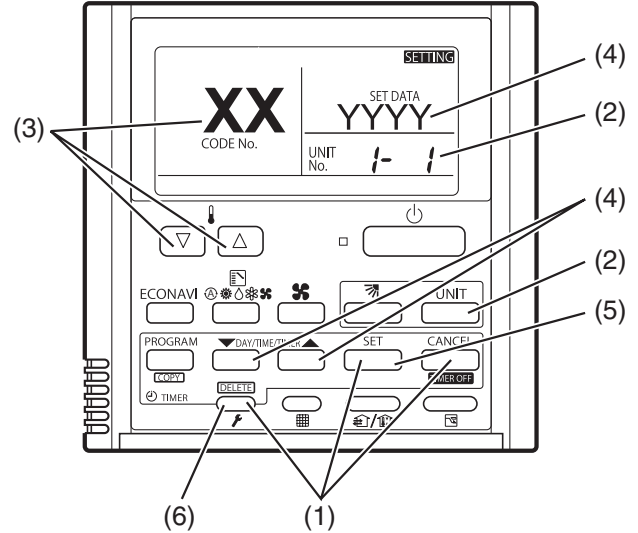
<Procedure of CZ-RTC4>

Stop the system before performing these steps.

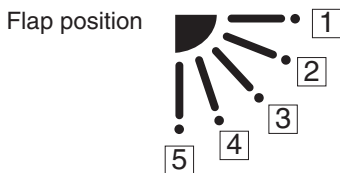
- (1) Press and hold the , and buttons simultaneously for 4 seconds or longer.
- (2) If group control is in effect, press the button to set. At this time, the fan at the indoor unit begins and select the address (unit No.) of the indoor unit operating.
- (3) Designate the item code "XX" by adjusting the Temperature Setting / buttons.



- (5) Press the button.  
(The display stops blinking and remains lit, and setting is completed.)  
If you wish to change the selected indoor unit, follow the step (2).
- (6) Press the button to return to normal remote controller display.



- (4) Press the timer time / buttons to select the desired setting data.



\* Setting data "YYYY"

| Setting data | Flap position during operation |
|--------------|--------------------------------|
| 0000         | Without separate setting       |
| 0001         | Swing                          |
| 0002         | Move to position 1 and stay    |
| 0003         | Move to position 2 and stay    |
| 0004         | Move to position 3 and stay    |
| 0005         | Move to position 4 and stay    |
| 0006         | Move to position 5 and stay    |




**NOTE**

The flap swings during the operation under "Setting the Flap Separately".  
At this time, the unselected flaps are moved to the position 1.

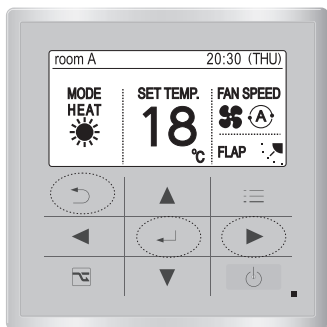
## ECONAVI SYSTEM SETTING

Change the settings of main and sub indoor units to correspond to the ECONAVI system function.  
For the benefit of using the ECONAVI function, the main indoor unit should be provided with the ECONAVI function.

1. Press three buttons.

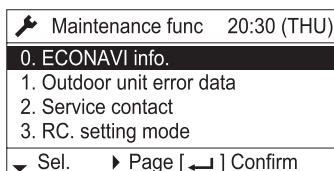
Keep pressing the ,  and  buttons simultaneously for more than 4 seconds.

The "Maintenance func" menu appears on the screen.



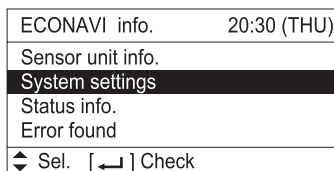
2. Select "0. ECONAVI info." from the menu command.

By pressing the  /  buttons, select "0. ECONAVI info." and press the  button.



3. Select "System settings" from the menu command.

By pressing the  /  buttons, select "System settings" and press the  button.



### NOTE

● After operating Step 2, the following messages may occasionally appear on the screen.

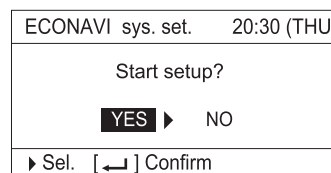
| Display message           | Contents   |
|---------------------------|--|
| Disabled in default mode. | After a while, select "0. ECONAVI info." again.<br>If no status changes even after 10 minutes, make auto address setting and then select "0. ECONAVI info.". |

● After operating Step 3, the following messages may occasionally appear on the screen.

| Display message                        | Contents   |
|--|--|
| Setup is not required.                 | The main indoor unit has already been provided with the ECONAVI function.<br>So, it works right out of the box.              |
| Main indoor unit is not found.         | The power of indoor unit may possibly shut down.<br>Check the power supply of indoor unit.                                   |
| Indoor unit with ECONAVI is not found. | Since all indoor units in the group control are not available for the ECONAVI function, the ECONAVI function cannot be used. |

4. Start settings.


By pressing the  /  buttons, select "YES" and press the  button.



5. When finished settings, the system restarts automatically.

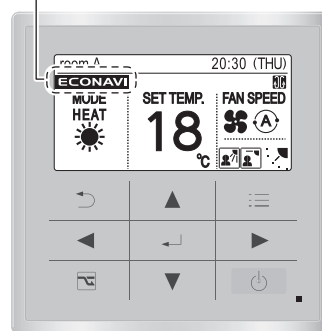
6. Check whether the ECONAVI function is set.

**ECONAVI** is displayed on the screen.

If the display is not operated, press the  button and set it in operating mode.

If operation is in fan mode, **ECONAVI** is not displayed. Set in any operating mode other than fan mode.




"**ECONAVI**" is displayed when setting the ECONAVI function.



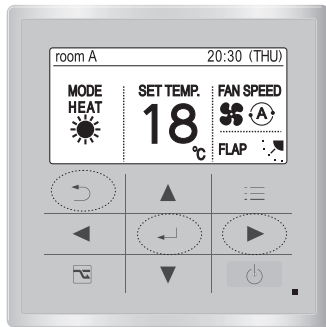
## ■ ECONAVI TEST OPERATION

Preparation: Refer to the manuals of the indoor unit and turn on the main power switch in advance.  
Human detection cannot be made for approx. 90 seconds when switched on the power because the human detection sensor is set in initial setup.




### 1. Press three buttons.



Keep pressing the ,  and  buttons simultaneously for more than 4 seconds.

The "Maintenance func" menu appears on the screen.







### 2. Select "0. ECONAVI info." from the menu command.

By pressing the  /  buttons, select "0. ECONAVI info." and press the  button.


|   |  |
|---|--|
|  Maintenance func | 20:30 (THU)  |
| 0. ECONAVI info.  |  |
| 1. Outdoor unit error data  |  |
| 2. Service contact  |  |
| 3. RC. setting mode   |  |
| ▼ Sel.  | ▶ Page [  ] Confirm |

### 3. Select "Error found" from the menu command.

By pressing the  /  buttons, select "Error found" and press the  button.

|                   |   |
|-------------------|---|
| ECONAVI info.     | 20:30 (THU)   |
| Sensor unit info. |   |
| System settings   |   |
| Status info.      |   |
| Error found       |   |
| ▲ Sel.            | [  ] Check |

### 4. Check the sensor status shows "Normal".

(By pressing the  /  buttons, the status of each indoor unit can be scrolled on the screen.)

The sensor status of all indoor units are displayed.

- "Normal": The sensor on the panel for cassette (ECONAVI type) works normally.
- "Preparing": The sensor on the panel for cassette (ECONAVI type) is set in initial setup. Confirm that "Normal" appears within 90 seconds.
- "Unsupported": Indoor units not available for ECONAVI function.

|             |               |
|-------------|---------------|
| Error found | 20:30 (THU)   |
| Unit no.    | Status        |
| 1 - 1       | Normal        |
| 1 - 2       | Normal        |
| Sensor 1    | Not connected |
| ▲ Scroll    |               |

The test run procedure described above is over. If any display appears other than "Normal" or "Preparing" even though the ECONAVI panel is connected, follow the Step 5 below.

\* "1-1", "1-2" mean indoor unit No. If the indoor unit is without ECONAVI panel, "Not connected" appears.

\* "Sensor 1" means optional ECONAVI sensor (CZ-CENSC1). If not connected, "Not connected" appears besides "Sensor 1" on the screen.

### 5. If the sensor status shows other than "Normal", "Preparing",



"Error" or "Not connected" although the panel for cassette (ECONAVI type) is connected, the following symptom may have occurred. Specify the applicable indoor unit and check the sensor.  
"Error": The sensor may possibly be damaged.

"Not connected": The wiring between the indoor unit and sensor may possibly be disconnected.


\* The specified indoor unit can be confirmed by the flap operation.

Confirmation method:

#### ① Finish the maintenance function.

Press the  button to show the maintenance function display and then press the  button.

#### ② Operate the flap.

By pressing the  button, select the applicable "Indoor Unit No." in the list of "2. FLAP" and then make flap setting. The indoor unit which responds to the flap setting becomes available.

When the indoor unit is specified, turn off the main power switch and disconnect the connector of sensor wiring from the PCB. Then reconnect it. Turn on the main power switch and repeat the Steps 1 to 4 described above. Confirm the display shows "Error found". If the display shows "Error" or "Not connected" on the screen again, it is necessary to replace the panel for cassette (ECONAVI type) with a new one.



## EXTERNAL DEVICE INTERLOCK

Example of wiring:

This is an example of the combination systems which extract optional output signal by the service wire and relay (field supply). When actuating the external device interlock, use the thermostat signal.

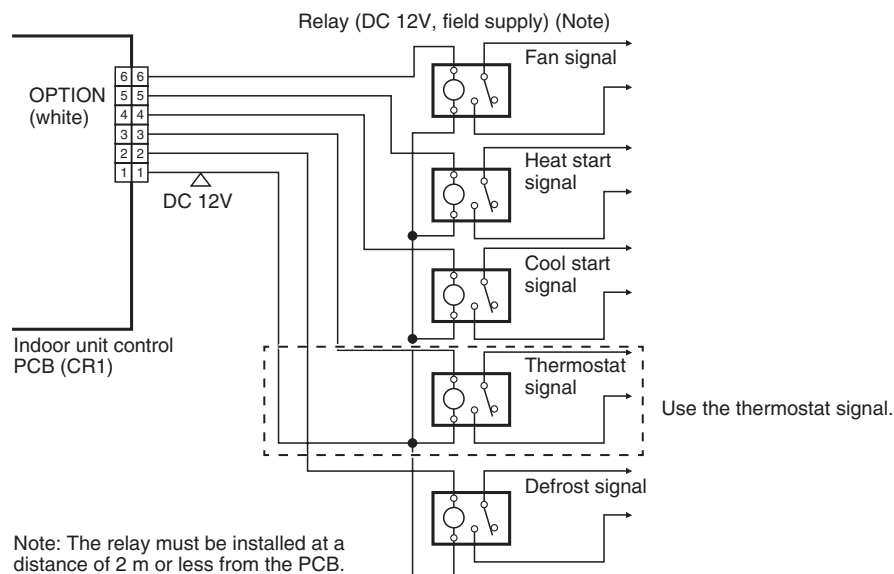
### OPTION Connector (CN060) Output external signals



PAW-OCT: Panasonic has developed an optional accessory (consisting of plug + wires) called PAW-OCT to enable an easy connection to this OPTION Connector (CN060).

With the combination of the T10 and the OPTION Connector (CN060) an external control of the I\_U is possible!

6P (WHITE): OUTPUTS EXTERNAL SIGNALS AS SHOWN IN THE FIGURE BELOW.



### NOTE

- The external output signal from the air conditioner is supplied for the purpose of controlling the external devices. If the air conditioner does not operate, take measures that the movement of external connecting devices can transfer to the safety zone in advance.
- The external output signal from the air conditioner is turned off when the blackout occurs. If any special considerations are needed in case of blackout, provide an external circuit.

## ■ CHECKLIST AFTER INSTALLATION WORK

| Work List       | No.         | Content   | Check <input checked="" type="checkbox"/>   | Possibility of Failure & Checkpoint   |
|-----------------|-------------|---|---|---|
| Installation    | 1           | Are the indoor units installed following the content on page 1-11-3-1 "■ SELECTING THE INSTALLATION SITE"?                                | <input type="checkbox"/>  | There is a possibility of light injure or loss of property.   |
| Tubing & Wiring | 2           | In the case of multiple installation: Is there a wrong tubing connection with another system?   | <input type="checkbox"/>  | The unit is inoperated or the refrigerant flows into the inoperative unit and the leakage is expected. Check if there is a wrong tubing or wiring connection with another system. |
|                 | 3           | In the case of multiple installation: Is there a wrong wiring connection with another system?   | <input type="checkbox"/>  |   |
|                 | 4           | Is the earth leakage circuit breaker (all-pole switching function provided) installed?  | <input type="checkbox"/>  |   |
|                 | 5           | Is there any wrong installation of optional parts or wrong wiring?  | <input type="checkbox"/>  | Power failure or short circuit may cause electric shock or fire. Check installation work and ground wire work.  |
|                 | 6           | Was the ground wire work performed?   | <input type="checkbox"/>  |   |
|                 | 7           | Are there any wrong power supply wiring, wrong connection wire, wrong signal wire or loose screw?   | <input type="checkbox"/>  |   |
|                 | 8           | Is the thickness of wire in accordance with rule?   | <input type="checkbox"/>  |   |
|                 | 9           | Is the power-supply voltage equal to the nameplate of the unit?   | <input type="checkbox"/>  |   |
|                 | 10          | Was the check of the airtight test, flared tube fitting and gas leakage on the welded portion performed?                                  | <input type="checkbox"/>  | If the gas leakage occurs, the unit quality not only becomes inferior but affects environment. Repair it as quickly as possible.  |
|                 | Drain Check | 11  | Has the adhesive been applied to the drain connecting portion (resin portion) of the indoor unit? | <input type="checkbox"/>  |
| 12              |             | Is there water leakage?   | <input type="checkbox"/>  | Since there is a possibility of water drain, repair the drain pipe if the drain failure or water drain occurs.  |
| 13              |             | Indoor unit drain pipe has a downward gradient (1/100 or more) by rule. Is the drain water flowing smoothly?                              | <input type="checkbox"/>  |   |
| Heat Insulation | 14          | Was the heat insulation work at a suitable location including the flared tube fitting (refrigerant tube & drain pipe) performed properly? | <input type="checkbox"/>  | The quality of unit not only becomes inferior but there is a possibility of the water drain. So, perform the heat insulation work properly.                                       |
| Optional Parts  | 15          | Was the short-circuit connector connected or the fan tap changed when installing the air-blocking material?                               | <input type="checkbox"/>  | The discharge temperature decreases in cooling mode according to the reduction of air volume and there is a possibility of dew drops. Be sure to change settings.                 |
| Test Run        | 16          | Did the abnormal sound occur?   | <input type="checkbox"/>  | Check if there is a fan contact or distortion of the indoor unit.   |
|                 | 17          | Did the cool and warm airflow discharge from the indoor unit?   | <input type="checkbox"/>  | Check if the unit does not operate or there is a wrong tubing or wiring connection with another system.   |

**Optional Parts**

■ **Air Intake Chamber**


**CZ-FDU3**

**Installation Instructions**

**Accessory parts**

The accessory parts are required for the installation work so they should not be discarded until the work is completed.

- The following parts are provided inside the package so check that they are accounted for.

| Part name   | No. of parts | Part name  | No. of parts | Part name  | No. of parts |
|---|--------------|--|--------------|--|--------------|
| Screws<br>(5 x 40)<br><br>(Used to secure this<br>Air intake chamber) | 4            | Washers<br><br>(Used to secure this<br>Air intake chamber) | 4            | Installation instructions<br><br> | 1            |

**Mounting procedure**

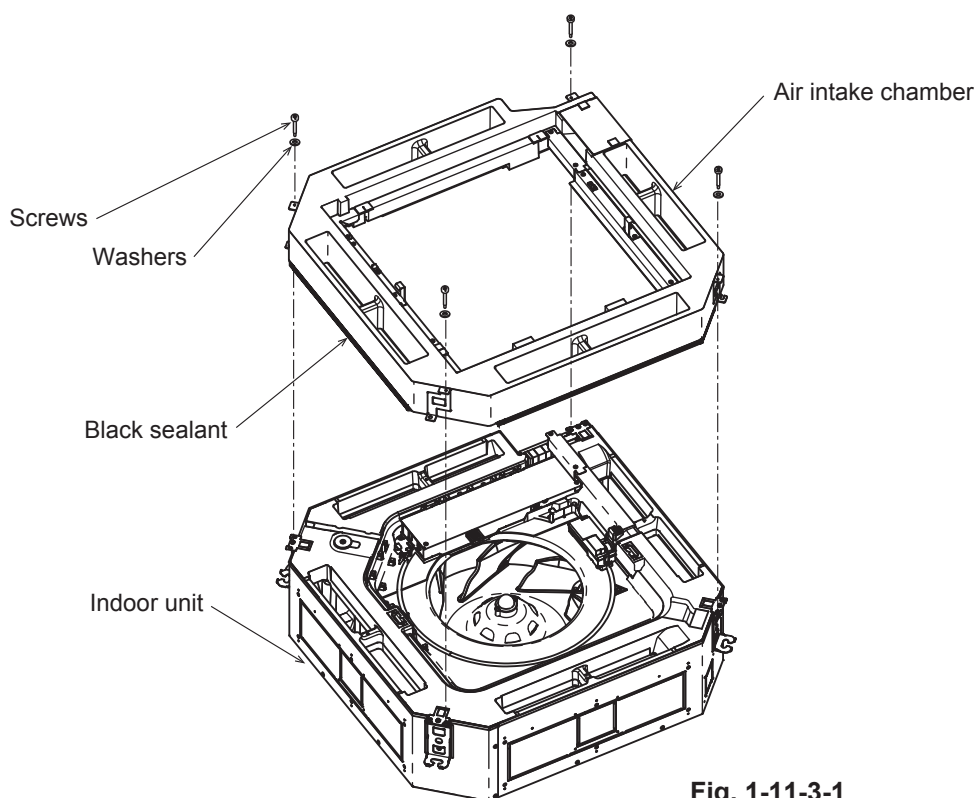
Before proceeding with the mounting, remove the cushions which have been inserted into the air outlets (in 4 places).

<1> Mounting Air intake chamber (Fig. 1-11-3-1)

- Place the black sealant side of Air intake chamber toward the indoor unit.  
(Air intake chamber can be mounted correctly in only one way so ensure that the shapes of the indoor unit and chamber are aligned properly.)
- Use the accessory screws (x4) to secure the indoor unit and Air intake chamber.

<2> Installing the indoor unit

- Install the indoor unit with Air intake chamber mounted on it to the ceiling.  
(Now proceed with the installation in accordance with the installation instructions provided with the indoor unit.)



**Fig. 1-11-3-1**

<3> Mounting the ceiling panel (Fig. 1-11-3-2)

- Mount the ceiling panel to the indoor unit (with Air intake chamber).  
(For details on how the ceiling panel is to be mounted, refer to the installation instructions which are provided with the ceiling panel.)

<4> Connecting the panel cables (Fig. 1-11-3-2)

- Remove the cover of Air intake chamber, and remove the cover of electrical component box.
- Cut the clamp used to bundle the ceiling panel cable, insert the 22P connector (white) of the cable into the through-hole in Air intake chamber, and connect it to the 22P connector inside the electrical component box.
- Return the cover of electrical component box and the cover of Air intake chamber to their original positions.

Mounting procedure (continued)

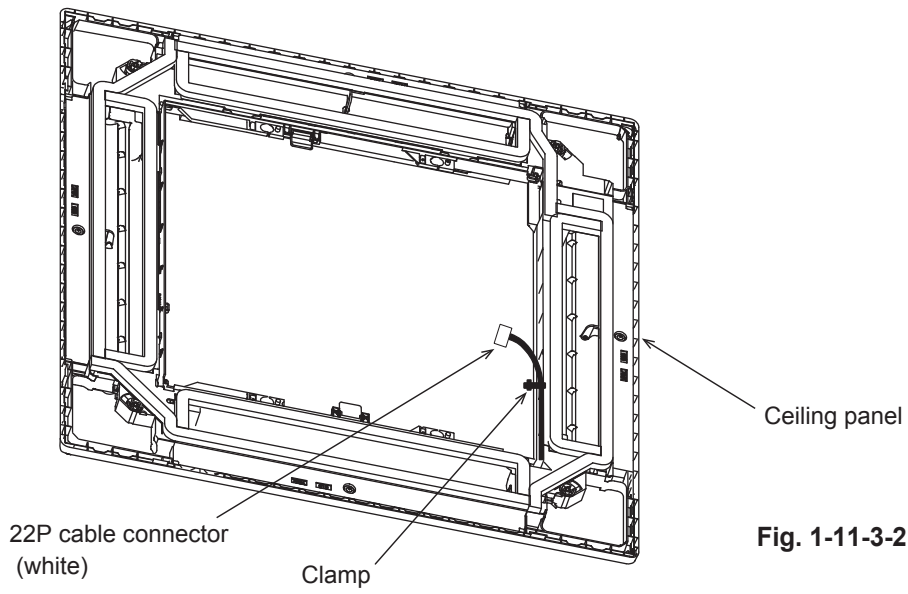
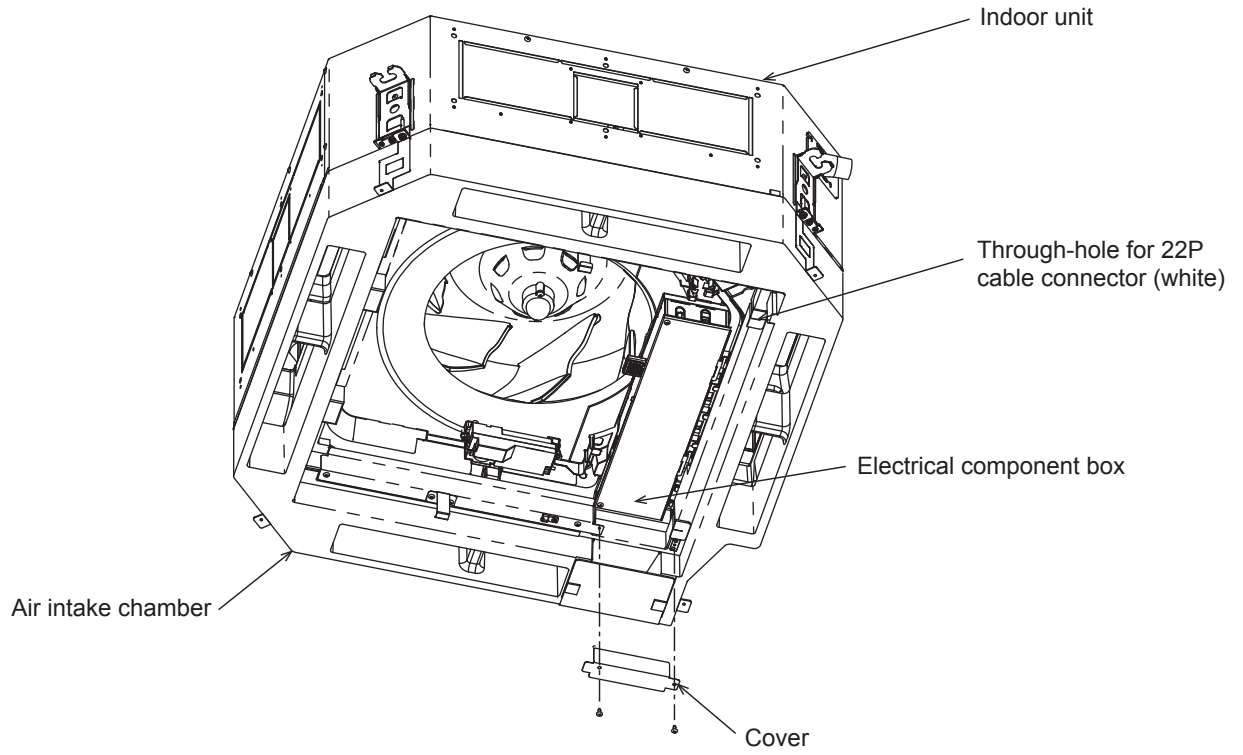


Fig. 1-11-3-2

## Selecting the DC fan motor taps

It is necessary to set the fan speed in accordance with the intended application and the optional parts to be used if any such part is used. (Table 1-11-3-1)

If this speed is not changed, a reduction in the air flow may result, causing the air outlet temperature to drop and condensation to form during cooling.

There are two ways to set the fan speed: either (1) change the positions of the DIP switches on the indoor unit control PCB or (2) set the speed using the wired remote controller. Select one of these ways.

\* Priority is given to setting the fan speed by changing the positions of the DIP switches.

**Table 1-11-3-1 DC fan motor tap setting table**

| Setting No | Item code 5D/5d setting data | Intended application / name of optional parts         | Setting No | Item code 5D/5d setting data | Intended application / name of optional parts         |
|------------|------------------------------|---|------------|------------------------------|---|
|            | 0000                         | Standard (factory setting)                            | (1)        | 0001                         | Air-flow blocking kit(for 3-way air flow)             |
| (1)        | 0001                         | High-ceiling setting 1 (with standard, ECONAVI panel) | (3)        | 0003                         | High-ceiling setting 2 (with standard, ECONAVI panel) |
|            |                              | Air-flow blocking kit (when a duct is connected.)     | (6)        | 0006                         | Air-flow blocking kit (for 2-way air flow)            |

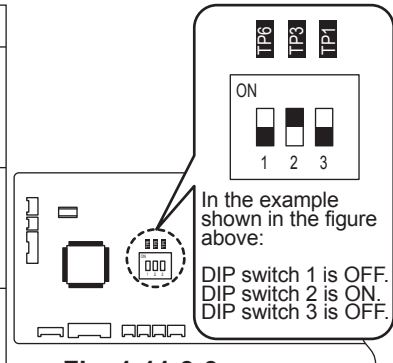
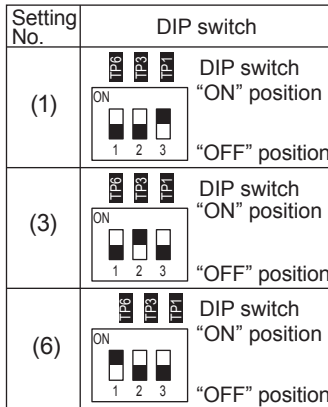
### (1) When setting the fan speed by changing the positions of the DIP switches on the indoor unit control PCB

<Procedure> Be absolutely sure to turn off the power (earth-leakage circuit breaker).

<1> On Table 1-11-3-1, check out the "Setting No." that corresponds to the intended application and the optional parts to be used.

<2> Open the cover of the electrical component box, and check the indoor unit control PCB. (Fig.1-11-3-3)

<3> Select the Setting No. which was checked out on Table 1-11-3-1, and change the positions of the DIP switches on the indoor unit control PCB.



**Fig. 1-11-3-3 Indoor unit control PCB**

### (2) When setting the fan speed using a wired remote controller (optional parts: CZ-RTC5A)

On Table 1-11-3-1, check out the "Item code 5D setting data" that corresponds to the intended application and the optional parts to be used.

<Procedure> Ensure that the unit has stopped operating before changing the fan speed.

<1> Hold down the + + buttons together for at least 4 seconds. The maintenance function screen is displayed.

<2> Use the / buttons to select the display and the / buttons to select the page.

Select "8. Detailed settings" and press the button.

The [Detailed settings screen] appears.

Using the / buttons, select the unit No.

<3> Using the / buttons, select the item code.

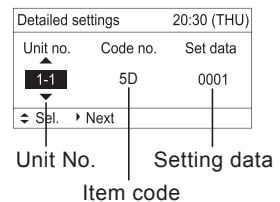
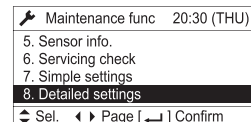
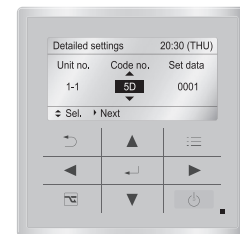
Using the / buttons, change the item code to "5D."

<4> Using the / buttons, select the setting data.

Using the / buttons, change the setting data to the value checked out on Table 1-11-3-1, and press the button.

<5> After selecting the unit No. using the / buttons, press the button. The [Detailed settings completion screen] appears.

Select "Yes", and press the button.



### (3) When setting the fan speed using a wired remote controller (optional parts: CZ-RTC4)

On Table 1-11-3-1, check out the "Item code 5d setting data" that corresponds to the intended application and the optional parts to be used.

<Procedure> Ensure that the units have stopped operating before changing the fan speed.

<1> Hold down the + + buttons together for at least 4 seconds.

<2> Each time the button is pressed, the numbers of the indoor units under group control are displayed in sequence.

The fan motor of only the indoor unit that has been selected will run.

<3> Specify item code "5d" using the temperature setting / buttons.

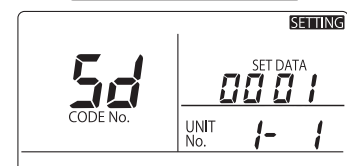
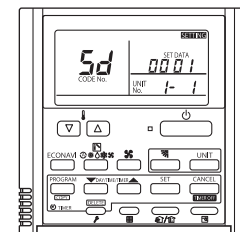
<4> Change the setting data using the hour - buttons. The setting data details are as given on Table 1-11-3-1.

<5> Press the button. (OK if the display changes from flashing to lighted.)

<6> Press the button. The normal stop status is established.

Go to step <2> to change the selected indoor unit.

<7> Press the button. The normal stop status is established.



■ Air-flow Blocking Kit

CZ-CFU3

Installation Instructions

Accessory parts

The accessory parts are required for the installation work so they should not be discarded until the work is completed.

| Part name                     | No. of parts | Part name          | No. of parts | Part name                 | No. of parts |
|-------------------------------|--------------|--------------------|--------------|---------------------------|--------------|
| Air-flow blocker (470×65×T10) | 3            | Sealer (570×90×T2) | 2            | Installation instructions | 1            |
| A:2                           |              |                    |              |                           |              |
| B:1                           |              |                    |              |                           |              |

Mounting procedure

(1) Checking where the air-flow blocker is to be attached

For Air outlet<1>

When Air-flow blocker A is to be attached, cut it in parallel with the slit. (Fig. 1-11-3-4)

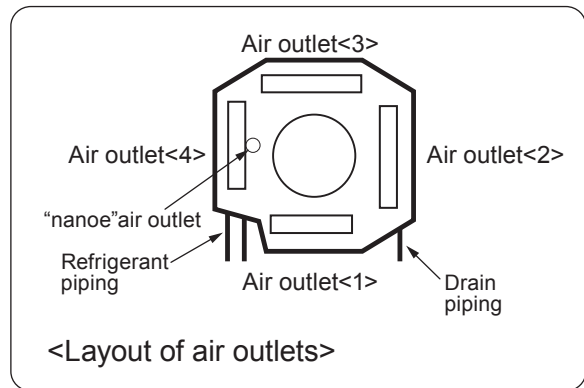
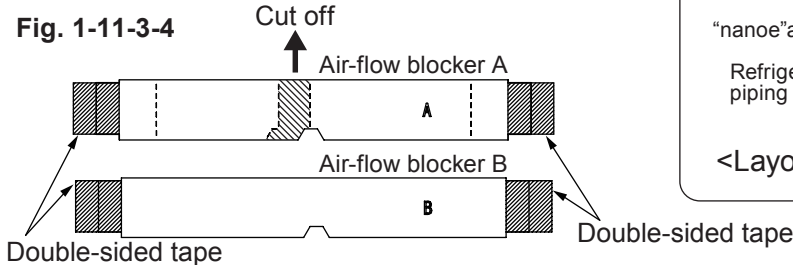
For Air outlet<2>

Air-flow blocker B can be used as is.

For Air outlet<3>or<4>

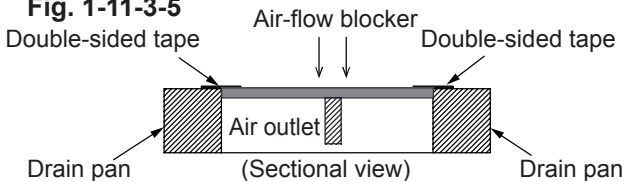
Air-flow blocker A can be used as is.

Fig. 1-11-3-4



(2) Fit the air-flow blocker into place to match the shape of the air outlet, adhere the tape of the both side of air-flow blocker to the drain pan and adhere the sealer on top to block the passage of air. (Fig. 1-11-3-5) (Fig. 1-11-3-6)

Fig. 1-11-3-5



(3) Adhere the sealer to the drain pan with an overlap of 10 mm or more. (Condensation may form if it is adhered with no overlap.)

- (Fig. 1-11-3-7)
  - \*1 Ensure that the sealer does not come into contact with the corner metal fitting.
  - \*2 Cut the sealer diagonally so that no contact is made with the wire.
- Fold the protruding parts of the sealer over the side panel, and adhere them into place.

Fig. 1-11-3-6

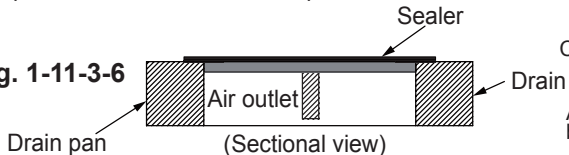
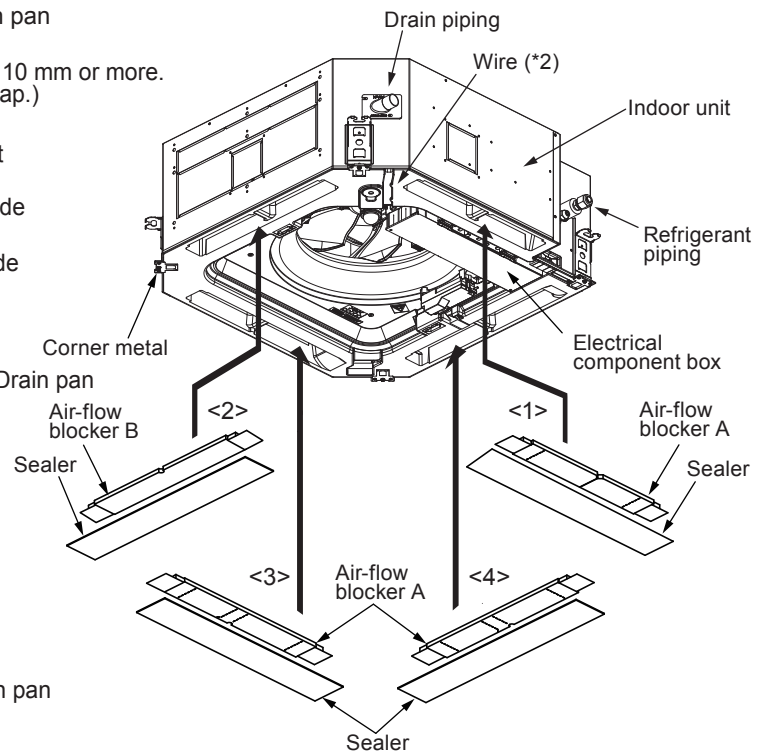
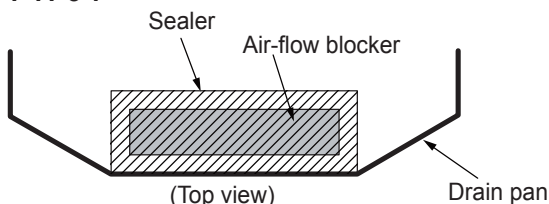


Fig. 1-11-3-7



### Air outlet blocking patterns

#### As seen from underneath the indoor unit

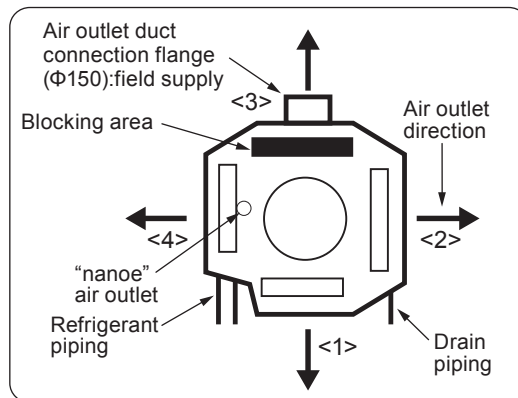
- When a 2- or 3-way air outlet configuration is used or when the air outlet duct connection flange (Φ150):field supply is connected, block the air outlets as per the air outlet blocking patterns illustrated below.

Also, refer to the table below, and decide on where the pipings are to be positioned.

(To better understand what the illustrations show, refer to the figure on the right.)

Note: Take care to prevent cold air leaks and deficient insulation while performing the air outlet duct connection flange (Φ150):field supply work in order to prevent condensation from forming.

- It should be borne in mind that any air outlet blocking pattern with the hatching mark will make it impossible for the “nanoe” nano-technology fine particle function to work.
- Under no circumstances must any air outlet blocking patterns not shown in the table below be used.



|   |  |  |  |  |
|---|--|--|--|--|
| 3-way air outlet<br>One outlet can be blocked.  |  |  |  |  |
| 2-way air outlet<br>Two outlets can be blocked.   |  |  |  |  |
|   |  |  |  |  |
| Air outlet duct connection flange (Φ150):field supply connection 3-way air outlet<br>One outlet can be blocked and connected to a duct.   |  |  |  |  |
| Air outlet duct connection flange (Φ150):field supply connection 2-way air outlet<br>Two outlets can be blocked and connected to a duct.<br><br>Note: The duct can be connected only in one of the locations shown. |  |  |  |  |
|   |  |  |  |  |
|   |  |  |  |  |

#### Changing the DC fan tap settings

While referring to “Selecting the DC fan motor taps,” change the DC fan speed by using the wired remote controller or by setting the DIP switches on the indoor unit control PCB.

## Selecting the DC fan motor taps

It is necessary to set the fan speed in accordance with the intended application and the optional parts to be used if any such part is used. (Table 1-11-3-2)

If this speed is not changed, a reduction in the air flow may result, causing the air outlet temperature to drop and condensation to form during cooling.

There are two ways to set the fan speed: either (1) change the positions of the DIP switches on the indoor unit control PCB or (2) set the speed using the wired remote controller. Select one of these ways.

\* Priority is given to setting the fan speed by changing the positions of the DIP switches.

**Table 1-11-3-2 DC fan motor tap setting table**

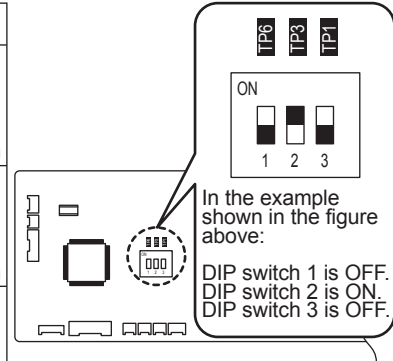
| Setting No | Item code 5D/5d setting data | Intended application / name of optional parts         | Setting No | Item code 5D/5d setting data | Intended application / name of optional parts         |
|------------|------------------------------|---|------------|------------------------------|---|
|            | 0000                         | Standard (factory setting)                            | (1)        | 0001                         | Air-flow blocking kit(for 3-way air flow)             |
| (1)        | 0001                         | High-ceiling setting 1 (with standard, ECONAVI panel) | (3)        | 0003                         | High-ceiling setting 2 (with standard, ECONAVI panel) |
|            |                              | Air-flow blocking kit (when a duct is connected.)     | (6)        | 0006                         | Air-flow blocking kit (for 2-way air flow)            |

### (1) When setting the fan speed by changing the positions of the DIP switches on the indoor unit control PCB

<Procedure> Be absolutely sure to turn off the power (earth-leakage circuit breaker).

- <1> On Table 1-11-3-2, check out the "Setting No." that corresponds to the intended application and the optional parts to be used.
- <2> Open the cover of the electrical parts box, and check the indoor unit control PCB. (Fig. 1-11-3-8)
- <3> Select the Setting No. which was checked out on Table 1-11-3-2, and change the positions of the DIP switches on the indoor unit control PCB.

| Setting No. | DIP switch  |
|-------------|---|
| (1)         | <p>DIP switch "ON" position</p> <p>"OFF" position</p> |
| (3)         | <p>DIP switch "ON" position</p> <p>"OFF" position</p> |
| (6)         | <p>DIP switch "ON" position</p> <p>"OFF" position</p> |



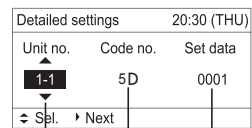
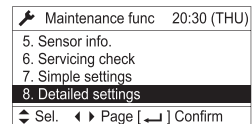
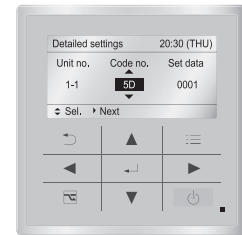
**Fig. 1-11-3-8**  
Indoor unit control PCB

### (2) When setting the fan speed using a wired remote controller (optional parts: CZ-RTC5A)

On Table 1-11-3-2, check out the "Item code 5D setting data" that corresponds to the intended application and the optional parts to be used.

<Procedure> Ensure that the unit has stopped operating before changing the fan speed.

- <1> Hold down the + + buttons together for at least 4 seconds. The maintenance function screen is displayed.
- <2> Use the / buttons to select the display and the / buttons to select the page.  
Select "8. Detailed settings" and press the button. The [Detailed settings screen] appears.  
Using the / buttons, select the unit No.
- <3> Using the / buttons, select the item code.  
Using the / buttons, change the item code to "5D."
- <4> Using the / buttons, select the setting data.  
Using the / buttons, change the setting data to the value checked out on Table 1-11-3-2, and press the button.
- <5> After selecting the unit No. using the / buttons, press the button. The [Detailed settings completion screen] appears.  
Select "Yes", and press the button.



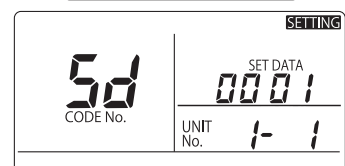
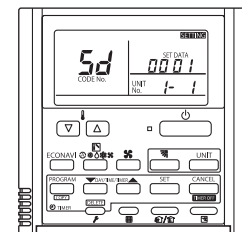
Unit No.      Setting data  
Item code

### (3) When setting the fan speed using a wired remote controller (optional parts: CZ-RTC4)

On Table 1-11-3-2, check out the "Item code 5d setting data" that corresponds to the intended application and the optional parts to be used.

<Procedure> Ensure that the units have stopped operating before changing the fan speed.

- <1> Hold down the + + buttons together for at least 4 seconds.
- <2> Each time the button is pressed, the numbers of the indoor units under group control are displayed in sequence.  
The fan motor of only the indoor unit that has been selected will run.
- <3> Specify item code "5d" using the temperature setting / buttons.
- <4> Change the setting data using the hour buttons. The setting data details are as given on Table 1-11-3-2.
- <5> Press the button. (OK if the display changes from flashing to lighted.)
- <6> Press the button. The normal stop status is established.  
Go to step <2> to change the selected indoor unit.
- <7> Press the button. The normal stop status is established.





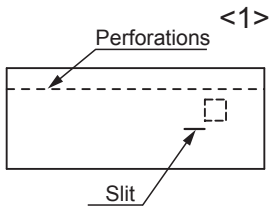
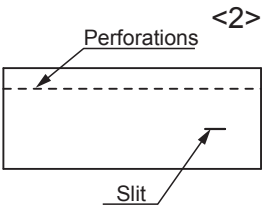
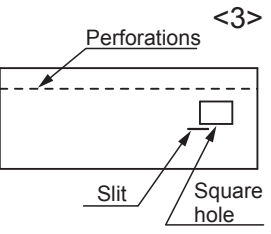
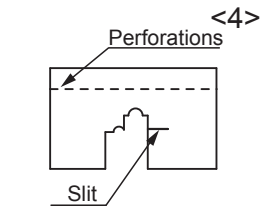
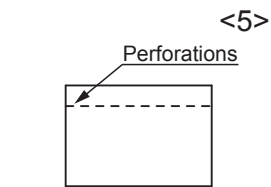
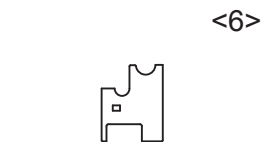
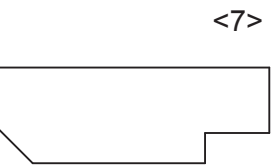

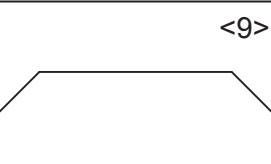
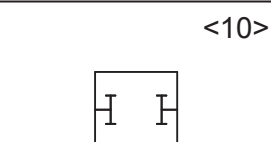
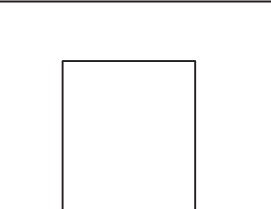
■ Thermal Insulation Kit

CZ-INSU3

Installation Instructions

Parts installed on the indoor unit

● Details of parts

|              |   |   |  |   |
|--------------|---|---|--|---|
| Part name    | Side panel insulator  | Side panel insulator  | Side panel insulator   | Side panel insulator  |
| Shape        |    |    |    |  |
| No. of parts | 1   | 1   | 1  | 1   |
| Part name    | Side panel insulator  | Side panel insulator  | Ceiling insulator  | Ceiling insulator   |
| Shape        |    |    |    |  |
| No. of parts | 1   | 1   | 1  | 1   |
| Part name    | Ceiling insulator   | Hanger insulator  | Installation instructions  |   |
| Shape        |  |  |  |   |
| No. of parts | 1   | 4   | 1  |   |

● Procedure for attaching the parts

\* Indoor unit has two kinds of heights.(Large unit=319mm, Small unit=256mm)  
 When attaching the side panel insulator to the small unit, attach it after cutting along its perforations of the parts<1> to <5>

1. Align the slits of the side panel insulators <1> to <4> with the hanger, and attach the parts to the side panels of the indoor unit. (Fig. 1-11-3-9)
2. Now attach the side panel insulator <5> to the side panel of the indoor unit. (Fig. 1-11-3-9)
3. Align the side panel insulator <6> with the piping cover, and attach the part. (Fig. 1-11-3-9)
4. Attach the ceiling insulators <7> to <9> in such a way that no gaps are left. (Fig. 1-11-3-10)

Do the following procedures after installing the indoor unit.

5. Attach the hanger insulators <10> to the hangers in the directions shown in the figure. (Fig. 1-11-3-11)

\* Keep hanger insulator<10> until installing the indoor unit.

## Parts installed on the indoor unit (continued)

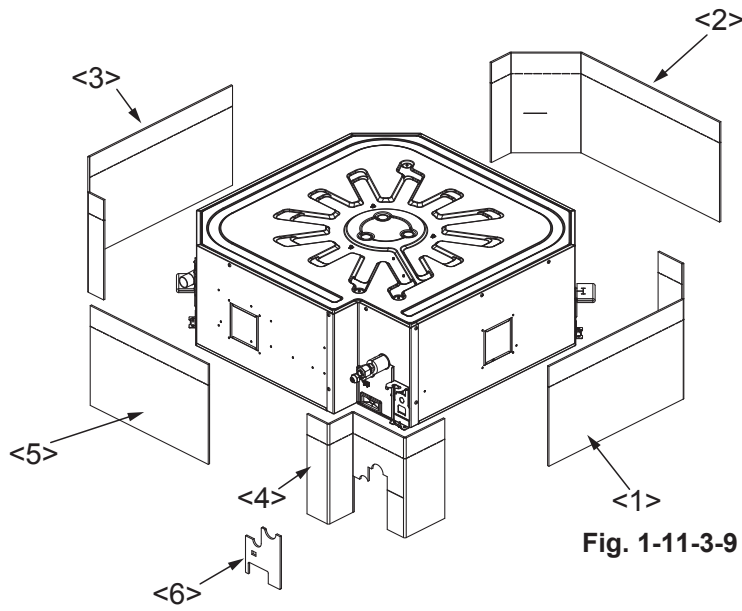


Fig. 1-11-3-9

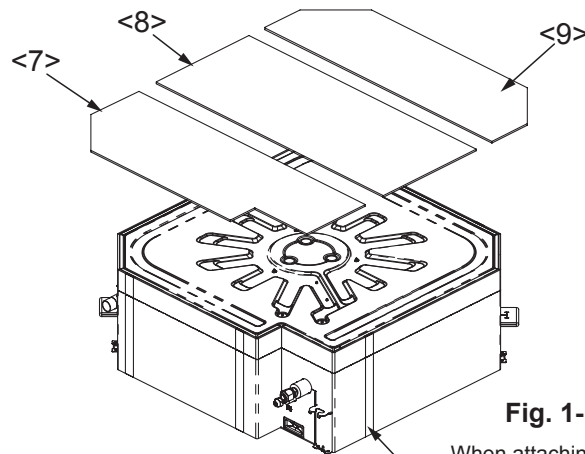


Fig. 1-11-3-10

When attaching the insulators, ensure that they overlap. (Side insulators <1> to <5>)

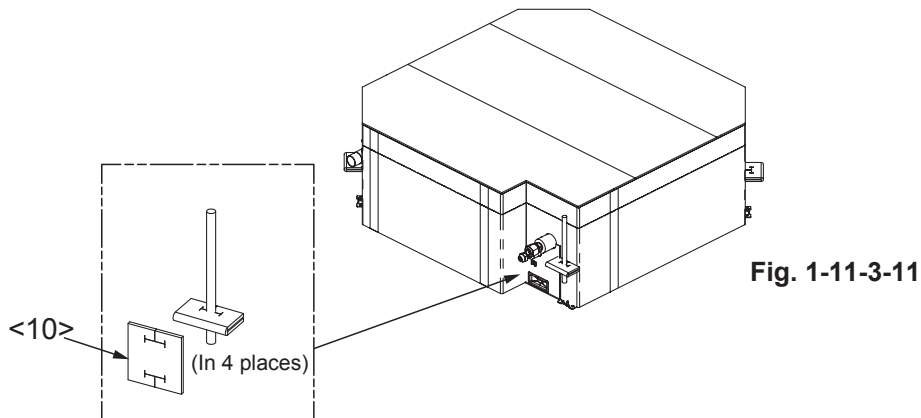
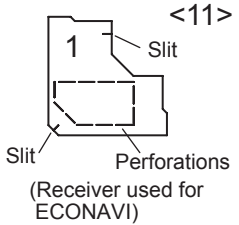
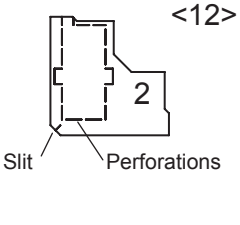
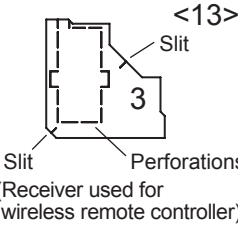
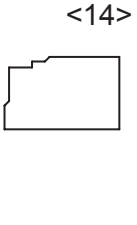
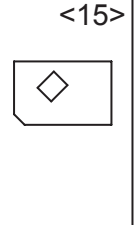
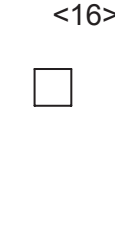


Fig. 1-11-3-11

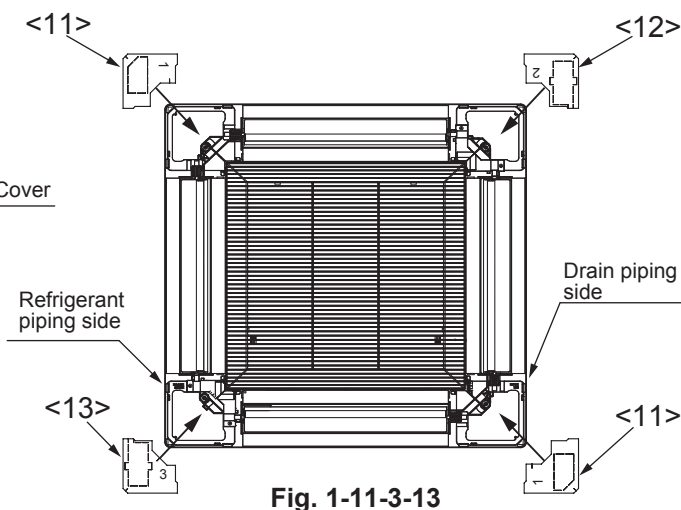
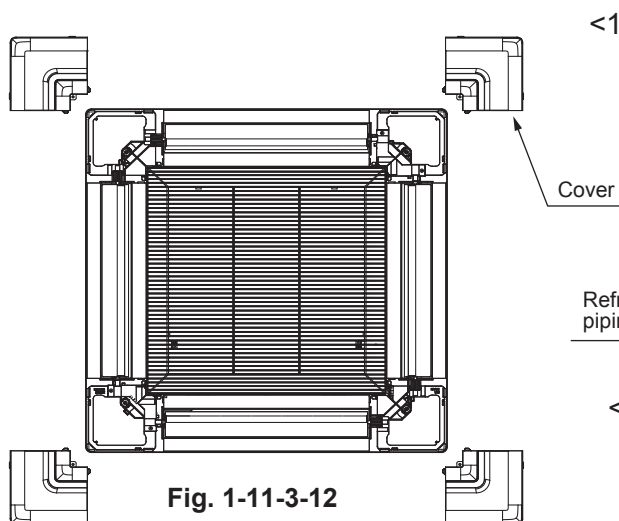
Parts mounted on ceiling panels

● Details of parts

| Part name    | Insulator   | Insulator   | Insulator   | Insulator  | Insulator   | Insulator   |
|--------------|---|---|---|--|---|---|
| Shape        |  <p>&lt;11&gt;</p> |  <p>&lt;12&gt;</p> |  <p>&lt;13&gt;</p> |  <p>&lt;14&gt;</p> |  <p>&lt;15&gt;</p> |  <p>&lt;16&gt;</p> |
| No. of parts | 2   | 1   | 1   | 2  | 1   | 1   |

● Procedure for attaching the parts

1. Remove the covers in the four corners. (Fig. 1-11-3-12)
2. Fit the ceiling panel to the indoor unit.  
(For details on how the ceiling panel is to be fitted, refer to the installation instructions which are provided with the ceiling panel.)
3. Fit the insulators <11> to <13> onto the four corners of the ceiling panel exactly as shown in Fig. 1-11-3-13.
4. Fit the cover in place. The cover can fall off in this state so be absolutely sure to secure it in place using the fixing screws.



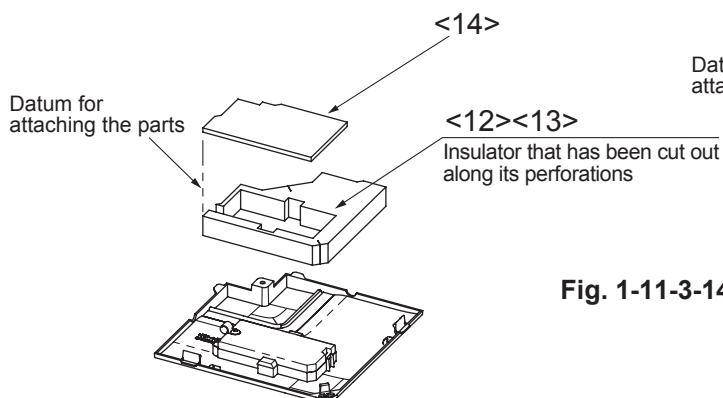
<When mounting the parts onto the receivers (Fig. 1-11-3-14)>

Cut out along the perforations the insulators <11>, <12> and/or <13> that fit the mounting location, mount them by matching them to the shape of each receiver, and attach the covers to the ceiling panel.

\* Be absolutely sure to use the maximum dimensions of 910 mm x 910 mm for the extent of the ceiling opening so that the ceiling surface and insulators will not absorb any shocks.

(For details on how the ceiling panel is to be fitted, refer to the installation instructions which are provided with the ceiling panel.)

For Wireless remote controller receiver



For ECONAVI panel

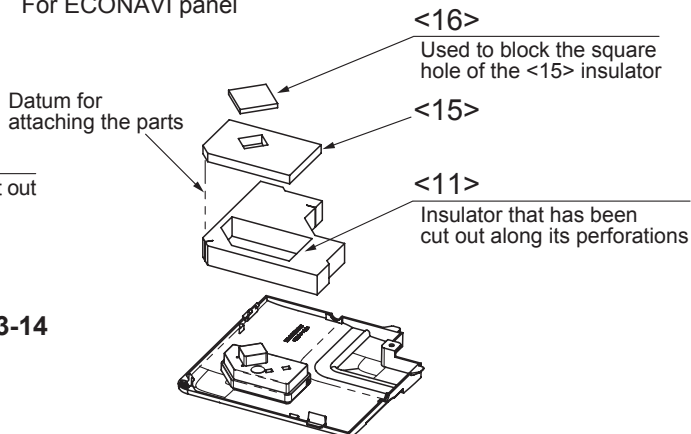


Fig. 1-11-3-14

#### 4. Ceiling Type (T2)

##### ■ SELECTING THE INSTALLATION SITE

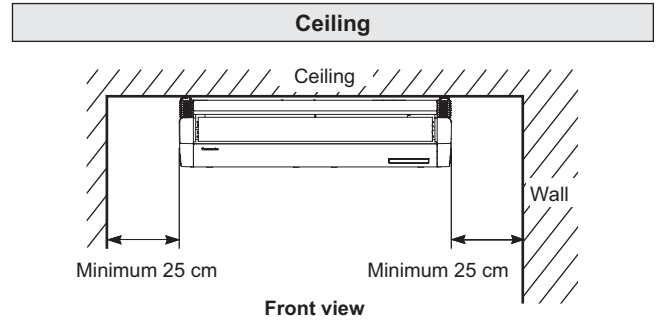
###### Indoor Unit

###### AVOID:

- areas where leakage of flammable gas may be expected.
- places where large amounts of oil mist exist.
- direct sunlight.
- locations near heat sources which may affect the performance of the unit.
- locations where external air may enter the room directly. This may cause "condensation" on the air discharge ports, causing them to spray or drip water.
- locations where the remote controller will be splashed with water or affected by dampness or humidity.
- installing the remote controller behind curtains or furniture.
- locations where high-frequency emissions are generated.

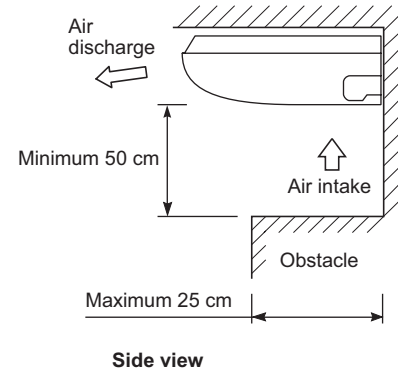
###### DO:

- select an appropriate position from which every corner of the room can be uniformly cooled.
- select a location where the ceiling is strong enough to support the weight of the unit.
- select a location where tubing and drain pipe have the shortest run to the outdoor unit.
- allow room for operation and maintenance as well as unrestricted air flow around the unit.
- install the unit within the maximum elevation difference above or below the outdoor unit and within a total tubing length (L) from the outdoor unit as detailed in the Installation Instructions provided with the outdoor unit.
- allow room for mounting the remote controller about 1 m off the floor, in an area that is not in direct sunlight or in the flow of cool air from the indoor unit.



###### NOTE

The rear of the indoor unit can be installed flush against the wall.



■ HOW TO INSTALL THE INDOOR UNIT

Unit: mm

■ Ceiling Type (Type T2)

4-1. Required Minimum Space for Installation and Service

(1) Dimensions of suspension bolt pitch and unit

| Type \ Length | A    | B    | C   |
|---------------|------|------|-----|
| 36, 45, 50    | 911  | 960  | 235 |
| 60, 71        | 1226 | 1275 | 235 |
| 100, 125, 140 | 1541 | 1590 | 235 |

Unit: mm

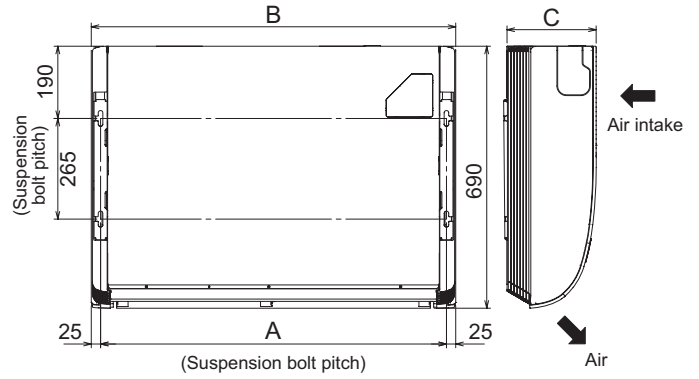


Fig. 1-11-4-1

Unit: mm

(2) Refrigerant tubing • drain hose position

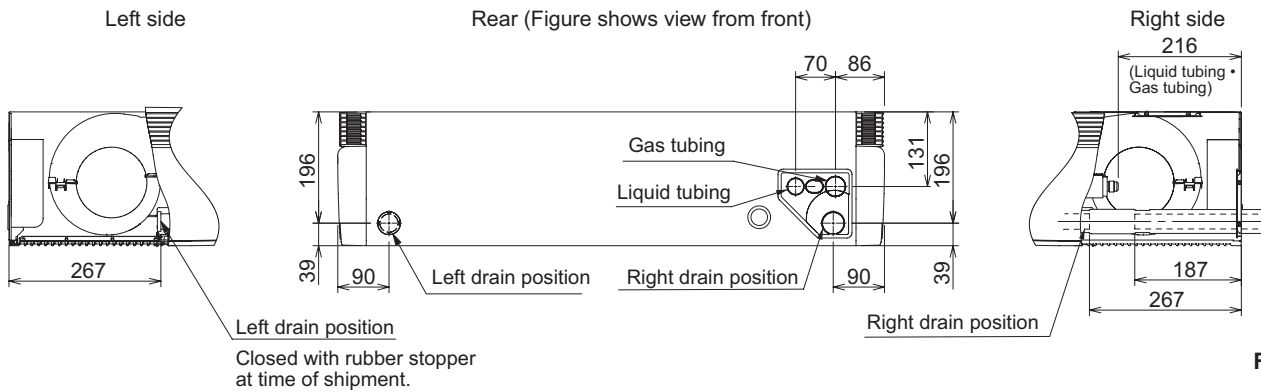
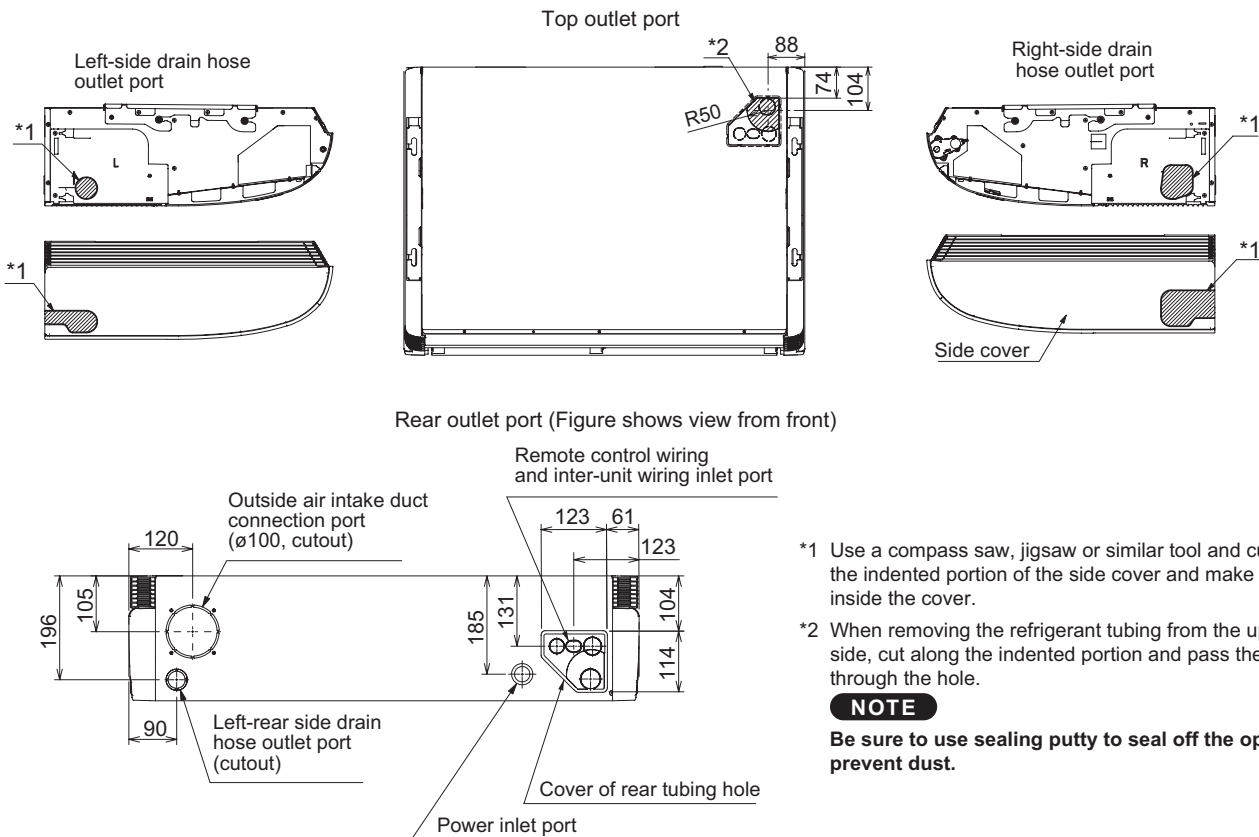


Fig. 1-11-4-2

(3) Unit opening position (Refrigerant tubing • drain hose • power inlet port • remote control wiring inlet port)

Unit: mm



\*1 Use a compass saw, jigsaw or similar tool and cut along the indented portion of the side cover and make a hole inside the cover.

\*2 When removing the refrigerant tubing from the upper side, cut along the indented portion and pass the tubing through the hole.

**NOTE**

Be sure to use sealing putty to seal off the opening to prevent dust.

Fig. 1-11-4-3

### 4-2. Preparation Before Installation

- (1) Remove the bracket (for suspending the indoor unit).  
Loose the M8 suspension bolts.  
Then remove the bracket. (Fig. 1-11-4-4)

**NOTE**

Keep the M8 suspension bolts fixed on to the bracket loose.  
Loosen the M8 suspension bolts and expose the axis of bolts less than 8 mm.

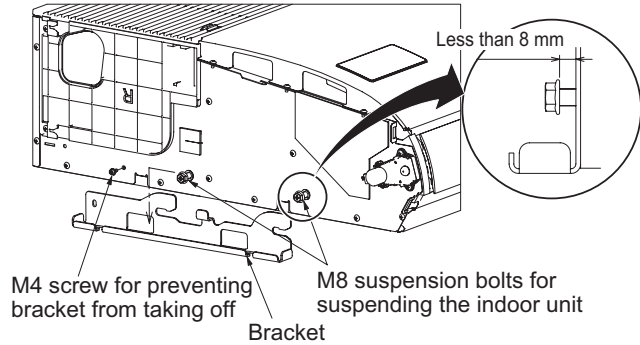


Fig. 1-11-4-4

- (2) Remove the air-intake grille before suspending the indoor unit. First, remove 2 attachment screws fixed with the latches. Open the air-intake grille and hold the claws of the hinges on both sides. Then remove the air-intake grille and suspension lug located on the left and right side of the indoor unit.

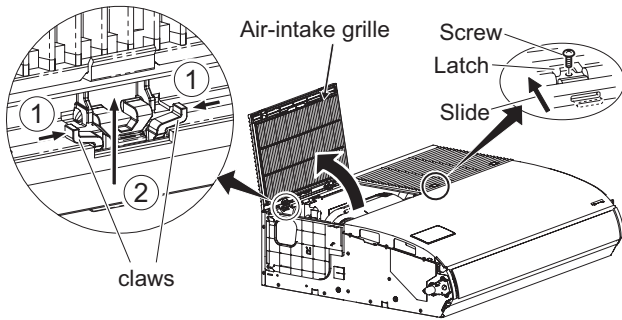


Fig. 1-11-4-5

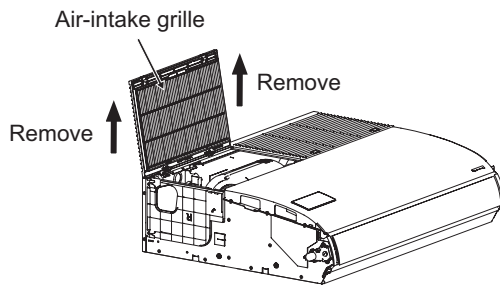


Fig. 1-11-4-6

- (3) Remove the side plate to the tubing side.

|                                     |   |
|-------------------------------------|---|
| Rear & upper side tubing connection | Remove 2 screws.<br>Slide the side plate in the direction of the arrow and remove it. |
| Right side tubing connection        | Do not remove the side plate.   |

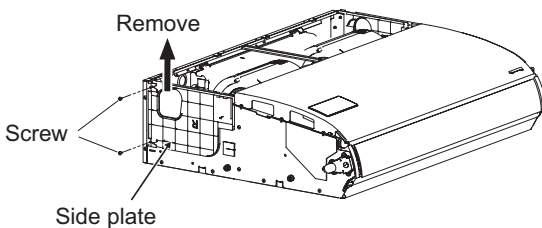


Fig. 1-11-4-7

- (4) Remove the center bracket.  
When wiring, remove the center bracket if necessary.  
When wiring is completed, reinstall the center bracket in its original position.

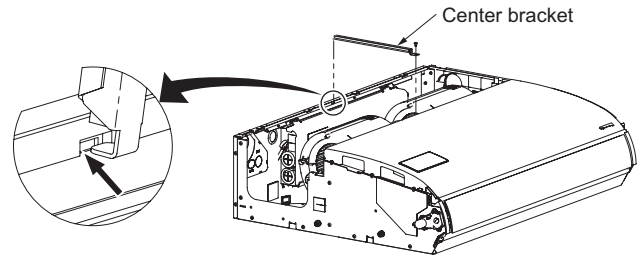


Fig. 1-11-4-8

### 4-3. Suspending the Indoor Unit

**NOTE**

Since the diagram is made of paper, it may shrink or stretch slightly because of high temperature or humidity. For this reason, before drilling the holes maintain the correct dimensions between the markings.

- (1) If the full-scale installation diagram is placed on the ceiling, the locations of each suspension bolt can be chosen. Take a pencil and mark the drill holes (Fig. 1-11-4-9).

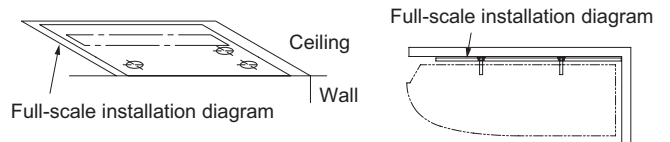


Fig. 1-11-4-9

- (2) If the full-scale installation diagram is bent at right angle to the ceiling and wall, the locations of the inlet for indoor tubing and wiring are chosen and the locations of each suspension bolt can also be chosen. Take a pencil and mark the drill holes (Fig. 1-11-4-10).

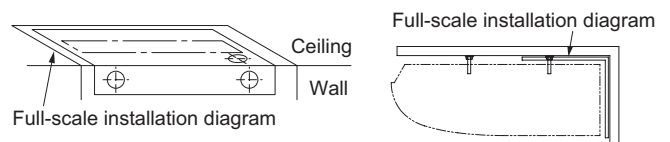


Fig. 1-11-4-10

**NOTE**

The dimension when the indoor unit is placed tightly against the wall.  
When installing away from the wall, drainage gradient should be taken into consideration.

- (3) Drill holes at the 4 points indicated on the full-scale diagram.
- (4) Depending on the ceiling type:
  - a) Insert suspension bolts (Fig. 1-11-4-11).
  - or
  - b) Use existing ceiling supports or construct a suitable support (Fig. 1-11-4-12).

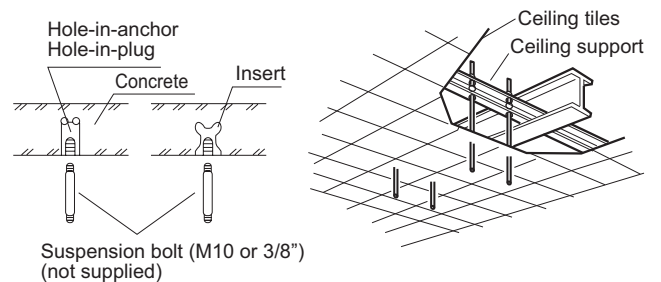


Fig. 1-11-4-11

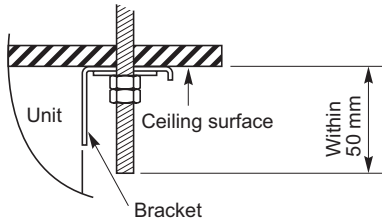
Fig. 1-11-4-12



**WARNING**

It is important that you use extreme care in supporting the indoor unit from the ceiling. Ensure that the ceiling is strong enough to support the weight of the unit. Before suspending the ceiling unit, test the strength of each attached suspension bolt.

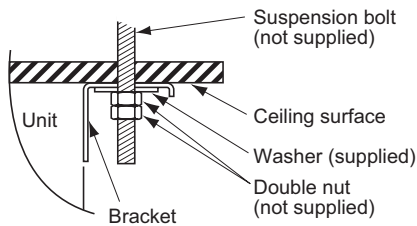
- (5) Screw in the suspension bolts, allowing them to protrude from the ceiling (Figs. 1-11-4-11 and 1-11-4-12). The distance of each exposed bolt must be of equal length within 50 mm. (Fig. 1-11-4-13)



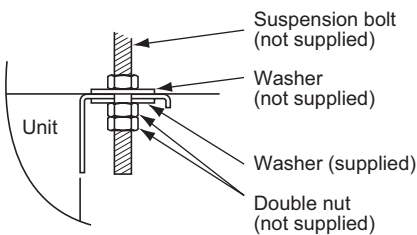
**Fig. 1-11-4-13**

- (6) Carry out the preparation for suspending the indoor unit. The suspension method varies depending on whether there is a suspended ceiling or not. (Figs. 1-11-4-14 and 1-11-4-15)
- (7) Suspend the indoor unit as follows:

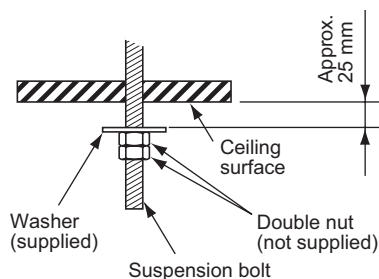
- a) Install the bracket to the suspension bolt. Stick it onto the ceiling surface. (Figs. 1-11-4-14 and 1-11-4-16)



**Fig. 1-11-4-14**

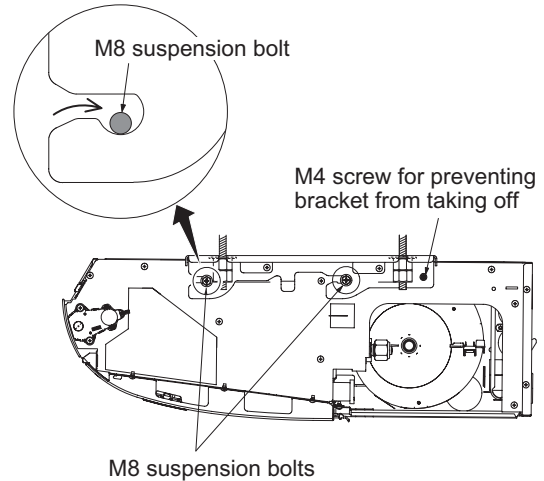


**Fig. 1-11-4-15**



**Fig. 1-11-4-16**

- b) Suspend the indoor unit to the bracket. Tighten the M8 suspension bolts and fix the indoor unit in place. (Fig. 1-11-4-17)



**Fig. 1-11-4-17**

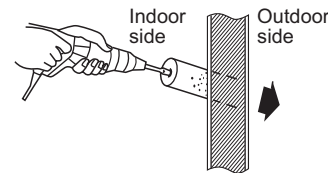
**NOTE**

The ceiling surface is not always level. Confirm that the indoor unit is evenly suspended. For the installation to be correct, leave a clearance of about 10 mm between the ceiling panel and the ceiling surface and fill the gap with an appropriate insulation or filler material.

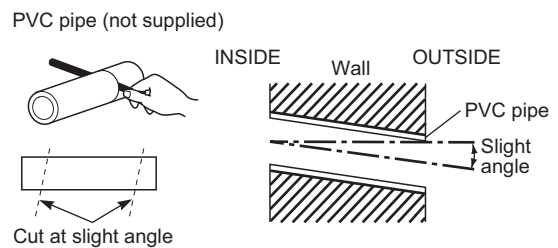
- (8) If the tubing and wiring are to go towards the rear of the unit, make holes in the wall. (Fig. 1-11-4-18)
- (9) Measure the thickness of the wall from the inside to the outside and cut PVC pipe at a slight angle to fit. Insert the PVC pipe in the wall. (Fig. 1-11-4-19)

**NOTE**

The hole should be made at a slight downward slant to the outside.



**Fig. 1-11-4-18**



**Fig. 1-11-4-19**

**4-4. Duct for Fresh Air**

There is a outside air intake duct connection port (cut-out hole) at the left-rear of the indoor unit for drawing in fresh air. If it is necessary to draw in fresh air, remove the cover by opening the hole and connecting the duct to the indoor unit through the connection port.

## 4-5. Shaping the Tubing

- The positions of the refrigerant tubing connections are shown in the figure below. (The tubing can be routed in 3 directions.) (Fig. 1-11-4-20)
- \* When routing the tubing out through the top or right sides, cut out the appropriate parts in the top panel and cut notches in the side panel.

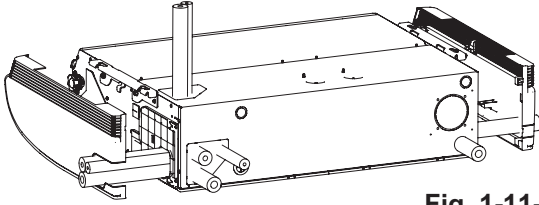
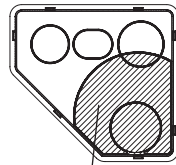


Fig. 1-11-4-20

If the tubing is to be routed out together, use a box cutter or similar tool to cut out the part of the rear cover indicated by the marked area (Fig. 1-11-4-21), to match the positions of the tubes. Then draw out the tubing.



Rear cover

Fig. 1-11-4-21

## 4-6. Installing the Drain Pipe

- Prepare standard PVC pipe for the drain and connect it to the indoor unit drain pipe with the supplied hose band to prevent water leaks.
- (1) Drain hose connection
    - The drain hose is connected below the refrigerant tubing.
  - (2) Installing the drain hose
    - First insert the drain hose (supplied) to the hose band (supplied) and then install the drain hose to the unit drain port.
    - Insert until the drain hose bumps to the end.
    - Attach the hose band to make the fixed portion 45° upper slant according to a vinyl tape (not supplied) of the drain hose (supplied).
    - Hose band screw torque is 30 - 35N · cm.
    - Wind the vinyl tape not to blow up the hose band.
    - Connect both the drain hose and PVC pipe (VP20 or similar material, not supplied). Insert until the PVC pipe bumps to the end and adhere with PVC adhesive.



### CAUTION

- **Wrap the drain insulator (supplied) between the connection of the drain hose and tubing not to expose the copper tubing. Also, wrap the hose band together. Wrap the hose band with the drain insulator, where the screw is located facing upward (Fig. 1-11-4-23). Then, tighten the insulator with a vinyl tape not to cause the detachment. If the tubing parts remain exposed, condensation may occur.**
- **Be sure to use the supplied drain hose.**
- If other commercially available hose bands are used, the drain hose may become pinched or wrinkled and there is danger of water leakage. Therefore be sure to use the supplied hose bands.

- Connect the drain pipe so that it slopes downward from the unit to the outside. (Fig. 1-11-4-22)

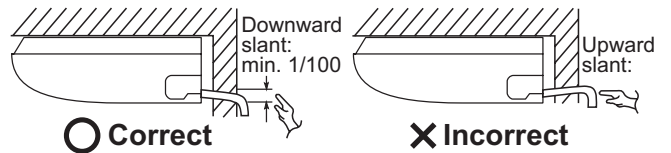


Fig. 1-11-4-22

- Never allow water traps to occur in the course of the piping.
- Insulate any piping inside the room to prevent dripping.
- After the drain piping, pour an appropriate amount of water into the drain pan through the opening on the side of the air discharge port. Check the water draining smoothly.
- \* If the drain hose is routed through the left side, refer to Fig. 1-11-4-20, and follow the procedure above to install the hose. Reattach the rubber stopper removed earlier onto the right side.

The rubber stopper can be inserted easily by using a screwdriver or similar tool to press the stopper into the drain port on the main unit. Press the stopper into the main unit drain port as far as it will go.

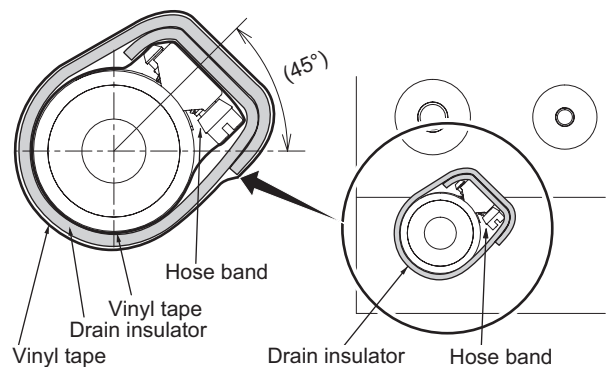
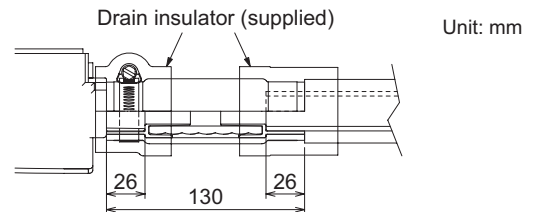
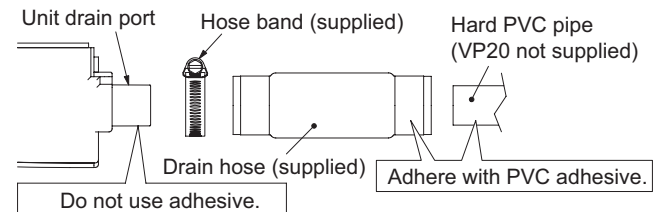
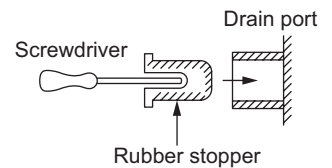


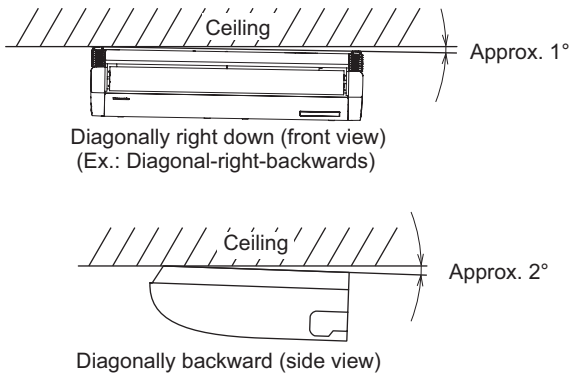
Fig. 1-11-4-23





**CAUTION**

The indoor unit should be slightly tilted downward toward the drain pipe connection side as shown in figure below so that the wastewater can flow smoothly without being trapped in the middle. (Fig. 1-11-4-24)

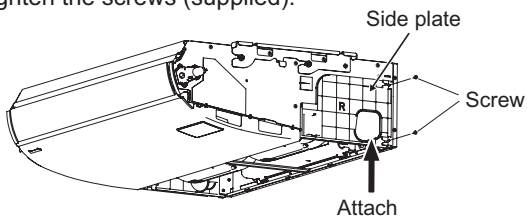


**Fig. 1-11-4-24**

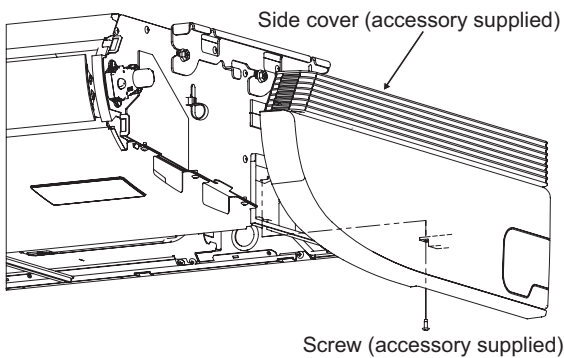
**4-7. Final Procedure**

Reinstall the removed part to be placed in its original position. (See the section “4-2. Preparation Before Installation”.) Then install the accessory supplied side covers (L/R) on both sides of the indoor unit.

- Attach the supplied side plates.  
Slide the covers from the front side and attach to the claws of the latches.  
Tighten the screws (supplied).

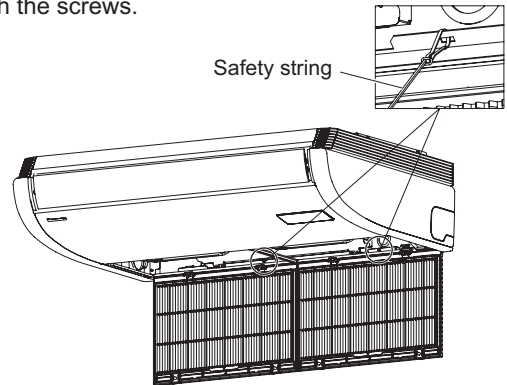


- Attach the accessory supplied side covers.  
Insert the side plates in the direction of the arrow and fix them with 2 screws once you've removed.



**Fig. 1-11-4-25**

- Attach the air-intake grille.  
When attaching the air-intake grille, perform the reverse procedure to removing the grille. Refer to the section “4-2. Preparation Before Installation”. Be sure to attach the safety string.  
Close the air-intake grille and fix the claws of the latches with the screws.



**Fig. 1-11-4-26**

**(Ceiling)**

| Part Name                       | Figure | Q'ty | Remarks   |
|---------------------------------|--------|------|---|
| Special washer                  |        | 4    | For temporarily suspending indoor unit from ceiling |
| Drain insulator                 |        | 2    | For drain hose joint                                |
| Flare insulator                 |        | 1    | For gas tube joint                                  |
|                                 |        | 1    | For liquid tube joints                              |
| Clamper                         |        | 6    | For flare insulator and wiring                      |
| Full-scale installation diagram |        | 1    | For positioning installation                        |
| Drain hose                      |        | 1    | For main unit + PVC pipe joints                     |
| Hose band                       |        | 1    | For drain hose connection                           |
| Side cover (R)                  |        | 1    | (Packed in carton box) For right side               |
| Side cover (L)                  |        | 1    | (Packed in carton box) For left side                |
| Screw                           |        | 2    | For side cover (L/R)                                |
| Operating Instructions          |        | 1    |   |
| Installation Instructions       |        | 1    |   |

## 5. Wall Mounted Type (K1)

### ■ SELECTING THE INSTALLATION SITE

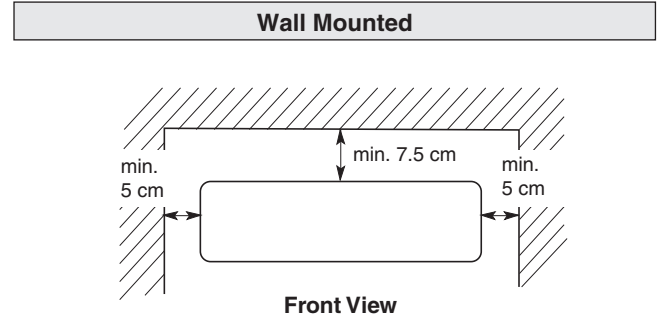
#### Indoor Unit

##### AVOID:

- areas where leakage of flammable gas may be expected.
- places where large amounts of oil mist exist.
- direct sunlight.
- locations near heat sources which may affect the performance of the unit.
- locations where external air may enter the room directly. This may cause "condensation" on the air discharge ports, causing them to spray or drip water.
- locations where the remote controller will be splashed with water or affected by dampness or humidity.
- installing the remote controller behind curtains or furniture.
- locations where high-frequency emissions are generated.

##### DO:

- select an appropriate position from which every corner of the room can be uniformly cooled.
- select a location where the ceiling is strong enough to support the weight of the unit.
- select a location where tubing and drain pipe have the shortest run to the outdoor unit.
- allow room for operation and maintenance as well as unrestricted air flow around the unit.
- install the unit within the maximum elevation difference above or below the outdoor unit and within a total tubing length (L) from the outdoor unit as detailed in the Installation Instructions provided with the outdoor unit.
- allow room for mounting the remote controller about 1 m off the floor, in an area that is not in direct sunlight or in the flow of cool air from the indoor unit.

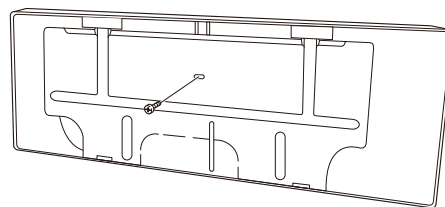


## ■ HOW TO INSTALL THE INDOOR UNIT

### ■ Wall Mounted Type (Type K1)

#### Remove the Rear Panel from the Unit

- (1) Remove and discard the set screw on the rear panel. (Fig. 1-11-5-1)
- (2) Press the 2 △ marks on the frame cover and disengage the stationary tabs from the frame. (Fig. 1-11-5-2)
- (3) Remove the rear panel by grasping the sections shown in Fig. 1-11-5-3 and pulling it in the direction shown by the arrow.



Set screw only for transportation

Fig. 1-11-5-1

#### NOTE

Tubing can be extended in 6 directions as shown in Fig. 1-11-5-5. Select the direction you need providing the shortest run to the outside unit.

- When left tubing is to be done, switch the drain hose and drain cap. (For details, refer to “Switching drain hose and drain cap”.)

#### Make a Hole

- (1) Place the rear panel from the indoor unit on the wall at the location selected. Make sure the panel is horizontal, using a carpenter’s level or tape measure to measure down from the ceiling. Wait until after cutting the hole before attaching the rear panel to the wall.
- (2) Determine which side of the unit you should make the hole for tubing and wiring. (Fig. 1-11-5-6)

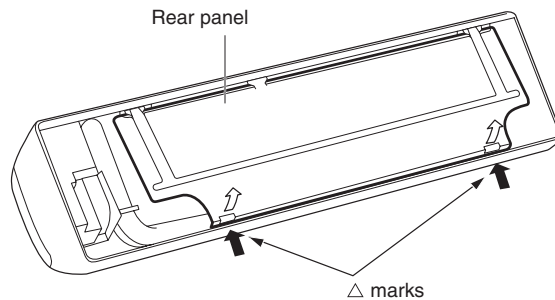


Fig. 1-11-5-2

#### NOTE

In the case of left-rear tubing, use the measurement points 158 mm from the marked position on the rear panel for precise placement of the hose outlet. (Fig. 1-11-5-6)

- (3) Before making the hole, check carefully that no studs or pipes are directly run behind the spot to be cut.

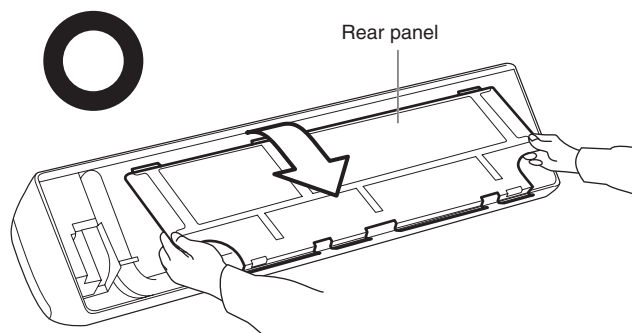


Fig. 1-11-5-3



#### CAUTION

Also avoid areas where electrical wiring or conduits are located.

The above precautions are also applicable if tubing goes through the wall in any other location.

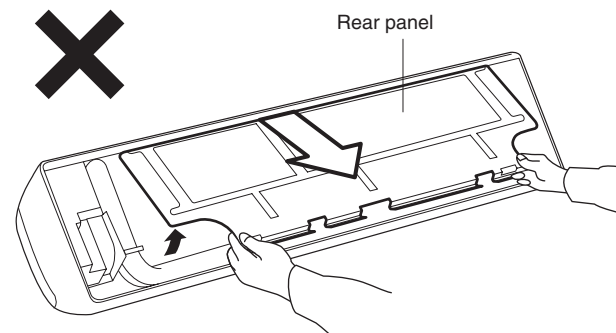


Fig. 1-11-5-4

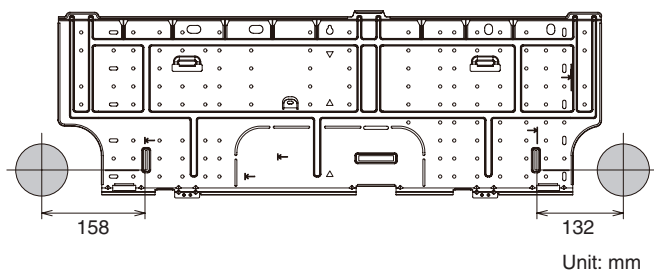


Fig. 1-11-5-6

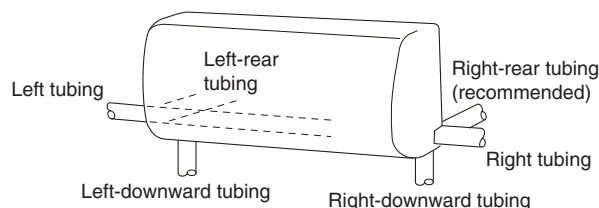


Fig. 1-11-5-5

- (4) Using a sabre saw, keyhole saw or hole-cutting drill attachment, cut a hole in the wall. See Table 1-11-5-1 and Fig. 1-11-5-7.

**Table 1-11-5-1**

| Hole Dia. |
|-----------|
| 80 mm     |

- (5) Measure the thickness of the wall from the inside edge to the outside edge and cut PVC pipe at a slight angle 6 mm shorter than the thickness of the wall. (Fig. 1-11-5-8)
- (6) Place the plastic cover over the end of the pipe (for indoor side only) and insert the pipe in the wall. (Fig. 1-11-5-9)

### Install the Rear Panel on the Wall

Be sure to confirm that the wall is strong enough to suspend the unit.

There are a number of screw holes on the rear panel.

Using the 8 screw holes with ↔ mark is recommended to attach the rear panel securely to the wall.

#### NOTE

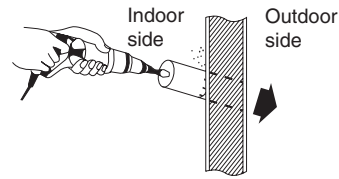
Be sure to install the unit within the range of the wall.

#### If Wooden Wall

- (1) Attach the rear panel to the wall with the 8 screws provided. (Fig. 1-11-5-10)
- If you are not able to line up the holes in the rear panel with the beam locations marked on the wall, use rawl plugs or toggle bolts to go through the holes on the panel or drill 5 mm dia. holes in the panel over the stud locations and then mount the rear panel.
- (2) Double check with a carpenter's level or tape measure that the panel is level. This is important to install the unit properly. (Fig. 1-11-5-11)
- (3) Make sure the panel is flush against the wall. Any space between the wall and unit will cause noise and vibration.

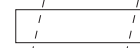
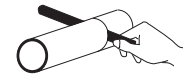
#### NOTE

Hole should be made at a slight downward slant to the outdoor side.



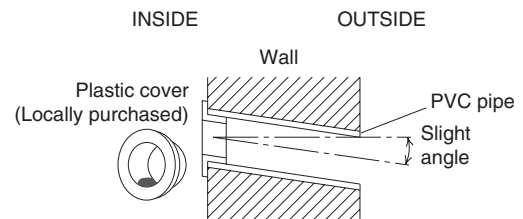
**Fig. 1-11-5-7**

PVC pipe (Locally purchased)

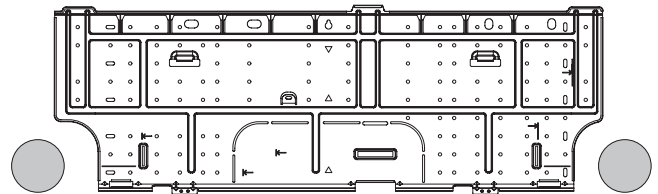


Cut at slight angle

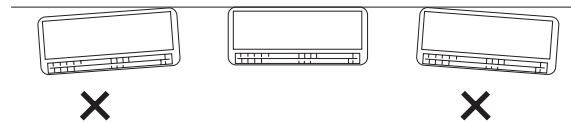
**Fig. 1-11-5-8**



**Fig. 1-11-5-9**



**Fig. 1-11-5-10**



**Fig. 1-11-5-11**

## Removing and Installing the Grille

Basically, these models can be installed and wired without removing the grille. If access to any internal part is needed, follow the steps as given below.

### How to remove the grille

- (1) Open the front panel until it is nearly horizontal, grasp the sections near the front panel arms on both sides, and then remove the panel by pushing the arms towards the outside while pulling the panel towards you.  
If the front panel is difficult to remove, grasp both ends of it and lift it up slightly. Move it to the left and disengage the left arm, then move it to the right and disengage the right arm. (Fig. 1-11-5-12)
- (2) Lift the anti-mold filter up slightly to disengage it from the protrusions on the unit, and then pull downward to remove the filter from the unit. (Fig. 1-11-5-12)
- (3) Remove the 3 screws from the front of the unit and remove the screw covers on the bottom surface. Then remove the 2 screws. (Fig. 1-11-5-13)
- (4) Remove the screw on the right side cover plate and remove the cover. (Fig. 1-11-5-13)
- (5) Remove the lower flap by disengaging 4 pins of the lower flap in order. (Figs. 1-11-5-14 and 1-11-5-15)  
(The flap is so flexible that it can be easily removed.)
- (6) Lift up the grille in the direction shown by the arrow and pull the grille towards you to remove it. (Fig. 1-11-5-16)

### How to replace the grille

- (1) While aligning the top edge of the grille with the frame, move the grille horizontally and insert the top and bottom into the frame.
- (2) Press the grille firmly with your hand to ensure no gap exists between the frame and grille.
- (3) Tighten the 6 screws. And fix the removed covers in place.
- (4) Grasp the sections near the front panel arms on both sides, and hold the front panel so that it is nearly horizontal. Push the arm shafts towards the outside so that they come into contact with the top of the indentations on the right and left sides of the air conditioner. Then push firmly until the arm shafts click into place. (Fig. 1-11-5-17)
- (5) Remount the lower flap.  
(In remounting the flap, it cannot be turned end for end because the right and left pins of the flap differ in form. (Fig. 1-11-5-15))
- (6) Insert the top of the anti-mold filter, and then secure the bottom of the filter with the protrusions on the unit.
- (7) When closing the front panel, push the central part of the front panel first and then press the bottom right and left corners in place until you feel a click. (Fig. 1-11-5-18)

**NOTE**

Check that no gap exists between the frame and the grille.

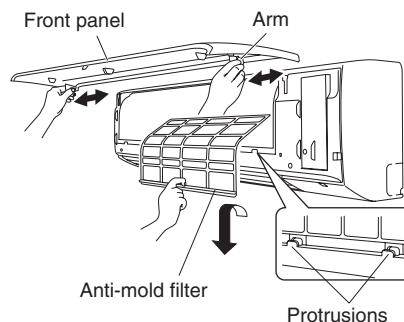


Fig. 1-11-5-12

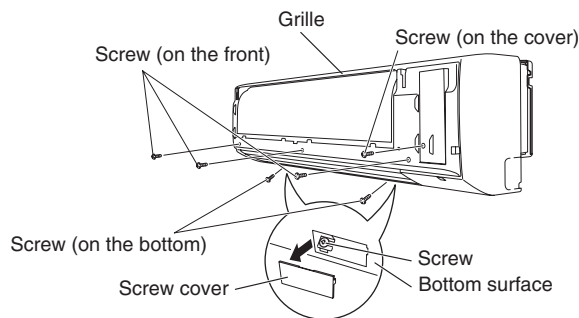


Fig. 1-11-5-13

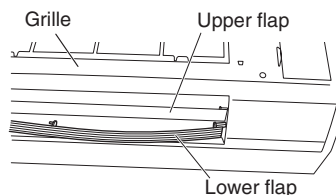


Fig. 1-11-5-14

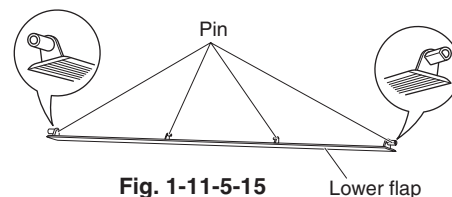


Fig. 1-11-5-15

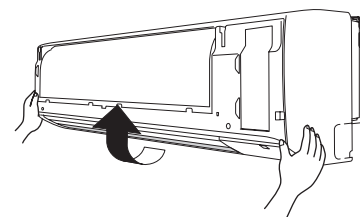


Fig. 1-11-5-16

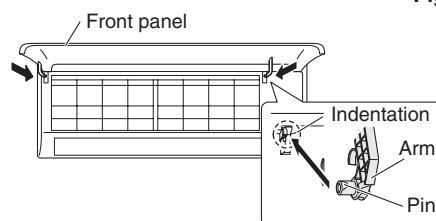


Fig. 1-11-5-17

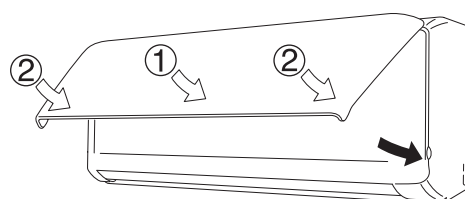


Fig. 1-11-5-18

## Shape the Indoor Side Tubing

- (1) Arrangement of tubing by direction
  - a) Right or left tubing
 

Cut out the corner of the right/left frame with a hacksaw or the like. (Figs. 1-11-5-19 and 1-11-5-20)
  - b) Right-rear or left-rear tubing
 

In this case, the corner of the frame need not be cut.
- (2) To mount the indoor unit on the rear panel:
 

Hang the 3 mounting slots of the unit on the upper tabs of the rear panel. (Fig. 1-11-5-21)

## Wiring Instructions

### General precautions on wiring

- (1) Before wiring, confirm the rated voltage of the unit as shown on its nameplate, then carry out the wiring closely following the wiring diagram.
- (2) Provide a power outlet to be used exclusively for each unit, with a power supply disconnect and circuit breaker for overcurrent protection provided in the exclusive line.
- (3) To prevent possible hazards due to insulation failure, the unit must be grounded.
- (4) Each wiring connection must be done tightly and in accordance with the wiring system diagram. Wrong wiring may cause the unit to misoperate or become damaged.
- (5) Do not allow wiring to touch the refrigerant tubing, compressor, or any moving parts of the fan.
- (6) Unauthorized changes in the internal wiring can be very dangerous. The manufacturer will accept no responsibility for any damage or misoperation that occurs as a result of such unauthorized changes.

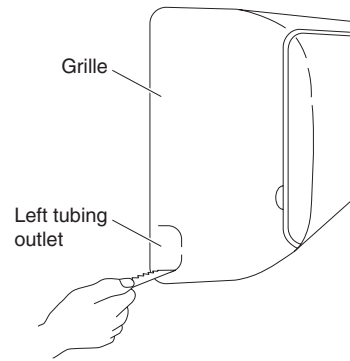


Fig. 1-11-5-19

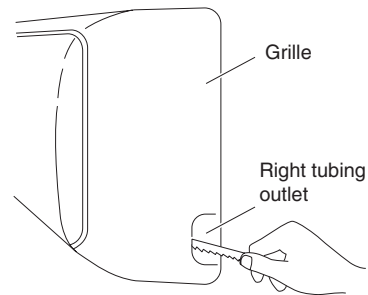


Fig. 1-11-5-20

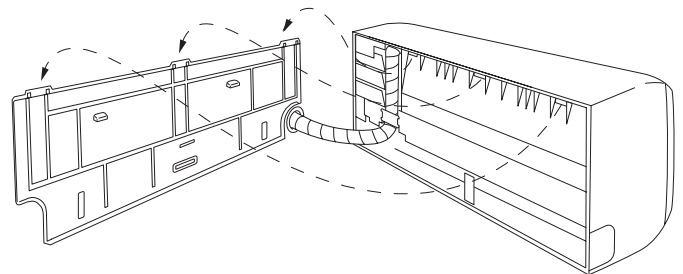


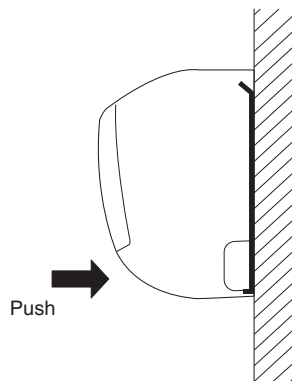
Fig. 1-11-5-21

**Mounting**

- (1) To install the indoor unit, mount the indoor unit onto the 3 tabs on the upper part of the rear plate.
- (2) Hold down the air discharge outlet and press the lower part of the indoor unit until it clicks to securely fasten to the 2 tabs on the lower part of the rear plate. (Fig. 1-11-5-22)

**NOTE**

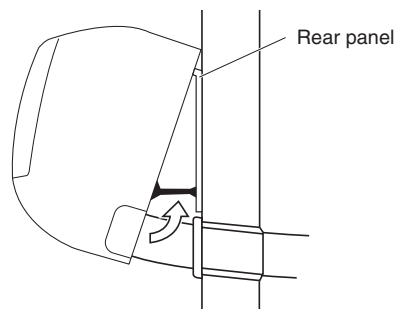
For tubing, choose either the right or left tubing direction and follow the steps below. Also, extend the support on the back of the indoor unit as a stand to make your work easier. (Fig. 1-11-5-23)



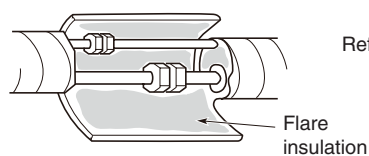
**Fig. 1-11-5-22**

**Right-side tubing**

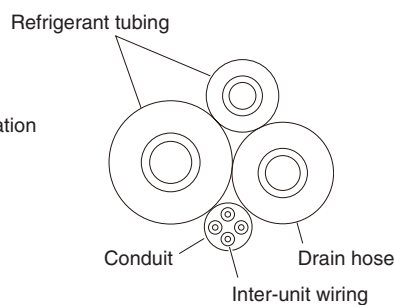
- (1) Shape the refrigerant tubing so that it can easily go into the wall hole. (Fig. 1-11-5-24)
- (2) Push the wiring, refrigerant tubing, and drain hose through the hole in the wall. Adjust the indoor unit so it is securely seated on the rear panel. (Fig. 1-11-5-25)
- (3) Carefully bend the tubing (if necessary) to run along the wall in the direction of the outdoor unit and then tape as far as the fittings. The drain hose should come straight down the wall to a point where water runoff won't stain the wall.
- (4) Connect the refrigerant tubing to the outdoor unit. (After performing a leak test on the connecting part, insulate with the tubing insulation. (Fig. 1-11-5-26)).
- (5) Assemble the refrigerant tubing, drain hose, and conduit (including inter-unit wiring) as shown in Fig. 1-11-5-27.



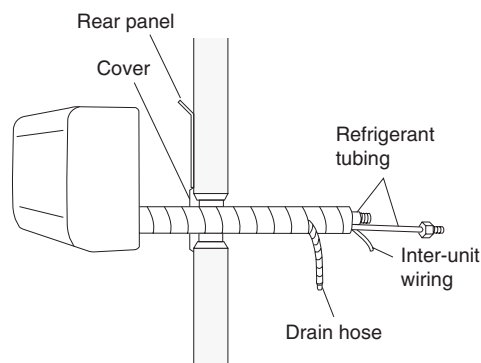
**Fig. 1-11-5-23**



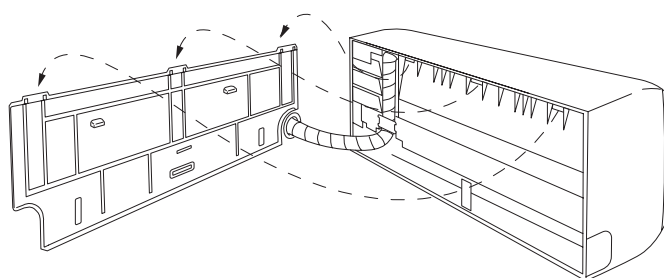
**Fig. 1-11-5-26**



**Fig. 1-11-5-27**



**Fig. 1-11-5-24**



**Fig. 1-11-5-25**

## ■ Left-side tubing

- (1) Lead the tubing and drain hose through the wall, allowing sufficient length for connection. Then bend the tubing using a tube bender to make the attachment. (Fig. 1-11-5-28)
- (2) Switch the drain hose and drain cap.

### Switching drain hose and drain cap

- (a) Locate the drain hose and the drain cap. (Fig. 1-11-5-29)
- (b) Remove the screw fastening the drain hose on the right side, and pull out the drain hose to remove it. (Fig. 1-11-5-29)
- (c) Apply moderate force to pull off the drain cap on the left side. (If you cannot pull it off by hand, use a long-nose pliers.)
- (d) Reattach the drain hose to the left side and the drain cap to the right side. (Fig. 1-11-5-30)

### Drain hose

Slide the drain hose fully onto the drain pan outlet. (It will be easy to slide when water is added.) Check that the screw holes in the drain bracket and the drain pan outlet are aligned and securely in contact, then fasten them with the screw. (After attaching the drain hose, check that it is attached securely.) (Fig. 1-11-5-31)

### Drain cap

Use a Phillips head screwdriver to push the drain cap in firmly. (If it is difficult to push in, wet the cap with water first.)

- (3) Install the indoor unit on the rear panel.
- (4) Connect the tubing and wiring led inside from outdoors.
- (5) After completing a leak test, bundle the tubing together with armoring tape and store it inside the tubing storage area at the back of the indoor unit and hold it with clamps. (Figs. 1-11-5-30 and 1-11-5-32)

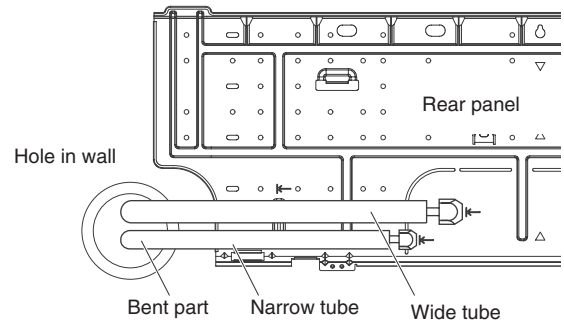


Fig. 1-11-5-28

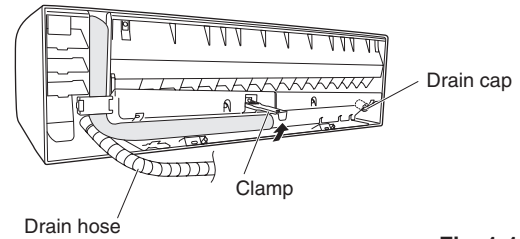


Fig. 1-11-5-29

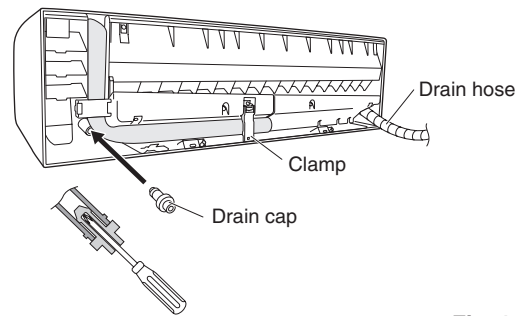


Fig. 1-11-5-30

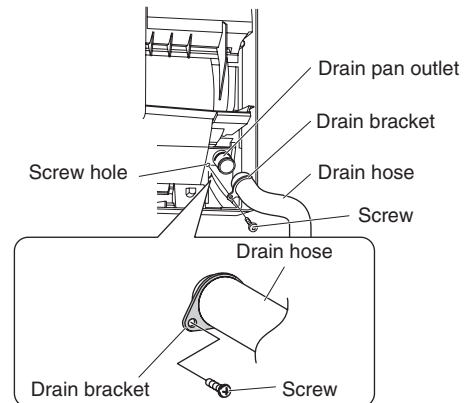


Fig. 1-11-5-31

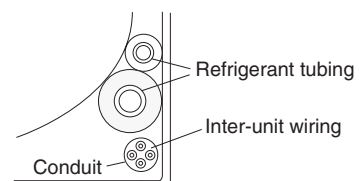
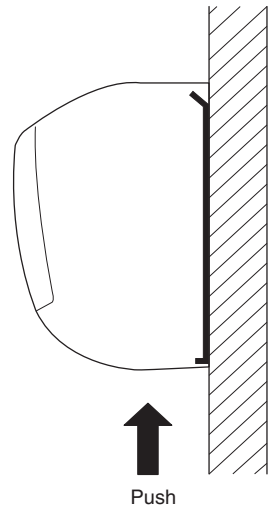


Fig. 1-11-5-32



**To unmount indoor unit**

- (1) Remove the screw cover on the bottom surface.  
(Fig. 1-11-5-34)
- (2) Fasten the frame to the rear panel using the 2 supplied tapping screws 4 × 10 mm. (Fig. 1-11-5-34)
- (3) Press the 2 △ marks on the lower part of the indoor unit and unlatch the tabs. Then lift the indoor unit and unmount.  
(Fig. 1-11-5-33)



**Fig. 1-11-5-33**

**NOTE**

Under normal conditions, the installation design calls for a less than 2 mm gap between the air conditioner unit and the wall. Confirm that the gap is appropriate (less than 2 mm).

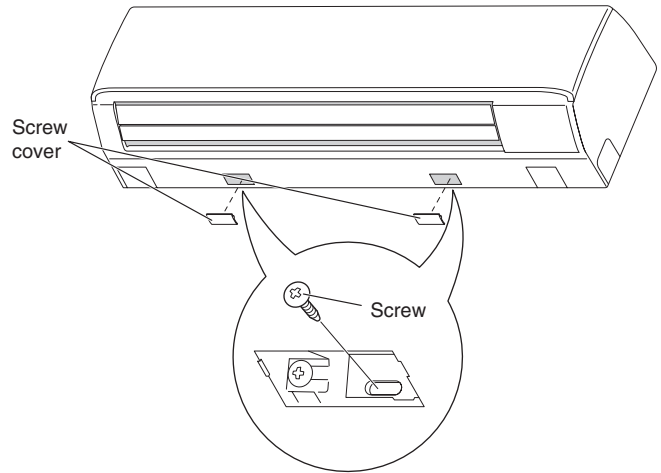
**Drain Hose**

- a) The drain hose should be slanted downward to the outdoors. (Fig. 1-11-5-35)
  - b) Never form a trap in the course of the hose.
  - c) If the drain hose will run in the room, insulate the hose with insulation\* so that chilled condensation will not damage furniture or floors. (Fig. 1-11-5-36)
- \*Foamed polyethylene or its equivalent is recommended.

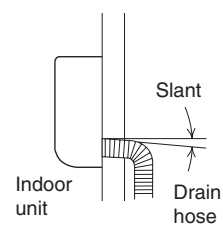
**WARNING**

**Do not supply power to the unit or operate it until all tubing and wiring to the outside unit are completed.**

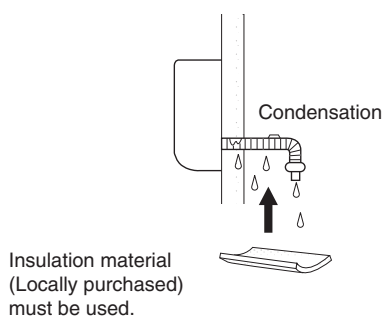
**Risk of Electric Shock**



**Fig. 1-11-5-34**






**Fig. 1-11-5-35**



**Fig. 1-11-5-36**

## (Wall Mounted)

| Part Name        | Figure  | Q'ty |
|------------------|---|------|
| Tapping screw    | Truss-head<br>Phillips <br>4 x 20 mm | 8    |
| Tapping screw    | Truss-head<br>Phillips <br>4 x 10 mm | 2    |
| Flare insulation |                                      | 1    |

## 6. Low Silhouette Ducted Type (F1)

### ■ SELECTING THE INSTALLATION SITE

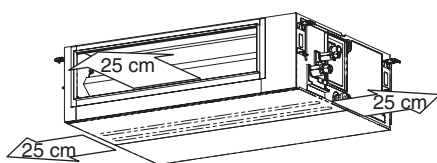
#### Indoor Unit

##### AVOID:

- areas where leakage of flammable gas may be expected.
- places where large amounts of oil mist exist.
- direct sunlight.
- locations near heat sources which may affect the performance of the unit.
- locations where external air may enter the room directly. This may cause “condensation” on the air discharge ports, causing them to spray or drip water.
- locations where the remote controller will be splashed with water or affected by dampness or humidity.
- installing the remote controller behind curtains or furniture.
- locations where high-frequency emissions are generated.

##### DO:

- select an appropriate position from which every corner of the room can be uniformly cooled.
- select a location where the ceiling is strong enough to support the weight of the unit.
- select a location where tubing and drain pipe have the shortest run to the outdoor unit.
- allow room for operation and maintenance as well as unrestricted air flow around the unit.
- install the unit within the maximum elevation difference above or below the outdoor unit and within a total tubing length (L) from the outdoor unit as detailed in the Installation Instructions provided with the outdoor unit.
- allow room for mounting the remote controller about 1m off the floor, in an area that is not in direct sunlight or in the flow of cool air from the indoor unit.



■ HOW TO INSTALL THE INDOOR UNIT

■ Low Silhouette Ducted Type (Type F1)

6-1. Required Minimum Space for Installation and Service

- This air conditioner is usually installed above the ceiling so that the indoor unit and ducts are not visible. Only the air intake and air outlet ports are visible from the unit bottom.
- The minimum space for installation and service is shown in Fig. 1-11-6-1 and Table 1-11-6-1.

Table 1-11-6-1 Unit: mm

| Type       | 36, 45, 50 | 60, 71 | 100, 125, 140 |
|------------|------------|--------|---------------|
| A (Length) | 867        | 1,067  | 1,467         |

- It is recommended that space be provided (450 × 450 mm) for checking and servicing the electrical system.
- The detailed dimensions of the indoor unit is shown in Fig. 1-11-6-2 and Table 1-11-6-2.

Table 1-11-6-2 Unit: mm

| Type          | A     | B     | C                     | D  | E     | F  |
|---------------|-------|-------|-----------------------|----|-------|----|
| 36, 45, 50    | 867   | 800   | 450 (Pitch 150 × 3)   | 71 | 592   | 12 |
| 60, 71        | 1,067 | 1,000 | 750 (Pitch 150 × 5)   | 21 | 792   | 16 |
| 100, 125, 140 | 1,467 | 1,400 | 1,050 (Pitch 150 × 7) | 71 | 1,192 | 20 |

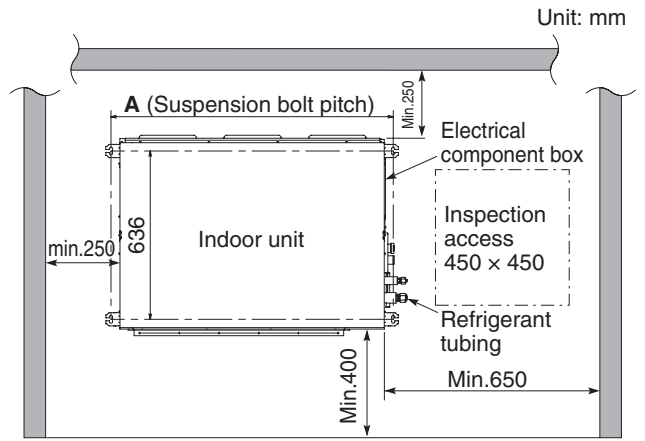
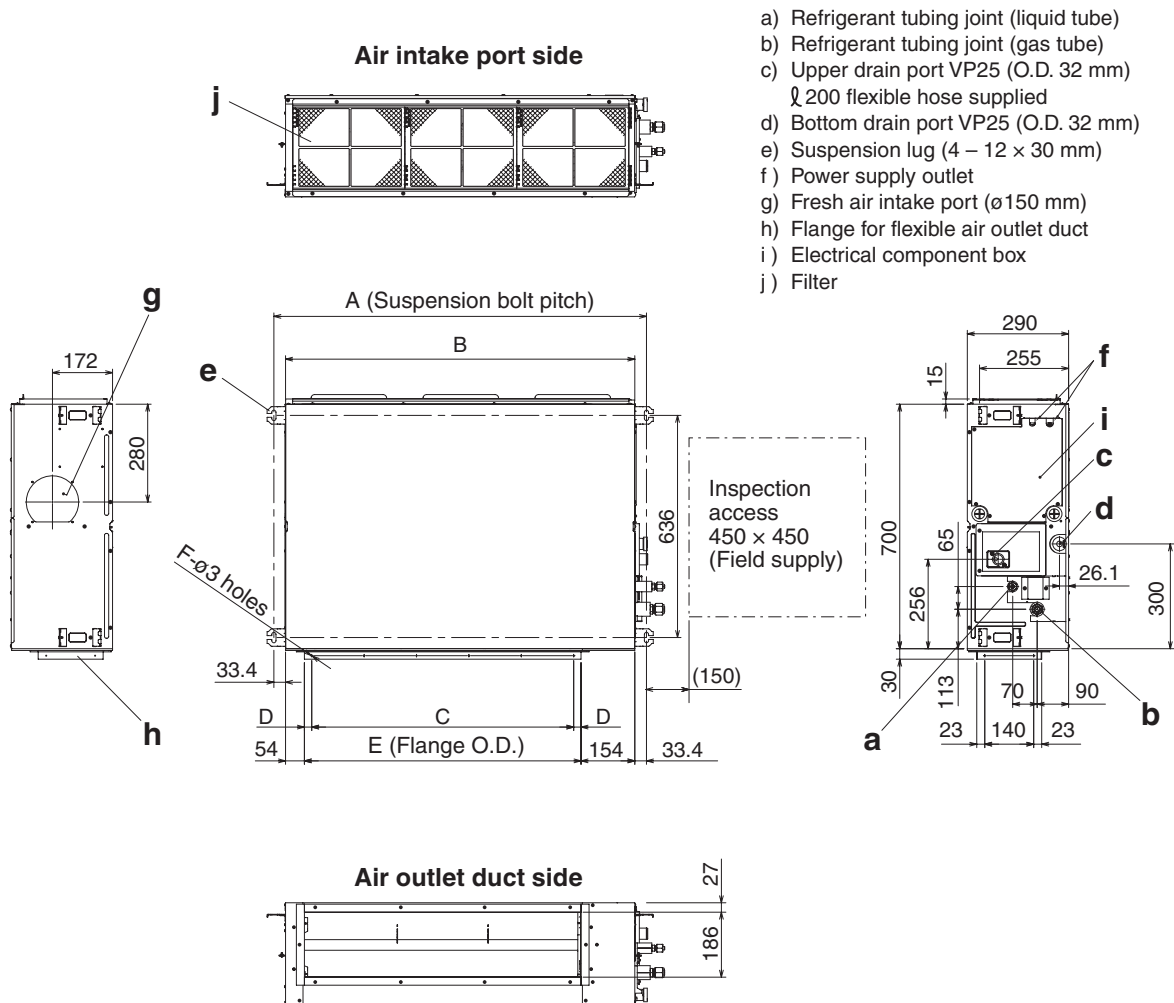


Fig. 1-11-6-1



Unit: mm

Fig. 1-11-6-2

## 6-2. Suspending the Indoor Unit

Depending on the ceiling type:

- Insert suspension bolts (Fig. 1-11-6-3) or
- Use existing ceiling supports or construct a suitable support (Fig. 1-11-6-4).

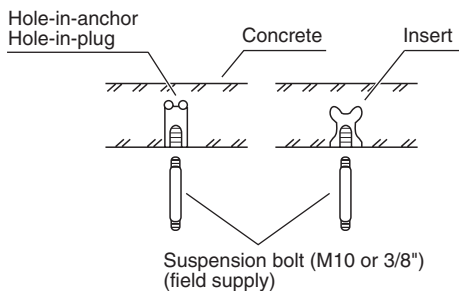


Fig. 1-11-6-3

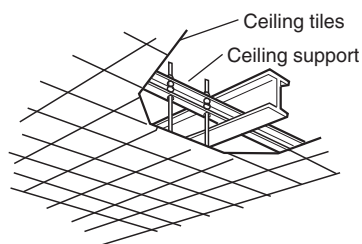


Fig. 1-11-6-4

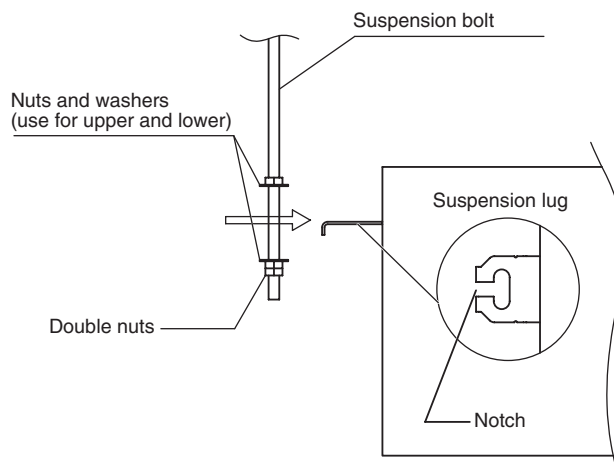


Fig. 1-11-6-5

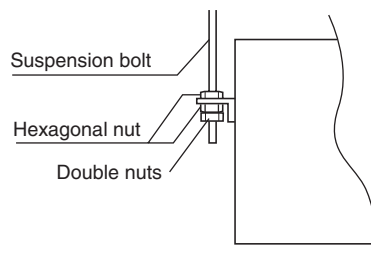


Fig. 1-11-6-6



### WARNING

It is important that you use extreme care in supporting the indoor unit inside the ceiling. Ensure that the ceiling is strong enough to support the weight of the unit. Before suspending the unit, test the strength of each attached suspension bolt.

- (1) When placing the unit inside the ceiling, determine the pitch of the suspension bolts referring to the dimensional data as shown in Fig. 1-11-6-1 and Table 1-11-6-2. Tubing must be laid and connected inside the ceiling when suspending the unit. If the ceiling is already constructed, lay the tubing into position for connection to the unit before placing the unit inside the ceiling.
- (2) Screw in the suspension bolts allowing them to protrude from the ceiling (Fig. 1-11-6-3). (Cut the ceiling material, if necessary.)
- (3) Thread the 3 hexagonal nuts and 2 washers (field supply) onto each of the 4 suspension bolts (Figs. 1-11-6-5 and 1-11-6-6). Use 1 nut and 1 washer for the upper part, and 2 nuts and 1 washer for the lower part, so that the unit will not fall off the suspension lugs.

- This shows an example of installation.

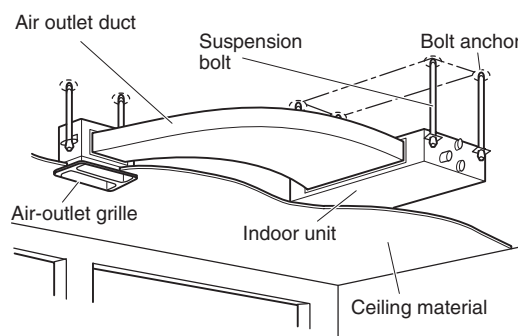


Fig. 1-11-6-7

### 6-3. Installing the Drain Pipe

- Prepare standard hard PVC pipe (O.D. 32 mm) for the drain and use the supplied hose band to prevent water leaks.  
The PVC pipe must be purchased separately.  
The transparent drain part on the unit allows you to check drainage. (Fig. 1-11-6-8)



#### CAUTION

- Do not use adhesive tape at the drain connection port on the indoor unit.
- Insert the drain pipe until it contacts the socket, and then secure it tightly with the hose band.
- Do not use the supplied drain hose bent at a 90° angle. (The maximum permissible bend is 45°.)
- Tighten the hose clamps so their locking nuts face upward. (Fig. 1-11-6-8)

Align the hose band with end of the hose, and tighten so that it does not contact the bead.

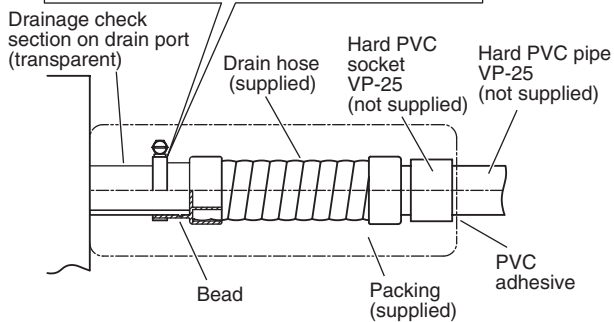


Fig. 1-11-6-8

- After connecting the drain pipe securely, wrap the supplied packing and drain pipe insulator around the pipe, then secure it with the vinyl clamps. (Fig. 1-11-6-9)

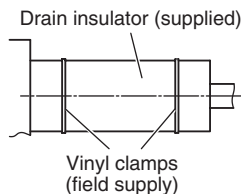


Fig. 1-11-6-9

#### NOTE

Make sure the drain pipe has a downward slant (1/100 or more) and that there are no water traps.



#### CAUTION

- Do not install an air bleeder as this may cause water to spray from the drain pipe outlet. (Fig. 1-11-6-10)

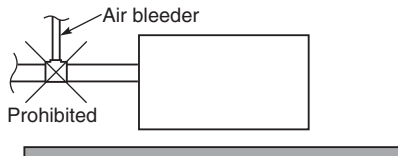


Fig. 1-11-6-10

- If it is necessary to increase the height of the drain pipe, the section directly after the connection port can be raised a maximum of 500 mm. Do not raise it any higher than 500 mm, as this could result in water leaks. (Fig. 1-11-6-11)

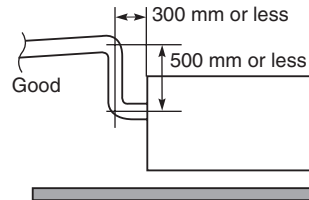


Fig. 1-11-6-11

- Do not install the pipe with an upward slant from the connection port. This will cause the drain water to flow backward and leak when the unit is not operating. (Fig. 1-11-6-12)

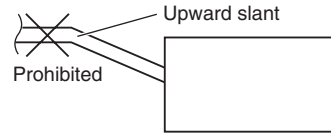


Fig. 1-11-6-12

- Do not apply force to the piping on the unit side when connecting the drain pipe. The pipe should not be allowed to hang unsupported from its connection to the unit. Fasten the pipe to a wall, frame, or other support as close to the unit as possible. (Fig. 1-11-6-13)

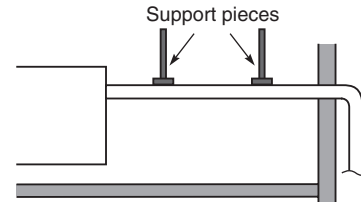


Fig. 1-11-6-13

### Checking the Drainage

After wiring and drain piping are completed, use the following procedure to check that the water will drain smoothly. For this, prepare a bucket and wiping cloth to catch and wipe up spilled water.

- Connect power to the power terminal board (R, S terminals) inside the electrical component box.
- Remove the tube cover and slowly pour about 1,200 cc of water through the opening into the drain pan to check drainage.
- Short-circuit the check pin (CHK) on the indoor control circuit board and operate the drain pump. Check the water flow through the transparent drain port and see if there is any leakage.



#### CAUTION

Be careful since the fan will start when you short the pin on the indoor control board.

- When the drainage check is complete, open the check pin (CHK) and remount the insulator and drain cap onto the drain inspection port.

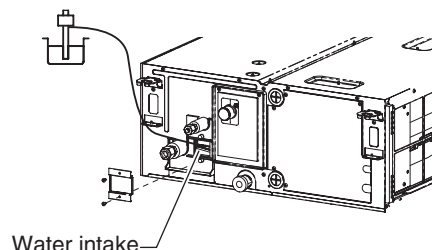


Fig. 1-11-6-14

### 6-4. Connecting Duct to Air Intake Port Side

- (1) First pull out a filter in the direction of the electrical component box in the unit. (Fig. 1-11-6-15)  
The pre-installed filter will not be used any more.
- (2) Then remove the seal packing, bracket and filter attached to the side of the air intake port. (Fig. 1-11-6-15)
- (3) Install the duct (field supply).  
See the figure for the dimension of the installation hole.  
Use M5 self-tapping screws for installation. (Fig. 1-11-6-16)

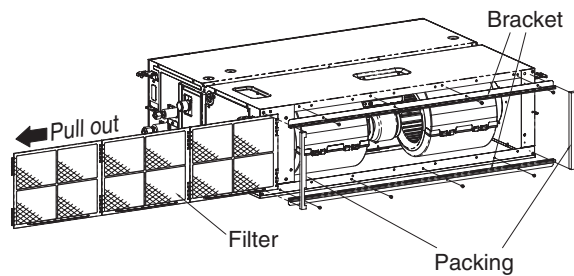
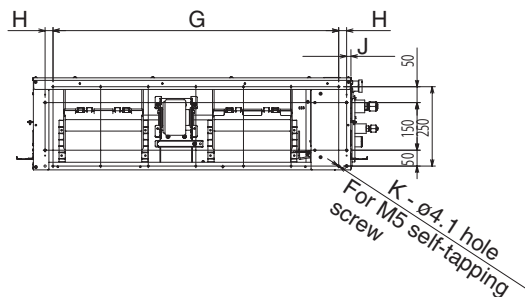


Fig. 1-11-6-15

**NOTE**

- Select an air-intake grille with a filter at a local shop.
- To get clean air and to extend the service life of the air conditioner, an air filter must be installed in the air intake.  
For installation and cleaning the air filter, consult your dealer or service center.



Unit : mm

| Type          | G                        | H  | J   | K  |
|---------------|--------------------------|----|-----|----|
| 36, 45, 50    | 600<br>(Pitch 150 × 4)   | 25 | 113 | 14 |
| 60, 71        | 900<br>(Pitch 150 × 6)   | 25 | 13  | 18 |
| 100, 125, 140 | 1,350<br>(Pitch 150 × 9) | 0  | 13  | 24 |

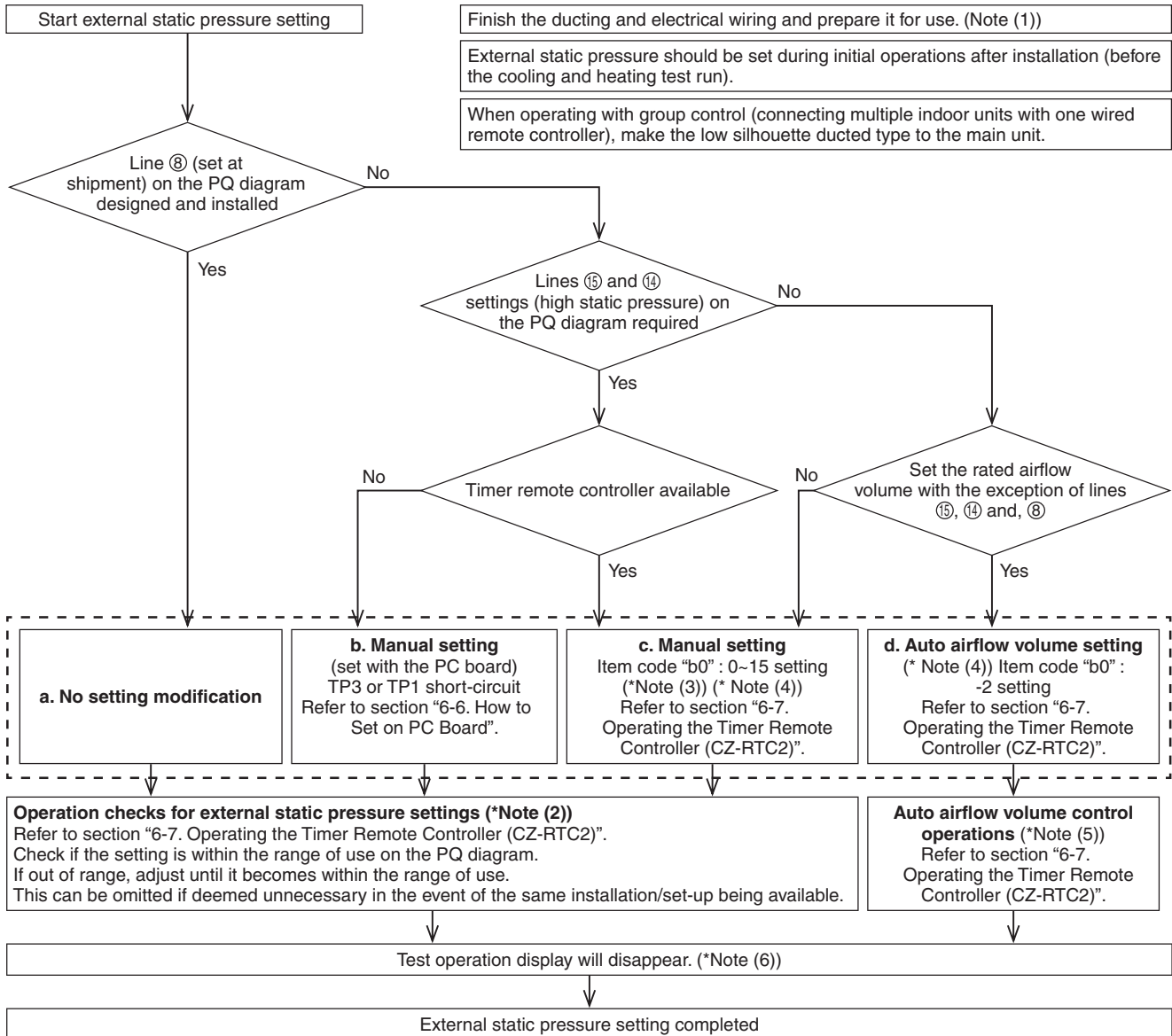
Fig. 1-11-6-16

## 6-5. External Static Pressure Setting

Choose one of the following methods from “a”, “b”, “c” or “d” as shown in the flow chart (within the dotted lines) and then make the setting accordingly.

- a. No setting modification.....: Use-as-is at shipment (there are cases in which the setting may differ from the shipment setting when reset after once setting the external static pressure.)
- b. Manual setting (set with the PC board).....: For high static pressure. Switching method with the short-circuit connector.
- c. Manual setting (set with the wired remote controller) .....: Low static pressure ~ high static pressure
- d. Auto airflow volume setting (set on the wired remote controller) ....: Air outlet volume is automatically adjusted to the rated airflow volume with the auto airflow control drive.

### Flow of External Static Pressure



### NOTE

- (1) Check the following items before performing the setting-check operations or auto airflow volume operations.
- 1) Check to make sure that the electrical wiring and ducting have been completed. Activate the stand-by mode. In particular, make sure that the closed damper located in the middle of the duct is open, if installed. Also, make sure that air filters have been installed inside the air inlet duct.  
Check to make sure air is not leaking from the joints.
  - 2) If multiple air outlets and air inlets are included, adjust the airflow volume ratio of all of them until they meet the design airflow ratio.
  - 3) Make sure the address setting has been completed.
- (2) The operation check will be completed in approximately three minutes if the settings have been made correctly. The settings will be modified if they are out of the range of use (maximum 30 minutes.). If this is not completed within 31 minutes, check whether the air speed is set to “H” or not.



- (3) Refer to Table 1-11-6-4 and Fig. 1-11-6-18 for details on the relationship between the value of item code “b0” and the external static pressure.
- (4) When set in group control (connecting multiple indoor units with one wired remote controller), set each indoor unit to item code “b0”. When amending the setting after selecting [ b. Manual setting] (due to airflow path changes, etc.), it is necessary to cancel [b. Manual setting] (disconnect short-circuit connector). When [b. Manual setting] has not been cancelled, [c. Manual setting] and [d. Auto airflow volume setting] will be activated if selected, but [b Manual setting] takes precedence when the power is switched back on after power outages, etc.
- (5) If this is not completed within 8 minutes, check the drive mode, air speed and air inlet temperature.
- (6) When set in group control (connecting multiple indoor units with one wired remote controller), the test run operations display will disappear once the external static pressure setting check or auto airflow volume control operation check have been completed for the main unit. Decisions on sub-unit complete are not possible. The test run operation display will disappear after one hour even if the external static pressure setting check or auto airflow volume control operation check have not been completed.



**CAUTION**

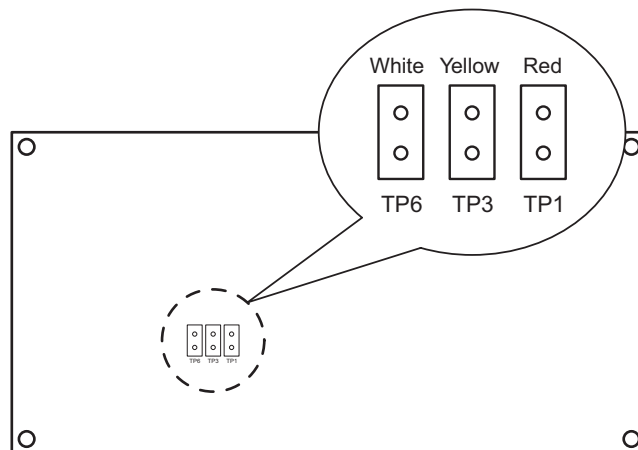
- Be sure to check that the external static pressure is within the range for use and then make the setting. Failure to observe this may result in insufficient airflow or water leakages. Refer to Fig. 1-11-6-18 for the external static pressure setting range.
- There are cases in which automatic variable dampers and other mounted items may trigger the P12 alarm on systems that modify the external static pressure when the auto airflow volume control operations or setting check operations are carried out if high external static pressure is lowered. In this event, lower the dampers, etc., so that the external static pressure reaches its lowest level, and then carry out the auto airflow volume control operations or setting check operations.
- Be sure to set the [External Static Pressure Setting] once again after amending the airflow path for the duct or air outlet after setting the external static pressure.
- Set the air inlet temperature within the range for use. The auto airflow volume control will not function if the air inlet temperature is over 45°C or not in the fan mode.

**6-6. How to Set on PC Board**

1. Turn off the power breaker to halt the supply of electricity to the PC board.
2. Open the lid of electrical component box and check where the short-circuit pin on the indoor unit control PC board is located (Fig. 1-11-6-17)
3. Short circuit the applicable short-circuit pin in accordance with the selected short-circuit pin connected (Fig. 1-11-6-18).  
 150 Pa : TP3 (2P: yellow) short-circuit  
 140 Pa : TP1 (2P: red) short-circuit  
 \* Use the short-circuit connector (2P: yellow) supplied.

**Table 1-11-6-3 Selection of connected short-circuit pins**

| External static pressure at the time of rated airflow volume | Short-circuit pin |
|--|-------------------|
| Unusable   | TP6 (2P: white)   |
| 150 Pa   | TP3 (2P: yellow)  |
| 140 Pa   | TP1 (2P: red)     |



Indoor Unit control PC board

**Fig. 1-11-6-17**

## 6-7. Operating the Timer Remote Controller (CZ-RTC2)

Setting Item Code “**b0**”

- Press and hold down the , and buttons simultaneously for 4 or more seconds.  
( **SETTING**, the Unit No., Item Code and Detailed Data will blink on the remote controller's LCD display.)
- The indoor unit numbers in the group control will be sequentially displayed whenever the Unit Select button is pressed .  
Only the fan motor for the selected indoor unit will operate during this.
- Specify the “**b0**” item code by pressing the / buttons for the temperature setting buttons and confirm the values.  
(“**-001**” set at shipment )
- Press the / buttons for the time to amend the values for the set data.  
Refer to table 1-11-6-2 and Fig.1-11-6-4 and select a value between “**0001**” and “**0015**”.  
Select “**-002**” if the auto airflow volume setting is activated.
- Press the button.  
The display will stop blinking and remain illuminated.
- Press the button. The fan motor will stop operating and the LCD display will return to the normal stop mode.

### Auto Airflow Volume Control Operations and External Static Pressure Setting-Check Operation

- Press and hold down the button for 4 or more seconds. “**TEST**” will be displayed on the remote controller's LCD display.
- Press the button to commence the test run.  
[Test Run] will be displayed on the remote controller's LCD display.
- Select the fan mode and set it to “H” by pressing the button.



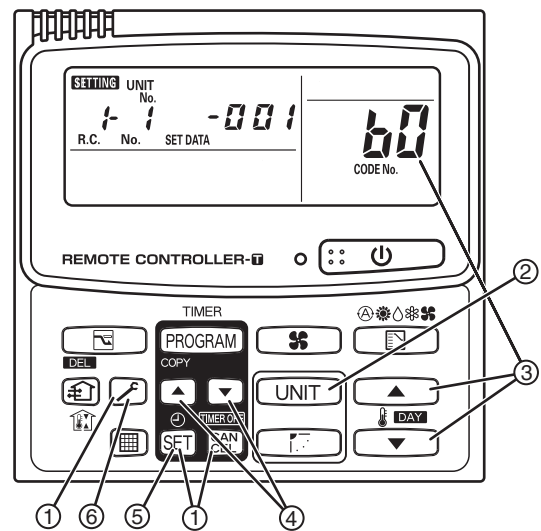
### CAUTION

Auto airflow volume control operations and external static pressure setting-check operations will not be performed unless [H] has been selected for the fan mode.

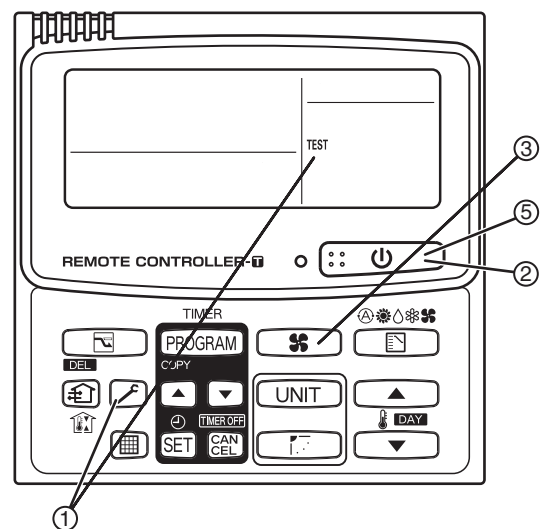
- The fan motor will be activated and auto airflow volume control operations or external static pressure setting-check operations will commence.  
The power of the airflow will change while these operations are in progress.  
The external static pressure setting-check operations and auto airflow volume control operations will be completed in about 3 to 30 minutes.  
The “**TEST**” display will be extinguished from the remote controller's LCD display.
- Press the button to halt the test run.

Table 1-11-6-4 Setting the external static pressure

| Indoor unit  |               | Item code   |
|--|---------------|-------------|
| 36, 45, 50, 60, 71   | 100, 125, 140 | b0          |
| External static pressure of the rated air flow volume (Pa) |               |             |
| 150  | 150           | <b>0015</b> |
| 140  | 140           | <b>0014</b> |
| 130  | 130           | <b>0013</b> |
| 120  | 120           | <b>0012</b> |
| 100  | 110           | <b>0011</b> |
| 70   | 100           | <b>0008</b> |
| 60   | 70            | <b>0006</b> |
| 50   | 50            | <b>0005</b> |
| 30   | 30            | <b>0003</b> |
| 10   | 10            | <b>0001</b> |
| No auto airflow volume setting                             |               | <b>-001</b> |
| Auto airflow volume setting                                |               | <b>-002</b> |



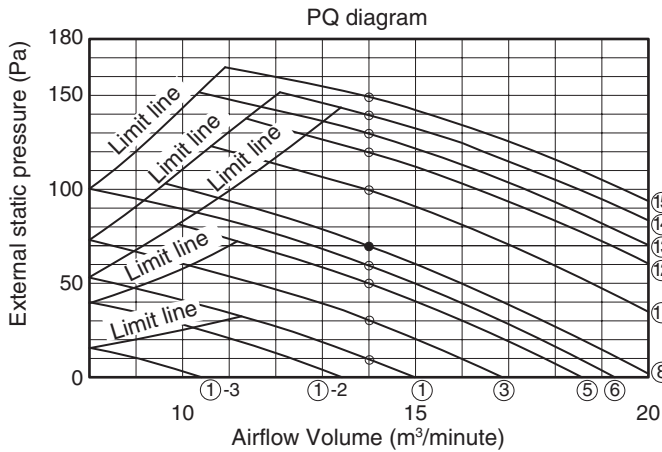
\* Failure to set this parameter may result in decreased airflow and condensation.



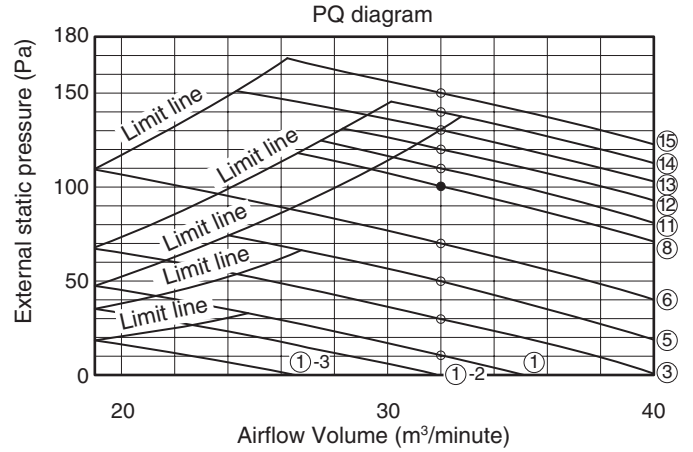
Indoor Fan Performance

|     |   | Item code "b0" |         |         |         |         |         |         |         |         |         |         |         |   |   |   |
|-----|---|----------------|---------|---------|---------|---------|---------|---------|---------|---------|---------|---------|---------|---|---|---|
|     |   | 0015           | 0014    | 0013    | 0012    | 0011    | 0008    | 0006    | 0005    | 0003    | 0001    |         |         |   |   |   |
|     |   | Cooling        | Heating | Cooling | Heating | Cooling | Heating | Cooling | Heating | Cooling | Heating | Cooling | Heating |   |   |   |
| Tap | ⑮ | H              | H       |         |         |         |         |         |         |         |         |         |         |   |   |   |
|     | ⑭ |                |         | H       | H       |         |         |         |         |         |         |         |         |   |   |   |
|     | ⑬ | M              | M       |         | H       | H       |         |         |         |         |         |         |         |   |   |   |
|     | ⑫ |                |         |         |         | H       | H       |         |         |         |         |         |         |   |   |   |
|     | ⑪ |                |         | M       |         |         | H       | H       |         |         |         |         |         |   |   |   |
|     | ⑩ |                |         |         |         |         |         |         |         |         |         |         |         |   |   |   |
|     | ⑨ |                | M       |         | M       | M       | M       |         | H       | H       |         |         |         |   |   |   |
|     | ⑧ | L              | L       |         | M       |         | M       | M       |         | H       | H       |         |         |   |   |   |
|     | ⑤ |                |         |         |         |         |         | M       | M       |         | H       | H       |         |   |   |   |
|     | ③ |                |         | L       | L       | L       | L       | L       | L       | M       | M       | M       | H       | H |   |   |
| ①   |   | L              | L       |         |         |         | L       | L       | L       | L       |         | M       | M       | H | H |   |
| ①-2 |   |                |         |         |         |         |         |         |         |         | L       | L       | L       | L | M | M |
| ①-3 |   |                |         |         |         |         |         |         |         |         |         |         |         |   | L | L |

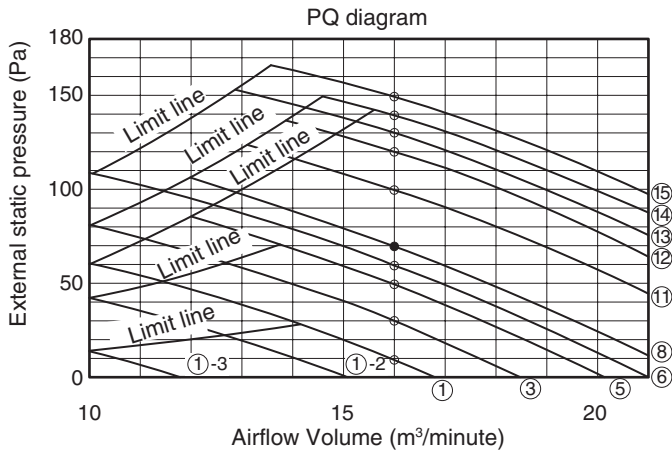
Type 36, 45



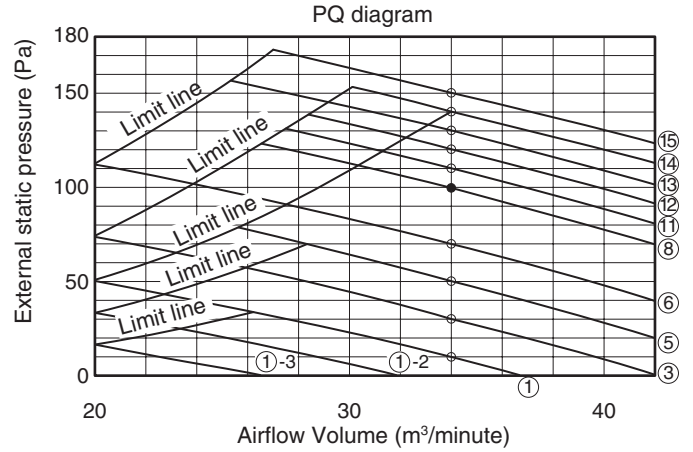
Type 100



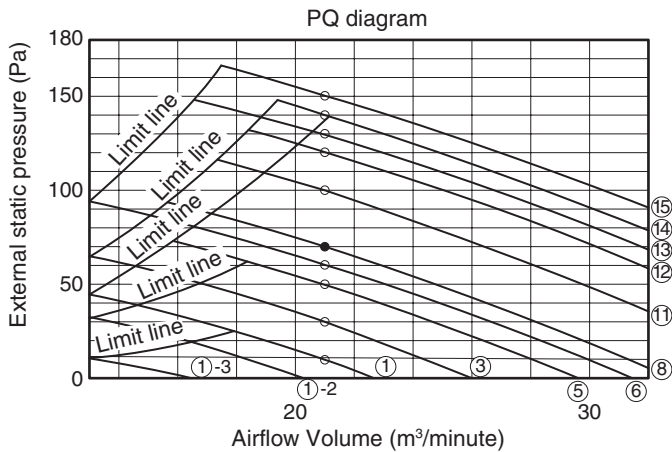
Type 50



Type 125



Type 60, 71



Type 140

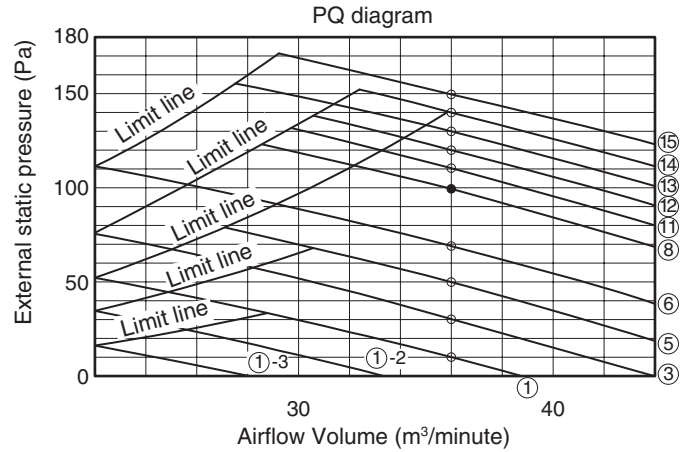







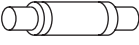





Fig. 1-11-6-18

**(Low Silhouette Ducted)**

| Part Name                 | Figure  | Q'ty | Remarks  |
|---------------------------|---|------|--|
| Washer                    |  | 8    | For suspending indoor unit from ceiling  |
| Flare insulator           |  | 2    | For gas and liquid tubes   |
| Insulating tape           |  | 2    | For gas and liquid tubes flare nuts  |
| Drain insulator           |  | 1    | For drain hose joint   |
| Hose band                 |  | 1    | For securing drain hose  |
| Packing                   |  | 1    | For drain hose joint (hard material)   |
| Packing                   |  | 1    | For drain hose joint (soft material)   |
| Drain hose                |  | 1    |  |
| Operating Instructions    |  | 1    | A5-size  |
| Installation Instructions |  | 1    | Included this instructions   |
| Short-circuit connection  |  | 1    | For high static pressure (Located on the back of the electrical component box lid. ) |

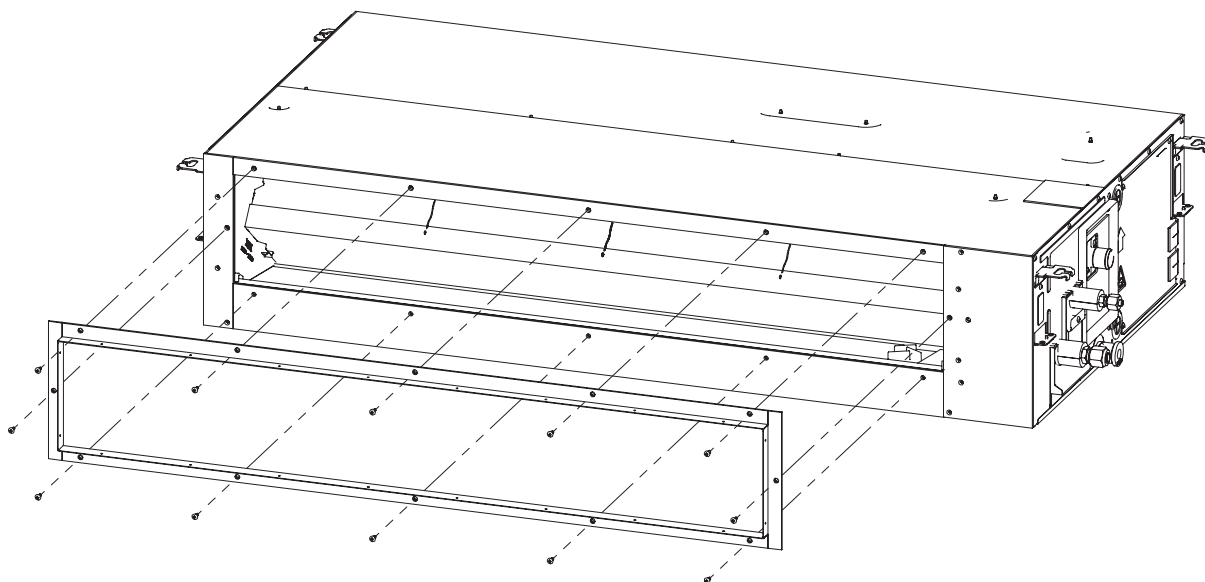
- Use M10 for suspension bolts.
- Suspension bolts and nuts are field supply.

## ■ Optional Duct Frange

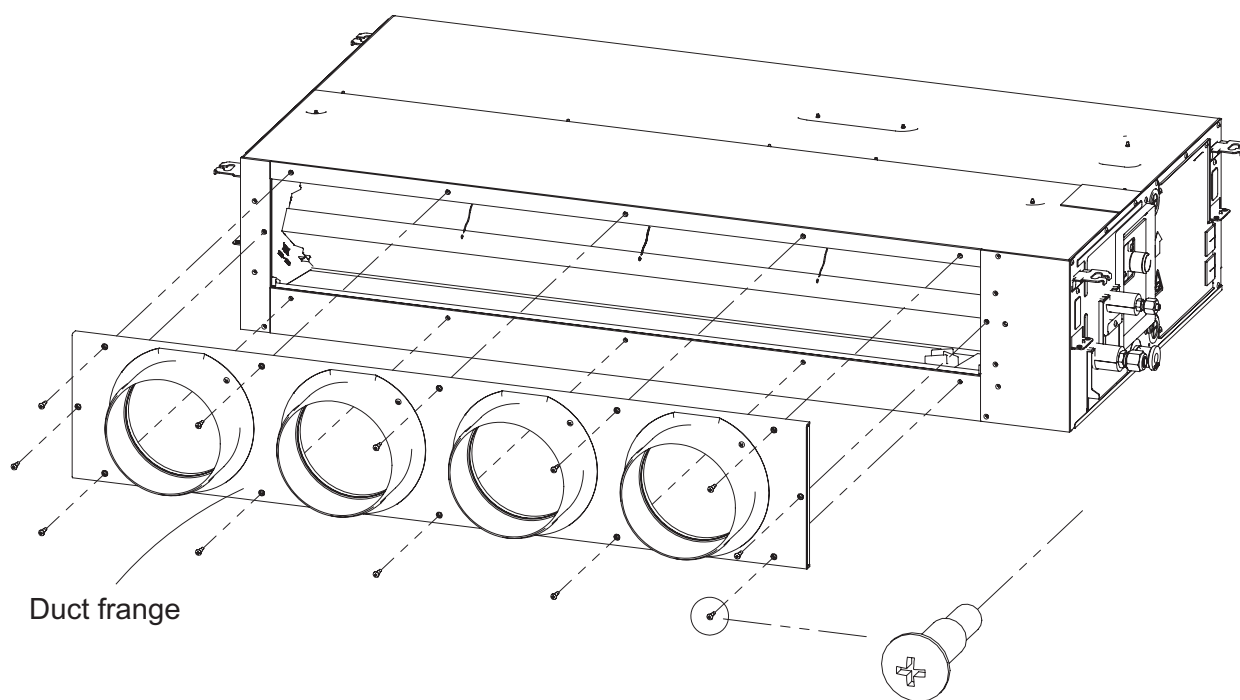
### How to Install Duct Frange

- 4 circle duct frange (CZ-160DAF2)
- 3 circle duct frange (CZ-90DAF2)
- 2 circle duct frange (CZ-56DAF2)

1. Remove the air outlet duct frange.

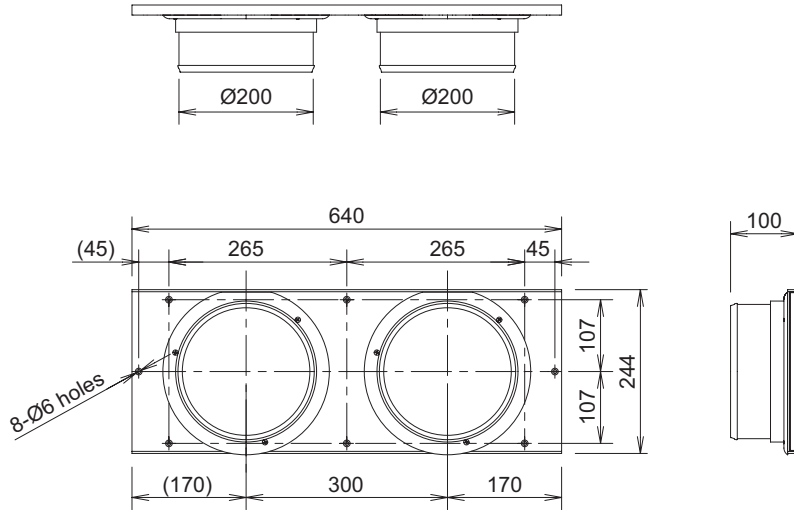


2. Attach the duct frange to the side of the unit with the supplied screws.



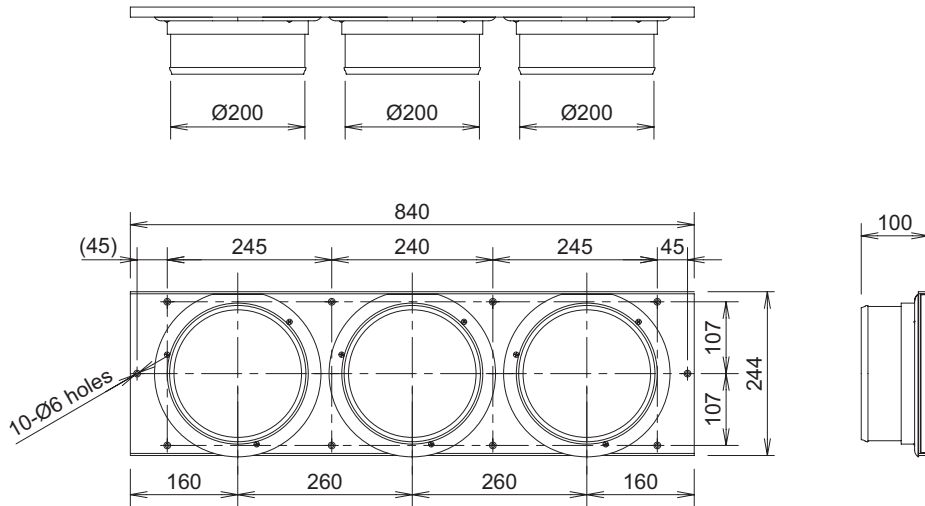
**Dimensional Diagram : CZ-56DAF2**

unit: mm



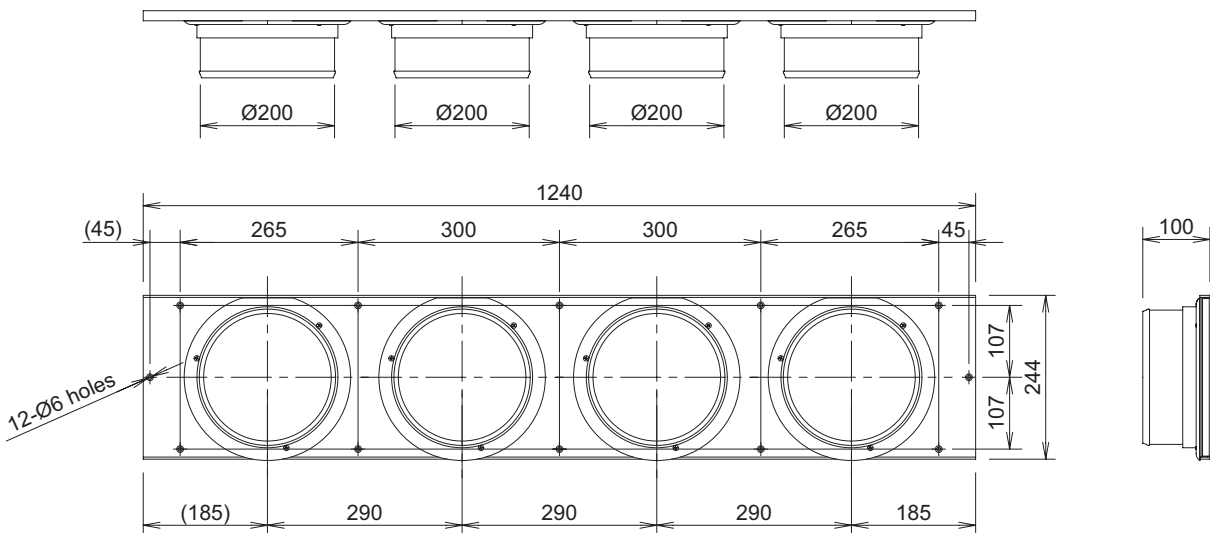
**Dimensional Diagram : CZ-90DAF2**

unit: mm



**Dimensional Diagram : CZ-160DAF2**

unit: mm



## 7. Ducted Type (N1)

### ■ SELECTING THE INSTALLATION SITE

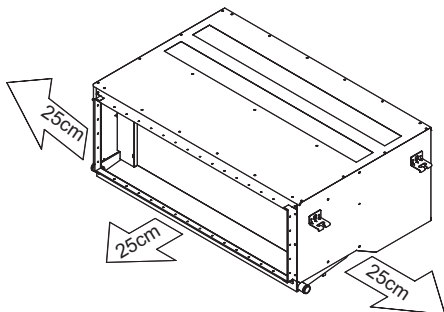
#### Indoor Unit

##### AVOID:

- areas where leakage of flammable gas may be expected.
- places where large amounts of oil mist exist.
- direct sunlight.
- locations near heat sources which may affect the performance of the unit.
- locations where external air may enter the room directly. This may cause “condensation” on the air discharge ports, causing them to spray or drip water.
- locations where the remote controller will be splashed with water or affected by dampness or humidity.
- installing the remote controller behind curtains or furniture.
- locations where high-frequency emissions are generated.

##### DO:

- select an appropriate position from which every corner of the room can be uniformly cooled.
- select a location where the ceiling is strong enough to support the weight of the unit.
- select a location where tubing and drain pipe have the shortest run to the outdoor unit.
- allow room for operation and maintenance as well as unrestricted air flow around the unit.
- install the unit within the maximum elevation difference above or below the outdoor unit and within a total tubing length (L) from the outdoor unit as detailed in the Installation Instructions provided with the outdoor unit.
- allow room for mounting the remote controller about 1 m off the floor, in an area that is not in direct sunlight or in the flow of cool air from the indoor unit.



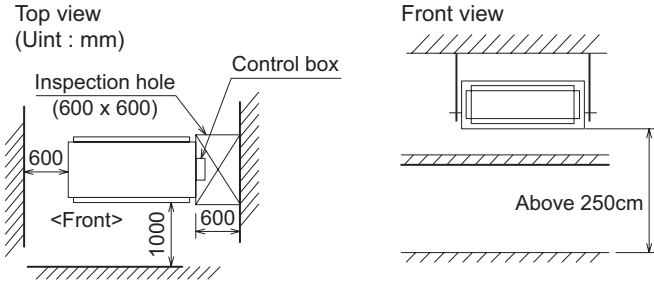
■ SELECTING THE LOCATION FOR THE INDOOR UNIT

7-1. Required Minimum Space for Installation and Service

Provide a check port on the piping side ceiling for repair and maintenance.

Install the indoor unit once the following conditions are satisfied and after receiving the customer approval.

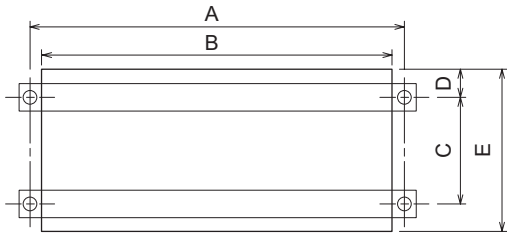
1. The indoor unit must be within a maintenance space.
2. The indoor unit must be free from any obstacles in path of the air inlet and outlet, and must allow spreading of air throughout the room.



If the height from the floor to ceiling exceeds three meters, air flow distribution deteriorates and the effect is decreased.

Fig. 1-11-7-1

POSITION OF SUSPENSION BOLT



- Apply a joint-canvas between the unit and duct to absorb unnecessary vibration.
- Install the unit leaning to a drainage hole side as a figure for easy water drainage.

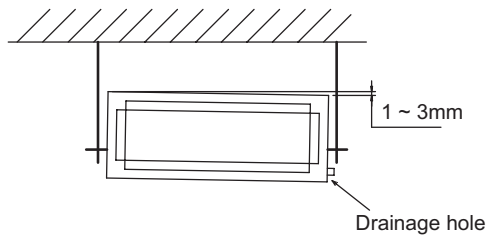


Table 1-11-7-1

Unit: mm

| TYPE        | A    | B    | C   | D  | E   |
|-------------|------|------|-----|----|-----|
| S-36PN1E5A  | 840  | 780  | 523 | 64 | 650 |
| S-45PN1E5A  |      |      |     |    |     |
| S-50PN1E5A  |      |      |     |    |     |
| S-60PN1E5A  | 1060 | 1000 | 523 | 64 | 650 |
| S-71PN1E5A  |      |      |     |    |     |
| S-100PN1E5A | 1260 | 1200 | 523 | 64 | 650 |
| S-125PN1E5A |      |      |     |    |     |
| S-140PN1E5A |      |      |     |    |     |

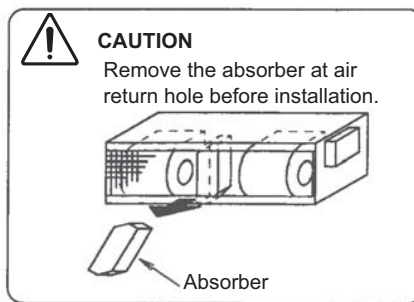
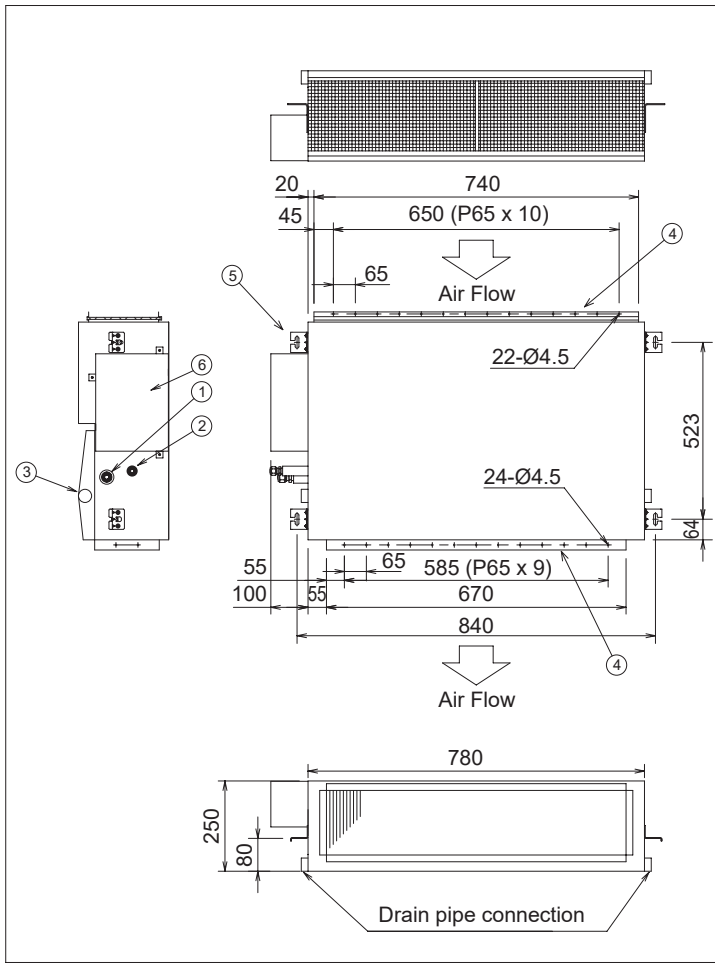
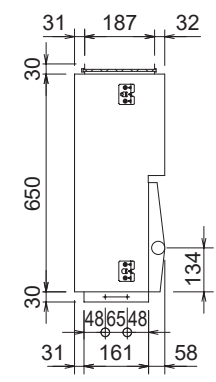


Fig. 1-11-7-2



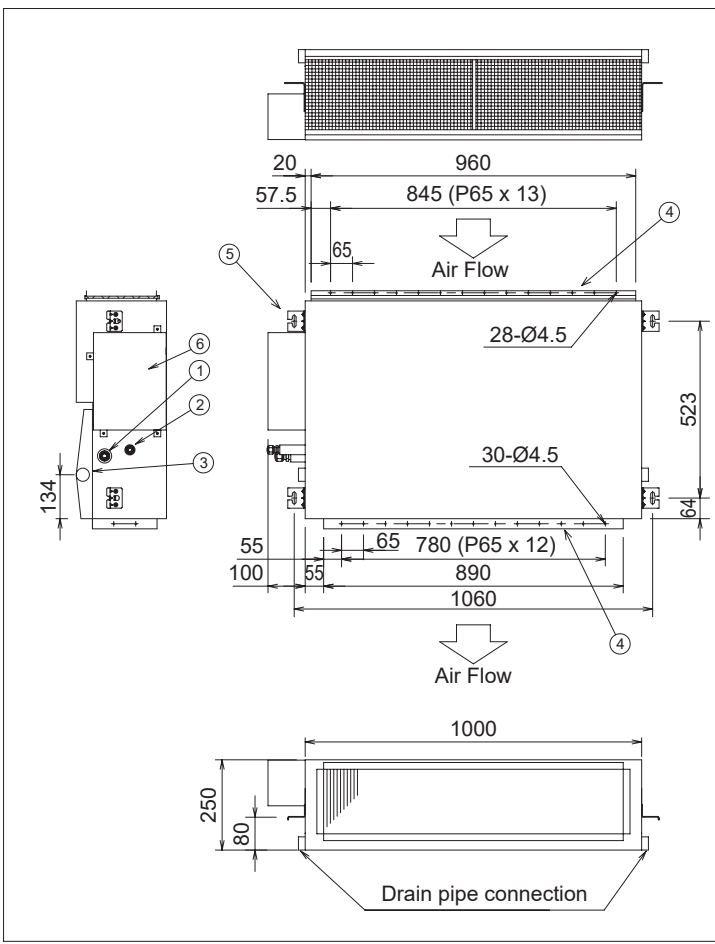


| No. | NAME                     | Q'TY | NOTE              |
|-----|--------------------------|------|-------------------|
| 1   | Pipe connection (gas)    | 1    | O.D. Ø12.7 Flared |
| 2   | Pipe connection (liquid) | 1    | O.D. Ø6.35 Flared |
| 3   | Drain pipe connection    | 2    | Female screw PT1" |
| 4   | Duct connection          | 2    |                   |
| 5   | Hanger                   | 4    |                   |
| 6   | Control box              | 1    |                   |

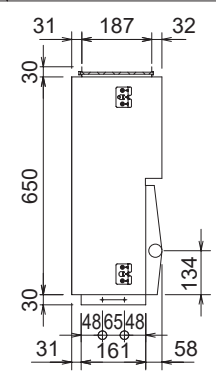


UNIT:mm

| Outside Dimensions | MODEL NO. | S-36PN1E5A<br>S-45PN1E5A<br>S-50PN1E5A |
|--------------------|-----------|--|
|--------------------|-----------|--|

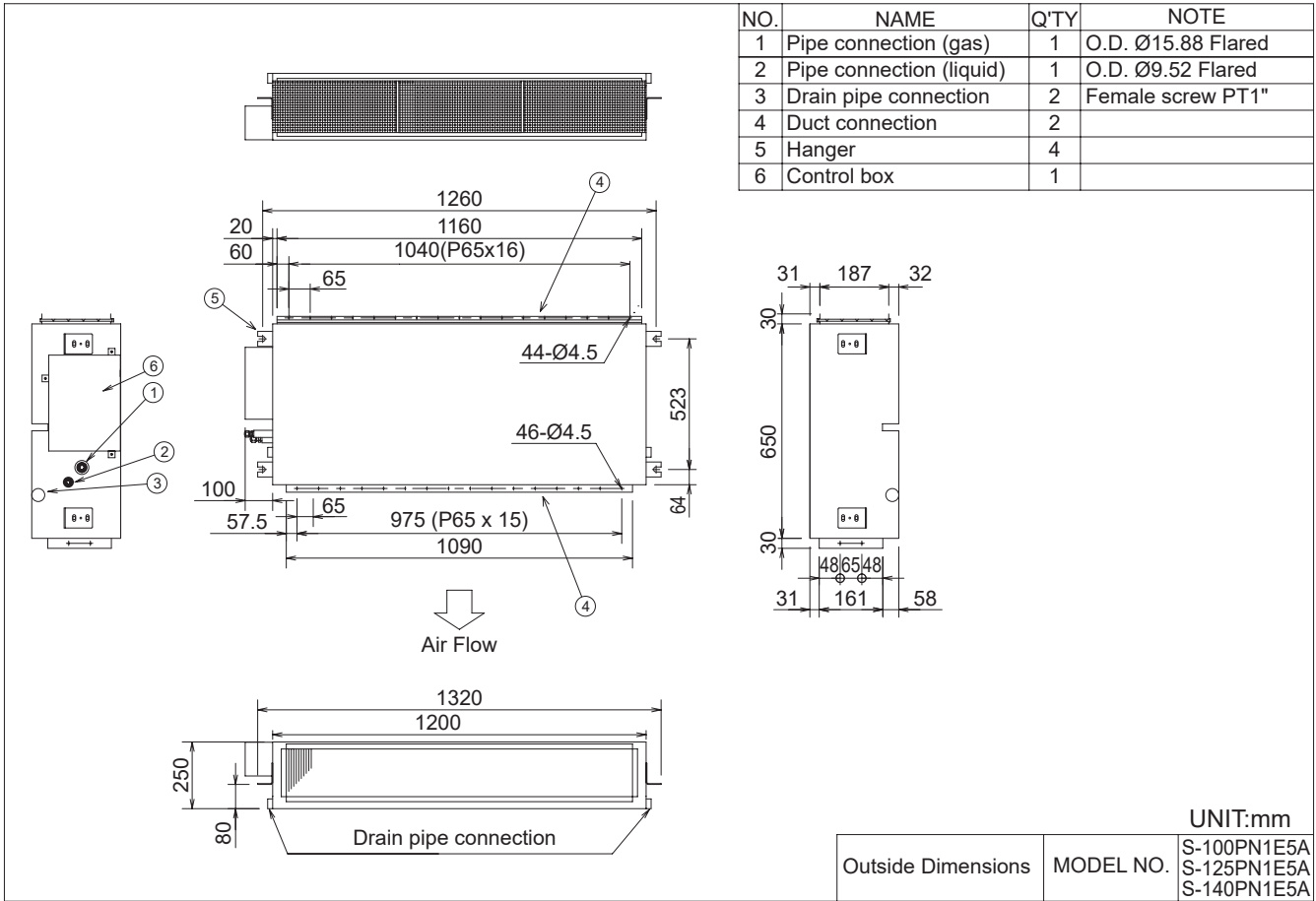


| NO. | NAME                     | Q'TY | NOTE               |
|-----|--------------------------|------|--------------------|
| 1   | Pipe connection (gas)    | 1    | O.D. Ø15.88 Flared |
| 2   | Pipe connection (liquid) | 1    | O.D. Ø9.52 Flared  |
| 3   | Drain pipe connection    | 2    | Female screw PT1"  |
| 4   | Duct connection          | 2    |                    |
| 5   | Hanger                   | 4    |                    |
| 6   | Control box              | 1    |                    |



UNIT:mm

| Outside Dimensions | MODEL NO. | S-60PN1E5A<br>S-71PN1E5A |
|--------------------|-----------|--------------------------|
|--------------------|-----------|--------------------------|



## 7-2. Suspending the Indoor Unit

Depending on the ceiling type:

- Insert suspension bolts (Fig. 1-11-7-3)  
or
- Use existing ceiling supports or construct a suitable support (Fig. 1-11-7-4).

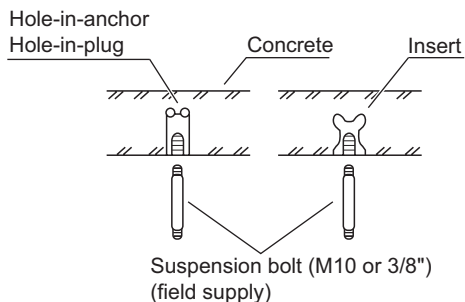


Fig. 1-11-7-3

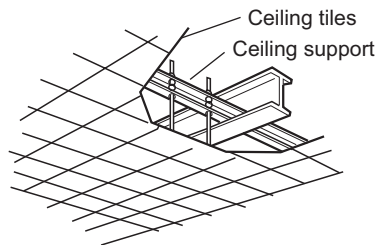


Fig. 1-11-7-4



### WARNING

It is important that you use extreme care in supporting the indoor unit inside the ceiling.

Ensure that the ceiling is strong enough to support the weight of the unit.

Before suspending the unit, test the strength of each attached suspension bolt.

- (1) When placing the unit inside the ceiling, determine the pitch of the suspension bolts referring to the dimensional data as shown in Fig. 1-11-7-1 and Table 1-11-7-1.  
Tubing must be laid and connected inside the ceiling when suspending the unit.  
If the ceiling is already constructed, lay the tubing into position for connection to the unit before placing the unit inside the ceiling.
- (2) Screw in the suspension bolts allowing them to protrude from the ceiling (Fig. 1-11-7-3). (Cut the ceiling material, if necessary.)
- (3) Thread the 3 hexagonal nuts and 2 washers (field supply) onto each of the 4 suspension bolts (Figs. 1-11-7-5 and 1-11-7-6).  
Use 1 nut and 1 washer for the upper part, and 2 nuts and 1 washer for the lower part, so that the unit will not fall off the suspension lugs.

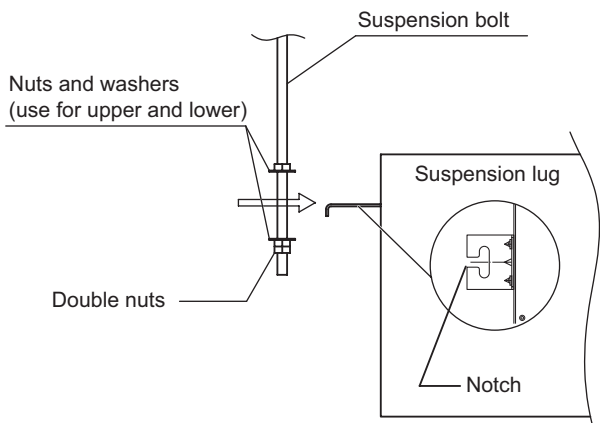


Fig. 1-11-7-5

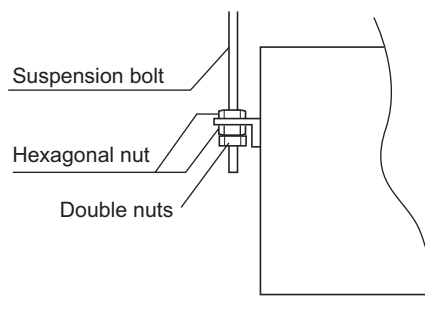


Fig. 1-11-7-6

- This shows an example of installation.

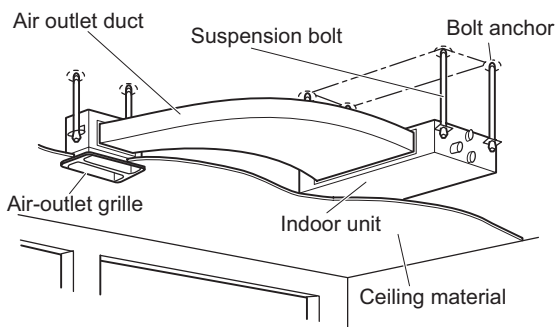


Fig. 1-11-7-7

### 7-3. Installing the Drain Pipe

(1) Prepare standard hard PVC pipe (O.D. 32 mm) for the drain and use the supplied hose band to prevent water leaks. The PVC pipe must be purchased separately.

**CAUTION**

- Do not use adhesive tape at the drain connection port on the indoor unit
- Insert the drain pipe until it contacts the socket, and then secure it tightly with the hose band.
- Do not use the supplied drain hose bent at a 90° angle. (The maximum permissible bend is 45°.)
- Tighten the hose clamps so their locking nuts face upward. (Fig. 1-11-7-8)

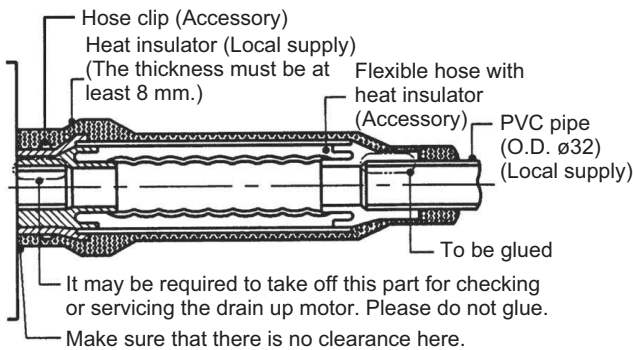


Fig. 1-11-7-8

(2) After connecting the drain pipe securely, wrap the supplied packing and drain pipe insulator around the pipe, then secure it with the vinyl clamps. (Fig. 1-11-7-9)

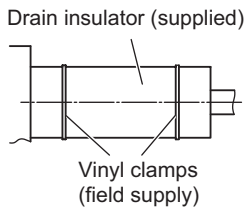


Fig. 1-11-7-9

**NOTE**

Make sure the drain pipe has a downward slant (1/100 or more) and that there are no water traps.

**CAUTION**

- Do not install an air bleeder as this may cause water to spray from the drain pipe outlet. ( Fig. 1-11-7-10)

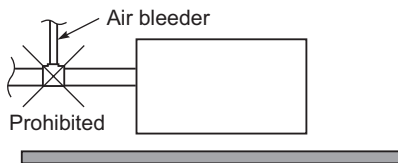


Fig. 1-11-7-10

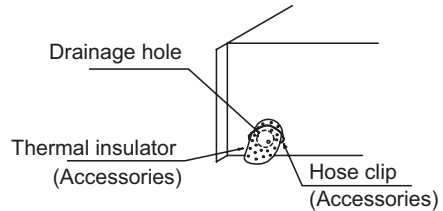


Fig. 1-11-7-11

- Do not install the pipe with an upward slant from the connection port. This will cause the drain water to flow backward and leak when the unit is not operating. (Fig. 1-11-7-12)

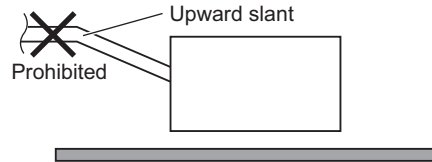


Fig. 1-11-7-12

- Do not apply force to the piping on the unit side when connecting the drain pipe. The pipe should not be allowed to hang unsupported from its connection to the unit. Fasten the pipe to a wall, frame, or other support as close to the unit as possible. (Fig. 1-11-7-13)

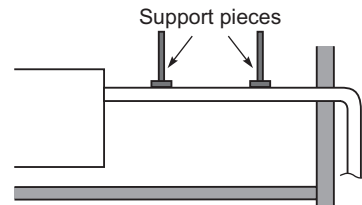


Fig. 1-11-7-13

### 7-4. Connecting Duct to Indoor Unit

(1) Install the duct (local supply) for the Dimension of the installation hole. Use M5 self-tapping screws for installation. See the Outside Dimensions.

(2) The duct connection of the air outlet needs thermal insulation.

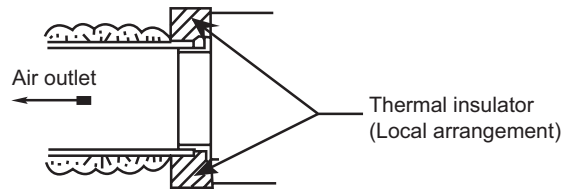


Fig. 1-11-7-14

**NOTE**

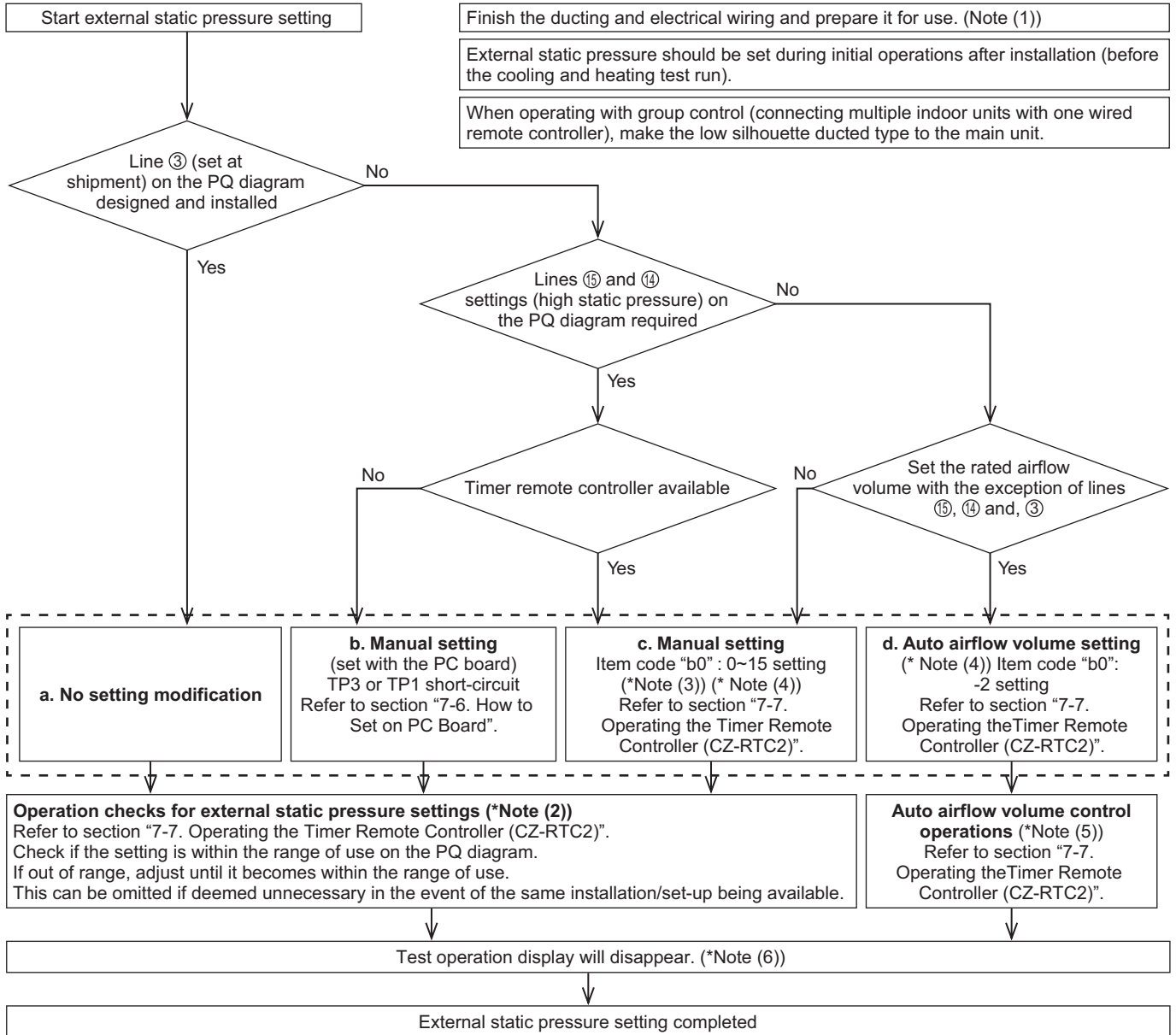
- Select an air-intake grille with a filter at a local shop.
- To get clean air and to extend the service life of the air conditioner, an air filter must be installed in the air intake. For installation and cleaning the air filter, consult your dealer or service center.

### 7-5. External Static Pressure Setting for Dc Fan Motor Model

Choose one of the following methods from “a”, “b”, “c” or “d” as shown in the flow chart (within the dotted lines) and then make the setting accordingly.

- a. No setting modification..... : Use-as-is at shipment (there are cases in which the setting may differ from the shipment setting when reset after once setting the external static pressure.)
- b. Manual setting (set with the PC board)..... : For high static pressure. Switching method with the short-circuit connector.
- c. Manual setting (set with the wired remote controller) ..... : Low static pressure ~ high static pressure
- d. Auto airflow volume setting (set on the wired remote controller).... : Air outlet volume is automatically adjusted to the rated airflow volume with the auto airflow control drive.

#### Flow of External Static Pressure



**NOTE**

- (1) Check the following items before performing the setting-check operations or auto airflow volume operations.
  - 1) Check to make sure that the electrical wiring and ducting have been completed. Activate the stand-by mode. In particular, make sure that the closed damper located in the middle of the duct is open, if installed. Also, make sure that air filters have been installed inside the air inlet duct. Check to make sure air is not leaking from the joints.
  - 2) If multiple air outlets and air inlets are included, adjust the airflow volume ratio of all of them until they meet the design airflow ratio.
  - 3) Make sure the address setting has been completed.
- (2) The operation check will be completed in approximately three minutes if the settings have been made correctly. The settings will be modified if they are out of the range of use (maximum 30 minutes). If this is not completed within 31 minutes, check whether the air speed is set to “H” or not.

- (3) Refer to Table 1-11-7-3 and Fig. 1-11-7-16 for details on the relationship between the value of item code "b0" and the external static pressure.
- (4) When set in group control (connecting multiple indoor units with one wired remote controller), set each indoor unit to item code "b0". When amending the setting after selecting [ b. Manual setting] (due to airflow path changes, etc.), it is necessary to cancel [b. Manual setting] (disconnect short-circuit connector). When [b. Manual setting] has not been cancelled, [c. Manual setting] and [d. Auto airflow volume setting] will be activated if selected, but [b Manual setting] takes precedence when the power is switched back on after power outages, etc.
- (5) If this is not completed within 8 minutes, check the drive mode, air speed and air inlet temperature.
- (6) When set in group control (connecting multiple indoor units with one wired remote controller), the test run operations display will disappear once the external static pressure setting check or auto airflow volume control operation check have been completed for the main unit.  
Decisions on sub-unit complete are not possible.  
The test run operation display will disappear after one hour even if the external status pressure setting check or auto airflow volume control operation check have not been completed.



## CAUTION

- Be sure to check that the external static pressure is within the range for use and then make the setting.  
Failure to observe this may result in insufficient airflow or water leakages.  
Refer to Fig. 1-11-7-16 for the external static pressure setting range.
- There are cases in which automatic variable dampers and other mounted items may trigger the P12 alarm on systems that modify the static pressure of outdoor units when the auto airflow volume control operations or setting check operations are carried out if high static pressure in the outdoor unit is lowered.  
In this event, lower the dampers, etc., so that the static pressure in the outdoor unit reaches its lowest level, and then carry out the auto airflow volume control operations or setting check operations.
- Be sure to set the [External Static Pressure Setting] once again after amending the airflow path for the duct or air outlet after setting the external static pressure.
- Set the air inlet temperature within the range for use.  
The auto airflow volume control will not function if the air inlet temperature is over 45°C or not in the fan mode.

## 7-6. How to Set on PC Board

1. Turn off the power breaker to halt the supply of electricity to the PC board.
2. Open the lid of electrical component box and check where the short-circuit pin on the indoor unit control PC board is located (Fig. 1-11-7-15)
3. Short circuit the applicable short-circuit pin in accordance with the selected short-circuit pin connected (Table 1-11-7-2).

Table 1-11-7-2 Selection of connected short-circuit pins

| External static pressure at the time of rated airflow volume | Short-circuit pin |
|--|-------------------|
| Unusable   | TP6 (2P: white)   |
| line ⑮   | TP3 (2P: yellow)  |
| line ⑭   | TP1 (2P: red)     |

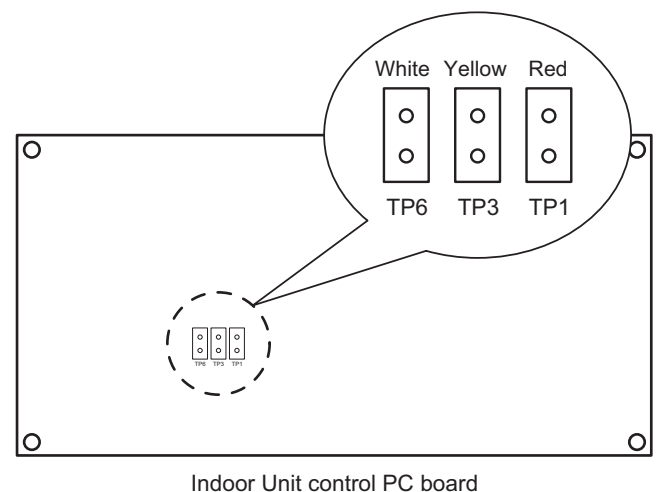


Fig. 1-11-7-15

### 7-7. Operating the Timer Remote Controller (CZ-RTC2)

Setting Item Code "60"

- Press and hold down the , and buttons simultaneously for 4 or more seconds.  
(**SETTING**, the Unit No., Item Code and Detailed Data will blink on the remote controller's LCD display.)
- The indoor unit numbers in the group control will be sequentially displayed whenever the Unit Select button is pressed .  
Only the fan motor for the selected indoor unit will operate during this.
- Specify the "60" item code by pressing the / buttons for the temperature setting buttons and confirm the values.  
( "-001" set at shipment )
- Press the / buttons for the time to amend the values for the set data.  
Refer to table 1-11-7-3 and Fig. 1-11-7-16 and select a value between "0001" and "0015".  
Select "-002" if the auto airflow volume setting is activated.
- Press the button.  
The display will stop blinking and remain illuminated.
- Press the button.  
The fan motor will stop operating and the LCD display will return to the normal stop mode.

Table 1-11-7-3 Setting the external static pressure

| Indoor unit  |               | Item code |
|--|---------------|-----------|
| 60, 71   | 100, 125, 140 | 60        |
| External static pressure of the rated air flow volume (Pa) |               |           |
| according to Indoor Unit P-Q diagram                       |               |           |
| 0015   |               |           |
| 0014   |               |           |
| 0013   |               |           |
| 0012   |               |           |
| 0011   |               |           |
| 0008   |               |           |
| 0006   |               |           |
| 0005   |               |           |
| 0003   |               |           |
| 0001   |               |           |
| No auto airflow volume setting                             |               | -001      |
| Auto airflow volume setting                                |               | -002      |

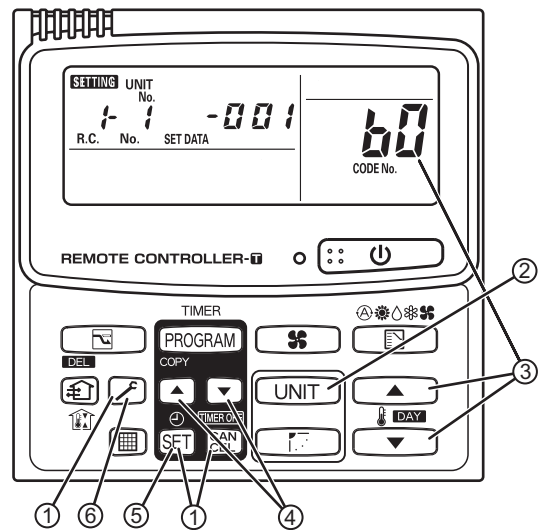
#### Auto Airflow Volume Control Operations and External Static Pressure Setting-Check Operation

- Press and hold down the button for 4 or more seconds. "TEST" will be displayed on the remote controller's LCD display.
- Press the button to commence the test run.  
[Test Run] will be displayed on the remote controller's LCD display.
- Select the fan mode and set it to "H" by pressing the button.

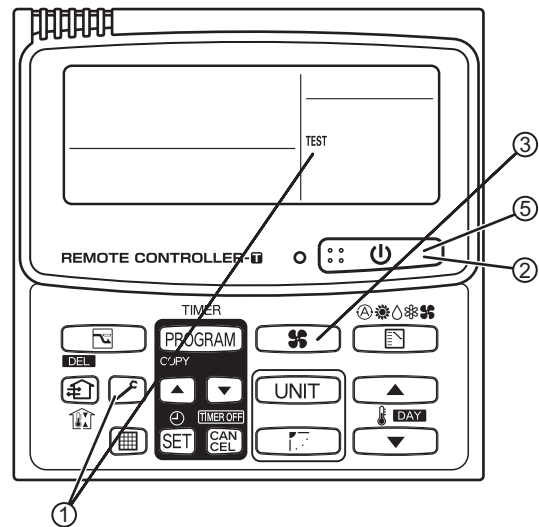


Auto airflow volume control operations and external static pressure setting-check operations will not be performed unless [H] has been selected for the fan mode.

- The fan motor will be activated and auto airflow volume control operations or external static pressure setting-check operations will commence.  
The power of the airflow will change while these operations are in progress.  
The external static pressure setting-check operations and auto airflow volume control operations will be completed in about 3 to 30 minutes.  
The "TEST" display will be extinguished from the remote controller's LCD display.
- Press the button to halt the test run.



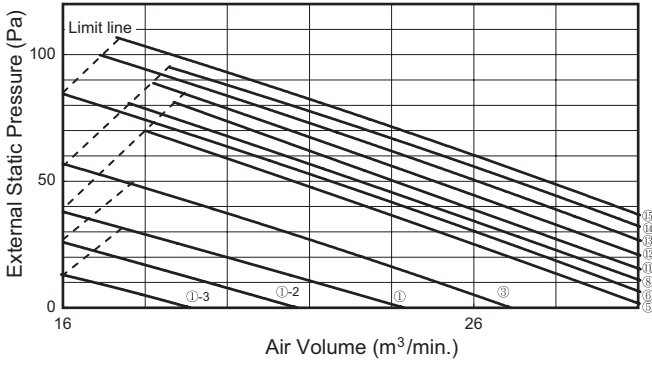
\* Failure to set this parameter may result in decreased airflow and condensation.



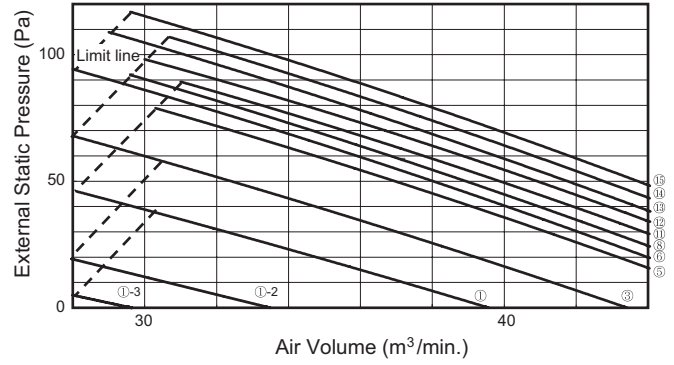
Indoor Fan Performance

|     |   | Item code "b0" |         |         |         |         |         |         |         |         |         |         |         |   |   |   |   |   |   |  |
|-----|---|----------------|---------|---------|---------|---------|---------|---------|---------|---------|---------|---------|---------|---|---|---|---|---|---|--|
|     |   | 0015           | 0014    | 0013    | 0012    | 0011    | 0008    | 0006    | 0005    | 0003    | 0001    |         |         |   |   |   |   |   |   |  |
|     |   | Cooling        | Heating | Cooling | Heating | Cooling | Heating | Cooling | Heating | Cooling | Heating | Cooling | Heating |   |   |   |   |   |   |  |
| Tap | ⑮ | H              | H       |         |         |         |         |         |         |         |         |         |         |   |   |   |   |   |   |  |
|     | ⑭ |                |         | H       | H       |         |         |         |         |         |         |         |         |   |   |   |   |   |   |  |
|     | ⑬ | M              | M       |         |         | H       | H       |         |         |         |         |         |         |   |   |   |   |   |   |  |
|     | ⑫ |                |         |         |         | H       | H       |         |         |         |         |         |         |   |   |   |   |   |   |  |
|     | ⑪ |                |         | M       |         |         |         | H       | H       |         |         |         |         |   |   |   |   |   |   |  |
|     | ⑩ |                |         | M       |         | M       | M       | M       |         |         |         |         |         |   |   |   |   |   |   |  |
|     | ⑨ | L              | L       |         |         | M       | M       |         |         |         | H       | H       |         |   |   |   |   |   |   |  |
|     | ⑧ |                |         |         |         |         |         |         |         | M       | M       |         | H       | H |   |   |   |   |   |  |
|     | ⑦ |                |         | L       | L       | L       | L       | L       | L       |         |         | M       | M       | M | M | H | H |   |   |  |
|     | ⑥ |                | L       | L       |         |         |         |         |         | L       | L       | L       | L       |   |   | M | M | H | H |  |
| ⑤   |   |                |         |         |         |         |         |         |         |         |         |         |         |   |   |   |   |   |   |  |
| ④   |   |                |         |         |         |         |         |         |         |         |         |         |         |   |   |   |   |   |   |  |
| ③   |   |                |         |         |         |         |         |         |         |         |         |         |         |   |   |   |   |   |   |  |
| ②   |   |                |         |         |         |         |         |         |         |         |         |         |         |   |   |   |   |   |   |  |
| ①   |   |                |         |         |         |         |         |         |         |         |         |         |         |   |   |   |   |   |   |  |
| ①-2 |   |                |         |         |         |         |         |         |         |         |         |         |         |   |   |   |   |   |   |  |
| ①-3 |   |                |         |         |         |         |         |         |         |         |         |         |         |   |   |   |   |   |   |  |

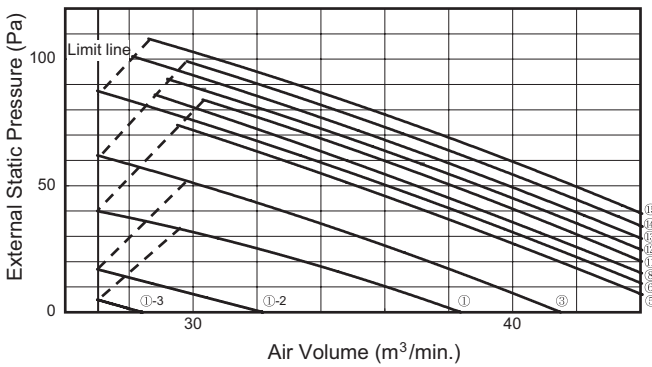
S-60PN1E5A • S-71PN1E5A P-Q diagram



S-125PN1E5A P-Q diagram



S-100PN1E5A P-Q diagram



S-140PN1E5A P-Q diagram

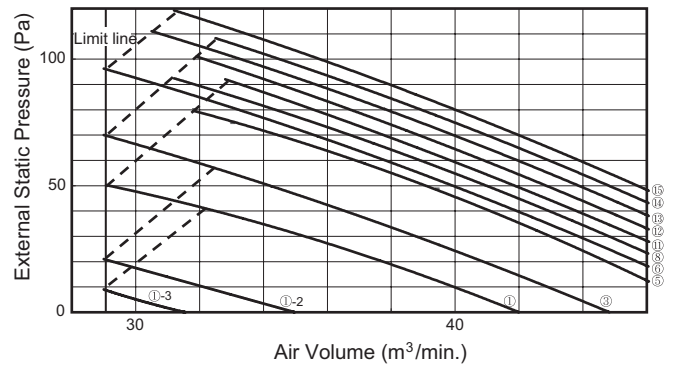


Fig. 1-11-7-16



### 7-8. External Static Pressure Setting for AC Fan Motor Model

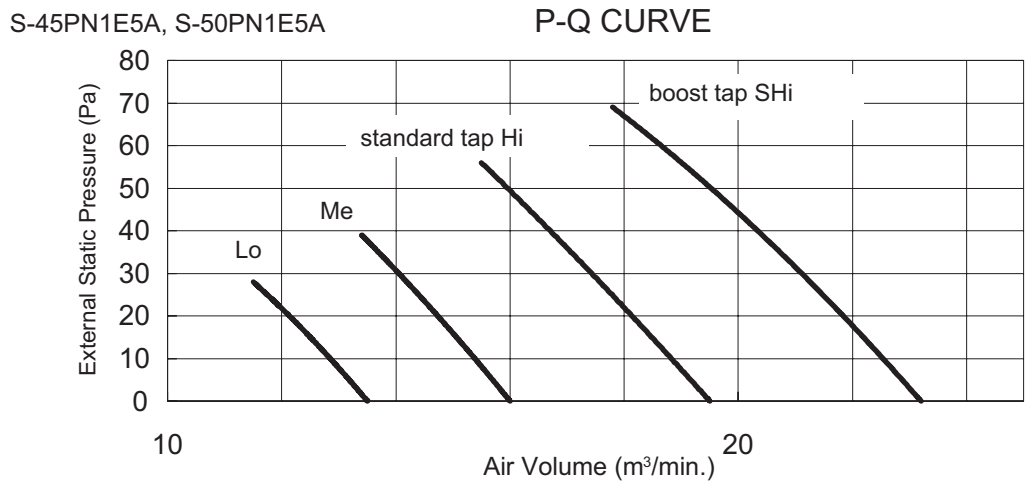
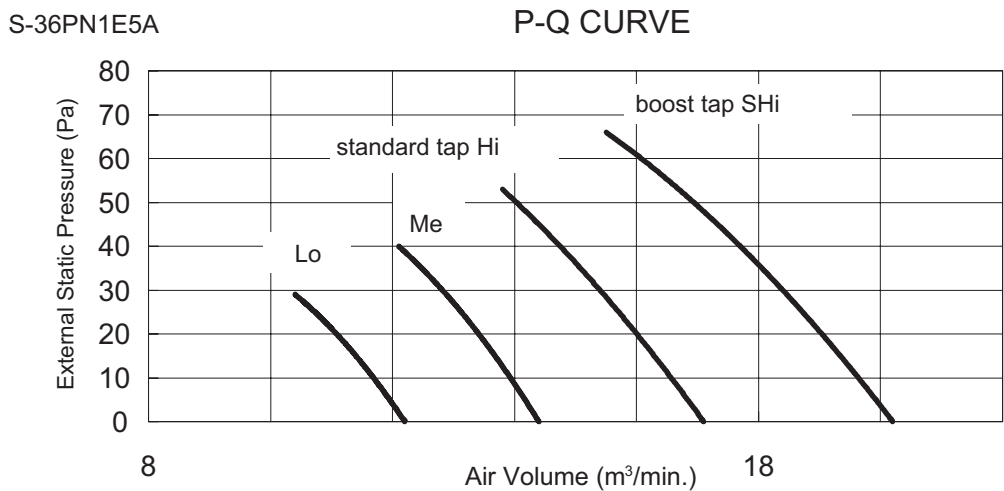
To apply to following models

- S-36PN1E5A , S-45PN1E5A , S-50PN1E5A








There are two tap connector located in indoor unit control box can be selected.

The "blue connector" is standard tap, use-as-is at shipment.

For high static pressure duct, switch Fan Motor connector to plug in boost tap "white connector" to elevate air volume.



## (Ducted)

| Part Name         | Figure  | Q'ty | Remarks                                     |
|-------------------|---|------|---|
| Washer            |  | 8    | For suspending indoor unit from ceiling     |
| Flare insulator   |  | 2    | For gas and liquid tubes                    |
| Hose band         |  | 5    | For securing drain hose                     |
| Foam drain socket |  | 1    | For drain hole (another side of drain hose) |
| Drain hose        |  | 1    |   |
| Flange            |  | 2    |   |
| Screw             |  | 4    | For inlet duct installation                 |

- Use M10 for suspension bolts.
- Suspension bolts and nuts are field supply.

## 8. 4-Way Cassette 60×60 Type (Y2)

### ■ SELECTING THE INSTALLATION SITE

#### Indoor Unit

#### AVOID:

- areas where leakage of flammable gas may be expected.
- places where large amounts of oil mist exist.
- direct sunlight.
- locations near heat sources which may affect the performance of the unit.
- locations where external air may enter the room directly. This may cause “condensation” on the air discharge ports, causing them to spray or drip water.
- locations where the remote controller will be splashed with water or affected by dampness or humidity.
- installing the remote controller behind curtains or furniture.
- locations where high-frequency emissions are generated.

#### DO:

- select an appropriate position from which every corner of the room can be uniformly cooled.
- select a location where the ceiling is strong enough to support the weight of the unit.



#### WARNING

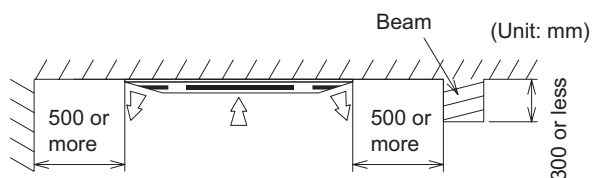
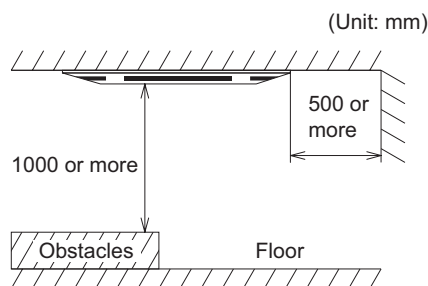
**The installation position must be able to support a load four times the indoor unit weight.**

- select a location where tubing and drain pipe have the shortest run to the outdoor unit.
- allow room for operation and maintenance as well as unrestricted air flow around the unit.
- install the unit within the maximum elevation difference above or below the outdoor unit and within a total tubing length (L) from the outdoor unit as detailed in the installation manual packed with the outdoor unit.
- allow room for mounting the remote controller about 1m off the floor, in an area that is not in direct sunlight or in the flow of cool air from the indoor unit.

#### NOTE

Air delivery will be degraded if the distance from the floor to the ceiling is greater than 3 m.

#### 4-Way Cassette 60×60 Type



- \* If the height from the floor to ceiling exceeds three meters, air flow distribution deteriorates and the effect is decreased.

■ HOW TO INSTALL THE INDOOR UNIT

■ 4-Way Cassette 60×60 Type (Type Y2)

8-1. Preparation for Ceiling Suspension

This unit uses a drain pump. Use a carpenter's level to check that the unit is level.

8-2. Ceiling Opening Dimensions and Hanging Bolt Location

This air conditioner uses a drain up motor. Horizontally install the unit using a carpenter's level. The paper model for installation expand or shrink according to temperature and humidity. Check on dimensions before using it.

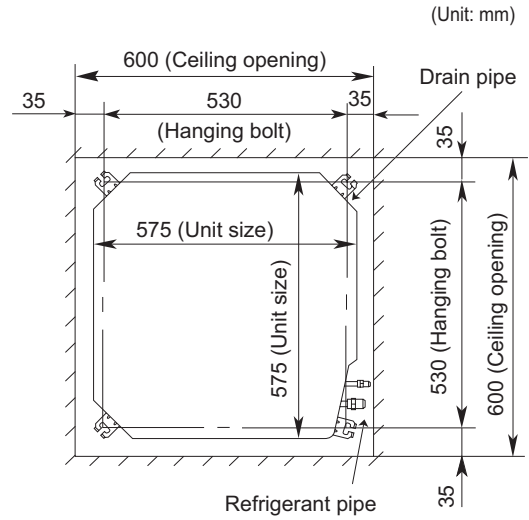


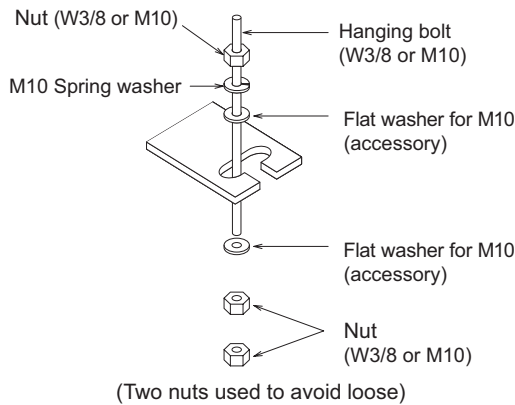
Fig. 1-11-8-1



During the installation, care must be taken not to damage electric wires.

- The dimensions of the paper model for installation are the same as those of the ceiling opening dimensions.
- Be sure to discuss the ceiling drilling work with the workers concerned.

8-3. Positions of Air Conditioner Body and Ceiling Surface



Note: Customers should purchase\* marked item.

Fig. 1-11-8-2

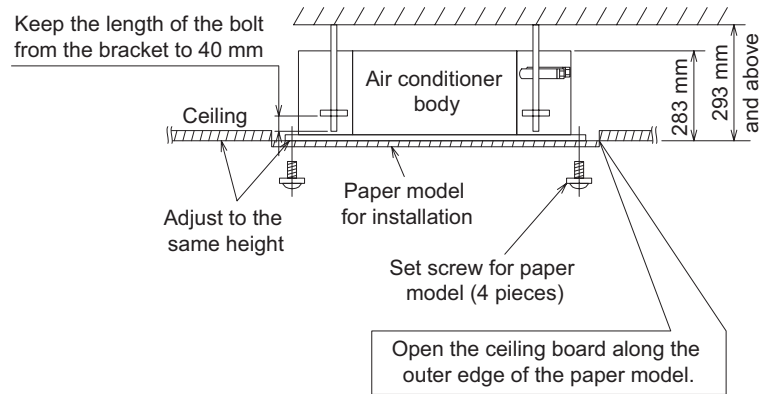


Fig. 1-11-8-3



Tighten the nut and bolt to prevent unit from falling.

8-4. Installing the Drain Pipe

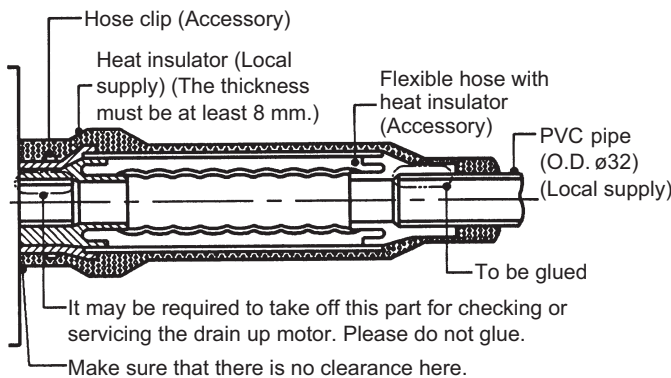


Fig. 1-11-8-4

NOTE

Make sure the drain pipe has a downward gradient (1/100 or more) and that there are no water traps.

### 8-5. Indoor Unit Drain Piping

- During drain piping connection, be careful not to exert extra force on the drain port at the indoor unit.
- The outside diameter of the drain connection at the indoor unit is 32 mm.  
Piping material: Polyvinyl chloride pipe VP-25 and pipe fittings.
- Be sure to perform heat insulation on the drain piping.  
Heat insulation material: Polyethylene foam with thickness more than 8 mm (local supply).
- Drain piping must have down-slope (1/50 to 1/100); be sure not to provide up-and-down slope to prevent reversal flow.
- Be sure to check no air trap on drain hose and to ensure smooth water flow and no abnormal sound.
- The height of drain may be possible up to 750 mm.
- When drain set piping, install as shown in the figure below.

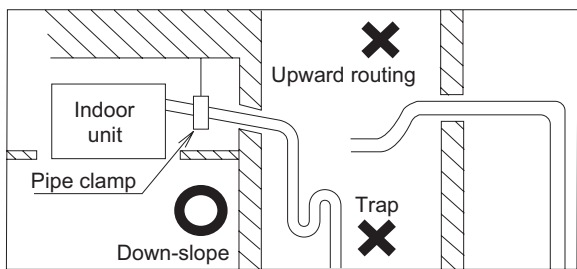


Fig. 1-11-8-5

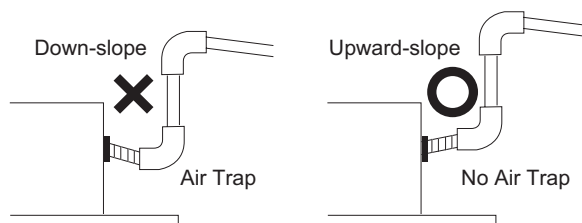


Fig. 1-11-8-6

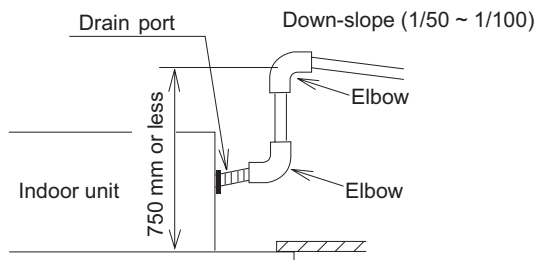


Fig. 1-11-8-7

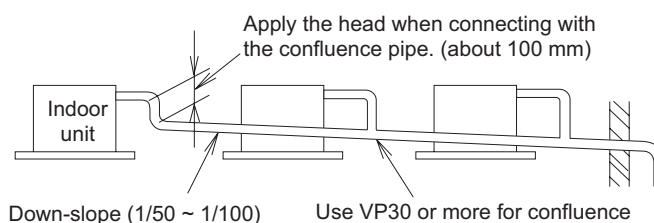


Fig. 1-11-8-8

#### Drain Test

The air conditioner uses a drain up motor to drain water. Use the following procedure to test the drain up motor operation.

- Connect the main drain pipe to exterior and leave it provisionally until the test comes to an end.
- Feed water to the flexible drain hose and check the piping for leakage.
- Be sure to check the drain up motor for normal operating and noise when electric wiring is complete.
- When the test is complete, connect the flexible drain hose to the drain port.

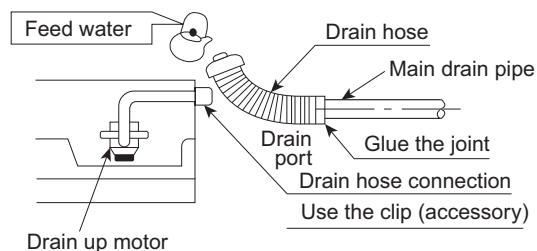


Fig. 1-11-8-9

## 8-6. Connecting Tubing Between Indoor and Outdoor Units

(1) Tightly connect the indoor-side refrigerant tubing extended from the wall with the outdoor-side tubing.

Indoor Unit Tubing Connection (Q 1, Q 2... n-1)

|                    |       |    |    |
|--------------------|-------|----|----|
| Indoor unit type   | 36    | 45 | 50 |
| Gas tubing (mm)    | ø12.7 |    |    |
| Liquid tubing (mm) | ø6.35 |    |    |

(2) To fasten the flare nuts, apply specified torque.

- When removing the flare nuts from the tubing connections, or when tightening them after connecting the tubing, be sure to use 2 adjustable wrenches or spanners. (Fig. 1-11-8-10) If the flare nuts are over-tightened, the flare may be damaged, which could result in refrigerant leakage and cause injury or asphyxiation to room occupants.
- For the flare nuts at tubing connections, be sure to use the flare nuts that were supplied with the unit, or else flare nuts for R410A (type 2). The refrigerant tubing that is used must be of the correct wall thickness as shown in the table below.

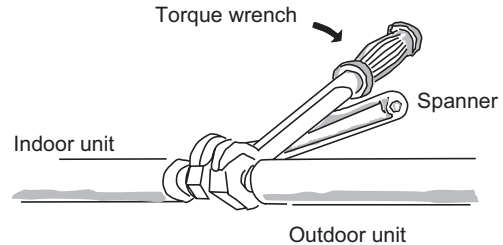


Fig. 1-11-8-10

| Tube diameter | Tightening torque (approximate)       | Tube thickness |
|---------------|---------------------------------------|----------------|
| ø6.35 (1/4")  | 14 – 18 N · m<br>{140 – 180 kgf · cm} | 0.8 mm         |
| ø9.52 (3/8")  | 34 – 42 N · m<br>{340 – 420 kgf · cm} | 0.8 mm         |
| ø12.7 (1/2")  | 49 – 61 N · m<br>{490 – 610 kgf · cm} | 0.8 mm         |
| ø15.88 (5/8") | 68 – 82 N · m<br>{680 – 820 kgf · cm} | 1.0 mm         |

Because the pressure is approximately 1.6 times higher than conventional refrigerant pressure, the use of ordinary flare nuts (type 1) or thin-walled tubes may result in tube rupture, injury, or asphyxiation caused by refrigerant leakage.

- In order to prevent damage to the flare caused by over-tightening of the flare nuts, use the table above as a guide when tightening.
- When tightening the flare nut on the liquid tube, use an adjustable wrench with a nominal handle length of 200 mm.

## 8-7. Insulating the Refrigerant Tubing

### Tubing Insulation

- Thermal insulation must be applied to all units tubing, including distribution joint (local supply).
    - \* For gas tubing, the insulation material must be heat resistant to 120°C or above. For other tubing, it must be heat resistant to 80°C or above.
- Insulation material thickness must be 10 mm or greater.  
If the conditions inside the ceiling exceed DB 30°C and RH 70%, increase the thickness of the gas tubing insulation material by 1 step.

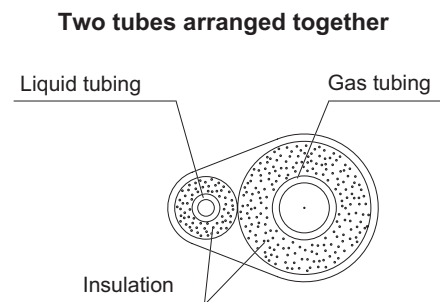


Fig. 1-11-8-11



**CAUTION**

If the exterior of the outdoor unit valves has been finished with a square duct covering, make sure you allow sufficient space to access the valves and to allow the panels to be attached and removed.

### Taping the flare nuts

Wind the white insulation tape around the flare nuts at the gas tube connections. Then cover up the tubing connections with the flare insulator, and fill the gap at the union with the supplied black insulation tape. Finally, fasten the insulator at both ends with the supplied vinyl clamps. (Fig. 1-11-8-12)

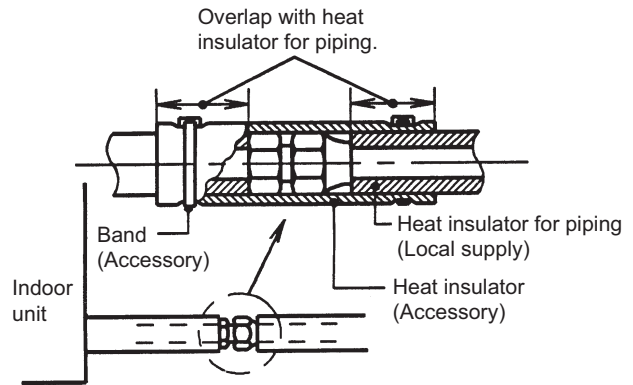
**Heat Insulation**



**Be sure to perform heat insulation on the drain, liquid and gas piping.**  
**Imperfection in heat insulation work leads to water leakage.**

- (1) Use the heat insulation material for the refrigerant piping which has an excellent heat-resistance (over 120°C).
- (2) Precautions in high humidity circumstance.  
 This air conditioner has been tested according to the "JIS Standard Conditions with Mist" and have been confirmed that there are no faults. However, if it is operated for a long time in high humid atmosphere (dew point temperature: more than 23°C), water drops are liable to fall. In this case, add heat insulation material according to the following procedure:

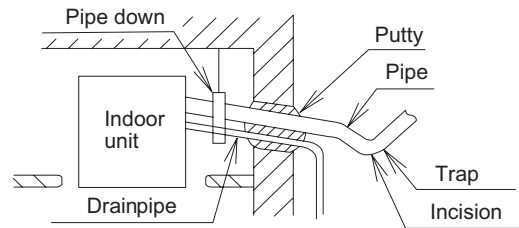
- Heat insulation material to be prepared... Adiabatic glass wool with thickness 10 to 20 mm.
- Stick glass wool on all air conditioners that are located in ceiling atmosphere.
- In addition to the normal heat insulation (thickness: more than 8 mm) for refrigerant piping (gas piping: thick piping) and drain piping, add a further of 10 mm to 30 mm thickness material.



**Fig. 1-11-8-12**

**Wall seal**

- When the outdoor unit is installed on a higher position than the indoor unit, install the trap so as not to instill rain water into the wall by transmitting in piping.
- Stuff the space among piping, the electric wire, and the drain hose with putty and seal the penetration wall hole. Make sure that rain water do not instill into the wall.

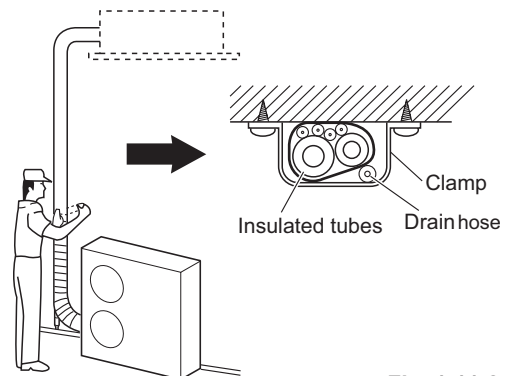


\* Put the incision at the trap part of the heat insulator (for water drain)

**Fig. 1-11-8-13**

**8-8. Taping the Tubes**

- (1) At this time, the refrigerant tubes (and electrical wiring if local codes permit) should be taped together with armoring tape in 1 bundle. To prevent condensation from overflowing the drain pan, keep the drain hose separate from the refrigerant tubing.
- (2) Wrap the armoring tape from the bottom of the outdoor unit to the top of the tubing where it enters the wall. As you wrap the tubing, overlap half of each previous tape turn.
- (3) Clamp the tubing bundle to the wall, using 1 clamp approx. each meter. (Fig. 1-11-8-14)



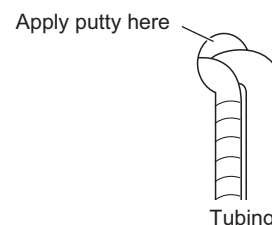
**Fig. 1-11-8-14**

**NOTE**

Do not wind the armoring tape too tightly since this will decrease the heat insulation effect. Also ensure that the condensation drain hose splits away from the bundle and drips clear of the unit and the tubing.

**8-9. Finishing the Installation**

After finishing insulating and taping over the tubing, use sealing putty to seal off the hole in the wall to prevent rain and draft from entering. (Fig. 1-11-8-15)



**Fig. 1-11-8-15**

## 8-10. Installation of Decorative Panel

When using the wireless remote controller, follow the step 8-10-3 "When Using Wireless Remote Controller Instead of Wired Remote Controller" before installing the decorative panel.

### 8-10-1. Before Installing the Decorative Panel

- (1) Remove the air-intake grille and air filter from the decorative panel.
  - Remove the 2 screws on the latch of the air-intake grille. (Fig. 1-11-8-16) (Reattach the air-intake grille after installation of the decorative panel.)

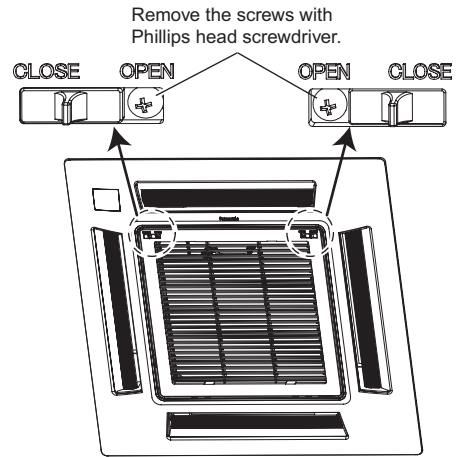


Fig. 1-11-8-16

### 8-10-2. Installing the Decorative Panel

The decorative panel has its installation direction. Confirm the direction by displaying the piping side.

- (1) Remove the air inlet grille by moving the catchers to center.

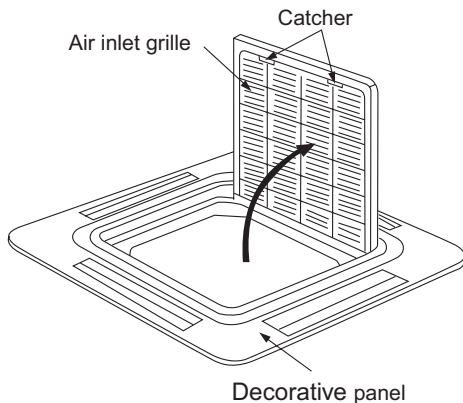


Fig. 1-11-8-17

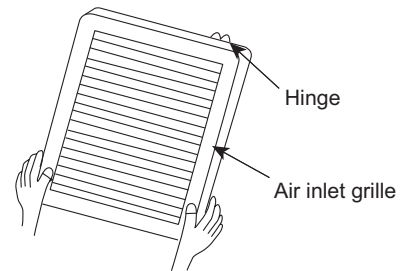


Fig. 1-11-8-18

\* Hang the hinge on the hole of decorative panel. (The direction of the installation is free.)

- (2) Fitting the decorative panel

- Temporarily secure the fixing screws (3 pcs.) before fitting the decorative panel. (For temporarily securing the front grille.)
- Place decorative panel on the screws (3 pcs.) before fitting, move decorative panel as illustrated and tighten all the screws (4 pcs.).

### CAUTION

- Check before hand the height from the ceiling to the unit.
- The front grille fitting direction is determined by the unit direction.
- Only use the screws with the length of 35 mm which is provided, to fix the decorative panel.
- Do not use other screw which is longer it may cause damage to the drain-pan and other components.

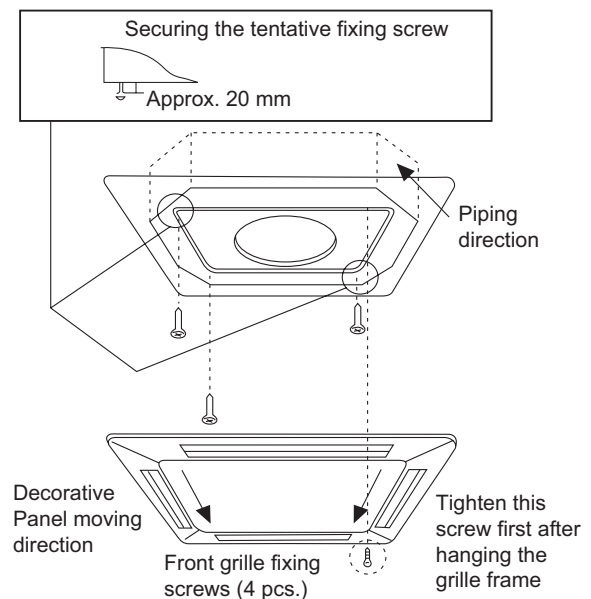
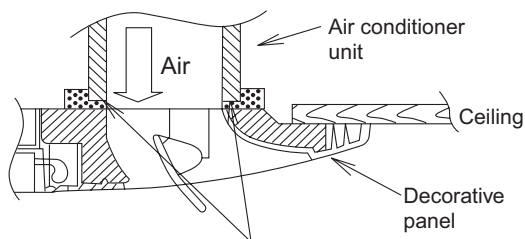


Fig. 1-11-8-19



- (3) Fit the decorative panel and ceiling wall together, making sure that there is no gap between the two. Readjust indoor unit height, if there is a gap between ceiling wall and decorative panel.

**Example of PROPER installation**



Fit the insulator (this part) and be careful for cool air leakage.

Fig. 1-11-8-20

**Example of IMPROPER installation**

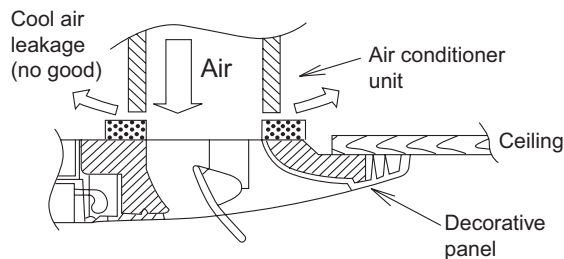


Fig. 1-11-8-21

- (4) Open the indoor control box cover. (3 pcs. screws)  
 (5) Insert firmly the connector of cosmetic louver to indoor PCB LM and WL.  
 Be caution not to clamp the cord in between control board and control board cover.  
 (6) After completing the aforementioned, install the removed part by reversing the steps for removal.

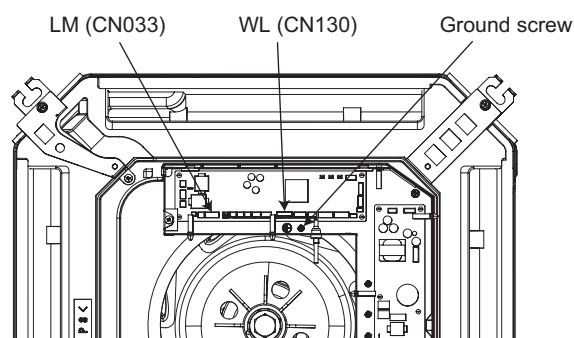


Fig. 1-11-8-22

**! WARNING**

Be sure to hook the air inlet grille string, to prevent grille from falling and causing injury from it.

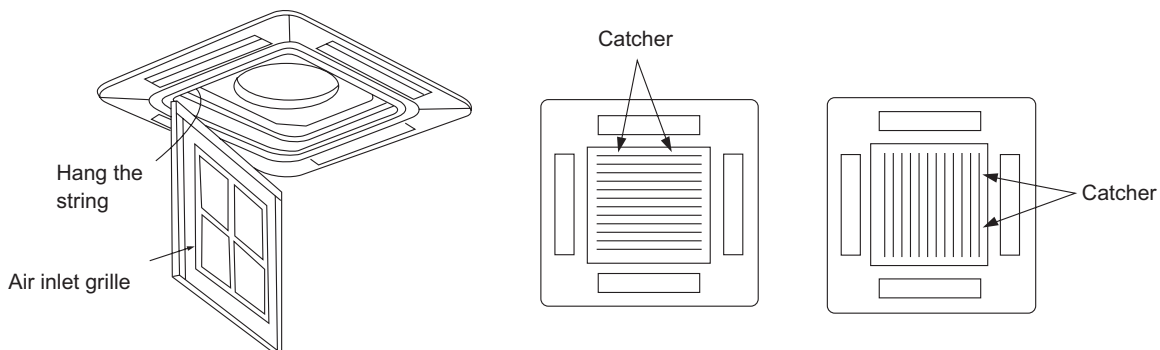


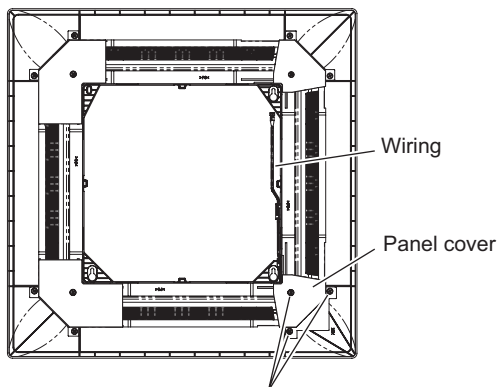
Fig. 1-11-8-23

**8-10-3. When Using Wireless Remote Controller Instead of Wired Remote Controller**

When the wireless remote controller is to be used, slide the switch (SW502) on the indoor unit control PCB to the ON position.

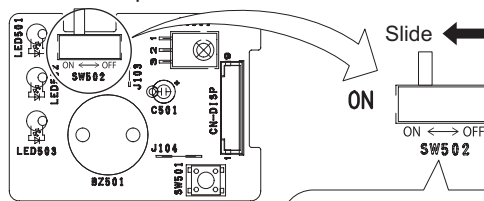
- If this setting is not made, an alarm will occur. (The operation lamp on the display blinks.)

Reverse side view of Decorative Panel



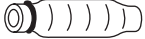

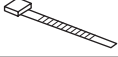

Remove 3 screws and panel cover




PCB inside panel cover



Setting status  
**ON:** Wireless: main, Wired: sub  
**OFF:** Wired: main, Wireless: sub (at shipment)

**(4-Way Cassette 60×60)**

| Part Name              | Figure  | Q'ty |
|------------------------|---|------|
| Drain hose with a clip |  | 1    |
| Heat Insulator         |  | 2    |
| Band                   |  | 4    |
| Flat washer for M10    |  | 8    |

| Part Name                 | Figure  | Q'ty |
|---------------------------|---|------|
| Screw M5                  |  | 4    |
| Operating Instructions    |  | 1    |
| Installation Instructions |  | 1    |

- Use M10 for hanging bolts.
- Field supply for hanging bolts and nuts.

## 1-12. How to select AHU system

### AHU system selection guideline

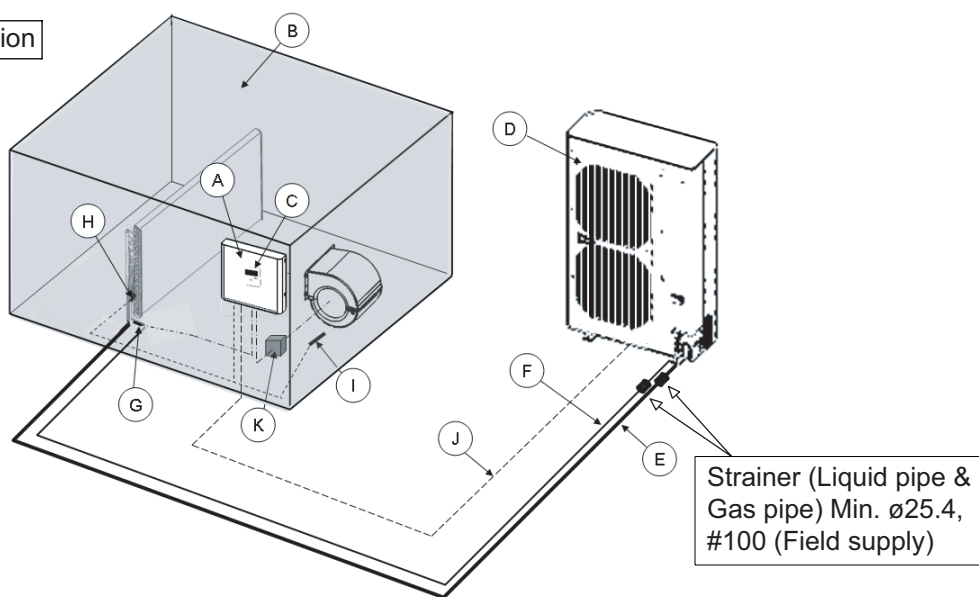
#### ● System lineup

| Capacity | Outdoor combination |             | Connectable AHU-kit combination |            |
|----------|---------------------|-------------|---------------------------------|------------|
|          | U-100PE1E8A         | U-100PE1E5A | CZ-280PAH1                      | CZ-280PAH1 |
| 10 kW    | U-100PE1E8A         | U-100PE1E5A | CZ-280PAH1                      | CZ-280PAH1 |
| 12.5 kW  | U-125PE1E8A         | U-125PE1E5A | CZ-280PAH1                      | CZ-280PAH1 |
| 14 kW    | U-140PE1E8A         | U-140PE1E5A | CZ-280PAH1                      | CZ-280PAH1 |

- \* Single connection type only
- \* Mix connection with standard indoor units is not allowed.
- \* The system is applicable to the above models.

#### ● System Overview

Single connection



- A: AHU kit controller box (with control PCB)
- B: AHU equipment (Field supplied)
- C: AHU kit controller (Option parts)
- D: Outdoor unit
- E: Gas piping (Field supplied)
- F: Liquid piping (Field supplied)
- G: Thermistor for Liquid pipe (E1)
- H: Thermistor for Heat exchanger pipe middle (E2)
- I: Thermistor for Suction air (TA)
- J: Inter-unit wiring
- K: Magnetic relay for operating the blower (Field supplied)

#### ● Piping design regulation

- Connecting pipe dimension to heat exchanger of AHU

| Capacity | Model name | Liquid pipe | Gas pipe |
|----------|------------|-------------|----------|
| 10-14kW  | CZ-280PAH1 | ø9.52mm     | ø15.88mm |

- System piping length (Charging with refrigerant)

At the time of shipment from the factory, the outdoor unit is charged with enough refrigerant for an equivalent pipe length of 30m.

If the equivalent piping length used is 30m or less, no additional charge will be necessary.

If the equivalent piping length is between 30 and 50m, charge with additional refrigerant according to the equivalent length given in the following table.

| Capacity | Additional charge amount | Equivalent length | Minimum length |
|----------|--------------------------|-------------------|----------------|
| 10-14kW  | 50g/m                    | 50m               | 5m             |

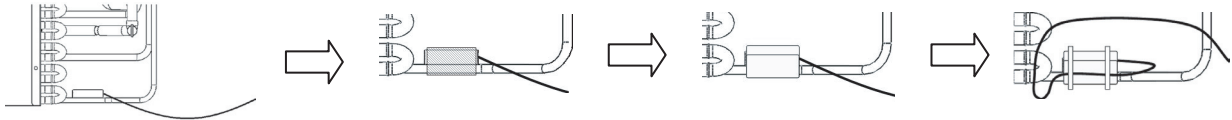
## ● Installation

### ▪ Installation of Strainer (Field supplied)

Attach the strainer to the side of the outdoor unit for Gas & Liquid piping.  
(See the "System Overview" on previous page.)

### ▪ Thermistor for Liquid pipe and Heat exchanger pipe middle

#### Liquid pipe thermistor



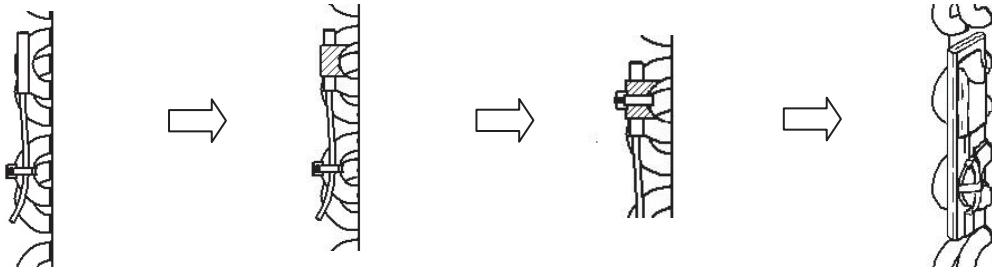
Attach the liquid pipe thermistor to the liquid pipe located in the lowest position after distributor in heat exchanger.

Cover the thermistor and pipe with aluminum tape.

Cover the aluminum tape with thermal insulation.

Thermal insulation and wiring are fixed in two bands.

#### Heat exchanger pipe thermistor



Attach the heat exchanger pipe thermistor in the middle of each pass-line (pipe) in the heat exchanger.

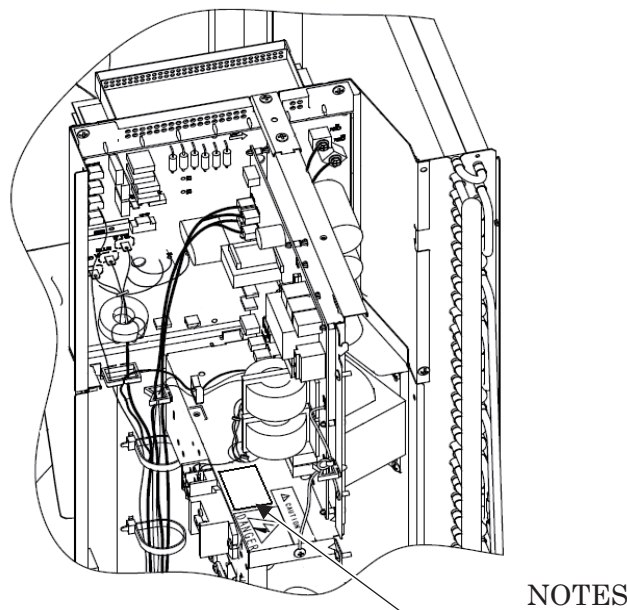
Cover the thermistor and pipe with aluminum tape.

The thermistor is fixed in band. Then, it must not make tension to the wire.

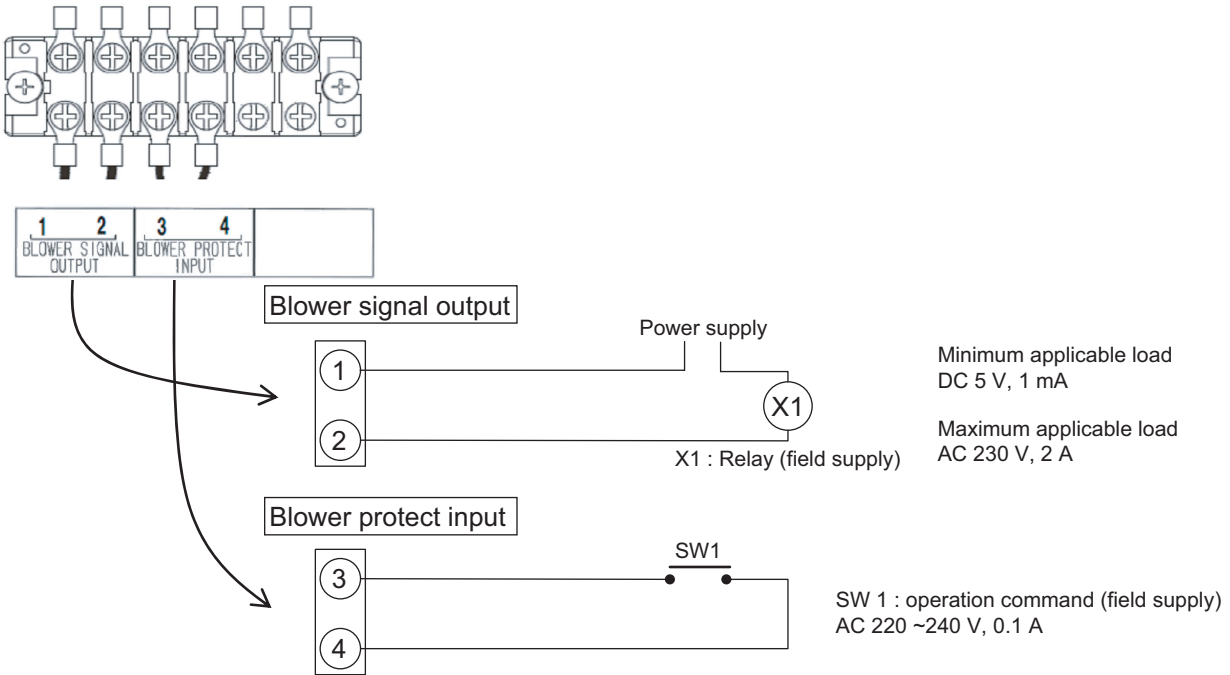
Cover the aluminum tape with thermal insulation. And also cover sensor (copper portion) with thermal insulation completely.

### ▪ Attachment of NOTES Label (Supplied parts)

Please be sure to apply the NOTES label at the designated area of the outdoor unit when cutting a jumper wire on the circuit board.



▪ Blower operation signal and protection signal



● Limitation of AHU

When the AHU is selected, there are some limitations.

- The limitation of temperature range is shown below.

|  |      | Cooling              | Heating     |
|--|------|----------------------|-------------|
| Outdoor temperature                              | Min. | -10 °C (DB)          | -20 °C (WB) |
|  | Max. | 43 °C (DB)           | 15 °C (WB)  |
| Inlet air temperature<br>(to the heat exchanger) | Min. | 18 °C (DB)           | 16 °C (DB)  |
|  | Max. | 32 °C(DB) / 23°C(WB) | 30 °C (DB)  |

- The limitation of Heat exchanger volume, Air volume and Front area is shown in the following Table 1-12-1, 1-12-2 and 1-12-3.

Table 1-12-1 : Inside volume of heat exchanger

| Cooling Capacity      |      | 10 kW               | 12.5 kW             | 14 kW               |
|-----------------------|------|---------------------|---------------------|---------------------|
| Heat exchanger volume | Max. | 2.1 dm <sup>3</sup> | 2.1 dm <sup>3</sup> | 2.1 dm <sup>3</sup> |
|                       | Min. | 1.7 dm <sup>3</sup> | 1.7 dm <sup>3</sup> | 1.7 dm <sup>3</sup> |

Table 1-12-2 : Air volume of heat exchanger

| Cooling Capacity |      | 10 kW                  | 12.5 kW                | 14 kW                  |
|------------------|------|------------------------|------------------------|------------------------|
| Air volume       | Max. | 1980 m <sup>3</sup> /h | 2100 m <sup>3</sup> /h | 2160 m <sup>3</sup> /h |
|                  | Min. | 840 m <sup>3</sup> /h  | 1140 m <sup>3</sup> /h | 1140 m <sup>3</sup> /h |

Table 1-12-3 : Front area of heat exchanger

| Cooling Capacity |      | 10 kW               | 12.5 kW             | 14 kW               |
|------------------|------|---------------------|---------------------|---------------------|
| Front area       | Max. | 0.51 m <sup>2</sup> | 0.51 m <sup>2</sup> | 0.51 m <sup>2</sup> |
|                  | Min. | 0.43 m <sup>2</sup> | 0.43 m <sup>2</sup> | 0.43 m <sup>2</sup> |

● Restriction on the number of passes of the heat exchanger hairpin

Minimum number of passes

$$= \text{Number of steps} \times \text{Distance between tube sheets} \times \text{Number of rows} \times 1.5 \times 10^{-4}$$

<For example>

Number of steps : 12

Distance between tube sheets : 1000 [mm]

Number of rows : 3

$$\therefore \text{Minimum number of passes} = 12 \times 1000 \times 3 \times 1.5 \times 10^{-4} = 5.4 < 6 \text{ passes}$$

1-13. Capacity Table

1. Cooling Capacity Performance Data

TC :Cooling Capacity

SHC :Sensible Heat Capacity

IPT :Cooling Power Consumption

• Combination of Single Unit

unit : kW

4-Way Cassette Type

| Model                    | Power Source                  | Ambient Return Air       |                               | Outdoor air intake temp(°C D.B.) |     |      |      |      |      |      |      |      |      |      |      |      |      |      |     |      |
|--------------------------|-------------------------------|--------------------------|-------------------------------|----------------------------------|-----|------|------|------|------|------|------|------|------|------|------|------|------|------|-----|------|
|                          |                               |                          |                               | 25°C                             |     |      | 30°C |      |      | 35°C |      |      | 40°C |      |      | 46°C |      |      |     |      |
|                          |                               | DB                       | WB                            | TC                               | SHC | IPT  | TC   | SHC  | IPT  | TC   | SHC  | IPT  | TC   | SHC  | IPT  | TC   | SHC  | IPT  |     |      |
| S-36PU2E5A<br>U-36PE2E5A | 220V-230V-240V<br>50Hz 1phase | 23                       | 16                            | 4.2                              | 3.5 | 0.79 | 4.0  | 3.5  | 0.84 | 3.7  | 3.3  | 0.89 | 3.4  | 3.2  | 0.88 | 2.8  | 2.8  | 0.68 |     |      |
|                          |                               |                          | 19                            | 4.5                              | 2.6 | 0.81 | 4.3  | 2.5  | 0.86 | 4.0  | 2.4  | 0.91 | 3.7  | 2.3  | 0.89 | 3.0  | 2.0  | 0.68 |     |      |
|                          |                               |                          | 22                            | 4.8                              | 1.6 | 0.84 | 4.6  | 1.6  | 0.89 | 4.3  | 1.5  | 0.94 | 4.0  | 1.4  | 0.91 | 3.1  | 1.1  | 0.69 |     |      |
|                          |                               | 25                       | 16                            | 4.2                              | 4.1 | 0.79 | 4.0  | 4.0  | 0.84 | 3.7  | 3.7  | 0.89 | 3.4  | 3.4  | 0.88 | 2.8  | 2.8  | 0.68 |     |      |
|                          |                               |                          | 19                            | 4.5                              | 3.2 | 0.81 | 4.3  | 3.1  | 0.86 | 4.0  | 3.0  | 0.91 | 3.7  | 2.8  | 0.89 | 3.0  | 2.6  | 0.68 |     |      |
|                          |                               |                          | 22                            | 4.8                              | 2.2 | 0.84 | 4.6  | 2.1  | 0.89 | 4.3  | 2.0  | 0.94 | 4.0  | 1.9  | 0.91 | 3.1  | 1.6  | 0.69 |     |      |
|                          |                               | 27                       | 16                            | 4.2                              | 4.2 | 0.79 | 4.0  | 4.0  | 0.84 | 3.7  | 3.7  | 0.89 | 3.4  | 3.4  | 0.88 | 2.8  | 2.8  | 0.68 |     |      |
|                          |                               |                          | 19                            | 4.5                              | 3.7 | 0.81 | 4.3  | 3.6  | 0.86 | 4.0  | 3.5  | 0.91 | 3.7  | 3.4  | 0.89 | 3.0  | 3.0  | 0.68 |     |      |
|                          |                               |                          | 22                            | 4.8                              | 2.8 | 0.84 | 4.6  | 2.7  | 0.89 | 4.3  | 2.6  | 0.94 | 4.0  | 2.5  | 0.91 | 3.1  | 2.2  | 0.69 |     |      |
|                          |                               | 29                       | 16                            | 4.2                              | 4.2 | 0.79 | 4.0  | 4.0  | 0.84 | 3.7  | 3.7  | 0.89 | 3.4  | 3.4  | 0.88 | 2.8  | 2.8  | 0.68 |     |      |
|                          |                               |                          | 19                            | 4.5                              | 4.3 | 0.81 | 4.3  | 4.2  | 0.86 | 4.0  | 4.0  | 0.91 | 3.7  | 3.7  | 0.89 | 3.0  | 3.0  | 0.68 |     |      |
|                          |                               |                          | 22                            | 4.8                              | 3.3 | 0.84 | 4.6  | 3.2  | 0.89 | 4.3  | 3.1  | 0.94 | 4.0  | 3.0  | 0.91 | 3.1  | 2.7  | 0.69 |     |      |
|                          |                               | 32                       | 16                            | 4.2                              | 4.2 | 0.79 | 4.0  | 4.0  | 0.84 | 3.7  | 3.7  | 0.89 | 3.4  | 3.4  | 0.88 | 2.8  | 2.8  | 0.68 |     |      |
|                          |                               |                          | 19                            | 4.5                              | 4.5 | 0.81 | 4.3  | 4.3  | 0.86 | 4.0  | 4.0  | 0.91 | 3.7  | 3.7  | 0.89 | 3.0  | 3.0  | 0.68 |     |      |
|                          |                               |                          | 22                            | 4.8                              | 4.1 | 0.84 | 4.6  | 4.1  | 0.89 | 4.3  | 4.0  | 0.94 | 4.0  | 3.9  | 0.91 | 3.1  | 3.1  | 0.69 |     |      |
|                          |                               | S-50PU2E5A<br>U-50PE2E5A | 220V-230V-240V<br>50Hz 1phase | 23                               | 16  | 5.9  | 4.5  | 1.41 | 5.5  | 4.4  | 1.50 | 5.2  | 4.2  | 1.59 | 4.8  | 4.0  | 1.57 | 3.9  | 3.6 | 1.20 |
|                          |                               |                          |                               |                                  | 19  | 6.3  | 3.4  | 1.45 | 6.0  | 3.3  | 1.53 | 5.6  | 3.1  | 1.62 | 5.2  | 3.0  | 1.59 | 4.1  | 2.6 | 1.22 |
|                          |                               |                          |                               |                                  | 22  | 6.8  | 2.4  | 1.49 | 6.4  | 2.2  | 1.58 | 6.1  | 2.1  | 1.67 | 5.5  | 1.9  | 1.62 | 4.4  | 1.5 | 1.23 |
|                          |                               |                          |                               | 25                               | 16  | 5.9  | 5.2  | 1.41 | 5.5  | 5.0  | 1.50 | 5.2  | 4.9  | 1.59 | 4.8  | 4.7  | 1.57 | 3.9  | 3.9 | 1.20 |
|                          |                               |                          |                               |                                  | 19  | 6.3  | 4.1  | 1.45 | 6.0  | 3.9  | 1.53 | 5.6  | 3.8  | 1.62 | 5.2  | 3.6  | 1.59 | 4.1  | 3.2 | 1.22 |
|                          |                               |                          |                               |                                  | 22  | 6.8  | 3.0  | 1.49 | 6.4  | 2.8  | 1.58 | 6.1  | 2.7  | 1.67 | 5.5  | 2.5  | 1.62 | 4.4  | 2.1 | 1.23 |
|                          |                               |                          |                               | 27                               | 16  | 5.9  | 5.9  | 1.41 | 5.5  | 5.5  | 1.50 | 5.2  | 5.2  | 1.59 | 4.8  | 4.8  | 1.57 | 3.9  | 3.9 | 1.20 |
|                          |                               |                          |                               |                                  | 19  | 6.3  | 4.7  | 1.45 | 6.0  | 4.6  | 1.53 | 5.6  | 4.4  | 1.62 | 5.2  | 4.3  | 1.59 | 4.1  | 3.8 | 1.22 |
|                          |                               |                          |                               |                                  | 22  | 6.8  | 3.6  | 1.49 | 6.4  | 3.5  | 1.58 | 6.1  | 3.4  | 1.67 | 5.5  | 3.1  | 1.62 | 4.4  | 2.8 | 1.23 |
| 29                       | 16                            |                          |                               | 5.9                              | 5.9 | 1.41 | 5.5  | 5.5  | 1.50 | 5.2  | 5.2  | 1.59 | 4.8  | 4.8  | 1.57 | 3.9  | 3.9  | 1.20 |     |      |
|                          | 19                            |                          |                               | 6.3                              | 5.3 | 1.45 | 6.0  | 5.2  | 1.53 | 5.6  | 5.1  | 1.62 | 5.2  | 4.9  | 1.59 | 4.1  | 4.1  | 1.22 |     |      |
|                          | 22                            |                          |                               | 6.8                              | 4.3 | 1.49 | 6.4  | 4.1  | 1.58 | 6.1  | 4.0  | 1.67 | 5.5  | 3.8  | 1.62 | 4.4  | 3.4  | 1.23 |     |      |
| 32                       | 16                            |                          |                               | 5.9                              | 5.9 | 1.41 | 5.5  | 5.5  | 1.50 | 5.2  | 5.2  | 1.59 | 4.8  | 4.8  | 1.57 | 3.9  | 3.9  | 1.20 |     |      |
|                          | 19                            |                          |                               | 6.3                              | 6.3 | 1.45 | 6.0  | 6.0  | 1.53 | 5.6  | 5.6  | 1.62 | 5.2  | 5.2  | 1.59 | 4.1  | 4.1  | 1.22 |     |      |
|                          | 22                            |                          |                               | 6.8                              | 5.2 | 1.49 | 6.4  | 5.1  | 1.58 | 6.1  | 4.9  | 1.67 | 5.5  | 4.7  | 1.62 | 4.4  | 4.3  | 1.23 |     |      |
| S-60PU2E5A<br>U-60PE2E5A | 220V-230V-240V<br>50Hz 1phase |                          |                               | 23                               | 16  | 7.1  | 5.6  | 1.81 | 6.8  | 5.4  | 1.98 | 6.5  | 5.3  | 2.14 | 6.1  | 5.1  | 2.08 | 5.0  | 4.6 | 1.38 |
|                          |                               |                          |                               |                                  | 19  | 7.8  | 4.3  | 1.86 | 7.4  | 4.1  | 2.03 | 7.1  | 4.0  | 2.20 | 6.7  | 3.8  | 2.14 | 5.3  | 3.3 | 1.40 |
|                          |                               |                          |                               |                                  | 22  | 8.6  | 3.0  | 1.90 | 8.2  | 2.8  | 2.07 | 7.8  | 2.7  | 2.25 | 7.3  | 2.5  | 2.18 | 5.7  | 2.0 | 1.42 |
|                          |                               |                          |                               | 25                               | 16  | 7.1  | 6.4  | 1.81 | 6.8  | 6.3  | 1.98 | 6.5  | 6.1  | 2.14 | 6.1  | 5.9  | 2.08 | 5.0  | 5.0 | 1.38 |
|                          |                               |                          |                               |                                  | 19  | 7.8  | 5.1  | 1.86 | 7.4  | 4.9  | 2.03 | 7.1  | 4.8  | 2.20 | 6.7  | 4.6  | 2.14 | 5.3  | 4.1 | 1.40 |
|                          |                               |                          |                               |                                  | 22  | 8.6  | 3.8  | 1.90 | 8.2  | 3.6  | 2.07 | 7.8  | 3.5  | 2.25 | 7.3  | 3.3  | 2.18 | 5.7  | 2.8 | 1.42 |
|                          |                               |                          |                               | 27                               | 16  | 7.1  | 7.1  | 1.81 | 6.8  | 6.8  | 1.98 | 6.5  | 6.5  | 2.14 | 6.1  | 6.1  | 2.08 | 5.0  | 5.0 | 1.38 |
|                          |                               |                          |                               |                                  | 19  | 7.8  | 5.9  | 1.86 | 7.4  | 5.7  | 2.03 | 7.1  | 5.6  | 2.20 | 6.7  | 5.4  | 2.14 | 5.3  | 4.9 | 1.40 |
|                          |                               |                          |                               |                                  | 22  | 8.6  | 4.6  | 1.90 | 8.2  | 4.4  | 2.07 | 7.8  | 4.3  | 2.25 | 7.3  | 4.1  | 2.18 | 5.7  | 3.6 | 1.42 |
|                          |                               | 29                       | 16                            | 7.1                              | 7.1 | 1.81 | 6.8  | 6.8  | 1.98 | 6.5  | 6.5  | 2.14 | 6.1  | 6.1  | 2.08 | 5.0  | 5.0  | 1.38 |     |      |
|                          |                               |                          | 19                            | 7.8                              | 6.7 | 1.86 | 7.4  | 6.5  | 2.03 | 7.1  | 6.4  | 2.20 | 6.7  | 6.2  | 2.14 | 5.3  | 5.3  | 1.40 |     |      |
|                          |                               |                          | 22                            | 8.6                              | 5.4 | 1.90 | 8.2  | 5.2  | 2.07 | 7.8  | 5.1  | 2.25 | 7.3  | 4.9  | 2.18 | 5.7  | 4.3  | 1.42 |     |      |
|                          |                               | 32                       | 16                            | 7.1                              | 7.1 | 1.81 | 6.8  | 6.8  | 1.98 | 6.5  | 6.5  | 2.14 | 6.1  | 6.1  | 2.08 | 5.0  | 5.0  | 1.38 |     |      |
|                          |                               |                          | 19                            | 7.8                              | 7.8 | 1.86 | 7.4  | 7.4  | 2.03 | 7.1  | 7.1  | 2.20 | 6.7  | 6.7  | 2.14 | 5.3  | 5.3  | 1.40 |     |      |
|                          |                               |                          | 22                            | 8.6                              | 6.6 | 1.90 | 8.2  | 6.4  | 2.07 | 7.8  | 6.3  | 2.25 | 7.3  | 6.1  | 2.18 | 5.7  | 5.5  | 1.42 |     |      |

## 1-13. Capacity Table

## 1. Cooling Capacity Performance Data

TC :Cooling Capacity

SHC :Sensible Heat Capacity

IPT :Cooling Power Consumption

## • Combination of Single Unit

4-Way Cassette Type

unit : kW

| Model                                       | Power Source  | Ambient Return Air |      | Outdoor air intake temp(°C D.B.) |      |      |      |      |      |      |      |      |      |      |      |      |      |      |
|---|---|--------------------|------|----------------------------------|------|------|------|------|------|------|------|------|------|------|------|------|------|------|
|   |   |                    |      | 25°C                             |      |      | 30°C |      |      | 35°C |      |      | 40°C |      |      | 46°C |      |      |
|   |   | DB                 | WB   | TC                               | SHC  | IPT  | TC   | SHC  | IPT  | TC   | SHC  | IPT  | TC   | SHC  | IPT  | TC   | SHC  | IPT  |
| S-71PU2E5A<br>U-71PE1E5A<br>(U-71PE1E8A)    | 220V-230V-240V<br>50Hz 1phase<br>(380V-400V-415V<br>50Hz 3 phase) | 23                 | 16   | 8.1                              | 6.2  | 2.25 | 7.9  | 6.1  | 2.41 | 7.6  | 5.9  | 2.59 | 7.2  | 5.7  | 2.57 | 6.3  | 5.3  | 2.20 |
|   |   |                    | 19   | 8.5                              | 4.6  | 2.33 | 8.3  | 4.5  | 2.49 | 8.0  | 4.4  | 2.65 | 7.5  | 4.2  | 2.60 | 6.6  | 3.8  | 2.23 |
|   |   |                    | 22   | 9.0                              | 3.1  | 2.44 | 8.7  | 3.0  | 2.58 | 8.3  | 2.9  | 2.73 | 7.8  | 2.7  | 2.62 | 6.8  | 2.3  | 2.25 |
|   |   | 25                 | 16   | 8.1                              | 7.0  | 2.25 | 7.9  | 6.9  | 2.41 | 7.6  | 6.8  | 2.59 | 7.2  | 6.6  | 2.57 | 6.3  | 6.2  | 2.20 |
|   |   |                    | 19   | 8.5                              | 5.5  | 2.33 | 8.3  | 5.4  | 2.49 | 8.0  | 5.2  | 2.65 | 7.5  | 5.0  | 2.60 | 6.6  | 4.7  | 2.23 |
|   |   |                    | 22   | 9.0                              | 4.0  | 2.44 | 8.7  | 3.8  | 2.58 | 8.3  | 3.7  | 2.73 | 7.8  | 3.5  | 2.62 | 6.8  | 3.2  | 2.25 |
|   |   | 27                 | 16   | 8.1                              | 7.9  | 2.25 | 7.9  | 7.8  | 2.41 | 7.6  | 7.6  | 2.59 | 7.2  | 7.2  | 2.57 | 6.3  | 6.3  | 2.20 |
|   |   |                    | 19   | 8.5                              | 6.3  | 2.33 | 8.3  | 6.2  | 2.49 | 8.0  | 6.1  | 2.65 | 7.5  | 5.9  | 2.60 | 6.6  | 5.5  | 2.23 |
|   |   |                    | 22   | 9.0                              | 4.8  | 2.44 | 8.7  | 4.7  | 2.58 | 8.3  | 4.5  | 2.73 | 7.8  | 4.4  | 2.62 | 6.8  | 4.0  | 2.25 |
|   |   | 29                 | 16   | 8.1                              | 8.1  | 2.25 | 7.9  | 7.9  | 2.41 | 7.6  | 7.6  | 2.59 | 7.2  | 7.2  | 2.57 | 6.3  | 6.3  | 2.20 |
|   |   |                    | 19   | 8.5                              | 7.2  | 2.33 | 8.3  | 7.1  | 2.49 | 8.0  | 6.9  | 2.65 | 7.5  | 6.7  | 2.60 | 6.6  | 6.4  | 2.23 |
|   |   |                    | 22   | 9.0                              | 5.7  | 2.44 | 8.7  | 5.5  | 2.58 | 8.3  | 5.4  | 2.73 | 7.8  | 5.2  | 2.62 | 6.8  | 4.9  | 2.25 |
| 32  | 16  | 8.1                | 8.1  | 2.25                             | 7.9  | 7.9  | 2.41 | 7.6  | 7.6  | 2.59 | 7.2  | 7.2  | 2.57 | 6.3  | 6.3  | 2.20 |      |      |
|   | 19  | 8.5                | 8.5  | 2.33                             | 8.3  | 8.3  | 2.49 | 8.0  | 8.0  | 2.65 | 7.5  | 7.5  | 2.60 | 6.6  | 6.6  | 2.23 |      |      |
|   | 22  | 9.0                | 6.9  | 2.44                             | 8.7  | 6.8  | 2.58 | 8.3  | 6.6  | 2.73 | 7.8  | 6.5  | 2.62 | 6.8  | 6.1  | 2.25 |      |      |
| S-100PU2E5A<br>U-100PE1E5A<br>(U-100PE1E8A) | 220V-230V-240V<br>50Hz 1phase<br>(380V-400V-415V<br>50Hz 3 phase) | 23                 | 16   | 11.4                             | 9.2  | 3.00 | 11.4 | 9.2  | 3.23 | 10.9 | 9.0  | 3.43 | 10.2 | 8.6  | 3.57 | 7.4  | 7.4  | 2.92 |
|   |   |                    | 19   | 12.1                             | 6.8  | 3.13 | 12.1 | 6.8  | 3.36 | 11.7 | 6.6  | 3.58 | 10.9 | 6.3  | 3.72 | 7.9  | 5.2  | 3.04 |
|   |   |                    | 22   | 13.3                             | 4.5  | 3.24 | 13.3 | 4.5  | 3.48 | 12.8 | 4.4  | 3.70 | 11.9 | 4.1  | 3.85 | 8.7  | 3.0  | 3.15 |
|   |   | 25                 | 16   | 11.8                             | 10.8 | 3.05 | 11.8 | 10.8 | 3.28 | 11.3 | 10.5 | 3.49 | 10.5 | 10.2 | 3.63 | 7.7  | 7.7  | 2.97 |
|   |   |                    | 19   | 12.6                             | 8.4  | 3.18 | 12.6 | 8.4  | 3.42 | 12.1 | 8.2  | 3.64 | 11.2 | 7.8  | 3.79 | 8.2  | 6.6  | 3.09 |
|   |   |                    | 22   | 13.8                             | 6.1  | 3.29 | 13.8 | 6.1  | 3.54 | 13.2 | 5.9  | 3.77 | 12.3 | 5.6  | 3.92 | 9.0  | 4.5  | 3.20 |
|   |   | 27                 | 16   | 12.2                             | 12.2 | 3.10 | 12.2 | 12.2 | 3.33 | 11.7 | 11.7 | 3.55 | 10.9 | 10.9 | 3.69 | 8.0  | 8.0  | 3.02 |
|   |   |                    | 19   | 13.0                             | 9.9  | 3.24 | 13.0 | 9.9  | 3.48 | 12.5 | 9.7  | 3.70 | 11.6 | 9.3  | 3.85 | 8.5  | 8.1  | 3.15 |
|   |   |                    | 22   | 14.2                             | 7.6  | 3.35 | 14.2 | 7.6  | 3.60 | 13.7 | 7.5  | 3.83 | 12.7 | 7.1  | 3.98 | 9.3  | 5.9  | 3.25 |
|   |   | 29                 | 16   | 12.4                             | 12.4 | 3.11 | 12.4 | 12.4 | 3.34 | 11.9 | 11.9 | 3.56 | 11.0 | 11.0 | 3.70 | 8.1  | 8.1  | 3.02 |
|   |   |                    | 19   | 13.2                             | 11.4 | 3.25 | 13.2 | 11.4 | 3.49 | 12.7 | 11.2 | 3.71 | 11.8 | 10.8 | 3.86 | 8.6  | 8.6  | 3.15 |
|   |   |                    | 22   | 14.5                             | 9.1  | 3.36 | 14.5 | 9.1  | 3.61 | 13.9 | 8.9  | 3.84 | 12.9 | 8.5  | 3.99 | 9.5  | 7.3  | 3.26 |
| 32  | 16  | 12.5               | 12.5 | 3.12                             | 12.5 | 12.5 | 3.35 | 12.1 | 12.1 | 3.56 | 11.2 | 11.2 | 3.71 | 8.2  | 8.2  | 3.03 |      |      |
|   | 19  | 13.4               | 13.4 | 3.25                             | 13.4 | 13.4 | 3.50 | 12.9 | 12.9 | 3.72 | 12.0 | 12.0 | 3.87 | 8.8  | 8.8  | 3.16 |      |      |
|   | 22  | 14.7               | 11.3 | 3.37                             | 14.7 | 11.3 | 3.62 | 14.1 | 11.0 | 3.85 | 13.1 | 10.7 | 4.00 | 9.6  | 9.4  | 3.27 |      |      |
| S-125PU2E5A<br>U-125PE1E5A<br>(U-125PE1E8A) | 220V-230V-240V<br>50Hz 1phase<br>(380V-400V-415V<br>50Hz 3 phase) | 23                 | 16   | 12.7                             | 9.9  | 3.73 | 12.7 | 9.9  | 4.01 | 12.2 | 9.7  | 4.27 | 11.4 | 9.3  | 4.44 | 8.3  | 7.9  | 3.63 |
|   |   |                    | 19   | 13.6                             | 7.4  | 3.89 | 13.6 | 7.4  | 4.18 | 13.1 | 7.2  | 4.45 | 12.2 | 6.9  | 4.63 | 8.9  | 5.6  | 3.78 |
|   |   |                    | 22   | 14.9                             | 5.2  | 4.03 | 14.9 | 5.2  | 4.33 | 14.3 | 4.9  | 4.60 | 13.3 | 4.6  | 4.79 | 9.7  | 3.3  | 3.91 |
|   |   | 25                 | 16   | 13.2                             | 11.6 | 3.80 | 13.2 | 11.6 | 4.08 | 12.7 | 11.3 | 4.34 | 11.8 | 10.9 | 4.51 | 8.6  | 8.6  | 3.69 |
|   |   |                    | 19   | 14.1                             | 9.1  | 3.96 | 14.1 | 9.1  | 4.25 | 13.5 | 8.8  | 4.52 | 12.6 | 8.5  | 4.71 | 9.2  | 7.1  | 3.85 |
|   |   |                    | 22   | 15.4                             | 6.7  | 4.10 | 15.4 | 6.7  | 4.40 | 14.8 | 6.5  | 4.68 | 13.8 | 6.1  | 4.87 | 10.1 | 4.9  | 3.98 |
|   |   | 27                 | 16   | 13.6                             | 13.2 | 3.86 | 13.6 | 13.2 | 4.15 | 13.1 | 13.0 | 4.41 | 12.2 | 12.2 | 4.59 | 8.9  | 8.9  | 3.75 |
|   |   |                    | 19   | 14.6                             | 10.7 | 4.03 | 14.6 | 10.7 | 4.32 | 14.0 | 10.5 | 4.60 | 13.0 | 10.0 | 4.78 | 9.5  | 8.7  | 3.91 |
|   |   |                    | 22   | 16.0                             | 8.4  | 4.16 | 16.0 | 8.4  | 4.47 | 15.3 | 8.1  | 4.76 | 14.3 | 7.7  | 4.95 | 10.4 | 6.4  | 4.05 |
|   |   | 29                 | 16   | 13.8                             | 13.8 | 3.87 | 13.8 | 13.8 | 4.16 | 13.3 | 13.3 | 4.42 | 12.4 | 12.4 | 4.60 | 9.0  | 9.0  | 3.76 |
|   |   |                    | 19   | 14.8                             | 12.2 | 4.03 | 14.8 | 12.2 | 4.33 | 14.2 | 12.0 | 4.61 | 13.2 | 11.6 | 4.80 | 9.7  | 9.7  | 3.92 |
|   |   |                    | 22   | 16.2                             | 9.9  | 4.17 | 16.2 | 9.9  | 4.48 | 15.6 | 9.7  | 4.77 | 14.5 | 9.2  | 4.96 | 10.6 | 7.8  | 4.06 |
| 32  | 16  | 14.0               | 14.0 | 3.88                             | 14.0 | 14.0 | 4.17 | 13.5 | 13.5 | 4.43 | 12.6 | 12.6 | 4.61 | 9.2  | 9.2  | 3.77 |      |      |
|   | 19  | 15.0               | 14.5 | 4.04                             | 15.0 | 14.5 | 4.35 | 14.4 | 14.2 | 4.62 | 13.4 | 13.4 | 4.81 | 9.8  | 9.8  | 3.93 |      |      |
|   | 22  | 16.4               | 12.1 | 4.18                             | 16.4 | 12.1 | 4.50 | 15.8 | 11.9 | 4.78 | 14.7 | 11.5 | 4.97 | 10.7 | 10.0 | 4.07 |      |      |
| S-140PU2E5A<br>U-140PE1E5A<br>(U-140PE1E8A) | 220V-230V-240V<br>50Hz 1phase<br>(380V-400V-415V<br>50Hz 3 phase) | 23                 | 16   | 14.1                             | 10.7 | 4.66 | 14.1 | 10.7 | 5.00 | 13.6 | 10.4 | 5.32 | 12.6 | 10.0 | 5.54 | 9.2  | 8.4  | 4.52 |
|   |   |                    | 19   | 15.1                             | 8.1  | 4.86 | 15.1 | 8.1  | 5.22 | 14.5 | 7.9  | 5.55 | 13.5 | 7.5  | 5.77 | 9.8  | 6.0  | 4.72 |
|   |   |                    | 22   | 16.5                             | 5.7  | 5.03 | 16.5 | 5.7  | 5.40 | 15.9 | 5.5  | 5.74 | 14.8 | 5.1  | 5.97 | 10.8 | 3.7  | 4.88 |
|   |   | 25                 | 16   | 14.6                             | 12.4 | 4.74 | 14.6 | 12.4 | 5.09 | 14.0 | 12.1 | 5.41 | 13.1 | 11.7 | 5.63 | 9.5  | 9.5  | 4.60 |
|   |   |                    | 19   | 15.6                             | 9.8  | 4.94 | 15.6 | 9.8  | 5.31 | 15.0 | 9.6  | 5.65 | 13.9 | 9.1  | 5.87 | 10.2 | 7.6  | 4.80 |
|   |   |                    | 22   | 17.1                             | 7.4  | 5.11 | 17.1 | 7.4  | 5.49 | 16.4 | 7.1  | 5.84 | 15.3 | 6.7  | 6.08 | 11.2 | 5.3  | 4.97 |
|   |   | 27                 | 16   | 15.1                             | 14.1 | 4.81 | 15.1 | 14.1 | 5.17 | 14.5 | 13.8 | 5.50 | 13.5 | 13.4 | 5.72 | 9.9  | 9.9  | 4.68 |
|   |   |                    | 19   | 16.1                             | 11.5 | 5.02 | 16.1 | 11.5 | 5.40 | 15.5 | 11.2 | 5.74 | 14.4 | 10.7 | 5.97 | 10.5 | 9.2  | 4.88 |
|   |   |                    | 22   | 17.7                             | 9.1  | 5.20 | 17.7 | 9.1  | 5.58 | 17.0 | 8.8  | 5.94 | 15.8 | 8.4  | 6.18 | 11.5 | 6.8  | 5.05 |
|   |   | 29                 | 16   | 15.3                             | 15.3 | 4.83 | 15.3 | 15.3 | 5.19 | 14.7 | 14.7 | 5.52 | 13.7 | 13.7 | 5.74 | 10.0 | 10.0 | 4.69 |
|   |   |                    | 19   | 16.4                             | 13.1 | 5.03 | 16.4 | 13.1 | 5.41 | 15.7 | 12.8 | 5.75 | 14.6 | 12.3 | 5.98 | 10.7 | 10.7 | 4.89 |
|   |   |                    | 22   | 17.9                             | 10.7 | 5.21 | 17.9 | 10.7 | 5.60 | 17.2 | 10.4 | 5.95 | 16.0 | 9.9  | 6.19 | 11.7 | 8.3  | 5.06 |
| 32  | 16  | 15.5               | 15.5 | 4.84                             | 15.5 | 15.5 | 5.20 | 14.9 | 14.9 | 5.53 | 13.9 | 13.9 | 5.75 | 10.2 | 10.2 | 4.70 |      |      |
|   | 19  | 16.6               | 15.4 | 5.05                             | 16.6 | 15.4 | 5.42 | 16.0 | 15.2 | 5.77 | 14.8 | 14.6 | 6.00 | 10.9 | 10.9 | 4.90 |      |      |
|   | 22  | 18.2               | 13.0 | 5.22                             | 18.2 | 13.0 | 5.61 | 17.5 | 12.7 | 5.97 | 16.3 | 12.2 | 6.21 | 11.9 | 10.6 | 5.07 |      |      |



1-13. Capacity Table

1. Cooling Capacity Performance Data

TC :Cooling Capacity

SHC :Sensible Heat Capacity

IPT :Cooling Power Consumption

• Combination of Multiple Unit

unit : kW

4-Way Cassette Type

| Model   | Power Source  | Ambient Return Air                            |   | Outdoor air intake temp(°C D.B.) |      |      |      |      |      |      |      |      |      |      |      |      |      |      |     |      |
|---|---|---|---|----------------------------------|------|------|------|------|------|------|------|------|------|------|------|------|------|------|-----|------|
|   |   |   |   | 25°C                             |      |      | 30°C |      |      | 35°C |      |      | 40°C |      |      | 46°C |      |      |     |      |
|   |   | DB  | WB  | TC                               | SHC  | IPT  | TC   | SHC  | IPT  | TC   | SHC  | IPT  | TC   | SHC  | IPT  | TC   | SHC  | IPT  |     |      |
| S-36PU2E5A x2<br>U-71PE1E5A<br>(U-71PE1E8A)   | 220V-230V-240V<br>50Hz 1phase<br>(380V-400V-415V<br>50Hz 3 phase) | 23  | 16  | 8.1                              | 6.9  | 2.25 | 7.9  | 6.8  | 2.41 | 7.6  | 6.7  | 2.59 | 7.2  | 6.5  | 2.57 | 6.3  | 6.1  | 2.20 |     |      |
|   |   |   | 19  | 8.5                              | 5.0  | 2.33 | 8.3  | 4.9  | 2.49 | 8.0  | 4.8  | 2.65 | 7.5  | 4.6  | 2.60 | 6.6  | 4.2  | 2.23 |     |      |
|   |   |   | 22  | 9.0                              | 3.1  | 2.44 | 8.7  | 3.0  | 2.58 | 8.3  | 2.9  | 2.73 | 7.8  | 2.7  | 2.62 | 6.8  | 2.4  | 2.25 |     |      |
|   |   | 25  | 16  | 8.1                              | 8.0  | 2.25 | 7.9  | 7.9  | 2.41 | 7.6  | 7.6  | 2.59 | 7.2  | 7.2  | 2.57 | 6.3  | 6.3  | 2.20 |     |      |
|   |   |   | 19  | 8.5                              | 6.1  | 2.33 | 8.3  | 6.0  | 2.49 | 8.0  | 5.9  | 2.65 | 7.5  | 5.7  | 2.60 | 6.6  | 5.3  | 2.23 |     |      |
|   |   |   | 22  | 9.0                              | 4.2  | 2.44 | 8.7  | 4.1  | 2.58 | 8.3  | 3.9  | 2.73 | 7.8  | 3.8  | 2.62 | 6.8  | 3.4  | 2.25 |     |      |
|   |   | 27  | 16  | 8.1                              | 8.1  | 2.25 | 7.9  | 7.9  | 2.41 | 7.6  | 7.6  | 2.59 | 7.2  | 7.2  | 2.57 | 6.3  | 6.3  | 2.20 |     |      |
|   |   |   | 19  | 8.5                              | 7.2  | 2.33 | 8.3  | 7.1  | 2.49 | 8.0  | 7.0  | 2.65 | 7.5  | 6.8  | 2.60 | 6.6  | 6.5  | 2.23 |     |      |
|   |   |   | 22  | 9.0                              | 5.3  | 2.44 | 8.7  | 5.2  | 2.58 | 8.3  | 5.1  | 2.73 | 7.8  | 4.9  | 2.62 | 6.8  | 4.6  | 2.25 |     |      |
|   |   | 29  | 16  | 8.1                              | 8.1  | 2.25 | 7.9  | 7.9  | 2.41 | 7.6  | 7.6  | 2.59 | 7.2  | 7.2  | 2.57 | 6.3  | 6.3  | 2.20 |     |      |
|   |   |   | 19  | 8.5                              | 8.3  | 2.33 | 8.3  | 8.2  | 2.49 | 8.0  | 8.0  | 2.65 | 7.5  | 7.5  | 2.60 | 6.6  | 6.6  | 2.23 |     |      |
|   |   |   | 22  | 9.0                              | 6.4  | 2.44 | 8.7  | 6.3  | 2.58 | 8.3  | 6.1  | 2.73 | 7.8  | 6.0  | 2.62 | 6.8  | 5.6  | 2.25 |     |      |
|   |   | 32  | 16  | 8.1                              | 8.1  | 2.25 | 7.9  | 7.9  | 2.41 | 7.6  | 7.6  | 2.59 | 7.2  | 7.2  | 2.57 | 6.3  | 6.3  | 2.20 |     |      |
|   |   |   | 19  | 8.5                              | 8.5  | 2.33 | 8.3  | 8.3  | 2.49 | 8.0  | 8.0  | 2.65 | 7.5  | 7.5  | 2.60 | 6.6  | 6.6  | 2.23 |     |      |
|   |   |   | 22  | 9.0                              | 8.0  | 2.44 | 8.7  | 7.9  | 2.58 | 8.3  | 7.8  | 2.73 | 7.8  | 7.6  | 2.62 | 6.8  | 6.8  | 2.25 |     |      |
|   |   | S-36PU2E5A x3<br>U-100PE1E5A<br>(U-100PE1E8A) | 220V-230V-240V<br>50Hz 1phase<br>(380V-400V-415V<br>50Hz 3 phase) | 23                               | 16   | 11.4 | 10.0 | 3.00 | 11.4 | 10.0 | 3.23 | 10.9 | 9.8  | 3.43 | 10.2 | 9.5  | 3.57 | 7.4  | 7.4 | 2.92 |
|   |   |   |   |                                  | 19   | 12.1 | 7.2  | 3.13 | 12.1 | 7.2  | 3.36 | 11.7 | 7.0  | 3.58 | 10.9 | 6.8  | 3.72 | 7.9  | 5.6 | 3.04 |
|   |   |   |   |                                  | 22   | 13.3 | 4.5  | 3.24 | 13.3 | 4.6  | 3.48 | 12.8 | 4.4  | 3.70 | 11.9 | 4.1  | 3.85 | 8.7  | 3.0 | 3.15 |
|   |   |   |   | 25                               | 16   | 11.8 | 11.8 | 3.05 | 11.8 | 11.8 | 3.28 | 11.3 | 11.3 | 3.49 | 10.5 | 10.5 | 3.63 | 7.7  | 7.7 | 2.97 |
|   |   |   |   |                                  | 19   | 12.6 | 9.0  | 3.18 | 12.6 | 9.1  | 3.42 | 12.1 | 8.9  | 3.64 | 11.2 | 8.5  | 3.79 | 8.2  | 7.3 | 3.09 |
|   |   |   |   |                                  | 22   | 13.8 | 6.4  | 3.29 | 13.8 | 6.4  | 3.54 | 13.2 | 6.2  | 3.77 | 12.3 | 5.9  | 3.92 | 9.0  | 4.8 | 3.20 |
|   |   |   |   | 27                               | 16   | 12.2 | 12.2 | 3.10 | 12.2 | 12.2 | 3.33 | 11.7 | 11.7 | 3.55 | 10.9 | 10.9 | 3.69 | 8.0  | 8.0 | 3.02 |
|   |   |   |   |                                  | 19   | 13.0 | 10.9 | 3.24 | 13.0 | 10.9 | 3.48 | 12.5 | 10.7 | 3.70 | 11.6 | 10.3 | 3.85 | 8.5  | 8.5 | 3.15 |
|   |   |   |   |                                  | 22   | 14.2 | 8.2  | 3.35 | 14.2 | 8.2  | 3.60 | 13.7 | 8.0  | 3.83 | 12.7 | 7.7  | 3.98 | 9.3  | 6.5 | 3.25 |
| 29  | 16  |   |   | 12.4                             | 12.4 | 3.11 | 12.4 | 12.4 | 3.34 | 11.9 | 11.9 | 3.56 | 11.0 | 11.0 | 3.70 | 8.1  | 8.1  | 3.02 |     |      |
|   | 19  |   |   | 13.2                             | 12.6 | 3.25 | 13.2 | 12.6 | 3.49 | 12.7 | 12.4 | 3.71 | 11.8 | 11.8 | 3.86 | 8.6  | 8.6  | 3.15 |     |      |
|   | 22  |   |   | 14.5                             | 9.9  | 3.36 | 14.5 | 9.9  | 3.61 | 13.9 | 9.7  | 3.84 | 12.9 | 9.4  | 3.99 | 9.5  | 8.2  | 3.26 |     |      |
| 32  | 16  |   |   | 12.5                             | 12.5 | 3.12 | 12.5 | 12.5 | 3.35 | 12.1 | 12.1 | 3.56 | 11.2 | 11.2 | 3.71 | 8.2  | 8.2  | 3.03 |     |      |
|   | 19  |   |   | 13.4                             | 13.4 | 3.25 | 13.4 | 13.4 | 3.50 | 12.9 | 12.9 | 3.72 | 12.0 | 12.0 | 3.87 | 8.8  | 8.8  | 3.16 |     |      |
|   | 22  |   |   | 14.7                             | 12.5 | 3.37 | 14.7 | 12.5 | 3.62 | 14.1 | 12.3 | 3.85 | 13.1 | 11.9 | 4.00 | 9.6  | 9.6  | 3.27 |     |      |
| S-50PU2E5A x2<br>U-100PE1E5A<br>(U-100PE1E8A) | 220V-230V-240V<br>50Hz 1phase<br>(380V-400V-415V<br>50Hz 3 phase) |   |   | 23                               | 16   | 11.4 | 8.9  | 3.00 | 11.4 | 8.9  | 3.23 | 10.9 | 8.7  | 3.43 | 10.2 | 8.3  | 3.57 | 7.4  | 7.1 | 2.92 |
|   |   |   |   |                                  | 19   | 12.1 | 6.6  | 3.13 | 12.1 | 6.6  | 3.36 | 11.7 | 6.5  | 3.58 | 10.9 | 6.2  | 3.72 | 7.9  | 5.0 | 3.04 |
|   |   |   |   |                                  | 22   | 13.3 | 4.6  | 3.24 | 13.3 | 4.6  | 3.48 | 12.8 | 4.4  | 3.70 | 11.9 | 4.1  | 3.85 | 8.7  | 3.0 | 3.15 |
|   |   |   |   | 25                               | 16   | 11.8 | 10.4 | 3.05 | 11.8 | 10.4 | 3.28 | 11.3 | 10.1 | 3.49 | 10.5 | 9.8  | 3.63 | 7.7  | 7.7 | 2.97 |
|   |   |   |   |                                  | 19   | 12.6 | 8.1  | 3.18 | 12.6 | 8.1  | 3.42 | 12.1 | 7.9  | 3.64 | 11.2 | 7.5  | 3.79 | 8.2  | 6.4 | 3.09 |
|   |   |   |   |                                  | 22   | 13.8 | 6.1  | 3.29 | 13.8 | 6.1  | 3.54 | 13.2 | 5.9  | 3.77 | 12.3 | 5.5  | 3.92 | 9.0  | 4.4 | 3.20 |
|   |   |   |   | 27                               | 16   | 12.2 | 11.9 | 3.10 | 12.2 | 11.9 | 3.33 | 11.7 | 11.6 | 3.55 | 10.9 | 10.9 | 3.69 | 8.0  | 8.0 | 3.02 |
|   |   |   |   |                                  | 19   | 13.0 | 9.6  | 3.24 | 13.0 | 9.6  | 3.48 | 12.5 | 9.4  | 3.70 | 11.6 | 9.0  | 3.85 | 8.5  | 7.7 | 3.15 |
|   |   |   |   |                                  | 22   | 14.2 | 7.5  | 3.35 | 14.2 | 7.5  | 3.60 | 13.7 | 7.3  | 3.83 | 12.7 | 6.9  | 3.98 | 9.3  | 5.7 | 3.25 |
|   |   | 29  | 16  | 12.4                             | 12.4 | 3.11 | 12.4 | 12.4 | 3.34 | 11.9 | 11.9 | 3.56 | 11.0 | 11.0 | 3.70 | 8.1  | 8.1  | 3.02 |     |      |
|   |   |   | 19  | 13.2                             | 11.0 | 3.25 | 13.2 | 11.0 | 3.49 | 12.7 | 10.7 | 3.71 | 11.8 | 10.4 | 3.86 | 8.6  | 8.6  | 3.15 |     |      |
|   |   |   | 22  | 14.5                             | 8.9  | 3.36 | 14.5 | 8.9  | 3.61 | 13.9 | 8.6  | 3.84 | 12.9 | 8.2  | 3.99 | 9.5  | 7.0  | 3.26 |     |      |
|   |   | 32  | 16  | 12.5                             | 12.5 | 3.12 | 12.5 | 12.5 | 3.35 | 12.1 | 12.1 | 3.56 | 11.2 | 11.2 | 3.71 | 8.2  | 8.2  | 3.03 |     |      |
|   |   |   | 19  | 13.4                             | 13.0 | 3.25 | 13.4 | 13.0 | 3.50 | 12.9 | 12.7 | 3.72 | 12.0 | 12.0 | 3.87 | 8.8  | 8.8  | 3.16 |     |      |
|   |   |   | 22  | 14.7                             | 10.8 | 3.37 | 14.7 | 10.8 | 3.62 | 14.1 | 10.6 | 3.85 | 13.1 | 10.2 | 4.00 | 9.6  | 8.9  | 3.27 |     |      |
|   |   | S-36PU2E5A x4<br>U-125PE1E5A<br>(U-125PE1E8A) | 220V-230V-240V<br>50Hz 1phase<br>(380V-400V-415V<br>50Hz 3 phase) | 23                               | 16   | 12.7 | 12.2 | 3.73 | 12.7 | 12.2 | 4.01 | 12.2 | 12.0 | 4.27 | 11.4 | 11.4 | 4.44 | 8.3  | 8.3 | 3.63 |
|   |   |   |   |                                  | 19   | 13.6 | 8.6  | 3.89 | 13.6 | 8.6  | 4.18 | 13.1 | 8.4  | 4.45 | 12.2 | 8.1  | 4.63 | 8.9  | 6.9 | 3.78 |
|   |   |   |   |                                  | 22   | 14.9 | 5.1  | 4.03 | 14.9 | 5.1  | 4.33 | 14.3 | 4.9  | 4.60 | 13.3 | 4.6  | 4.79 | 9.7  | 3.5 | 3.91 |
|   |   |   |   | 25                               | 16   | 13.2 | 13.2 | 3.80 | 13.2 | 13.2 | 4.08 | 12.7 | 12.7 | 4.34 | 11.8 | 11.8 | 4.51 | 8.6  | 8.6 | 3.69 |
|   |   |   |   |                                  | 19   | 14.1 | 11.0 | 3.96 | 14.1 | 11.0 | 4.25 | 13.5 | 10.8 | 4.52 | 12.6 | 10.5 | 4.71 | 9.2  | 9.2 | 3.85 |
|   |   |   |   |                                  | 22   | 15.4 | 7.5  | 4.10 | 15.4 | 7.5  | 4.40 | 14.8 | 7.3  | 4.68 | 13.8 | 6.9  | 4.87 | 10.1 | 5.8 | 3.98 |
|   |   |   |   | 27                               | 16   | 13.6 | 13.6 | 3.86 | 13.6 | 13.6 | 4.15 | 13.1 | 13.1 | 4.41 | 12.2 | 12.2 | 4.59 | 8.9  | 8.9 | 3.75 |
|   |   |   |   |                                  | 19   | 14.6 | 13.4 | 4.03 | 14.6 | 13.4 | 4.32 | 14.0 | 13.2 | 4.60 | 13.0 | 12.8 | 4.78 | 9.5  | 9.5 | 3.91 |
|   |   |   |   |                                  | 22   | 16.0 | 9.9  | 4.16 | 16.0 | 9.9  | 4.47 | 15.3 | 9.6  | 4.76 | 14.3 | 9.3  | 4.95 | 10.4 | 8.1 | 4.05 |
| 29  | 16  |   |   | 13.8                             | 13.8 | 3.87 | 13.8 | 13.8 | 4.16 | 13.3 | 13.3 | 4.42 | 12.4 | 12.4 | 4.60 | 9.0  | 9.0  | 3.76 |     |      |
|   | 19  |   |   | 14.8                             | 14.8 | 4.03 | 14.8 | 14.8 | 4.33 | 14.2 | 14.2 | 4.61 | 13.2 | 13.2 | 4.80 | 9.7  | 9.7  | 3.92 |     |      |
|   | 22  |   |   | 16.2                             | 12.1 | 4.17 | 16.2 | 12.1 | 4.48 | 15.6 | 11.9 | 4.77 | 14.5 | 11.6 | 4.96 | 10.6 | 10.3 | 4.06 |     |      |
| 32  | 16  |   |   | 14.0                             | 14.0 | 3.88 | 14.0 | 14.0 | 4.17 | 13.5 | 13.5 | 4.43 | 12.6 | 12.6 | 4.61 | 9.2  | 9.2  | 3.77 |     |      |
|   | 19  |   |   | 15.0                             | 15.0 | 4.04 | 15.0 | 15.0 | 4.35 | 14.4 | 14.4 | 4.62 | 13.4 | 13.4 | 4.81 | 9.8  | 9.8  | 3.93 |     |      |
|   | 22  |   |   | 16.4                             | 15.5 | 4.18 | 16.4 | 15.5 | 4.50 | 15.8 | 15.3 | 4.78 | 14.7 | 14.7 | 4.97 | 10.7 | 10.7 | 4.07 |     |      |
| S-45PU2E5A x3<br>U-125PE1E5A<br>(U-125PE1E8A) | 220V-230V-240V<br>50Hz 1phase<br>(380V-400V-415V<br>50Hz 3 phase) |   |   | 23                               | 16   | 12.7 | 11.0 | 3.73 | 12.7 | 11.0 | 4.01 | 12.2 | 10.7 | 4.27 | 11.4 | 10.4 | 4.44 | 8.3  | 8.3 | 3.63 |
|   |   |   |   |                                  | 19   | 13.6 | 7.9  | 3.89 | 13.6 | 7.9  | 4.18 | 13.1 | 7.8  | 4.45 | 12.2 | 7.4  | 4.63 | 8.9  | 6.1 | 3.78 |
|   |   |   |   |                                  | 22   | 14.9 | 5.1  | 4.03 | 14.9 | 5.1  | 4.33 | 14.3 | 4.9  | 4.60 | 13.3 | 4.6  | 4.79 | 9.7  | 3.4 | 3.91 |
|   |   |   |   | 25                               | 16   | 13.2 | 13.0 | 3.80 | 13.2 | 13.0 | 4.08 | 12.7 | 12.7 | 4.34 | 11.8 | 11.8 | 4.51 | 8.6  | 8.6 | 3.69 |
|   |   |   |   |                                  | 19   | 14.1 | 9.9  | 3.96 | 14.1 | 9.9  | 4.25 | 13.5 | 9.7  | 4.52 | 12.6 | 9.3  | 4.71 | 9.2  | 8.0 | 3.85 |
|   |   |   |   |                                  | 22   | 15.4 | 7.0  | 4.10 | 15.4 | 7.0  | 4.40 | 14.8 | 6.9  | 4.68 | 13.8 | 6.5  | 4.87 | 10.1 | 5.3 | 3.98 |
|   |   |   |   | 27                               | 16   | 13.6 | 13.6 | 3.86 | 13.6 | 13.6 | 4.15 | 13.1 | 13.1 | 4.41 | 12.2 | 12.2 | 4.59 | 8.9  | 8.9 | 3.75 |
|   |   |   |   |                                  | 19   | 14.6 | 11.9 | 4.03 | 14.6 | 11.9 | 4.32 | 14.0 | 11.7 | 4.60 | 13.0 | 11.3 | 4.78 | 9.5  | 9.5 | 3.91 |
|   |   |   |   |                                  | 22   | 16.0 | 9.0  | 4.16 | 16.0 | 9.0  | 4.47 | 15.3 | 8.8  | 4.76 | 14.3 | 8.4  | 4.95 | 10.4 | 7.1 | 4.05 |
|   |   | 29  | 16  | 13.8                             | 13.8 | 3.87 | 13.8 | 13.8 | 4.16 | 13.3 | 13.3 | 4.42 | 12.4 | 12.4 | 4.60 | 9.0  | 9.0  | 3.76 |     |      |
|   |   |   | 19  | 14.8                             | 13.8 | 4.03 | 14.8 | 13.8 | 4.33 | 14.2 | 13.6 | 4.61 | 13.2 | 13.2 | 4.80 | 9.7  | 9.7  | 3.92 |     |      |
|   |   |   | 22  | 16.2                             | 10.9 | 4.17 | 16.2 | 10.9 | 4.48 | 15.6 | 10.7 | 4.77 | 14.5 | 10.3 | 4.96 | 10.6 | 8.9  | 4.06 |     |      |
|   |   | 32  | 16  | 14.0                             | 14.0 | 3.88 | 14.0 | 14.0 | 4.17 | 13.5 | 13.5 | 4.43 | 12.6 | 12.6 | 4.61 | 9.2  | 9.2  | 3.77 |     |      |
|   |   |   | 19  | 15.0                             | 15.0 | 4.04 | 15.0 | 15.0 | 4.35 | 14.4 | 14.4 | 4.62 | 13.4 | 13.4 | 4.81 | 9.8  | 9.8  | 3.93 |     |      |
|   |   |   | 22  | 16.4                             | 13.6 | 4.18 | 16.4 | 13.6 | 4.50 | 15.8 | 13.4 | 4.78 | 14.7 |      |      |      |      |      |     |      |

## 1-13. Capacity Table

## 1. Cooling Capacity Performance Data

TC :Cooling Capacity

SHC :Sensible Heat Capacity

IPT :Cooling Power Consumption

## • Combination of Multiple Unit

unit : kW

## 4-Way Cassette Type

| Model  | Power Source  | Ambient Return Air                           |   | Outdoor air intake temp(°C D.B.) |      |      |      |      |      |      |      |      |      |      |      |      |      |      |     |      |
|--|---|--|---|----------------------------------|------|------|------|------|------|------|------|------|------|------|------|------|------|------|-----|------|
|  |   |  |   | 25°C                             |      |      | 30°C |      |      | 35°C |      |      | 40°C |      |      | 46°C |      |      |     |      |
|  |   | DB   | WB  | TC                               | SHC  | IPT  | TC   | SHC  | IPT  | TC   | SHC  | IPT  | TC   | SHC  | IPT  | TC   | SHC  | IPT  |     |      |
| S-60PU2E5A×2<br>U-125PE1E5A<br>(U-125PE1E8A) | 220V-230V-240V<br>50Hz 1phase<br>(380V-400V-415V<br>50Hz 3 phase) | 23   | 16  | 12.7                             | 10.5 | 3.73 | 12.7 | 10.5 | 4.01 | 12.2 | 10.2 | 4.27 | 11.4 | 9.9  | 4.44 | 8.3  | 8.3  | 3.63 |     |      |
|  |   |  | 19  | 13.6                             | 7.7  | 3.89 | 13.6 | 7.7  | 4.18 | 13.1 | 7.5  | 4.45 | 12.2 | 7.1  | 4.63 | 8.9  | 5.9  | 3.78 |     |      |
|  |   |  | 22  | 14.9                             | 5.1  | 4.03 | 14.9 | 5.1  | 4.33 | 14.3 | 4.9  | 4.60 | 13.3 | 4.5  | 4.79 | 9.7  | 3.3  | 3.91 |     |      |
|  |   | 25   | 16  | 13.2                             | 12.3 | 3.80 | 13.2 | 12.3 | 4.08 | 12.7 | 12.1 | 4.34 | 11.8 | 11.7 | 4.51 | 8.6  | 8.6  | 3.69 |     |      |
|  |   |  | 19  | 14.1                             | 9.5  | 3.96 | 14.1 | 9.5  | 4.25 | 13.5 | 9.3  | 4.52 | 12.6 | 8.9  | 4.71 | 9.2  | 7.6  | 3.85 |     |      |
|  |   |  | 22  | 15.4                             | 6.9  | 4.10 | 15.4 | 6.9  | 4.40 | 14.8 | 6.7  | 4.68 | 13.8 | 6.3  | 4.87 | 10.1 | 5.1  | 3.98 |     |      |
|  |   | 27   | 16  | 13.6                             | 13.6 | 3.86 | 13.6 | 13.6 | 4.15 | 13.1 | 13.1 | 4.41 | 12.2 | 12.2 | 4.59 | 8.9  | 8.9  | 3.75 |     |      |
|  |   |  | 19  | 14.6                             | 11.4 | 4.03 | 14.6 | 11.4 | 4.32 | 14.0 | 11.1 | 4.60 | 13.0 | 10.7 | 4.78 | 9.5  | 9.3  | 3.91 |     |      |
|  |   |  | 22  | 16.0                             | 8.7  | 4.16 | 16.0 | 8.7  | 4.47 | 15.3 | 8.5  | 4.76 | 14.3 | 8.1  | 4.95 | 10.4 | 6.8  | 4.05 |     |      |
|  |   | 29   | 16  | 13.8                             | 13.8 | 3.87 | 13.8 | 13.8 | 4.16 | 13.3 | 13.3 | 4.42 | 12.4 | 12.4 | 4.60 | 9.0  | 9.0  | 3.76 |     |      |
|  |   |  | 19  | 14.8                             | 13.0 | 4.03 | 14.8 | 13.0 | 4.33 | 14.2 | 12.8 | 4.61 | 13.2 | 12.4 | 4.80 | 9.7  | 9.7  | 3.92 |     |      |
|  |   |  | 22  | 16.2                             | 10.4 | 4.17 | 16.2 | 10.4 | 4.48 | 15.6 | 10.2 | 4.77 | 14.5 | 9.8  | 4.96 | 10.6 | 8.4  | 4.06 |     |      |
|  |   | 32   | 16  | 14.0                             | 14.0 | 3.88 | 14.0 | 14.0 | 4.17 | 13.5 | 13.5 | 4.43 | 12.6 | 12.6 | 4.61 | 9.2  | 9.2  | 3.77 |     |      |
|  |   |  | 19  | 15.0                             | 15.0 | 4.04 | 15.0 | 15.0 | 4.35 | 14.4 | 14.4 | 4.62 | 13.4 | 13.4 | 4.81 | 9.8  | 9.8  | 3.93 |     |      |
|  |   |  | 22  | 16.4                             | 12.9 | 4.18 | 16.4 | 12.9 | 4.50 | 15.8 | 12.6 | 4.78 | 14.7 | 12.3 | 4.97 | 10.7 | 10.7 | 4.07 |     |      |
|  |   | S-50PU2E5A×3<br>U-140PE1E5A<br>(U-140PE1E8A) | 220V-230V-240V<br>50Hz 1phase<br>(380V-400V-415V<br>50Hz 3 phase) | 23                               | 16   | 14.1 | 11.9 | 4.66 | 14.1 | 11.9 | 5.00 | 13.6 | 11.7 | 5.32 | 12.6 | 11.2 | 5.54 | 9.2  | 9.2 | 4.52 |
|  |   |  |   |                                  | 19   | 15.1 | 8.7  | 4.86 | 15.1 | 8.7  | 5.22 | 14.5 | 8.5  | 5.55 | 13.5 | 8.1  | 5.77 | 9.8  | 6.6 | 4.72 |
|  |   |  |   |                                  | 22   | 16.5 | 5.6  | 5.03 | 16.5 | 5.6  | 5.40 | 15.9 | 5.4  | 5.74 | 14.8 | 5.1  | 5.97 | 10.8 | 3.7 | 4.88 |
| 25   | 16  |  |   | 14.6                             | 14.1 | 4.74 | 14.6 | 14.1 | 5.09 | 14.0 | 13.8 | 5.41 | 13.1 | 13.1 | 5.63 | 9.5  | 9.5  | 4.60 |     |      |
|  | 19  |  |   | 15.6                             | 10.8 | 4.94 | 15.6 | 10.8 | 5.31 | 15.0 | 10.6 | 5.65 | 13.9 | 10.1 | 5.87 | 10.2 | 8.7  | 4.80 |     |      |
|  | 22  |  |   | 17.1                             | 7.7  | 5.11 | 17.1 | 7.7  | 5.49 | 16.4 | 7.5  | 5.84 | 15.3 | 7.1  | 6.08 | 11.2 | 5.7  | 4.97 |     |      |
| 27   | 16  |  |   | 15.1                             | 15.1 | 4.81 | 15.1 | 15.1 | 5.17 | 14.5 | 14.5 | 5.50 | 13.5 | 13.5 | 5.72 | 9.9  | 9.9  | 4.68 |     |      |
|  | 19  |  |   | 16.1                             | 12.9 | 5.02 | 16.1 | 12.9 | 5.40 | 15.5 | 12.7 | 5.74 | 14.4 | 12.2 | 5.97 | 10.5 | 10.5 | 4.88 |     |      |
|  | 22  |  |   | 17.7                             | 9.8  | 5.20 | 17.7 | 9.8  | 5.58 | 17.0 | 9.6  | 5.94 | 15.8 | 9.2  | 6.18 | 11.5 | 7.7  | 5.05 |     |      |
| 29   | 16  |  |   | 15.3                             | 15.3 | 4.83 | 15.3 | 15.3 | 5.19 | 14.7 | 14.7 | 5.52 | 13.7 | 13.7 | 5.74 | 10.0 | 10.0 | 4.69 |     |      |
|  | 19  |  |   | 16.4                             | 14.9 | 5.03 | 16.4 | 14.9 | 5.41 | 15.7 | 14.6 | 5.75 | 14.6 | 14.2 | 5.98 | 10.7 | 10.7 | 4.89 |     |      |
|  | 22  |  |   | 17.9                             | 11.8 | 5.21 | 17.9 | 11.8 | 5.60 | 17.2 | 11.5 | 5.95 | 16.0 | 11.1 | 6.19 | 11.7 | 9.7  | 5.06 |     |      |
| 32   | 16  |  |   | 15.5                             | 15.5 | 4.84 | 15.5 | 15.5 | 5.20 | 14.9 | 14.9 | 5.53 | 13.9 | 13.9 | 5.75 | 10.2 | 10.2 | 4.70 |     |      |
|  | 19  |  |   | 16.6                             | 16.6 | 5.05 | 16.6 | 16.6 | 5.42 | 16.0 | 16.0 | 5.77 | 14.8 | 14.8 | 6.00 | 10.9 | 10.9 | 4.90 |     |      |
|  | 22  |  |   | 18.2                             | 14.7 | 5.22 | 18.2 | 14.7 | 5.61 | 17.5 | 14.5 | 5.97 | 16.3 | 14.0 | 6.21 | 11.9 | 11.9 | 5.07 |     |      |
| S-71PU2E5A×2<br>U-140PE1E5A<br>(U-140PE1E8A) | 220V-230V-240V<br>50Hz 1phase<br>(380V-400V-415V<br>50Hz 3 phase) |  |   | 23                               | 16   | 14.1 | 11.3 | 4.66 | 14.1 | 11.3 | 5.00 | 13.6 | 11.1 | 5.32 | 12.6 | 10.6 | 5.54 | 9.2  | 9.1 | 4.52 |
|  |   |  |   |                                  | 19   | 15.1 | 8.4  | 4.86 | 15.1 | 8.4  | 5.22 | 14.5 | 8.2  | 5.55 | 13.5 | 7.8  | 5.77 | 9.8  | 6.4 | 4.72 |
|  |   |  |   |                                  | 22   | 16.5 | 5.7  | 5.03 | 16.5 | 5.7  | 5.40 | 15.9 | 5.5  | 5.74 | 14.8 | 5.1  | 5.97 | 10.8 | 3.7 | 4.88 |
|  |   | 25   | 16  | 14.6                             | 13.3 | 4.74 | 14.6 | 13.3 | 5.09 | 14.0 | 13.0 | 5.41 | 13.1 | 12.6 | 5.63 | 9.5  | 9.5  | 4.60 |     |      |
|  |   |  | 19  | 15.6                             | 10.3 | 4.94 | 15.6 | 10.3 | 5.31 | 15.0 | 10.1 | 5.65 | 13.9 | 9.6  | 5.87 | 10.2 | 8.2  | 4.80 |     |      |
|  |   |  | 22  | 17.1                             | 7.6  | 5.11 | 17.1 | 7.6  | 5.49 | 16.4 | 7.3  | 5.84 | 15.3 | 6.9  | 6.08 | 11.2 | 5.5  | 4.97 |     |      |
|  |   | 27   | 16  | 15.1                             | 15.1 | 4.81 | 15.1 | 15.1 | 5.17 | 14.5 | 14.5 | 5.50 | 13.5 | 13.5 | 5.72 | 9.9  | 9.9  | 4.68 |     |      |
|  |   |  | 19  | 16.1                             | 12.2 | 5.02 | 16.1 | 12.2 | 5.40 | 15.5 | 12.0 | 5.74 | 14.4 | 11.5 | 5.97 | 10.5 | 10.0 | 4.88 |     |      |
|  |   |  | 22  | 17.7                             | 9.5  | 5.20 | 17.7 | 9.5  | 5.58 | 17.0 | 9.2  | 5.94 | 15.8 | 8.8  | 6.18 | 11.5 | 7.3  | 5.05 |     |      |
|  |   | 29   | 16  | 15.3                             | 15.3 | 4.83 | 15.3 | 15.3 | 5.19 | 14.7 | 14.7 | 5.52 | 13.7 | 13.7 | 5.74 | 10.0 | 10.0 | 4.69 |     |      |
|  |   |  | 19  | 16.4                             | 14.1 | 5.03 | 16.4 | 14.1 | 5.41 | 15.7 | 13.8 | 5.75 | 14.6 | 13.3 | 5.98 | 10.7 | 10.7 | 4.89 |     |      |
|  |   |  | 22  | 17.9                             | 11.3 | 5.21 | 17.9 | 11.3 | 5.60 | 17.2 | 11.0 | 5.95 | 16.0 | 10.5 | 6.19 | 11.7 | 9.0  | 5.06 |     |      |
|  |   | 32   | 16  | 15.5                             | 15.5 | 4.84 | 15.5 | 15.5 | 5.20 | 14.9 | 14.9 | 5.53 | 13.9 | 13.9 | 5.75 | 10.2 | 10.2 | 4.70 |     |      |
|  |   |  | 19  | 16.6                             | 16.6 | 5.05 | 16.6 | 16.6 | 5.42 | 16.0 | 16.0 | 5.77 | 14.8 | 14.8 | 6.00 | 10.9 | 10.9 | 4.90 |     |      |
|  |   |  | 22  | 18.2                             | 13.9 | 5.22 | 18.2 | 13.9 | 5.61 | 17.5 | 13.7 | 5.97 | 16.3 | 13.1 | 6.21 | 11.9 | 11.6 | 5.07 |     |      |

1-13. Capacity Table

1. Cooling Capacity Performance Data

TC :Cooling Capacity

SHC :Sensible Heat Capacity

IPT :Cooling Power Consumption

• Combination of Single Unit

unit : kW

Ceiling Type

| Model                    | Power Source                  | Ambient Return Air       |                               | Outdoor air intake temp(°C D.B.) |     |      |      |      |      |      |      |      |      |      |      |      |      |      |     |      |
|--------------------------|-------------------------------|--------------------------|-------------------------------|----------------------------------|-----|------|------|------|------|------|------|------|------|------|------|------|------|------|-----|------|
|                          |                               |                          |                               | 25°C                             |     |      | 30°C |      |      | 35°C |      |      | 40°C |      |      | 46°C |      |      |     |      |
|                          |                               | DB                       | WB                            | TC                               | SHC | IPT  | TC   | SHC  | IPT  | TC   | SHC  | IPT  | TC   | SHC  | IPT  | TC   | SHC  | IPT  |     |      |
| S-36PT2E5A<br>U-36PE2E5A | 220V-230V-240V<br>50Hz 1phase | 23                       | 16                            | 4.2                              | 3.4 | 0.78 | 4.0  | 3.3  | 0.82 | 3.7  | 3.2  | 0.87 | 3.4  | 3.1  | 0.86 | 2.8  | 2.8  | 0.66 |     |      |
|                          |                               |                          | 19                            | 4.5                              | 2.5 | 0.79 | 4.3  | 2.4  | 0.84 | 4.0  | 2.3  | 0.89 | 3.7  | 2.2  | 0.87 | 3.0  | 1.9  | 0.67 |     |      |
|                          |                               |                          | 22                            | 4.8                              | 1.7 | 0.82 | 4.6  | 1.6  | 0.87 | 4.3  | 1.5  | 0.91 | 4.0  | 1.4  | 0.89 | 3.1  | 1.1  | 0.67 |     |      |
|                          |                               | 25                       | 16                            | 4.2                              | 3.9 | 0.78 | 4.0  | 3.8  | 0.82 | 3.7  | 3.7  | 0.87 | 3.4  | 3.4  | 0.86 | 2.8  | 2.8  | 0.66 |     |      |
|                          |                               |                          | 19                            | 4.5                              | 3.0 | 0.79 | 4.3  | 3.0  | 0.84 | 4.0  | 2.8  | 0.89 | 3.7  | 2.7  | 0.87 | 3.0  | 2.5  | 0.67 |     |      |
|                          |                               |                          | 22                            | 4.8                              | 2.2 | 0.82 | 4.6  | 2.1  | 0.87 | 4.3  | 2.0  | 0.91 | 4.0  | 1.9  | 0.89 | 3.1  | 1.6  | 0.67 |     |      |
|                          |                               | 27                       | 16                            | 4.2                              | 4.2 | 0.78 | 4.0  | 4.0  | 0.82 | 3.7  | 3.7  | 0.87 | 3.4  | 3.4  | 0.86 | 2.8  | 2.8  | 0.66 |     |      |
|                          |                               |                          | 19                            | 4.5                              | 3.6 | 0.79 | 4.3  | 3.5  | 0.84 | 4.0  | 3.4  | 0.89 | 3.7  | 3.2  | 0.87 | 3.0  | 3.0  | 0.67 |     |      |
|                          |                               |                          | 22                            | 4.8                              | 2.7 | 0.82 | 4.6  | 2.6  | 0.87 | 4.3  | 2.5  | 0.91 | 4.0  | 2.4  | 0.89 | 3.1  | 2.1  | 0.67 |     |      |
|                          |                               | 29                       | 16                            | 4.2                              | 4.2 | 0.78 | 4.0  | 4.0  | 0.82 | 3.7  | 3.7  | 0.87 | 3.4  | 3.4  | 0.86 | 2.8  | 2.8  | 0.66 |     |      |
|                          |                               |                          | 19                            | 4.5                              | 4.1 | 0.79 | 4.3  | 4.0  | 0.84 | 4.0  | 3.9  | 0.89 | 3.7  | 3.7  | 0.87 | 3.0  | 3.0  | 0.67 |     |      |
|                          |                               |                          | 22                            | 4.8                              | 3.2 | 0.82 | 4.6  | 3.1  | 0.87 | 4.3  | 3.0  | 0.91 | 4.0  | 2.9  | 0.89 | 3.1  | 2.6  | 0.67 |     |      |
|                          |                               | 32                       | 16                            | 4.2                              | 4.2 | 0.78 | 4.0  | 4.0  | 0.82 | 3.7  | 3.7  | 0.87 | 3.4  | 3.4  | 0.86 | 2.8  | 2.8  | 0.66 |     |      |
|                          |                               |                          | 19                            | 4.5                              | 4.5 | 0.79 | 4.3  | 4.3  | 0.84 | 4.0  | 4.0  | 0.89 | 3.7  | 3.7  | 0.87 | 3.0  | 3.0  | 0.67 |     |      |
|                          |                               |                          | 22                            | 4.8                              | 3.9 | 0.82 | 4.6  | 3.9  | 0.87 | 4.3  | 3.8  | 0.91 | 4.0  | 3.7  | 0.89 | 3.1  | 3.1  | 0.67 |     |      |
|                          |                               | S-50PT2E5A<br>U-50PE2E5A | 220V-230V-240V<br>50Hz 1phase | 23                               | 16  | 5.9  | 4.3  | 1.43 | 5.5  | 4.1  | 1.52 | 5.2  | 4.0  | 1.61 | 4.8  | 3.8  | 1.59 | 3.9  | 3.4 | 1.22 |
|                          |                               |                          |                               |                                  | 19  | 6.3  | 3.3  | 1.46 | 6.0  | 3.2  | 1.55 | 5.6  | 3.0  | 1.64 | 5.2  | 2.9  | 1.61 | 4.1  | 2.4 | 1.23 |
|                          |                               |                          |                               |                                  | 22  | 6.8  | 2.4  | 1.51 | 6.4  | 2.2  | 1.60 | 6.1  | 2.1  | 1.69 | 5.5  | 1.9  | 1.64 | 4.4  | 1.5 | 1.24 |
| 25                       | 16                            |                          |                               | 5.9                              | 4.9 | 1.43 | 5.5  | 4.7  | 1.52 | 5.2  | 4.5  | 1.61 | 4.8  | 4.4  | 1.59 | 3.9  | 3.9  | 1.22 |     |      |
|                          | 19                            |                          |                               | 6.3                              | 3.9 | 1.46 | 6.0  | 3.8  | 1.55 | 5.6  | 3.6  | 1.64 | 5.2  | 3.4  | 1.61 | 4.1  | 3.0  | 1.23 |     |      |
|                          | 22                            |                          |                               | 6.8                              | 3.0 | 1.51 | 6.4  | 2.8  | 1.60 | 6.1  | 2.7  | 1.69 | 5.5  | 2.4  | 1.64 | 4.4  | 2.1  | 1.24 |     |      |
| 27                       | 16                            |                          |                               | 5.9                              | 5.4 | 1.43 | 5.5  | 5.3  | 1.52 | 5.2  | 5.1  | 1.61 | 4.8  | 4.8  | 1.59 | 3.9  | 3.9  | 1.22 |     |      |
|                          | 19                            |                          |                               | 6.3                              | 4.5 | 1.46 | 6.0  | 4.3  | 1.55 | 5.6  | 4.1  | 1.64 | 5.2  | 4.0  | 1.61 | 4.1  | 3.5  | 1.23 |     |      |
|                          | 22                            |                          |                               | 6.8                              | 3.5 | 1.51 | 6.4  | 3.3  | 1.60 | 6.1  | 3.2  | 1.69 | 5.5  | 3.0  | 1.64 | 4.4  | 2.6  | 1.24 |     |      |
| 29                       | 16                            |                          |                               | 5.9                              | 5.9 | 1.43 | 5.5  | 5.5  | 1.52 | 5.2  | 5.2  | 1.61 | 4.8  | 4.8  | 1.59 | 3.9  | 3.9  | 1.22 |     |      |
|                          | 19                            |                          |                               | 6.3                              | 5.0 | 1.46 | 6.0  | 4.9  | 1.55 | 5.6  | 4.7  | 1.64 | 5.2  | 4.5  | 1.61 | 4.1  | 4.1  | 1.23 |     |      |
|                          | 22                            |                          |                               | 6.8                              | 4.1 | 1.51 | 6.4  | 3.9  | 1.60 | 6.1  | 3.8  | 1.69 | 5.5  | 3.5  | 1.64 | 4.4  | 3.2  | 1.24 |     |      |
| 32                       | 16                            |                          |                               | 5.9                              | 5.9 | 1.43 | 5.5  | 5.5  | 1.52 | 5.2  | 5.2  | 1.61 | 4.8  | 4.8  | 1.59 | 3.9  | 3.9  | 1.22 |     |      |
|                          | 19                            |                          |                               | 6.3                              | 5.9 | 1.46 | 6.0  | 5.7  | 1.55 | 5.6  | 5.5  | 1.64 | 5.2  | 5.2  | 1.61 | 4.1  | 4.1  | 1.23 |     |      |
|                          | 22                            |                          |                               | 6.8                              | 4.9 | 1.51 | 6.4  | 4.7  | 1.60 | 6.1  | 4.6  | 1.69 | 5.5  | 4.4  | 1.64 | 4.4  | 4.0  | 1.24 |     |      |
| S-60PT2E5A<br>U-60PE2E5A | 220V-230V-240V<br>50Hz 1phase |                          |                               | 23                               | 16  | 7.1  | 5.4  | 1.85 | 6.8  | 5.2  | 2.02 | 6.5  | 5.1  | 2.19 | 6.1  | 4.9  | 2.13 | 5.0  | 4.4 | 1.41 |
|                          |                               |                          |                               |                                  | 19  | 7.8  | 4.2  | 1.90 | 7.4  | 4.0  | 2.08 | 7.1  | 3.9  | 2.25 | 6.7  | 3.7  | 2.18 | 5.3  | 3.2 | 1.43 |
|                          |                               |                          |                               |                                  | 22  | 8.6  | 3.0  | 1.94 | 8.2  | 2.9  | 2.12 | 7.8  | 2.7  | 2.30 | 7.3  | 2.5  | 2.23 | 5.7  | 2.0 | 1.46 |
|                          |                               | 25                       | 16                            | 7.1                              | 6.1 | 1.85 | 6.8  | 6.0  | 2.02 | 6.5  | 5.8  | 2.19 | 6.1  | 5.7  | 2.13 | 5.0  | 5.0  | 1.41 |     |      |
|                          |                               |                          | 19                            | 7.8                              | 4.9 | 1.90 | 7.4  | 4.8  | 2.08 | 7.1  | 4.6  | 2.25 | 6.7  | 4.5  | 2.18 | 5.3  | 3.9  | 1.43 |     |      |
|                          |                               |                          | 22                            | 8.6                              | 3.7 | 1.94 | 8.2  | 3.6  | 2.12 | 7.8  | 3.5  | 2.30 | 7.3  | 3.2  | 2.23 | 5.7  | 2.7  | 1.46 |     |      |
|                          |                               | 27                       | 16                            | 7.1                              | 6.9 | 1.85 | 6.8  | 6.7  | 2.02 | 6.5  | 6.5  | 2.19 | 6.1  | 6.1  | 2.13 | 5.0  | 5.0  | 1.41 |     |      |
|                          |                               |                          | 19                            | 7.8                              | 5.7 | 1.90 | 7.4  | 5.5  | 2.08 | 7.1  | 5.4  | 2.25 | 6.7  | 5.2  | 2.18 | 5.3  | 4.6  | 1.43 |     |      |
|                          |                               |                          | 22                            | 8.6                              | 4.5 | 1.94 | 8.2  | 4.3  | 2.12 | 7.8  | 4.2  | 2.30 | 7.3  | 4.0  | 2.23 | 5.7  | 3.4  | 1.46 |     |      |
|                          |                               | 29                       | 16                            | 7.1                              | 7.1 | 1.85 | 6.8  | 6.8  | 2.02 | 6.5  | 6.5  | 2.19 | 6.1  | 6.1  | 2.13 | 5.0  | 5.0  | 1.41 |     |      |
|                          |                               |                          | 19                            | 7.8                              | 6.4 | 1.90 | 7.4  | 6.2  | 2.08 | 7.1  | 6.1  | 2.25 | 6.7  | 5.9  | 2.18 | 5.3  | 5.3  | 1.43 |     |      |
|                          |                               |                          | 22                            | 8.6                              | 5.2 | 1.94 | 8.2  | 5.1  | 2.12 | 7.8  | 4.9  | 2.30 | 7.3  | 4.7  | 2.23 | 5.7  | 4.1  | 1.46 |     |      |
|                          |                               | 32                       | 16                            | 7.1                              | 7.1 | 1.85 | 6.8  | 6.8  | 2.02 | 6.5  | 6.5  | 2.19 | 6.1  | 6.1  | 2.13 | 5.0  | 5.0  | 1.41 |     |      |
|                          |                               |                          | 19                            | 7.8                              | 7.5 | 1.90 | 7.4  | 7.3  | 2.08 | 7.1  | 7.1  | 2.25 | 6.7  | 6.7  | 2.18 | 5.3  | 5.3  | 1.43 |     |      |
|                          |                               |                          | 22                            | 8.6                              | 6.3 | 1.94 | 8.2  | 6.2  | 2.12 | 7.8  | 6.0  | 2.30 | 7.3  | 5.8  | 2.23 | 5.7  | 5.2  | 1.46 |     |      |

1-13. Capacity Table

1. Cooling Capacity Performance Data

TC :Cooling Capacity

SHC :Sensible Heat Capacity

IPT :Cooling Power Consumption

• Combination of Single Unit

Ceiling Type

unit : kW

| Model                                       | Power Source  | Ambient Return Air                          |   | Outdoor air intake temp(°C D.B.) |      |      |      |      |      |      |      |      |      |      |      |      |      |      |     |      |
|---|---|---|---|----------------------------------|------|------|------|------|------|------|------|------|------|------|------|------|------|------|-----|------|
|   |   |   |   | 25°C                             |      |      | 30°C |      |      | 35°C |      |      | 40°C |      |      | 46°C |      |      |     |      |
|   |   | DB  | WB  | TC                               | SHC  | IPT  | TC   | SHC  | IPT  | TC   | SHC  | IPT  | TC   | SHC  | IPT  | TC   | SHC  | IPT  |     |      |
| S-71PT2E5A<br>U-71PE1E5A<br>(U-71PE1E8A)    | 220V-230V-240V<br>50Hz 1phase<br>(380V-400V-415V<br>50Hz 3 phase) | 23  | 16  | 8.1                              | 6.1  | 2.36 | 7.9  | 6.0  | 2.53 | 7.6  | 5.9  | 2.72 | 7.2  | 5.6  | 2.70 | 6.3  | 5.1  | 2.31 |     |      |
|   |   |   | 19  | 8.5                              | 4.6  | 2.45 | 8.3  | 4.5  | 2.61 | 8.0  | 4.4  | 2.78 | 7.5  | 4.2  | 2.72 | 6.6  | 3.8  | 2.34 |     |      |
|   |   |   | 22  | 9.0                              | 3.3  | 2.55 | 8.7  | 3.0  | 2.71 | 8.3  | 2.9  | 2.86 | 7.8  | 2.8  | 2.75 | 6.8  | 2.4  | 2.36 |     |      |
|   |   | 25  | 16  | 8.1                              | 6.9  | 2.36 | 7.9  | 6.8  | 2.53 | 7.6  | 6.6  | 2.72 | 7.2  | 6.4  | 2.70 | 6.3  | 5.9  | 2.31 |     |      |
|   |   |   | 19  | 8.5                              | 5.4  | 2.45 | 8.3  | 5.3  | 2.61 | 8.0  | 5.1  | 2.78 | 7.5  | 5.0  | 2.72 | 6.6  | 4.6  | 2.34 |     |      |
|   |   |   | 22  | 9.0                              | 4.0  | 2.55 | 8.7  | 3.9  | 2.71 | 8.3  | 3.7  | 2.86 | 7.8  | 3.5  | 2.75 | 6.8  | 3.2  | 2.36 |     |      |
|   |   | 27  | 16  | 8.1                              | 7.7  | 2.36 | 7.9  | 7.6  | 2.53 | 7.6  | 7.4  | 2.72 | 7.2  | 7.2  | 2.70 | 6.3  | 6.3  | 2.31 |     |      |
|   |   |   | 19  | 8.5                              | 6.2  | 2.45 | 8.3  | 6.1  | 2.61 | 8.0  | 6.0  | 2.78 | 7.5  | 5.7  | 2.72 | 6.6  | 5.4  | 2.34 |     |      |
|   |   |   | 22  | 9.0                              | 4.8  | 2.55 | 8.7  | 4.7  | 2.71 | 8.3  | 4.5  | 2.86 | 7.8  | 4.3  | 2.75 | 6.8  | 4.0  | 2.36 |     |      |
|   |   | 29  | 16  | 8.1                              | 8.1  | 2.36 | 7.9  | 7.9  | 2.53 | 7.6  | 7.6  | 2.72 | 7.2  | 7.2  | 2.70 | 6.3  | 6.3  | 2.31 |     |      |
|   |   |   | 19  | 8.5                              | 7.1  | 2.45 | 8.3  | 7.0  | 2.61 | 8.0  | 6.8  | 2.78 | 7.5  | 6.5  | 2.72 | 6.6  | 6.3  | 2.34 |     |      |
|   |   |   | 22  | 9.0                              | 5.6  | 2.55 | 8.7  | 5.5  | 2.71 | 8.3  | 5.2  | 2.86 | 7.8  | 5.2  | 2.75 | 6.8  | 4.7  | 2.36 |     |      |
|   |   | 32  | 16  | 8.1                              | 8.1  | 2.36 | 7.9  | 7.9  | 2.53 | 7.6  | 7.6  | 2.72 | 7.2  | 7.2  | 2.70 | 6.3  | 6.3  | 2.31 |     |      |
|   |   |   | 19  | 8.5                              | 7.1  | 2.45 | 8.3  | 7.0  | 2.61 | 8.0  | 6.8  | 2.78 | 7.5  | 6.5  | 2.72 | 6.6  | 6.3  | 2.34 |     |      |
|   |   |   | 22  | 9.0                              | 5.6  | 2.55 | 8.7  | 5.5  | 2.71 | 8.3  | 5.2  | 2.86 | 7.8  | 5.2  | 2.75 | 6.8  | 4.7  | 2.36 |     |      |
|   |   | S-100PT2E5A<br>U-100PE1E5A<br>(U-100PE1E8A) | 220V-230V-240V<br>50Hz 1phase<br>(380V-400V-415V<br>50Hz 3 phase) | 23                               | 16   | 11.4 | 8.5  | 3.12 | 11.4 | 8.5  | 3.36 | 10.9 | 8.2  | 3.57 | 10.2 | 8.1  | 3.71 | 7.4  | 6.8 | 3.03 |
|   |   |   |   |                                  | 19   | 12.1 | 6.3  | 3.26 | 12.1 | 6.3  | 3.50 | 11.7 | 6.2  | 3.72 | 10.9 | 6.0  | 3.87 | 7.9  | 4.8 | 3.17 |
|   |   |   |   |                                  | 22   | 13.3 | 4.2  | 3.37 | 13.3 | 4.2  | 3.62 | 12.8 | 4.2  | 3.85 | 11.9 | 3.8  | 4.01 | 8.7  | 2.8 | 3.28 |
| 25  | 16  |   |   | 11.8                             | 10.2 | 3.18 | 11.8 | 10.2 | 3.41 | 11.3 | 9.8  | 3.63 | 10.5 | 9.7  | 3.78 | 7.7  | 7.3  | 3.09 |     |      |
|   | 19  |   |   | 12.6                             | 8.0  | 3.31 | 12.6 | 8.0  | 3.56 | 12.1 | 7.8  | 3.79 | 11.2 | 7.6  | 3.94 | 8.2  | 6.3  | 3.22 |     |      |
|   | 22  |   |   | 13.8                             | 5.9  | 3.43 | 13.8 | 5.9  | 3.68 | 13.2 | 5.6  | 3.92 | 12.3 | 5.4  | 4.07 | 9.0  | 4.2  | 3.33 |     |      |
| 27  | 16  |   |   | 12.2                             | 11.6 | 3.23 | 12.2 | 11.6 | 3.47 | 11.7 | 11.1 | 3.69 | 10.9 | 10.3 | 3.84 | 8.0  | 7.6  | 3.14 |     |      |
|   | 19  |   |   | 13.0                             | 9.7  | 3.37 | 13.0 | 9.7  | 3.62 | 12.5 | 9.4  | 3.85 | 11.6 | 9.2  | 4.00 | 8.5  | 7.9  | 3.27 |     |      |
|   | 22  |   |   | 14.2                             | 7.6  | 3.49 | 14.2 | 7.6  | 3.74 | 13.7 | 7.3  | 3.98 | 12.7 | 7.0  | 4.14 | 9.3  | 5.8  | 3.39 |     |      |
| 29  | 16  |   |   | 12.4                             | 11.8 | 3.24 | 12.4 | 11.8 | 3.48 | 11.9 | 11.3 | 3.70 | 11.0 | 10.4 | 3.85 | 8.1  | 7.7  | 3.15 |     |      |
|   | 19  |   |   | 13.2                             | 11.3 | 3.38 | 13.2 | 11.3 | 3.63 | 12.7 | 11.0 | 3.86 | 11.8 | 10.8 | 4.01 | 8.6  | 8.2  | 3.28 |     |      |
|   | 22  |   |   | 14.5                             | 9.1  | 3.49 | 14.5 | 9.1  | 3.75 | 13.9 | 8.9  | 3.99 | 12.9 | 8.6  | 4.15 | 9.5  | 7.3  | 3.39 |     |      |
| 32  | 16  |   |   | 12.5                             | 11.9 | 3.25 | 12.5 | 11.9 | 3.49 | 12.1 | 11.5 | 3.71 | 11.2 | 10.6 | 3.86 | 8.2  | 7.8  | 3.15 |     |      |
|   | 19  |   |   | 13.4                             | 11.5 | 3.39 | 13.4 | 11.5 | 3.64 | 12.9 | 11.1 | 3.87 | 12.0 | 11.0 | 4.02 | 8.8  | 8.3  | 3.29 |     |      |
|   | 22  |   |   | 14.7                             | 9.3  | 3.50 | 14.7 | 9.3  | 3.76 | 14.1 | 9.0  | 4.00 | 13.1 | 8.8  | 4.16 | 9.6  | 7.4  | 3.40 |     |      |
| S-125PT2E5A<br>U-125PE1E5A<br>(U-125PE1E8A) | 220V-230V-240V<br>50Hz 1phase<br>(380V-400V-415V<br>50Hz 3 phase) |   |   | 23                               | 16   | 12.7 | 9.2  | 3.94 | 12.7 | 9.3  | 4.24 | 12.2 | 8.9  | 4.51 | 11.4 | 8.7  | 4.69 | 8.3  | 7.2 | 3.83 |
|   |   |   |   |                                  | 19   | 13.6 | 7.1  | 4.11 | 13.6 | 7.1  | 4.42 | 13.1 | 6.9  | 4.70 | 12.2 | 6.6  | 4.89 | 8.9  | 5.2 | 4.00 |
|   |   |   |   |                                  | 22   | 14.9 | 5.0  | 4.26 | 14.9 | 5.1  | 4.57 | 14.3 | 4.8  | 4.86 | 13.3 | 4.5  | 5.06 | 9.7  | 3.2 | 4.13 |
|   |   | 25  | 16  | 13.2                             | 10.9 | 4.01 | 13.2 | 10.9 | 4.31 | 12.7 | 10.6 | 4.58 | 11.8 | 10.3 | 4.77 | 8.6  | 8.4  | 3.90 |     |      |
|   |   |   | 19  | 14.1                             | 8.8  | 4.18 | 14.1 | 8.7  | 4.49 | 13.5 | 8.4  | 4.78 | 12.6 | 8.1  | 4.97 | 9.2  | 6.7  | 4.06 |     |      |
|   |   |   | 22  | 15.4                             | 6.5  | 4.33 | 15.4 | 6.6  | 4.65 | 14.8 | 6.3  | 4.95 | 13.8 | 6.0  | 5.14 | 10.1 | 4.7  | 4.20 |     |      |
|   |   | 27  | 16  | 13.6                             | 12.6 | 4.08 | 13.6 | 12.7 | 4.38 | 13.1 | 12.3 | 4.66 | 12.2 | 12.0 | 4.85 | 8.9  | 8.7  | 3.96 |     |      |
|   |   |   | 19  | 14.6                             | 10.4 | 4.25 | 14.6 | 10.5 | 4.57 | 14.0 | 10.1 | 4.86 | 13.0 | 9.8  | 5.05 | 9.5  | 8.3  | 4.13 |     |      |
|   |   |   | 22  | 16.0                             | 8.3  | 4.40 | 16.0 | 8.3  | 4.73 | 15.3 | 8.0  | 5.03 | 14.3 | 7.7  | 5.23 | 10.4 | 6.2  | 4.27 |     |      |
|   |   | 29  | 16  | 13.8                             | 13.5 | 4.09 | 13.8 | 13.5 | 4.39 | 13.3 | 13.0 | 4.67 | 12.4 | 12.2 | 4.86 | 9.0  | 8.8  | 3.97 |     |      |
|   |   |   | 19  | 14.8                             | 12.0 | 4.26 | 14.8 | 12.0 | 4.58 | 14.2 | 11.6 | 4.87 | 13.2 | 11.3 | 5.07 | 9.7  | 9.5  | 4.14 |     |      |
|   |   |   | 22  | 16.2                             | 9.8  | 4.41 | 16.2 | 9.9  | 4.74 | 15.6 | 9.6  | 5.04 | 14.5 | 9.2  | 5.24 | 10.6 | 7.8  | 4.28 |     |      |
|   |   | 32  | 16  | 14.0                             | 13.7 | 4.10 | 14.0 | 13.7 | 4.40 | 13.5 | 13.2 | 4.68 | 12.6 | 12.4 | 4.87 | 9.2  | 9.0  | 3.98 |     |      |
|   |   |   | 19  | 15.0                             | 12.2 | 4.27 | 15.0 | 12.2 | 4.59 | 14.4 | 11.7 | 4.88 | 13.4 | 11.5 | 5.08 | 9.8  | 9.6  | 4.15 |     |      |
|   |   |   | 22  | 16.4                             | 10.0 | 4.42 | 16.4 | 10.0 | 4.75 | 15.8 | 9.7  | 5.05 | 14.7 | 9.3  | 5.25 | 10.7 | 7.8  | 4.29 |     |      |
|   |   | S-140PT2E5A<br>U-140PE1E5A<br>(U-140PE1E8A) | 220V-230V-240V<br>50Hz 1phase<br>(380V-400V-415V<br>50Hz 3 phase) | 23                               | 16   | 13.6 | 9.6  | 4.58 | 13.6 | 9.6  | 4.93 | 13.1 | 9.3  | 5.24 | 12.2 | 9.0  | 5.45 | 8.9  | 7.5 | 4.45 |
|   |   |   |   |                                  | 19   | 14.6 | 7.5  | 4.78 | 14.6 | 7.5  | 5.14 | 14.0 | 7.2  | 5.47 | 13.0 | 6.9  | 5.68 | 9.5  | 5.4 | 4.65 |
|   |   |   |   |                                  | 22   | 16.0 | 5.5  | 4.95 | 16.0 | 5.4  | 5.32 | 15.4 | 5.3  | 5.65 | 14.3 | 4.8  | 5.88 | 10.4 | 3.5 | 4.81 |
| 25  | 16  |   |   | 14.1                             | 11.3 | 4.66 | 14.1 | 11.3 | 5.01 | 13.6 | 11.0 | 5.33 | 12.6 | 10.7 | 5.54 | 9.2  | 9.1  | 4.53 |     |      |
|   | 19  |   |   | 15.1                             | 9.2  | 4.86 | 15.1 | 9.1  | 5.22 | 14.5 | 8.8  | 5.56 | 13.5 | 8.5  | 5.78 | 9.9  | 7.0  | 4.72 |     |      |
|   | 22  |   |   | 16.5                             | 6.9  | 5.03 | 16.5 | 7.0  | 5.40 | 15.9 | 6.7  | 5.75 | 14.8 | 6.4  | 5.98 | 10.8 | 4.9  | 4.89 |     |      |
| 27  | 16  |   |   | 14.6                             | 13.0 | 4.74 | 14.6 | 13.1 | 5.09 | 14.0 | 12.7 | 5.42 | 13.1 | 12.5 | 5.63 | 9.5  | 9.4  | 4.60 |     |      |
|   | 19  |   |   | 15.6                             | 10.9 | 4.94 | 15.6 | 10.8 | 5.31 | 15.0 | 10.4 | 5.65 | 14.0 | 10.2 | 5.88 | 10.2 | 8.6  | 4.80 |     |      |
|   | 22  |   |   | 17.1                             | 8.6  | 5.11 | 17.1 | 8.7  | 5.49 | 16.4 | 8.4  | 5.85 | 15.3 | 8.0  | 6.08 | 11.2 | 6.5  | 4.97 |     |      |
| 29  | 16  |   |   | 14.8                             | 14.6 | 4.75 | 14.8 | 14.6 | 5.10 | 14.3 | 14.1 | 5.43 | 13.3 | 13.1 | 5.65 | 9.7  | 9.6  | 4.62 |     |      |
|   | 19  |   |   | 15.8                             | 12.3 | 4.96 | 15.8 | 12.4 | 5.32 | 15.2 | 12.0 | 5.66 | 14.2 | 11.8 | 5.89 | 10.4 | 10.1 | 4.81 |     |      |
|   | 22  |   |   | 17.3                             | 10.2 | 5.13 | 17.3 | 10.3 | 5.51 | 16.7 | 10.0 | 5.86 | 15.5 | 9.5  | 6.09 | 11.3 | 7.9  | 4.98 |     |      |
| 32  | 16  |   |   | 15.0                             | 14.8 | 4.76 | 15.0 | 14.8 | 5.12 | 14.5 | 14.3 | 5.44 | 13.4 | 13.2 | 5.66 | 9.8  | 9.7  | 4.63 |     |      |
|   | 19  |   |   | 16.1                             | 12.5 | 4.97 | 16.1 | 12.6 | 5.34 | 15.4 | 12.1 | 5.68 | 14.4 | 11.9 | 5.91 | 10.5 | 10.2 | 4.83 |     |      |
|   | 22  |   |   | 17.6                             | 10.4 | 5.14 | 17.6 | 10.5 | 5.52 | 16.9 | 10.1 | 5.87 | 15.7 | 9.7  | 6.11 | 11.5 | 8.0  | 4.99 |     |      |

1-13. Capacity Table

1. Cooling Capacity Performance Data

TC :Cooling Capacity

SHC :Sensible Heat Capacity

IPT :Cooling Power Consumption

• Combination of Multiple Unit

unit : kW

Ceiling Type

| Model   | Power Source  | Ambient Return Air                            |   | Outdoor air intake temp(°C D.B.) |      |      |      |      |      |      |      |      |      |      |      |      |      |      |     |      |
|---|---|---|---|----------------------------------|------|------|------|------|------|------|------|------|------|------|------|------|------|------|-----|------|
|   |   |   |   | 25°C                             |      |      | 30°C |      |      | 35°C |      |      | 40°C |      |      | 46°C |      |      |     |      |
|   |   | DB  | WB  | TC                               | SHC  | IPT  | TC   | SHC  | IPT  | TC   | SHC  | IPT  | TC   | SHC  | IPT  | TC   | SHC  | IPT  |     |      |
| S-36PT2E5A x2<br>U-71PE1E5A<br>(U-71PE1E8A)   | 220V-230V-240V<br>50Hz 1phase<br>(380V-400V-415V<br>50Hz 3 phase) | 23  | 16  | 8.1                              | 6.7  | 2.36 | 7.9  | 6.7  | 2.53 | 7.6  | 6.5  | 2.72 | 7.2  | 6.4  | 2.70 | 6.3  | 6.0  | 2.31 |     |      |
|   |   |   | 19  | 8.5                              | 4.9  | 2.45 | 8.3  | 5.0  | 2.61 | 8.0  | 4.8  | 2.78 | 7.5  | 4.5  | 2.72 | 6.6  | 4.2  | 2.34 |     |      |
|   |   |   | 22  | 9.0                              | 3.2  | 2.55 | 8.7  | 3.1  | 2.71 | 8.3  | 3.0  | 2.86 | 7.8  | 2.8  | 2.75 | 6.8  | 2.4  | 2.36 |     |      |
|   |   | 25  | 16  | 8.1                              | 7.8  | 2.36 | 7.9  | 7.7  | 2.53 | 7.6  | 7.6  | 2.72 | 7.2  | 7.2  | 2.70 | 6.3  | 6.3  | 2.31 |     |      |
|   |   |   | 19  | 8.5                              | 6.0  | 2.45 | 8.3  | 5.9  | 2.61 | 8.0  | 5.8  | 2.78 | 7.5  | 5.6  | 2.72 | 6.6  | 5.2  | 2.34 |     |      |
|   |   |   | 22  | 9.0                              | 4.3  | 2.55 | 8.7  | 4.2  | 2.71 | 8.3  | 4.1  | 2.86 | 7.8  | 3.9  | 2.75 | 6.8  | 3.5  | 2.36 |     |      |
|   |   | 27  | 16  | 8.1                              | 8.1  | 2.36 | 7.9  | 7.9  | 2.53 | 7.6  | 7.6  | 2.72 | 7.2  | 7.2  | 2.70 | 6.3  | 6.3  | 2.31 |     |      |
|   |   |   | 19  | 8.5                              | 7.0  | 2.45 | 8.3  | 7.0  | 2.61 | 8.0  | 6.8  | 2.78 | 7.5  | 6.6  | 2.72 | 6.6  | 6.3  | 2.34 |     |      |
|   |   |   | 22  | 9.0                              | 5.3  | 2.55 | 8.7  | 5.2  | 2.71 | 8.3  | 5.0  | 2.86 | 7.8  | 4.8  | 2.75 | 6.8  | 4.5  | 2.36 |     |      |
|   |   | 29  | 16  | 8.1                              | 8.1  | 2.36 | 7.9  | 7.9  | 2.53 | 7.6  | 7.6  | 2.72 | 7.2  | 7.2  | 2.70 | 6.3  | 6.3  | 2.31 |     |      |
|   |   |   | 19  | 8.5                              | 8.1  | 2.45 | 8.3  | 8.0  | 2.61 | 8.0  | 7.8  | 2.78 | 7.5  | 7.5  | 2.72 | 6.6  | 6.6  | 2.34 |     |      |
|   |   |   | 22  | 9.0                              | 6.4  | 2.55 | 8.7  | 6.3  | 2.71 | 8.3  | 6.0  | 2.86 | 7.8  | 5.9  | 2.75 | 6.8  | 5.6  | 2.36 |     |      |
|   |   | 32  | 16  | 8.1                              | 8.1  | 2.36 | 7.9  | 7.9  | 2.53 | 7.6  | 7.6  | 2.72 | 7.2  | 7.2  | 2.70 | 6.3  | 6.3  | 2.31 |     |      |
|   |   |   | 19  | 8.5                              | 8.1  | 2.45 | 8.3  | 8.0  | 2.61 | 8.0  | 7.8  | 2.78 | 7.5  | 7.5  | 2.72 | 6.6  | 6.6  | 2.34 |     |      |
|   |   |   | 22  | 9.0                              | 6.4  | 2.55 | 8.7  | 6.3  | 2.71 | 8.3  | 6.0  | 2.86 | 7.8  | 5.9  | 2.75 | 6.8  | 5.6  | 2.36 |     |      |
|   |   | S-36PT2E5A x3<br>U-100PE1E5A<br>(U-100PE1E8A) | 220V-230V-240V<br>50Hz 1phase<br>(380V-400V-415V<br>50Hz 3 phase) | 23                               | 16   | 11.4 | 10.0 | 3.12 | 11.4 | 10.0 | 3.36 | 10.9 | 9.7  | 3.57 | 10.2 | 9.5  | 3.71 | 7.4  | 7.4 | 3.03 |
|   |   |   |   |                                  | 19   | 12.1 | 7.3  | 3.26 | 12.1 | 7.3  | 3.50 | 11.7 | 7.1  | 3.72 | 10.9 | 6.8  | 3.87 | 7.9  | 5.6 | 3.17 |
|   |   |   |   |                                  | 22   | 13.3 | 4.8  | 3.37 | 13.3 | 4.8  | 3.62 | 12.8 | 4.7  | 3.85 | 11.9 | 4.3  | 4.01 | 8.7  | 3.2 | 3.28 |
|   |   |   |   | 25                               | 16   | 11.8 | 11.8 | 3.18 | 11.8 | 11.8 | 3.41 | 11.3 | 11.3 | 3.63 | 10.5 | 10.5 | 3.78 | 7.7  | 7.7 | 3.09 |
|   |   |   |   |                                  | 19   | 12.6 | 9.3  | 3.31 | 12.6 | 9.3  | 3.56 | 12.1 | 9.0  | 3.79 | 11.2 | 8.7  | 3.94 | 8.2  | 7.4 | 3.22 |
|   |   |   |   |                                  | 22   | 13.8 | 6.7  | 3.43 | 13.8 | 6.7  | 3.68 | 13.2 | 6.4  | 3.92 | 12.3 | 6.2  | 4.07 | 9.0  | 4.9 | 3.33 |
|   |   |   |   | 27                               | 16   | 12.2 | 12.2 | 3.23 | 12.2 | 12.2 | 3.47 | 11.7 | 11.7 | 3.69 | 10.9 | 10.9 | 3.84 | 8.0  | 8.0 | 3.14 |
|   |   |   |   |                                  | 19   | 13.0 | 11.4 | 3.37 | 13.0 | 11.4 | 3.62 | 12.5 | 11.0 | 3.85 | 11.6 | 10.8 | 4.00 | 8.5  | 8.5 | 3.27 |
|   |   |   |   |                                  | 22   | 14.2 | 8.6  | 3.49 | 14.2 | 8.6  | 3.74 | 13.7 | 8.5  | 3.98 | 12.7 | 8.1  | 4.14 | 9.3  | 6.8 | 3.39 |
| 29  | 16  |   |   | 12.4                             | 12.4 | 3.24 | 12.4 | 12.4 | 3.48 | 11.9 | 11.9 | 3.70 | 11.0 | 11.0 | 3.85 | 8.1  | 8.1  | 3.15 |     |      |
|   | 19  |   |   | 13.2                             | 13.2 | 3.38 | 13.2 | 13.2 | 3.63 | 12.7 | 12.7 | 3.86 | 11.8 | 11.8 | 4.01 | 8.6  | 8.6  | 3.28 |     |      |
|   | 22  |   |   | 14.5                             | 10.7 | 3.49 | 14.5 | 10.7 | 3.75 | 13.9 | 10.3 | 3.99 | 12.9 | 10.1 | 4.15 | 9.5  | 8.7  | 3.39 |     |      |
| 32  | 16  |   |   | 12.5                             | 12.5 | 3.25 | 12.5 | 12.5 | 3.49 | 12.1 | 12.1 | 3.71 | 11.2 | 11.2 | 3.86 | 8.2  | 8.2  | 3.15 |     |      |
|   | 19  |   |   | 13.4                             | 13.4 | 3.39 | 13.4 | 13.4 | 3.64 | 12.9 | 12.9 | 3.87 | 12.0 | 12.0 | 4.02 | 8.8  | 8.8  | 3.29 |     |      |
|   | 22  |   |   | 14.7                             | 10.8 | 3.50 | 14.7 | 10.8 | 3.76 | 14.1 | 10.4 | 4.00 | 13.1 | 10.3 | 4.16 | 9.6  | 8.8  | 3.40 |     |      |
| S-50PT2E5A x2<br>U-100PE1E5A<br>(U-100PE1E8A) | 220V-230V-240V<br>50Hz 1phase<br>(380V-400V-415V<br>50Hz 3 phase) |   |   | 23                               | 16   | 11.4 | 8.7  | 3.12 | 11.4 | 8.7  | 3.36 | 10.9 | 8.4  | 3.57 | 10.2 | 8.2  | 3.71 | 7.4  | 6.8 | 3.03 |
|   |   |   |   |                                  | 19   | 12.1 | 6.6  | 3.26 | 12.1 | 6.6  | 3.50 | 11.7 | 6.4  | 3.72 | 10.9 | 6.1  | 3.87 | 7.9  | 4.9 | 3.17 |
|   |   |   |   |                                  | 22   | 13.3 | 4.7  | 3.37 | 13.3 | 4.7  | 3.62 | 12.8 | 4.5  | 3.85 | 11.9 | 4.1  | 4.01 | 8.7  | 3.1 | 3.28 |
|   |   |   |   | 25                               | 16   | 11.8 | 10.3 | 3.18 | 11.8 | 10.3 | 3.41 | 11.3 | 9.9  | 3.63 | 10.5 | 9.7  | 3.78 | 7.7  | 7.7 | 3.09 |
|   |   |   |   |                                  | 19   | 12.6 | 8.1  | 3.31 | 12.6 | 8.1  | 3.56 | 12.1 | 7.8  | 3.79 | 11.2 | 7.5  | 3.94 | 8.2  | 6.3 | 3.22 |
|   |   |   |   |                                  | 22   | 13.8 | 6.2  | 3.43 | 13.8 | 6.2  | 3.68 | 13.2 | 5.9  | 3.92 | 12.3 | 5.6  | 4.07 | 9.0  | 4.4 | 3.33 |
|   |   |   |   | 27                               | 16   | 12.2 | 11.9 | 3.23 | 12.2 | 11.9 | 3.47 | 11.7 | 11.5 | 3.69 | 10.9 | 10.9 | 3.84 | 8.0  | 8.0 | 3.14 |
|   |   |   |   |                                  | 19   | 13.0 | 9.7  | 3.37 | 13.0 | 9.7  | 3.62 | 12.5 | 9.4  | 3.85 | 11.6 | 9.1  | 4.00 | 8.5  | 7.7 | 3.27 |
|   |   |   |   |                                  | 22   | 14.2 | 7.6  | 3.49 | 14.2 | 7.6  | 3.74 | 13.7 | 7.5  | 3.98 | 12.7 | 7.1  | 4.14 | 9.3  | 5.8 | 3.39 |
|   |   | 29  | 16  | 12.4                             | 12.4 | 3.24 | 12.4 | 12.4 | 3.48 | 11.9 | 11.9 | 3.70 | 11.0 | 11.0 | 3.85 | 8.1  | 8.1  | 3.15 |     |      |
|   |   |   | 19  | 13.2                             | 11.2 | 3.38 | 13.2 | 11.2 | 3.63 | 12.7 | 11.0 | 3.86 | 11.8 | 10.6 | 4.01 | 8.6  | 8.6  | 3.28 |     |      |
|   |   |   | 22  | 14.5                             | 9.2  | 3.49 | 14.5 | 9.2  | 3.75 | 13.9 | 9.0  | 3.99 | 12.9 | 8.6  | 4.15 | 9.5  | 7.2  | 3.39 |     |      |
|   |   | 32  | 16  | 12.5                             | 12.5 | 3.25 | 12.5 | 12.5 | 3.49 | 12.1 | 12.1 | 3.71 | 11.2 | 11.2 | 3.86 | 8.2  | 8.2  | 3.15 |     |      |
|   |   |   | 19  | 13.4                             | 11.3 | 3.39 | 13.4 | 11.3 | 3.64 | 12.9 | 11.1 | 3.87 | 12.0 | 10.8 | 4.02 | 8.8  | 8.8  | 3.29 |     |      |
|   |   |   | 22  | 14.7                             | 9.3  | 3.50 | 14.7 | 9.3  | 3.76 | 14.1 | 9.1  | 4.00 | 13.1 | 8.8  | 4.16 | 9.6  | 7.3  | 3.40 |     |      |
|   |   | S-36PT2E5A x4<br>U-125PE1E5A<br>(U-125PE1E8A) | 220V-230V-240V<br>50Hz 1phase<br>(380V-400V-415V<br>50Hz 3 phase) | 23                               | 16   | 12.7 | 11.6 | 3.94 | 12.7 | 11.6 | 4.24 | 12.2 | 11.2 | 4.51 | 11.4 | 11.0 | 4.69 | 8.3  | 8.3 | 3.83 |
|   |   |   |   |                                  | 19   | 13.6 | 8.5  | 4.11 | 13.6 | 8.5  | 4.42 | 13.1 | 8.3  | 4.70 | 12.2 | 7.9  | 4.89 | 8.9  | 6.6 | 4.00 |
|   |   |   |   |                                  | 22   | 14.9 | 5.4  | 4.26 | 14.9 | 5.4  | 4.57 | 14.3 | 5.2  | 4.86 | 13.3 | 4.8  | 5.06 | 9.7  | 3.6 | 4.13 |
|   |   |   |   | 25                               | 16   | 13.2 | 13.2 | 4.01 | 13.2 | 13.2 | 4.31 | 12.7 | 12.7 | 4.58 | 11.8 | 11.8 | 4.77 | 8.6  | 8.6 | 3.90 |
|   |   |   |   |                                  | 19   | 14.1 | 10.8 | 4.18 | 14.1 | 10.9 | 4.49 | 13.5 | 10.5 | 4.78 | 12.6 | 10.2 | 4.97 | 9.2  | 8.8 | 4.06 |
|   |   |   |   |                                  | 22   | 15.4 | 7.7  | 4.33 | 15.4 | 7.7  | 4.65 | 14.8 | 7.4  | 4.95 | 13.8 | 7.1  | 5.14 | 10.1 | 5.7 | 4.20 |
|   |   |   |   | 27                               | 16   | 13.6 | 13.6 | 4.08 | 13.6 | 13.6 | 4.38 | 13.1 | 13.1 | 4.66 | 12.2 | 12.2 | 4.85 | 8.9  | 8.9 | 3.96 |
|   |   |   |   |                                  | 19   | 14.6 | 13.3 | 4.25 | 14.6 | 13.4 | 4.57 | 14.0 | 12.9 | 4.86 | 13.0 | 12.7 | 5.05 | 9.5  | 9.5 | 4.13 |
|   |   |   |   |                                  | 22   | 16.0 | 10.2 | 4.40 | 16.0 | 10.3 | 4.73 | 15.3 | 9.8  | 5.03 | 14.3 | 9.6  | 5.23 | 10.4 | 8.0 | 4.27 |
| 29  | 16  |   |   | 13.8                             | 13.8 | 4.09 | 13.8 | 13.8 | 4.39 | 13.3 | 13.3 | 4.67 | 12.4 | 12.4 | 4.86 | 9.0  | 9.0  | 3.97 |     |      |
|   | 19  |   |   | 14.8                             | 14.8 | 4.26 | 14.8 | 14.8 | 4.58 | 14.2 | 14.2 | 4.87 | 13.2 | 13.2 | 5.07 | 9.7  | 9.7  | 4.14 |     |      |
|   | 22  |   |   | 16.2                             | 12.5 | 4.41 | 16.2 | 12.6 | 4.74 | 15.6 | 12.2 | 5.04 | 14.5 | 12.0 | 5.24 | 10.6 | 10.2 | 4.28 |     |      |
| 32  | 16  |   |   | 14.0                             | 14.0 | 4.10 | 14.0 | 14.0 | 4.40 | 13.5 | 13.5 | 4.68 | 12.6 | 12.6 | 4.87 | 9.2  | 9.2  | 3.98 |     |      |
|   | 19  |   |   | 15.0                             | 15.0 | 4.27 | 15.0 | 15.0 | 4.59 | 14.4 | 14.4 | 4.88 | 13.4 | 13.4 | 5.08 | 9.8  | 9.8  | 4.15 |     |      |
|   | 22  |   |   | 16.4                             | 12.7 | 4.42 | 16.4 | 12.8 | 4.75 | 15.8 | 12.4 | 5.05 | 14.7 | 12.1 | 5.25 | 10.7 | 10.3 | 4.29 |     |      |
| S-45PT2E5A x3<br>U-125PE1E5A<br>(U-125PE1E8A) | 220V-230V-240V<br>50Hz 1phase<br>(380V-400V-415V<br>50Hz 3 phase) |   |   | 23                               | 16   | 12.7 | 10.4 | 3.94 | 12.7 | 10.4 | 4.24 | 12.2 | 10.0 | 4.51 | 11.4 | 9.9  | 4.69 | 8.3  | 8.3 | 3.83 |
|   |   |   |   |                                  | 19   | 13.6 | 7.8  | 4.11 | 13.6 | 7.8  | 4.42 | 13.1 | 7.6  | 4.70 | 12.2 | 7.2  | 4.89 | 8.9  | 5.9 | 4.00 |
|   |   |   |   |                                  | 22   | 14.9 | 5.3  | 4.26 | 14.9 | 5.2  | 4.57 | 14.3 | 4.9  | 4.86 | 13.3 | 4.6  | 5.06 | 9.7  | 3.4 | 4.13 |
|   |   |   |   | 25                               | 16   | 13.2 | 12.5 | 4.01 | 13.2 | 12.5 | 4.31 | 12.7 | 12.2 | 4.58 | 11.8 | 11.8 | 4.77 | 8.6  | 8.6 | 3.90 |
|   |   |   |   |                                  | 19   | 14.1 | 9.8  | 4.18 | 14.1 | 9.8  | 4.49 | 13.5 | 9.4  | 4.78 | 12.6 | 9.2  | 4.97 | 9.2  | 7.8 | 4.06 |
|   |   |   |   |                                  | 22   | 15.4 | 7.1  | 4.33 | 15.4 | 7.2  | 4.65 | 14.8 | 6.9  | 4.95 | 13.8 | 6.6  | 5.14 | 10.1 | 5.3 | 4.20 |
|   |   |   |   | 27                               | 16   | 13.6 | 13.6 | 4.08 | 13.6 | 13.6 | 4.38 | 13.1 | 13.1 | 4.66 | 12.2 | 12.2 | 4.85 | 8.9  | 8.9 | 3.96 |
|   |   |   |   |                                  | 19   | 14.6 | 11.9 | 4.25 | 14.6 | 12.0 | 4.57 | 14.0 | 11.5 | 4.86 | 13.0 | 11.2 | 5.05 | 9.5  | 9.5 | 4.13 |
|   |   |   |   |                                  | 22   | 16.0 | 9.2  | 4.40 | 16.0 | 9.3  | 4.73 | 15.3 | 8.9  | 5.03 | 14.3 | 8.7  | 5.23 | 10.4 | 7.1 | 4.27 |
|   |   | 29  | 16  | 13.8                             | 13.8 | 4.09 | 13.8 | 13.8 | 4.39 | 13.3 | 13.3 | 4.67 | 12.4 | 12.4 | 4.86 | 9.0  | 9.0  | 3.97 |     |      |
|   |   |   | 19  | 14.8                             | 13.8 | 4.26 | 14.8 | 13.9 | 4.58 | 14.2 | 13.4 | 4.87 | 13.2 | 13.2 | 5.07 | 9.7  | 9.7  | 4.14 |     |      |
|   |   |   | 22  | 16.2                             | 11.2 | 4.41 | 16.2 | 11.2 | 4.74 | 15.6 | 10.9 | 5.04 | 14.5 | 10.5 | 5.24 | 10.6 | 9.0  | 4.28 |     |      |
|   |   | 32  | 16  | 14.0                             | 14.0 | 4.10 | 14.0 | 14.0 | 4.40 | 13.5 | 13.5 | 4.68 | 12.6 | 12.6 | 4.87 | 9.2  | 9.2  | 3.98 |     |      |
|   |   |   | 19  | 15.0                             | 15.0 | 4.27 | 15.0 | 14.1 | 4.59 | 14.4 | 13.6 | 4.88 | 13.4 | 13.4 | 5.08 | 9.8  | 9.8  | 4.15 |     |      |
|   |   |   | 22  | 16.4                             | 11.3 | 4.42 | 16.4 | 11.3 | 4.75 | 15.8 | 11.0 | 5.05 | 14.7 |      |      |      |      |      |     |      |

1-13. Capacity Table

1. Cooling Capacity Performance Data

TC :Cooling Capacity

SHC :Sensible Heat Capacity

IPT :Cooling Power Consumption

• Combination of Multiple Unit

unit : kW

Ceiling Type

| Model  | Power Source  | Ambient Return Air                           |   | Outdoor air intake temp(°C D.B.) |      |      |      |      |      |      |      |      |      |      |      |      |      |      |     |      |
|--|---|--|---|----------------------------------|------|------|------|------|------|------|------|------|------|------|------|------|------|------|-----|------|
|  |   |  |   | 25°C                             |      |      | 30°C |      |      | 35°C |      |      | 40°C |      |      | 46°C |      |      |     |      |
|  |   | DB   | WB  | TC                               | SHC  | IPT  | TC   | SHC  | IPT  | TC   | SHC  | IPT  | TC   | SHC  | IPT  | TC   | SHC  | IPT  |     |      |
| S-60PT2E5A×2<br>U-125PE1E5A<br>(U-125PE1E8A) | 220V-230V-240V<br>50Hz 1phase<br>(380V-400V-415V<br>50Hz 3 phase) | 23   | 16  | 12.7                             | 9.9  | 3.94 | 12.7 | 9.9  | 4.24 | 12.2 | 9.5  | 4.51 | 11.4 | 9.4  | 4.69 | 8.3  | 7.8  | 3.83 |     |      |
|  |   |  | 19  | 13.6                             | 7.5  | 4.11 | 13.6 | 7.5  | 4.42 | 13.1 | 7.3  | 4.70 | 12.2 | 6.9  | 4.89 | 8.9  | 5.5  | 4.00 |     |      |
|  |   |  | 22  | 14.9                             | 5.2  | 4.26 | 14.9 | 5.1  | 4.57 | 14.3 | 5.0  | 4.86 | 13.3 | 4.6  | 5.06 | 9.7  | 3.4  | 4.13 |     |      |
|  |   | 25   | 16  | 13.2                             | 11.8 | 4.01 | 13.2 | 11.8 | 4.31 | 12.7 | 11.4 | 4.58 | 11.8 | 11.2 | 4.77 | 8.6  | 8.6  | 3.90 |     |      |
|  |   |  | 19  | 14.1                             | 9.3  | 4.18 | 14.1 | 9.4  | 4.49 | 13.5 | 9.0  | 4.78 | 12.6 | 8.7  | 4.97 | 9.2  | 7.3  | 4.06 |     |      |
|  |   |  | 22  | 15.4                             | 6.9  | 4.33 | 15.4 | 7.0  | 4.65 | 14.8 | 6.7  | 4.95 | 13.8 | 6.4  | 5.14 | 10.1 | 5.0  | 4.20 |     |      |
|  |   | 27   | 16  | 13.6                             | 13.6 | 4.08 | 13.6 | 13.6 | 4.38 | 13.1 | 13.1 | 4.66 | 12.2 | 12.2 | 4.85 | 8.9  | 8.9  | 3.96 |     |      |
|  |   |  | 19  | 14.6                             | 11.2 | 4.25 | 14.6 | 11.2 | 4.57 | 14.0 | 10.8 | 4.86 | 13.0 | 10.5 | 5.05 | 9.5  | 9.0  | 4.13 |     |      |
|  |   |  | 22  | 16.0                             | 8.9  | 4.40 | 16.0 | 8.8  | 4.73 | 15.3 | 8.4  | 5.03 | 14.3 | 8.2  | 5.23 | 10.4 | 6.6  | 4.27 |     |      |
|  |   | 29   | 16  | 13.8                             | 13.8 | 4.09 | 13.8 | 13.8 | 4.39 | 13.3 | 13.3 | 4.67 | 12.4 | 12.4 | 4.86 | 9.0  | 9.0  | 3.97 |     |      |
|  |   |  | 19  | 14.8                             | 13.0 | 4.26 | 14.8 | 13.1 | 4.58 | 14.2 | 12.6 | 4.87 | 13.2 | 12.4 | 5.07 | 9.7  | 9.7  | 4.14 |     |      |
|  |   |  | 22  | 16.2                             | 10.6 | 4.41 | 16.2 | 10.5 | 4.74 | 15.6 | 10.3 | 5.04 | 14.5 | 10.1 | 5.24 | 10.6 | 8.4  | 4.28 |     |      |
|  |   | 32   | 16  | 14.0                             | 14.0 | 4.10 | 14.0 | 14.0 | 4.40 | 13.5 | 13.5 | 4.68 | 12.6 | 12.6 | 4.87 | 9.2  | 9.2  | 3.98 |     |      |
|  |   |  | 19  | 15.0                             | 13.1 | 4.27 | 15.0 | 13.2 | 4.59 | 14.4 | 12.8 | 4.88 | 13.4 | 12.6 | 5.08 | 9.8  | 9.8  | 4.15 |     |      |
|  |   |  | 22  | 16.4                             | 10.7 | 4.42 | 16.4 | 10.7 | 4.75 | 15.8 | 10.4 | 5.05 | 14.7 | 10.2 | 5.25 | 10.7 | 8.5  | 4.29 |     |      |
|  |   | S-50PT2E5A×3<br>U-140PE1E5A<br>(U-140PE1E8A) | 220V-230V-240V<br>50Hz 1phase<br>(380V-400V-415V<br>50Hz 3 phase) | 23                               | 16   | 13.6 | 10.6 | 4.58 | 13.6 | 10.6 | 4.93 | 13.1 | 10.3 | 5.24 | 12.2 | 10.0 | 5.45 | 8.9  | 8.5 | 4.45 |
|  |   |  |   |                                  | 19   | 14.6 | 8.0  | 4.78 | 14.6 | 8.1  | 5.14 | 14.0 | 7.8  | 5.47 | 13.0 | 7.4  | 5.68 | 9.5  | 5.9 | 4.65 |
|  |   |  |   |                                  | 22   | 16.0 | 5.6  | 4.95 | 16.0 | 5.6  | 5.32 | 15.4 | 5.4  | 5.65 | 14.3 | 4.9  | 5.88 | 10.4 | 3.6 | 4.81 |
|  |   |  |   | 25                               | 16   | 14.1 | 12.5 | 4.66 | 14.1 | 12.5 | 5.01 | 13.6 | 12.2 | 5.33 | 12.6 | 11.9 | 5.54 | 9.2  | 9.2 | 4.53 |
|  |   |  |   |                                  | 19   | 15.1 | 9.9  | 4.86 | 15.1 | 10.0 | 5.22 | 14.5 | 9.6  | 5.56 | 13.5 | 9.3  | 5.78 | 9.9  | 7.8 | 4.72 |
|  |   |  |   |                                  | 22   | 16.5 | 7.4  | 5.03 | 16.5 | 7.5  | 5.40 | 15.9 | 7.2  | 5.75 | 14.8 | 6.8  | 5.98 | 10.8 | 5.3 | 4.89 |
|  |   |  |   | 27                               | 16   | 14.6 | 14.6 | 4.74 | 14.6 | 14.6 | 5.09 | 14.0 | 14.0 | 5.42 | 13.1 | 13.1 | 5.63 | 9.5  | 9.5 | 4.60 |
|  |   |  |   |                                  | 19   | 15.6 | 11.9 | 4.94 | 15.6 | 12.0 | 5.31 | 15.0 | 11.6 | 5.65 | 14.0 | 11.4 | 5.88 | 10.2 | 9.7 | 4.80 |
|  |   |  |   |                                  | 22   | 17.1 | 9.4  | 5.11 | 17.1 | 9.4  | 5.49 | 16.4 | 9.1  | 5.85 | 15.3 | 8.8  | 6.08 | 11.2 | 7.2 | 4.97 |
| 29   | 16  |  |   | 14.8                             | 14.8 | 4.75 | 14.8 | 14.8 | 5.10 | 14.3 | 14.3 | 5.43 | 13.3 | 13.3 | 5.65 | 9.7  | 9.7  | 4.62 |     |      |
|  | 19  |  |   | 15.8                             | 13.8 | 4.96 | 15.8 | 13.9 | 5.32 | 15.2 | 13.4 | 5.66 | 14.2 | 13.3 | 5.89 | 10.4 | 10.4 | 4.81 |     |      |
|  | 22  |  |   | 17.3                             | 11.3 | 5.13 | 17.3 | 11.3 | 5.51 | 16.7 | 10.9 | 5.86 | 15.5 | 10.6 | 6.09 | 11.3 | 8.9  | 4.98 |     |      |
| 32   | 16  |  |   | 15.0                             | 15.0 | 4.76 | 15.0 | 15.0 | 5.12 | 14.5 | 14.5 | 5.44 | 13.4 | 13.4 | 5.66 | 9.8  | 9.8  | 4.63 |     |      |
|  | 19  |  |   | 16.1                             | 14.0 | 4.97 | 16.1 | 14.1 | 5.34 | 15.4 | 13.6 | 5.68 | 14.4 | 13.4 | 5.91 | 10.5 | 10.5 | 4.83 |     |      |
|  | 22  |  |   | 17.6                             | 11.5 | 5.14 | 17.6 | 11.5 | 5.52 | 16.9 | 11.0 | 5.87 | 15.7 | 10.7 | 6.11 | 11.5 | 9.1  | 4.99 |     |      |
| S-71PT2E5A×2<br>U-140PE1E5A<br>(U-140PE1E8A) | 220V-230V-240V<br>50Hz 1phase<br>(380V-400V-415V<br>50Hz 3 phase) |  |   | 23                               | 16   | 13.6 | 10.3 | 4.58 | 13.6 | 10.4 | 4.93 | 13.1 | 10.1 | 5.24 | 12.2 | 9.7  | 5.45 | 8.9  | 8.2 | 4.45 |
|  |   |  |   |                                  | 19   | 14.6 | 8.1  | 4.78 | 14.6 | 8.0  | 5.14 | 14.0 | 7.7  | 5.47 | 13.0 | 7.3  | 5.68 | 9.5  | 5.8 | 4.65 |
|  |   |  |   |                                  | 22   | 16.0 | 5.7  | 4.95 | 16.0 | 5.7  | 5.32 | 15.4 | 5.4  | 5.65 | 14.3 | 5.0  | 5.88 | 10.4 | 3.7 | 4.81 |
|  |   |  |   | 25                               | 16   | 14.1 | 12.2 | 4.66 | 14.1 | 12.2 | 5.01 | 13.6 | 11.9 | 5.33 | 12.6 | 11.6 | 5.54 | 9.2  | 9.2 | 4.53 |
|  |   |  |   |                                  | 19   | 15.1 | 9.8  | 4.86 | 15.1 | 9.8  | 5.22 | 14.5 | 9.5  | 5.56 | 13.5 | 9.1  | 5.78 | 9.9  | 7.6 | 4.72 |
|  |   |  |   |                                  | 22   | 16.5 | 7.4  | 5.03 | 16.5 | 7.5  | 5.40 | 15.9 | 7.2  | 5.75 | 14.8 | 6.8  | 5.98 | 10.8 | 5.3 | 4.89 |
|  |   |  |   | 27                               | 16   | 14.6 | 14.2 | 4.74 | 14.6 | 14.2 | 5.09 | 14.0 | 13.8 | 5.42 | 13.1 | 13.1 | 5.63 | 9.5  | 9.5 | 4.60 |
|  |   |  |   |                                  | 19   | 15.6 | 11.7 | 4.94 | 15.6 | 11.6 | 5.31 | 15.0 | 11.2 | 5.65 | 14.0 | 11.1 | 5.88 | 10.2 | 9.3 | 4.80 |
|  |   |  |   |                                  | 22   | 17.1 | 9.2  | 5.11 | 17.1 | 9.3  | 5.49 | 16.4 | 8.9  | 5.85 | 15.3 | 8.6  | 6.08 | 11.2 | 7.0 | 4.97 |
|  |   | 29   | 16  | 14.8                             | 14.8 | 4.75 | 14.8 | 14.8 | 5.10 | 14.3 | 14.3 | 5.43 | 13.3 | 13.3 | 5.65 | 9.7  | 9.7  | 4.62 |     |      |
|  |   |  | 19  | 15.8                             | 13.3 | 4.96 | 15.8 | 13.4 | 5.32 | 15.2 | 13.0 | 5.66 | 14.2 | 12.8 | 5.89 | 10.4 | 10.4 | 4.81 |     |      |
|  |   |  | 22  | 17.3                             | 11.0 | 5.13 | 17.3 | 11.0 | 5.51 | 16.7 | 10.7 | 5.86 | 15.5 | 10.3 | 6.09 | 11.3 | 8.5  | 4.98 |     |      |
|  |   | 32   | 16  | 15.0                             | 15.0 | 4.76 | 15.0 | 15.0 | 5.12 | 14.5 | 14.5 | 5.44 | 13.4 | 13.4 | 5.66 | 9.8  | 9.8  | 4.63 |     |      |
|  |   |  | 19  | 16.1                             | 13.6 | 4.97 | 16.1 | 13.7 | 5.34 | 15.4 | 13.1 | 5.68 | 14.4 | 12.9 | 5.91 | 10.5 | 10.5 | 4.83 |     |      |
|  |   |  | 22  | 17.6                             | 11.2 | 5.14 | 17.6 | 11.2 | 5.52 | 16.9 | 10.9 | 5.87 | 15.7 | 10.4 | 6.11 | 11.5 | 8.7  | 4.99 |     |      |

1-13. Capacity Table

1. Cooling Capacity Performance Data

TC :Cooling Capacity

SHC :Sensible Heat Capacity

IPT :Cooling Power Consumption

• Combination of Single Unit

Wall Mounted Type

unit : kW

| Model                                       | Power Source  | Ambient Return Air                       |   | Outdoor air intake temp(°C D.B.) |     |      |      |      |      |      |      |      |      |      |      |      |      |      |     |      |
|---|---|--|---|----------------------------------|-----|------|------|------|------|------|------|------|------|------|------|------|------|------|-----|------|
|   |   |  |   | 25°C                             |     |      | 30°C |      |      | 35°C |      |      | 40°C |      |      | 46°C |      |      |     |      |
|   |   |  |   | DB                               | WB  | TC   | SHC  | IPT  | TC   | SHC  | IPT  | TC   | SHC  | IPT  | TC   | SHC  | IPT  | TC   | SHC | IPT  |
| S-36PK1E5A<br>U-36PE2E5A                    | 220V-230V-240V<br>50Hz 1phase                                     | 23                                       | 16  | 4.2                              | 3.1 | 0.81 | 4.0  | 3.0  | 0.86 | 3.7  | 2.9  | 0.91 | 3.4  | 2.8  | 0.90 | 2.8  | 2.5  | 0.69 |     |      |
|   |   |  | 19  | 4.5                              | 2.4 | 0.83 | 4.3  | 2.3  | 0.88 | 4.0  | 2.2  | 0.93 | 3.7  | 2.1  | 0.91 | 3.0  | 1.8  | 0.70 |     |      |
|   |   |  | 22  | 4.8                              | 1.7 | 0.86 | 4.6  | 1.6  | 0.91 | 4.3  | 1.5  | 0.96 | 4.0  | 1.4  | 0.93 | 3.1  | 1.1  | 0.70 |     |      |
|   |   | 25                                       | 16  | 4.2                              | 3.6 | 0.81 | 4.0  | 3.5  | 0.86 | 3.7  | 3.3  | 0.91 | 3.4  | 3.2  | 0.90 | 2.8  | 2.8  | 0.69 |     |      |
|   |   |  | 19  | 4.5                              | 2.8 | 0.83 | 4.3  | 2.7  | 0.88 | 4.0  | 2.6  | 0.93 | 3.7  | 2.5  | 0.91 | 3.0  | 2.2  | 0.70 |     |      |
|   |   |  | 22  | 4.8                              | 2.1 | 0.86 | 4.6  | 2.0  | 0.91 | 4.3  | 1.9  | 0.96 | 4.0  | 1.8  | 0.93 | 3.1  | 1.5  | 0.70 |     |      |
|   |   | 27                                       | 16  | 4.2                              | 4.0 | 0.81 | 4.0  | 3.9  | 0.86 | 3.7  | 3.7  | 0.91 | 3.4  | 3.4  | 0.90 | 2.8  | 2.8  | 0.69 |     |      |
|   |   |  | 19  | 4.5                              | 3.3 | 0.83 | 4.3  | 3.2  | 0.88 | 4.0  | 3.0  | 0.93 | 3.7  | 2.9  | 0.91 | 3.0  | 2.6  | 0.70 |     |      |
|   |   |  | 22  | 4.8                              | 2.5 | 0.86 | 4.6  | 2.4  | 0.91 | 4.3  | 2.3  | 0.96 | 4.0  | 2.2  | 0.93 | 3.1  | 1.9  | 0.70 |     |      |
|   |   | 29                                       | 16  | 4.2                              | 4.2 | 0.81 | 4.0  | 4.0  | 0.86 | 3.7  | 3.7  | 0.91 | 3.4  | 3.4  | 0.90 | 2.8  | 2.8  | 0.69 |     |      |
|   |   |  | 19  | 4.5                              | 3.7 | 0.83 | 4.3  | 3.6  | 0.88 | 4.0  | 3.5  | 0.93 | 3.7  | 3.3  | 0.91 | 3.0  | 3.0  | 0.70 |     |      |
|   |   |  | 22  | 4.8                              | 2.9 | 0.86 | 4.6  | 2.8  | 0.91 | 4.3  | 2.7  | 0.96 | 4.0  | 2.6  | 0.93 | 3.1  | 2.3  | 0.70 |     |      |
|   |   | 32                                       | 16  | 4.2                              | 4.2 | 0.81 | 4.0  | 4.0  | 0.86 | 3.7  | 3.7  | 0.91 | 3.4  | 3.4  | 0.90 | 2.8  | 2.8  | 0.69 |     |      |
|   |   |  | 19  | 4.5                              | 4.3 | 0.83 | 4.3  | 4.2  | 0.88 | 4.0  | 4.0  | 0.93 | 3.7  | 3.7  | 0.91 | 3.0  | 3.0  | 0.70 |     |      |
|   |   |  | 22  | 4.8                              | 3.5 | 0.86 | 4.6  | 3.5  | 0.91 | 4.3  | 3.4  | 0.96 | 4.0  | 3.2  | 0.93 | 3.1  | 2.9  | 0.70 |     |      |
|   |   | S-50PK1E5A<br>U-50PE2E5A                 | 220V-230V-240V<br>50Hz 1phase                                     | 23                               | 16  | 5.9  | 4.3  | 1.50 | 5.5  | 4.1  | 1.59 | 5.2  | 3.9  | 1.69 | 4.8  | 3.7  | 1.67 | 3.9  | 3.3 | 1.28 |
|   |   |  |   |                                  | 19  | 6.3  | 3.3  | 1.53 | 6.0  | 3.2  | 1.63 | 5.6  | 3.0  | 1.72 | 5.2  | 2.8  | 1.69 | 4.1  | 2.4 | 1.29 |
|   |   |  |   |                                  | 22  | 6.8  | 2.4  | 1.58 | 6.4  | 2.3  | 1.68 | 6.1  | 2.1  | 1.77 | 5.5  | 1.9  | 1.72 | 4.4  | 1.5 | 1.30 |
| 25  | 16  |  |   | 5.9                              | 4.8 | 1.50 | 5.5  | 4.6  | 1.59 | 5.2  | 4.5  | 1.69 | 4.8  | 4.3  | 1.67 | 3.9  | 3.8  | 1.28 |     |      |
|   | 19  |  |   | 6.3                              | 3.9 | 1.53 | 6.0  | 3.7  | 1.63 | 5.6  | 3.5  | 1.72 | 5.2  | 3.4  | 1.69 | 4.1  | 2.9  | 1.29 |     |      |
|   | 22  |  |   | 6.8                              | 2.9 | 1.58 | 6.4  | 2.8  | 1.68 | 6.1  | 2.7  | 1.77 | 5.5  | 2.4  | 1.72 | 4.4  | 2.0  | 1.30 |     |      |
| 27  | 16  |  |   | 5.9                              | 5.4 | 1.50 | 5.5  | 5.1  | 1.59 | 5.2  | 5.0  | 1.69 | 4.8  | 4.8  | 1.67 | 3.9  | 3.9  | 1.28 |     |      |
|   | 19  |  |   | 6.3                              | 4.4 | 1.53 | 6.0  | 4.3  | 1.63 | 5.6  | 4.1  | 1.72 | 5.2  | 3.9  | 1.69 | 4.1  | 3.4  | 1.29 |     |      |
|   | 22  |  |   | 6.8                              | 3.5 | 1.58 | 6.4  | 3.3  | 1.68 | 6.1  | 3.2  | 1.77 | 5.5  | 3.0  | 1.72 | 4.4  | 2.6  | 1.30 |     |      |
| 29  | 16  |  |   | 5.9                              | 5.9 | 1.50 | 5.5  | 5.5  | 1.59 | 5.2  | 5.2  | 1.69 | 4.8  | 4.8  | 1.67 | 3.9  | 3.9  | 1.28 |     |      |
|   | 19  |  |   | 6.3                              | 4.9 | 1.53 | 6.0  | 4.8  | 1.63 | 5.6  | 4.6  | 1.72 | 5.2  | 4.4  | 1.69 | 4.1  | 4.0  | 1.29 |     |      |
|   | 22  |  |   | 6.8                              | 4.0 | 1.58 | 6.4  | 3.8  | 1.68 | 6.1  | 3.7  | 1.77 | 5.5  | 3.5  | 1.72 | 4.4  | 3.1  | 1.30 |     |      |
| 32  | 16  |  |   | 5.9                              | 5.9 | 1.50 | 5.5  | 5.5  | 1.59 | 5.2  | 5.2  | 1.69 | 4.8  | 4.8  | 1.67 | 3.9  | 3.9  | 1.28 |     |      |
|   | 19  |  |   | 6.3                              | 5.7 | 1.53 | 6.0  | 5.6  | 1.63 | 5.6  | 5.4  | 1.72 | 5.2  | 5.2  | 1.69 | 4.1  | 4.1  | 1.29 |     |      |
|   | 22  |  |   | 6.8                              | 4.8 | 1.58 | 6.4  | 4.6  | 1.68 | 6.1  | 4.5  | 1.77 | 5.5  | 4.3  | 1.72 | 4.4  | 3.9  | 1.30 |     |      |
| S-60PK1E5A<br>U-60PE2E5A                    | 220V-230V-240V<br>50Hz 1phase                                     |  |   | 23                               | 16  | 7.1  | 5.2  | 1.93 | 6.8  | 5.1  | 2.11 | 6.5  | 4.9  | 2.29 | 6.1  | 4.7  | 2.22 | 5.0  | 4.2 | 1.47 |
|   |   |  |   |                                  | 19  | 7.8  | 4.1  | 1.99 | 7.4  | 3.9  | 2.17 | 7.1  | 3.8  | 2.35 | 6.7  | 3.6  | 2.28 | 5.3  | 3.1 | 1.50 |
|   |   |  |   |                                  | 22  | 8.6  | 3.0  | 2.03 | 8.2  | 2.9  | 2.21 | 7.8  | 2.7  | 2.40 | 7.3  | 2.5  | 2.33 | 5.7  | 2.0 | 1.52 |
|   |   | 25                                       | 16  | 7.1                              | 5.9 | 1.93 | 6.8  | 5.8  | 2.11 | 6.5  | 5.6  | 2.29 | 6.1  | 5.4  | 2.22 | 5.0  | 4.9  | 1.47 |     |      |
|   |   |  | 19  | 7.8                              | 4.8 | 1.99 | 7.4  | 4.6  | 2.17 | 7.1  | 4.5  | 2.35 | 6.7  | 4.3  | 2.28 | 5.3  | 3.8  | 1.50 |     |      |
|   |   |  | 22  | 8.6                              | 3.7 | 2.03 | 8.2  | 3.6  | 2.21 | 7.8  | 3.4  | 2.40 | 7.3  | 3.2  | 2.33 | 5.7  | 2.6  | 1.52 |     |      |
|   |   | 27                                       | 16  | 7.1                              | 6.6 | 1.93 | 6.8  | 6.5  | 2.11 | 6.5  | 6.3  | 2.29 | 6.1  | 6.1  | 2.22 | 5.0  | 5.0  | 1.47 |     |      |
|   |   |  | 19  | 7.8                              | 5.5 | 1.99 | 7.4  | 5.3  | 2.17 | 7.1  | 5.2  | 2.35 | 6.7  | 5.0  | 2.28 | 5.3  | 4.4  | 1.50 |     |      |
|   |   |  | 22  | 8.6                              | 4.4 | 2.03 | 8.2  | 4.2  | 2.21 | 7.8  | 4.1  | 2.40 | 7.3  | 3.9  | 2.33 | 5.7  | 3.3  | 1.52 |     |      |
|   |   | 29                                       | 16  | 7.1                              | 7.1 | 1.93 | 6.8  | 6.8  | 2.11 | 6.5  | 6.5  | 2.29 | 6.1  | 6.1  | 2.22 | 5.0  | 5.0  | 1.47 |     |      |
|   |   |  | 19  | 7.8                              | 6.2 | 1.99 | 7.4  | 6.0  | 2.17 | 7.1  | 5.9  | 2.35 | 6.7  | 5.7  | 2.28 | 5.3  | 5.1  | 1.50 |     |      |
|   |   |  | 22  | 8.6                              | 5.1 | 2.03 | 8.2  | 4.9  | 2.21 | 7.8  | 4.7  | 2.40 | 7.3  | 4.6  | 2.33 | 5.7  | 4.0  | 1.52 |     |      |
|   |   | 32                                       | 16  | 7.1                              | 7.1 | 1.93 | 6.8  | 6.8  | 2.11 | 6.5  | 6.5  | 2.29 | 6.1  | 6.1  | 2.22 | 5.0  | 5.0  | 1.47 |     |      |
|   |   |  | 19  | 7.8                              | 7.2 | 1.99 | 7.4  | 7.0  | 2.17 | 7.1  | 6.9  | 2.35 | 6.7  | 6.7  | 2.28 | 5.3  | 5.3  | 1.50 |     |      |
|   |   |  | 22  | 8.6                              | 6.1 | 2.03 | 8.2  | 5.9  | 2.21 | 7.8  | 5.8  | 2.40 | 7.3  | 5.6  | 2.33 | 5.7  | 5.0  | 1.52 |     |      |
|   |   | S-71PK1E5A<br>U-71PE1E5A<br>(U-71PE1E8A) | 220V-230V-240V<br>50Hz 1phase<br>(380V-400V-415V<br>50Hz 3 phase) | 23                               | 16  | 8.1  | 6.0  | 2.25 | 7.9  | 5.9  | 2.41 | 7.6  | 5.7  | 2.59 | 7.2  | 5.5  | 2.57 | 6.3  | 5.1 | 2.20 |
|   |   |  |   |                                  | 19  | 8.5  | 4.5  | 2.33 | 8.3  | 4.4  | 2.49 | 8.0  | 4.3  | 2.65 | 7.5  | 4.0  | 2.60 | 6.6  | 3.8 | 2.23 |
|   |   |  |   |                                  | 22  | 9.0  | 3.2  | 2.44 | 8.7  | 3.1  | 2.58 | 8.3  | 2.9  | 2.73 | 7.8  | 2.7  | 2.62 | 6.8  | 2.4 | 2.25 |
| 25  | 16  |  |   | 8.1                              | 6.8 | 2.25 | 7.9  | 6.7  | 2.41 | 7.6  | 6.5  | 2.59 | 7.2  | 6.3  | 2.57 | 6.3  | 5.9  | 2.20 |     |      |
|   | 19  |  |   | 8.5                              | 5.3 | 2.33 | 8.3  | 5.2  | 2.49 | 8.0  | 5.1  | 2.65 | 7.5  | 4.8  | 2.60 | 6.6  | 4.6  | 2.23 |     |      |
|   | 22  |  |   | 9.0                              | 3.9 | 2.44 | 8.7  | 3.8  | 2.58 | 8.3  | 3.7  | 2.73 | 7.8  | 3.5  | 2.62 | 6.8  | 3.2  | 2.25 |     |      |
| 27  | 16  |  |   | 8.1                              | 7.5 | 2.25 | 7.9  | 7.4  | 2.41 | 7.6  | 7.3  | 2.59 | 7.2  | 7.1  | 2.57 | 6.3  | 6.3  | 2.20 |     |      |
|   | 19  |  |   | 8.5                              | 6.1 | 2.33 | 8.3  | 6.0  | 2.49 | 8.0  | 5.9  | 2.65 | 7.5  | 5.6  | 2.60 | 6.6  | 5.3  | 2.23 |     |      |
|   | 22  |  |   | 9.0                              | 4.7 | 2.44 | 8.7  | 4.5  | 2.58 | 8.3  | 4.4  | 2.73 | 7.8  | 4.3  | 2.62 | 6.8  | 3.9  | 2.25 |     |      |
| 29  | 16  |  |   | 8.1                              | 8.1 | 2.25 | 7.9  | 7.9  | 2.41 | 7.6  | 7.6  | 2.59 | 7.2  | 7.2  | 2.57 | 6.3  | 6.3  | 2.20 |     |      |
|   | 19  |  |   | 8.5                              | 6.9 | 2.33 | 8.3  | 6.8  | 2.49 | 8.0  | 6.6  | 2.65 | 7.5  | 6.4  | 2.60 | 6.6  | 6.0  | 2.23 |     |      |
|   | 22  |  |   | 9.0                              | 5.5 | 2.44 | 8.7  | 5.3  | 2.58 | 8.3  | 5.2  | 2.73 | 7.8  | 5.0  | 2.62 | 6.8  | 4.6  | 2.25 |     |      |
| 32  | 16  |  |   | 8.1                              | 8.1 | 2.25 | 7.9  | 7.9  | 2.41 | 7.6  | 7.6  | 2.59 | 7.2  | 7.2  | 2.57 | 6.3  | 6.3  | 2.20 |     |      |
|   | 19  |  |   | 8.5                              | 6.9 | 2.33 | 8.3  | 6.8  | 2.49 | 8.0  | 6.6  | 2.65 | 7.5  | 6.4  | 2.60 | 6.6  | 6.0  | 2.23 |     |      |
|   | 22  |  |   | 9.0                              | 5.5 | 2.44 | 8.7  | 5.3  | 2.58 | 8.3  | 5.2  | 2.73 | 7.8  | 5.0  | 2.62 | 6.8  | 4.6  | 2.25 |     |      |
| S-100PK1E5A<br>U-100PE1E5A<br>(U-100PE1E8A) | 220V-230V-240V<br>50Hz 1phase<br>(380V-400V-415V<br>50Hz 3 phase) |  |   | 23                               | 16  | 9.6  | 6.5  | 2.76 | 9.6  | 6.5  | 2.96 | 9.2  | 6.3  | 3.15 | 8.5  | 5.9  | 3.28 | 6.2  | 4.8 | 2.68 |
|   |   |  |   |                                  | 19  | 10.2 | 5.1  | 2.88 | 10.2 | 5.1  | 3.09 | 9.8  | 4.9  | 3.29 | 9.1  | 4.6  | 3.42 | 6.7  | 3.6 | 2.80 |
|   |   |  |   |                                  | 22  | 11.2 | 4.0  | 2.98 | 11.2 | 4.0  | 3.20 | 10.7 | 3.8  | 3.40 | 10.0 | 3.5  | 3.54 | 7.3  | 2.5 | 2.89 |
|   |   | 25                                       | 16  | 9.9                              | 7.4 | 2.81 | 9.9  | 7.4  | 3.01 | 9.5  | 7.1  | 3.21 | 8.8  | 6.8  | 3.33 | 6.5  | 5.6  | 2.73 |     |      |
|   |   |  | 19  | 10.6                             | 6.0 | 2.93 | 10.6 | 6.0  | 3.14 | 10.2 | 5.9  | 3.34 | 9.4  | 5.5  | 3.48 | 6.9  | 4.4  | 2.84 |     |      |
|   |   |  | 22  | 11.6                             | 4.8 | 3.03 | 11.6 | 4.8  | 3.25 | 11.1 | 4.6  | 3.46 | 10.3 | 4.3  | 3.60 | 7.6  | 3.3  | 2.94 |     |      |
|   |   | 27                                       | 16  | 10.2                             | 8.2 | 2.85 | 10.2 | 8.2  | 3.06 | 9.8  | 8.0  | 3.26 | 9.1  | 7.7  | 3.39 | 6.7  | 6.5  | 2.77 |     |      |
|   |   |  | 19  | 10.9                             | 6.9 | 2.98 | 10.9 | 6.9  | 3.20 | 10.5 | 6.7  | 3.40 | 9.8  | 6.4  | 3.54 | 7.1  | 5.2  | 2.89 |     |      |
|   |   |  | 22  | 12.0                             | 5.7 | 3.08 | 12.0 | 5.7  | 3.31 | 11.5 | 5.5  | 3.52 | 10.7 | 5.2  | 3.66 | 7.8  | 4.1  | 2.99 |     |      |
|   |   | 29                                       | 16  | 10.4                             | 9.1 | 2.86 | 10.4 | 9.1  | 3.07 | 10.0 | 8.9  | 3.27 | 9.3  | 8.5  | 3.40 | 6.8  | 6.8  | 2.78 |     |      |
|   |   |  | 19  | 11.1                             | 7.7 | 2.98 | 11.1 | 7.7  | 3.20 | 10.7 | 7.6  | 3.41 | 9.9  | 7.2  | 3.54 | 7.2  | 6.0  | 2.90 |     |      |
|   |   |  | 22  | 12.1                             | 6.5 | 3.09 | 12.1 | 6.5  | 3.31 | 11.7 | 6.3  | 3.53 | 10.9 | 6.0  | 3.67 | 7.9  | 4.8  | 3.00 |     |      |
|   |   | 32                                       | 16  | 10.5                             | 9.2 | 2.87 | 10.5 | 9.2  | 3.08 | 10.1 | 9.0  | 3.28 | 9.4  | 8.6  | 3.41 | 6.9  | 6.9  | 2.78 |     |      |
|   |   |  | 19  | 11.2                             | 7.8 | 2.99 | 11.2 | 7.8  | 3.21 | 10.8 | 7.6  | 3.42 | 10.1 | 7.3  | 3.55 | 7.4  | 6.0  | 2.90 |     |      |
|   |   |  | 22  | 12.3                             | 6.6 | 3.09 | 12.3 | 6.6  | 3.32 | 11.8 | 6.4  | 3.53 | 11.0 | 6.0  | 3.68 | 8.1  | 4.9  | 3.00 |     |      |

1-13. Capacity Table

1. Cooling Capacity Performance Data

• Combination of Multiple Unit

Wall Mounted Type

TC :Cooling Capacity

SHC :Sensible Heat Capacity

IPT :Cooling Power Consumption

unit : kW

| Model  | Power Source  | Ambient Return Air                           |   | Outdoor air intake temp(°C D.B.) |      |      |      |      |      |      |      |      |      |      |      |      |      |      |     |      |
|--|---|--|---|----------------------------------|------|------|------|------|------|------|------|------|------|------|------|------|------|------|-----|------|
|  |   |  |   | 25°C                             |      |      | 30°C |      |      | 35°C |      |      | 40°C |      |      | 46°C |      |      |     |      |
|  |   | DB   | WB  | TC                               | SHC  | IPT  | TC   | SHC  | IPT  | TC   | SHC  | IPT  | TC   | SHC  | IPT  | TC   | SHC  | IPT  |     |      |
| S-36PK1E5A×2<br>U-71PE1E5A<br>(U-71PE1E8A)   | 220V-230V-240V<br>50Hz 1phase<br>(380V-400V-415V<br>50Hz 3 phase) | 23   | 16  | 8.1                              | 6.4  | 2.25 | 7.9  | 6.3  | 2.41 | 7.6  | 6.1  | 2.59 | 7.2  | 6.0  | 2.57 | 6.3  | 5.5  | 2.20 |     |      |
|  |   |  | 19  | 8.5                              | 4.8  | 2.33 | 8.3  | 4.7  | 2.49 | 8.0  | 4.5  | 2.65 | 7.5  | 4.4  | 2.60 | 6.6  | 4.0  | 2.23 |     |      |
|  |   |  | 22  | 9.0                              | 3.2  | 2.44 | 8.7  | 3.1  | 2.58 | 8.3  | 2.9  | 2.73 | 7.8  | 2.7  | 2.62 | 6.8  | 2.4  | 2.25 |     |      |
|  |   | 25   | 16  | 8.1                              | 7.3  | 2.25 | 7.9  | 7.2  | 2.41 | 7.6  | 7.1  | 2.59 | 7.2  | 6.9  | 2.57 | 6.3  | 6.3  | 2.20 |     |      |
|  |   |  | 19  | 8.5                              | 5.7  | 2.33 | 8.3  | 5.6  | 2.49 | 8.0  | 5.4  | 2.65 | 7.5  | 5.3  | 2.60 | 6.6  | 4.9  | 2.23 |     |      |
|  |   |  | 22  | 9.0                              | 4.1  | 2.44 | 8.7  | 4.0  | 2.58 | 8.3  | 3.8  | 2.73 | 7.8  | 3.6  | 2.62 | 6.8  | 3.3  | 2.25 |     |      |
|  |   | 27   | 16  | 8.1                              | 8.1  | 2.25 | 7.9  | 7.9  | 2.41 | 7.6  | 7.6  | 2.59 | 7.2  | 7.2  | 2.57 | 6.3  | 6.3  | 2.20 |     |      |
|  |   |  | 19  | 8.5                              | 6.6  | 2.33 | 8.3  | 6.6  | 2.49 | 8.0  | 6.4  | 2.65 | 7.5  | 6.2  | 2.60 | 6.6  | 5.9  | 2.23 |     |      |
|  |   |  | 22  | 9.0                              | 5.0  | 2.44 | 8.7  | 4.9  | 2.58 | 8.3  | 4.7  | 2.73 | 7.8  | 4.5  | 2.62 | 6.8  | 4.2  | 2.25 |     |      |
|  |   | 29   | 16  | 8.1                              | 8.1  | 2.25 | 7.9  | 7.9  | 2.41 | 7.6  | 7.6  | 2.59 | 7.2  | 7.2  | 2.57 | 6.3  | 6.3  | 2.20 |     |      |
|  |   |  | 19  | 8.5                              | 7.6  | 2.33 | 8.3  | 7.5  | 2.49 | 8.0  | 7.3  | 2.65 | 7.5  | 7.1  | 2.60 | 6.6  | 6.6  | 2.23 |     |      |
|  |   |  | 22  | 9.0                              | 6.0  | 2.44 | 8.7  | 5.8  | 2.58 | 8.3  | 5.6  | 2.73 | 7.8  | 5.4  | 2.62 | 6.8  | 5.1  | 2.25 |     |      |
|  |   | 32   | 16  | 8.1                              | 8.1  | 2.25 | 7.9  | 7.9  | 2.41 | 7.6  | 7.6  | 2.59 | 7.2  | 7.2  | 2.57 | 6.3  | 6.3  | 2.20 |     |      |
|  |   |  | 19  | 8.5                              | 7.6  | 2.33 | 8.3  | 7.5  | 2.49 | 8.0  | 7.3  | 2.65 | 7.5  | 7.1  | 2.60 | 6.6  | 6.6  | 2.23 |     |      |
|  |   |  | 22  | 9.0                              | 6.0  | 2.44 | 8.7  | 5.8  | 2.58 | 8.3  | 5.6  | 2.73 | 7.8  | 5.4  | 2.62 | 6.8  | 5.1  | 2.25 |     |      |
|  |   | S-36PK1E5A×3<br>U-100PE1E5A<br>(U-100PE1E8A) | 220V-230V-240V<br>50Hz 1phase<br>(380V-400V-415V<br>50Hz 3 phase) | 23                               | 16   | 11.4 | 9.3  | 3.00 | 11.4 | 9.3  | 3.23 | 10.9 | 9.0  | 3.43 | 10.2 | 8.9  | 3.57 | 7.4  | 7.4 | 2.92 |
|  |   |  |   |                                  | 19   | 12.1 | 6.9  | 3.13 | 12.1 | 6.9  | 3.36 | 11.7 | 6.8  | 3.58 | 10.9 | 6.5  | 3.72 | 7.9  | 5.2 | 3.04 |
|  |   |  |   |                                  | 22   | 13.3 | 4.6  | 3.24 | 13.3 | 4.6  | 3.48 | 12.8 | 4.5  | 3.70 | 11.9 | 4.1  | 3.85 | 8.7  | 3.1 | 3.15 |
|  |   |  |   | 25                               | 16   | 11.8 | 11.2 | 3.05 | 11.8 | 11.2 | 3.28 | 11.3 | 10.8 | 3.49 | 10.5 | 10.5 | 3.63 | 7.7  | 7.7 | 2.97 |
|  |   |  |   |                                  | 19   | 12.6 | 8.8  | 3.18 | 12.6 | 8.8  | 3.42 | 12.1 | 8.5  | 3.64 | 11.2 | 8.2  | 3.79 | 8.2  | 7.0 | 3.09 |
|  |   |  |   |                                  | 22   | 13.8 | 6.3  | 3.29 | 13.8 | 6.3  | 3.54 | 13.2 | 6.2  | 3.77 | 12.3 | 5.8  | 3.92 | 9.0  | 4.7 | 3.20 |
|  |   |  |   | 27                               | 16   | 12.2 | 12.2 | 3.10 | 12.2 | 12.2 | 3.33 | 11.7 | 11.7 | 3.55 | 10.9 | 10.9 | 3.69 | 8.0  | 8.0 | 3.02 |
|  |   |  |   |                                  | 19   | 13.0 | 10.6 | 3.24 | 13.0 | 10.6 | 3.48 | 12.5 | 10.4 | 3.70 | 11.6 | 10.1 | 3.85 | 8.5  | 8.5 | 3.15 |
|  |   |  |   |                                  | 22   | 14.2 | 8.2  | 3.35 | 14.2 | 8.2  | 3.60 | 13.7 | 8.0  | 3.83 | 12.7 | 7.8  | 3.98 | 9.3  | 6.4 | 3.25 |
| 29   | 16  |  |   | 12.4                             | 12.4 | 3.11 | 12.4 | 12.4 | 3.34 | 11.9 | 11.9 | 3.56 | 11.0 | 11.0 | 3.70 | 8.1  | 8.1  | 3.02 |     |      |
|  | 19  |  |   | 13.2                             | 12.4 | 3.25 | 13.2 | 12.4 | 3.49 | 12.7 | 12.1 | 3.71 | 11.8 | 11.8 | 3.86 | 8.6  | 8.6  | 3.15 |     |      |
|  | 22  |  |   | 14.5                             | 10.0 | 3.36 | 14.5 | 10.0 | 3.61 | 13.9 | 9.7  | 3.84 | 12.9 | 9.5  | 3.99 | 9.5  | 8.1  | 3.26 |     |      |
| 32   | 16  |  |   | 12.5                             | 12.5 | 3.12 | 12.5 | 12.5 | 3.35 | 12.1 | 12.1 | 3.56 | 11.2 | 11.2 | 3.71 | 8.2  | 8.2  | 3.03 |     |      |
|  | 19  |  |   | 13.4                             | 12.6 | 3.25 | 13.4 | 12.6 | 3.50 | 12.9 | 12.3 | 3.72 | 12.0 | 12.0 | 3.87 | 8.8  | 8.8  | 3.16 |     |      |
|  | 22  |  |   | 14.7                             | 10.2 | 3.37 | 14.7 | 10.2 | 3.62 | 14.1 | 9.8  | 3.85 | 13.1 | 9.7  | 4.00 | 9.6  | 8.2  | 3.27 |     |      |
| S-50PK1E5A×2<br>U-100PE1E5A<br>(U-100PE1E8A) | 220V-230V-240V<br>50Hz 1phase<br>(380V-400V-415V<br>50Hz 3 phase) |  |   | 23                               | 16   | 11.4 | 8.7  | 3.00 | 11.4 | 8.7  | 3.23 | 10.9 | 8.4  | 3.43 | 10.2 | 8.2  | 3.57 | 7.4  | 6.9 | 2.92 |
|  |   |  |   |                                  | 19   | 12.1 | 6.6  | 3.13 | 12.1 | 6.6  | 3.36 | 11.7 | 6.4  | 3.58 | 10.9 | 6.2  | 3.72 | 7.9  | 4.9 | 3.04 |
|  |   |  |   |                                  | 22   | 13.3 | 4.6  | 3.24 | 13.3 | 4.6  | 3.48 | 12.8 | 4.5  | 3.70 | 11.9 | 4.1  | 3.85 | 8.7  | 3.1 | 3.15 |
|  |   |  |   | 25                               | 16   | 11.8 | 10.4 | 3.05 | 11.8 | 10.4 | 3.28 | 11.3 | 10.0 | 3.49 | 10.5 | 9.8  | 3.63 | 7.7  | 7.7 | 2.97 |
|  |   |  |   |                                  | 19   | 12.6 | 8.2  | 3.18 | 12.6 | 8.2  | 3.42 | 12.1 | 7.9  | 3.64 | 11.2 | 7.7  | 3.79 | 8.2  | 6.4 | 3.09 |
|  |   |  |   |                                  | 22   | 13.8 | 6.2  | 3.29 | 13.8 | 6.2  | 3.54 | 13.2 | 5.9  | 3.77 | 12.3 | 5.6  | 3.92 | 9.0  | 4.4 | 3.20 |
|  |   |  |   | 27                               | 16   | 12.2 | 12.0 | 3.10 | 12.2 | 12.0 | 3.33 | 11.7 | 11.6 | 3.55 | 10.9 | 10.9 | 3.69 | 8.0  | 8.0 | 3.02 |
|  |   |  |   |                                  | 19   | 13.0 | 9.8  | 3.24 | 13.0 | 9.8  | 3.48 | 12.5 | 9.5  | 3.70 | 11.6 | 9.3  | 3.85 | 8.5  | 7.9 | 3.15 |
|  |   |  |   |                                  | 22   | 14.2 | 7.7  | 3.35 | 14.2 | 7.7  | 3.60 | 13.7 | 7.4  | 3.83 | 12.7 | 7.2  | 3.98 | 9.3  | 5.9 | 3.25 |
|  |   | 29   | 16  | 12.4                             | 12.4 | 3.11 | 12.4 | 12.4 | 3.34 | 11.9 | 11.9 | 3.56 | 11.0 | 11.0 | 3.70 | 8.1  | 8.1  | 3.02 |     |      |
|  |   |  | 19  | 13.2                             | 11.4 | 3.25 | 13.2 | 11.4 | 3.49 | 12.7 | 11.0 | 3.71 | 11.8 | 10.9 | 3.86 | 8.6  | 8.6  | 3.15 |     |      |
|  |   |  | 22  | 14.5                             | 9.4  | 3.36 | 14.5 | 9.4  | 3.61 | 13.9 | 9.0  | 3.84 | 12.9 | 8.7  | 3.99 | 9.5  | 7.4  | 3.26 |     |      |
|  |   | 32   | 16  | 12.5                             | 12.5 | 3.12 | 12.5 | 12.5 | 3.35 | 12.1 | 12.1 | 3.56 | 11.2 | 11.2 | 3.71 | 8.2  | 8.2  | 3.03 |     |      |
|  |   |  | 19  | 13.4                             | 11.6 | 3.25 | 13.4 | 11.6 | 3.50 | 12.9 | 11.2 | 3.72 | 12.0 | 11.1 | 3.87 | 8.8  | 8.8  | 3.16 |     |      |
|  |   |  | 22  | 14.7                             | 9.5  | 3.37 | 14.7 | 9.5  | 3.62 | 14.1 | 9.1  | 3.85 | 13.1 | 8.8  | 4.00 | 9.6  | 7.5  | 3.27 |     |      |



1-13. Capacity Table

1. Cooling Capacity Performance Data

TC :Cooling Capacity

SHC :Sensible Heat Capacity

IPT :Cooling Power Consumption

• Combination of Single Unit

Low Silhouette Ducted Type

unit : kW

| Model                    | Power Source                  | Ambient Return Air       |                               | Outdoor air intake temp(°C D.B.) |     |      |      |      |      |      |      |      |      |      |      |      |      |      |     |      |
|--------------------------|-------------------------------|--------------------------|-------------------------------|----------------------------------|-----|------|------|------|------|------|------|------|------|------|------|------|------|------|-----|------|
|                          |                               |                          |                               | 25°C                             |     |      | 30°C |      |      | 35°C |      |      | 40°C |      |      | 46°C |      |      |     |      |
|                          |                               | DB                       | WB                            | TC                               | SHC | IPT  | TC   | SHC  | IPT  | TC   | SHC  | IPT  | TC   | SHC  | IPT  | TC   | SHC  | IPT  |     |      |
| S-36PF1E5A<br>U-36PE2E5A | 220V-230V-240V<br>50Hz 1phase | 23                       | 16                            | 4.2                              | 3.5 | 0.87 | 4.0  | 3.4  | 0.93 | 3.7  | 3.2  | 0.98 | 3.4  | 3.1  | 0.97 | 2.8  | 2.8  | 0.74 |     |      |
|                          |                               |                          | 19                            | 4.5                              | 2.6 | 0.89 | 4.3  | 2.5  | 0.95 | 4.0  | 2.4  | 1.00 | 3.7  | 2.3  | 0.98 | 3.0  | 2.0  | 0.75 |     |      |
|                          |                               |                          | 22                            | 4.8                              | 1.6 | 0.92 | 4.6  | 1.6  | 0.97 | 4.3  | 1.5  | 1.03 | 4.0  | 1.4  | 1.00 | 3.1  | 1.1  | 0.76 |     |      |
|                          |                               | 25                       | 16                            | 4.2                              | 4.0 | 0.87 | 4.0  | 3.9  | 0.93 | 3.7  | 3.7  | 0.98 | 3.4  | 3.4  | 0.97 | 2.8  | 2.8  | 0.74 |     |      |
|                          |                               |                          | 19                            | 4.5                              | 3.1 | 0.89 | 4.3  | 3.0  | 0.95 | 4.0  | 2.9  | 1.00 | 3.7  | 2.8  | 0.98 | 3.0  | 2.5  | 0.75 |     |      |
|                          |                               |                          | 22                            | 4.8                              | 2.2 | 0.92 | 4.6  | 2.1  | 0.97 | 4.3  | 2.0  | 1.03 | 4.0  | 1.9  | 1.00 | 3.1  | 1.6  | 0.76 |     |      |
|                          |                               | 27                       | 16                            | 4.2                              | 4.2 | 0.87 | 4.0  | 4.0  | 0.93 | 3.7  | 3.7  | 0.98 | 3.4  | 3.4  | 0.97 | 2.8  | 2.8  | 0.74 |     |      |
|                          |                               |                          | 19                            | 4.5                              | 3.6 | 0.89 | 4.3  | 3.6  | 0.95 | 4.0  | 3.4  | 1.00 | 3.7  | 3.3  | 0.98 | 3.0  | 3.0  | 0.75 |     |      |
|                          |                               |                          | 22                            | 4.8                              | 2.7 | 0.92 | 4.6  | 2.6  | 0.97 | 4.3  | 2.5  | 1.03 | 4.0  | 2.4  | 1.00 | 3.1  | 2.1  | 0.76 |     |      |
|                          |                               | 29                       | 16                            | 4.2                              | 4.2 | 0.87 | 4.0  | 4.0  | 0.93 | 3.7  | 3.7  | 0.98 | 3.4  | 3.4  | 0.97 | 2.8  | 2.8  | 0.74 |     |      |
|                          |                               |                          | 19                            | 4.5                              | 4.2 | 0.89 | 4.3  | 4.1  | 0.95 | 4.0  | 4.0  | 1.00 | 3.7  | 3.7  | 0.98 | 3.0  | 3.0  | 0.75 |     |      |
|                          |                               |                          | 22                            | 4.8                              | 3.3 | 0.92 | 4.6  | 3.2  | 0.97 | 4.3  | 3.1  | 1.03 | 4.0  | 3.0  | 1.00 | 3.1  | 2.7  | 0.76 |     |      |
|                          |                               | 32                       | 16                            | 4.2                              | 4.2 | 0.87 | 4.0  | 4.0  | 0.93 | 3.7  | 3.7  | 0.98 | 3.4  | 3.4  | 0.97 | 2.8  | 2.8  | 0.74 |     |      |
|                          |                               |                          | 19                            | 4.5                              | 4.5 | 0.89 | 4.3  | 4.3  | 0.95 | 4.0  | 4.0  | 1.00 | 3.7  | 3.7  | 0.98 | 3.0  | 3.0  | 0.75 |     |      |
|                          |                               |                          | 22                            | 4.8                              | 4.0 | 0.92 | 4.6  | 4.0  | 0.97 | 4.3  | 3.9  | 1.03 | 4.0  | 3.8  | 1.00 | 3.1  | 3.1  | 0.76 |     |      |
|                          |                               | S-50PF1E5A<br>U-50PE2E5A | 220V-230V-240V<br>50Hz 1phase | 23                               | 16  | 5.9  | 4.5  | 1.40 | 5.5  | 4.3  | 1.48 | 5.2  | 4.2  | 1.57 | 4.8  | 4.0  | 1.55 | 3.9  | 3.6 | 1.19 |
|                          |                               |                          |                               |                                  | 19  | 6.3  | 3.4  | 1.43 | 6.0  | 3.3  | 1.51 | 5.6  | 3.1  | 1.60 | 5.2  | 3.0  | 1.57 | 4.1  | 2.5 | 1.20 |
|                          |                               |                          |                               |                                  | 22  | 6.8  | 2.4  | 1.47 | 6.4  | 2.2  | 1.56 | 6.1  | 2.1  | 1.64 | 5.5  | 1.9  | 1.60 | 4.4  | 1.5 | 1.21 |
| 25                       | 16                            |                          |                               | 5.9                              | 5.1 | 1.40 | 5.5  | 4.9  | 1.48 | 5.2  | 4.8  | 1.57 | 4.8  | 4.6  | 1.55 | 3.9  | 3.9  | 1.19 |     |      |
|                          | 19                            |                          |                               | 6.3                              | 4.0 | 1.43 | 6.0  | 3.9  | 1.51 | 5.6  | 3.7  | 1.60 | 5.2  | 3.6  | 1.57 | 4.1  | 3.1  | 1.20 |     |      |
|                          | 22                            |                          |                               | 6.8                              | 3.0 | 1.47 | 6.4  | 2.8  | 1.56 | 6.1  | 2.7  | 1.64 | 5.5  | 2.5  | 1.60 | 4.4  | 2.1  | 1.21 |     |      |
| 27                       | 16                            |                          |                               | 5.9                              | 5.8 | 1.40 | 5.5  | 5.5  | 1.48 | 5.2  | 5.2  | 1.57 | 4.8  | 4.8  | 1.55 | 3.9  | 3.9  | 1.19 |     |      |
|                          | 19                            |                          |                               | 6.3                              | 4.6 | 1.43 | 6.0  | 4.5  | 1.51 | 5.6  | 4.4  | 1.60 | 5.2  | 4.2  | 1.57 | 4.1  | 3.8  | 1.20 |     |      |
|                          | 22                            |                          |                               | 6.8                              | 3.6 | 1.47 | 6.4  | 3.5  | 1.56 | 6.1  | 3.3  | 1.64 | 5.5  | 3.1  | 1.60 | 4.4  | 2.7  | 1.21 |     |      |
| 29                       | 16                            |                          |                               | 5.9                              | 5.9 | 1.40 | 5.5  | 5.5  | 1.48 | 5.2  | 5.2  | 1.57 | 4.8  | 4.8  | 1.55 | 3.9  | 3.9  | 1.19 |     |      |
|                          | 19                            |                          |                               | 6.3                              | 5.3 | 1.43 | 6.0  | 5.1  | 1.51 | 5.6  | 5.0  | 1.60 | 5.2  | 4.8  | 1.57 | 4.1  | 4.1  | 1.20 |     |      |
|                          | 22                            |                          |                               | 6.8                              | 4.2 | 1.47 | 6.4  | 4.1  | 1.56 | 6.1  | 3.9  | 1.64 | 5.5  | 3.7  | 1.60 | 4.4  | 3.3  | 1.21 |     |      |
| 32                       | 16                            |                          |                               | 5.9                              | 5.9 | 1.40 | 5.5  | 5.5  | 1.48 | 5.2  | 5.2  | 1.57 | 4.8  | 4.8  | 1.55 | 3.9  | 3.9  | 1.19 |     |      |
|                          | 19                            |                          |                               | 6.3                              | 6.2 | 1.43 | 6.0  | 6.0  | 1.51 | 5.6  | 5.6  | 1.60 | 5.2  | 5.2  | 1.57 | 4.1  | 4.1  | 1.20 |     |      |
|                          | 22                            |                          |                               | 6.8                              | 5.1 | 1.47 | 6.4  | 5.0  | 1.56 | 6.1  | 4.9  | 1.64 | 5.5  | 4.6  | 1.60 | 4.4  | 4.3  | 1.21 |     |      |
| S-60PF1E5A<br>U-60PE2E5A | 220V-230V-240V<br>50Hz 1phase |                          |                               | 23                               | 16  | 7.1  | 5.6  | 1.93 | 6.8  | 5.4  | 2.11 | 6.5  | 5.3  | 2.29 | 6.1  | 5.1  | 2.22 | 5.0  | 4.6 | 1.47 |
|                          |                               |                          |                               |                                  | 19  | 7.8  | 4.3  | 1.99 | 7.4  | 4.1  | 2.17 | 7.1  | 4.0  | 2.35 | 6.7  | 3.8  | 2.28 | 5.3  | 3.3 | 1.50 |
|                          |                               |                          |                               |                                  | 22  | 8.6  | 3.0  | 2.03 | 8.2  | 2.8  | 2.21 | 7.8  | 2.7  | 2.40 | 7.3  | 2.5  | 2.33 | 5.7  | 2.0 | 1.52 |
|                          |                               | 25                       | 16                            | 7.1                              | 6.4 | 1.93 | 6.8  | 6.3  | 2.11 | 6.5  | 6.1  | 2.29 | 6.1  | 5.9  | 2.22 | 5.0  | 5.0  | 1.47 |     |      |
|                          |                               |                          | 19                            | 7.8                              | 5.1 | 1.99 | 7.4  | 4.9  | 2.17 | 7.1  | 4.8  | 2.35 | 6.7  | 4.6  | 2.28 | 5.3  | 4.1  | 1.50 |     |      |
|                          |                               |                          | 22                            | 8.6                              | 3.8 | 2.03 | 8.2  | 3.6  | 2.21 | 7.8  | 3.5  | 2.40 | 7.3  | 3.3  | 2.33 | 5.7  | 2.8  | 1.52 |     |      |
|                          |                               | 27                       | 16                            | 7.1                              | 7.1 | 1.93 | 6.8  | 6.8  | 2.11 | 6.5  | 6.5  | 2.29 | 6.1  | 6.1  | 2.22 | 5.0  | 5.0  | 1.47 |     |      |
|                          |                               |                          | 19                            | 7.8                              | 5.9 | 1.99 | 7.4  | 5.7  | 2.17 | 7.1  | 5.6  | 2.35 | 6.7  | 5.4  | 2.28 | 5.3  | 4.9  | 1.50 |     |      |
|                          |                               |                          | 22                            | 8.6                              | 4.6 | 2.03 | 8.2  | 4.4  | 2.21 | 7.8  | 4.3  | 2.40 | 7.3  | 4.1  | 2.33 | 5.7  | 3.6  | 1.52 |     |      |
|                          |                               | 29                       | 16                            | 7.1                              | 7.1 | 1.93 | 6.8  | 6.8  | 2.11 | 6.5  | 6.5  | 2.29 | 6.1  | 6.1  | 2.22 | 5.0  | 5.0  | 1.47 |     |      |
|                          |                               |                          | 19                            | 7.8                              | 6.7 | 1.99 | 7.4  | 6.5  | 2.17 | 7.1  | 6.4  | 2.35 | 6.7  | 6.2  | 2.28 | 5.3  | 5.3  | 1.50 |     |      |
|                          |                               |                          | 22                            | 8.6                              | 5.4 | 2.03 | 8.2  | 5.2  | 2.21 | 7.8  | 5.1  | 2.40 | 7.3  | 4.9  | 2.33 | 5.7  | 4.3  | 1.52 |     |      |
|                          |                               | 32                       | 16                            | 7.1                              | 7.1 | 1.93 | 6.8  | 6.8  | 2.11 | 6.5  | 6.5  | 2.29 | 6.1  | 6.1  | 2.22 | 5.0  | 5.0  | 1.47 |     |      |
|                          |                               |                          | 19                            | 7.8                              | 7.8 | 1.99 | 7.4  | 7.4  | 2.17 | 7.1  | 7.1  | 2.35 | 6.7  | 6.7  | 2.28 | 5.3  | 5.3  | 1.50 |     |      |
|                          |                               |                          | 22                            | 8.6                              | 6.6 | 2.03 | 8.2  | 6.4  | 2.21 | 7.8  | 6.3  | 2.40 | 7.3  | 6.1  | 2.33 | 5.7  | 5.5  | 1.52 |     |      |

1-13. Capacity Table

1. Cooling Capacity Performance Data

TC :Cooling Capacity

SHC :Sensible Heat Capacity

IPT :Cooling Power Consumption

• Combination of Single Unit

Low Silhouette Ducted Type

unit : kW

| Model                                       | Power Source  | Ambient Return Air                          |   | Outdoor air intake temp(°C D.B.) |      |      |      |      |      |      |      |      |      |      |      |      |      |      |     |      |
|---|---|---|---|----------------------------------|------|------|------|------|------|------|------|------|------|------|------|------|------|------|-----|------|
|   |   |   |   | 25°C                             |      |      | 30°C |      |      | 35°C |      |      | 40°C |      |      | 46°C |      |      |     |      |
|   |   | DB  | WB  | TC                               | SHC  | IPT  | TC   | SHC  | IPT  | TC   | SHC  | IPT  | TC   | SHC  | IPT  | TC   | SHC  | IPT  |     |      |
| S-71PF1E5A<br>U-71PE1E5A<br>(U-71PE1E8A)    | 220V-230V-240V<br>50Hz 1phase<br>(380V-400V-415V<br>50Hz 3 phase) | 23  | 16  | 8.1                              | 6.1  | 2.25 | 7.9  | 6.0  | 2.41 | 7.6  | 5.8  | 2.59 | 7.2  | 5.6  | 2.57 | 6.3  | 5.2  | 2.20 |     |      |
|   |   |   | 19  | 8.5                              | 4.5  | 2.33 | 8.3  | 4.4  | 2.49 | 8.0  | 4.3  | 2.65 | 7.5  | 4.0  | 2.60 | 6.6  | 3.8  | 2.23 |     |      |
|   |   |   | 22  | 9.0                              | 3.0  | 2.44 | 8.7  | 2.8  | 2.58 | 8.3  | 2.7  | 2.73 | 7.8  | 2.6  | 2.62 | 6.8  | 2.3  | 2.25 |     |      |
|   |   | 25  | 16  | 8.1                              | 7.0  | 2.25 | 7.9  | 6.9  | 2.41 | 7.6  | 6.7  | 2.59 | 7.2  | 6.5  | 2.57 | 6.3  | 6.1  | 2.20 |     |      |
|   |   |   | 19  | 8.5                              | 5.3  | 2.33 | 8.3  | 5.3  | 2.49 | 8.0  | 5.2  | 2.65 | 7.5  | 4.9  | 2.60 | 6.6  | 4.7  | 2.23 |     |      |
|   |   |   | 22  | 9.0                              | 3.8  | 2.44 | 8.7  | 3.7  | 2.58 | 8.3  | 3.6  | 2.73 | 7.8  | 3.4  | 2.62 | 6.8  | 3.1  | 2.25 |     |      |
|   |   | 27  | 16  | 8.1                              | 7.8  | 2.25 | 7.9  | 7.8  | 2.41 | 7.6  | 7.6  | 2.59 | 7.2  | 7.2  | 2.57 | 6.3  | 6.3  | 2.20 |     |      |
|   |   |   | 19  | 8.5                              | 6.2  | 2.33 | 8.3  | 6.1  | 2.49 | 8.0  | 6.0  | 2.65 | 7.5  | 5.8  | 2.60 | 6.6  | 5.5  | 2.23 |     |      |
|   |   |   | 22  | 9.0                              | 4.7  | 2.44 | 8.7  | 4.6  | 2.58 | 8.3  | 4.5  | 2.73 | 7.8  | 4.3  | 2.62 | 6.8  | 4.0  | 2.25 |     |      |
|   |   | 29  | 16  | 8.1                              | 8.1  | 2.25 | 7.9  | 7.9  | 2.41 | 7.6  | 7.6  | 2.59 | 7.2  | 7.2  | 2.57 | 6.3  | 6.3  | 2.20 |     |      |
|   |   |   | 19  | 8.5                              | 7.1  | 2.33 | 8.3  | 7.0  | 2.49 | 8.0  | 6.9  | 2.65 | 7.5  | 6.7  | 2.60 | 6.6  | 6.4  | 2.23 |     |      |
|   |   |   | 22  | 9.0                              | 5.6  | 2.44 | 8.7  | 5.5  | 2.58 | 8.3  | 5.3  | 2.73 | 7.8  | 5.2  | 2.62 | 6.8  | 4.8  | 2.25 |     |      |
|   |   | 32  | 16  | 8.1                              | 8.1  | 2.25 | 7.9  | 7.9  | 2.41 | 7.6  | 7.6  | 2.59 | 7.2  | 7.2  | 2.57 | 6.3  | 6.3  | 2.20 |     |      |
|   |   |   | 19  | 8.5                              | 7.1  | 2.33 | 8.3  | 7.0  | 2.49 | 8.0  | 6.9  | 2.65 | 7.5  | 6.7  | 2.60 | 6.6  | 6.4  | 2.23 |     |      |
|   |   |   | 22  | 9.0                              | 5.6  | 2.44 | 8.7  | 5.5  | 2.58 | 8.3  | 5.3  | 2.73 | 7.8  | 5.2  | 2.62 | 6.8  | 4.8  | 2.25 |     |      |
|   |   | S-100PF1E5A<br>U-100PE1E5A<br>(U-100PE1E8A) | 220V-230V-240V<br>50Hz 1phase<br>(380V-400V-415V<br>50Hz 3 phase) | 23                               | 16   | 11.4 | 9.3  | 3.00 | 11.4 | 9.3  | 3.23 | 10.9 | 9.0  | 3.43 | 10.2 | 8.9  | 3.57 | 7.4  | 7.4 | 2.92 |
|   |   |   |   |                                  | 19   | 12.1 | 6.8  | 3.13 | 12.1 | 6.8  | 3.36 | 11.7 | 6.7  | 3.58 | 10.9 | 6.4  | 3.72 | 7.9  | 5.2 | 3.04 |
|   |   |   |   |                                  | 22   | 13.3 | 4.5  | 3.24 | 13.3 | 4.5  | 3.48 | 12.8 | 4.3  | 3.70 | 11.9 | 4.0  | 3.85 | 8.7  | 2.9 | 3.15 |
| 25  | 16  |   |   | 11.8                             | 11.2 | 3.05 | 11.8 | 11.2 | 3.28 | 11.3 | 10.8 | 3.49 | 10.5 | 10.5 | 3.63 | 7.7  | 7.7  | 2.97 |     |      |
|   | 19  |   |   | 12.6                             | 8.6  | 3.18 | 12.6 | 8.6  | 3.42 | 12.1 | 8.3  | 3.64 | 11.2 | 8.2  | 3.79 | 8.2  | 6.9  | 3.09 |     |      |
|   | 22  |   |   | 13.8                             | 6.2  | 3.29 | 13.8 | 6.2  | 3.54 | 13.2 | 6.0  | 3.77 | 12.3 | 5.7  | 3.92 | 9.0  | 4.6  | 3.20 |     |      |
| 27  | 16  |   |   | 12.2                             | 12.2 | 3.10 | 12.2 | 12.2 | 3.33 | 11.7 | 11.7 | 3.55 | 10.9 | 10.9 | 3.69 | 8.0  | 8.0  | 3.02 |     |      |
|   | 19  |   |   | 13.0                             | 10.6 | 3.24 | 13.0 | 10.6 | 3.48 | 12.5 | 10.3 | 3.70 | 11.6 | 10.1 | 3.85 | 8.5  | 8.5  | 3.15 |     |      |
|   | 22  |   |   | 14.2                             | 8.1  | 3.35 | 14.2 | 8.1  | 3.60 | 13.7 | 7.8  | 3.83 | 12.7 | 7.6  | 3.98 | 9.3  | 6.2  | 3.25 |     |      |
| 29  | 16  |   |   | 12.4                             | 12.4 | 3.11 | 12.4 | 12.4 | 3.34 | 11.9 | 11.9 | 3.56 | 11.0 | 11.0 | 3.70 | 8.1  | 8.1  | 3.02 |     |      |
|   | 19  |   |   | 13.2                             | 12.4 | 3.25 | 13.2 | 12.4 | 3.49 | 12.7 | 12.1 | 3.71 | 11.8 | 11.8 | 3.86 | 8.6  | 8.6  | 3.15 |     |      |
|   | 22  |   |   | 14.5                             | 10.0 | 3.36 | 14.5 | 10.0 | 3.61 | 13.9 | 9.7  | 3.84 | 12.9 | 9.4  | 3.99 | 9.5  | 8.1  | 3.26 |     |      |
| 32  | 16  |   |   | 12.5                             | 12.5 | 3.12 | 12.5 | 12.5 | 3.35 | 12.1 | 12.1 | 3.56 | 11.2 | 11.2 | 3.71 | 8.2  | 8.2  | 3.03 |     |      |
|   | 19  |   |   | 13.4                             | 12.6 | 3.25 | 13.4 | 12.6 | 3.50 | 12.9 | 12.3 | 3.72 | 12.0 | 12.0 | 3.87 | 8.8  | 8.8  | 3.16 |     |      |
|   | 22  |   |   | 14.7                             | 10.2 | 3.37 | 14.7 | 10.2 | 3.62 | 14.1 | 9.8  | 3.85 | 13.1 | 9.5  | 4.00 | 9.6  | 8.2  | 3.27 |     |      |
| S-125PF1E5A<br>U-125PE1E5A<br>(U-125PE1E8A) | 220V-230V-240V<br>50Hz 1phase<br>(380V-400V-415V<br>50Hz 3 phase) |   |   | 23                               | 16   | 12.7 | 9.5  | 3.73 | 12.7 | 9.6  | 4.01 | 12.2 | 9.3  | 4.27 | 11.4 | 9.0  | 4.44 | 8.3  | 7.6 | 3.63 |
|   |   |   |   |                                  | 19   | 13.6 | 7.2  | 3.89 | 13.6 | 7.3  | 4.18 | 13.1 | 7.0  | 4.45 | 12.2 | 6.7  | 4.63 | 8.9  | 5.3 | 3.78 |
|   |   |   |   |                                  | 22   | 14.9 | 5.0  | 4.03 | 14.9 | 5.0  | 4.33 | 14.3 | 4.8  | 4.60 | 13.3 | 4.5  | 4.79 | 9.7  | 3.2 | 3.91 |
|   |   | 25  | 16  | 13.2                             | 11.4 | 3.80 | 13.2 | 11.4 | 4.08 | 12.7 | 11.0 | 4.34 | 11.8 | 10.8 | 4.51 | 8.6  | 8.6  | 3.69 |     |      |
|   |   |   | 19  | 14.1                             | 9.0  | 3.96 | 14.1 | 9.0  | 4.25 | 13.5 | 8.6  | 4.52 | 12.6 | 8.4  | 4.71 | 9.2  | 7.0  | 3.85 |     |      |
|   |   |   | 22  | 15.4                             | 6.7  | 4.10 | 15.4 | 6.7  | 4.40 | 14.8 | 6.4  | 4.68 | 13.8 | 6.1  | 4.87 | 10.1 | 4.8  | 3.98 |     |      |
|   |   | 27  | 16  | 13.6                             | 13.2 | 3.86 | 13.6 | 13.3 | 4.15 | 13.1 | 12.8 | 4.41 | 12.2 | 12.2 | 4.59 | 8.9  | 8.9  | 3.75 |     |      |
|   |   |   | 19  | 14.6                             | 10.8 | 4.03 | 14.6 | 10.8 | 4.32 | 14.0 | 10.5 | 4.60 | 13.0 | 10.2 | 4.78 | 9.5  | 8.7  | 3.91 |     |      |
|   |   |   | 22  | 16.0                             | 8.5  | 4.16 | 16.0 | 8.5  | 4.47 | 15.3 | 8.2  | 4.76 | 14.3 | 7.9  | 4.95 | 10.4 | 6.4  | 4.05 |     |      |
|   |   | 29  | 16  | 13.8                             | 13.8 | 3.87 | 13.8 | 13.8 | 4.16 | 13.3 | 13.3 | 4.42 | 12.4 | 12.4 | 4.60 | 9.0  | 9.0  | 3.76 |     |      |
|   |   |   | 19  | 14.8                             | 12.5 | 4.03 | 14.8 | 12.6 | 4.33 | 14.2 | 12.2 | 4.61 | 13.2 | 11.9 | 4.80 | 9.7  | 9.7  | 3.92 |     |      |
|   |   |   | 22  | 16.2                             | 10.2 | 4.17 | 16.2 | 10.2 | 4.48 | 15.6 | 9.9  | 4.77 | 14.5 | 9.6  | 4.96 | 10.6 | 8.0  | 4.06 |     |      |
|   |   | 32  | 16  | 14.0                             | 14.0 | 3.88 | 14.0 | 14.0 | 4.17 | 13.5 | 13.5 | 4.43 | 12.6 | 12.6 | 4.61 | 9.2  | 9.2  | 3.77 |     |      |
|   |   |   | 19  | 15.0                             | 12.7 | 4.04 | 15.0 | 12.8 | 4.35 | 14.4 | 12.3 | 4.62 | 13.4 | 12.1 | 4.81 | 9.8  | 9.8  | 3.93 |     |      |
|   |   |   | 22  | 16.4                             | 10.3 | 4.18 | 16.4 | 10.4 | 4.50 | 15.8 | 10.0 | 4.78 | 14.7 | 9.8  | 4.97 | 10.7 | 8.1  | 4.07 |     |      |
|   |   | S-140PF1E5A<br>U-140PE1E5A<br>(U-140PE1E8A) | 220V-230V-240V<br>50Hz 1phase<br>(380V-400V-415V<br>50Hz 3 phase) | 23                               | 16   | 14.1 | 10.2 | 4.87 | 14.1 | 10.3 | 5.23 | 13.6 | 9.9  | 5.56 | 12.6 | 9.6  | 5.79 | 9.2  | 8.1 | 4.73 |
|   |   |   |   |                                  | 19   | 15.1 | 7.9  | 5.08 | 15.1 | 8.0  | 5.46 | 14.5 | 7.7  | 5.80 | 13.5 | 7.3  | 6.04 | 9.8  | 5.8 | 4.93 |
|   |   |   |   |                                  | 22   | 16.5 | 5.6  | 5.25 | 16.5 | 5.5  | 5.64 | 15.9 | 5.4  | 6.00 | 14.8 | 5.0  | 6.25 | 10.8 | 3.6 | 5.10 |
| 25  | 16  |   |   | 14.6                             | 12.1 | 4.95 | 14.6 | 12.1 | 5.32 | 14.0 | 11.7 | 5.66 | 13.1 | 11.5 | 5.88 | 9.5  | 9.5  | 4.81 |     |      |
|   | 19  |   |   | 15.6                             | 9.7  | 5.16 | 15.6 | 9.7  | 5.55 | 15.0 | 9.3  | 5.90 | 13.9 | 9.0  | 6.14 | 10.2 | 7.4  | 5.02 |     |      |
|   | 22  |   |   | 17.1                             | 7.3  | 5.34 | 17.1 | 7.3  | 5.74 | 16.4 | 7.0  | 6.11 | 15.3 | 6.7  | 6.35 | 11.2 | 5.2  | 5.19 |     |      |
| 27  | 16  |   |   | 15.1                             | 14.0 | 5.03 | 15.1 | 14.0 | 5.41 | 14.5 | 13.6 | 5.75 | 13.5 | 13.4 | 5.98 | 9.9  | 9.9  | 4.89 |     |      |
|   | 19  |   |   | 16.1                             | 11.5 | 5.25 | 16.1 | 11.6 | 5.64 | 15.5 | 11.2 | 6.00 | 14.4 | 10.9 | 6.24 | 10.5 | 9.1  | 5.10 |     |      |
|   | 22  |   |   | 17.7                             | 9.2  | 5.43 | 17.7 | 9.1  | 5.83 | 17.0 | 8.9  | 6.21 | 15.8 | 8.4  | 6.46 | 11.5 | 6.9  | 5.28 |     |      |
| 29  | 16  |   |   | 15.3                             | 15.3 | 5.05 | 15.3 | 15.3 | 5.42 | 14.7 | 14.7 | 5.77 | 13.7 | 13.7 | 6.00 | 10.0 | 10.0 | 4.90 |     |      |
|   | 19  |   |   | 16.4                             | 13.3 | 5.26 | 16.4 | 13.4 | 5.65 | 15.7 | 12.9 | 6.01 | 14.6 | 12.6 | 6.26 | 10.7 | 10.7 | 5.11 |     |      |
|   | 22  |   |   | 17.9                             | 10.9 | 5.44 | 17.9 | 10.9 | 5.85 | 17.2 | 10.5 | 6.22 | 16.0 | 10.2 | 6.47 | 11.7 | 8.5  | 5.29 |     |      |
| 32  | 16  |   |   | 15.5                             | 15.5 | 5.06 | 15.5 | 15.5 | 5.43 | 14.9 | 14.9 | 5.78 | 13.9 | 13.9 | 6.01 | 10.2 | 10.2 | 4.91 |     |      |
|   | 19  |   |   | 16.6                             | 13.5 | 5.28 | 16.6 | 13.6 | 5.67 | 16.0 | 13.1 | 6.03 | 14.8 | 12.8 | 6.27 | 10.9 | 10.9 | 5.13 |     |      |
|   | 22  |   |   | 18.2                             | 11.0 | 5.46 | 18.2 | 11.1 | 5.86 | 17.5 | 10.7 | 6.24 | 16.3 | 10.4 | 6.49 | 11.9 | 8.6  | 5.30 |     |      |

1-13. Capacity Table

1. Cooling Capacity Performance Data

TC :Cooling Capacity

SHC :Sensible Heat Capacity

IPT :Cooling Power Consumption

• Combination of Multiple Unit

Low Silhouette Ducted Type

unit : kW

| Model   | Power Source  | Ambient Return Air |      | Outdoor air intake temp(°C D.B.) |      |      |      |      |      |      |      |      |      |      |      |      |      |      |
|---|---|--------------------|------|----------------------------------|------|------|------|------|------|------|------|------|------|------|------|------|------|------|
|   |   |                    |      | 25°C                             |      |      | 30°C |      |      | 35°C |      |      | 40°C |      |      | 46°C |      |      |
|   |   |                    |      | DB                               | WB   | TC   | SHC  | IPT  | TC   | SHC  | IPT  | TC   | SHC  | IPT  | TC   | SHC  | IPT  | TC   |
| S-36PF1E5A x2<br>U-71PE1E5A<br>(U-71PE1E8A)   | 220V-230V-240V<br>50Hz 1phase<br>(380V-400V-415V<br>50Hz 3 phase) | 23                 | 16   | 8.1                              | 7.1  | 2.25 | 7.9  | 7.0  | 2.41 | 7.6  | 6.9  | 2.59 | 7.2  | 6.6  | 2.57 | 6.3  | 6.3  | 2.20 |
|   |   |                    | 19   | 8.5                              | 5.0  | 2.33 | 8.3  | 4.9  | 2.49 | 8.0  | 4.8  | 2.65 | 7.5  | 4.6  | 2.60 | 6.6  | 4.3  | 2.23 |
|   |   |                    | 22   | 9.0                              | 3.0  | 2.44 | 8.7  | 2.9  | 2.58 | 8.3  | 2.8  | 2.73 | 7.8  | 2.6  | 2.62 | 6.8  | 2.3  | 2.25 |
|   |   | 25                 | 16   | 8.1                              | 8.1  | 2.25 | 7.9  | 7.9  | 2.41 | 7.6  | 7.6  | 2.59 | 7.2  | 7.2  | 2.57 | 6.3  | 6.3  | 2.20 |
|   |   |                    | 19   | 8.5                              | 6.2  | 2.33 | 8.3  | 6.1  | 2.49 | 8.0  | 6.0  | 2.65 | 7.5  | 5.8  | 2.60 | 6.6  | 5.6  | 2.23 |
|   |   |                    | 22   | 9.0                              | 4.2  | 2.44 | 8.7  | 4.1  | 2.58 | 8.3  | 3.9  | 2.73 | 7.8  | 3.8  | 2.62 | 6.8  | 3.5  | 2.25 |
|   |   | 27                 | 16   | 8.1                              | 8.1  | 2.25 | 7.9  | 7.9  | 2.41 | 7.6  | 7.6  | 2.59 | 7.2  | 7.2  | 2.57 | 6.3  | 6.3  | 2.20 |
|   |   |                    | 19   | 8.5                              | 7.5  | 2.33 | 8.3  | 7.4  | 2.49 | 8.0  | 7.2  | 2.65 | 7.5  | 7.1  | 2.60 | 6.6  | 6.6  | 2.23 |
|   |   |                    | 22   | 9.0                              | 5.4  | 2.44 | 8.7  | 5.3  | 2.58 | 8.3  | 5.2  | 2.73 | 7.8  | 5.0  | 2.62 | 6.8  | 4.6  | 2.25 |
|   |   | 29                 | 16   | 8.1                              | 8.1  | 2.25 | 7.9  | 7.9  | 2.41 | 7.6  | 7.6  | 2.59 | 7.2  | 7.2  | 2.57 | 6.3  | 6.3  | 2.20 |
|   |   |                    | 19   | 8.5                              | 8.5  | 2.33 | 8.3  | 8.3  | 2.49 | 8.0  | 8.0  | 2.65 | 7.5  | 7.5  | 2.60 | 6.6  | 6.6  | 2.23 |
|   |   |                    | 22   | 9.0                              | 6.6  | 2.44 | 8.7  | 6.6  | 2.58 | 8.3  | 6.4  | 2.73 | 7.8  | 6.2  | 2.62 | 6.8  | 5.9  | 2.25 |
| 32  | 16  | 8.1                | 8.1  | 2.25                             | 7.9  | 7.9  | 2.41 | 7.6  | 7.6  | 2.59 | 7.2  | 7.2  | 2.57 | 6.3  | 6.3  | 2.20 |      |      |
|   | 19  | 8.5                | 8.5  | 2.33                             | 8.3  | 8.3  | 2.49 | 8.0  | 8.0  | 2.65 | 7.5  | 7.5  | 2.60 | 6.6  | 6.6  | 2.23 |      |      |
|   | 22  | 9.0                | 6.6  | 2.44                             | 8.7  | 6.6  | 2.58 | 8.3  | 6.4  | 2.73 | 7.8  | 6.2  | 2.62 | 6.8  | 5.9  | 2.25 |      |      |
| S-36PF1E5A x3<br>U-100PE1E5A<br>(U-100PE1E8A) | 220V-230V-240V<br>50Hz 1phase<br>(380V-400V-415V<br>50Hz 3 phase) | 23                 | 16   | 11.4                             | 10.5 | 3.00 | 11.4 | 10.5 | 3.23 | 10.9 | 10.1 | 3.43 | 10.2 | 10.1 | 3.57 | 7.4  | 7.4  | 2.92 |
|   |   |                    | 19   | 12.1                             | 7.4  | 3.13 | 12.1 | 7.4  | 3.36 | 11.7 | 7.3  | 3.58 | 10.9 | 7.0  | 3.72 | 7.9  | 5.8  | 3.04 |
|   |   |                    | 22   | 13.3                             | 4.5  | 3.24 | 13.3 | 4.5  | 3.48 | 12.8 | 4.3  | 3.70 | 11.9 | 4.0  | 3.85 | 8.7  | 3.0  | 3.15 |
|   |   | 25                 | 16   | 11.8                             | 11.8 | 3.05 | 11.8 | 11.8 | 3.28 | 11.3 | 11.3 | 3.49 | 10.5 | 10.5 | 3.63 | 7.7  | 7.7  | 2.97 |
|   |   |                    | 19   | 12.6                             | 9.6  | 3.18 | 12.6 | 9.6  | 3.42 | 12.1 | 9.4  | 3.64 | 11.2 | 9.2  | 3.79 | 8.2  | 8.0  | 3.09 |
|   |   |                    | 22   | 13.8                             | 6.7  | 3.29 | 13.8 | 6.7  | 3.54 | 13.2 | 6.4  | 3.77 | 12.3 | 6.2  | 3.92 | 9.0  | 5.1  | 3.20 |
|   |   | 27                 | 16   | 12.2                             | 12.2 | 3.10 | 12.2 | 12.2 | 3.33 | 11.7 | 11.7 | 3.55 | 10.9 | 10.9 | 3.69 | 8.0  | 8.0  | 3.02 |
|   |   |                    | 19   | 13.0                             | 12.1 | 3.24 | 13.0 | 12.1 | 3.48 | 12.5 | 11.8 | 3.70 | 11.6 | 11.6 | 3.85 | 8.5  | 8.5  | 3.15 |
|   |   |                    | 22   | 14.2                             | 9.0  | 3.35 | 14.2 | 9.0  | 3.60 | 13.7 | 8.7  | 3.83 | 12.7 | 8.6  | 3.98 | 9.3  | 7.3  | 3.25 |
|   |   | 29                 | 16   | 12.4                             | 12.4 | 3.11 | 12.4 | 12.4 | 3.34 | 11.9 | 11.9 | 3.56 | 11.0 | 11.0 | 3.70 | 8.1  | 8.1  | 3.02 |
|   |   |                    | 19   | 13.2                             | 13.2 | 3.25 | 13.2 | 13.2 | 3.49 | 12.7 | 12.7 | 3.71 | 11.8 | 11.8 | 3.86 | 8.6  | 8.6  | 3.15 |
|   |   |                    | 22   | 14.5                             | 11.2 | 3.36 | 14.5 | 11.2 | 3.61 | 13.9 | 11.0 | 3.84 | 12.9 | 10.9 | 3.99 | 9.5  | 9.4  | 3.26 |
| 32  | 16  | 12.5               | 12.5 | 3.12                             | 12.5 | 12.5 | 3.35 | 12.1 | 12.1 | 3.56 | 11.2 | 11.2 | 3.71 | 8.2  | 8.2  | 3.03 |      |      |
|   | 19  | 13.4               | 13.4 | 3.25                             | 13.4 | 13.4 | 3.50 | 12.9 | 12.9 | 3.72 | 12.0 | 12.0 | 3.87 | 8.8  | 8.8  | 3.16 |      |      |
|   | 22  | 14.7               | 11.4 | 3.37                             | 14.7 | 11.4 | 3.62 | 14.1 | 11.1 | 3.85 | 13.1 | 11.0 | 4.00 | 9.6  | 9.5  | 3.27 |      |      |
| S-50PF1E5A x2<br>U-100PE1E5A<br>(U-100PE1E8A) | 220V-230V-240V<br>50Hz 1phase<br>(380V-400V-415V<br>50Hz 3 phase) | 23                 | 16   | 11.4                             | 9.2  | 3.00 | 11.4 | 9.2  | 3.23 | 10.9 | 8.9  | 3.43 | 10.2 | 8.7  | 3.57 | 7.4  | 7.4  | 2.92 |
|   |   |                    | 19   | 12.1                             | 6.8  | 3.13 | 12.1 | 6.8  | 3.36 | 11.7 | 6.6  | 3.58 | 10.9 | 6.3  | 3.72 | 7.9  | 5.1  | 3.04 |
|   |   |                    | 22   | 13.3                             | 4.5  | 3.24 | 13.3 | 4.5  | 3.48 | 12.8 | 4.3  | 3.70 | 11.9 | 4.0  | 3.85 | 8.7  | 2.9  | 3.15 |
|   |   | 25                 | 16   | 11.8                             | 11.0 | 3.05 | 11.8 | 11.0 | 3.28 | 11.3 | 10.6 | 3.49 | 10.5 | 10.5 | 3.63 | 7.7  | 7.7  | 2.97 |
|   |   |                    | 19   | 12.6                             | 8.5  | 3.18 | 12.6 | 8.5  | 3.42 | 12.1 | 8.2  | 3.64 | 11.2 | 8.1  | 3.79 | 8.2  | 6.8  | 3.09 |
|   |   |                    | 22   | 13.8                             | 6.2  | 3.29 | 13.8 | 6.2  | 3.54 | 13.2 | 5.9  | 3.77 | 12.3 | 5.7  | 3.92 | 9.0  | 4.4  | 3.20 |
|   |   | 27                 | 16   | 12.2                             | 12.2 | 3.10 | 12.2 | 12.2 | 3.33 | 11.7 | 11.7 | 3.55 | 10.9 | 10.9 | 3.69 | 8.0  | 8.0  | 3.02 |
|   |   |                    | 19   | 13.0                             | 10.5 | 3.24 | 13.0 | 10.5 | 3.48 | 12.5 | 10.1 | 3.70 | 11.6 | 9.9  | 3.85 | 8.5  | 8.5  | 3.15 |
|   |   |                    | 22   | 14.2                             | 8.0  | 3.35 | 14.2 | 8.0  | 3.60 | 13.7 | 7.8  | 3.83 | 12.7 | 7.5  | 3.98 | 9.3  | 6.2  | 3.25 |
|   |   | 29                 | 16   | 12.4                             | 12.4 | 3.11 | 12.4 | 12.4 | 3.34 | 11.9 | 11.9 | 3.56 | 11.0 | 11.0 | 3.70 | 8.1  | 8.1  | 3.02 |
|   |   |                    | 19   | 13.2                             | 12.2 | 3.25 | 13.2 | 12.2 | 3.49 | 12.7 | 11.8 | 3.71 | 11.8 | 11.8 | 3.86 | 8.6  | 8.6  | 3.15 |
|   |   |                    | 22   | 14.5                             | 9.8  | 3.36 | 14.5 | 9.8  | 3.61 | 13.9 | 9.5  | 3.84 | 12.9 | 9.2  | 3.99 | 9.5  | 7.9  | 3.26 |
| 32  | 16  | 12.5               | 12.5 | 3.12                             | 12.5 | 12.5 | 3.35 | 12.1 | 12.1 | 3.56 | 11.2 | 11.2 | 3.71 | 8.2  | 8.2  | 3.03 |      |      |
|   | 19  | 13.4               | 12.3 | 3.25                             | 13.4 | 12.3 | 3.50 | 12.9 | 12.0 | 3.72 | 12.0 | 12.0 | 3.87 | 8.8  | 8.8  | 3.16 |      |      |
|   | 22  | 14.7               | 9.9  | 3.37                             | 14.7 | 9.9  | 3.62 | 14.1 | 9.7  | 3.85 | 13.1 | 9.4  | 4.00 | 9.6  | 8.0  | 3.27 |      |      |
| S-36PF1E5A x4<br>U-125PE1E5A<br>(U-125PE1E8A) | 220V-230V-240V<br>50Hz 1phase<br>(380V-400V-415V<br>50Hz 3 phase) | 23                 | 16   | 12.7                             | 12.1 | 3.73 | 12.7 | 12.1 | 4.01 | 12.2 | 11.7 | 4.27 | 11.4 | 11.4 | 4.44 | 8.3  | 8.3  | 3.63 |
|   |   |                    | 19   | 13.6                             | 8.6  | 3.89 | 13.6 | 8.6  | 4.18 | 13.1 | 8.3  | 4.45 | 12.2 | 8.1  | 4.63 | 8.9  | 6.8  | 3.78 |
|   |   |                    | 22   | 14.9                             | 4.9  | 4.03 | 14.9 | 4.9  | 4.33 | 14.3 | 4.7  | 4.60 | 13.3 | 4.4  | 4.79 | 9.7  | 3.3  | 3.91 |
|   |   | 25                 | 16   | 13.2                             | 13.2 | 3.80 | 13.2 | 13.2 | 4.08 | 12.7 | 12.7 | 4.34 | 11.8 | 11.8 | 4.51 | 8.6  | 8.6  | 3.69 |
|   |   |                    | 19   | 14.1                             | 11.2 | 3.96 | 14.1 | 11.3 | 4.25 | 13.5 | 10.9 | 4.52 | 12.6 | 10.7 | 4.71 | 9.2  | 9.2  | 3.85 |
|   |   |                    | 22   | 15.4                             | 7.6  | 4.10 | 15.4 | 7.5  | 4.40 | 14.8 | 7.5  | 4.68 | 13.8 | 7.1  | 4.87 | 10.1 | 5.8  | 3.98 |
|   |   | 27                 | 16   | 13.6                             | 13.6 | 3.86 | 13.6 | 13.6 | 4.15 | 13.1 | 13.1 | 4.41 | 12.2 | 12.2 | 4.59 | 8.9  | 8.9  | 3.75 |
|   |   |                    | 19   | 14.6                             | 14.0 | 4.03 | 14.6 | 14.1 | 4.32 | 14.0 | 13.6 | 4.60 | 13.0 | 13.0 | 4.78 | 9.5  | 9.5  | 3.91 |
|   |   |                    | 22   | 16.0                             | 10.4 | 4.16 | 16.0 | 10.6 | 4.47 | 15.3 | 10.0 | 4.76 | 14.3 | 9.9  | 4.95 | 10.4 | 8.5  | 4.05 |
|   |   | 29                 | 16   | 13.8                             | 13.8 | 3.87 | 13.8 | 13.8 | 4.16 | 13.3 | 13.3 | 4.42 | 12.4 | 12.4 | 4.60 | 9.0  | 9.0  | 3.76 |
|   |   |                    | 19   | 14.8                             | 14.8 | 4.03 | 14.8 | 14.8 | 4.33 | 14.2 | 14.2 | 4.61 | 13.2 | 13.2 | 4.80 | 9.7  | 9.7  | 3.92 |
|   |   |                    | 22   | 16.2                             | 13.2 | 4.17 | 16.2 | 13.2 | 4.48 | 15.6 | 12.7 | 4.77 | 14.5 | 12.7 | 4.96 | 10.6 | 10.6 | 4.06 |
| 32  | 16  | 14.0               | 14.0 | 3.88                             | 14.0 | 14.0 | 4.17 | 13.5 | 13.5 | 4.43 | 12.6 | 12.6 | 4.61 | 9.2  | 9.2  | 3.77 |      |      |
|   | 19  | 15.0               | 15.0 | 4.04                             | 15.0 | 15.0 | 4.35 | 14.4 | 14.4 | 4.62 | 13.4 | 13.4 | 4.81 | 9.8  | 9.8  | 3.93 |      |      |
|   | 22  | 16.4               | 13.3 | 4.18                             | 16.4 | 13.3 | 4.50 | 15.8 | 12.9 | 4.78 | 14.7 | 12.8 | 4.97 | 10.7 | 10.7 | 4.07 |      |      |
| S-45PF1E5A x3<br>U-125PE1E5A<br>(U-125PE1E8A) | 220V-230V-240V<br>50Hz 1phase<br>(380V-400V-415V<br>50Hz 3 phase) | 23                 | 16   | 12.7                             | 10.4 | 3.73 | 12.7 | 10.4 | 4.01 | 12.2 | 10.1 | 4.27 | 11.4 | 9.9  | 4.44 | 8.3  | 8.3  | 3.63 |
|   |   |                    | 19   | 13.6                             | 7.7  | 3.89 | 13.6 | 7.7  | 4.18 | 13.1 | 7.4  | 4.45 | 12.2 | 7.1  | 4.63 | 8.9  | 5.9  | 3.78 |
|   |   |                    | 22   | 14.9                             | 5.0  | 4.03 | 14.9 | 4.9  | 4.33 | 14.3 | 4.8  | 4.60 | 13.3 | 4.5  | 4.79 | 9.7  | 3.2  | 3.91 |
|   |   | 25                 | 16   | 13.2                             | 12.6 | 3.80 | 13.2 | 12.7 | 4.08 | 12.7 | 12.3 | 4.34 | 11.8 | 11.8 | 4.51 | 8.6  | 8.6  | 3.69 |
|   |   |                    | 19   | 14.1                             | 9.8  | 3.96 | 14.1 | 9.8  | 4.25 | 13.5 | 9.4  | 4.52 | 12.6 | 9.3  | 4.71 | 9.2  | 7.8  | 3.85 |
|   |   |                    | 22   | 15.4                             | 7.0  | 4.10 | 15.4 | 6.9  | 4.40 | 14.8 | 6.8  | 4.68 | 13.8 | 6.5  | 4.87 | 10.1 | 5.1  | 3.98 |
|   |   | 27                 | 16   | 13.6                             | 13.6 | 3.86 | 13.6 | 13.6 | 4.15 | 13.1 | 13.1 | 4.41 | 12.2 | 12.2 | 4.59 | 8.9  | 8.9  | 3.75 |
|   |   |                    | 19   | 14.6                             | 12.0 | 4.03 | 14.6 | 12.0 | 4.32 | 14.0 | 11.5 | 4.60 | 13.0 | 11.4 | 4.78 | 9.5  | 9.5  | 3.91 |
|   |   |                    | 22   | 16.0                             | 9.2  | 4.16 | 16.0 | 9.1  | 4.47 | 15.3 | 8.9  | 4.76 | 14.3 | 8.5  | 4.95 | 10.4 | 7.1  | 4.05 |
|   |   | 29                 | 16   | 13.8                             | 13.8 | 3.87 | 13.8 | 13.8 | 4.16 | 13.3 | 13.3 | 4.42 | 12.4 | 12.4 | 4.60 | 9.0  | 9.0  | 3.76 |
|   |   |                    | 19   | 14.8                             | 14.0 | 4.03 | 14.8 | 14.1 | 4.33 | 14.2 | 13.6 | 4.61 | 13.2 | 13.2 | 4.80 | 9.7  | 9.7  | 3.92 |
|   |   |                    | 22   | 16.2                             | 11.2 | 4.17 | 16.2 | 11.2 | 4.48 | 15.6 | 11.0 | 4.77 | 14.5 | 10.6 | 4.96 | 10.6 | 9.1  | 4.06 |
| 32  | 16  | 14.0               | 14.0 | 3.88                             | 14.0 | 14.0 | 4.17 | 13.5 | 13.5 | 4.43 | 12.6 | 12.6 | 4.61 | 9.2  | 9.2  | 3.77 |      |      |
|   | 19  | 15.0               | 14.2 | 4.04                             | 15.0 | 14.3 | 4.35 | 14.4 | 13.8 | 4.62 | 13.4 | 13.4 | 4.81 | 9.8  | 9.8  | 3.93 |      |      |
|   | 22  | 16.4               | 11.4 | 4.18                             | 16.4 | 11.3 | 4.50 | 15.8 | 11.1 | 4.78 |      |      |      |      |      |      |      |      |

1-13. Capacity Table

1. Cooling Capacity Performance Data

TC :Cooling Capacity

SHC :Sensible Heat Capacity

IPT :Cooling Power Consumption

• Combination of Multiple Unit

Low Silhouette Ducted Type

unit : kW

| Model  | Power Source  | Ambient Return Air                           |   | Outdoor air intake temp(°C D.B.) |      |      |      |      |      |      |      |      |      |      |      |      |      |      |      |      |
|--|---|--|---|----------------------------------|------|------|------|------|------|------|------|------|------|------|------|------|------|------|------|------|
|  |   |  |   | 25°C                             |      |      | 30°C |      |      | 35°C |      |      | 40°C |      |      | 46°C |      |      |      |      |
|  |   | DB   | WB  | TC                               | SHC  | IPT  | TC   | SHC  | IPT  | TC   | SHC  | IPT  | TC   | SHC  | IPT  | TC   | SHC  | IPT  |      |      |
| S-60PF1E5A×2<br>U-125PE1E5A<br>(U-125PE1E8A) | 220V-230V-240V<br>50Hz 1phase<br>(380V-400V-415V<br>50Hz 3 phase) | 23   | 16  | 12.7                             | 10.5 | 3.73 | 12.7 | 10.5 | 4.01 | 12.2 | 10.2 | 4.27 | 11.4 | 10.0 | 4.44 | 8.3  | 8.3  | 3.63 |      |      |
|  |   |  | 19  | 13.6                             | 7.8  | 3.89 | 13.6 | 7.7  | 4.18 | 13.1 | 7.4  | 4.45 | 12.2 | 7.2  | 4.63 | 8.9  | 6.0  | 3.78 |      |      |
|  |   |  | 22  | 14.9                             | 5.0  | 4.03 | 14.9 | 4.9  | 4.33 | 14.3 | 4.8  | 4.60 | 13.3 | 4.5  | 4.79 | 9.7  | 3.3  | 3.91 |      |      |
|  |   | 25   | 16  | 13.2                             | 12.7 | 3.80 | 13.2 | 12.7 | 4.08 | 12.7 | 12.3 | 4.34 | 11.8 | 11.8 | 4.51 | 8.6  | 8.6  | 3.69 |      |      |
|  |   |  | 19  | 14.1                             | 9.8  | 3.96 | 14.1 | 9.8  | 4.25 | 13.5 | 9.4  | 4.52 | 12.6 | 9.3  | 4.71 | 9.2  | 7.9  | 3.85 |      |      |
|  |   |  | 22  | 15.4                             | 7.1  | 4.10 | 15.4 | 6.9  | 4.40 | 14.8 | 6.8  | 4.68 | 13.8 | 6.5  | 4.87 | 10.1 | 5.2  | 3.98 |      |      |
|  |   | 27   | 16  | 13.6                             | 13.6 | 3.86 | 13.6 | 13.6 | 4.15 | 13.1 | 13.1 | 4.41 | 12.2 | 12.2 | 4.59 | 8.9  | 8.9  | 3.75 |      |      |
|  |   |  | 19  | 14.6                             | 12.1 | 4.03 | 14.6 | 12.1 | 4.32 | 14.0 | 11.6 | 4.60 | 13.0 | 11.5 | 4.78 | 9.5  | 9.5  | 3.91 |      |      |
|  |   |  | 22  | 16.0                             | 9.3  | 4.16 | 16.0 | 9.1  | 4.47 | 15.3 | 8.9  | 4.76 | 14.3 | 8.7  | 4.95 | 10.4 | 7.2  | 4.05 |      |      |
|  |   | 29   | 16  | 13.8                             | 13.8 | 3.87 | 13.8 | 13.8 | 4.16 | 13.3 | 13.3 | 4.42 | 12.4 | 12.4 | 4.60 | 9.0  | 9.0  | 3.76 |      |      |
|  |   |  | 19  | 14.8                             | 14.1 | 4.03 | 14.8 | 14.1 | 4.33 | 14.2 | 13.6 | 4.61 | 13.2 | 13.2 | 4.80 | 9.7  | 9.7  | 3.92 |      |      |
|  |   |  | 22  | 16.2                             | 11.4 | 4.17 | 16.2 | 11.3 | 4.48 | 15.6 | 11.0 | 4.77 | 14.5 | 10.7 | 4.96 | 10.6 | 9.2  | 4.06 |      |      |
|  |   | 32   | 16  | 14.0                             | 14.0 | 3.88 | 14.0 | 14.0 | 4.17 | 13.5 | 13.5 | 4.43 | 12.6 | 12.6 | 4.61 | 9.2  | 9.2  | 3.77 |      |      |
|  |   |  | 19  | 15.0                             | 14.3 | 4.04 | 15.0 | 14.3 | 4.35 | 14.4 | 13.8 | 4.62 | 13.4 | 13.4 | 4.81 | 9.8  | 9.8  | 3.93 |      |      |
|  |   |  | 22  | 16.4                             | 11.5 | 4.18 | 16.4 | 11.5 | 4.50 | 15.8 | 11.1 | 4.78 | 14.7 | 10.9 | 4.97 | 10.7 | 9.3  | 4.07 |      |      |
|  |   | S-50PF1E5A×3<br>U-140PE1E5A<br>(U-140PE1E8A) | 220V-230V-240V<br>50Hz 1phase<br>(380V-400V-415V<br>50Hz 3 phase) | 23                               | 16   | 14.1 | 11.6 | 4.87 | 14.1 | 11.7 | 5.23 | 13.6 | 11.5 | 5.56 | 12.6 | 11.1 | 5.79 | 9.2  | 9.2  | 4.73 |
|  |   |  |   |                                  | 19   | 15.1 | 8.6  | 5.08 | 15.1 | 8.6  | 5.46 | 14.5 | 8.3  | 5.80 | 13.5 | 8.0  | 6.04 | 9.8  | 6.5  | 4.93 |
|  |   |  |   |                                  | 22   | 16.5 | 5.5  | 5.25 | 16.5 | 5.5  | 5.64 | 15.9 | 5.3  | 6.00 | 14.8 | 4.9  | 6.25 | 10.8 | 3.6  | 5.10 |
|  |   |  |   | 25                               | 16   | 14.6 | 14.1 | 4.95 | 14.6 | 14.2 | 5.32 | 14.0 | 13.7 | 5.66 | 13.1 | 13.1 | 5.88 | 9.5  | 9.5  | 4.81 |
|  |   |  |   |                                  | 19   | 15.6 | 10.9 | 5.16 | 15.6 | 11.0 | 5.55 | 15.0 | 10.6 | 5.90 | 13.9 | 10.3 | 6.14 | 10.2 | 8.7  | 5.02 |
|  |   |  |   |                                  | 22   | 17.1 | 7.8  | 5.34 | 17.1 | 7.8  | 5.74 | 16.4 | 7.5  | 6.11 | 15.3 | 7.2  | 6.35 | 11.2 | 5.7  | 5.19 |
|  |   |  |   | 27                               | 16   | 15.1 | 15.1 | 5.03 | 15.1 | 15.1 | 5.41 | 14.5 | 14.5 | 5.75 | 13.5 | 13.5 | 5.98 | 9.9  | 9.9  | 4.89 |
|  |   |  |   |                                  | 19   | 16.1 | 13.4 | 5.25 | 16.1 | 13.4 | 5.64 | 15.5 | 13.0 | 6.00 | 14.4 | 12.8 | 6.24 | 10.5 | 10.5 | 5.10 |
|  |   |  |   |                                  | 22   | 17.7 | 10.3 | 5.43 | 17.7 | 10.2 | 5.83 | 17.0 | 9.9  | 6.21 | 15.8 | 9.6  | 6.46 | 11.5 | 8.0  | 5.28 |
| 29   | 16  |  |   | 15.3                             | 15.3 | 5.05 | 15.3 | 15.3 | 5.42 | 14.7 | 14.7 | 5.77 | 13.7 | 13.7 | 6.00 | 10.0 | 10.0 | 4.90 |      |      |
|  | 19  |  |   | 16.4                             | 15.7 | 5.26 | 16.4 | 15.8 | 5.65 | 15.7 | 15.3 | 6.01 | 14.6 | 14.6 | 6.26 | 10.7 | 10.7 | 5.11 |      |      |
|  | 22  |  |   | 17.9                             | 12.5 | 5.44 | 17.9 | 12.6 | 5.85 | 17.2 | 12.2 | 6.22 | 16.0 | 11.9 | 6.47 | 11.7 | 10.2 | 5.29 |      |      |
| 32   | 16  |  |   | 15.5                             | 15.5 | 5.06 | 15.5 | 15.5 | 5.43 | 14.9 | 14.9 | 5.78 | 13.9 | 13.9 | 6.01 | 10.2 | 10.2 | 4.91 |      |      |
|  | 19  |  |   | 16.6                             | 15.9 | 5.28 | 16.6 | 16.0 | 5.67 | 16.0 | 15.5 | 6.03 | 14.8 | 14.8 | 6.27 | 10.9 | 10.9 | 5.13 |      |      |
|  | 22  |  |   | 18.2                             | 12.7 | 5.46 | 18.2 | 12.8 | 5.86 | 17.5 | 12.4 | 6.24 | 16.3 | 12.1 | 6.49 | 11.9 | 10.4 | 5.30 |      |      |
| S-71PF1E5A×2<br>U-140PE1E5A<br>(U-140PE1E8A) | 220V-230V-240V<br>50Hz 1phase<br>(380V-400V-415V<br>50Hz 3 phase) |  |   | 23                               | 16   | 14.1 | 11.0 | 4.87 | 14.1 | 11.0 | 5.23 | 13.6 | 10.8 | 5.56 | 12.6 | 10.4 | 5.79 | 9.2  | 8.9  | 4.73 |
|  |   |  |   |                                  | 19   | 15.1 | 8.2  | 5.08 | 15.1 | 8.3  | 5.46 | 14.5 | 8.0  | 5.80 | 13.5 | 7.7  | 6.04 | 9.8  | 6.2  | 4.93 |
|  |   |  |   |                                  | 22   | 16.5 | 5.5  | 5.25 | 16.5 | 5.5  | 5.64 | 15.9 | 5.3  | 6.00 | 14.8 | 4.9  | 6.25 | 10.8 | 3.6  | 5.10 |
|  |   |  |   | 25                               | 16   | 14.6 | 13.1 | 4.95 | 14.6 | 13.2 | 5.32 | 14.0 | 12.9 | 5.66 | 13.1 | 12.6 | 5.88 | 9.5  | 9.5  | 4.81 |
|  |   |  |   |                                  | 19   | 15.6 | 10.4 | 5.16 | 15.6 | 10.3 | 5.55 | 15.0 | 10.0 | 5.90 | 13.9 | 9.7  | 6.14 | 10.2 | 8.2  | 5.02 |
|  |   |  |   |                                  | 22   | 17.1 | 7.5  | 5.34 | 17.1 | 7.6  | 5.74 | 16.4 | 7.3  | 6.11 | 15.3 | 6.9  | 6.35 | 11.2 | 5.5  | 5.19 |
|  |   |  |   | 27                               | 16   | 15.1 | 15.1 | 5.03 | 15.1 | 15.1 | 5.41 | 14.5 | 14.5 | 5.75 | 13.5 | 13.5 | 5.98 | 9.9  | 9.9  | 4.89 |
|  |   |  |   |                                  | 19   | 16.1 | 12.5 | 5.25 | 16.1 | 12.6 | 5.64 | 15.5 | 12.2 | 6.00 | 14.4 | 11.9 | 6.24 | 10.5 | 10.2 | 5.10 |
|  |   |  |   |                                  | 22   | 17.7 | 9.7  | 5.43 | 17.7 | 9.7  | 5.83 | 17.0 | 9.4  | 6.21 | 15.8 | 9.0  | 6.46 | 11.5 | 7.4  | 5.28 |
|  |   | 29   | 16  | 15.3                             | 15.3 | 5.05 | 15.3 | 15.3 | 5.42 | 14.7 | 14.7 | 5.77 | 13.7 | 13.7 | 6.00 | 10.0 | 10.0 | 4.90 |      |      |
|  |   |  | 19  | 16.4                             | 14.6 | 5.26 | 16.4 | 14.7 | 5.65 | 15.7 | 14.1 | 6.01 | 14.6 | 13.9 | 6.26 | 10.7 | 10.7 | 5.11 |      |      |
|  |   |  | 22  | 17.9                             | 11.7 | 5.44 | 17.9 | 11.8 | 5.85 | 17.2 | 11.5 | 6.22 | 16.0 | 11.2 | 6.47 | 11.7 | 9.4  | 5.29 |      |      |
|  |   | 32   | 16  | 15.5                             | 15.5 | 5.06 | 15.5 | 15.5 | 5.43 | 14.9 | 14.9 | 5.78 | 13.9 | 13.9 | 6.01 | 10.2 | 10.2 | 4.91 |      |      |
|  |   |  | 19  | 16.6                             | 14.7 | 5.28 | 16.6 | 14.8 | 5.67 | 16.0 | 14.4 | 6.03 | 14.8 | 14.1 | 6.27 | 10.9 | 10.9 | 5.13 |      |      |
|  |   |  | 22  | 18.2                             | 11.9 | 5.46 | 18.2 | 12.0 | 5.86 | 17.5 | 11.7 | 6.24 | 16.3 | 11.4 | 6.49 | 11.9 | 9.6  | 5.30 |      |      |

1-13. Capacity Table

1. Cooling Capacity Performance Data

TC :Cooling Capacity

SHC :Sensible Heat Capacity

IPT :Cooling Power Consumption

• Combination of Single Unit

Ducted Type

unit : kW

| Model                    | Power Source                  | Ambient Return Air       |                               | Outdoor air intake temp(°C D.B.) |     |      |      |      |      |      |      |      |      |      |      |      |      |      |     |      |
|--------------------------|-------------------------------|--------------------------|-------------------------------|----------------------------------|-----|------|------|------|------|------|------|------|------|------|------|------|------|------|-----|------|
|                          |                               |                          |                               | 25°C                             |     |      | 30°C |      |      | 35°C |      |      | 40°C |      |      | 46°C |      |      |     |      |
|                          |                               |                          |                               | DB                               | WB  | TC   | SHC  | IPT  | TC   | SHC  | IPT  | TC   | SHC  | IPT  | TC   | SHC  | IPT  | TC   | SHC | IPT  |
| S-36PN1E5A<br>U-36PE2E5A | 220V-230V-240V<br>50Hz 1phase | 23                       | 16                            | 4.2                              | 3.3 | 0.98 | 4.0  | 3.2  | 1.04 | 3.7  | 3.1  | 1.10 | 3.4  | 2.9  | 1.09 | 2.8  | 2.7  | 0.83 |     |      |
|                          |                               |                          | 19                            | 4.5                              | 2.4 | 1.00 | 4.3  | 2.4  | 1.06 | 4.0  | 2.2  | 1.12 | 3.7  | 2.1  | 1.10 | 3.0  | 1.8  | 0.84 |     |      |
|                          |                               |                          | 22                            | 4.8                              | 1.5 | 1.03 | 4.6  | 1.5  | 1.09 | 4.3  | 1.4  | 1.15 | 4.0  | 1.3  | 1.12 | 3.1  | 1.0  | 0.85 |     |      |
|                          |                               | 25                       | 16                            | 4.2                              | 3.8 | 0.98 | 4.0  | 3.8  | 1.04 | 3.7  | 3.6  | 1.10 | 3.4  | 3.4  | 1.09 | 2.8  | 2.8  | 0.83 |     |      |
|                          |                               |                          | 19                            | 4.5                              | 2.9 | 1.00 | 4.3  | 2.9  | 1.06 | 4.0  | 2.7  | 1.12 | 3.7  | 2.6  | 1.10 | 3.0  | 2.3  | 0.84 |     |      |
|                          |                               |                          | 22                            | 4.8                              | 2.1 | 1.03 | 4.6  | 2.0  | 1.09 | 4.3  | 1.9  | 1.15 | 4.0  | 1.8  | 1.12 | 3.1  | 1.5  | 0.85 |     |      |
|                          |                               | 27                       | 16                            | 4.2                              | 4.2 | 0.98 | 4.0  | 4.0  | 1.04 | 3.7  | 3.7  | 1.10 | 3.4  | 3.4  | 1.09 | 2.8  | 2.8  | 0.83 |     |      |
|                          |                               |                          | 19                            | 4.5                              | 3.5 | 1.00 | 4.3  | 3.4  | 1.06 | 4.0  | 3.3  | 1.12 | 3.7  | 3.1  | 1.10 | 3.0  | 2.9  | 0.84 |     |      |
|                          |                               |                          | 22                            | 4.8                              | 2.6 | 1.03 | 4.6  | 2.5  | 1.09 | 4.3  | 2.4  | 1.15 | 4.0  | 2.3  | 1.12 | 3.1  | 2.0  | 0.85 |     |      |
|                          |                               | 29                       | 16                            | 4.2                              | 4.2 | 0.98 | 4.0  | 4.0  | 1.04 | 3.7  | 3.7  | 1.10 | 3.4  | 3.4  | 1.09 | 2.8  | 2.8  | 0.83 |     |      |
|                          |                               |                          | 19                            | 4.5                              | 4.0 | 1.00 | 4.3  | 3.9  | 1.06 | 4.0  | 3.8  | 1.12 | 3.7  | 3.7  | 1.10 | 3.0  | 3.0  | 0.84 |     |      |
|                          |                               |                          | 22                            | 4.8                              | 3.1 | 1.03 | 4.6  | 3.0  | 1.09 | 4.3  | 2.9  | 1.15 | 4.0  | 2.8  | 1.12 | 3.1  | 2.5  | 0.85 |     |      |
|                          |                               | 32                       | 16                            | 4.2                              | 4.2 | 0.98 | 4.0  | 4.0  | 1.04 | 3.7  | 3.7  | 1.10 | 3.4  | 3.4  | 1.09 | 2.8  | 2.8  | 0.83 |     |      |
|                          |                               |                          | 19                            | 4.5                              | 4.5 | 1.00 | 4.3  | 4.3  | 1.06 | 4.0  | 4.0  | 1.12 | 3.7  | 3.7  | 1.10 | 3.0  | 3.0  | 0.84 |     |      |
|                          |                               |                          | 22                            | 4.8                              | 3.9 | 1.03 | 4.6  | 3.8  | 1.09 | 4.3  | 3.7  | 1.15 | 4.0  | 3.5  | 1.12 | 3.1  | 3.1  | 0.85 |     |      |
|                          |                               | S-50PN1E5A<br>U-50PE2E5A | 220V-230V-240V<br>50Hz 1phase | 23                               | 16  | 5.9  | 4.3  | 1.65 | 5.5  | 4.1  | 1.75 | 5.2  | 4.0  | 1.85 | 4.8  | 3.8  | 1.83 | 3.9  | 3.4 | 1.40 |
|                          |                               |                          |                               |                                  | 19  | 6.3  | 3.3  | 1.69 | 6.0  | 3.1  | 1.79 | 5.6  | 3.0  | 1.89 | 5.2  | 2.8  | 1.85 | 4.1  | 2.4 | 1.42 |
|                          |                               |                          |                               |                                  | 22  | 6.8  | 2.3  | 1.74 | 6.4  | 2.1  | 1.84 | 6.1  | 2.0  | 1.94 | 5.5  | 1.8  | 1.89 | 4.4  | 1.4 | 1.43 |
| 25                       | 16                            |                          |                               | 5.9                              | 4.9 | 1.65 | 5.5  | 4.7  | 1.75 | 5.2  | 4.6  | 1.85 | 4.8  | 4.4  | 1.83 | 3.9  | 3.9  | 1.40 |     |      |
|                          | 19                            |                          |                               | 6.3                              | 3.9 | 1.69 | 6.0  | 3.7  | 1.79 | 5.6  | 3.6  | 1.89 | 5.2  | 3.4  | 1.85 | 4.1  | 3.0  | 1.42 |     |      |
|                          | 22                            |                          |                               | 6.8                              | 2.9 | 1.74 | 6.4  | 2.7  | 1.84 | 6.1  | 2.6  | 1.94 | 5.5  | 2.4  | 1.89 | 4.4  | 2.0  | 1.43 |     |      |
| 27                       | 16                            |                          |                               | 5.9                              | 5.5 | 1.65 | 5.5  | 5.3  | 1.75 | 5.2  | 5.2  | 1.85 | 4.8  | 4.8  | 1.83 | 3.9  | 3.9  | 1.40 |     |      |
|                          | 19                            |                          |                               | 6.3                              | 4.5 | 1.69 | 6.0  | 4.3  | 1.79 | 5.6  | 4.2  | 1.89 | 5.2  | 4.0  | 1.85 | 4.1  | 3.5  | 1.42 |     |      |
|                          | 22                            |                          |                               | 6.8                              | 3.4 | 1.74 | 6.4  | 3.3  | 1.84 | 6.1  | 3.2  | 1.94 | 5.5  | 2.9  | 1.89 | 4.4  | 2.5  | 1.43 |     |      |
| 29                       | 16                            |                          |                               | 5.9                              | 5.9 | 1.65 | 5.5  | 5.5  | 1.75 | 5.2  | 5.2  | 1.85 | 4.8  | 4.8  | 1.83 | 3.9  | 3.9  | 1.40 |     |      |
|                          | 19                            |                          |                               | 6.3                              | 5.0 | 1.69 | 6.0  | 4.9  | 1.79 | 5.6  | 4.8  | 1.89 | 5.2  | 4.6  | 1.85 | 4.1  | 4.1  | 1.42 |     |      |
|                          | 22                            |                          |                               | 6.8                              | 4.0 | 1.74 | 6.4  | 3.9  | 1.84 | 6.1  | 3.7  | 1.94 | 5.5  | 3.5  | 1.89 | 4.4  | 3.1  | 1.43 |     |      |
| 32                       | 16                            |                          |                               | 5.9                              | 5.9 | 1.65 | 5.5  | 5.5  | 1.75 | 5.2  | 5.2  | 1.85 | 4.8  | 4.8  | 1.83 | 3.9  | 3.9  | 1.40 |     |      |
|                          | 19                            |                          |                               | 6.3                              | 5.9 | 1.69 | 6.0  | 5.8  | 1.79 | 5.6  | 5.6  | 1.89 | 5.2  | 5.2  | 1.85 | 4.1  | 4.1  | 1.42 |     |      |
|                          | 22                            |                          |                               | 6.8                              | 4.9 | 1.74 | 6.4  | 4.7  | 1.84 | 6.1  | 4.6  | 1.94 | 5.5  | 4.4  | 1.89 | 4.4  | 4.0  | 1.43 |     |      |
| S-60PN1E5A<br>U-60PE2E5A | 220V-230V-240V<br>50Hz 1phase |                          |                               | 23                               | 16  | 7.1  | 5.4  | 2.10 | 6.8  | 5.3  | 2.29 | 6.5  | 5.2  | 2.48 | 6.1  | 5.0  | 2.41 | 5.0  | 4.5 | 1.60 |
|                          |                               |                          |                               |                                  | 19  | 7.8  | 4.1  | 2.15 | 7.4  | 3.9  | 2.35 | 7.1  | 3.8  | 2.55 | 6.7  | 3.7  | 2.48 | 5.3  | 3.1 | 1.62 |
|                          |                               |                          |                               |                                  | 22  | 8.6  | 2.8  | 2.20 | 8.2  | 2.7  | 2.40 | 7.8  | 2.5  | 2.60 | 7.3  | 2.4  | 2.52 | 5.7  | 1.8 | 1.65 |
|                          |                               | 25                       | 16                            | 7.1                              | 6.2 | 2.10 | 6.8  | 6.1  | 2.29 | 6.5  | 6.0  | 2.48 | 6.1  | 5.8  | 2.41 | 5.0  | 5.0  | 1.60 |     |      |
|                          |                               |                          | 19                            | 7.8                              | 4.9 | 2.15 | 7.4  | 4.8  | 2.35 | 7.1  | 4.6  | 2.55 | 6.7  | 4.5  | 2.48 | 5.3  | 3.9  | 1.62 |     |      |
|                          |                               |                          | 22                            | 8.6                              | 3.6 | 2.20 | 8.2  | 3.5  | 2.40 | 7.8  | 3.3  | 2.60 | 7.3  | 3.1  | 2.52 | 5.7  | 2.6  | 1.65 |     |      |
|                          |                               | 27                       | 16                            | 7.1                              | 7.1 | 2.10 | 6.8  | 6.8  | 2.29 | 6.5  | 6.5  | 2.48 | 6.1  | 6.1  | 2.41 | 5.0  | 5.0  | 1.60 |     |      |
|                          |                               |                          | 19                            | 7.8                              | 5.7 | 2.15 | 7.4  | 5.6  | 2.35 | 7.1  | 5.4  | 2.55 | 6.7  | 5.3  | 2.48 | 5.3  | 4.7  | 1.62 |     |      |
|                          |                               |                          | 22                            | 8.6                              | 4.4 | 2.20 | 8.2  | 4.3  | 2.40 | 7.8  | 4.1  | 2.60 | 7.3  | 4.0  | 2.52 | 5.7  | 3.4  | 1.65 |     |      |
|                          |                               | 29                       | 16                            | 7.1                              | 7.1 | 2.10 | 6.8  | 6.8  | 2.29 | 6.5  | 6.5  | 2.48 | 6.1  | 6.1  | 2.41 | 5.0  | 5.0  | 1.60 |     |      |
|                          |                               |                          | 19                            | 7.8                              | 6.6 | 2.15 | 7.4  | 6.4  | 2.35 | 7.1  | 6.2  | 2.55 | 6.7  | 6.1  | 2.48 | 5.3  | 5.3  | 1.62 |     |      |
|                          |                               |                          | 22                            | 8.6                              | 5.2 | 2.20 | 8.2  | 5.1  | 2.40 | 7.8  | 4.9  | 2.60 | 7.3  | 4.7  | 2.52 | 5.7  | 4.2  | 1.65 |     |      |
|                          |                               | 32                       | 16                            | 7.1                              | 7.1 | 2.10 | 6.8  | 6.8  | 2.29 | 6.5  | 6.5  | 2.48 | 6.1  | 6.1  | 2.41 | 5.0  | 5.0  | 1.60 |     |      |
|                          |                               |                          | 19                            | 7.8                              | 7.8 | 2.15 | 7.4  | 7.4  | 2.35 | 7.1  | 7.1  | 2.55 | 6.7  | 6.7  | 2.48 | 5.3  | 5.3  | 1.62 |     |      |
|                          |                               |                          | 22                            | 8.6                              | 6.4 | 2.20 | 8.2  | 6.3  | 2.40 | 7.8  | 6.1  | 2.60 | 7.3  | 6.0  | 2.52 | 5.7  | 5.4  | 1.65 |     |      |

1-13. Capacity Table

1. Cooling Capacity Performance Data

TC :Cooling Capacity

SHC :Sensible Heat Capacity

IPT :Cooling Power Consumption

• Combination of Single Unit

Ducted Type

unit : kW

| Model                                       | Power Source  | Ambient Return Air |      | Outdoor air intake temp(°C D.B.) |      |      |      |      |      |      |      |      |      |      |      |      |      |      |
|---|---|--------------------|------|----------------------------------|------|------|------|------|------|------|------|------|------|------|------|------|------|------|
|   |   |                    |      | 25°C                             |      |      | 30°C |      |      | 35°C |      |      | 40°C |      |      | 46°C |      |      |
|   |   | DB                 | WB   | TC                               | SHC  | IPT  | TC   | SHC  | IPT  | TC   | SHC  | IPT  | TC   | SHC  | IPT  | TC   | SHC  | IPT  |
| S-71PN1E5A<br>U-71PE1E5A<br>(U-71PE1E8A)    | 220V-230V-240V<br>50Hz 1phase<br>(380V-400V-415V<br>50Hz 3 phase) | 23                 | 16   | 8.1                              | 6.3  | 2.34 | 7.9  | 6.2  | 2.50 | 7.6  | 6.0  | 2.69 | 7.2  | 5.9  | 2.67 | 6.3  | 5.5  | 2.28 |
|   |   |                    | 19   | 8.5                              | 4.6  | 2.42 | 8.3  | 4.5  | 2.59 | 8.0  | 4.4  | 2.75 | 7.5  | 4.3  | 2.70 | 6.6  | 3.9  | 2.31 |
|   |   |                    | 22   | 9.0                              | 3.0  | 2.53 | 8.7  | 2.9  | 2.68 | 8.3  | 2.8  | 2.83 | 7.8  | 2.6  | 2.72 | 6.8  | 2.3  | 2.34 |
|   |   | 25                 | 16   | 8.1                              | 7.2  | 2.34 | 7.9  | 7.1  | 2.50 | 7.6  | 7.0  | 2.69 | 7.2  | 6.8  | 2.67 | 6.3  | 6.3  | 2.28 |
|   |   |                    | 19   | 8.5                              | 5.6  | 2.42 | 8.3  | 5.5  | 2.59 | 8.0  | 5.3  | 2.75 | 7.5  | 5.1  | 2.70 | 6.6  | 4.8  | 2.31 |
|   |   |                    | 22   | 9.0                              | 3.9  | 2.53 | 8.7  | 3.8  | 2.68 | 8.3  | 3.7  | 2.83 | 7.8  | 3.5  | 2.72 | 6.8  | 3.2  | 2.34 |
|   |   | 27                 | 16   | 8.1                              | 8.1  | 2.34 | 7.9  | 7.9  | 2.50 | 7.6  | 7.6  | 2.69 | 7.2  | 7.2  | 2.67 | 6.3  | 6.3  | 2.28 |
|   |   |                    | 19   | 8.5                              | 6.5  | 2.42 | 8.3  | 6.5  | 2.59 | 8.0  | 6.3  | 2.75 | 7.5  | 6.0  | 2.70 | 6.6  | 5.8  | 2.31 |
|   |   |                    | 22   | 9.0                              | 4.8  | 2.53 | 8.7  | 4.7  | 2.68 | 8.3  | 4.6  | 2.83 | 7.8  | 4.4  | 2.72 | 6.8  | 4.1  | 2.34 |
|   |   | 29                 | 16   | 8.1                              | 8.1  | 2.34 | 7.9  | 7.9  | 2.50 | 7.6  | 7.6  | 2.69 | 7.2  | 7.2  | 2.67 | 6.3  | 6.3  | 2.28 |
|   |   |                    | 19   | 8.5                              | 7.5  | 2.42 | 8.3  | 7.4  | 2.59 | 8.0  | 7.2  | 2.75 | 7.5  | 7.1  | 2.70 | 6.6  | 6.6  | 2.31 |
|   |   |                    | 22   | 9.0                              | 5.9  | 2.53 | 8.7  | 5.6  | 2.68 | 8.3  | 5.5  | 2.83 | 7.8  | 5.4  | 2.72 | 6.8  | 5.1  | 2.34 |
| 32  | 16  | 8.1                | 8.1  | 2.34                             | 7.9  | 7.9  | 2.50 | 7.6  | 7.6  | 2.69 | 7.2  | 7.2  | 2.67 | 6.3  | 6.3  | 2.28 |      |      |
|   | 19  | 8.5                | 7.5  | 2.42                             | 8.3  | 7.4  | 2.59 | 8.0  | 7.2  | 2.75 | 7.5  | 7.1  | 2.70 | 6.6  | 6.6  | 2.31 |      |      |
|   | 22  | 9.0                | 5.9  | 2.53                             | 8.7  | 5.6  | 2.68 | 8.3  | 5.5  | 2.83 | 7.8  | 5.4  | 2.72 | 6.8  | 5.1  | 2.34 |      |      |
| S-100PN1E5A<br>U-100PE1E5A<br>(U-100PE1E8A) | 220V-230V-240V<br>50Hz 1phase<br>(380V-400V-415V<br>50Hz 3 phase) | 23                 | 16   | 11.4                             | 9.2  | 3.08 | 11.4 | 9.2  | 3.31 | 10.9 | 8.9  | 3.52 | 10.2 | 8.7  | 3.67 | 7.4  | 7.4  | 3.00 |
|   |   |                    | 19   | 12.1                             | 6.8  | 3.22 | 12.1 | 6.8  | 3.46 | 11.7 | 6.7  | 3.68 | 10.9 | 6.4  | 3.82 | 7.9  | 5.1  | 3.12 |
|   |   |                    | 22   | 13.3                             | 4.6  | 3.33 | 13.3 | 4.6  | 3.57 | 12.8 | 4.4  | 3.80 | 11.9 | 4.1  | 3.96 | 8.7  | 3.0  | 3.23 |
|   |   | 25                 | 16   | 11.8                             | 11.0 | 3.14 | 11.8 | 11.0 | 3.37 | 11.3 | 10.6 | 3.58 | 10.5 | 10.4 | 3.73 | 7.7  | 7.7  | 3.05 |
|   |   |                    | 19   | 12.6                             | 8.5  | 3.27 | 12.6 | 8.5  | 3.51 | 12.1 | 8.3  | 3.74 | 11.2 | 8.1  | 3.89 | 8.2  | 6.8  | 3.18 |
|   |   |                    | 22   | 13.8                             | 6.3  | 3.38 | 13.8 | 6.3  | 3.64 | 13.2 | 6.0  | 3.87 | 12.3 | 5.7  | 4.02 | 9.0  | 4.6  | 3.29 |
|   |   | 27                 | 16   | 12.2                             | 12.2 | 3.19 | 12.2 | 12.2 | 3.42 | 11.7 | 11.7 | 3.64 | 10.9 | 10.9 | 3.79 | 8.0  | 8.0  | 3.10 |
|   |   |                    | 19   | 13.0                             | 10.5 | 3.33 | 13.0 | 10.5 | 3.57 | 12.5 | 10.1 | 3.80 | 11.6 | 9.9  | 3.95 | 8.5  | 8.5  | 3.23 |
|   |   |                    | 22   | 14.2                             | 8.1  | 3.44 | 14.2 | 8.1  | 3.70 | 13.7 | 7.8  | 3.93 | 12.7 | 7.5  | 4.09 | 9.3  | 6.2  | 3.34 |
|   |   | 29                 | 16   | 12.4                             | 12.4 | 3.20 | 12.4 | 12.4 | 3.43 | 11.9 | 11.9 | 3.65 | 11.0 | 11.0 | 3.80 | 8.1  | 8.1  | 3.10 |
|   |   |                    | 19   | 13.2                             | 12.2 | 3.33 | 13.2 | 12.2 | 3.58 | 12.7 | 11.8 | 3.81 | 11.8 | 11.7 | 3.96 | 8.6  | 8.6  | 3.24 |
|   |   |                    | 22   | 14.5                             | 9.8  | 3.45 | 14.5 | 9.8  | 3.70 | 13.9 | 9.5  | 3.94 | 12.9 | 9.2  | 4.10 | 9.5  | 7.9  | 3.35 |
| 32  | 16  | 12.5               | 12.5 | 3.20                             | 12.5 | 12.5 | 3.44 | 12.1 | 12.1 | 3.66 | 11.2 | 11.2 | 3.81 | 8.2  | 8.2  | 3.11 |      |      |
|   | 19  | 13.4               | 12.3 | 3.34                             | 13.4 | 12.3 | 3.59 | 12.9 | 12.0 | 3.82 | 12.0 | 11.9 | 3.97 | 8.8  | 8.8  | 3.25 |      |      |
|   | 22  | 14.7               | 9.9  | 3.46                             | 14.7 | 9.9  | 3.71 | 14.1 | 9.7  | 3.95 | 13.1 | 9.4  | 4.11 | 9.6  | 8.0  | 3.36 |      |      |
| S-125PN1E5A<br>U-125PE1E5A<br>(U-125PE1E8A) | 220V-230V-240V<br>50Hz 1phase<br>(380V-400V-415V<br>50Hz 3 phase) | 23                 | 16   | 12.7                             | 9.7  | 3.90 | 12.7 | 9.7  | 4.18 | 12.2 | 9.4  | 4.45 | 11.4 | 9.2  | 4.63 | 8.3  | 7.7  | 3.78 |
|   |   |                    | 19   | 13.6                             | 7.4  | 4.06 | 13.6 | 7.4  | 4.36 | 13.1 | 7.1  | 4.64 | 12.2 | 6.9  | 4.83 | 8.9  | 5.5  | 3.95 |
|   |   |                    | 22   | 14.9                             | 5.1  | 4.20 | 14.9 | 5.2  | 4.52 | 14.3 | 4.9  | 4.80 | 13.3 | 4.6  | 5.00 | 9.7  | 3.3  | 4.08 |
|   |   | 25                 | 16   | 13.2                             | 11.5 | 3.96 | 13.2 | 11.6 | 4.26 | 12.7 | 11.2 | 4.53 | 11.8 | 11.0 | 4.71 | 8.6  | 8.6  | 3.85 |
|   |   |                    | 19   | 14.1                             | 9.1  | 4.13 | 14.1 | 9.2  | 4.44 | 13.5 | 8.9  | 4.72 | 12.6 | 8.6  | 4.91 | 9.2  | 7.1  | 4.01 |
|   |   |                    | 22   | 15.4                             | 6.8  | 4.27 | 15.4 | 6.8  | 4.59 | 14.8 | 6.6  | 4.88 | 13.8 | 6.3  | 5.08 | 10.1 | 5.0  | 4.15 |
|   |   | 27                 | 16   | 13.6                             | 13.4 | 4.03 | 13.6 | 13.5 | 4.33 | 13.1 | 13.1 | 4.60 | 12.2 | 12.2 | 4.79 | 8.9  | 8.9  | 3.91 |
|   |   |                    | 19   | 14.6                             | 11.1 | 4.20 | 14.6 | 11.0 | 4.51 | 14.0 | 10.6 | 4.80 | 13.0 | 10.4 | 4.99 | 9.5  | 8.8  | 4.08 |
|   |   |                    | 22   | 16.0                             | 8.7  | 4.35 | 16.0 | 8.7  | 4.67 | 15.3 | 8.4  | 4.97 | 14.3 | 8.1  | 5.16 | 10.4 | 6.6  | 4.22 |
|   |   | 29                 | 16   | 13.8                             | 13.8 | 4.04 | 13.8 | 13.8 | 4.34 | 13.3 | 13.3 | 4.61 | 12.4 | 12.4 | 4.80 | 9.0  | 9.0  | 3.92 |
|   |   |                    | 19   | 14.8                             | 12.7 | 4.21 | 14.8 | 12.7 | 4.52 | 14.2 | 12.4 | 4.81 | 13.2 | 12.1 | 5.00 | 9.7  | 9.7  | 4.09 |
|   |   |                    | 22   | 16.2                             | 10.4 | 4.36 | 16.2 | 10.4 | 4.68 | 15.6 | 10.1 | 4.98 | 14.5 | 9.7  | 5.18 | 10.6 | 8.3  | 4.23 |
| 32  | 16  | 14.0               | 14.0 | 4.05                             | 14.0 | 14.0 | 4.35 | 13.5 | 13.5 | 4.62 | 12.6 | 12.6 | 4.81 | 9.2  | 9.2  | 3.93 |      |      |
|   | 19  | 15.0               | 12.9 | 4.22                             | 15.0 | 12.9 | 4.53 | 14.4 | 12.6 | 4.82 | 13.4 | 12.3 | 5.02 | 9.8  | 9.8  | 4.10 |      |      |
|   | 22  | 16.4               | 10.5 | 4.37                             | 16.4 | 10.5 | 4.69 | 15.8 | 10.3 | 4.99 | 14.7 | 9.9  | 5.19 | 10.7 | 8.3  | 4.24 |      |      |
| S-140PN1E5A<br>U-140PE1E5A<br>(U-140PE1E8A) | 220V-230V-240V<br>50Hz 1phase<br>(380V-400V-415V<br>50Hz 3 phase) | 23                 | 16   | 14.1                             | 10.4 | 5.03 | 14.1 | 10.5 | 5.40 | 13.6 | 10.1 | 5.75 | 12.6 | 9.8  | 5.98 | 9.2  | 8.3  | 4.89 |
|   |   |                    | 19   | 15.1                             | 8.0  | 5.25 | 15.1 | 8.1  | 5.64 | 14.5 | 7.8  | 6.00 | 13.5 | 7.4  | 6.24 | 9.8  | 5.9  | 5.10 |
|   |   |                    | 22   | 16.5                             | 5.7  | 5.43 | 16.5 | 5.6  | 5.83 | 15.9 | 5.5  | 6.21 | 14.8 | 5.1  | 6.45 | 10.8 | 3.7  | 5.27 |
|   |   | 25                 | 16   | 14.6                             | 12.3 | 5.12 | 14.6 | 12.4 | 5.50 | 14.0 | 11.9 | 5.85 | 13.1 | 11.7 | 6.08 | 9.5  | 9.5  | 4.97 |
|   |   |                    | 19   | 15.6                             | 9.8  | 5.34 | 15.6 | 9.9  | 5.73 | 15.0 | 9.5  | 6.10 | 13.9 | 9.2  | 6.34 | 10.2 | 7.6  | 5.18 |
|   |   |                    | 22   | 17.1                             | 7.4  | 5.52 | 17.1 | 7.5  | 5.93 | 16.4 | 7.1  | 6.31 | 15.3 | 6.8  | 6.56 | 11.2 | 5.4  | 5.36 |
|   |   | 27                 | 16   | 15.1                             | 14.2 | 5.20 | 15.1 | 14.3 | 5.59 | 14.5 | 13.9 | 5.94 | 13.5 | 13.5 | 6.18 | 9.9  | 9.9  | 5.05 |
|   |   |                    | 19   | 16.1                             | 11.7 | 5.43 | 16.1 | 11.8 | 5.83 | 15.5 | 11.4 | 6.20 | 14.4 | 11.1 | 6.45 | 10.5 | 9.3  | 5.27 |
|   |   |                    | 22   | 17.7                             | 9.3  | 5.61 | 17.7 | 9.4  | 6.03 | 17.0 | 9.0  | 6.41 | 15.8 | 8.7  | 6.67 | 11.5 | 7.0  | 5.45 |
|   |   | 29                 | 16   | 15.3                             | 15.3 | 5.21 | 15.3 | 15.3 | 5.60 | 14.7 | 14.7 | 5.96 | 13.7 | 13.7 | 6.20 | 10.0 | 10.0 | 5.06 |
|   |   |                    | 19   | 16.4                             | 13.5 | 5.44 | 16.4 | 13.5 | 5.84 | 15.7 | 13.1 | 6.22 | 14.6 | 12.9 | 6.46 | 10.7 | 10.7 | 5.28 |
|   |   |                    | 22   | 17.9                             | 11.1 | 5.63 | 17.9 | 11.2 | 6.04 | 17.2 | 10.8 | 6.43 | 16.0 | 10.5 | 6.69 | 11.7 | 8.7  | 5.47 |
| 32  | 16  | 15.5               | 15.5 | 5.23                             | 15.5 | 15.5 | 5.61 | 14.9 | 14.9 | 5.97 | 13.9 | 13.9 | 6.21 | 10.2 | 10.2 | 5.08 |      |      |
|   | 19  | 16.6               | 13.7 | 5.45                             | 16.6 | 13.7 | 5.86 | 16.0 | 13.4 | 6.23 | 14.8 | 13.0 | 6.48 | 10.9 | 10.9 | 5.30 |      |      |
|   | 22  | 18.2               | 11.3 | 5.64                             | 18.2 | 11.4 | 6.06 | 17.5 | 11.0 | 6.45 | 16.3 | 10.7 | 6.70 | 11.9 | 8.9  | 5.48 |      |      |

1-13. Capacity Table

1. Cooling Capacity Performance Data

TC :Cooling Capacity

SHC :Sensible Heat Capacity

IPT :Cooling Power Consumption

• Combination of Multiple Unit

Ducted Type

unit : kW

| Model  | Power Source  | Ambient Return Air                           |   | Outdoor air intake temp(°C D.B.) |      |      |      |      |      |      |      |      |      |      |      |      |      |      |     |      |
|--|---|--|---|----------------------------------|------|------|------|------|------|------|------|------|------|------|------|------|------|------|-----|------|
|  |   |  |   | 25°C                             |      |      | 30°C |      |      | 35°C |      |      | 40°C |      |      | 46°C |      |      |     |      |
|  |   |  |   | DB                               | WB   | TC   | SHC  | IPT  | TC   | SHC  | IPT  | TC   | SHC  | IPT  | TC   | SHC  | IPT  | TC   | SHC | IPT  |
| S-36PN1E5A×2<br>U-71PE1E5A<br>(U-71PE1E8A)   | 220V-230V-240V<br>50Hz 1phase<br>(380V-400V-415V<br>50Hz 3 phase) | 23   | 16  | 8.1                              | 7.0  | 2.34 | 7.9  | 6.9  | 2.50 | 7.6  | 6.7  | 2.69 | 7.2  | 6.5  | 2.67 | 6.3  | 6.2  | 2.28 |     |      |
|  |   |  | 19  | 8.5                              | 5.0  | 2.42 | 8.3  | 4.9  | 2.59 | 8.0  | 4.7  | 2.75 | 7.5  | 4.6  | 2.70 | 6.6  | 4.2  | 2.31 |     |      |
|  |   |  | 22  | 9.0                              | 2.9  | 2.53 | 8.7  | 2.8  | 2.68 | 8.3  | 2.7  | 2.83 | 7.8  | 2.6  | 2.72 | 6.8  | 2.3  | 2.34 |     |      |
|  |   | 25   | 16  | 8.1                              | 8.1  | 2.34 | 7.9  | 7.9  | 2.50 | 7.6  | 7.6  | 2.69 | 7.2  | 7.2  | 2.67 | 6.3  | 6.3  | 2.28 |     |      |
|  |   |  | 19  | 8.5                              | 6.1  | 2.42 | 8.3  | 6.0  | 2.59 | 8.0  | 6.0  | 2.75 | 7.5  | 5.7  | 2.70 | 6.6  | 5.5  | 2.31 |     |      |
|  |   |  | 22  | 9.0                              | 4.2  | 2.53 | 8.7  | 4.1  | 2.68 | 8.3  | 3.9  | 2.83 | 7.8  | 3.7  | 2.72 | 6.8  | 3.4  | 2.34 |     |      |
|  |   | 27   | 16  | 8.1                              | 8.1  | 2.34 | 7.9  | 7.9  | 2.50 | 7.6  | 7.6  | 2.69 | 7.2  | 7.2  | 2.67 | 6.3  | 6.3  | 2.28 |     |      |
|  |   |  | 19  | 8.5                              | 7.3  | 2.42 | 8.3  | 7.3  | 2.59 | 8.0  | 7.1  | 2.75 | 7.5  | 6.8  | 2.70 | 6.6  | 6.6  | 2.31 |     |      |
|  |   |  | 22  | 9.0                              | 5.3  | 2.53 | 8.7  | 5.2  | 2.68 | 8.3  | 5.0  | 2.83 | 7.8  | 4.9  | 2.72 | 6.8  | 4.6  | 2.34 |     |      |
|  |   | 29   | 16  | 8.1                              | 8.1  | 2.34 | 7.9  | 7.9  | 2.50 | 7.6  | 7.6  | 2.69 | 7.2  | 7.2  | 2.67 | 6.3  | 6.3  | 2.28 |     |      |
|  |   |  | 19  | 8.5                              | 8.5  | 2.42 | 8.3  | 8.3  | 2.59 | 8.0  | 8.0  | 2.75 | 7.5  | 7.5  | 2.70 | 6.6  | 6.6  | 2.31 |     |      |
|  |   |  | 22  | 9.0                              | 6.5  | 2.53 | 8.7  | 6.4  | 2.68 | 8.3  | 6.3  | 2.83 | 7.8  | 6.1  | 2.72 | 6.8  | 5.8  | 2.34 |     |      |
|  |   | 32   | 16  | 8.1                              | 8.1  | 2.34 | 7.9  | 7.9  | 2.50 | 7.6  | 7.6  | 2.69 | 7.2  | 7.2  | 2.67 | 6.3  | 6.3  | 2.28 |     |      |
|  |   |  | 19  | 8.5                              | 8.5  | 2.42 | 8.3  | 8.3  | 2.59 | 8.0  | 8.0  | 2.75 | 7.5  | 7.5  | 2.70 | 6.6  | 6.6  | 2.31 |     |      |
|  |   |  | 22  | 9.0                              | 6.5  | 2.53 | 8.7  | 6.4  | 2.68 | 8.3  | 6.3  | 2.83 | 7.8  | 6.1  | 2.72 | 6.8  | 5.8  | 2.34 |     |      |
|  |   | S-36PN1E5A×3<br>U-100PE1E5A<br>(U-100PE1E8A) | 220V-230V-240V<br>50Hz 1phase<br>(380V-400V-415V<br>50Hz 3 phase) | 23                               | 16   | 11.4 | 10.2 | 3.08 | 11.4 | 10.2 | 3.31 | 10.9 | 9.9  | 3.52 | 10.2 | 9.8  | 3.67 | 7.4  | 7.4 | 3.00 |
|  |   |  |   |                                  | 19   | 12.1 | 7.4  | 3.22 | 12.1 | 7.2  | 3.46 | 11.7 | 7.1  | 3.68 | 10.9 | 6.9  | 3.82 | 7.9  | 5.7 | 3.12 |
|  |   |  |   |                                  | 22   | 13.3 | 4.4  | 3.33 | 13.3 | 4.4  | 3.57 | 12.8 | 4.3  | 3.80 | 11.9 | 3.9  | 3.96 | 8.7  | 2.9 | 3.23 |
| 25   | 16  |  |   | 11.8                             | 11.8 | 3.14 | 11.8 | 11.8 | 3.37 | 11.3 | 11.3 | 3.58 | 10.5 | 10.5 | 3.73 | 7.7  | 7.7  | 3.05 |     |      |
|  | 19  |  |   | 12.6                             | 9.5  | 3.27 | 12.6 | 9.5  | 3.51 | 12.1 | 9.2  | 3.74 | 11.2 | 9.0  | 3.89 | 8.2  | 7.7  | 3.18 |     |      |
|  | 22  |  |   | 13.8                             | 6.6  | 3.38 | 13.8 | 6.6  | 3.64 | 13.2 | 6.3  | 3.87 | 12.3 | 6.1  | 4.02 | 9.0  | 4.9  | 3.29 |     |      |
| 27   | 16  |  |   | 12.2                             | 12.2 | 3.19 | 12.2 | 12.2 | 3.42 | 11.7 | 11.7 | 3.64 | 10.9 | 10.9 | 3.79 | 8.0  | 8.0  | 3.10 |     |      |
|  | 19  |  |   | 13.0                             | 11.7 | 3.33 | 13.0 | 11.7 | 3.57 | 12.5 | 11.5 | 3.80 | 11.6 | 11.3 | 3.95 | 8.5  | 8.5  | 3.23 |     |      |
|  | 22  |  |   | 14.2                             | 8.9  | 3.44 | 14.2 | 8.9  | 3.70 | 13.7 | 8.6  | 3.93 | 12.7 | 8.4  | 4.09 | 9.3  | 7.0  | 3.34 |     |      |
| 29   | 16  |  |   | 12.4                             | 12.4 | 3.20 | 12.4 | 12.4 | 3.43 | 11.9 | 11.9 | 3.65 | 11.0 | 11.0 | 3.80 | 8.1  | 8.1  | 3.10 |     |      |
|  | 19  |  |   | 13.2                             | 13.2 | 3.33 | 13.2 | 13.2 | 3.58 | 12.7 | 12.7 | 3.81 | 11.8 | 11.8 | 3.96 | 8.6  | 8.6  | 3.24 |     |      |
|  | 22  |  |   | 14.5                             | 11.1 | 3.45 | 14.5 | 11.1 | 3.70 | 13.9 | 10.7 | 3.94 | 12.9 | 10.6 | 4.10 | 9.5  | 9.1  | 3.35 |     |      |
| 32   | 16  |  |   | 12.5                             | 12.5 | 3.20 | 12.5 | 12.5 | 3.44 | 12.1 | 12.1 | 3.66 | 11.2 | 11.2 | 3.81 | 8.2  | 8.2  | 3.11 |     |      |
|  | 19  |  |   | 13.4                             | 13.4 | 3.34 | 13.4 | 13.4 | 3.59 | 12.9 | 12.9 | 3.82 | 12.0 | 12.0 | 3.97 | 8.8  | 8.8  | 3.25 |     |      |
|  | 22  |  |   | 14.7                             | 11.3 | 3.46 | 14.7 | 11.3 | 3.71 | 14.1 | 10.9 | 3.95 | 13.1 | 10.8 | 4.11 | 9.6  | 9.2  | 3.36 |     |      |
| S-50PN1E5A×2<br>U-100PE1E5A<br>(U-100PE1E8A) | 220V-230V-240V<br>50Hz 1phase<br>(380V-400V-415V<br>50Hz 3 phase) |  |   | 23                               | 16   | 11.4 | 9.0  | 3.08 | 11.4 | 9.1  | 3.31 | 10.9 | 8.6  | 3.52 | 10.2 | 8.5  | 3.67 | 7.4  | 7.3 | 3.00 |
|  |   |  |   |                                  | 19   | 12.1 | 6.6  | 3.22 | 12.1 | 6.6  | 3.46 | 11.7 | 6.4  | 3.68 | 10.9 | 6.2  | 3.82 | 7.9  | 5.0 | 3.12 |
|  |   |  |   |                                  | 22   | 13.3 | 4.5  | 3.33 | 13.3 | 4.5  | 3.57 | 12.8 | 4.3  | 3.80 | 11.9 | 3.9  | 3.96 | 8.7  | 2.9 | 3.23 |
|  |   | 25   | 16  | 11.8                             | 10.8 | 3.14 | 11.8 | 10.8 | 3.37 | 11.3 | 10.5 | 3.58 | 10.5 | 10.3 | 3.73 | 7.7  | 7.7  | 3.05 |     |      |
|  |   |  | 19  | 12.6                             | 8.4  | 3.27 | 12.6 | 8.4  | 3.51 | 12.1 | 8.1  | 3.74 | 11.2 | 8.0  | 3.89 | 8.2  | 6.6  | 3.18 |     |      |
|  |   |  | 22  | 13.8                             | 6.1  | 3.38 | 13.8 | 6.1  | 3.64 | 13.2 | 5.9  | 3.87 | 12.3 | 5.6  | 4.02 | 9.0  | 4.4  | 3.29 |     |      |
|  |   | 27   | 16  | 12.2                             | 12.2 | 3.19 | 12.2 | 12.2 | 3.42 | 11.7 | 11.7 | 3.64 | 10.9 | 10.9 | 3.79 | 8.0  | 8.0  | 3.10 |     |      |
|  |   |  | 19  | 13.0                             | 10.2 | 3.33 | 13.0 | 10.2 | 3.57 | 12.5 | 9.9  | 3.80 | 11.6 | 9.7  | 3.95 | 8.5  | 8.4  | 3.23 |     |      |
|  |   |  | 22  | 14.2                             | 7.8  | 3.44 | 14.2 | 7.8  | 3.70 | 13.7 | 7.7  | 3.93 | 12.7 | 7.4  | 4.09 | 9.3  | 6.1  | 3.34 |     |      |
|  |   | 29   | 16  | 12.4                             | 12.4 | 3.20 | 12.4 | 12.4 | 3.43 | 11.9 | 11.9 | 3.65 | 11.0 | 11.0 | 3.80 | 8.1  | 8.1  | 3.10 |     |      |
|  |   |  | 19  | 13.2                             | 11.9 | 3.33 | 13.2 | 11.9 | 3.58 | 12.7 | 11.7 | 3.81 | 11.8 | 11.5 | 3.96 | 8.6  | 8.6  | 3.24 |     |      |
|  |   |  | 22  | 14.5                             | 9.6  | 3.45 | 14.5 | 9.6  | 3.70 | 13.9 | 9.4  | 3.94 | 12.9 | 9.1  | 4.10 | 9.5  | 7.7  | 3.35 |     |      |
|  |   | 32   | 16  | 12.5                             | 12.5 | 3.20 | 12.5 | 12.5 | 3.44 | 12.1 | 12.1 | 3.66 | 11.2 | 11.2 | 3.81 | 8.2  | 8.2  | 3.11 |     |      |
|  |   |  | 19  | 13.4                             | 12.1 | 3.34 | 13.4 | 12.1 | 3.59 | 12.9 | 11.9 | 3.82 | 12.0 | 11.7 | 3.97 | 8.8  | 8.8  | 3.25 |     |      |
|  |   |  | 22  | 14.7                             | 9.8  | 3.46 | 14.7 | 9.8  | 3.71 | 14.1 | 9.5  | 3.95 | 13.1 | 9.2  | 4.11 | 9.6  | 7.8  | 3.36 |     |      |
|  |   | S-36PN1E5A×4<br>U-125PE1E5A<br>(U-125PE1E8A) | 220V-230V-240V<br>50Hz 1phase<br>(380V-400V-415V<br>50Hz 3 phase) | 23                               | 16   | 12.7 | 11.8 | 3.90 | 12.7 | 11.9 | 4.18 | 12.2 | 11.5 | 4.45 | 11.4 | 11.4 | 4.63 | 8.3  | 8.3 | 3.78 |
|  |   |  |   |                                  | 19   | 13.6 | 8.4  | 4.06 | 13.6 | 8.5  | 4.36 | 13.1 | 8.2  | 4.64 | 12.2 | 7.9  | 4.83 | 8.9  | 6.6 | 3.95 |
|  |   |  |   |                                  | 22   | 14.9 | 4.9  | 4.20 | 14.9 | 4.9  | 4.52 | 14.3 | 4.7  | 4.80 | 13.3 | 4.4  | 5.00 | 9.7  | 3.3 | 4.08 |
| 25   | 16  |  |   | 13.2                             | 13.2 | 3.96 | 13.2 | 13.2 | 4.26 | 12.7 | 12.7 | 4.53 | 11.8 | 11.8 | 4.71 | 8.6  | 8.6  | 3.85 |     |      |
|  | 19  |  |   | 14.1                             | 11.0 | 4.13 | 14.1 | 11.0 | 4.44 | 13.5 | 10.7 | 4.72 | 12.6 | 10.5 | 4.91 | 9.2  | 9.1  | 4.01 |     |      |
|  | 22  |  |   | 15.4                             | 7.5  | 4.27 | 15.4 | 7.5  | 4.59 | 14.8 | 7.2  | 4.88 | 13.8 | 7.0  | 5.08 | 10.1 | 5.7  | 4.15 |     |      |
| 27   | 16  |  |   | 13.6                             | 13.6 | 4.03 | 13.6 | 13.6 | 4.33 | 13.1 | 13.1 | 4.60 | 12.2 | 12.2 | 4.79 | 8.9  | 8.9  | 3.91 |     |      |
|  | 19  |  |   | 14.6                             | 13.7 | 4.20 | 14.6 | 13.8 | 4.51 | 14.0 | 13.3 | 4.80 | 13.0 | 13.0 | 4.99 | 9.5  | 9.5  | 4.08 |     |      |
|  | 22  |  |   | 16.0                             | 10.3 | 4.35 | 16.0 | 10.2 | 4.67 | 15.3 | 9.9  | 4.97 | 14.3 | 9.6  | 5.16 | 10.4 | 8.2  | 4.22 |     |      |
| 29   | 16  |  |   | 13.8                             | 13.8 | 4.04 | 13.8 | 13.8 | 4.34 | 13.3 | 13.3 | 4.61 | 12.4 | 12.4 | 4.80 | 9.0  | 9.0  | 3.92 |     |      |
|  | 19  |  |   | 14.8                             | 14.8 | 4.21 | 14.8 | 14.8 | 4.52 | 14.2 | 14.2 | 4.81 | 13.2 | 13.2 | 5.00 | 9.7  | 9.7  | 4.09 |     |      |
|  | 22  |  |   | 16.2                             | 12.9 | 4.36 | 16.2 | 12.9 | 4.68 | 15.6 | 12.5 | 4.98 | 14.5 | 12.3 | 5.18 | 10.6 | 10.6 | 4.23 |     |      |
| 32   | 16  |  |   | 14.0                             | 14.0 | 4.05 | 14.0 | 14.0 | 4.35 | 13.5 | 13.5 | 4.62 | 12.6 | 12.6 | 4.81 | 9.2  | 9.2  | 3.93 |     |      |
|  | 19  |  |   | 15.0                             | 15.0 | 4.22 | 15.0 | 15.0 | 4.53 | 14.4 | 14.4 | 4.82 | 13.4 | 13.4 | 5.02 | 9.8  | 9.8  | 4.10 |     |      |
|  | 22  |  |   | 16.4                             | 13.1 | 4.37 | 16.4 | 13.1 | 4.69 | 15.8 | 12.7 | 4.99 | 14.7 | 12.5 | 5.19 | 10.7 | 10.7 | 4.24 |     |      |
| S-45PN1E5A×3<br>U-125PE1E5A<br>(U-125PE1E8A) | 220V-230V-240V<br>50Hz 1phase<br>(380V-400V-415V<br>50Hz 3 phase) |  |   | 23                               | 16   | 12.7 | 10.8 | 3.90 | 12.7 | 10.9 | 4.18 | 12.2 | 10.6 | 4.45 | 11.4 | 10.5 | 4.63 | 8.3  | 8.3 | 3.78 |
|  |   |  |   |                                  | 19   | 13.6 | 8.0  | 4.06 | 13.6 | 7.9  | 4.36 | 13.1 | 7.7  | 4.64 | 12.2 | 7.4  | 4.83 | 8.9  | 6.1 | 3.95 |
|  |   |  |   |                                  | 22   | 14.9 | 4.9  | 4.20 | 14.9 | 4.9  | 4.52 | 14.3 | 4.7  | 4.80 | 13.3 | 4.4  | 5.00 | 9.7  | 3.2 | 4.08 |
|  |   | 25   | 16  | 13.2                             | 13.2 | 3.96 | 13.2 | 13.2 | 4.26 | 12.7 | 12.7 | 4.53 | 11.8 | 11.8 | 4.71 | 8.6  | 8.6  | 3.85 |     |      |
|  |   |  | 19  | 14.1                             | 10.1 | 4.13 | 14.1 | 10.2 | 4.44 | 13.5 | 9.8  | 4.72 | 12.6 | 9.7  | 4.91 | 9.2  | 8.3  | 4.01 |     |      |
|  |   |  | 22  | 15.4                             | 7.1  | 4.27 | 15.4 | 7.2  | 4.59 | 14.8 | 6.9  | 4.88 | 13.8 | 6.6  | 5.08 | 10.1 | 5.3  | 4.15 |     |      |
|  |   | 27   | 16  | 13.6                             | 13.6 | 4.03 | 13.6 | 13.6 | 4.33 | 13.1 | 13.1 | 4.60 | 12.2 | 12.2 | 4.79 | 8.9  | 8.9  | 3.91 |     |      |
|  |   |  | 19  | 14.6                             | 12.5 | 4.20 | 14.6 | 12.6 | 4.51 | 14.0 | 12.2 | 4.80 | 13.0 | 12.0 | 4.99 | 9.5  | 9.5  | 4.08 |     |      |
|  |   |  | 22  | 16.0                             | 9.6  | 4.35 | 16.0 | 9.6  | 4.67 | 15.3 | 9.2  | 4.97 | 14.3 | 9.0  | 5.16 | 10.4 | 7.4  | 4.22 |     |      |
|  |   | 29   | 16  | 13.8                             | 13.8 | 4.04 | 13.8 | 13.8 | 4.34 | 13.3 | 13.3 | 4.61 | 12.4 | 12.4 | 4.80 | 9.0  | 9.0  | 3.92 |     |      |
|  |   |  | 19  | 14.8                             | 14.8 | 4.21 | 14.8 | 14.8 | 4.52 | 14.2 | 14.2 | 4.81 | 13.2 | 13.2 | 5.00 | 9.7  | 9.7  | 4.09 |     |      |
|  |   |  | 22  | 16.2                             | 11.7 | 4.36 | 16.2 | 11.8 | 4.68 | 15.6 | 11.6 | 4.98 | 14.5 | 11.2 | 5.18 | 10.6 | 9.7  | 4.23 |     |      |
|  |   | 32   | 16  | 14.0                             | 14.0 | 4.05 | 14.0 | 14.0 | 4.35 | 13.5 | 13.5 | 4.62 | 12.6 | 12.6 | 4.81 | 9.2  | 9.2  | 3.93 |     |      |
|  |   |  | 19  | 15.0                             | 15.0 | 4.22 | 15.0 | 15.0 | 4.53 | 14.4 | 14.4 | 4.82 | 13.4 | 13.4 | 5.02 | 9.8  | 9.8  | 4.10 |     |      |
|  |   |  | 22  | 16.4                             | 11.9 | 4.37 | 16.4 | 12.0 | 4.69 | 15.8 | 11.7 | 4.99 | 14.7 |      |      |      |      |      |     |      |

1-13. Capacity Table

1. Cooling Capacity Performance Data

TC :Cooling Capacity

SHC :Sensible Heat Capacity

IPT :Cooling Power Consumption

• Combination of Multiple Unit

Ducted Type

unit : kW

| Model  | Power Source  | Ambient Return Air                           |   | Outdoor air intake temp(°C D.B.) |      |      |      |      |      |      |      |      |      |      |      |      |      |      |     |      |
|--|---|--|---|----------------------------------|------|------|------|------|------|------|------|------|------|------|------|------|------|------|-----|------|
|  |   |  |   | 25°C                             |      |      | 30°C |      |      | 35°C |      |      | 40°C |      |      | 46°C |      |      |     |      |
|  |   | DB   | WB  | TC                               | SHC  | IPT  | TC   | SHC  | IPT  | TC   | SHC  | IPT  | TC   | SHC  | IPT  | TC   | SHC  | IPT  |     |      |
| S-60PN1E5A×2<br>U-125PE1E5A<br>(U-125PE1E8A) | 220V-230V-240V<br>50Hz 1phase<br>(380V-400V-415V<br>50Hz 3 phase) | 23   | 16  | 12.7                             | 10.4 | 3.90 | 12.7 | 10.5 | 4.18 | 12.2 | 10.2 | 4.45 | 11.4 | 10.0 | 4.63 | 8.3  | 8.3  | 3.78 |     |      |
|  |   |  | 19  | 13.6                             | 7.7  | 4.06 | 13.6 | 7.7  | 4.36 | 13.1 | 7.4  | 4.64 | 12.2 | 7.2  | 4.83 | 8.9  | 5.9  | 3.95 |     |      |
|  |   |  | 22  | 14.9                             | 4.9  | 4.20 | 14.9 | 4.9  | 4.52 | 14.3 | 4.7  | 4.80 | 13.3 | 4.4  | 5.00 | 9.7  | 3.2  | 4.08 |     |      |
|  |   | 25   | 16  | 13.2                             | 12.7 | 3.96 | 13.2 | 12.8 | 4.26 | 12.7 | 12.4 | 4.53 | 11.8 | 11.8 | 4.71 | 8.6  | 8.6  | 3.85 |     |      |
|  |   |  | 19  | 14.1                             | 9.8  | 4.13 | 14.1 | 9.8  | 4.44 | 13.5 | 9.5  | 4.72 | 12.6 | 9.3  | 4.91 | 9.2  | 7.8  | 4.01 |     |      |
|  |   |  | 22  | 15.4                             | 7.0  | 4.27 | 15.4 | 6.9  | 4.59 | 14.8 | 6.8  | 4.88 | 13.8 | 6.5  | 5.08 | 10.1 | 5.1  | 4.15 |     |      |
|  |   | 27   | 16  | 13.6                             | 13.6 | 4.03 | 13.6 | 13.6 | 4.33 | 13.1 | 13.1 | 4.60 | 12.2 | 12.2 | 4.79 | 8.9  | 8.9  | 3.91 |     |      |
|  |   |  | 19  | 14.6                             | 12.0 | 4.20 | 14.6 | 12.1 | 4.51 | 14.0 | 11.6 | 4.80 | 13.0 | 11.5 | 4.99 | 9.5  | 9.5  | 4.08 |     |      |
|  |   |  | 22  | 16.0                             | 9.2  | 4.35 | 16.0 | 9.3  | 4.67 | 15.3 | 8.9  | 4.97 | 14.3 | 8.7  | 5.16 | 10.4 | 7.1  | 4.22 |     |      |
|  |   | 29   | 16  | 13.8                             | 13.8 | 4.04 | 13.8 | 13.8 | 4.34 | 13.3 | 13.3 | 4.61 | 12.4 | 12.4 | 4.80 | 9.0  | 9.0  | 3.92 |     |      |
|  |   |  | 19  | 14.8                             | 14.1 | 4.21 | 14.8 | 14.1 | 4.52 | 14.2 | 13.6 | 4.81 | 13.2 | 13.2 | 5.00 | 9.7  | 9.7  | 4.09 |     |      |
|  |   |  | 22  | 16.2                             | 11.2 | 4.36 | 16.2 | 11.3 | 4.68 | 15.6 | 11.0 | 4.98 | 14.5 | 10.7 | 5.18 | 10.6 | 9.2  | 4.23 |     |      |
|  |   | 32   | 16  | 14.0                             | 14.0 | 4.05 | 14.0 | 14.0 | 4.35 | 13.5 | 13.5 | 4.62 | 12.6 | 12.6 | 4.81 | 9.2  | 9.2  | 3.93 |     |      |
|  |   |  | 19  | 15.0                             | 14.3 | 4.22 | 15.0 | 14.3 | 4.53 | 14.4 | 13.8 | 4.82 | 13.4 | 13.4 | 5.02 | 9.8  | 9.8  | 4.10 |     |      |
|  |   |  | 22  | 16.4                             | 11.4 | 4.37 | 16.4 | 11.5 | 4.69 | 15.8 | 11.1 | 4.99 | 14.7 | 10.9 | 5.19 | 10.7 | 9.3  | 4.24 |     |      |
|  |   | S-50PN1E5A×3<br>U-140PE1E5A<br>(U-140PE1E8A) | 220V-230V-240V<br>50Hz 1phase<br>(380V-400V-415V<br>50Hz 3 phase) | 23                               | 16   | 14.1 | 11.4 | 5.03 | 14.1 | 11.5 | 5.40 | 13.6 | 11.2 | 5.75 | 12.6 | 10.9 | 5.98 | 9.2  | 9.2 | 4.89 |
|  |   |  |   |                                  | 19   | 15.1 | 8.4  | 5.25 | 15.1 | 8.5  | 5.64 | 14.5 | 8.2  | 6.00 | 13.5 | 7.9  | 6.24 | 9.8  | 6.4 | 5.10 |
|  |   |  |   |                                  | 22   | 16.5 | 5.5  | 5.43 | 16.5 | 5.4  | 5.83 | 15.9 | 5.3  | 6.21 | 14.8 | 4.9  | 6.45 | 10.8 | 3.6 | 5.27 |
| 25   | 16  |  |   | 14.6                             | 13.8 | 5.12 | 14.6 | 13.9 | 5.50 | 14.0 | 13.5 | 5.85 | 13.1 | 13.1 | 6.08 | 9.5  | 9.5  | 4.97 |     |      |
|  | 19  |  |   | 15.6                             | 10.7 | 5.34 | 15.6 | 10.8 | 5.73 | 15.0 | 10.4 | 6.10 | 13.9 | 10.1 | 6.34 | 10.2 | 8.6  | 5.18 |     |      |
|  | 22  |  |   | 17.1                             | 7.8  | 5.52 | 17.1 | 7.7  | 5.93 | 16.4 | 7.5  | 6.31 | 15.3 | 7.1  | 6.56 | 11.2 | 5.7  | 5.36 |     |      |
| 27   | 16  |  |   | 15.1                             | 15.1 | 5.20 | 15.1 | 15.1 | 5.59 | 14.5 | 14.5 | 5.94 | 13.5 | 13.5 | 6.18 | 9.9  | 9.9  | 5.05 |     |      |
|  | 19  |  |   | 16.1                             | 13.1 | 5.43 | 16.1 | 13.2 | 5.83 | 15.5 | 12.7 | 6.20 | 14.4 | 12.6 | 6.45 | 10.5 | 10.5 | 5.27 |     |      |
|  | 22  |  |   | 17.7                             | 10.0 | 5.61 | 17.7 | 10.1 | 6.03 | 17.0 | 9.7  | 6.41 | 15.8 | 9.5  | 6.67 | 11.5 | 7.8  | 5.45 |     |      |
| 29   | 16  |  |   | 15.3                             | 15.3 | 5.21 | 15.3 | 15.3 | 5.60 | 14.7 | 14.7 | 5.96 | 13.7 | 13.7 | 6.20 | 10.0 | 10.0 | 5.06 |     |      |
|  | 19  |  |   | 16.4                             | 15.4 | 5.44 | 16.4 | 15.5 | 5.84 | 15.7 | 14.9 | 6.22 | 14.6 | 14.6 | 6.46 | 10.7 | 10.7 | 5.28 |     |      |
|  | 22  |  |   | 17.9                             | 12.3 | 5.63 | 17.9 | 12.4 | 6.04 | 17.2 | 11.9 | 6.43 | 16.0 | 11.7 | 6.69 | 11.7 | 10.0 | 5.47 |     |      |
| 32   | 16  |  |   | 15.5                             | 15.5 | 5.23 | 15.5 | 15.5 | 5.61 | 14.9 | 14.9 | 5.97 | 13.9 | 13.9 | 6.21 | 10.2 | 10.2 | 5.08 |     |      |
|  | 19  |  |   | 16.6                             | 15.6 | 5.45 | 16.6 | 15.7 | 5.86 | 16.0 | 15.2 | 6.23 | 14.8 | 14.8 | 6.48 | 10.9 | 10.9 | 5.30 |     |      |
|  | 22  |  |   | 18.2                             | 12.5 | 5.64 | 18.2 | 12.6 | 6.06 | 17.5 | 12.1 | 6.45 | 16.3 | 11.9 | 6.70 | 11.9 | 10.2 | 5.48 |     |      |
| S-71PN1E5A×2<br>U-140PE1E5A<br>(U-140PE1E8A) | 220V-230V-240V<br>50Hz 1phase<br>(380V-400V-415V<br>50Hz 3 phase) |  |   | 23                               | 16   | 14.1 | 11.0 | 5.03 | 14.1 | 11.0 | 5.40 | 13.6 | 10.8 | 5.75 | 12.6 | 10.4 | 5.98 | 9.2  | 8.9 | 4.89 |
|  |   |  |   |                                  | 19   | 15.1 | 8.2  | 5.25 | 15.1 | 8.3  | 5.64 | 14.5 | 8.0  | 6.00 | 13.5 | 7.7  | 6.24 | 9.8  | 6.2 | 5.10 |
|  |   |  |   |                                  | 22   | 16.5 | 5.5  | 5.43 | 16.5 | 5.5  | 5.83 | 15.9 | 5.3  | 6.21 | 14.8 | 4.9  | 6.45 | 10.8 | 3.6 | 5.27 |
|  |   | 25   | 16  | 14.6                             | 13.2 | 5.12 | 14.6 | 13.2 | 5.50 | 14.0 | 12.9 | 5.85 | 13.1 | 12.7 | 6.08 | 9.5  | 9.5  | 4.97 |     |      |
|  |   |  | 19  | 15.6                             | 10.4 | 5.34 | 15.6 | 10.4 | 5.73 | 15.0 | 10.1 | 6.10 | 13.9 | 9.7  | 6.34 | 10.2 | 8.2  | 5.18 |     |      |
|  |   |  | 22  | 17.1                             | 7.5  | 5.52 | 17.1 | 7.6  | 5.93 | 16.4 | 7.3  | 6.31 | 15.3 | 6.9  | 6.56 | 11.2 | 5.5  | 5.36 |     |      |
|  |   | 27   | 16  | 15.1                             | 15.1 | 5.20 | 15.1 | 15.1 | 5.59 | 14.5 | 14.5 | 5.94 | 13.5 | 13.5 | 6.18 | 9.9  | 9.9  | 5.05 |     |      |
|  |   |  | 19  | 16.1                             | 12.5 | 5.43 | 16.1 | 12.6 | 5.83 | 15.5 | 12.2 | 6.20 | 14.4 | 12.0 | 6.45 | 10.5 | 10.3 | 5.27 |     |      |
|  |   |  | 22  | 17.7                             | 9.8  | 5.61 | 17.7 | 9.7  | 6.03 | 17.0 | 9.5  | 6.41 | 15.8 | 9.1  | 6.67 | 11.5 | 7.4  | 5.45 |     |      |
|  |   | 29   | 16  | 15.3                             | 15.3 | 5.21 | 15.3 | 15.3 | 5.60 | 14.7 | 14.7 | 5.96 | 13.7 | 13.7 | 6.20 | 10.0 | 10.0 | 5.06 |     |      |
|  |   |  | 19  | 16.4                             | 14.7 | 5.44 | 16.4 | 14.8 | 5.84 | 15.7 | 14.2 | 6.22 | 14.6 | 14.0 | 6.46 | 10.7 | 10.7 | 5.28 |     |      |
|  |   |  | 22  | 17.9                             | 11.8 | 5.63 | 17.9 | 11.9 | 6.04 | 17.2 | 11.5 | 6.43 | 16.0 | 11.2 | 6.69 | 11.7 | 9.4  | 5.47 |     |      |
|  |   | 32   | 16  | 15.5                             | 15.5 | 5.23 | 15.5 | 15.5 | 5.61 | 14.9 | 14.9 | 5.97 | 13.9 | 13.9 | 6.21 | 10.2 | 10.2 | 5.08 |     |      |
|  |   |  | 19  | 16.6                             | 14.9 | 5.45 | 16.6 | 15.0 | 5.86 | 16.0 | 14.5 | 6.23 | 14.8 | 14.2 | 6.48 | 10.9 | 10.9 | 5.30 |     |      |
|  |   |  | 22  | 18.2                             | 12.0 | 5.64 | 18.2 | 12.1 | 6.06 | 17.5 | 11.7 | 6.45 | 16.3 | 11.4 | 6.70 | 11.9 | 9.6  | 5.48 |     |      |



1-13. Capacity Table

1. Cooling Capacity Performance Data

TC :Cooling Capacity

SHC :Sensible Heat Capacity

IPT :Cooling Power Consumption

• Combination of Single Unit

4-Way Cassette 60×60 Type

unit : kW

| Model                    | Power Source                  | Ambient Return Air       |                               | Outdoor air intake temp(°C D.B.) |     |      |      |      |      |      |      |      |      |      |      |      |      |      |     |      |
|--------------------------|-------------------------------|--------------------------|-------------------------------|----------------------------------|-----|------|------|------|------|------|------|------|------|------|------|------|------|------|-----|------|
|                          |                               |                          |                               | 25°C                             |     |      | 30°C |      |      | 35°C |      |      | 40°C |      |      | 46°C |      |      |     |      |
|                          |                               | DB                       | WB                            | TC                               | SHC | IPT  | TC   | SHC  | IPT  | TC   | SHC  | IPT  | TC   | SHC  | IPT  | TC   | SHC  | IPT  |     |      |
| S-36PY2E5A<br>U-36PE2E5A | 220V-230V-240V<br>50Hz 1phase | 23                       | 16                            | 4.2                              | 3.0 | 0.83 | 4.0  | 2.9  | 0.88 | 3.7  | 2.7  | 0.93 | 3.4  | 2.6  | 0.92 | 2.8  | 2.3  | 0.71 |     |      |
|                          |                               |                          | 19                            | 4.5                              | 2.3 | 0.85 | 4.3  | 2.2  | 0.90 | 4.0  | 2.1  | 0.95 | 3.7  | 1.9  | 0.93 | 3.0  | 1.6  | 0.71 |     |      |
|                          |                               |                          | 22                            | 4.8                              | 1.6 | 0.87 | 4.6  | 1.5  | 0.93 | 4.3  | 1.4  | 0.98 | 4.0  | 1.3  | 0.95 | 3.1  | 1.0  | 0.72 |     |      |
|                          |                               | 25                       | 16                            | 4.2                              | 3.4 | 0.83 | 4.0  | 3.2  | 0.88 | 3.7  | 3.1  | 0.93 | 3.4  | 3.0  | 0.92 | 2.8  | 2.7  | 0.71 |     |      |
|                          |                               |                          | 19                            | 4.5                              | 2.7 | 0.85 | 4.3  | 2.6  | 0.90 | 4.0  | 2.4  | 0.95 | 3.7  | 2.3  | 0.93 | 3.0  | 2.0  | 0.71 |     |      |
|                          |                               |                          | 22                            | 4.8                              | 2.0 | 0.87 | 4.6  | 1.9  | 0.93 | 4.3  | 1.8  | 0.98 | 4.0  | 1.7  | 0.95 | 3.1  | 1.3  | 0.72 |     |      |
|                          |                               | 27                       | 16                            | 4.2                              | 3.7 | 0.83 | 4.0  | 3.6  | 0.88 | 3.7  | 3.5  | 0.93 | 3.4  | 3.3  | 0.92 | 2.8  | 2.8  | 0.71 |     |      |
|                          |                               |                          | 19                            | 4.5                              | 3.1 | 0.85 | 4.3  | 3.0  | 0.90 | 4.0  | 2.8  | 0.95 | 3.7  | 2.7  | 0.93 | 3.0  | 2.4  | 0.71 |     |      |
|                          |                               |                          | 22                            | 4.8                              | 2.4 | 0.87 | 4.6  | 2.3  | 0.93 | 4.3  | 2.2  | 0.98 | 4.0  | 2.1  | 0.95 | 3.1  | 1.7  | 0.72 |     |      |
|                          |                               | 29                       | 16                            | 4.2                              | 4.1 | 0.83 | 4.0  | 4.0  | 0.88 | 3.7  | 3.7  | 0.93 | 3.4  | 3.4  | 0.92 | 2.8  | 2.8  | 0.71 |     |      |
|                          |                               |                          | 19                            | 4.5                              | 3.4 | 0.85 | 4.3  | 3.4  | 0.90 | 4.0  | 3.2  | 0.95 | 3.7  | 3.1  | 0.93 | 3.0  | 2.8  | 0.71 |     |      |
|                          |                               |                          | 22                            | 4.8                              | 2.7 | 0.87 | 4.6  | 2.7  | 0.93 | 4.3  | 2.5  | 0.98 | 4.0  | 2.4  | 0.95 | 3.1  | 2.1  | 0.72 |     |      |
|                          |                               | 32                       | 16                            | 4.2                              | 4.2 | 0.83 | 4.0  | 4.0  | 0.88 | 3.7  | 3.7  | 0.93 | 3.4  | 3.4  | 0.92 | 2.8  | 2.8  | 0.71 |     |      |
|                          |                               |                          | 19                            | 4.5                              | 4.0 | 0.85 | 4.3  | 3.9  | 0.90 | 4.0  | 3.8  | 0.95 | 3.7  | 3.6  | 0.93 | 3.0  | 3.0  | 0.71 |     |      |
|                          |                               |                          | 22                            | 4.8                              | 3.3 | 0.87 | 4.6  | 3.2  | 0.93 | 4.3  | 3.1  | 0.98 | 4.0  | 3.0  | 0.95 | 3.1  | 2.6  | 0.72 |     |      |
|                          |                               | S-50PY2E5A<br>U-50PE2E5A | 220V-230V-240V<br>50Hz 1phase | 23                               | 16  | 5.9  | 3.9  | 1.54 | 5.5  | 3.8  | 1.64 | 5.2  | 3.7  | 1.73 | 4.8  | 3.5  | 1.72 | 3.9  | 3.0 | 1.32 |
|                          |                               |                          |                               |                                  | 19  | 6.3  | 3.2  | 1.58 | 6.0  | 3.1  | 1.67 | 5.6  | 2.9  | 1.77 | 5.2  | 2.7  | 1.73 | 4.1  | 2.2 | 1.33 |
|                          |                               |                          |                               |                                  | 22  | 6.8  | 2.5  | 1.63 | 6.4  | 2.3  | 1.72 | 6.1  | 2.2  | 1.82 | 5.5  | 1.9  | 1.77 | 4.4  | 1.5 | 1.34 |
| 25                       | 16                            |                          |                               | 5.9                              | 4.3 | 1.54 | 5.5  | 4.3  | 1.64 | 5.2  | 4.1  | 1.73 | 4.8  | 3.9  | 1.72 | 3.9  | 3.5  | 1.32 |     |      |
|                          | 19                            |                          |                               | 6.3                              | 3.7 | 1.58 | 6.0  | 3.5  | 1.67 | 5.6  | 3.3  | 1.77 | 5.2  | 3.1  | 1.73 | 4.1  | 2.7  | 1.33 |     |      |
|                          | 22                            |                          |                               | 6.8                              | 2.9 | 1.63 | 6.4  | 2.7  | 1.72 | 6.1  | 2.6  | 1.82 | 5.5  | 2.4  | 1.77 | 4.4  | 1.9  | 1.34 |     |      |
| 27                       | 16                            |                          |                               | 5.9                              | 4.7 | 1.54 | 5.5  | 4.7  | 1.64 | 5.2  | 4.5  | 1.73 | 4.8  | 4.3  | 1.72 | 3.9  | 3.9  | 1.32 |     |      |
|                          | 19                            |                          |                               | 6.3                              | 4.1 | 1.58 | 6.0  | 4.0  | 1.67 | 5.6  | 3.8  | 1.77 | 5.2  | 3.6  | 1.73 | 4.1  | 3.1  | 1.33 |     |      |
|                          | 22                            |                          |                               | 6.8                              | 3.3 | 1.63 | 6.4  | 3.1  | 1.72 | 6.1  | 3.0  | 1.82 | 5.5  | 2.8  | 1.77 | 4.4  | 2.4  | 1.34 |     |      |
| 29                       | 16                            |                          |                               | 5.9                              | 5.2 | 1.54 | 5.5  | 5.2  | 1.64 | 5.2  | 5.0  | 1.73 | 4.8  | 4.8  | 1.72 | 3.9  | 3.9  | 1.32 |     |      |
|                          | 19                            |                          |                               | 6.3                              | 4.6 | 1.58 | 6.0  | 4.4  | 1.67 | 5.6  | 4.2  | 1.77 | 5.2  | 4.0  | 1.73 | 4.1  | 3.5  | 1.33 |     |      |
|                          | 22                            |                          |                               | 6.8                              | 3.8 | 1.63 | 6.4  | 3.6  | 1.72 | 6.1  | 3.5  | 1.82 | 5.5  | 3.2  | 1.77 | 4.4  | 2.8  | 1.34 |     |      |
| 32                       | 16                            |                          |                               | 5.9                              | 5.8 | 1.54 | 5.5  | 5.5  | 1.64 | 5.2  | 5.2  | 1.73 | 4.8  | 4.8  | 1.72 | 3.9  | 3.9  | 1.32 |     |      |
|                          | 19                            |                          |                               | 6.3                              | 5.2 | 1.58 | 6.0  | 5.1  | 1.67 | 5.6  | 4.9  | 1.77 | 5.2  | 4.7  | 1.73 | 4.1  | 4.1  | 1.33 |     |      |
|                          | 22                            |                          |                               | 6.8                              | 4.4 | 1.63 | 6.4  | 4.2  | 1.72 | 6.1  | 4.1  | 1.82 | 5.5  | 3.9  | 1.77 | 4.4  | 3.4  | 1.34 |     |      |

1-13. Capacity Table

1. Cooling Capacity Performance Data

TC :Cooling Capacity

SHC :Sensible Heat Capacity

IPT :Cooling Power Consumption

• Combination of Multiple Unit

4-Way Cassette 60x60 Type

unit : kW

| Model   | Power Source  | Ambient Return Air                            |   | Outdoor air intake temp(°C D.B.) |      |      |      |      |      |      |      |      |      |      |      |      |      |      |     |      |
|---|---|---|---|----------------------------------|------|------|------|------|------|------|------|------|------|------|------|------|------|------|-----|------|
|   |   |   |   | 25°C                             |      |      | 30°C |      |      | 35°C |      |      | 40°C |      |      | 46°C |      |      |     |      |
|   |   | DB  | WB  | TC                               | SHC  | IPT  | TC   | SHC  | IPT  | TC   | SHC  | IPT  | TC   | SHC  | IPT  | TC   | SHC  | IPT  |     |      |
| S-36PY2E5A x2<br>U-71PE1E5A<br>(U-71PE1E8A)   | 220V-230V-240V<br>50Hz 1phase<br>(380V-400V-415V<br>50Hz 3 phase) | 23  | 16  | 8.1                              | 5.9  | 2.25 | 7.9  | 5.8  | 2.41 | 7.6  | 5.7  | 2.59 | 7.2  | 5.4  | 2.57 | 6.3  | 5.0  | 2.20 |     |      |
|   |   |   | 19  | 8.5                              | 4.4  | 2.33 | 8.3  | 4.3  | 2.49 | 8.0  | 4.3  | 2.65 | 7.5  | 4.0  | 2.60 | 6.6  | 3.6  | 2.23 |     |      |
|   |   |   | 22  | 9.0                              | 3.2  | 2.44 | 8.7  | 2.9  | 2.58 | 8.3  | 2.8  | 2.73 | 7.8  | 2.7  | 2.62 | 6.8  | 2.3  | 2.25 |     |      |
|   |   | 25  | 16  | 8.1                              | 6.6  | 2.25 | 7.9  | 6.5  | 2.41 | 7.6  | 6.4  | 2.59 | 7.2  | 6.2  | 2.57 | 6.3  | 5.7  | 2.20 |     |      |
|   |   |   | 19  | 8.5                              | 5.2  | 2.33 | 8.3  | 5.1  | 2.49 | 8.0  | 5.0  | 2.65 | 7.5  | 4.8  | 2.60 | 6.6  | 4.4  | 2.23 |     |      |
|   |   |   | 22  | 9.0                              | 3.8  | 2.44 | 8.7  | 3.7  | 2.58 | 8.3  | 3.6  | 2.73 | 7.8  | 3.4  | 2.62 | 6.8  | 3.1  | 2.25 |     |      |
|   |   | 27  | 16  | 8.1                              | 7.4  | 2.25 | 7.9  | 7.3  | 2.41 | 7.6  | 7.1  | 2.59 | 7.2  | 7.0  | 2.57 | 6.3  | 6.3  | 2.20 |     |      |
|   |   |   | 19  | 8.5                              | 6.0  | 2.33 | 8.3  | 5.9  | 2.49 | 8.0  | 5.7  | 2.65 | 7.5  | 5.6  | 2.60 | 6.6  | 5.2  | 2.23 |     |      |
|   |   |   | 22  | 9.0                              | 4.6  | 2.44 | 8.7  | 4.5  | 2.58 | 8.3  | 4.4  | 2.73 | 7.8  | 4.2  | 2.62 | 6.8  | 3.9  | 2.25 |     |      |
|   |   | 29  | 16  | 8.1                              | 8.1  | 2.25 | 7.9  | 7.9  | 2.41 | 7.6  | 7.6  | 2.59 | 7.2  | 7.2  | 2.57 | 6.3  | 6.3  | 2.20 |     |      |
|   |   |   | 19  | 8.5                              | 6.8  | 2.33 | 8.3  | 6.7  | 2.49 | 8.0  | 6.5  | 2.65 | 7.5  | 6.3  | 2.60 | 6.6  | 6.0  | 2.23 |     |      |
|   |   |   | 22  | 9.0                              | 5.4  | 2.44 | 8.7  | 5.3  | 2.58 | 8.3  | 5.2  | 2.73 | 7.8  | 5.0  | 2.62 | 6.8  | 4.5  | 2.25 |     |      |
|   |   | 32  | 16  | 8.1                              | 8.1  | 2.25 | 7.9  | 7.9  | 2.41 | 7.6  | 7.6  | 2.59 | 7.2  | 7.2  | 2.57 | 6.3  | 6.3  | 2.20 |     |      |
|   |   |   | 19  | 8.5                              | 6.8  | 2.33 | 8.3  | 6.7  | 2.49 | 8.0  | 6.5  | 2.65 | 7.5  | 6.3  | 2.60 | 6.6  | 6.0  | 2.23 |     |      |
|   |   |   | 22  | 9.0                              | 5.4  | 2.44 | 8.7  | 5.3  | 2.58 | 8.3  | 5.2  | 2.73 | 7.8  | 5.0  | 2.62 | 6.8  | 4.5  | 2.25 |     |      |
|   |   | S-36PY2E5A x3<br>U-100PE1E5A<br>(U-100PE1E8A) | 220V-230V-240V<br>50Hz 1phase<br>(380V-400V-415V<br>50Hz 3 phase) | 23                               | 16   | 11.4 | 8.5  | 3.00 | 11.4 | 8.5  | 3.23 | 10.9 | 8.2  | 3.43 | 10.2 | 8.1  | 3.57 | 7.4  | 6.7 | 2.92 |
|   |   |   |   |                                  | 19   | 12.1 | 6.5  | 3.13 | 12.1 | 6.5  | 3.36 | 11.7 | 6.3  | 3.58 | 10.9 | 6.1  | 3.72 | 7.9  | 4.8 | 3.04 |
|   |   |   |   |                                  | 22   | 13.3 | 4.6  | 3.24 | 13.3 | 4.6  | 3.48 | 12.8 | 4.4  | 3.70 | 11.9 | 4.0  | 3.85 | 8.7  | 3.0 | 3.15 |
| 25  | 16  |   |   | 11.8                             | 10.0 | 3.05 | 11.8 | 10.0 | 3.28 | 11.3 | 9.8  | 3.49 | 10.5 | 9.5  | 3.63 | 7.7  | 7.7  | 2.97 |     |      |
|   | 19  |   |   | 12.6                             | 8.0  | 3.18 | 12.6 | 8.0  | 3.42 | 12.1 | 7.7  | 3.64 | 11.2 | 7.5  | 3.79 | 8.2  | 6.2  | 3.09 |     |      |
|   | 22  |   |   | 13.8                             | 6.1  | 3.29 | 13.8 | 6.1  | 3.54 | 13.2 | 5.8  | 3.77 | 12.3 | 5.4  | 3.92 | 9.0  | 4.3  | 3.20 |     |      |
| 27  | 16  |   |   | 12.2                             | 11.7 | 3.10 | 12.2 | 11.7 | 3.33 | 11.7 | 11.3 | 3.55 | 10.9 | 10.9 | 3.69 | 8.0  | 8.0  | 3.02 |     |      |
|   | 19  |   |   | 13.0                             | 9.6  | 3.24 | 13.0 | 9.6  | 3.48 | 12.5 | 9.3  | 3.70 | 11.6 | 9.0  | 3.85 | 8.5  | 7.6  | 3.15 |     |      |
|   | 22  |   |   | 14.2                             | 7.6  | 3.35 | 14.2 | 7.6  | 3.60 | 13.7 | 7.3  | 3.83 | 12.7 | 7.0  | 3.98 | 9.3  | 5.7  | 3.25 |     |      |
| 29  | 16  |   |   | 12.4                             | 12.4 | 3.11 | 12.4 | 12.4 | 3.34 | 11.9 | 11.9 | 3.56 | 11.0 | 11.0 | 3.70 | 8.1  | 8.1  | 3.02 |     |      |
|   | 19  |   |   | 13.2                             | 11.0 | 3.25 | 13.2 | 11.0 | 3.49 | 12.7 | 10.7 | 3.71 | 11.8 | 10.5 | 3.86 | 8.6  | 8.6  | 3.15 |     |      |
|   | 22  |   |   | 14.5                             | 9.1  | 3.36 | 14.5 | 9.1  | 3.61 | 13.9 | 8.7  | 3.84 | 12.9 | 8.4  | 3.99 | 9.5  | 7.2  | 3.26 |     |      |
| 32  | 16  |   |   | 12.5                             | 12.5 | 3.12 | 12.5 | 12.5 | 3.35 | 12.1 | 12.1 | 3.56 | 11.2 | 11.2 | 3.71 | 8.2  | 8.2  | 3.03 |     |      |
|   | 19  |   |   | 13.4                             | 11.2 | 3.25 | 13.4 | 11.2 | 3.50 | 12.9 | 10.8 | 3.72 | 12.0 | 10.7 | 3.87 | 8.8  | 8.8  | 3.16 |     |      |
|   | 22  |   |   | 14.7                             | 9.2  | 3.37 | 14.7 | 9.2  | 3.62 | 14.1 | 8.9  | 3.85 | 13.1 | 8.5  | 4.00 | 9.6  | 7.2  | 3.27 |     |      |
| S-50PY2E5A x2<br>U-100PE1E5A<br>(U-100PE1E8A) | 220V-230V-240V<br>50Hz 1phase<br>(380V-400V-415V<br>50Hz 3 phase) |   |   | 23                               | 16   | 11.4 | 8.3  | 3.00 | 11.4 | 8.3  | 3.23 | 10.9 | 7.9  | 3.43 | 10.2 | 7.8  | 3.57 | 7.4  | 6.5 | 2.92 |
|   |   |   |   |                                  | 19   | 12.1 | 6.4  | 3.13 | 12.1 | 6.4  | 3.36 | 11.7 | 6.2  | 3.58 | 10.9 | 5.9  | 3.72 | 7.9  | 4.6 | 3.04 |
|   |   |   |   |                                  | 22   | 13.3 | 4.6  | 3.24 | 13.3 | 4.6  | 3.48 | 12.8 | 4.4  | 3.70 | 11.9 | 4.0  | 3.85 | 8.7  | 3.0 | 3.15 |
|   |   | 25  | 16  | 11.8                             | 9.8  | 3.05 | 11.8 | 9.8  | 3.28 | 11.3 | 9.4  | 3.49 | 10.5 | 9.2  | 3.63 | 7.7  | 7.7  | 2.97 |     |      |
|   |   |   | 19  | 12.6                             | 7.8  | 3.18 | 12.6 | 7.8  | 3.42 | 12.1 | 7.5  | 3.64 | 11.2 | 7.2  | 3.79 | 8.2  | 5.9  | 3.09 |     |      |
|   |   |   | 22  | 13.8                             | 5.9  | 3.29 | 13.8 | 5.9  | 3.54 | 13.2 | 5.7  | 3.77 | 12.3 | 5.4  | 3.92 | 9.0  | 4.2  | 3.20 |     |      |
|   |   | 27  | 16  | 12.2                             | 11.2 | 3.10 | 12.2 | 11.3 | 3.33 | 11.7 | 10.8 | 3.55 | 10.9 | 10.8 | 3.69 | 8.0  | 8.0  | 3.02 |     |      |
|   |   |   | 19  | 13.0                             | 9.3  | 3.24 | 13.0 | 9.3  | 3.48 | 12.5 | 9.0  | 3.70 | 11.6 | 8.8  | 3.85 | 8.5  | 7.4  | 3.15 |     |      |
|   |   |   | 22  | 14.2                             | 7.4  | 3.35 | 14.2 | 7.4  | 3.60 | 13.7 | 7.2  | 3.83 | 12.7 | 6.8  | 3.98 | 9.3  | 5.5  | 3.25 |     |      |
|   |   | 29  | 16  | 12.4                             | 12.4 | 3.11 | 12.4 | 12.4 | 3.34 | 11.9 | 11.9 | 3.56 | 11.0 | 11.0 | 3.70 | 8.1  | 8.1  | 3.02 |     |      |
|   |   |   | 19  | 13.2                             | 10.6 | 3.25 | 13.2 | 10.6 | 3.49 | 12.7 | 10.3 | 3.71 | 11.8 | 10.1 | 3.86 | 8.6  | 8.6  | 3.15 |     |      |
|   |   |   | 22  | 14.5                             | 8.8  | 3.36 | 14.5 | 8.8  | 3.61 | 13.9 | 8.5  | 3.84 | 12.9 | 8.1  | 3.99 | 9.5  | 6.9  | 3.26 |     |      |
|   |   | 32  | 16  | 12.5                             | 12.5 | 3.12 | 12.5 | 12.5 | 3.35 | 12.1 | 12.1 | 3.56 | 11.2 | 11.2 | 3.71 | 8.2  | 8.2  | 3.03 |     |      |
|   |   |   | 19  | 13.4                             | 10.8 | 3.25 | 13.4 | 10.8 | 3.50 | 12.9 | 10.4 | 3.72 | 12.0 | 10.3 | 3.87 | 8.8  | 8.8  | 3.16 |     |      |
|   |   |   | 22  | 14.7                             | 8.9  | 3.37 | 14.7 | 8.9  | 3.62 | 14.1 | 8.6  | 3.85 | 13.1 | 8.3  | 4.00 | 9.6  | 7.0  | 3.27 |     |      |
|   |   | S-36PY2E5A x4<br>U-125PE1E5A<br>(U-125PE1E8A) | 220V-230V-240V<br>50Hz 1phase<br>(380V-400V-415V<br>50Hz 3 phase) | 23                               | 16   | 12.7 | 9.7  | 3.73 | 12.7 | 9.7  | 4.01 | 12.2 | 9.4  | 4.27 | 11.4 | 9.2  | 4.44 | 8.3  | 7.8 | 3.63 |
|   |   |   |   |                                  | 19   | 13.6 | 7.3  | 3.89 | 13.6 | 7.4  | 4.18 | 13.1 | 7.1  | 4.45 | 12.2 | 6.8  | 4.63 | 8.9  | 5.4 | 3.78 |
|   |   |   |   |                                  | 22   | 14.9 | 5.1  | 4.03 | 14.9 | 5.0  | 4.33 | 14.3 | 4.9  | 4.60 | 13.3 | 4.5  | 4.79 | 9.7  | 3.3 | 3.91 |
| 25  | 16  |   |   | 13.2                             | 11.6 | 3.80 | 13.2 | 11.6 | 4.08 | 12.7 | 11.2 | 4.34 | 11.8 | 11.0 | 4.51 | 8.6  | 8.6  | 3.69 |     |      |
|   | 19  |   |   | 14.1                             | 9.1  | 3.96 | 14.1 | 9.2  | 4.25 | 13.5 | 8.9  | 4.52 | 12.6 | 8.6  | 4.71 | 9.2  | 7.1  | 3.85 |     |      |
|   | 22  |   |   | 15.4                             | 6.8  | 4.10 | 15.4 | 6.8  | 4.40 | 14.8 | 6.6  | 4.68 | 13.8 | 6.3  | 4.87 | 10.1 | 4.9  | 3.98 |     |      |
| 27  | 16  |   |   | 13.6                             | 13.4 | 3.86 | 13.6 | 13.5 | 4.15 | 13.1 | 13.1 | 4.41 | 12.2 | 12.2 | 4.59 | 8.9  | 8.9  | 3.75 |     |      |
|   | 19  |   |   | 14.6                             | 11.1 | 4.03 | 14.6 | 11.0 | 4.32 | 14.0 | 10.6 | 4.60 | 13.0 | 10.4 | 4.78 | 9.5  | 8.9  | 3.91 |     |      |
|   | 22  |   |   | 16.0                             | 8.7  | 4.16 | 16.0 | 8.7  | 4.47 | 15.3 | 8.3  | 4.76 | 14.3 | 8.1  | 4.95 | 10.4 | 6.6  | 4.05 |     |      |
| 29  | 16  |   |   | 13.8                             | 13.8 | 3.87 | 13.8 | 13.8 | 4.16 | 13.3 | 13.3 | 4.42 | 12.4 | 12.4 | 4.60 | 9.0  | 9.0  | 3.76 |     |      |
|   | 19  |   |   | 14.8                             | 12.7 | 4.03 | 14.8 | 12.8 | 4.33 | 14.2 | 12.4 | 4.61 | 13.2 | 12.1 | 4.80 | 9.7  | 9.7  | 3.92 |     |      |
|   | 22  |   |   | 16.2                             | 10.4 | 4.17 | 16.2 | 10.4 | 4.48 | 15.6 | 10.1 | 4.77 | 14.5 | 9.9  | 4.96 | 10.6 | 8.3  | 4.06 |     |      |
| 32  | 16  |   |   | 14.0                             | 14.0 | 3.88 | 14.0 | 14.0 | 4.17 | 13.5 | 13.5 | 4.43 | 12.6 | 12.6 | 4.61 | 9.2  | 9.2  | 3.77 |     |      |
|   | 19  |   |   | 15.0                             | 12.9 | 4.04 | 15.0 | 13.0 | 4.35 | 14.4 | 12.6 | 4.62 | 13.4 | 12.3 | 4.81 | 9.8  | 9.8  | 3.93 |     |      |
|   | 22  |   |   | 16.4                             | 10.5 | 4.18 | 16.4 | 10.5 | 4.50 | 15.8 | 10.3 | 4.78 | 14.7 | 10.0 | 4.97 | 10.7 | 8.3  | 4.07 |     |      |
| S-45PY2E5A x3<br>U-125PE1E5A<br>(U-125PE1E8A) | 220V-230V-240V<br>50Hz 1phase<br>(380V-400V-415V<br>50Hz 3 phase) |   |   | 23                               | 16   | 12.7 | 9.3  | 3.73 | 12.7 | 9.3  | 4.01 | 12.2 | 8.9  | 4.27 | 11.4 | 8.8  | 4.44 | 8.3  | 7.3 | 3.63 |
|   |   |   |   |                                  | 19   | 13.6 | 7.1  | 3.89 | 13.6 | 7.2  | 4.18 | 13.1 | 6.9  | 4.45 | 12.2 | 6.6  | 4.63 | 8.9  | 5.2 | 3.78 |
|   |   |   |   |                                  | 22   | 14.9 | 5.1  | 4.03 | 14.9 | 5.2  | 4.33 | 14.3 | 4.9  | 4.60 | 13.3 | 4.6  | 4.79 | 9.7  | 3.3 | 3.91 |
|   |   | 25  | 16  | 13.2                             | 10.9 | 3.80 | 13.2 | 10.9 | 4.08 | 12.7 | 10.6 | 4.34 | 11.8 | 10.4 | 4.51 | 8.6  | 8.6  | 3.69 |     |      |
|   |   |   | 19  | 14.1                             | 8.8  | 3.96 | 14.1 | 8.8  | 4.25 | 13.5 | 8.4  | 4.52 | 12.6 | 8.1  | 4.71 | 9.2  | 6.7  | 3.85 |     |      |
|   |   |   | 22  | 15.4                             | 6.7  | 4.10 | 15.4 | 6.7  | 4.40 | 14.8 | 6.4  | 4.68 | 13.8 | 6.0  | 4.87 | 10.1 | 4.8  | 3.98 |     |      |
|   |   | 27  | 16  | 13.6                             | 12.6 | 3.86 | 13.6 | 12.7 | 4.15 | 13.1 | 12.3 | 4.41 | 12.2 | 12.1 | 4.59 | 8.9  | 8.9  | 3.75 |     |      |
|   |   |   | 19  | 14.6                             | 10.4 | 4.03 | 14.6 | 10.5 | 4.32 | 14.0 | 10.1 | 4.60 | 13.0 | 9.8  | 4.78 | 9.5  | 8.3  | 3.91 |     |      |
|   |   |   | 22  | 16.0                             | 8.4  | 4.16 | 16.0 | 8.3  | 4.47 | 15.3 | 8.1  | 4.76 | 14.3 | 7.7  | 4.95 | 10.4 | 6.2  | 4.05 |     |      |
|   |   | 29  | 16  | 13.8                             | 13.8 | 3.87 | 13.8 | 13.8 | 4.16 | 13.3 | 13.3 | 4.42 | 12.4 | 12.4 | 4.60 | 9.0  | 9.0  | 3.76 |     |      |
|   |   |   | 19  | 14.8                             | 12.0 | 4.03 | 14.8 | 12.0 | 4.33 | 14.2 | 11.6 | 4.61 | 13.2 | 11.3 | 4.80 | 9.7  | 9.7  | 3.92 |     |      |
|   |   |   | 22  | 16.2                             | 9.9  | 4.17 | 16.2 | 9.9  | 4.48 | 15.6 | 9.6  | 4.77 | 14.5 | 9.3  | 4.96 | 10.6 | 7.7  | 4.06 |     |      |
|   |   | 32  | 16  | 14.0                             | 14.0 | 3.88 | 14.0 | 14.0 | 4.17 | 13.5 | 13.5 | 4.43 | 12.6 | 12.6 | 4.61 | 9.2  | 9.2  | 3.77 |     |      |
|   |   |   | 19  | 15.0                             | 12.2 | 4.04 | 15.0 | 12.2 | 4.35 | 14.4 | 11.8 | 4.62 | 13.4 | 11.5 | 4.81 | 9.8  | 9.8  | 3.93 |     |      |
|   |   |   | 22  | 16.4                             | 10.0 | 4.18 | 16.4 | 10.0 | 4.50 | 15.8 | 9.8  | 4.78 | 14.7 | 9.4  | 4.97 | 10.7 | 7.8  |      |     |      |

**1-13. Capacity Table**

**1. Cooling Capacity Performance Data**

TC :Cooling Capacity

SHC :Sensible Heat Capacity

IPT :Cooling Power Consumption

**• Combination of Multiple Unit**

4-Way Cassette 60×60 Type

unit : kW

| Model  | Power Source  | Ambient Return Air |    | Outdoor air intake temp(°C D.B.) |      |      |      |      |      |      |      |      |      |      |      |      |      |      |
|--|---|--------------------|----|----------------------------------|------|------|------|------|------|------|------|------|------|------|------|------|------|------|
|  |   |                    |    | 25°C                             |      |      | 30°C |      |      | 35°C |      |      | 40°C |      |      | 46°C |      |      |
|  |   | DB                 | WB | TC                               | SHC  | IPT  | TC   | SHC  | IPT  | TC   | SHC  | IPT  | TC   | SHC  | IPT  | TC   | SHC  | IPT  |
| S-50PY2E5A×3<br>U-140PE1E5A<br>(U-140PE1E8A) | 220V-230V-240V<br>50Hz 1phase<br>(380V-400V-415V<br>50Hz 3 phase) | 23                 | 16 | 14.1                             | 10.4 | 4.87 | 14.1 | 10.5 | 5.23 | 13.6 | 10.3 | 5.56 | 12.6 | 9.8  | 5.79 | 9.2  | 8.3  | 4.73 |
|  |   |                    | 19 | 15.1                             | 8.0  | 5.08 | 15.1 | 8.1  | 5.46 | 14.5 | 7.8  | 5.80 | 13.5 | 7.4  | 6.04 | 9.8  | 5.9  | 4.93 |
|  |   |                    | 22 | 16.5                             | 5.6  | 5.25 | 16.5 | 5.6  | 5.64 | 15.9 | 5.4  | 6.00 | 14.8 | 5.0  | 6.25 | 10.8 | 3.7  | 5.10 |
|  |   | 25                 | 16 | 14.6                             | 12.4 | 4.95 | 14.6 | 12.4 | 5.32 | 14.0 | 12.0 | 5.66 | 13.1 | 11.8 | 5.88 | 9.5  | 9.5  | 4.81 |
|  |   |                    | 19 | 15.6                             | 9.8  | 5.16 | 15.6 | 9.9  | 5.55 | 15.0 | 9.5  | 5.90 | 13.9 | 9.2  | 6.14 | 10.2 | 7.6  | 5.02 |
|  |   |                    | 22 | 17.1                             | 7.4  | 5.34 | 17.1 | 7.5  | 5.74 | 16.4 | 7.1  | 6.11 | 15.3 | 6.8  | 6.35 | 11.2 | 5.3  | 5.19 |
|  |   | 27                 | 16 | 15.1                             | 14.3 | 5.03 | 15.1 | 14.4 | 5.41 | 14.5 | 14.0 | 5.75 | 13.5 | 13.5 | 5.98 | 9.9  | 9.9  | 4.89 |
|  |   |                    | 19 | 16.1                             | 11.8 | 5.25 | 16.1 | 11.8 | 5.64 | 15.5 | 11.4 | 6.00 | 14.4 | 11.2 | 6.24 | 10.5 | 9.4  | 5.10 |
|  |   |                    | 22 | 17.7                             | 9.3  | 5.43 | 17.7 | 9.4  | 5.83 | 17.0 | 9.0  | 6.21 | 15.8 | 8.7  | 6.46 | 11.5 | 7.0  | 5.28 |
|  |   | 29                 | 16 | 15.3                             | 15.3 | 5.05 | 15.3 | 15.3 | 5.42 | 14.7 | 14.7 | 5.77 | 13.7 | 13.7 | 6.00 | 10.0 | 10.0 | 4.90 |
|  |   |                    | 19 | 16.4                             | 13.6 | 5.26 | 16.4 | 13.6 | 5.65 | 15.7 | 13.2 | 6.01 | 14.6 | 13.0 | 6.26 | 10.7 | 10.7 | 5.11 |
|  |   |                    | 22 | 17.9                             | 11.1 | 5.44 | 17.9 | 11.2 | 5.85 | 17.2 | 10.8 | 6.22 | 16.0 | 10.5 | 6.47 | 11.7 | 8.7  | 5.29 |
|  |   | 32                 | 16 | 15.5                             | 15.5 | 5.06 | 15.5 | 15.5 | 5.43 | 14.9 | 14.9 | 5.78 | 13.9 | 13.9 | 6.01 | 10.2 | 10.2 | 4.91 |
|  |   |                    | 19 | 16.6                             | 13.8 | 5.28 | 16.6 | 13.8 | 5.67 | 16.0 | 13.5 | 6.03 | 14.8 | 13.2 | 6.27 | 10.9 | 10.9 | 5.13 |
|  |   |                    | 22 | 18.2                             | 11.3 | 5.46 | 18.2 | 11.4 | 5.86 | 17.5 | 11.0 | 6.24 | 16.3 | 10.7 | 6.49 | 11.9 | 8.9  | 5.30 |

1-13. Capacity Table

1. Cooling Capacity Performance Data

• Combination of Single Unit

4-Way Cassette Type

TC :Cooling Capacity

SHC :Sensible Heat Capacity

IPT :Cooling Power Consumption

unit : kW

| Model                                       | Power Source  | Ambient Return Air                          |   | Outdoor air intake temp(°C D.B.) |      |      |      |      |      |      |      |      |      |      |      |      |      |      |     |      |
|---|---|---|---|----------------------------------|------|------|------|------|------|------|------|------|------|------|------|------|------|------|-----|------|
|   |   |   |   | 25°C                             |      |      | 30°C |      |      | 35°C |      |      | 40°C |      |      | 43°C |      |      |     |      |
|   |   | DB  | WB  | TC                               | SHC  | IPT  | TC   | SHC  | IPT  | TC   | SHC  | IPT  | TC   | SHC  | IPT  | TC   | SHC  | IPT  |     |      |
| S-60PU2E5A<br>U-60PEY2E5                    | 220V-230V-240V<br>50Hz 1phase                                     | 23  | 16  | 7.1                              | 5.6  | 1.81 | 6.8  | 5.4  | 1.98 | 6.5  | 5.3  | 2.14 | 6.1  | 5.1  | 2.08 | 5.0  | 4.6  | 1.38 |     |      |
|   |   |   | 19  | 7.8                              | 4.3  | 1.86 | 7.4  | 4.1  | 2.03 | 7.1  | 4.0  | 2.20 | 6.7  | 3.8  | 2.14 | 5.3  | 3.3  | 1.40 |     |      |
|   |   |   | 22  | 8.6                              | 3.0  | 1.90 | 8.2  | 2.8  | 2.07 | 7.8  | 2.7  | 2.25 | 7.3  | 2.5  | 2.18 | 5.7  | 2.0  | 1.42 |     |      |
|   |   | 25  | 16  | 7.1                              | 6.4  | 1.81 | 6.8  | 6.3  | 1.98 | 6.5  | 6.1  | 2.14 | 6.1  | 5.9  | 2.08 | 5.0  | 5.0  | 1.38 |     |      |
|   |   |   | 19  | 7.8                              | 5.1  | 1.86 | 7.4  | 4.9  | 2.03 | 7.1  | 4.8  | 2.20 | 6.7  | 4.6  | 2.14 | 5.3  | 4.1  | 1.40 |     |      |
|   |   |   | 22  | 8.6                              | 3.8  | 1.90 | 8.2  | 3.6  | 2.07 | 7.8  | 3.5  | 2.25 | 7.3  | 3.3  | 2.18 | 5.7  | 2.8  | 1.42 |     |      |
|   |   | 27  | 16  | 7.1                              | 7.1  | 1.81 | 6.8  | 6.8  | 1.98 | 6.5  | 6.5  | 2.14 | 6.1  | 6.1  | 2.08 | 5.0  | 5.0  | 1.38 |     |      |
|   |   |   | 19  | 7.8                              | 5.9  | 1.86 | 7.4  | 5.7  | 2.03 | 7.1  | 5.6  | 2.20 | 6.7  | 5.4  | 2.14 | 5.3  | 4.9  | 1.40 |     |      |
|   |   |   | 22  | 8.6                              | 4.6  | 1.90 | 8.2  | 4.4  | 2.07 | 7.8  | 4.3  | 2.25 | 7.3  | 4.1  | 2.18 | 5.7  | 3.6  | 1.42 |     |      |
|   |   | 29  | 16  | 7.1                              | 7.1  | 1.81 | 6.8  | 6.8  | 1.98 | 6.5  | 6.5  | 2.14 | 6.1  | 6.1  | 2.08 | 5.0  | 5.0  | 1.38 |     |      |
|   |   |   | 19  | 7.8                              | 6.7  | 1.86 | 7.4  | 6.5  | 2.03 | 7.1  | 6.4  | 2.20 | 6.7  | 6.2  | 2.14 | 5.3  | 5.3  | 1.40 |     |      |
|   |   |   | 22  | 8.6                              | 5.4  | 1.90 | 8.2  | 5.2  | 2.07 | 7.8  | 5.1  | 2.25 | 7.3  | 4.9  | 2.18 | 5.7  | 4.3  | 1.42 |     |      |
|   |   | 32  | 16  | 7.1                              | 7.1  | 1.81 | 6.8  | 6.8  | 1.98 | 6.5  | 6.5  | 2.14 | 6.1  | 6.1  | 2.08 | 5.0  | 5.0  | 1.38 |     |      |
|   |   |   | 19  | 7.8                              | 7.8  | 1.86 | 7.4  | 7.4  | 2.03 | 7.1  | 7.1  | 2.20 | 6.7  | 6.7  | 2.14 | 5.3  | 5.3  | 1.40 |     |      |
|   |   |   | 22  | 8.6                              | 6.6  | 1.90 | 8.2  | 6.4  | 2.07 | 7.8  | 6.3  | 2.25 | 7.3  | 6.1  | 2.18 | 5.7  | 5.5  | 1.42 |     |      |
|   |   | S-71PU2E5A<br>U-71PEY21E5                   | 220V-230V-240V<br>50Hz 1phase                                     | 23                               | 16   | 7.7  | 6.0  | 2.19 | 7.4  | 5.8  | 2.38 | 7.1  | 5.7  | 2.58 | 6.7  | 5.5  | 2.18 | 5.4  | 4.9 | 1.50 |
|   |   |   |   |                                  | 19   | 8.4  | 4.6  | 2.25 | 8.1  | 4.4  | 2.45 | 7.7  | 4.3  | 2.65 | 7.2  | 4.1  | 2.23 | 5.7  | 3.5 | 1.53 |
|   |   |   |   |                                  | 22   | 9.3  | 3.2  | 2.29 | 8.9  | 3.1  | 2.50 | 8.5  | 2.9  | 2.70 | 7.9  | 2.7  | 2.28 | 6.0  | 2.1 | 1.55 |
| 25  | 16  |   |   | 7.7                              | 6.8  | 2.19 | 7.4  | 6.7  | 2.38 | 7.1  | 6.5  | 2.58 | 6.7  | 6.4  | 2.18 | 5.4  | 5.4  | 1.50 |     |      |
|   | 19  |   |   | 8.4                              | 5.4  | 2.25 | 8.1  | 5.3  | 2.45 | 7.7  | 5.1  | 2.65 | 7.2  | 4.9  | 2.23 | 5.7  | 4.3  | 1.53 |     |      |
|   | 22  |   |   | 9.3                              | 4.1  | 2.29 | 8.9  | 3.9  | 2.50 | 8.5  | 3.8  | 2.70 | 7.9  | 3.6  | 2.28 | 6.0  | 2.9  | 1.55 |     |      |
| 27  | 16  |   |   | 7.7                              | 7.7  | 2.19 | 7.4  | 7.4  | 2.38 | 7.1  | 7.1  | 2.58 | 6.7  | 6.7  | 2.18 | 5.4  | 5.4  | 1.50 |     |      |
|   | 19  |   |   | 8.4                              | 6.3  | 2.25 | 8.1  | 6.1  | 2.45 | 7.7  | 6.0  | 2.65 | 7.2  | 5.8  | 2.23 | 5.7  | 5.2  | 1.53 |     |      |
|   | 22  |   |   | 9.3                              | 4.9  | 2.29 | 8.9  | 4.8  | 2.50 | 8.5  | 4.6  | 2.70 | 7.9  | 4.4  | 2.28 | 6.0  | 3.7  | 1.55 |     |      |
| 29  | 16  |   |   | 7.7                              | 7.7  | 2.19 | 7.4  | 7.4  | 2.38 | 7.1  | 7.1  | 2.58 | 6.7  | 6.7  | 2.18 | 5.4  | 5.4  | 1.50 |     |      |
|   | 19  |   |   | 8.4                              | 7.1  | 2.25 | 8.1  | 7.0  | 2.45 | 7.7  | 6.8  | 2.65 | 7.2  | 6.6  | 2.23 | 5.7  | 5.7  | 1.53 |     |      |
|   | 22  |   |   | 9.3                              | 5.8  | 2.29 | 8.9  | 5.6  | 2.50 | 8.5  | 5.5  | 2.70 | 7.9  | 5.2  | 2.28 | 6.0  | 4.6  | 1.55 |     |      |
| 32  | 16  |   |   | 7.7                              | 7.7  | 2.19 | 7.4  | 7.4  | 2.38 | 7.1  | 7.1  | 2.58 | 6.7  | 6.7  | 2.18 | 5.4  | 5.4  | 1.50 |     |      |
|   | 19  |   |   | 8.4                              | 8.4  | 2.25 | 8.1  | 8.1  | 2.45 | 7.7  | 7.7  | 2.65 | 7.2  | 7.2  | 2.23 | 5.7  | 5.7  | 1.53 |     |      |
|   | 22  |   |   | 9.3                              | 7.0  | 2.29 | 8.9  | 6.9  | 2.50 | 8.5  | 6.7  | 2.70 | 7.9  | 6.5  | 2.28 | 6.0  | 5.8  | 1.55 |     |      |
| S-100PU2E5A<br>U-100PEY1E5<br>(U-100PEY1E8) | 220V-230V-240V<br>50Hz 1phase<br>(380V-400V-415V<br>50Hz 3 phase) |   |   | 23                               | 16   | 11.1 | 9.0  | 3.37 | 10.6 | 8.8  | 3.63 | 10.1 | 8.6  | 3.90 | 8.5  | 7.9  | 3.70 | 4.4  | 4.4 | 1.39 |
|   |   |   |   |                                  | 19   | 11.9 | 6.7  | 3.52 | 11.3 | 6.5  | 3.79 | 10.7 | 6.2  | 4.06 | 9.1  | 5.6  | 3.86 | 4.7  | 4.0 | 1.45 |
|   |   |   |   |                                  | 22   | 13.0 | 4.4  | 3.64 | 12.4 | 4.2  | 3.92 | 11.8 | 4.0  | 4.20 | 10.0 | 3.4  | 3.99 | 5.2  | 1.9 | 1.50 |
|   |   | 25  | 16  | 11.5                             | 10.6 | 3.43 | 11.0 | 10.4 | 3.70 | 10.4 | 10.1 | 3.96 | 8.8  | 8.8  | 3.76 | 4.6  | 4.6  | 1.41 |     |      |
|   |   |   | 19  | 12.3                             | 8.2  | 3.58 | 11.7 | 8.0  | 3.85 | 11.1 | 7.8  | 4.13 | 9.4  | 7.1  | 3.93 | 4.9  | 4.9  | 1.47 |     |      |
|   |   |   | 22  | 13.5                             | 6.0  | 3.70 | 12.8 | 5.8  | 3.99 | 12.2 | 5.5  | 4.27 | 10.3 | 4.9  | 4.06 | 5.4  | 3.3  | 1.53 |     |      |
|   |   | 27  | 16  | 11.9                             | 11.9 | 3.49 | 11.3 | 11.3 | 3.76 | 10.8 | 10.8 | 4.03 | 9.1  | 9.1  | 3.83 | 4.8  | 4.8  | 1.44 |     |      |
|   |   |   | 19  | 12.7                             | 9.8  | 3.64 | 12.1 | 9.6  | 3.92 | 11.5 | 9.3  | 4.20 | 9.8  | 8.6  | 3.99 | 5.1  | 5.1  | 1.50 |     |      |
|   |   |   | 22  | 13.9                             | 7.5  | 3.76 | 13.3 | 7.3  | 4.05 | 12.6 | 7.0  | 4.35 | 10.7 | 6.4  | 4.13 | 5.6  | 4.7  | 1.55 |     |      |
|   |   | 29  | 16  | 12.1                             | 12.1 | 3.50 | 11.5 | 11.5 | 3.77 | 10.9 | 10.9 | 4.04 | 9.3  | 9.3  | 3.84 | 4.8  | 4.8  | 1.44 |     |      |
|   |   |   | 19  | 12.9                             | 11.3 | 3.65 | 12.3 | 11.0 | 3.93 | 11.7 | 10.8 | 4.21 | 9.9  | 9.9  | 4.00 | 5.2  | 5.2  | 1.50 |     |      |
|   |   |   | 22  | 14.1                             | 9.0  | 3.77 | 13.5 | 8.8  | 4.06 | 12.8 | 8.5  | 4.36 | 10.9 | 7.8  | 4.14 | 5.7  | 5.7  | 1.56 |     |      |
|   |   | 32  | 16  | 12.3                             | 12.3 | 3.50 | 11.7 | 11.7 | 3.78 | 11.1 | 11.1 | 4.05 | 9.4  | 9.4  | 3.84 | 4.9  | 4.9  | 1.44 |     |      |
|   |   |   | 19  | 13.1                             | 13.1 | 3.65 | 12.5 | 12.5 | 3.94 | 11.8 | 11.8 | 4.22 | 10.1 | 10.1 | 4.01 | 5.2  | 5.2  | 1.51 |     |      |
|   |   |   | 22  | 14.3                             | 11.1 | 3.78 | 13.7 | 10.9 | 4.07 | 13.0 | 10.6 | 4.37 | 11.0 | 9.9  | 4.15 | 5.7  | 5.7  | 1.56 |     |      |
|   |   | S-125PU2E5A<br>U-125PEY1E5<br>(U-125PEY1E8) | 220V-230V-240V<br>50Hz 1phase<br>(380V-400V-415V<br>50Hz 3 phase) | 23                               | 16   | 12.5 | 9.8  | 3.92 | 12.2 | 9.7  | 4.22 | 11.8 | 9.5  | 4.53 | 9.5  | 8.5  | 4.30 | 5.2  | 5.2 | 1.62 |
|   |   |   |   |                                  | 19   | 13.4 | 7.4  | 4.09 | 13.0 | 7.2  | 4.40 | 12.6 | 7.0  | 4.72 | 10.2 | 6.1  | 4.49 | 5.6  | 4.3 | 1.69 |
|   |   |   |   |                                  | 22   | 14.7 | 5.1  | 4.23 | 14.3 | 4.9  | 4.56 | 13.8 | 4.7  | 4.88 | 11.1 | 3.8  | 4.64 | 6.1  | 2.2 | 1.74 |
| 25  | 16  |   |   | 13.0                             | 11.5 | 3.98 | 12.6 | 11.3 | 4.29 | 12.2 | 11.1 | 4.60 | 9.9  | 9.9  | 4.37 | 5.4  | 5.4  | 1.64 |     |      |
|   | 19  |   |   | 13.8                             | 9.0  | 4.16 | 13.5 | 8.8  | 4.48 | 13.1 | 8.7  | 4.80 | 10.5 | 7.6  | 4.56 | 5.8  | 5.8  | 1.71 |     |      |
|   | 22  |   |   | 15.2                             | 6.7  | 4.30 | 14.8 | 6.6  | 4.63 | 14.3 | 6.3  | 4.97 | 11.5 | 5.3  | 4.72 | 6.3  | 3.7  | 1.77 |     |      |
| 27  | 16  |   |   | 13.4                             | 13.1 | 4.05 | 13.0 | 12.9 | 4.36 | 12.6 | 12.6 | 4.68 | 10.2 | 10.2 | 4.45 | 5.6  | 5.6  | 1.67 |     |      |
|   | 19  |   |   | 14.3                             | 10.6 | 4.23 | 13.9 | 10.4 | 4.55 | 13.5 | 10.3 | 4.88 | 10.9 | 9.2  | 4.64 | 6.0  | 6.0  | 1.74 |     |      |
|   | 22  |   |   | 15.7                             | 8.3  | 4.37 | 15.3 | 8.1  | 4.71 | 14.8 | 8.0  | 5.05 | 11.9 | 6.9  | 4.80 | 6.5  | 5.1  | 1.80 |     |      |
| 29  | 16  |   |   | 13.6                             | 13.6 | 4.06 | 13.2 | 13.2 | 4.38 | 12.8 | 12.8 | 4.69 | 10.3 | 10.3 | 4.46 | 5.7  | 5.7  | 1.67 |     |      |
|   | 19  |   |   | 14.5                             | 12.1 | 4.24 | 14.1 | 11.9 | 4.56 | 13.7 | 11.8 | 4.89 | 11.1 | 10.7 | 4.65 | 6.1  | 6.1  | 1.75 |     |      |
|   | 22  |   |   | 15.9                             | 9.8  | 4.38 | 15.5 | 9.7  | 4.72 | 15.0 | 9.5  | 5.06 | 12.1 | 8.4  | 4.81 | 6.6  | 6.5  | 1.81 |     |      |
| 32  | 16  |   |   | 13.8                             | 13.8 | 4.07 | 13.4 | 13.4 | 4.39 | 13.0 | 13.0 | 4.70 | 10.5 | 10.5 | 4.47 | 5.8  | 5.8  | 1.68 |     |      |
|   | 19  |   |   | 14.7                             | 14.4 | 4.25 | 14.3 | 14.2 | 4.58 | 13.9 | 13.9 | 4.90 | 11.2 | 11.2 | 4.66 | 6.1  | 6.1  | 1.75 |     |      |
|   | 22  |   |   | 16.2                             | 12.0 | 4.39 | 15.7 | 11.9 | 4.73 | 15.2 | 11.7 | 5.07 | 12.3 | 10.5 | 4.82 | 6.7  | 6.7  | 1.81 |     |      |
| S-140PU2E5A<br>U-140PEY1E8                  | 220V-230V-240V<br>50Hz 1phase<br>(380V-400V-415V<br>50Hz 3 phase) |   |   | 23                               | 16   | 14.1 | 10.7 | 4.71 | 14.1 | 10.7 | 5.06 | 13.6 | 10.4 | 5.39 | 12.6 | 10.0 | 5.60 | 9.2  | 8.4 | 4.58 |
|   |   |   |   |                                  | 19   | 15.1 | 8.1  | 4.92 | 15.1 | 8.1  | 5.28 | 14.5 | 7.9  | 5.62 | 13.5 | 7.5  | 5.85 | 9.8  | 6.0 | 4.78 |
|   |   |   |   |                                  | 22   | 16.5 | 5.7  | 5.09 | 16.5 | 5.7  | 5.47 | 15.9 | 5.5  | 5.81 | 14.8 | 5.1  | 6.05 | 10.8 | 3.7 | 4.94 |
|   |   | 25  | 16  | 14.6                             | 12.4 | 4.79 | 14.6 | 12.4 | 5.15 | 14.0 | 12.1 | 5.48 | 13.1 | 11.7 | 5.70 | 9.5  | 9.5  | 4.66 |     |      |
|   |   |   | 19  | 15.6                             | 9.8  | 5.00 | 15.6 | 9.8  | 5.37 | 15.0 | 9.6  | 5.72 | 13.9 | 9.1  | 5.94 | 10.2 | 7.6  | 4.86 |     |      |
|   |   |   | 22  | 17.1                             | 7.4  | 5.17 | 17.1 | 7.4  | 5.56 | 16.4 | 7.2  | 5.91 | 15.3 | 6.8  | 6.15 | 11.2 | 5.3  | 5.03 |     |      |
|   |   | 27  | 16  | 15.1                             | 14.1 | 4.87 | 15.1 | 14.1 | 5.24 | 14.5 | 13.8 | 5.57 | 13.5 | 13.4 | 5.79 | 9.9  | 9.9  | 4.73 |     |      |
|   |   |   | 19  | 16.1                             | 11.5 | 5.08 | 16.1 | 11.5 | 5.46 | 15.5 | 11.2 | 5.81 | 14.4 | 10.8 | 6.04 | 10.5 | 9.2  | 4.94 |     |      |
|   |   |   | 22  | 17.7                             | 9.1  | 5.26 | 17.7 | 9.1  | 5.65 | 17.0 | 8.8  | 6.01 | 15.8 | 8.4  | 6.25 | 11.5 | 6.8  | 5.11 |     |      |
|   |   | 29  | 16  | 15.3                             | 15.3 | 4.89 | 15.3 | 15.3 | 5.25 | 14.7 | 14.7 | 5.58 | 13.7 | 13.7 | 5.81 | 10.0 | 10.0 | 4.75 |     |      |
|   |   |   | 19  | 16.4                             | 13.2 | 5.10 | 16.4 | 13.2 | 5.47 | 15.7 | 12.8 | 5.82 | 14.6 | 12.3 | 6.06 | 10.7 | 10.7 | 4.95 |     |      |
|   |   |   | 22  | 17.9                             | 10.7 | 5.27 | 17.9 | 10.7 | 5.66 | 17.2 | 10.4 | 6.03 | 16.0 | 9.9  | 6.27 | 11.7 | 8.3  | 5.12 |     |      |
|   |   | 32  | 16  | 15.5                             | 15.5 | 4.90 | 15.5 | 15.5 | 5.26 | 14.9 | 14.9 | 5.60 | 13.9 | 13.9 | 5.82 | 10.2 | 10.2 | 4.76 |     |      |
|   |   |   | 19  | 16.6                             | 15.5 | 5.11 | 16.6 | 15.5 | 5.49 | 16.0 | 15.2 | 5.84 | 14.8 | 14.6 | 6.07 | 10.9 | 10.9 | 4.96 |     |      |
|   |   |   | 22  | 18.2                             | 13.0 | 5.29 | 18.2 | 13.0 | 5.68 | 17.5 | 12.7 | 6.04 | 16.3 | 12.3 | 6.28 | 11.9 | 10.6 | 5.13 |     |      |

1-13. Capacity Table

1. Cooling Capacity Performance Data

TC :Cooling Capacity

SHC :Sensible Heat Capacity

IPT :Cooling Power Consumption

• Combination of Multiple Unit

unit : kW

4-Way Cassette Type

| Model  | Power Source  | Ambient Return Air                           |   | Outdoor air intake temp(°C D.B.) |      |      |      |      |      |      |      |      |      |      |      |      |      |      |     |      |
|--|---|--|---|----------------------------------|------|------|------|------|------|------|------|------|------|------|------|------|------|------|-----|------|
|  |   |  |   | 25°C                             |      |      | 30°C |      |      | 35°C |      |      | 40°C |      |      | 43°C |      |      |     |      |
|  |   | DB   | WB  | TC                               | SHC  | IPT  | TC   | SHC  | IPT  | TC   | SHC  | IPT  | TC   | SHC  | IPT  | TC   | SHC  | IPT  |     |      |
| S-50PU2E5A×2<br>U-100PEY1E5<br>(U-100PEY1E8) | 220V-230V-240V<br>50Hz 1phase<br>(380V-400V-415V<br>50Hz 3 phase) | 23   | 16  | 11.1                             | 8.7  | 3.37 | 10.6 | 8.5  | 3.63 | 10.1 | 8.3  | 3.90 | 8.5  | 7.6  | 3.70 | 4.4  | 4.4  | 1.39 |     |      |
|  |   |  | 19  | 11.9                             | 6.5  | 3.52 | 11.3 | 6.3  | 3.79 | 10.7 | 6.1  | 4.06 | 9.1  | 5.4  | 3.86 | 4.7  | 3.8  | 1.45 |     |      |
|  |   |  | 22  | 13.0                             | 4.4  | 3.64 | 12.4 | 4.3  | 3.92 | 11.8 | 4.0  | 4.20 | 10.0 | 3.4  | 3.99 | 5.2  | 1.9  | 1.50 |     |      |
|  |   | 25   | 16  | 11.5                             | 10.2 | 3.43 | 11.0 | 10.0 | 3.70 | 10.4 | 9.7  | 3.96 | 8.8  | 8.8  | 3.76 | 4.6  | 4.6  | 1.41 |     |      |
|  |   |  | 19  | 12.3                             | 8.0  | 3.58 | 11.7 | 7.7  | 3.85 | 11.1 | 7.5  | 4.13 | 9.4  | 6.8  | 3.93 | 4.9  | 4.9  | 1.47 |     |      |
|  |   |  | 22  | 13.5                             | 6.0  | 3.70 | 12.8 | 5.7  | 3.99 | 12.2 | 5.4  | 4.27 | 10.3 | 4.8  | 4.06 | 5.4  | 3.2  | 1.53 |     |      |
|  |   | 27   | 16  | 11.9                             | 11.7 | 3.49 | 11.3 | 11.3 | 3.76 | 10.8 | 10.8 | 4.03 | 9.1  | 9.1  | 3.83 | 4.8  | 4.8  | 1.44 |     |      |
|  |   |  | 19  | 12.7                             | 9.4  | 3.64 | 12.1 | 9.2  | 3.92 | 11.5 | 8.9  | 4.20 | 9.8  | 8.2  | 3.99 | 5.1  | 5.1  | 1.50 |     |      |
|  |   |  | 22  | 13.9                             | 7.4  | 3.76 | 13.3 | 7.1  | 4.05 | 12.6 | 6.8  | 4.35 | 10.7 | 6.2  | 4.13 | 5.6  | 4.5  | 1.55 |     |      |
|  |   | 29   | 16  | 12.1                             | 12.1 | 3.50 | 11.5 | 11.5 | 3.77 | 10.9 | 10.9 | 4.04 | 9.3  | 9.3  | 3.84 | 4.8  | 4.8  | 1.44 |     |      |
|  |   |  | 19  | 12.9                             | 10.8 | 3.65 | 12.3 | 10.5 | 3.93 | 11.7 | 10.3 | 4.21 | 9.9  | 9.5  | 4.00 | 5.2  | 5.2  | 1.50 |     |      |
|  |   |  | 22  | 14.1                             | 8.7  | 3.77 | 13.5 | 8.5  | 4.06 | 12.8 | 8.2  | 4.36 | 10.9 | 7.5  | 4.14 | 5.7  | 5.7  | 1.56 |     |      |
|  |   | 32   | 16  | 12.3                             | 12.3 | 3.50 | 11.7 | 11.7 | 3.78 | 11.1 | 11.1 | 4.05 | 9.4  | 9.4  | 3.84 | 4.9  | 4.9  | 1.44 |     |      |
|  |   |  | 19  | 13.1                             | 12.8 | 3.65 | 12.5 | 12.5 | 3.94 | 11.8 | 11.8 | 4.22 | 10.1 | 10.1 | 4.01 | 5.2  | 5.2  | 1.51 |     |      |
|  |   |  | 22  | 14.3                             | 10.7 | 3.78 | 13.7 | 10.4 | 4.07 | 13.0 | 10.2 | 4.37 | 11.0 | 9.4  | 4.15 | 5.7  | 5.7  | 1.56 |     |      |
|  |   | S-60PU2E5A×2<br>U-125PEY1E5<br>(U-125PEY1E8) | 220V-230V-240V<br>50Hz 1phase<br>(380V-400V-415V<br>50Hz 3 phase) | 23                               | 16   | 12.5 | 10.3 | 3.92 | 12.2 | 10.2 | 4.22 | 11.8 | 10.0 | 4.53 | 9.5  | 9.0  | 4.30 | 5.2  | 5.2 | 1.62 |
|  |   |  |   |                                  | 19   | 13.4 | 7.6  | 4.09 | 13.0 | 7.5  | 4.40 | 12.6 | 7.3  | 4.72 | 10.2 | 6.4  | 4.49 | 5.6  | 4.7 | 1.69 |
|  |   |  |   |                                  | 22   | 14.7 | 5.0  | 4.23 | 14.3 | 4.9  | 4.56 | 13.8 | 4.7  | 4.88 | 11.1 | 3.8  | 4.64 | 6.1  | 2.2 | 1.74 |
| 25   | 16  |  |   | 13.0                             | 12.2 | 3.98 | 12.6 | 12.0 | 4.29 | 12.2 | 11.9 | 4.60 | 9.9  | 9.9  | 4.37 | 5.4  | 5.4  | 1.64 |     |      |
|  | 19  |  |   | 13.8                             | 9.4  | 4.16 | 13.5 | 9.3  | 4.48 | 13.1 | 9.1  | 4.80 | 10.5 | 8.1  | 4.56 | 5.8  | 5.8  | 1.71 |     |      |
|  | 22  |  |   | 15.2                             | 6.8  | 4.30 | 14.8 | 6.7  | 4.63 | 14.3 | 6.5  | 4.97 | 11.5 | 5.5  | 4.72 | 6.3  | 3.9  | 1.77 |     |      |
| 27   | 16  |  |   | 13.4                             | 13.4 | 4.05 | 13.0 | 13.0 | 4.36 | 12.6 | 12.6 | 4.68 | 10.2 | 10.2 | 4.45 | 5.6  | 5.6  | 1.67 |     |      |
|  | 19  |  |   | 14.3                             | 11.2 | 4.23 | 13.9 | 11.0 | 4.55 | 13.5 | 10.9 | 4.88 | 10.9 | 9.9  | 4.64 | 6.0  | 6.0  | 1.74 |     |      |
|  | 22  |  |   | 15.7                             | 8.6  | 4.37 | 15.3 | 8.5  | 4.71 | 14.8 | 8.3  | 5.05 | 11.9 | 7.3  | 4.80 | 6.5  | 5.5  | 1.80 |     |      |
| 29   | 16  |  |   | 13.6                             | 13.6 | 4.06 | 13.2 | 13.2 | 4.38 | 12.8 | 12.8 | 4.69 | 10.3 | 10.3 | 4.46 | 5.7  | 5.7  | 1.67 |     |      |
|  | 19  |  |   | 14.5                             | 12.9 | 4.24 | 14.1 | 12.8 | 4.56 | 13.7 | 12.6 | 4.89 | 11.1 | 11.1 | 4.65 | 6.1  | 6.1  | 1.75 |     |      |
|  | 22  |  |   | 15.9                             | 10.3 | 4.38 | 15.5 | 10.1 | 4.72 | 15.0 | 9.9  | 5.06 | 12.1 | 8.9  | 4.81 | 6.6  | 6.6  | 1.81 |     |      |
| 32   | 16  |  |   | 13.8                             | 13.8 | 4.07 | 13.4 | 13.4 | 4.39 | 13.0 | 13.0 | 4.70 | 10.5 | 10.5 | 4.47 | 5.8  | 5.8  | 1.68 |     |      |
|  | 19  |  |   | 14.7                             | 14.7 | 4.25 | 14.3 | 14.3 | 4.58 | 13.9 | 13.9 | 4.90 | 11.2 | 11.2 | 4.66 | 6.1  | 6.1  | 1.75 |     |      |
|  | 22  |  |   | 16.2                             | 12.8 | 4.39 | 15.7 | 12.6 | 4.73 | 15.2 | 12.4 | 5.07 | 12.3 | 11.4 | 4.82 | 6.7  | 6.7  | 1.81 |     |      |
| S-71PU2E5A×2<br>U-140PEY1E8                  | 220V-230V-240V<br>50Hz 1phase<br>(380V-400V-415V<br>50Hz 3 phase) |  |   | 23                               | 16   | 14.1 | 10.8 | 4.71 | 14.1 | 10.7 | 5.06 | 13.6 | 10.5 | 5.39 | 12.6 | 9.4  | 5.60 | 9.2  | 5.5 | 4.58 |
|  |   |  |   |                                  | 19   | 15.1 | 8.0  | 4.92 | 15.1 | 7.8  | 5.28 | 14.5 | 7.6  | 5.62 | 13.5 | 6.7  | 5.85 | 9.8  | 4.9 | 4.78 |
|  |   |  |   |                                  | 22   | 16.5 | 5.3  | 5.09 | 16.5 | 5.1  | 5.47 | 15.9 | 5.0  | 5.81 | 14.8 | 4.0  | 6.05 | 10.8 | 2.3 | 4.94 |
|  |   | 25   | 16  | 14.6                             | 12.8 | 4.79 | 14.6 | 12.6 | 5.15 | 14.0 | 12.4 | 5.48 | 13.1 | 10.4 | 5.70 | 9.5  | 5.7  | 4.66 |     |      |
|  |   |  | 19  | 15.6                             | 9.8  | 5.00 | 15.6 | 9.7  | 5.37 | 15.0 | 9.5  | 5.72 | 13.9 | 8.5  | 5.94 | 10.2 | 6.1  | 4.86 |     |      |
|  |   |  | 22  | 17.1                             | 7.1  | 5.17 | 17.1 | 7.0  | 5.56 | 16.4 | 6.8  | 5.91 | 15.3 | 5.8  | 6.15 | 11.2 | 4.1  | 5.03 |     |      |
|  |   | 27   | 16  | 15.1                             | 14.1 | 4.87 | 15.1 | 13.7 | 5.24 | 14.5 | 13.2 | 5.57 | 13.5 | 10.7 | 5.79 | 9.9  | 5.9  | 4.73 |     |      |
|  |   |  | 19  | 16.1                             | 11.7 | 5.08 | 16.1 | 11.6 | 5.46 | 15.5 | 11.4 | 5.81 | 14.4 | 10.3 | 6.04 | 10.5 | 6.3  | 4.94 |     |      |
|  |   |  | 22  | 17.7                             | 9.0  | 5.26 | 17.7 | 8.9  | 5.65 | 17.0 | 8.7  | 6.01 | 15.8 | 7.6  | 6.25 | 11.5 | 5.8  | 5.11 |     |      |
|  |   | 29   | 16  | 15.3                             | 14.3 | 4.89 | 15.3 | 13.9 | 5.25 | 14.7 | 13.5 | 5.58 | 13.7 | 10.8 | 5.81 | 10.0 | 6.0  | 4.75 |     |      |
|  |   |  | 19  | 16.4                             | 13.5 | 5.10 | 16.4 | 13.4 | 5.47 | 15.7 | 13.2 | 5.82 | 14.6 | 11.6 | 6.06 | 10.7 | 6.4  | 4.95 |     |      |
|  |   |  | 22  | 17.9                             | 10.7 | 5.27 | 17.9 | 10.6 | 5.66 | 17.2 | 10.4 | 6.03 | 16.0 | 9.4  | 6.27 | 11.7 | 6.9  | 5.12 |     |      |
|  |   | 32   | 16  | 15.5                             | 14.5 | 4.90 | 15.5 | 14.1 | 5.26 | 14.9 | 13.7 | 5.60 | 13.9 | 11.1 | 5.82 | 10.2 | 6.1  | 4.76 |     |      |
|  |   |  | 19  | 16.6                             | 15.4 | 5.11 | 16.6 | 15.0 | 5.49 | 16.0 | 14.6 | 5.84 | 14.8 | 11.8 | 6.07 | 10.9 | 6.4  | 4.96 |     |      |
|  |   |  | 22  | 18.2                             | 13.4 | 5.29 | 18.2 | 13.2 | 5.68 | 17.5 | 13.0 | 6.04 | 16.3 | 11.9 | 6.28 | 11.9 | 7.1  | 5.13 |     |      |

1-13. Capacity Table

1. Cooling Capacity Performance Data

TC :Cooling Capacity

SHC :Sensible Heat Capacity

IPT :Cooling Power Consumption

• Combination of Single Unit

Ceiling Type

unit : kW

| Model                                       | Power Source  | Ambient Return Air                          |   | Outdoor air intake temp(°C D.B.) |      |      |      |      |      |      |      |      |      |      |      |      |      |      |     |      |
|---|---|---|---|----------------------------------|------|------|------|------|------|------|------|------|------|------|------|------|------|------|-----|------|
|   |   |   |   | 25°C                             |      |      | 30°C |      |      | 35°C |      |      | 40°C |      |      | 43°C |      |      |     |      |
|   |   |   |   | DB                               | WB   | TC   | SHC  | IPT  | TC   | SHC  | IPT  | TC   | SHC  | IPT  | TC   | SHC  | IPT  | TC   | SHC | IPT  |
| S-60PT2E5A<br>U-60PEY2E5                    | 220V-230V-240V<br>50Hz 1phase                                     | 23  | 16  | 7.1                              | 5.4  | 1.85 | 6.8  | 5.2  | 2.02 | 6.5  | 5.1  | 2.19 | 6.1  | 4.9  | 2.13 | 5.0  | 4.4  | 1.41 |     |      |
|   |   |   | 19  | 7.8                              | 4.2  | 1.90 | 7.4  | 4.0  | 2.08 | 7.1  | 3.9  | 2.25 | 6.7  | 3.7  | 2.18 | 5.3  | 3.2  | 1.43 |     |      |
|   |   |   | 22  | 8.6                              | 3.0  | 1.94 | 8.2  | 2.9  | 2.12 | 7.8  | 2.7  | 2.30 | 7.3  | 2.5  | 2.23 | 5.7  | 2.0  | 1.46 |     |      |
|   |   | 25  | 16  | 7.1                              | 6.1  | 1.85 | 6.8  | 6.0  | 2.02 | 6.5  | 5.8  | 2.19 | 6.1  | 5.7  | 2.13 | 5.0  | 5.0  | 1.41 |     |      |
|   |   |   | 19  | 7.8                              | 4.9  | 1.90 | 7.4  | 4.8  | 2.08 | 7.1  | 4.6  | 2.25 | 6.7  | 4.5  | 2.18 | 5.3  | 3.9  | 1.43 |     |      |
|   |   |   | 22  | 8.6                              | 3.7  | 1.94 | 8.2  | 3.6  | 2.12 | 7.8  | 3.5  | 2.30 | 7.3  | 3.2  | 2.23 | 5.7  | 2.7  | 1.46 |     |      |
|   |   | 27  | 16  | 7.1                              | 6.9  | 1.85 | 6.8  | 6.7  | 2.02 | 6.5  | 6.5  | 2.19 | 6.1  | 6.1  | 2.13 | 5.0  | 5.0  | 1.41 |     |      |
|   |   |   | 19  | 7.8                              | 5.7  | 1.90 | 7.4  | 5.5  | 2.08 | 7.1  | 5.4  | 2.25 | 6.7  | 5.2  | 2.18 | 5.3  | 4.6  | 1.43 |     |      |
|   |   |   | 22  | 8.6                              | 4.5  | 1.94 | 8.2  | 4.3  | 2.12 | 7.8  | 4.2  | 2.30 | 7.3  | 4.0  | 2.23 | 5.7  | 3.4  | 1.46 |     |      |
|   |   | 29  | 16  | 7.1                              | 7.1  | 1.85 | 6.8  | 6.8  | 2.02 | 6.5  | 6.5  | 2.19 | 6.1  | 6.1  | 2.13 | 5.0  | 5.0  | 1.41 |     |      |
|   |   |   | 19  | 7.8                              | 6.4  | 1.90 | 7.4  | 6.2  | 2.08 | 7.1  | 6.1  | 2.25 | 6.7  | 5.9  | 2.18 | 5.3  | 5.3  | 1.43 |     |      |
|   |   |   | 22  | 8.6                              | 5.2  | 1.94 | 8.2  | 5.1  | 2.12 | 7.8  | 4.9  | 2.30 | 7.3  | 4.7  | 2.23 | 5.7  | 4.1  | 1.46 |     |      |
|   |   | 32  | 16  | 7.1                              | 7.1  | 1.85 | 6.8  | 6.8  | 2.02 | 6.5  | 6.5  | 2.19 | 6.1  | 6.1  | 2.13 | 5.0  | 5.0  | 1.41 |     |      |
|   |   |   | 19  | 7.8                              | 7.5  | 1.90 | 7.4  | 7.3  | 2.08 | 7.1  | 7.1  | 2.25 | 6.7  | 6.7  | 2.18 | 5.3  | 5.3  | 1.43 |     |      |
|   |   |   | 22  | 8.6                              | 6.3  | 1.94 | 8.2  | 6.2  | 2.12 | 7.8  | 6.0  | 2.30 | 7.3  | 5.8  | 2.23 | 5.7  | 5.2  | 1.46 |     |      |
|   |   | S-71PT2E5A<br>U-71PEY21E5                   | 220V-230V-240V<br>50Hz 1phase                                     | 23                               | 16   | 7.7  | 5.8  | 2.19 | 7.4  | 5.6  | 2.38 | 7.1  | 5.5  | 2.58 | 6.7  | 5.3  | 2.18 | 5.4  | 4.7 | 1.50 |
|   |   |   |   |                                  | 19   | 8.4  | 4.5  | 2.25 | 8.1  | 4.4  | 2.45 | 7.7  | 4.2  | 2.65 | 7.2  | 4.0  | 2.23 | 5.7  | 3.4 | 1.53 |
|   |   |   |   |                                  | 22   | 9.3  | 3.3  | 2.29 | 8.9  | 3.1  | 2.50 | 8.5  | 3.0  | 2.70 | 7.9  | 2.7  | 2.28 | 6.0  | 2.1 | 1.55 |
| 25  | 16  |   |   | 7.7                              | 6.6  | 2.19 | 7.4  | 6.4  | 2.38 | 7.1  | 6.3  | 2.58 | 6.7  | 6.1  | 2.18 | 5.4  | 5.4  | 1.50 |     |      |
|   | 19  |   |   | 8.4                              | 5.3  | 2.25 | 8.1  | 5.1  | 2.45 | 7.7  | 5.0  | 2.65 | 7.2  | 4.7  | 2.23 | 5.7  | 4.2  | 1.53 |     |      |
|   | 22  |   |   | 9.3                              | 4.0  | 2.29 | 8.9  | 3.9  | 2.50 | 8.5  | 3.7  | 2.70 | 7.9  | 3.5  | 2.28 | 6.0  | 2.8  | 1.55 |     |      |
| 27  | 16  |   |   | 7.7                              | 7.4  | 2.19 | 7.4  | 7.2  | 2.38 | 7.1  | 7.1  | 2.58 | 6.7  | 6.7  | 2.18 | 5.4  | 5.4  | 1.50 |     |      |
|   | 19  |   |   | 8.4                              | 6.1  | 2.25 | 8.1  | 5.9  | 2.45 | 7.7  | 5.7  | 2.65 | 7.2  | 5.5  | 2.23 | 5.7  | 4.9  | 1.53 |     |      |
|   | 22  |   |   | 9.3                              | 4.8  | 2.29 | 8.9  | 4.7  | 2.50 | 8.5  | 4.5  | 2.70 | 7.9  | 4.3  | 2.28 | 6.0  | 3.6  | 1.55 |     |      |
| 29  | 16  |   |   | 7.7                              | 7.7  | 2.19 | 7.4  | 7.4  | 2.38 | 7.1  | 7.1  | 2.58 | 6.7  | 6.7  | 2.18 | 5.4  | 5.4  | 1.50 |     |      |
|   | 19  |   |   | 8.4                              | 6.8  | 2.25 | 8.1  | 6.7  | 2.45 | 7.7  | 6.5  | 2.65 | 7.2  | 6.3  | 2.23 | 5.7  | 5.7  | 1.53 |     |      |
|   | 22  |   |   | 9.3                              | 5.6  | 2.29 | 8.9  | 5.4  | 2.50 | 8.5  | 5.3  | 2.70 | 7.9  | 5.1  | 2.28 | 6.0  | 4.4  | 1.55 |     |      |
| 32  | 16  |   |   | 7.7                              | 7.7  | 2.19 | 7.4  | 7.4  | 2.38 | 7.1  | 7.1  | 2.58 | 6.7  | 6.7  | 2.18 | 5.4  | 5.4  | 1.50 |     |      |
|   | 19  |   |   | 8.4                              | 8.0  | 2.25 | 8.1  | 7.9  | 2.45 | 7.7  | 7.7  | 2.65 | 7.2  | 7.2  | 2.23 | 5.7  | 5.7  | 1.53 |     |      |
|   | 22  |   |   | 9.3                              | 6.7  | 2.29 | 8.9  | 6.6  | 2.50 | 8.5  | 6.4  | 2.70 | 7.9  | 6.2  | 2.28 | 6.0  | 5.5  | 1.55 |     |      |
| S-100PT2E5A<br>U-100PEY1E5<br>(U-100PEY1E8) | 220V-230V-240V<br>50Hz 1phase<br>(380V-400V-415V<br>50Hz 3 phase) |   |   | 23                               | 16   | 11.1 | 8.3  | 3.49 | 10.6 | 7.9  | 3.76 | 10.1 | 7.6  | 4.02 | 8.5  | 6.7  | 3.82 | 6.1  | 5.6 | 2.64 |
|   |   |   |   |                                  | 19   | 11.9 | 6.2  | 3.64 | 11.3 | 5.9  | 3.92 | 10.7 | 5.7  | 4.20 | 9.1  | 5.0  | 3.99 | 6.5  | 4.0 | 2.75 |
|   |   |   |   |                                  | 22   | 13.0 | 4.1  | 3.76 | 12.4 | 4.0  | 4.05 | 11.8 | 3.8  | 4.34 | 10.0 | 3.2  | 4.13 | 7.2  | 2.3 | 2.84 |
|   |   | 25  | 16  | 11.5                             | 9.9  | 3.54 | 11.0 | 9.5  | 3.82 | 10.4 | 9.0  | 4.09 | 8.8  | 8.2  | 3.89 | 6.3  | 6.0  | 2.68 |     |      |
|   |   |   | 19  | 12.3                             | 7.8  | 3.70 | 11.7 | 7.4  | 3.98 | 11.1 | 7.2  | 4.27 | 9.4  | 6.3  | 4.06 | 6.8  | 5.2  | 2.80 |     |      |
|   |   |   | 22  | 13.5                             | 5.7  | 3.82 | 12.8 | 5.4  | 4.12 | 12.2 | 5.2  | 4.42 | 10.3 | 4.5  | 4.20 | 7.4  | 3.5  | 2.89 |     |      |
|   |   | 27  | 16  | 11.9                             | 11.3 | 3.60 | 11.3 | 10.7 | 3.88 | 10.8 | 10.2 | 4.16 | 9.1  | 8.6  | 3.95 | 6.6  | 6.3  | 2.73 |     |      |
|   |   |   | 19  | 12.7                             | 9.4  | 3.76 | 12.1 | 9.0  | 4.05 | 11.5 | 8.6  | 4.34 | 9.8  | 7.7  | 4.12 | 7.0  | 6.5  | 2.84 |     |      |
|   |   |   | 22  | 13.9                             | 7.4  | 3.89 | 13.3 | 7.1  | 4.19 | 12.6 | 6.7  | 4.49 | 10.7 | 5.9  | 4.27 | 7.7  | 4.8  | 2.94 |     |      |
|   |   | 29  | 16  | 12.1                             | 11.5 | 3.61 | 11.5 | 10.9 | 3.89 | 10.9 | 10.3 | 4.17 | 9.3  | 8.8  | 3.96 | 6.7  | 6.4  | 2.73 |     |      |
|   |   |   | 19  | 12.9                             | 11.0 | 3.77 | 12.3 | 10.5 | 4.06 | 11.7 | 10.1 | 4.35 | 9.9  | 9.1  | 4.13 | 7.1  | 6.7  | 2.85 |     |      |
|   |   |   | 22  | 14.1                             | 8.9  | 3.90 | 13.5 | 8.5  | 4.20 | 12.8 | 8.2  | 4.50 | 10.9 | 7.3  | 4.28 | 7.8  | 6.0  | 2.95 |     |      |
|   |   | 32  | 16  | 12.3                             | 11.7 | 3.62 | 11.7 | 11.1 | 3.90 | 11.1 | 10.5 | 4.18 | 9.4  | 8.9  | 3.97 | 6.8  | 6.4  | 2.74 |     |      |
|   |   |   | 19  | 13.1                             | 11.2 | 3.78 | 12.5 | 10.7 | 4.07 | 11.8 | 10.2 | 4.36 | 10.1 | 9.3  | 4.14 | 7.2  | 6.8  | 2.86 |     |      |
|   |   |   | 22  | 14.3                             | 9.0  | 3.91 | 13.7 | 8.6  | 4.21 | 13.0 | 8.3  | 4.51 | 11.0 | 7.4  | 4.29 | 7.9  | 6.1  | 2.96 |     |      |
|   |   | S-125PT2E5A<br>U-125PEY1E5<br>(U-125PEY1E8) | 220V-230V-240V<br>50Hz 1phase<br>(380V-400V-415V<br>50Hz 3 phase) | 23                               | 16   | 12.5 | 9.1  | 4.14 | 12.2 | 8.9  | 4.46 | 11.8 | 8.6  | 4.79 | 9.5  | 7.2  | 4.55 | 7.2  | 6.3 | 3.13 |
|   |   |   |   |                                  | 19   | 13.4 | 7.0  | 4.32 | 13.0 | 6.8  | 4.66 | 12.6 | 6.6  | 4.99 | 10.2 | 5.5  | 4.74 | 7.7  | 4.5 | 3.27 |
|   |   |   |   |                                  | 22   | 14.7 | 4.9  | 4.47 | 14.3 | 4.9  | 4.82 | 13.8 | 4.6  | 5.16 | 11.1 | 3.8  | 4.91 | 8.4  | 2.8 | 3.38 |
| 25  | 16  |   |   | 13.0                             | 10.8 | 4.21 | 12.6 | 10.4 | 4.54 | 12.2 | 10.2 | 4.87 | 9.9  | 8.6  | 4.62 | 7.4  | 7.3  | 3.19 |     |      |
|   | 19  |   |   | 13.8                             | 8.6  | 4.40 | 13.5 | 8.3  | 4.74 | 13.1 | 8.1  | 5.08 | 10.5 | 6.7  | 4.82 | 8.0  | 5.8  | 3.32 |     |      |
|   | 22  |   |   | 15.2                             | 6.5  | 4.55 | 14.8 | 6.3  | 4.90 | 14.3 | 6.1  | 5.25 | 11.5 | 5.0  | 4.99 | 8.7  | 4.0  | 3.44 |     |      |
| 27  | 16  |   |   | 13.4                             | 12.4 | 4.28 | 13.0 | 12.1 | 4.62 | 12.6 | 11.8 | 4.95 | 10.2 | 10.0 | 4.70 | 7.7  | 7.6  | 3.24 |     |      |
|   | 19  |   |   | 14.3                             | 10.2 | 4.47 | 13.9 | 10.0 | 4.81 | 13.5 | 9.7  | 5.16 | 10.9 | 8.2  | 4.90 | 8.2  | 7.2  | 3.38 |     |      |
|   | 22  |   |   | 15.7                             | 8.2  | 4.62 | 15.3 | 7.9  | 4.98 | 14.8 | 7.8  | 5.34 | 11.9 | 6.4  | 5.07 | 9.0  | 5.3  | 3.50 |     |      |
| 29  | 16  |   |   | 13.6                             | 13.3 | 4.29 | 13.2 | 12.9 | 4.63 | 12.8 | 12.6 | 4.96 | 10.3 | 10.1 | 4.71 | 7.8  | 7.6  | 3.25 |     |      |
|   | 19  |   |   | 14.5                             | 11.8 | 4.48 | 14.1 | 11.4 | 4.83 | 13.7 | 11.2 | 5.17 | 11.1 | 9.5  | 4.92 | 8.3  | 8.1  | 3.39 |     |      |
|   | 22  |   |   | 15.9                             | 9.7  | 4.63 | 15.5 | 9.5  | 4.99 | 15.0 | 9.2  | 5.35 | 12.1 | 7.7  | 5.09 | 9.1  | 6.7  | 3.50 |     |      |
| 32  | 16  |   |   | 13.8                             | 13.5 | 4.30 | 13.4 | 13.1 | 4.64 | 13.0 | 12.7 | 4.97 | 10.5 | 10.3 | 4.72 | 7.9  | 7.7  | 3.26 |     |      |
|   | 19  |   |   | 14.7                             | 11.9 | 4.49 | 14.3 | 11.6 | 4.84 | 13.9 | 11.3 | 5.19 | 11.2 | 9.6  | 4.93 | 8.5  | 8.3  | 3.40 |     |      |
|   | 22  |   |   | 16.2                             | 9.8  | 4.65 | 15.7 | 9.6  | 5.01 | 15.2 | 9.3  | 5.36 | 12.3 | 7.8  | 5.10 | 9.3  | 6.8  | 3.51 |     |      |
| S-140PT2E5A<br>U-140PEY1E8                  | 220V-230V-240V<br>50Hz 1phase<br>(380V-400V-415V<br>50Hz 3 phase) |   |   | 23                               | 16   | 13.6 | 9.6  | 4.63 | 13.6 | 9.6  | 4.97 | 13.1 | 9.3  | 5.29 | 12.2 | 9.0  | 5.50 | 8.9  | 7.5 | 4.49 |
|   |   |   |   |                                  | 19   | 14.6 | 7.5  | 4.82 | 14.6 | 7.5  | 5.18 | 14.0 | 7.2  | 5.51 | 13.0 | 6.9  | 5.73 | 9.5  | 5.4 | 4.69 |
|   |   |   |   |                                  | 22   | 16.0 | 5.5  | 4.99 | 16.0 | 5.4  | 5.36 | 15.4 | 5.3  | 5.70 | 14.3 | 4.8  | 5.93 | 10.4 | 3.5 | 4.85 |
|   |   | 25  | 16  | 14.1                             | 11.3 | 4.70 | 14.1 | 11.3 | 5.05 | 13.6 | 11.0 | 5.38 | 12.6 | 10.7 | 5.59 | 9.2  | 9.1  | 4.57 |     |      |
|   |   |   | 19  | 15.1                             | 9.2  | 4.91 | 15.1 | 9.1  | 5.27 | 14.5 | 8.8  | 5.61 | 13.5 | 8.5  | 5.83 | 9.9  | 7.0  | 4.77 |     |      |
|   |   |   | 22  | 16.5                             | 6.9  | 5.08 | 16.5 | 7.0  | 5.45 | 15.9 | 6.7  | 5.80 | 14.8 | 6.4  | 6.03 | 10.8 | 4.9  | 4.93 |     |      |
|   |   | 27  | 16  | 14.6                             | 13.0 | 4.78 | 14.6 | 13.1 | 5.14 | 14.0 | 12.7 | 5.46 | 13.1 | 12.5 | 5.68 | 9.5  | 9.4  | 4.64 |     |      |
|   |   |   | 19  | 15.6                             | 10.9 | 4.99 | 15.6 | 10.8 | 5.36 | 15.0 | 10.4 | 5.70 | 14.0 | 10.2 | 5.93 | 10.2 | 8.6  | 4.85 |     |      |
|   |   |   | 22  | 17.1                             | 8.6  | 5.16 | 17.1 | 8.7  | 5.54 | 16.4 | 8.4  | 5.90 | 15.3 | 8.0  | 6.13 | 11.2 | 6.5  | 5.01 |     |      |
|   |   | 29  | 16  | 14.8                             | 14.6 | 4.79 | 14.8 | 14.6 | 5.15 | 14.3 | 14.1 | 5.48 | 13.3 | 13.1 | 5.70 | 9.7  | 9.6  | 4.66 |     |      |
|   |   |   | 19  | 15.8                             | 12.3 | 5.00 | 15.8 | 12.4 | 5.37 | 15.2 | 12.0 | 5.71 | 14.2 | 11.8 | 5.94 | 10.4 | 10.1 | 4.86 |     |      |
|   |   |   | 22  | 17.3                             | 10.2 | 5.17 | 17.3 | 10.3 | 5.56 | 16.7 | 10.0 | 5.91 | 15.5 | 9.5  | 6.15 | 11.3 | 7.9  | 5.02 |     |      |
|   |   | 32  | 16  | 15.0                             | 14.8 | 4.81 | 15.0 | 14.8 | 5.16 | 14.5 | 14.3 | 5.49 | 13.4 | 13.2 | 5.71 | 9.8  | 9.7  | 4.67 |     |      |
|   |   |   | 19  | 16.1                             | 12.5 | 5.01 | 16.1 | 12.6 | 5.38 | 15.4 | 12.1 | 5.73 | 14.4 | 11.9 | 5.96 | 10.5 | 10.2 | 4.87 |     |      |
|   |   |   | 22  | 17.6                             | 10.4 | 5.19 | 17.6 | 10.5 | 5.57 | 16.9 | 10.1 | 5.93 | 15.7 | 9.7  | 6.16 | 11.5 | 8.0  | 5.04 |     |      |

1-13. Capacity Table

1. Cooling Capacity Performance Data

TC :Cooling Capacity

SHC :Sensible Heat Capacity

IPT :Cooling Power Consumption

• Combination of Multiple Unit

unit : kW

Ceiling Type

| Model  | Power Source  | Ambient Return Air |      | Outdoor air intake temp(°C D.B.) |      |      |      |      |      |      |      |      |      |      |      |      |      |      |
|--|---|--------------------|------|----------------------------------|------|------|------|------|------|------|------|------|------|------|------|------|------|------|
|  |   |                    |      | 25°C                             |      |      | 30°C |      |      | 35°C |      |      | 40°C |      |      | 43°C |      |      |
|  |   |                    |      | DB                               | WB   | TC   | SHC  | IPT  | TC   | SHC  | IPT  | TC   | SHC  | IPT  | TC   | SHC  | IPT  | TC   |
| S-50PT2E5A×2<br>U-100PEY1E5<br>(U-100PEY1E8) | 220V-230V-240V<br>50Hz 1phase<br>(380V-400V-415V<br>50Hz 3 phase) | 23                 | 16   | 11.1                             | 8.5  | 3.49 | 10.6 | 8.1  | 3.76 | 10.1 | 7.8  | 4.02 | 8.5  | 6.8  | 3.82 | 6.1  | 5.6  | 2.64 |
|  |   |                    | 19   | 11.9                             | 6.5  | 3.64 | 11.3 | 6.1  | 3.92 | 10.7 | 5.8  | 4.20 | 9.1  | 5.1  | 3.99 | 6.5  | 4.0  | 2.75 |
|  |   |                    | 22   | 13.0                             | 4.6  | 3.76 | 12.4 | 4.4  | 4.05 | 11.8 | 4.2  | 4.34 | 10.0 | 3.5  | 4.13 | 7.2  | 2.5  | 2.84 |
|  |   | 25                 | 16   | 11.5                             | 10.0 | 3.54 | 11.0 | 9.6  | 3.82 | 10.4 | 9.1  | 4.09 | 8.8  | 8.1  | 3.89 | 6.3  | 6.3  | 2.68 |
|  |   |                    | 19   | 12.3                             | 7.9  | 3.70 | 11.7 | 7.5  | 3.98 | 11.1 | 7.2  | 4.27 | 9.4  | 6.3  | 4.06 | 6.8  | 5.2  | 2.80 |
|  |   |                    | 22   | 13.5                             | 6.1  | 3.82 | 12.8 | 5.8  | 4.12 | 12.2 | 5.5  | 4.42 | 10.3 | 4.7  | 4.20 | 7.4  | 3.6  | 2.89 |
|  |   | 27                 | 16   | 11.9                             | 11.6 | 3.60 | 11.3 | 11.0 | 3.88 | 10.8 | 10.6 | 4.16 | 9.1  | 9.1  | 3.95 | 6.6  | 6.6  | 2.73 |
|  |   |                    | 19   | 12.7                             | 9.5  | 3.76 | 12.1 | 9.0  | 4.05 | 11.5 | 8.6  | 4.34 | 9.8  | 7.7  | 4.12 | 7.0  | 6.3  | 2.84 |
|  |   |                    | 22   | 13.9                             | 7.5  | 3.89 | 13.3 | 7.1  | 4.19 | 12.6 | 6.9  | 4.49 | 10.7 | 6.0  | 4.27 | 7.7  | 4.8  | 2.94 |
|  |   | 29                 | 16   | 12.1                             | 12.1 | 3.61 | 11.5 | 11.5 | 3.89 | 10.9 | 10.9 | 4.17 | 9.3  | 9.3  | 3.96 | 6.7  | 6.7  | 2.73 |
|  |   |                    | 19   | 12.9                             | 10.9 | 3.77 | 12.3 | 10.4 | 4.06 | 11.7 | 10.1 | 4.35 | 9.9  | 8.9  | 4.13 | 7.1  | 7.1  | 2.85 |
|  |   |                    | 22   | 14.1                             | 8.9  | 3.90 | 13.5 | 8.5  | 4.20 | 12.8 | 8.3  | 4.50 | 10.9 | 7.3  | 4.28 | 7.8  | 5.9  | 2.95 |
| 32   | 16  | 12.3               | 12.3 | 3.62                             | 11.7 | 11.7 | 3.90 | 11.1 | 11.1 | 4.18 | 9.4  | 9.4  | 3.97 | 6.8  | 6.8  | 2.74 |      |      |
|  | 19  | 13.1               | 11.1 | 3.78                             | 12.5 | 10.6 | 4.07 | 11.8 | 10.2 | 4.36 | 10.1 | 9.1  | 4.14 | 7.2  | 7.2  | 2.86 |      |      |
|  | 22  | 14.3               | 9.1  | 3.91                             | 13.7 | 8.7  | 4.21 | 13.0 | 8.4  | 4.51 | 11.0 | 7.4  | 4.29 | 7.9  | 6.0  | 2.96 |      |      |
| S-60PT2E5A×2<br>U-125PEY1E5<br>(U-125PEY1E8) | 220V-230V-240V<br>50Hz 1phase<br>(380V-400V-415V<br>50Hz 3 phase) | 23                 | 16   | 12.5                             | 9.7  | 4.14 | 12.2 | 9.5  | 4.46 | 11.8 | 9.2  | 4.79 | 9.5  | 7.8  | 4.55 | 7.2  | 6.8  | 3.13 |
|  |   |                    | 19   | 13.4                             | 7.4  | 4.32 | 13.0 | 7.2  | 4.66 | 12.6 | 7.0  | 4.99 | 10.2 | 5.8  | 4.74 | 7.7  | 4.8  | 3.27 |
|  |   |                    | 22   | 14.7                             | 5.1  | 4.47 | 14.3 | 4.9  | 4.82 | 13.8 | 4.8  | 5.16 | 11.1 | 3.8  | 4.91 | 8.4  | 2.9  | 3.38 |
|  |   | 25                 | 16   | 13.0                             | 11.6 | 4.21 | 12.6 | 11.3 | 4.54 | 12.2 | 11.0 | 4.87 | 9.9  | 9.4  | 4.62 | 7.4  | 7.4  | 3.19 |
|  |   |                    | 19   | 13.8                             | 9.1  | 4.40 | 13.5 | 9.0  | 4.74 | 13.1 | 8.8  | 5.08 | 10.5 | 7.3  | 4.82 | 8.0  | 6.3  | 3.32 |
|  |   |                    | 22   | 15.2                             | 6.8  | 4.55 | 14.8 | 6.7  | 4.90 | 14.3 | 6.4  | 5.25 | 11.5 | 5.3  | 4.99 | 8.7  | 4.3  | 3.44 |
|  |   | 27                 | 16   | 13.4                             | 13.4 | 4.28 | 13.0 | 13.0 | 4.62 | 12.6 | 12.6 | 4.95 | 10.2 | 10.2 | 4.70 | 7.7  | 7.7  | 3.24 |
|  |   |                    | 19   | 14.3                             | 10.9 | 4.47 | 13.9 | 10.7 | 4.81 | 13.5 | 10.5 | 5.16 | 10.9 | 8.8  | 4.90 | 8.2  | 7.8  | 3.38 |
|  |   |                    | 22   | 15.7                             | 8.7  | 4.62 | 15.3 | 8.4  | 4.98 | 14.8 | 8.2  | 5.34 | 11.9 | 6.8  | 5.07 | 9.0  | 5.7  | 3.50 |
|  |   | 29                 | 16   | 13.6                             | 13.6 | 4.29 | 13.2 | 13.2 | 4.63 | 12.8 | 12.8 | 4.96 | 10.3 | 10.3 | 4.71 | 7.8  | 7.8  | 3.25 |
|  |   |                    | 19   | 14.5                             | 12.7 | 4.48 | 14.1 | 12.4 | 4.83 | 13.7 | 12.2 | 5.17 | 11.1 | 10.4 | 4.92 | 8.3  | 8.3  | 3.39 |
|  |   |                    | 22   | 15.9                             | 10.4 | 4.63 | 15.5 | 10.1 | 4.99 | 15.0 | 9.9  | 5.35 | 12.1 | 8.4  | 5.09 | 9.1  | 7.2  | 3.50 |
| 32   | 16  | 13.8               | 13.8 | 4.30                             | 13.4 | 13.4 | 4.64 | 13.0 | 13.0 | 4.97 | 10.5 | 10.5 | 4.72 | 7.9  | 7.9  | 3.26 |      |      |
|  | 19  | 14.7               | 12.9 | 4.49                             | 14.3 | 12.6 | 4.84 | 13.9 | 12.3 | 5.19 | 11.2 | 10.5 | 4.93 | 8.5  | 8.5  | 3.40 |      |      |
|  | 22  | 16.2               | 10.6 | 4.65                             | 15.7 | 10.2 | 5.01 | 15.2 | 10.0 | 5.36 | 12.3 | 8.5  | 5.10 | 9.3  | 7.4  | 3.51 |      |      |
| S-71PT2E5A×2<br>U-140PEY1E8                  | 220V-230V-240V<br>50Hz 1phase<br>(380V-400V-415V<br>50Hz 3 phase) | 23                 | 16   | 13.6                             | 10.3 | 4.63 | 13.6 | 10.4 | 4.97 | 13.1 | 10.1 | 5.29 | 12.2 | 9.7  | 5.50 | 8.9  | 8.2  | 4.49 |
|  |   |                    | 19   | 14.6                             | 8.1  | 4.82 | 14.6 | 8.0  | 5.18 | 14.0 | 7.7  | 5.51 | 13.0 | 7.3  | 5.73 | 9.5  | 5.8  | 4.69 |
|  |   |                    | 22   | 16.0                             | 5.7  | 4.99 | 16.0 | 5.7  | 5.36 | 15.4 | 5.4  | 5.70 | 14.3 | 5.0  | 5.93 | 10.4 | 3.7  | 4.85 |
|  |   | 25                 | 16   | 14.1                             | 12.2 | 4.70 | 14.1 | 12.2 | 5.05 | 13.6 | 11.9 | 5.38 | 12.6 | 11.6 | 5.59 | 9.2  | 9.2  | 4.57 |
|  |   |                    | 19   | 15.1                             | 9.8  | 4.91 | 15.1 | 9.8  | 5.27 | 14.5 | 9.5  | 5.61 | 13.5 | 9.1  | 5.83 | 9.9  | 7.6  | 4.77 |
|  |   |                    | 22   | 16.5                             | 7.4  | 5.08 | 16.5 | 7.5  | 5.45 | 15.9 | 7.2  | 5.80 | 14.8 | 6.8  | 6.03 | 10.8 | 5.3  | 4.93 |
|  |   | 27                 | 16   | 14.6                             | 14.2 | 4.78 | 14.6 | 14.2 | 5.14 | 14.0 | 13.8 | 5.46 | 13.1 | 13.1 | 5.68 | 9.5  | 9.5  | 4.64 |
|  |   |                    | 19   | 15.6                             | 11.7 | 4.99 | 15.6 | 11.6 | 5.36 | 15.0 | 11.2 | 5.70 | 14.0 | 11.1 | 5.93 | 10.2 | 9.3  | 4.85 |
|  |   |                    | 22   | 17.1                             | 9.2  | 5.16 | 17.1 | 9.3  | 5.54 | 16.4 | 8.9  | 5.90 | 15.3 | 8.6  | 6.13 | 11.2 | 7.0  | 5.01 |
|  |   | 29                 | 16   | 14.8                             | 14.8 | 4.79 | 14.8 | 14.8 | 5.15 | 14.3 | 14.3 | 5.48 | 13.3 | 13.3 | 5.70 | 9.7  | 9.7  | 4.66 |
|  |   |                    | 19   | 15.8                             | 13.3 | 5.00 | 15.8 | 13.4 | 5.37 | 15.2 | 13.0 | 5.71 | 14.2 | 12.8 | 5.94 | 10.4 | 10.4 | 4.86 |
|  |   |                    | 22   | 17.3                             | 11.0 | 5.17 | 17.3 | 11.0 | 5.56 | 16.7 | 10.7 | 5.91 | 15.5 | 10.3 | 6.15 | 11.3 | 8.5  | 5.02 |
| 32   | 16  | 15.0               | 15.0 | 4.81                             | 15.0 | 15.0 | 5.16 | 14.5 | 14.5 | 5.49 | 13.4 | 13.4 | 5.71 | 9.8  | 9.8  | 4.67 |      |      |
|  | 19  | 16.1               | 13.6 | 5.01                             | 16.1 | 13.7 | 5.38 | 15.4 | 13.1 | 5.73 | 14.4 | 12.9 | 5.96 | 10.5 | 10.5 | 4.87 |      |      |
|  | 22  | 17.6               | 11.2 | 5.19                             | 17.6 | 11.2 | 5.57 | 16.9 | 10.9 | 5.93 | 15.7 | 10.4 | 6.16 | 11.5 | 8.7  | 5.04 |      |      |

1-13. Capacity Table

1. Cooling Capacity Performance Data

• Combination of Single Unit

Wall Mounted Type

TC :Cooling Capacity

SHC :Sensible Heat Capacity

IPT :Cooling Power Consumption

unit : kW

| Model                                       | Power Source  | Ambient Return Air        |                               | Outdoor air intake temp(°C D.B.) |     |      |      |      |      |      |      |      |      |      |      |      |      |      |     |      |
|---|---|---------------------------|-------------------------------|----------------------------------|-----|------|------|------|------|------|------|------|------|------|------|------|------|------|-----|------|
|   |   |                           |                               | 25°C                             |     |      | 30°C |      |      | 35°C |      |      | 40°C |      |      | 43°C |      |      |     |      |
|   |   |                           |                               | DB                               | WB  | TC   | SHC  | IPT  | TC   | SHC  | IPT  | TC   | SHC  | IPT  | TC   | SHC  | IPT  | TC   | SHC | IPT  |
| S-60PK1E5A<br>U-60PEY2E5                    | 220V-230V-240V<br>50Hz 1phase                                     | 23                        | 16                            | 7.1                              | 5.2 | 1.93 | 6.8  | 5.1  | 2.11 | 6.5  | 4.9  | 2.29 | 6.1  | 4.7  | 2.18 | 5.0  | 4.2  | 1.44 |     |      |
|   |   |                           | 19                            | 7.8                              | 4.1 | 1.99 | 7.4  | 3.9  | 2.17 | 7.1  | 3.8  | 2.35 | 6.7  | 3.6  | 2.23 | 5.3  | 3.1  | 1.47 |     |      |
|   |   |                           | 22                            | 8.6                              | 3.0 | 2.03 | 8.2  | 2.9  | 2.21 | 7.8  | 2.7  | 2.40 | 7.3  | 2.5  | 2.28 | 5.7  | 2.0  | 1.49 |     |      |
|   |   | 25                        | 16                            | 7.1                              | 5.9 | 1.93 | 6.8  | 5.8  | 2.11 | 6.5  | 5.6  | 2.29 | 6.1  | 5.4  | 2.18 | 5.0  | 4.9  | 1.44 |     |      |
|   |   |                           | 19                            | 7.8                              | 4.8 | 1.99 | 7.4  | 4.6  | 2.17 | 7.1  | 4.5  | 2.35 | 6.7  | 4.3  | 2.23 | 5.3  | 3.8  | 1.47 |     |      |
|   |   |                           | 22                            | 8.6                              | 3.7 | 2.03 | 8.2  | 3.6  | 2.21 | 7.8  | 3.4  | 2.40 | 7.3  | 3.2  | 2.28 | 5.7  | 2.6  | 1.49 |     |      |
|   |   | 27                        | 16                            | 7.1                              | 6.6 | 1.93 | 6.8  | 6.5  | 2.11 | 6.5  | 6.3  | 2.29 | 6.1  | 6.1  | 2.18 | 5.0  | 5.0  | 1.44 |     |      |
|   |   |                           | 19                            | 7.8                              | 5.5 | 1.99 | 7.4  | 5.3  | 2.17 | 7.1  | 5.2  | 2.35 | 6.7  | 5.0  | 2.23 | 5.3  | 4.4  | 1.47 |     |      |
|   |   |                           | 22                            | 8.6                              | 4.4 | 2.03 | 8.2  | 4.2  | 2.21 | 7.8  | 4.1  | 2.40 | 7.3  | 3.9  | 2.28 | 5.7  | 3.3  | 1.49 |     |      |
|   |   | 29                        | 16                            | 7.1                              | 7.1 | 1.93 | 6.8  | 6.8  | 2.11 | 6.5  | 6.5  | 2.29 | 6.1  | 6.1  | 2.18 | 5.0  | 5.0  | 1.44 |     |      |
|   |   |                           | 19                            | 7.8                              | 6.2 | 1.99 | 7.4  | 6.0  | 2.17 | 7.1  | 5.9  | 2.35 | 6.7  | 5.7  | 2.23 | 5.3  | 5.1  | 1.47 |     |      |
|   |   |                           | 22                            | 8.6                              | 5.1 | 2.03 | 8.2  | 4.9  | 2.21 | 7.8  | 4.7  | 2.40 | 7.3  | 4.6  | 2.28 | 5.7  | 4.0  | 1.49 |     |      |
|   |   | 32                        | 16                            | 7.1                              | 7.1 | 1.93 | 6.8  | 6.8  | 2.11 | 6.5  | 6.5  | 2.29 | 6.1  | 6.1  | 2.18 | 5.0  | 5.0  | 1.44 |     |      |
|   |   |                           | 19                            | 7.8                              | 7.2 | 1.99 | 7.4  | 7.0  | 2.17 | 7.1  | 6.9  | 2.35 | 6.7  | 6.7  | 2.23 | 5.3  | 5.3  | 1.47 |     |      |
|   |   |                           | 22                            | 8.6                              | 6.1 | 2.03 | 8.2  | 5.9  | 2.21 | 7.8  | 5.8  | 2.40 | 7.3  | 5.6  | 2.28 | 5.7  | 5.0  | 1.49 |     |      |
|   |   | S-71PK1E5A<br>U-71PEY21E5 | 220V-230V-240V<br>50Hz 1phase | 23                               | 16  | 7.7  | 5.5  | 2.43 | 7.4  | 5.4  | 2.65 | 7.1  | 5.2  | 2.87 | 6.7  | 5.0  | 2.42 | 5.4  | 4.4 | 1.67 |
|   |   |                           |                               |                                  | 19  | 8.4  | 4.4  | 2.50 | 8.1  | 4.3  | 2.73 | 7.7  | 4.1  | 2.95 | 7.2  | 3.9  | 2.49 | 5.7  | 3.2 | 1.70 |
|   |   |                           |                               |                                  | 22  | 9.3  | 3.3  | 2.55 | 8.9  | 3.2  | 2.78 | 8.5  | 3.0  | 3.01 | 7.9  | 2.8  | 2.54 | 6.0  | 2.1 | 1.73 |
| 25  | 16  |                           |                               | 7.7                              | 6.2 | 2.43 | 7.4  | 6.1  | 2.65 | 7.1  | 5.9  | 2.87 | 6.7  | 5.7  | 2.42 | 5.4  | 5.1  | 1.67 |     |      |
|   | 19  |                           |                               | 8.4                              | 5.1 | 2.50 | 8.1  | 5.0  | 2.73 | 7.7  | 4.8  | 2.95 | 7.2  | 4.5  | 2.49 | 5.7  | 3.9  | 1.70 |     |      |
|   | 22  |                           |                               | 9.3                              | 4.0 | 2.55 | 8.9  | 3.8  | 2.78 | 8.5  | 3.7  | 3.01 | 7.9  | 3.5  | 2.54 | 6.0  | 2.7  | 1.73 |     |      |
| 27  | 16  |                           |                               | 7.7                              | 6.9 | 2.43 | 7.4  | 6.8  | 2.65 | 7.1  | 6.6  | 2.87 | 6.7  | 6.4  | 2.42 | 5.4  | 5.4  | 1.67 |     |      |
|   | 19  |                           |                               | 8.4                              | 5.8 | 2.50 | 8.1  | 5.6  | 2.73 | 7.7  | 5.5  | 2.95 | 7.2  | 5.2  | 2.49 | 5.7  | 4.6  | 1.70 |     |      |
|   | 22  |                           |                               | 9.3                              | 4.7 | 2.55 | 8.9  | 4.5  | 2.78 | 8.5  | 4.4  | 3.01 | 7.9  | 4.1  | 2.54 | 6.0  | 3.4  | 1.73 |     |      |
| 29  | 16  |                           |                               | 7.7                              | 7.6 | 2.43 | 7.4  | 7.4  | 2.65 | 7.1  | 7.1  | 2.87 | 6.7  | 6.7  | 2.42 | 5.4  | 5.4  | 1.67 |     |      |
|   | 19  |                           |                               | 8.4                              | 6.5 | 2.50 | 8.1  | 6.3  | 2.73 | 7.7  | 6.1  | 2.95 | 7.2  | 5.9  | 2.49 | 5.7  | 5.3  | 1.70 |     |      |
|   | 22  |                           |                               | 9.3                              | 5.3 | 2.55 | 8.9  | 5.2  | 2.78 | 8.5  | 5.0  | 3.01 | 7.9  | 4.8  | 2.54 | 6.0  | 4.1  | 1.73 |     |      |
| 32  | 16  |                           |                               | 7.7                              | 7.7 | 2.43 | 7.4  | 7.4  | 2.65 | 7.1  | 7.1  | 2.87 | 6.7  | 6.7  | 2.42 | 5.4  | 5.4  | 1.67 |     |      |
|   | 19  |                           |                               | 8.4                              | 7.5 | 2.50 | 8.1  | 7.4  | 2.73 | 7.7  | 7.2  | 2.95 | 7.2  | 6.9  | 2.49 | 5.7  | 5.7  | 1.70 |     |      |
|   | 22  |                           |                               | 9.3                              | 6.4 | 2.55 | 8.9  | 6.2  | 2.78 | 8.5  | 6.0  | 3.01 | 7.9  | 5.8  | 2.54 | 6.0  | 5.1  | 1.73 |     |      |
| S-100PK1E5A<br>U-100PEY1E5<br>(U-100PEY1E8) | 220V-230V-240V<br>50Hz 1phase<br>(380V-400V-415V<br>50Hz 3 phase) |                           |                               | 23                               | 16  | 9.4  | 6.3  | 3.05 | 8.9  | 6.0  | 3.29 | 8.5  | 5.8  | 3.52 | 7.2  | 5.0  | 3.35 | 5.2  | 3.6 | 2.31 |
|   |   |                           |                               |                                  | 19  | 10.0 | 5.0  | 3.18 | 9.5  | 4.8  | 3.43 | 9.1  | 4.6  | 3.68 | 7.7  | 3.9  | 3.49 | 5.5  | 2.8 | 2.41 |
|   |   |                           |                               |                                  | 22  | 11.0 | 3.9  | 3.29 | 10.5 | 3.7  | 3.55 | 9.9  | 3.5  | 3.80 | 8.4  | 2.9  | 3.61 | 6.0  | 2.1 | 2.49 |
|   |   | 25                        | 16                            | 9.7                              | 7.2 | 3.10 | 9.2  | 6.8  | 3.34 | 8.8  | 6.6  | 3.58 | 7.5  | 5.8  | 3.41 | 5.3  | 4.1  | 2.35 |     |      |
|   |   |                           | 19                            | 10.4                             | 5.9 | 3.24 | 9.9  | 5.6  | 3.49 | 9.4  | 5.4  | 3.74 | 8.0  | 4.7  | 3.55 | 5.7  | 3.3  | 2.45 |     |      |
|   |   |                           | 22                            | 11.4                             | 4.8 | 3.35 | 10.8 | 4.5  | 3.61 | 10.3 | 4.3  | 3.87 | 8.7  | 3.6  | 3.67 | 6.3  | 2.6  | 2.53 |     |      |
|   |   | 27                        | 16                            | 10.0                             | 8.1 | 3.15 | 9.6  | 7.8  | 3.40 | 9.1  | 7.5  | 3.64 | 7.7  | 6.5  | 3.46 | 5.5  | 4.6  | 2.39 |     |      |
|   |   |                           | 19                            | 10.7                             | 6.8 | 3.29 | 10.2 | 6.5  | 3.55 | 9.7  | 6.2  | 3.80 | 8.2  | 5.3  | 3.61 | 5.9  | 3.8  | 2.49 |     |      |
|   |   |                           | 22                            | 11.7                             | 5.6 | 3.40 | 11.2 | 5.4  | 3.67 | 10.6 | 5.1  | 3.93 | 9.0  | 4.4  | 3.74 | 6.5  | 3.2  | 2.57 |     |      |
|   |   | 29                        | 16                            | 10.2                             | 8.9 | 3.16 | 9.7  | 8.5  | 3.41 | 9.2  | 8.2  | 3.65 | 7.8  | 7.1  | 3.47 | 5.6  | 5.1  | 2.39 |     |      |
|   |   |                           | 19                            | 10.9                             | 7.6 | 3.30 | 10.4 | 7.3  | 3.55 | 9.8  | 6.9  | 3.81 | 8.4  | 6.1  | 3.62 | 6.0  | 4.3  | 2.49 |     |      |
|   |   |                           | 22                            | 11.9                             | 6.4 | 3.41 | 11.4 | 6.1  | 3.68 | 10.8 | 5.8  | 3.94 | 9.2  | 5.1  | 3.74 | 6.6  | 3.6  | 2.58 |     |      |
|   |   | 32                        | 16                            | 10.3                             | 9.0 | 3.17 | 9.8  | 8.6  | 3.42 | 9.4  | 8.3  | 3.66 | 7.9  | 7.2  | 3.48 | 5.7  | 5.2  | 2.40 |     |      |
|   |   |                           | 19                            | 11.0                             | 7.7 | 3.31 | 10.5 | 7.3  | 3.56 | 10.0 | 7.0  | 3.82 | 8.5  | 6.1  | 3.63 | 6.1  | 4.4  | 2.50 |     |      |
|   |   |                           | 22                            | 12.1                             | 6.5 | 3.42 | 11.5 | 6.2  | 3.69 | 10.9 | 5.9  | 3.95 | 9.3  | 5.1  | 3.75 | 6.7  | 3.7  | 2.59 |     |      |



1-13. Capacity Table

1. Cooling Capacity Performance Data

TC :Cooling Capacity

SHC :Sensible Heat Capacity

IPT :Cooling Power Consumption

• Combination of Multiple Unit

unit : kW

Wall Mounted Type

| Model  | Power Source  | Ambient Return Air |    | Outdoor air intake temp(°C D.B.) |      |      |      |      |      |      |      |      |      |     |      |      |     |      |
|--|---|--------------------|----|----------------------------------|------|------|------|------|------|------|------|------|------|-----|------|------|-----|------|
|  |   |                    |    | 25°C                             |      |      | 30°C |      |      | 35°C |      |      | 40°C |     |      | 43°C |     |      |
|  |   |                    |    | DB                               | WB   | TC   | SHC  | IPT  | TC   | SHC  | IPT  | TC   | SHC  | IPT | TC   | SHC  | IPT | TC   |
| S-50PK1E5A×2<br>U-100PEY1E5<br>(U-100PEY1E8) | 220V-230V-240V<br>50Hz 1phase<br>(380V-400V-415V<br>50Hz 3 phase) | 23                 | 16 | 10.6                             | 8.1  | 3.37 | 10.1 | 7.7  | 3.63 | 9.6  | 7.4  | 3.90 | 8.2  | 6.6 | 3.70 | 5.9  | 5.1 | 2.55 |
|  |   |                    | 19 | 11.4                             | 6.3  | 3.52 | 10.8 | 5.9  | 3.79 | 10.3 | 5.7  | 4.06 | 8.7  | 4.9 | 3.86 | 6.3  | 3.7 | 2.66 |
|  |   |                    | 22 | 12.4                             | 4.3  | 3.64 | 11.9 | 4.1  | 3.92 | 11.3 | 4.0  | 4.20 | 9.6  | 3.3 | 3.99 | 6.9  | 2.4 | 2.75 |
|  |   | 25                 | 16 | 11.0                             | 9.7  | 3.43 | 10.5 | 9.2  | 3.70 | 10.0 | 8.9  | 3.96 | 8.5  | 7.9 | 3.76 | 6.1  | 5.9 | 2.59 |
|  |   |                    | 19 | 11.8                             | 7.6  | 3.58 | 11.2 | 7.2  | 3.85 | 10.6 | 6.9  | 4.13 | 9.0  | 6.2 | 3.93 | 6.5  | 4.8 | 2.71 |
|  |   |                    | 22 | 12.9                             | 5.8  | 3.70 | 12.3 | 5.5  | 3.99 | 11.7 | 5.2  | 4.27 | 9.9  | 4.5 | 4.06 | 7.1  | 3.4 | 2.80 |
|  |   | 27                 | 16 | 11.4                             | 11.2 | 3.49 | 10.8 | 10.6 | 3.76 | 10.3 | 10.2 | 4.03 | 8.7  | 8.7 | 3.83 | 6.3  | 6.3 | 2.64 |
|  |   |                    | 19 | 12.2                             | 9.2  | 3.64 | 11.6 | 8.8  | 3.92 | 11.0 | 8.4  | 4.20 | 9.3  | 7.4 | 3.99 | 6.7  | 5.8 | 2.75 |
|  |   |                    | 22 | 13.3                             | 7.2  | 3.76 | 12.7 | 6.9  | 4.05 | 12.1 | 6.6  | 4.35 | 10.2 | 5.8 | 4.13 | 7.3  | 4.4 | 2.85 |
|  |   | 29                 | 16 | 11.5                             | 11.5 | 3.50 | 11.0 | 11.0 | 3.77 | 10.5 | 10.5 | 4.04 | 8.9  | 8.9 | 3.84 | 6.4  | 6.4 | 2.64 |
|  |   |                    | 19 | 12.3                             | 10.6 | 3.65 | 11.7 | 10.1 | 3.93 | 11.2 | 9.7  | 4.21 | 9.5  | 8.8 | 4.00 | 6.8  | 6.5 | 2.76 |
|  |   |                    | 22 | 13.5                             | 8.7  | 3.77 | 12.9 | 8.3  | 4.06 | 12.2 | 7.9  | 4.36 | 10.4 | 7.0 | 4.14 | 7.5  | 5.5 | 2.85 |
|  |   | 32                 | 16 | 11.7                             | 11.7 | 3.50 | 11.2 | 11.2 | 3.78 | 10.6 | 10.6 | 4.05 | 9.0  | 9.0 | 3.84 | 6.5  | 6.5 | 2.65 |
|  |   |                    | 19 | 12.5                             | 10.8 | 3.65 | 11.9 | 10.3 | 3.94 | 11.3 | 9.8  | 4.22 | 9.6  | 8.9 | 4.01 | 6.9  | 6.6 | 2.76 |
|  |   |                    | 22 | 13.7                             | 8.8  | 3.78 | 13.1 | 8.4  | 4.07 | 12.4 | 8.0  | 4.37 | 10.5 | 7.1 | 4.15 | 7.6  | 5.5 | 2.86 |

1-13. Capacity Table

1. Cooling Capacity Performance Data

- Combination of Single Unit
- Low Silhouette Ducted Type

TC :Cooling Capacity

SHC :Sensible Heat Capacity

IPT :Cooling Power Consumption

unit : kW

| Model                                       | Power Source  | Ambient Return Air |      | Outdoor air intake temp(°C D.B.) |      |      |      |      |      |      |      |      |      |      |      |      |      |      |
|---|---|--------------------|------|----------------------------------|------|------|------|------|------|------|------|------|------|------|------|------|------|------|
|   |   |                    |      | 25°C                             |      |      | 30°C |      |      | 35°C |      |      | 40°C |      |      | 43°C |      |      |
|   |   | DB                 | WB   | TC                               | SHC  | IPT  | TC   | SHC  | IPT  | TC   | SHC  | IPT  | TC   | SHC  | IPT  | TC   | SHC  | IPT  |
| S-60PF1E5A<br>U-60PEY2E5                    | 220V-230V-240V<br>50Hz 1phase                                     | 23                 | 16   | 7.1                              | 5.6  | 2.05 | 6.8  | 5.4  | 2.24 | 6.5  | 5.3  | 2.43 | 6.1  | 5.1  | 2.36 | 5.0  | 4.6  | 1.56 |
|   |   |                    | 19   | 7.8                              | 4.3  | 2.10 | 7.4  | 4.1  | 2.30 | 7.1  | 4.0  | 2.49 | 6.7  | 3.8  | 2.42 | 5.3  | 3.3  | 1.59 |
|   |   |                    | 22   | 8.6                              | 3.0  | 2.15 | 8.2  | 2.8  | 2.35 | 7.8  | 2.7  | 2.54 | 7.3  | 2.5  | 2.47 | 5.7  | 2.0  | 1.61 |
|   |   | 25                 | 16   | 7.1                              | 6.4  | 2.05 | 6.8  | 6.3  | 2.24 | 6.5  | 6.1  | 2.43 | 6.1  | 5.9  | 2.36 | 5.0  | 5.0  | 1.56 |
|   |   |                    | 19   | 7.8                              | 5.1  | 2.10 | 7.4  | 4.9  | 2.30 | 7.1  | 4.8  | 2.49 | 6.7  | 4.6  | 2.42 | 5.3  | 4.1  | 1.59 |
|   |   |                    | 22   | 8.6                              | 3.8  | 2.15 | 8.2  | 3.6  | 2.35 | 7.8  | 3.5  | 2.54 | 7.3  | 3.3  | 2.47 | 5.7  | 2.8  | 1.61 |
|   |   | 27                 | 16   | 7.1                              | 7.1  | 2.05 | 6.8  | 6.8  | 2.24 | 6.5  | 6.5  | 2.43 | 6.1  | 6.1  | 2.36 | 5.0  | 5.0  | 1.56 |
|   |   |                    | 19   | 7.8                              | 5.9  | 2.10 | 7.4  | 5.7  | 2.30 | 7.1  | 5.6  | 2.49 | 6.7  | 5.4  | 2.42 | 5.3  | 4.9  | 1.59 |
|   |   |                    | 22   | 8.6                              | 4.6  | 2.15 | 8.2  | 4.4  | 2.35 | 7.8  | 4.3  | 2.54 | 7.3  | 4.1  | 2.47 | 5.7  | 3.6  | 1.61 |
|   |   | 29                 | 16   | 7.1                              | 7.1  | 2.05 | 6.8  | 6.8  | 2.24 | 6.5  | 6.5  | 2.43 | 6.1  | 6.1  | 2.36 | 5.0  | 5.0  | 1.56 |
|   |   |                    | 19   | 7.8                              | 6.7  | 2.10 | 7.4  | 6.5  | 2.30 | 7.1  | 6.4  | 2.49 | 6.7  | 6.2  | 2.42 | 5.3  | 5.3  | 1.59 |
|   |   |                    | 22   | 8.6                              | 5.4  | 2.15 | 8.2  | 5.2  | 2.35 | 7.8  | 5.1  | 2.54 | 7.3  | 4.9  | 2.47 | 5.7  | 4.3  | 1.61 |
| 32  | 16  | 7.1                | 7.1  | 2.05                             | 6.8  | 6.8  | 2.24 | 6.5  | 6.5  | 2.43 | 6.1  | 6.1  | 2.36 | 5.0  | 5.0  | 1.56 |      |      |
|   | 19  | 7.8                | 7.8  | 2.10                             | 7.4  | 7.4  | 2.30 | 7.1  | 7.1  | 2.49 | 6.7  | 6.7  | 2.42 | 5.3  | 5.3  | 1.59 |      |      |
|   | 22  | 8.6                | 6.6  | 2.15                             | 8.2  | 6.4  | 2.35 | 7.8  | 6.3  | 2.54 | 7.3  | 6.1  | 2.47 | 5.7  | 5.5  | 1.61 |      |      |
| S-71PF1E5A<br>U-71PEY21E5                   | 220V-230V-240V<br>50Hz 1phase                                     | 23                 | 16   | 7.7                              | 5.9  | 2.56 | 7.4  | 5.7  | 2.79 | 7.1  | 5.6  | 3.01 | 6.7  | 5.4  | 2.55 | 5.4  | 4.8  | 1.76 |
|   |   |                    | 19   | 8.4                              | 4.5  | 2.63 | 8.1  | 4.4  | 2.86 | 7.7  | 4.2  | 3.10 | 7.2  | 4.0  | 2.61 | 5.7  | 3.4  | 1.79 |
|   |   |                    | 22   | 9.3                              | 3.3  | 2.68 | 8.9  | 3.1  | 2.92 | 8.5  | 3.0  | 3.16 | 7.9  | 2.7  | 2.67 | 6.0  | 2.1  | 1.81 |
|   |   | 25                 | 16   | 7.7                              | 6.7  | 2.56 | 7.4  | 6.5  | 2.79 | 7.1  | 6.4  | 3.01 | 6.7  | 6.2  | 2.55 | 5.4  | 5.4  | 1.76 |
|   |   |                    | 19   | 8.4                              | 5.3  | 2.63 | 8.1  | 5.2  | 2.86 | 7.7  | 5.0  | 3.10 | 7.2  | 4.8  | 2.61 | 5.7  | 4.2  | 1.79 |
|   |   |                    | 22   | 9.3                              | 4.1  | 2.68 | 8.9  | 3.9  | 2.92 | 8.5  | 3.8  | 3.16 | 7.9  | 3.5  | 2.67 | 6.0  | 2.9  | 1.81 |
|   |   | 27                 | 16   | 7.7                              | 7.5  | 2.56 | 7.4  | 7.4  | 2.79 | 7.1  | 7.1  | 3.01 | 6.7  | 6.7  | 2.55 | 5.4  | 5.4  | 1.76 |
|   |   |                    | 19   | 8.4                              | 6.1  | 2.63 | 8.1  | 6.0  | 2.86 | 7.7  | 5.8  | 3.10 | 7.2  | 5.6  | 2.61 | 5.7  | 5.0  | 1.79 |
|   |   |                    | 22   | 9.3                              | 4.9  | 2.68 | 8.9  | 4.7  | 2.92 | 8.5  | 4.6  | 3.16 | 7.9  | 4.3  | 2.67 | 6.0  | 3.7  | 1.81 |
|   |   | 29                 | 16   | 7.7                              | 7.7  | 2.56 | 7.4  | 7.4  | 2.79 | 7.1  | 7.1  | 3.01 | 6.7  | 6.7  | 2.55 | 5.4  | 5.4  | 1.76 |
|   |   |                    | 19   | 8.4                              | 6.9  | 2.63 | 8.1  | 6.8  | 2.86 | 7.7  | 6.7  | 3.10 | 7.2  | 6.5  | 2.61 | 5.7  | 5.7  | 1.79 |
|   |   |                    | 22   | 9.3                              | 5.7  | 2.68 | 8.9  | 5.5  | 2.92 | 8.5  | 5.4  | 3.16 | 7.9  | 5.1  | 2.67 | 6.0  | 4.4  | 1.81 |
| 32  | 16  | 7.7                | 7.7  | 2.56                             | 7.4  | 7.4  | 2.79 | 7.1  | 7.1  | 3.01 | 6.7  | 6.7  | 2.55 | 5.4  | 5.4  | 1.76 |      |      |
|   | 19  | 8.4                | 8.2  | 2.63                             | 8.1  | 8.0  | 2.86 | 7.7  | 7.7  | 3.10 | 7.2  | 7.2  | 2.61 | 5.7  | 5.7  | 1.79 |      |      |
|   | 22  | 9.3                | 6.9  | 2.68                             | 8.9  | 6.7  | 2.92 | 8.5  | 6.6  | 3.16 | 7.9  | 6.3  | 2.67 | 6.0  | 5.6  | 1.81 |      |      |
| S-100PF1E5A<br>U-100PEY1E5<br>(U-100PEY1E8) | 220V-230V-240V<br>50Hz 1phase<br>(380V-400V-415V<br>50Hz 3 phase) | 23                 | 16   | 11.1                             | 9.1  | 3.37 | 10.6 | 8.7  | 3.63 | 10.1 | 8.3  | 3.90 | 8.5  | 7.4  | 3.70 | 6.1  | 5.7  | 2.55 |
|   |   |                    | 19   | 11.9                             | 6.7  | 3.52 | 11.3 | 6.3  | 3.79 | 10.7 | 6.1  | 4.06 | 9.1  | 5.4  | 3.86 | 6.5  | 4.1  | 2.66 |
|   |   |                    | 22   | 13.0                             | 4.4  | 3.64 | 12.4 | 4.2  | 3.92 | 11.8 | 3.9  | 4.20 | 10.0 | 3.4  | 3.99 | 7.2  | 2.4  | 2.75 |
|   |   | 25                 | 16   | 11.5                             | 10.9 | 3.43 | 11.0 | 10.4 | 3.70 | 10.4 | 10.0 | 3.96 | 8.8  | 8.8  | 3.76 | 6.3  | 6.3  | 2.59 |
|   |   |                    | 19   | 12.3                             | 8.4  | 3.58 | 11.7 | 8.0  | 3.85 | 11.1 | 7.7  | 4.13 | 9.4  | 6.9  | 3.93 | 6.8  | 5.3  | 2.71 |
|   |   |                    | 22   | 13.5                             | 6.1  | 3.70 | 12.8 | 5.7  | 3.99 | 12.2 | 5.6  | 4.27 | 10.3 | 4.8  | 4.06 | 7.4  | 3.6  | 2.80 |
|   |   | 27                 | 16   | 11.9                             | 11.9 | 3.49 | 11.3 | 11.3 | 3.76 | 10.8 | 10.8 | 4.03 | 9.1  | 9.1  | 3.83 | 6.6  | 6.6  | 2.64 |
|   |   |                    | 19   | 12.7                             | 10.3 | 3.64 | 12.1 | 9.8  | 3.92 | 11.5 | 9.4  | 4.20 | 9.8  | 8.5  | 3.99 | 7.0  | 6.5  | 2.75 |
|   |   |                    | 22   | 13.9                             | 7.9  | 3.76 | 13.3 | 7.6  | 4.05 | 12.6 | 7.2  | 4.35 | 10.7 | 6.4  | 4.13 | 7.7  | 4.9  | 2.85 |
|   |   | 29                 | 16   | 12.1                             | 12.1 | 3.50 | 11.5 | 11.5 | 3.77 | 10.9 | 10.9 | 4.04 | 9.3  | 9.3  | 3.84 | 6.7  | 6.7  | 2.64 |
|   |   |                    | 19   | 12.9                             | 12.1 | 3.65 | 12.3 | 11.6 | 3.93 | 11.7 | 11.1 | 4.21 | 9.9  | 9.9  | 4.00 | 7.1  | 7.1  | 2.76 |
|   |   |                    | 22   | 14.1                             | 9.8  | 3.77 | 13.5 | 9.3  | 4.06 | 12.8 | 8.9  | 4.36 | 10.9 | 7.9  | 4.14 | 7.8  | 6.1  | 2.85 |
| 32  | 16  | 12.3               | 12.3 | 3.50                             | 11.7 | 11.7 | 3.78 | 11.1 | 11.1 | 4.05 | 9.4  | 9.4  | 3.84 | 6.8  | 6.8  | 2.65 |      |      |
|   | 19  | 13.1               | 12.3 | 3.65                             | 12.5 | 11.8 | 3.94 | 11.8 | 11.2 | 4.22 | 10.1 | 10.1 | 4.01 | 7.2  | 7.2  | 2.76 |      |      |
|   | 22  | 14.3               | 9.9  | 3.78                             | 13.7 | 9.5  | 4.07 | 13.0 | 9.0  | 4.37 | 11.0 | 8.0  | 4.15 | 7.9  | 6.2  | 2.86 |      |      |
| S-125PF1E5A<br>U-125PEY1E5<br>(U-125PEY1E8) | 220V-230V-240V<br>50Hz 1phase<br>(380V-400V-415V<br>50Hz 3 phase) | 23                 | 16   | 12.5                             | 9.3  | 4.02 | 12.2 | 9.2  | 4.33 | 11.8 | 8.9  | 4.64 | 9.5  | 7.5  | 4.41 | 7.2  | 6.1  | 3.04 |
|   |   |                    | 19   | 13.4                             | 7.1  | 4.19 | 13.0 | 7.0  | 4.51 | 12.6 | 6.8  | 4.84 | 10.2 | 5.6  | 4.60 | 7.7  | 4.4  | 3.17 |
|   |   |                    | 22   | 14.7                             | 4.9  | 4.33 | 14.3 | 4.8  | 4.67 | 13.8 | 4.6  | 5.00 | 11.1 | 3.7  | 4.75 | 8.4  | 2.8  | 3.28 |
|   |   | 25                 | 16   | 13.0                             | 11.2 | 4.08 | 12.6 | 10.8 | 4.40 | 12.2 | 10.6 | 4.72 | 9.9  | 9.1  | 4.48 | 7.4  | 7.1  | 3.09 |
|   |   |                    | 19   | 13.8                             | 8.8  | 4.26 | 13.5 | 8.6  | 4.59 | 13.1 | 8.4  | 4.92 | 10.5 | 7.0  | 4.67 | 8.0  | 5.7  | 3.22 |
|   |   |                    | 22   | 15.2                             | 6.6  | 4.41 | 14.8 | 6.5  | 4.75 | 14.3 | 6.2  | 5.09 | 11.5 | 5.1  | 4.84 | 8.7  | 4.0  | 3.33 |
|   |   | 27                 | 16   | 13.4                             | 13.0 | 4.15 | 13.0 | 12.7 | 4.47 | 12.6 | 12.3 | 4.79 | 10.2 | 10.2 | 4.55 | 7.7  | 7.7  | 3.14 |
|   |   |                    | 19   | 14.3                             | 10.6 | 4.33 | 13.9 | 10.3 | 4.66 | 13.5 | 10.2 | 5.00 | 10.9 | 8.6  | 4.75 | 8.2  | 7.0  | 3.27 |
|   |   |                    | 22   | 15.7                             | 8.3  | 4.48 | 15.3 | 8.2  | 4.83 | 14.8 | 7.9  | 5.17 | 11.9 | 6.6  | 4.92 | 9.0  | 5.3  | 3.39 |
|   |   | 29                 | 16   | 13.6                             | 13.6 | 4.16 | 13.2 | 13.2 | 4.48 | 12.8 | 12.8 | 4.81 | 10.3 | 10.3 | 4.57 | 7.8  | 7.8  | 3.15 |
|   |   |                    | 19   | 14.5                             | 12.2 | 4.34 | 14.1 | 12.0 | 4.68 | 13.7 | 11.7 | 5.01 | 11.1 | 10.0 | 4.76 | 8.3  | 7.9  | 3.28 |
|   |   |                    | 22   | 15.9                             | 10.0 | 4.49 | 15.5 | 9.8  | 4.84 | 15.0 | 9.5  | 5.19 | 12.1 | 8.0  | 4.93 | 9.1  | 6.5  | 3.40 |
| 32  | 16  | 13.8               | 13.8 | 4.17                             | 13.4 | 13.4 | 4.49 | 13.0 | 13.0 | 4.82 | 10.5 | 10.5 | 4.58 | 7.9  | 7.9  | 3.15 |      |      |
|   | 19  | 14.7               | 12.4 | 4.35                             | 14.3 | 12.2 | 4.69 | 13.9 | 11.9 | 5.02 | 11.2 | 10.1 | 4.77 | 8.5  | 8.1  | 3.29 |      |      |
|   | 22  | 16.2               | 10.2 | 4.50                             | 15.7 | 9.9  | 4.85 | 15.2 | 9.6  | 5.20 | 12.3 | 8.2  | 4.94 | 9.3  | 6.6  | 3.40 |      |      |
| S-140PF1E5A<br>U-140PEY1E8                  | 220V-230V-240V<br>50Hz 1phase<br>(380V-400V-415V<br>50Hz 3 phase) | 23                 | 16   | 14.1                             | 10.2 | 4.87 | 14.1 | 10.3 | 5.23 | 13.6 | 9.9  | 5.56 | 12.6 | 9.6  | 5.79 | 9.2  | 7.5  | 4.73 |
|   |   |                    | 19   | 15.1                             | 7.9  | 5.08 | 15.1 | 8.0  | 5.46 | 14.5 | 7.7  | 5.80 | 13.5 | 7.3  | 6.04 | 9.8  | 5.5  | 4.93 |
|   |   |                    | 22   | 16.5                             | 5.6  | 5.25 | 16.5 | 5.5  | 5.64 | 15.9 | 5.4  | 6.00 | 14.8 | 5.0  | 6.25 | 10.8 | 3.6  | 5.10 |
|   |   | 25                 | 16   | 14.6                             | 12.1 | 4.95 | 14.6 | 12.1 | 5.32 | 14.0 | 11.7 | 5.66 | 13.1 | 11.5 | 5.88 | 9.5  | 8.9  | 4.81 |
|   |   |                    | 19   | 15.6                             | 9.7  | 5.16 | 15.6 | 9.7  | 5.55 | 15.0 | 9.3  | 5.90 | 13.9 | 9.0  | 6.14 | 10.2 | 7.0  | 5.02 |
|   |   |                    | 22   | 17.1                             | 7.3  | 5.34 | 17.1 | 7.3  | 5.74 | 16.4 | 7.0  | 6.11 | 15.3 | 6.7  | 6.35 | 11.2 | 5.0  | 5.19 |
|   |   | 27                 | 16   | 15.1                             | 14.0 | 5.03 | 15.1 | 14.0 | 5.41 | 14.5 | 13.6 | 5.75 | 13.5 | 13.4 | 5.98 | 9.9  | 9.9  | 4.89 |
|   |   |                    | 19   | 16.1                             | 11.5 | 5.25 | 16.1 | 11.6 | 5.64 | 15.5 | 11.2 | 6.00 | 14.4 | 10.9 | 6.24 | 10.5 | 8.5  | 5.10 |
|   |   |                    | 22   | 17.7                             | 9.2  | 5.43 | 17.7 | 9.1  | 5.83 | 17.0 | 8.9  | 6.21 | 15.8 | 8.4  | 6.46 | 11.5 | 6.5  | 5.28 |
|   |   | 29                 | 16   | 15.3                             | 15.3 | 5.05 | 15.3 | 15.3 | 5.42 | 14.7 | 14.7 | 5.77 | 13.7 | 13.7 | 6.00 | 10.0 | 10.0 | 4.90 |
|   |   |                    | 19   | 16.4                             | 13.3 | 5.26 | 16.4 | 13.4 | 5.65 | 15.7 | 12.9 | 6.01 | 14.6 | 12.6 | 6.26 | 10.7 | 10.0 | 5.11 |
|   |   |                    | 22   | 17.9                             | 10.9 | 5.44 | 17.9 | 10.9 | 5.85 | 17.2 | 10.5 | 6.22 | 16.0 | 10.2 | 6.47 | 11.7 | 8.0  | 5.29 |
| 32  | 16  | 15.5               | 15.5 | 5.06                             | 15.5 | 15.5 | 5.43 | 14.9 | 14.9 | 5.78 | 13.9 | 13.9 | 6.01 | 10.2 | 10.2 | 4.91 |      |      |
|   | 19  | 16.6               | 13.5 | 5.28                             | 16.6 | 13.6 | 5.67 | 16.0 | 13.1 | 6.03 | 14.8 | 12.8 | 6.27 | 10.9 | 10.2 | 5.13 |      |      |
|   | 22  | 18.2               | 11.0 | 5.46                             | 18.2 | 11.1 | 5.86 | 17.5 | 10.7 | 6.24 | 16.3 | 10.4 | 6.49 | 11.9 | 8.1  | 5.30 |      |      |

1-13. Capacity Table

1. Cooling Capacity Performance Data

TC :Cooling Capacity

SHC :Sensible Heat Capacity

IPT :Cooling Power Consumption

• Combination of Multiple Unit

Low Silhouette Ducted Type

unit : kW

| Model  | Power Source  | Ambient Return Air                           |   | Outdoor air intake temp(°C D.B.) |      |      |      |      |      |      |      |      |      |      |      |      |      |      |     |      |
|--|---|--|---|----------------------------------|------|------|------|------|------|------|------|------|------|------|------|------|------|------|-----|------|
|  |   |  |   | 25°C                             |      |      | 30°C |      |      | 35°C |      |      | 40°C |      |      | 43°C |      |      |     |      |
|  |   | DB   | WB  | TC                               | SHC  | IPT  | TC   | SHC  | IPT  | TC   | SHC  | IPT  | TC   | SHC  | IPT  | TC   | SHC  | IPT  |     |      |
| S-50PF1E5A×2<br>U-100PEY1E5<br>(U-100PEY1E8) | 220V-230V-240V<br>50Hz 1phase<br>(380V-400V-415V<br>50Hz 3 phase) | 23   | 16  | 11.1                             | 8.9  | 3.37 | 10.6 | 8.5  | 3.63 | 10.1 | 8.2  | 3.90 | 8.5  | 7.2  | 3.70 | 6.1  | 5.6  | 2.55 |     |      |
|  |   |  | 19  | 11.9                             | 6.7  | 3.52 | 11.3 | 6.3  | 3.79 | 10.7 | 6.0  | 4.06 | 9.1  | 5.3  | 3.86 | 6.5  | 4.0  | 2.66 |     |      |
|  |   |  | 22  | 13.0                             | 4.4  | 3.64 | 12.4 | 4.2  | 3.92 | 11.8 | 3.9  | 4.20 | 10.0 | 3.4  | 3.99 | 7.2  | 2.4  | 2.75 |     |      |
|  |   | 25   | 16  | 11.5                             | 10.7 | 3.43 | 11.0 | 10.2 | 3.70 | 10.4 | 9.8  | 3.96 | 8.8  | 8.8  | 3.76 | 6.3  | 6.3  | 2.59 |     |      |
|  |   |  | 19  | 12.3                             | 8.3  | 3.58 | 11.7 | 7.9  | 3.85 | 11.1 | 7.5  | 4.13 | 9.4  | 6.8  | 3.93 | 6.8  | 5.3  | 2.71 |     |      |
|  |   |  | 22  | 13.5                             | 6.1  | 3.70 | 12.8 | 5.7  | 3.99 | 12.2 | 5.5  | 4.27 | 10.3 | 4.8  | 4.06 | 7.4  | 3.5  | 2.80 |     |      |
|  |   | 27   | 16  | 11.9                             | 11.9 | 3.49 | 11.3 | 11.3 | 3.76 | 10.8 | 10.8 | 4.03 | 9.1  | 9.1  | 3.83 | 6.6  | 6.6  | 2.64 |     |      |
|  |   |  | 19  | 12.7                             | 10.2 | 3.64 | 12.1 | 9.7  | 3.92 | 11.5 | 9.3  | 4.20 | 9.8  | 8.4  | 3.99 | 7.0  | 6.5  | 2.75 |     |      |
|  |   |  | 22  | 13.9                             | 7.8  | 3.76 | 13.3 | 7.5  | 4.05 | 12.6 | 7.2  | 4.35 | 10.7 | 6.3  | 4.13 | 7.7  | 4.9  | 2.85 |     |      |
|  |   | 29   | 16  | 12.1                             | 12.1 | 3.50 | 11.5 | 11.5 | 3.77 | 10.9 | 10.9 | 4.04 | 9.3  | 9.3  | 3.84 | 6.7  | 6.7  | 2.64 |     |      |
|  |   |  | 19  | 12.9                             | 11.9 | 3.65 | 12.3 | 11.3 | 3.93 | 11.7 | 10.9 | 4.21 | 9.9  | 9.9  | 4.00 | 7.1  | 7.1  | 2.76 |     |      |
|  |   |  | 22  | 14.1                             | 9.5  | 3.77 | 13.5 | 9.1  | 4.06 | 12.8 | 8.8  | 4.36 | 10.9 | 7.8  | 4.14 | 7.8  | 6.1  | 2.85 |     |      |
|  |   | 32   | 16  | 12.3                             | 12.3 | 3.50 | 11.7 | 11.7 | 3.78 | 11.1 | 11.1 | 4.05 | 9.4  | 9.4  | 3.84 | 6.8  | 6.8  | 2.65 |     |      |
|  |   |  | 19  | 13.1                             | 12.1 | 3.65 | 12.5 | 11.5 | 3.94 | 11.8 | 11.0 | 4.22 | 10.1 | 10.1 | 4.01 | 7.2  | 7.2  | 2.76 |     |      |
|  |   |  | 22  | 14.3                             | 9.6  | 3.78 | 13.7 | 9.2  | 4.07 | 13.0 | 8.9  | 4.37 | 11.0 | 7.9  | 4.15 | 7.9  | 6.1  | 2.86 |     |      |
|  |   | S-60PF1E5A×2<br>U-125PEY1E5<br>(U-125PEY1E8) | 220V-230V-240V<br>50Hz 1phase<br>(380V-400V-415V<br>50Hz 3 phase) | 23                               | 16   | 12.5 | 10.4 | 4.02 | 12.2 | 10.1 | 4.33 | 11.8 | 9.8  | 4.64 | 9.5  | 8.4  | 4.41 | 7.2  | 6.8 | 3.04 |
|  |   |  |   |                                  | 19   | 13.4 | 7.6  | 4.19 | 13.0 | 7.4  | 4.51 | 12.6 | 7.2  | 4.84 | 10.2 | 6.0  | 4.60 | 7.7  | 4.9 | 3.17 |
|  |   |  |   |                                  | 22   | 14.7 | 4.9  | 4.33 | 14.3 | 4.7  | 4.67 | 13.8 | 4.6  | 5.00 | 11.1 | 3.7  | 4.75 | 8.4  | 2.8 | 3.28 |
| 25   | 16  |  |   | 13.0                             | 12.5 | 4.08 | 12.6 | 12.1 | 4.40 | 12.2 | 11.8 | 4.72 | 9.9  | 9.9  | 4.48 | 7.4  | 7.4  | 3.09 |     |      |
|  | 19  |  |   | 13.8                             | 9.6  | 4.26 | 13.5 | 9.4  | 4.59 | 13.1 | 9.1  | 4.92 | 10.5 | 7.7  | 4.67 | 8.0  | 6.4  | 3.22 |     |      |
|  | 22  |  |   | 15.2                             | 7.0  | 4.41 | 14.8 | 6.7  | 4.75 | 14.3 | 6.5  | 5.09 | 11.5 | 5.4  | 4.84 | 8.7  | 4.3  | 3.33 |     |      |
| 27   | 16  |  |   | 13.4                             | 13.4 | 4.15 | 13.0 | 13.0 | 4.47 | 12.6 | 12.6 | 4.79 | 10.2 | 10.2 | 4.55 | 7.7  | 7.7  | 3.14 |     |      |
|  | 19  |  |   | 14.3                             | 11.8 | 4.33 | 13.9 | 11.5 | 4.66 | 13.5 | 11.2 | 5.00 | 10.9 | 9.6  | 4.75 | 8.2  | 7.7  | 3.27 |     |      |
|  | 22  |  |   | 15.7                             | 9.1  | 4.48 | 15.3 | 8.7  | 4.83 | 14.8 | 8.6  | 5.17 | 11.9 | 7.2  | 4.92 | 9.0  | 5.8  | 3.39 |     |      |
| 29   | 16  |  |   | 13.6                             | 13.6 | 4.16 | 13.2 | 13.2 | 4.48 | 12.8 | 12.8 | 4.81 | 10.3 | 10.3 | 4.57 | 7.8  | 7.8  | 3.15 |     |      |
|  | 19  |  |   | 14.5                             | 13.8 | 4.34 | 14.1 | 13.4 | 4.68 | 13.7 | 13.2 | 5.01 | 11.1 | 11.1 | 4.76 | 8.3  | 8.3  | 3.28 |     |      |
|  | 22  |  |   | 15.9                             | 11.2 | 4.49 | 15.5 | 10.8 | 4.84 | 15.0 | 10.5 | 5.19 | 12.1 | 8.9  | 4.93 | 9.1  | 7.3  | 3.40 |     |      |
| 32   | 16  |  |   | 13.8                             | 13.8 | 4.17 | 13.4 | 13.4 | 4.49 | 13.0 | 13.0 | 4.82 | 10.5 | 10.5 | 4.58 | 7.9  | 7.9  | 3.15 |     |      |
|  | 19  |  |   | 14.7                             | 14.0 | 4.35 | 14.3 | 13.6 | 4.69 | 13.9 | 13.3 | 5.02 | 11.2 | 11.2 | 4.77 | 8.5  | 8.5  | 3.29 |     |      |
|  | 22  |  |   | 16.2                             | 11.4 | 4.50 | 15.7 | 11.0 | 4.85 | 15.2 | 10.7 | 5.20 | 12.3 | 9.1  | 4.94 | 9.3  | 7.5  | 3.40 |     |      |
| S-71PF1E5A×2<br>U-140PEY1E8                  | 220V-230V-240V<br>50Hz 1phase<br>(380V-400V-415V<br>50Hz 3 phase) |  |   | 23                               | 16   | 14.1 | 11.0 | 4.87 | 14.1 | 11.0 | 5.23 | 13.6 | 10.8 | 5.56 | 12.6 | 10.4 | 5.79 | 9.2  | 8.2 | 4.73 |
|  |   |  |   |                                  | 19   | 15.1 | 8.2  | 5.08 | 15.1 | 8.3  | 5.46 | 14.5 | 8.0  | 5.80 | 13.5 | 7.7  | 6.04 | 9.8  | 5.9 | 4.93 |
|  |   |  |   |                                  | 22   | 16.5 | 5.5  | 5.25 | 16.5 | 5.5  | 5.64 | 15.9 | 5.3  | 6.00 | 14.8 | 4.9  | 6.25 | 10.8 | 3.6 | 5.10 |
|  |   | 25   | 16  | 14.6                             | 13.1 | 4.95 | 14.6 | 13.2 | 5.32 | 14.0 | 12.9 | 5.66 | 13.1 | 12.6 | 5.88 | 9.5  | 9.3  | 4.81 |     |      |
|  |   |  | 19  | 15.6                             | 10.4 | 5.16 | 15.6 | 10.3 | 5.55 | 15.0 | 10.0 | 5.90 | 13.9 | 9.7  | 6.14 | 10.2 | 7.6  | 5.02 |     |      |
|  |   |  | 22  | 17.1                             | 7.5  | 5.34 | 17.1 | 7.6  | 5.74 | 16.4 | 7.3  | 6.11 | 15.3 | 6.9  | 6.35 | 11.2 | 5.3  | 5.19 |     |      |
|  |   | 27   | 16  | 15.1                             | 15.1 | 5.03 | 15.1 | 15.1 | 5.41 | 14.5 | 14.5 | 5.75 | 13.5 | 13.5 | 5.98 | 9.9  | 9.9  | 4.89 |     |      |
|  |   |  | 19  | 16.1                             | 12.5 | 5.25 | 16.1 | 12.6 | 5.64 | 15.5 | 12.2 | 6.00 | 14.4 | 11.9 | 6.24 | 10.5 | 9.4  | 5.10 |     |      |
|  |   |  | 22  | 17.7                             | 9.7  | 5.43 | 17.7 | 9.7  | 5.83 | 17.0 | 9.4  | 6.21 | 15.8 | 9.0  | 6.46 | 11.5 | 7.0  | 5.28 |     |      |
|  |   | 29   | 16  | 15.3                             | 15.3 | 5.05 | 15.3 | 15.3 | 5.42 | 14.7 | 14.7 | 5.77 | 13.7 | 13.7 | 6.00 | 10.0 | 10.0 | 4.90 |     |      |
|  |   |  | 19  | 16.4                             | 14.6 | 5.26 | 16.4 | 14.7 | 5.65 | 15.7 | 14.1 | 6.01 | 14.6 | 13.9 | 6.26 | 10.7 | 10.4 | 5.11 |     |      |
|  |   |  | 22  | 17.9                             | 11.7 | 5.44 | 17.9 | 11.8 | 5.85 | 17.2 | 11.5 | 6.22 | 16.0 | 11.2 | 6.47 | 11.7 | 8.8  | 5.29 |     |      |
|  |   | 32   | 16  | 15.5                             | 15.5 | 5.06 | 15.5 | 15.5 | 5.43 | 14.9 | 14.9 | 5.78 | 13.9 | 13.9 | 6.01 | 10.2 | 10.2 | 4.91 |     |      |
|  |   |  | 19  | 16.6                             | 14.7 | 5.28 | 16.6 | 14.8 | 5.67 | 16.0 | 14.4 | 6.03 | 14.8 | 14.1 | 6.27 | 10.9 | 10.6 | 5.13 |     |      |
|  |   |  | 22  | 18.2                             | 11.9 | 5.46 | 18.2 | 12.0 | 5.86 | 17.5 | 11.7 | 6.24 | 16.3 | 11.4 | 6.49 | 11.9 | 8.9  | 5.30 |     |      |

1-13. Capacity Table

1. Cooling Capacity Performance Data

• Combination of Single Unit

Ducted Type

TC :Cooling Capacity

SHC :Sensible Heat Capacity

IPT :Cooling Power Consumption

unit : kW

| Model                                       | Power Source  | Ambient Return Air |      | Outdoor air intake temp(°C D.B.) |      |      |      |      |      |      |      |      |      |      |      |      |      |      |
|---|---|--------------------|------|----------------------------------|------|------|------|------|------|------|------|------|------|------|------|------|------|------|
|   |   |                    |      | 25°C                             |      |      | 30°C |      |      | 35°C |      |      | 40°C |      |      | 43°C |      |      |
|   |   |                    |      | DB                               | WB   | TC   | SHC  | IPT  | TC   | SHC  | IPT  | TC   | SHC  | IPT  | TC   | SHC  | IPT  | TC   |
| S-60PN1E5A<br>U-60PEY2E5                    | 220V-230V-240V<br>50Hz 1phase                                     | 23                 | 16   | 7.1                              | 5.4  | 2.10 | 6.8  | 5.3  | 2.29 | 6.5  | 5.2  | 2.48 | 6.1  | 5.0  | 2.41 | 5.0  | 4.5  | 1.60 |
|   |   |                    | 19   | 7.8                              | 4.1  | 2.15 | 7.4  | 4.0  | 2.35 | 7.1  | 3.8  | 2.55 | 6.7  | 3.7  | 2.48 | 5.3  | 3.1  | 1.62 |
|   |   |                    | 22   | 8.6                              | 2.8  | 2.20 | 8.2  | 2.7  | 2.40 | 7.8  | 2.5  | 2.60 | 7.3  | 2.4  | 2.52 | 5.7  | 1.8  | 1.65 |
|   |   | 25                 | 16   | 7.1                              | 6.3  | 2.10 | 6.8  | 6.1  | 2.29 | 6.5  | 6.0  | 2.48 | 6.1  | 5.8  | 2.41 | 5.0  | 5.0  | 1.60 |
|   |   |                    | 19   | 7.8                              | 4.9  | 2.15 | 7.4  | 4.8  | 2.35 | 7.1  | 4.6  | 2.55 | 6.7  | 4.5  | 2.48 | 5.3  | 3.9  | 1.62 |
|   |   |                    | 22   | 8.6                              | 3.6  | 2.20 | 8.2  | 3.5  | 2.40 | 7.8  | 3.3  | 2.60 | 7.3  | 3.1  | 2.52 | 5.7  | 2.6  | 1.65 |
|   |   | 27                 | 16   | 7.1                              | 7.1  | 2.10 | 6.8  | 6.8  | 2.29 | 6.5  | 6.5  | 2.48 | 6.1  | 6.1  | 2.41 | 5.0  | 5.0  | 1.60 |
|   |   |                    | 19   | 7.8                              | 5.8  | 2.15 | 7.4  | 5.6  | 2.35 | 7.1  | 5.4  | 2.55 | 6.7  | 5.3  | 2.48 | 5.3  | 4.7  | 1.62 |
|   |   |                    | 22   | 8.6                              | 4.4  | 2.20 | 8.2  | 4.3  | 2.40 | 7.8  | 4.1  | 2.60 | 7.3  | 4.0  | 2.52 | 5.7  | 3.4  | 1.65 |
|   |   | 29                 | 16   | 7.1                              | 7.1  | 2.10 | 6.8  | 6.8  | 2.29 | 6.5  | 6.5  | 2.48 | 6.1  | 6.1  | 2.41 | 5.0  | 5.0  | 1.60 |
|   |   |                    | 19   | 7.8                              | 6.5  | 2.15 | 7.4  | 6.4  | 2.35 | 7.1  | 6.2  | 2.55 | 6.7  | 6.1  | 2.48 | 5.3  | 5.3  | 1.62 |
|   |   |                    | 22   | 8.6                              | 5.2  | 2.20 | 8.2  | 5.1  | 2.40 | 7.8  | 4.9  | 2.60 | 7.3  | 4.7  | 2.52 | 5.7  | 4.2  | 1.65 |
| 32  | 16  | 7.1                | 7.1  | 2.10                             | 6.8  | 6.8  | 2.29 | 6.5  | 6.5  | 2.48 | 6.1  | 6.1  | 2.41 | 5.0  | 5.0  | 1.60 |      |      |
|   | 19  | 7.8                | 7.8  | 2.15                             | 7.4  | 7.4  | 2.35 | 7.1  | 7.1  | 2.55 | 6.7  | 6.7  | 2.48 | 5.3  | 5.3  | 1.62 |      |      |
|   | 22  | 8.6                | 6.4  | 2.20                             | 8.2  | 6.3  | 2.40 | 7.8  | 6.1  | 2.60 | 7.3  | 6.0  | 2.52 | 5.7  | 5.7  | 1.65 |      |      |
| S-71PN1E5A<br>U-71PEY21E5                   | 220V-230V-240V<br>50Hz 1phase                                     | 23                 | 16   | 7.7                              | 5.7  | 2.56 | 7.4  | 5.6  | 2.79 | 7.1  | 5.4  | 3.01 | 6.7  | 5.3  | 2.55 | 5.4  | 4.7  | 1.76 |
|   |   |                    | 19   | 8.4                              | 4.4  | 2.63 | 8.1  | 4.3  | 2.86 | 7.7  | 4.1  | 3.10 | 7.2  | 3.9  | 2.61 | 5.7  | 3.3  | 1.79 |
|   |   |                    | 22   | 9.3                              | 3.1  | 2.68 | 8.9  | 2.9  | 2.92 | 8.5  | 2.8  | 3.16 | 7.9  | 2.6  | 2.67 | 6.0  | 1.9  | 1.81 |
|   |   | 25                 | 16   | 7.7                              | 6.6  | 2.56 | 7.4  | 6.4  | 2.79 | 7.1  | 6.3  | 3.01 | 6.7  | 6.1  | 2.55 | 5.4  | 5.4  | 1.76 |
|   |   |                    | 19   | 8.4                              | 5.2  | 2.63 | 8.1  | 5.1  | 2.86 | 7.7  | 4.9  | 3.10 | 7.2  | 4.7  | 2.61 | 5.7  | 4.1  | 1.79 |
|   |   |                    | 22   | 9.3                              | 3.9  | 2.68 | 8.9  | 3.7  | 2.92 | 8.5  | 3.6  | 3.16 | 7.9  | 3.4  | 2.67 | 6.0  | 2.7  | 1.81 |
|   |   | 27                 | 16   | 7.7                              | 7.4  | 2.56 | 7.4  | 7.2  | 2.79 | 7.1  | 7.1  | 3.01 | 6.7  | 6.7  | 2.55 | 5.4  | 5.4  | 1.76 |
|   |   |                    | 19   | 8.4                              | 6.0  | 2.63 | 8.1  | 5.9  | 2.86 | 7.7  | 5.7  | 3.10 | 7.2  | 5.5  | 2.61 | 5.7  | 4.9  | 1.79 |
|   |   |                    | 22   | 9.3                              | 4.7  | 2.68 | 8.9  | 4.5  | 2.92 | 8.5  | 4.4  | 3.16 | 7.9  | 4.2  | 2.67 | 6.0  | 3.5  | 1.81 |
|   |   | 29                 | 16   | 7.7                              | 7.7  | 2.56 | 7.4  | 7.4  | 2.79 | 7.1  | 7.1  | 3.01 | 6.7  | 6.7  | 2.55 | 5.4  | 5.4  | 1.76 |
|   |   |                    | 19   | 8.4                              | 6.8  | 2.63 | 8.1  | 6.7  | 2.86 | 7.7  | 6.5  | 3.10 | 7.2  | 6.3  | 2.61 | 5.7  | 5.7  | 1.79 |
|   |   |                    | 22   | 9.3                              | 5.5  | 2.68 | 8.9  | 5.3  | 2.92 | 8.5  | 5.2  | 3.16 | 7.9  | 5.0  | 2.67 | 6.0  | 4.3  | 1.81 |
| 32  | 16  | 7.7                | 7.7  | 2.56                             | 7.4  | 7.4  | 2.79 | 7.1  | 7.1  | 3.01 | 6.7  | 6.7  | 2.55 | 5.4  | 5.4  | 1.76 |      |      |
|   | 19  | 8.4                | 8.0  | 2.63                             | 8.1  | 7.9  | 2.86 | 7.7  | 7.7  | 3.10 | 7.2  | 7.2  | 2.61 | 5.7  | 5.7  | 1.79 |      |      |
|   | 22  | 9.3                | 6.7  | 2.68                             | 8.9  | 6.6  | 2.92 | 8.5  | 6.4  | 3.16 | 7.9  | 6.2  | 2.67 | 6.0  | 5.5  | 1.81 |      |      |
| S-100PN1E5A<br>U-100PEY1E5<br>(U-100PEY1E8) | 220V-230V-240V<br>50Hz 1phase<br>(380V-400V-415V<br>50Hz 3 phase) | 23                 | 16   | 11.1                             | 8.9  | 3.45 | 10.6 | 8.5  | 3.72 | 10.1 | 8.2  | 3.99 | 8.5  | 7.2  | 3.79 | 6.1  | 5.6  | 2.61 |
|   |   |                    | 19   | 11.9                             | 6.7  | 3.60 | 11.3 | 6.3  | 3.88 | 10.7 | 6.1  | 4.16 | 9.1  | 5.4  | 3.95 | 6.5  | 4.0  | 2.72 |
|   |   |                    | 22   | 13.0                             | 4.5  | 3.73 | 12.4 | 4.3  | 4.01 | 11.8 | 4.0  | 4.30 | 10.0 | 3.5  | 4.09 | 7.2  | 2.5  | 2.82 |
|   |   | 25                 | 16   | 11.5                             | 10.7 | 3.51 | 11.0 | 10.2 | 3.78 | 10.4 | 9.8  | 4.06 | 8.8  | 8.7  | 3.85 | 6.3  | 6.3  | 2.66 |
|   |   |                    | 19   | 12.3                             | 8.3  | 3.66 | 11.7 | 7.9  | 3.95 | 11.1 | 7.7  | 4.23 | 9.4  | 6.8  | 4.02 | 6.8  | 5.3  | 2.77 |
|   |   |                    | 22   | 13.5                             | 6.2  | 3.79 | 12.8 | 5.9  | 4.08 | 12.2 | 5.6  | 4.38 | 10.3 | 4.8  | 4.16 | 7.4  | 3.6  | 2.87 |
|   |   | 27                 | 16   | 11.9                             | 11.9 | 3.57 | 11.3 | 11.3 | 3.85 | 10.8 | 10.8 | 4.12 | 9.1  | 9.1  | 3.92 | 6.6  | 6.6  | 2.70 |
|   |   |                    | 19   | 12.7                             | 10.2 | 3.72 | 12.1 | 9.7  | 4.01 | 11.5 | 9.3  | 4.30 | 9.8  | 8.4  | 4.09 | 7.0  | 6.5  | 2.82 |
|   |   |                    | 22   | 13.9                             | 7.9  | 3.85 | 13.3 | 7.6  | 4.15 | 12.6 | 7.2  | 4.45 | 10.7 | 6.3  | 4.23 | 7.7  | 4.9  | 2.91 |
|   |   | 29                 | 16   | 12.1                             | 12.1 | 3.58 | 11.5 | 11.5 | 3.86 | 10.9 | 10.9 | 4.13 | 9.3  | 9.3  | 3.93 | 6.7  | 6.7  | 2.71 |
|   |   |                    | 19   | 12.9                             | 11.9 | 3.73 | 12.3 | 11.3 | 4.02 | 11.7 | 10.9 | 4.31 | 9.9  | 9.8  | 4.10 | 7.1  | 7.1  | 2.82 |
|   |   |                    | 22   | 14.1                             | 9.5  | 3.86 | 13.5 | 9.1  | 4.16 | 12.8 | 8.8  | 4.46 | 10.9 | 7.8  | 4.24 | 7.8  | 6.1  | 2.92 |
| 32  | 16  | 12.3               | 12.3 | 3.59                             | 11.7 | 11.7 | 3.86 | 11.1 | 11.1 | 4.14 | 9.4  | 9.4  | 3.94 | 6.8  | 6.8  | 2.71 |      |      |
|   | 19  | 13.1               | 12.1 | 3.74                             | 12.5 | 11.5 | 4.03 | 11.8 | 11.0 | 4.32 | 10.1 | 10.0 | 4.11 | 7.2  | 7.2  | 2.83 |      |      |
|   | 22  | 14.3               | 9.6  | 3.87                             | 13.7 | 9.2  | 4.17 | 13.0 | 8.9  | 4.47 | 11.0 | 7.9  | 4.25 | 7.9  | 6.1  | 2.93 |      |      |
| S-125PN1E5A<br>U-125PEY1E5<br>(U-125PEY1E8) | 220V-230V-240V<br>50Hz 1phase<br>(380V-400V-415V<br>50Hz 3 phase) | 23                 | 16   | 12.5                             | 9.6  | 4.18 | 12.2 | 9.3  | 4.50 | 11.8 | 9.0  | 4.82 | 9.5  | 7.7  | 4.58 | 7.2  | 6.2  | 3.16 |
|   |   |                    | 19   | 13.4                             | 7.3  | 4.36 | 13.0 | 7.1  | 4.69 | 12.6 | 6.9  | 5.03 | 10.2 | 5.8  | 4.78 | 7.7  | 4.6  | 3.29 |
|   |   |                    | 22   | 14.7                             | 5.0  | 4.51 | 14.3 | 4.9  | 4.86 | 13.8 | 4.7  | 5.20 | 11.1 | 3.8  | 4.95 | 8.4  | 2.9  | 3.41 |
|   |   | 25                 | 16   | 13.0                             | 11.3 | 4.25 | 12.6 | 11.1 | 4.57 | 12.2 | 10.8 | 4.90 | 9.9  | 9.3  | 4.66 | 7.4  | 7.2  | 3.21 |
|   |   |                    | 19   | 13.8                             | 8.9  | 4.43 | 13.5 | 8.8  | 4.77 | 13.1 | 8.6  | 5.12 | 10.5 | 7.2  | 4.86 | 8.0  | 5.8  | 3.35 |
|   |   |                    | 22   | 15.2                             | 6.7  | 4.58 | 14.8 | 6.6  | 4.94 | 14.3 | 6.3  | 5.29 | 11.5 | 5.2  | 5.03 | 8.7  | 4.1  | 3.47 |
|   |   | 27                 | 16   | 13.4                             | 13.2 | 4.32 | 13.0 | 12.9 | 4.65 | 12.6 | 12.6 | 4.99 | 10.2 | 10.2 | 4.74 | 7.7  | 7.7  | 3.26 |
|   |   |                    | 19   | 14.3                             | 10.8 | 4.50 | 13.9 | 10.5 | 4.85 | 13.5 | 10.3 | 5.20 | 10.9 | 8.7  | 4.94 | 8.2  | 7.1  | 3.41 |
|   |   |                    | 22   | 15.7                             | 8.6  | 4.66 | 15.3 | 8.3  | 5.02 | 14.8 | 8.1  | 5.38 | 11.9 | 6.7  | 5.11 | 9.0  | 5.4  | 3.52 |
|   |   | 29                 | 16   | 13.6                             | 13.6 | 4.33 | 13.2 | 13.2 | 4.66 | 12.8 | 12.8 | 5.00 | 10.3 | 10.3 | 4.75 | 7.8  | 7.8  | 3.27 |
|   |   |                    | 19   | 14.5                             | 12.5 | 4.51 | 14.1 | 12.1 | 4.86 | 13.7 | 11.9 | 5.21 | 11.1 | 10.2 | 4.95 | 8.3  | 8.0  | 3.41 |
|   |   |                    | 22   | 15.9                             | 10.2 | 4.67 | 15.5 | 9.9  | 5.03 | 15.0 | 9.7  | 5.39 | 12.1 | 8.1  | 5.12 | 9.1  | 6.6  | 3.53 |
| 32  | 16  | 13.8               | 13.8 | 4.34                             | 13.4 | 13.4 | 4.67 | 13.0 | 13.0 | 5.01 | 10.5 | 10.5 | 4.76 | 7.9  | 7.9  | 3.28 |      |      |
|   | 19  | 14.7               | 12.6 | 4.52                             | 14.3 | 12.3 | 4.88 | 13.9 | 12.1 | 5.23 | 11.2 | 10.3 | 4.97 | 8.5  | 8.2  | 3.42 |      |      |
|   | 22  | 16.2               | 10.4 | 4.68                             | 15.7 | 10.0 | 5.04 | 15.2 | 9.9  | 5.41 | 12.3 | 8.3  | 5.14 | 9.3  | 6.8  | 3.54 |      |      |
| S-140PN1E5A<br>U-140PEY1E8                  | 220V-230V-240V<br>50Hz 1phase<br>(380V-400V-415V<br>50Hz 3 phase) | 23                 | 16   | 14.1                             | 10.4 | 4.87 | 14.1 | 10.5 | 5.23 | 13.6 | 10.1 | 5.56 | 12.6 | 9.8  | 5.79 | 9.2  | 7.7  | 4.73 |
|   |   |                    | 19   | 15.1                             | 8.0  | 5.08 | 15.1 | 8.1  | 5.46 | 14.5 | 7.8  | 5.80 | 13.5 | 7.4  | 6.04 | 9.8  | 5.6  | 4.93 |
|   |   |                    | 22   | 16.5                             | 5.7  | 5.25 | 16.5 | 5.6  | 5.64 | 15.9 | 5.5  | 6.00 | 14.8 | 5.1  | 6.25 | 10.8 | 3.7  | 5.10 |
|   |   | 25                 | 16   | 14.6                             | 12.3 | 4.95 | 14.6 | 12.4 | 5.32 | 14.0 | 11.9 | 5.66 | 13.1 | 11.7 | 5.88 | 9.5  | 9.0  | 4.81 |
|   |   |                    | 19   | 15.6                             | 9.8  | 5.16 | 15.6 | 9.9  | 5.55 | 15.0 | 9.5  | 5.90 | 13.9 | 9.2  | 6.14 | 10.2 | 7.2  | 5.02 |
|   |   |                    | 22   | 17.1                             | 7.4  | 5.34 | 17.1 | 7.5  | 5.74 | 16.4 | 7.1  | 6.11 | 15.3 | 6.8  | 6.35 | 11.2 | 5.2  | 5.19 |
|   |   | 27                 | 16   | 15.1                             | 14.2 | 5.03 | 15.1 | 14.3 | 5.41 | 14.5 | 13.9 | 5.75 | 13.5 | 13.5 | 5.98 | 9.9  | 9.9  | 4.89 |
|   |   |                    | 19   | 16.1                             | 11.7 | 5.25 | 16.1 | 11.8 | 5.64 | 15.5 | 11.4 | 6.00 | 14.4 | 11.1 | 6.24 | 10.5 | 8.7  | 5.10 |
|   |   |                    | 22   | 17.7                             | 9.3  | 5.43 | 17.7 | 9.4  | 5.83 | 17.0 | 9.0  | 6.21 | 15.8 | 8.7  | 6.46 | 11.5 | 6.7  | 5.28 |
|   |   | 29                 | 16   | 15.3                             | 15.3 | 5.05 | 15.3 | 15.3 | 5.42 | 14.7 | 14.7 | 5.77 | 13.7 | 13.7 | 6.00 | 10.0 | 10.0 | 4.90 |
|   |   |                    | 19   | 16.4                             | 13.5 | 5.26 | 16.4 | 13.5 | 5.65 | 15.7 | 13.1 | 6.01 | 14.6 | 12.9 | 6.26 | 10.7 | 10.1 | 5.11 |
|   |   |                    | 22   | 17.9                             | 11.1 | 5.44 | 17.9 | 11.2 | 5.85 | 17.2 | 10.8 | 6.22 | 16.0 | 10.5 | 6.47 | 11.7 | 8.2  | 5.29 |
| 32  | 16  | 15.5               | 15.5 | 5.06                             | 15.5 | 15.5 | 5.43 | 14.9 | 14.9 | 5.78 | 13.9 | 13.9 | 6.01 | 10.2 | 10.2 | 4.91 |      |      |
|   | 19  | 16.6               | 13.7 | 5.28                             | 16.6 | 13.7 | 5.67 | 16.0 | 13.4 | 6.03 | 14.8 | 13.0 | 6.27 | 10.9 | 10.3 | 5.13 |      |      |
|   | 22  | 18.2               | 11.3 | 5.46                             | 18.2 | 11.4 | 5.86 | 17.5 | 11.0 | 6.24 | 16.3 | 10.7 | 6.49 | 11.9 | 8.3  | 5.30 |      |      |

1-13. Capacity Table

1. Cooling Capacity Performance Data

TC :Cooling Capacity

SHC :Sensible Heat Capacity

IPT :Cooling Power Consumption

• Combination of Multiple Unit

Ducted Type

unit : kW

| Model  | Power Source  | Ambient Return Air                           |   | Outdoor air intake temp(°C D.B.) |      |      |      |      |      |      |      |      |      |      |      |      |      |      |     |      |
|--|---|--|---|----------------------------------|------|------|------|------|------|------|------|------|------|------|------|------|------|------|-----|------|
|  |   |  |   | 25°C                             |      |      | 30°C |      |      | 35°C |      |      | 40°C |      |      | 43°C |      |      |     |      |
|  |   | DB   | WB  | TC                               | SHC  | IPT  | TC   | SHC  | IPT  | TC   | SHC  | IPT  | TC   | SHC  | IPT  | TC   | SHC  | IPT  |     |      |
| S-50PN1E5A×2<br>U-100PEY1E5<br>(U-100PEY1E8) | 220V-230V-240V<br>50Hz 1phase<br>(380V-400V-415V<br>50Hz 3 phase) | 23   | 16  | 11.1                             | 8.7  | 3.45 | 10.6 | 8.4  | 3.72 | 10.1 | 8.0  | 3.99 | 8.5  | 7.1  | 3.79 | 6.1  | 5.6  | 2.61 |     |      |
|  |   |  | 19  | 11.9                             | 6.5  | 3.60 | 11.3 | 6.2  | 3.88 | 10.7 | 5.9  | 4.16 | 9.1  | 5.2  | 3.95 | 6.5  | 3.9  | 2.72 |     |      |
|  |   |  | 22  | 13.0                             | 4.4  | 3.73 | 12.4 | 4.2  | 4.01 | 11.8 | 3.9  | 4.30 | 10.0 | 3.3  | 4.09 | 7.2  | 2.4  | 2.82 |     |      |
|  |   | 25   | 16  | 11.5                             | 10.6 | 3.51 | 11.0 | 10.1 | 3.78 | 10.4 | 9.6  | 4.06 | 8.8  | 8.6  | 3.85 | 6.3  | 6.2  | 2.66 |     |      |
|  |   |  | 19  | 12.3                             | 8.2  | 3.66 | 11.7 | 7.8  | 3.95 | 11.1 | 7.4  | 4.23 | 9.4  | 6.7  | 4.02 | 6.8  | 5.2  | 2.77 |     |      |
|  |   |  | 22  | 13.5                             | 5.9  | 3.79 | 12.8 | 5.6  | 4.08 | 12.2 | 5.5  | 4.38 | 10.3 | 4.7  | 4.16 | 7.4  | 3.5  | 2.87 |     |      |
|  |   | 27   | 16  | 11.9                             | 11.9 | 3.57 | 11.3 | 11.3 | 3.85 | 10.8 | 10.8 | 4.12 | 9.1  | 9.1  | 3.92 | 6.6  | 6.6  | 2.70 |     |      |
|  |   |  | 19  | 12.7                             | 10.0 | 3.72 | 12.1 | 9.5  | 4.01 | 11.5 | 9.1  | 4.30 | 9.8  | 8.2  | 4.09 | 7.0  | 6.4  | 2.82 |     |      |
|  |   |  | 22  | 13.9                             | 7.7  | 3.85 | 13.3 | 7.3  | 4.15 | 12.6 | 7.1  | 4.45 | 10.7 | 6.2  | 4.23 | 7.7  | 4.8  | 2.91 |     |      |
|  |   | 29   | 16  | 12.1                             | 12.1 | 3.58 | 11.5 | 11.5 | 3.86 | 10.9 | 10.9 | 4.13 | 9.3  | 9.3  | 3.93 | 6.7  | 6.7  | 2.71 |     |      |
|  |   |  | 19  | 12.9                             | 11.6 | 3.73 | 12.3 | 11.1 | 4.02 | 11.7 | 10.8 | 4.31 | 9.9  | 9.7  | 4.10 | 7.1  | 7.0  | 2.82 |     |      |
|  |   |  | 22  | 14.1                             | 9.4  | 3.86 | 13.5 | 9.0  | 4.16 | 12.8 | 8.7  | 4.46 | 10.9 | 7.7  | 4.24 | 7.8  | 5.9  | 2.92 |     |      |
|  |   | 32   | 16  | 12.3                             | 12.3 | 3.59 | 11.7 | 11.7 | 3.86 | 11.1 | 11.1 | 4.14 | 9.4  | 9.4  | 3.94 | 6.8  | 6.8  | 2.71 |     |      |
|  |   |  | 19  | 13.1                             | 11.8 | 3.74 | 12.5 | 11.3 | 4.03 | 11.8 | 10.9 | 4.32 | 10.1 | 9.9  | 4.11 | 7.2  | 7.1  | 2.83 |     |      |
|  |   |  | 22  | 14.3                             | 9.5  | 3.87 | 13.7 | 9.1  | 4.17 | 13.0 | 8.8  | 4.47 | 11.0 | 7.8  | 4.25 | 7.9  | 6.0  | 2.93 |     |      |
|  |   | S-60PN1E5A×2<br>U-125PEY1E5<br>(U-125PEY1E8) | 220V-230V-240V<br>50Hz 1phase<br>(380V-400V-415V<br>50Hz 3 phase) | 23                               | 16   | 12.5 | 10.3 | 4.18 | 12.2 | 10.1 | 4.50 | 11.8 | 9.8  | 4.82 | 9.5  | 8.4  | 4.58 | 7.2  | 6.8 | 3.16 |
|  |   |  |   |                                  | 19   | 13.4 | 7.5  | 4.36 | 13.0 | 7.4  | 4.69 | 12.6 | 7.2  | 5.03 | 10.2 | 6.0  | 4.78 | 7.7  | 4.8 | 3.29 |
|  |   |  |   |                                  | 22   | 14.7 | 4.8  | 4.51 | 14.3 | 4.7  | 4.86 | 13.8 | 4.5  | 5.20 | 11.1 | 3.6  | 4.95 | 8.4  | 2.8 | 3.41 |
| 25   | 16  |  |   | 13.0                             | 12.5 | 4.25 | 12.6 | 12.2 | 4.57 | 12.2 | 11.9 | 4.90 | 9.9  | 9.9  | 4.66 | 7.4  | 7.4  | 3.21 |     |      |
|  | 19  |  |   | 13.8                             | 9.6  | 4.43 | 13.5 | 9.4  | 4.77 | 13.1 | 9.2  | 5.12 | 10.5 | 7.7  | 4.86 | 8.0  | 6.3  | 3.35 |     |      |
|  | 22  |  |   | 15.2                             | 6.9  | 4.58 | 14.8 | 6.7  | 4.94 | 14.3 | 6.5  | 5.29 | 11.5 | 5.4  | 5.03 | 8.7  | 4.2  | 3.47 |     |      |
| 27   | 16  |  |   | 13.4                             | 13.4 | 4.32 | 13.0 | 13.0 | 4.65 | 12.6 | 12.6 | 4.99 | 10.2 | 10.2 | 4.74 | 7.7  | 7.7  | 3.26 |     |      |
|  | 19  |  |   | 14.3                             | 11.7 | 4.50 | 13.9 | 11.5 | 4.85 | 13.5 | 11.2 | 5.20 | 10.9 | 9.6  | 4.94 | 8.2  | 7.7  | 3.41 |     |      |
|  | 22  |  |   | 15.7                             | 9.0  | 4.66 | 15.3 | 8.9  | 5.02 | 14.8 | 8.6  | 5.38 | 11.9 | 7.2  | 5.11 | 9.0  | 5.8  | 3.52 |     |      |
| 29   | 16  |  |   | 13.6                             | 13.6 | 4.33 | 13.2 | 13.2 | 4.66 | 12.8 | 12.8 | 5.00 | 10.3 | 10.3 | 4.75 | 7.8  | 7.8  | 3.27 |     |      |
|  | 19  |  |   | 14.5                             | 13.8 | 4.51 | 14.1 | 13.4 | 4.86 | 13.7 | 13.2 | 5.21 | 11.1 | 11.1 | 4.95 | 8.3  | 8.3  | 3.41 |     |      |
|  | 22  |  |   | 15.9                             | 11.0 | 4.67 | 15.5 | 10.8 | 5.03 | 15.0 | 10.5 | 5.39 | 12.1 | 8.9  | 5.12 | 9.1  | 7.3  | 3.53 |     |      |
| 32   | 16  |  |   | 13.8                             | 13.8 | 4.34 | 13.4 | 13.4 | 4.67 | 13.0 | 13.0 | 5.01 | 10.5 | 10.5 | 4.76 | 7.9  | 7.9  | 3.28 |     |      |
|  | 19  |  |   | 14.7                             | 14.0 | 4.52 | 14.3 | 13.6 | 4.88 | 13.9 | 13.3 | 5.23 | 11.2 | 11.2 | 4.97 | 8.5  | 8.5  | 3.42 |     |      |
|  | 22  |  |   | 16.2                             | 11.2 | 4.68 | 15.7 | 11.0 | 5.04 | 15.2 | 10.7 | 5.41 | 12.3 | 9.1  | 5.14 | 9.3  | 7.5  | 3.54 |     |      |
| S-71PN1E5A×2<br>U-140PEY1E8                  | 220V-230V-240V<br>50Hz 1phase<br>(380V-400V-415V<br>50Hz 3 phase) |  |   | 23                               | 16   | 14.1 | 11.0 | 4.87 | 14.1 | 11.0 | 5.23 | 13.6 | 10.8 | 5.56 | 12.6 | 10.4 | 5.79 | 9.2  | 8.2 | 4.73 |
|  |   |  |   |                                  | 19   | 15.1 | 8.2  | 5.08 | 15.1 | 8.3  | 5.46 | 14.5 | 8.0  | 5.80 | 13.5 | 7.7  | 6.04 | 9.8  | 5.9 | 4.93 |
|  |   |  |   |                                  | 22   | 16.5 | 5.5  | 5.25 | 16.5 | 5.5  | 5.64 | 15.9 | 5.3  | 6.00 | 14.8 | 4.9  | 6.25 | 10.8 | 3.6 | 5.10 |
|  |   | 25   | 16  | 14.6                             | 13.2 | 4.95 | 14.6 | 13.2 | 5.32 | 14.0 | 12.9 | 5.66 | 13.1 | 12.7 | 5.88 | 9.5  | 9.3  | 4.81 |     |      |
|  |   |  | 19  | 15.6                             | 10.4 | 5.16 | 15.6 | 10.4 | 5.55 | 15.0 | 10.1 | 5.90 | 13.9 | 9.7  | 6.14 | 10.2 | 7.6  | 5.02 |     |      |
|  |   |  | 22  | 17.1                             | 7.5  | 5.34 | 17.1 | 7.6  | 5.74 | 16.4 | 7.3  | 6.11 | 15.3 | 6.9  | 6.35 | 11.2 | 5.3  | 5.19 |     |      |
|  |   | 27   | 16  | 15.1                             | 15.1 | 5.03 | 15.1 | 15.1 | 5.41 | 14.5 | 14.5 | 5.75 | 13.5 | 13.5 | 5.98 | 9.9  | 9.9  | 4.89 |     |      |
|  |   |  | 19  | 16.1                             | 12.5 | 5.25 | 16.1 | 12.6 | 5.64 | 15.5 | 12.2 | 6.00 | 14.4 | 12.0 | 6.24 | 10.5 | 9.5  | 5.10 |     |      |
|  |   |  | 22  | 17.7                             | 9.8  | 5.43 | 17.7 | 9.7  | 5.83 | 17.0 | 9.5  | 6.21 | 15.8 | 9.1  | 6.46 | 11.5 | 7.0  | 5.28 |     |      |
|  |   | 29   | 16  | 15.3                             | 15.3 | 5.05 | 15.3 | 15.3 | 5.42 | 14.7 | 14.7 | 5.77 | 13.7 | 13.7 | 6.00 | 10.0 | 10.0 | 4.90 |     |      |
|  |   |  | 19  | 16.4                             | 14.7 | 5.26 | 16.4 | 14.8 | 5.65 | 15.7 | 14.2 | 6.01 | 14.6 | 14.0 | 6.26 | 10.7 | 10.5 | 5.11 |     |      |
|  |   |  | 22  | 17.9                             | 11.8 | 5.44 | 17.9 | 11.9 | 5.85 | 17.2 | 11.5 | 6.22 | 16.0 | 11.2 | 6.47 | 11.7 | 8.8  | 5.29 |     |      |
|  |   | 32   | 16  | 15.5                             | 15.5 | 5.06 | 15.5 | 15.5 | 5.43 | 14.9 | 14.9 | 5.78 | 13.9 | 13.9 | 6.01 | 10.2 | 10.2 | 4.91 |     |      |
|  |   |  | 19  | 16.6                             | 14.9 | 5.28 | 16.6 | 15.0 | 5.67 | 16.0 | 14.5 | 6.03 | 14.8 | 14.2 | 6.27 | 10.9 | 10.7 | 5.13 |     |      |
|  |   |  | 22  | 18.2                             | 12.0 | 5.46 | 18.2 | 12.1 | 5.86 | 17.5 | 11.7 | 6.24 | 16.3 | 11.4 | 6.49 | 11.9 | 8.9  | 5.30 |     |      |

## 1-13. Capacity Table

### 1. Cooling Capacity Performance Data

#### • Combination of Multiple Unit

4-Way Cassette 60×60 Type

TC :Cooling Capacity

SHC :Sensible Heat Capacity

IPT :Cooling Power Consumption

unit : kW

| Model  | Power Source  | Ambient Return Air |    | Outdoor air intake temp(°C D.B.) |      |      |      |      |      |      |      |      |      |     |      |      |     |      |
|--|---|--------------------|----|----------------------------------|------|------|------|------|------|------|------|------|------|-----|------|------|-----|------|
|  |   |                    |    | 25°C                             |      |      | 30°C |      |      | 35°C |      |      | 40°C |     |      | 43°C |     |      |
|  |   |                    |    | DB                               | WB   | TC   | SHC  | IPT  | TC   | SHC  | IPT  | TC   | SHC  | IPT | TC   | SHC  | IPT | TC   |
| S-50PY2E5A×2<br>U-100PEY1E5<br>(U-100PEY1E8) | 220V-230V-240V<br>50Hz 1phase<br>(380V-400V-415V<br>50Hz 3 phase) | 23                 | 16 | 10.6                             | 7.7  | 3.44 | 10.1 | 7.3  | 3.70 | 9.6  | 7.0  | 3.97 | 8.2  | 6.3 | 3.77 | 5.9  | 4.8 | 2.60 |
|  |   |                    | 19 | 11.4                             | 6.0  | 3.59 | 10.8 | 5.7  | 3.86 | 10.3 | 5.5  | 4.14 | 8.7  | 4.7 | 3.93 | 6.3  | 3.6 | 2.71 |
|  |   |                    | 22 | 12.4                             | 4.3  | 3.71 | 11.9 | 4.1  | 4.00 | 11.3 | 3.9  | 4.28 | 9.6  | 3.2 | 4.07 | 6.9  | 2.3 | 2.81 |
|  |   | 25                 | 16 | 11.0                             | 9.1  | 3.49 | 10.5 | 8.7  | 3.77 | 10.0 | 8.3  | 4.04 | 8.5  | 7.4 | 3.84 | 6.1  | 5.7 | 2.64 |
|  |   |                    | 19 | 11.8                             | 7.3  | 3.65 | 11.2 | 6.9  | 3.93 | 10.6 | 6.6  | 4.21 | 9.0  | 5.8 | 4.00 | 6.5  | 4.4 | 2.76 |
|  |   |                    | 22 | 12.9                             | 5.5  | 3.77 | 12.3 | 5.3  | 4.06 | 11.7 | 5.0  | 4.36 | 9.9  | 4.4 | 4.14 | 7.1  | 3.2 | 2.85 |
|  |   | 27                 | 16 | 11.4                             | 10.5 | 3.55 | 10.8 | 10.0 | 3.83 | 10.3 | 9.5  | 4.10 | 8.7  | 8.6 | 3.90 | 6.3  | 6.3 | 2.69 |
|  |   |                    | 19 | 12.2                             | 8.7  | 3.71 | 11.6 | 8.3  | 3.99 | 11.0 | 7.9  | 4.28 | 9.3  | 7.0 | 4.07 | 6.7  | 5.4 | 2.80 |
|  |   |                    | 22 | 13.3                             | 7.0  | 3.83 | 12.7 | 6.6  | 4.13 | 12.1 | 6.3  | 4.43 | 10.2 | 5.5 | 4.21 | 7.3  | 4.1 | 2.90 |
|  |   | 29                 | 16 | 11.5                             | 11.5 | 3.56 | 11.0 | 11.0 | 3.84 | 10.5 | 10.5 | 4.11 | 8.9  | 8.9 | 3.91 | 6.4  | 6.4 | 2.69 |
|  |   |                    | 19 | 12.3                             | 9.9  | 3.72 | 11.7 | 9.4  | 4.00 | 11.2 | 9.1  | 4.29 | 9.5  | 8.1 | 4.08 | 6.8  | 6.3 | 2.81 |
|  |   |                    | 22 | 13.5                             | 8.2  | 3.84 | 12.9 | 7.8  | 4.14 | 12.2 | 7.4  | 4.44 | 10.4 | 6.6 | 4.22 | 7.5  | 5.1 | 2.91 |
|  |   | 32                 | 16 | 11.7                             | 11.7 | 3.57 | 11.2 | 11.2 | 3.85 | 10.6 | 10.6 | 4.12 | 9.0  | 9.0 | 3.92 | 6.5  | 6.5 | 2.70 |
|  |   |                    | 19 | 12.5                             | 10.0 | 3.72 | 11.9 | 9.6  | 4.01 | 11.3 | 9.2  | 4.30 | 9.6  | 8.2 | 4.09 | 6.9  | 6.4 | 2.82 |
|  |   |                    | 22 | 13.7                             | 8.3  | 3.85 | 13.1 | 8.0  | 4.15 | 12.4 | 7.6  | 4.45 | 10.5 | 6.6 | 4.23 | 7.6  | 5.2 | 2.91 |

**1-13. Capacity Table**

**2. Heating Capacity Performance Data**

TC :Cooling Capacity

IPT :Cooling Power Consumption

• **Combination of Single Unit**

4-Way Cassette Type

unit : kW

| Model                                       | Power Source  | Ambient Return Air | Outdoor air intake temp(°C W.B.) |      |      |      |      |      |      |      |      |      |
|---|---|--------------------|----------------------------------|------|------|------|------|------|------|------|------|------|
|   |   |                    | -5°C                             |      | 0°C  |      | 6°C  |      | 10°C |      | 15°C |      |
|   |   |                    | TC                               | IPT  | TC   | IPT  | TC   | IPT  | TC   | IPT  | TC   | IPT  |
| S-36PU2E5A<br>U-36PE1E5A                    | 220V-230V-240V<br>50Hz 1phase                                     | 16                 | 4.4                              | 0.93 | 4.8  | 0.97 | 5.1  | 1.02 | 5.5  | 1.07 | 6.0  | 1.12 |
|   |   | 20                 | 4.3                              | 0.99 | 4.6  | 1.03 | 5.0  | 1.08 | 5.4  | 1.12 | 5.9  | 1.18 |
|   |   | 24                 | 4.2                              | 1.08 | 4.5  | 1.12 | 4.9  | 1.17 | 5.3  | 1.21 | 5.8  | 1.26 |
| S-50PU2E5A<br>U-50PE2E5A                    | 220V-230V-240V<br>50Hz 1phase                                     | 16                 | 5.8                              | 1.66 | 6.4  | 1.79 | 6.6  | 1.53 | 7.1  | 1.49 | 8.3  | 1.66 |
|   |   | 20                 | 5.6                              | 1.75 | 6.3  | 1.87 | 6.5  | 1.62 | 6.9  | 1.57 | 8.1  | 1.75 |
|   |   | 24                 | 5.5                              | 1.88 | 6.1  | 2.00 | 6.4  | 1.75 | 6.8  | 1.70 | 8.0  | 1.88 |
| S-60PU2E5A<br>U-60PE2E5A                    | 220V-230V-240V<br>50Hz 1phase                                     | 16                 | 6.9                              | 2.13 | 8.0  | 2.36 | 8.2  | 1.92 | 8.2  | 1.67 | 8.9  | 1.72 |
|   |   | 20                 | 6.7                              | 2.27 | 7.8  | 2.52 | 8.0  | 2.05 | 8.0  | 1.78 | 8.7  | 1.83 |
|   |   | 24                 | 6.7                              | 2.42 | 7.8  | 2.69 | 8.0  | 2.19 | 8.0  | 1.90 | 8.6  | 1.96 |
| S-71PU2E5A<br>U-71PE1E5A<br>(U-71PE1E8A)    | 220V-230V-240V<br>50Hz 1phase<br>(380V-400V-415V<br>50Hz 3 phase) | 16                 | 8.2                              | 2.83 | 8.5  | 2.85 | 9.7  | 2.81 | 9.9  | 2.63 | 9.9  | 2.43 |
|   |   | 20                 | 7.8                              | 2.91 | 8.1  | 2.93 | 9.0  | 2.85 | 9.0  | 2.67 | 9.0  | 2.45 |
|   |   | 24                 | 7.4                              | 3.00 | 7.7  | 3.02 | 8.1  | 2.91 | 8.1  | 2.73 | 8.1  | 2.51 |
| S-100PU2E5A<br>U-100PE1E5A<br>(U-100PE1E8A) | 220V-230V-240V<br>50Hz 1phase<br>(380V-400V-415V<br>50Hz 3 phase) | 16                 | 15.1                             | 4.97 | 15.1 | 4.77 | 15.1 | 4.16 | 15.1 | 3.66 | 15.1 | 3.10 |
|   |   | 20                 | 14.0                             | 5.26 | 14.0 | 5.05 | 14.0 | 4.40 | 14.0 | 3.87 | 14.0 | 3.28 |
|   |   | 24                 | 13.1                             | 5.34 | 13.1 | 5.13 | 13.1 | 4.47 | 13.1 | 3.94 | 13.1 | 3.33 |
| S-125PU2E5A<br>U-125PE1E5A<br>(U-125PE1E8A) | 220V-230V-240V<br>50Hz 1phase<br>(380V-400V-415V<br>50Hz 3 phase) | 16                 | 16.7                             | 5.35 | 17.2 | 5.26 | 17.3 | 4.76 | 17.3 | 4.19 | 17.3 | 3.55 |
|   |   | 20                 | 15.5                             | 5.66 | 15.9 | 5.57 | 16.0 | 5.04 | 16.0 | 4.44 | 16.0 | 3.75 |
|   |   | 24                 | 14.5                             | 5.75 | 14.9 | 5.66 | 15.0 | 5.12 | 15.0 | 4.51 | 15.0 | 3.82 |
| S-140PU2E5A<br>U-140PE1E5A<br>(U-140PE1E8A) | 220V-230V-240V<br>50Hz 1phase<br>(380V-400V-415V<br>50Hz 3 phase) | 16                 | 18.1                             | 5.54 | 19.2 | 5.52 | 19.4 | 5.40 | 19.4 | 4.76 | 19.4 | 4.03 |
|   |   | 20                 | 16.7                             | 5.87 | 17.8 | 5.84 | 18.0 | 5.72 | 18.0 | 5.03 | 18.0 | 4.26 |
|   |   | 24                 | 15.7                             | 5.96 | 16.7 | 5.94 | 16.9 | 5.81 | 16.9 | 5.12 | 16.9 | 4.33 |

## 1-13. Capacity Table

## 2. Heating Capacity Performance Data

TC :Cooling Capacity

IPT :Cooling Power Consumption

## • Combination of Multiple Unit

unit : kW

## 4-Way Cassette Type

| Model  | Power Source  | Ambient Return Air | Outdoor air intake temp(°C W.B.) |      |      |      |      |      |      |      |      |      |
|--|---|--------------------|----------------------------------|------|------|------|------|------|------|------|------|------|
|  |   |                    | -5°C                             |      | 0°C  |      | 6°C  |      | 10°C |      | 15°C |      |
|  |   |                    | TC                               | IPT  | TC   | IPT  | TC   | IPT  | TC   | IPT  | TC   | IPT  |
| S-36PU2E5A×2<br>U-71PE1E5A<br>(U-71PE1E8A)   | 220V-230V-240V<br>50Hz 1phase<br>(380V-400V-415V<br>50Hz 3 phase) | 16                 | 8.2                              | 2.83 | 8.5  | 2.85 | 9.7  | 2.81 | 9.9  | 2.63 | 9.9  | 2.43 |
|  |   | 20                 | 7.8                              | 2.91 | 8.1  | 2.93 | 9.0  | 2.85 | 9.0  | 2.67 | 9.0  | 2.45 |
|  |   | 24                 | 7.4                              | 3.00 | 7.7  | 3.02 | 8.1  | 2.91 | 8.1  | 2.73 | 8.1  | 2.51 |
| S-36PU2E5A×3<br>U-100PE1E5A<br>(U-100PE1E8A) | 220V-230V-240V<br>50Hz 1phase<br>(380V-400V-415V<br>50Hz 3 phase) | 16                 | 15.1                             | 4.97 | 15.1 | 4.77 | 15.1 | 4.16 | 15.1 | 3.66 | 15.1 | 3.10 |
|  |   | 20                 | 14.0                             | 5.26 | 14.0 | 5.05 | 14.0 | 4.40 | 14.0 | 3.87 | 14.0 | 3.28 |
|  |   | 24                 | 13.1                             | 5.34 | 13.1 | 5.13 | 13.1 | 4.47 | 13.1 | 3.94 | 13.1 | 3.33 |
| S-50PU2E5A×2<br>U-100PE1E5A<br>(U-100PE1E8A) | 220V-230V-240V<br>50Hz 1phase<br>(380V-400V-415V<br>50Hz 3 phase) | 16                 | 15.1                             | 4.97 | 15.1 | 4.77 | 15.1 | 4.16 | 15.1 | 3.66 | 15.1 | 3.10 |
|  |   | 20                 | 14.0                             | 5.26 | 14.0 | 5.05 | 14.0 | 4.40 | 14.0 | 3.87 | 14.0 | 3.28 |
|  |   | 24                 | 13.1                             | 5.34 | 13.1 | 5.13 | 13.1 | 4.47 | 13.1 | 3.94 | 13.1 | 3.33 |
| S-36PU2E5A×4<br>U-125PE1E5A<br>(U-125PE1E8A) | 220V-230V-240V<br>50Hz 1phase<br>(380V-400V-415V<br>50Hz 3 phase) | 16                 | 16.7                             | 5.35 | 17.2 | 5.26 | 17.3 | 4.76 | 17.3 | 4.19 | 17.3 | 3.55 |
|  |   | 20                 | 15.5                             | 5.66 | 15.9 | 5.57 | 16.0 | 5.04 | 16.0 | 4.44 | 16.0 | 3.75 |
|  |   | 24                 | 14.5                             | 5.75 | 14.9 | 5.66 | 15.0 | 5.12 | 15.0 | 4.51 | 15.0 | 3.82 |
| S-45PU2E5A×3<br>U-125PE1E5A<br>(U-125PE1E8A) | 220V-230V-240V<br>50Hz 1phase<br>(380V-400V-415V<br>50Hz 3 phase) | 16                 | 16.7                             | 5.35 | 17.2 | 5.26 | 17.3 | 4.76 | 17.3 | 4.19 | 17.3 | 3.55 |
|  |   | 20                 | 15.5                             | 5.66 | 15.9 | 5.57 | 16.0 | 5.04 | 16.0 | 4.44 | 16.0 | 3.75 |
|  |   | 24                 | 14.5                             | 5.75 | 14.9 | 5.66 | 15.0 | 5.12 | 15.0 | 4.51 | 15.0 | 3.82 |
| S-60PU2E5A×2<br>U-125PE1E5A<br>(U-125PE1E8A) | 220V-230V-240V<br>50Hz 1phase<br>(380V-400V-415V<br>50Hz 3 phase) | 16                 | 16.7                             | 5.35 | 17.2 | 5.26 | 17.3 | 4.76 | 17.3 | 4.19 | 17.3 | 3.55 |
|  |   | 20                 | 15.5                             | 5.66 | 15.9 | 5.57 | 16.0 | 5.04 | 16.0 | 4.44 | 16.0 | 3.75 |
|  |   | 24                 | 14.5                             | 5.75 | 14.9 | 5.66 | 15.0 | 5.12 | 15.0 | 4.51 | 15.0 | 3.82 |
| S-50PU2E5A×3<br>U-140PE1E5A<br>(U-140PE1E8A) | 220V-230V-240V<br>50Hz 1phase<br>(380V-400V-415V<br>50Hz 3 phase) | 16                 | 18.1                             | 5.54 | 19.2 | 5.52 | 19.4 | 5.40 | 19.4 | 4.76 | 19.4 | 4.03 |
|  |   | 20                 | 16.7                             | 5.87 | 17.8 | 5.84 | 18.0 | 5.72 | 18.0 | 5.03 | 18.0 | 4.26 |
|  |   | 24                 | 15.7                             | 5.96 | 16.7 | 5.94 | 16.9 | 5.81 | 16.9 | 5.12 | 16.9 | 4.33 |
| S-71PU2E5A×2<br>U-140PE1E5A<br>(U-140PE1E8A) | 220V-230V-240V<br>50Hz 1phase<br>(380V-400V-415V<br>50Hz 3 phase) | 16                 | 18.1                             | 5.54 | 19.2 | 5.52 | 19.4 | 5.40 | 19.4 | 4.76 | 19.4 | 4.03 |
|  |   | 20                 | 16.7                             | 5.87 | 17.8 | 5.84 | 18.0 | 5.72 | 18.0 | 5.03 | 18.0 | 4.26 |
|  |   | 24                 | 15.7                             | 5.96 | 16.7 | 5.94 | 16.9 | 5.81 | 16.9 | 5.12 | 16.9 | 4.33 |



**1-13. Capacity Table**

**2. Heating Capacity Performance Data**

TC :Cooling Capacity

IPT :Cooling Power Consumption

**• Combination of Single Unit**

unit : kW

Ceiling Type

| Model                                       | Power Source  | Ambient Return Air | Outdoor air intake temp(°C W.B.) |      |      |      |      |      |      |      |      |      |
|---|---|--------------------|----------------------------------|------|------|------|------|------|------|------|------|------|
|   |   |                    | -5°C                             |      | 0°C  |      | 6°C  |      | 10°C |      | 15°C |      |
|   |   |                    | TC                               | IPT  | TC   | IPT  | TC   | IPT  | TC   | IPT  | TC   | IPT  |
| S-36PT2E5A<br>U-36PE1E5A                    | 220V-230V-240V<br>50Hz 1phase                                     | DB                 |                                  |      |      |      |      |      |      |      |      |      |
|   |   | 16                 | 4.4                              | 0.95 | 4.8  | 0.99 | 5.1  | 1.04 | 5.5  | 1.09 | 6.0  | 1.14 |
|   |   | 20                 | 4.3                              | 1.01 | 4.6  | 1.05 | 5.0  | 1.10 | 5.4  | 1.14 | 5.9  | 1.20 |
| S-50PT2E5A<br>U-50PE2E5A                    | 220V-230V-240V<br>50Hz 1phase                                     | 16                 | 5.8                              | 1.77 | 6.4  | 1.90 | 6.6  | 1.63 | 7.1  | 1.58 | 8.3  | 1.76 |
|   |   | 20                 | 5.6                              | 1.86 | 6.3  | 1.99 | 6.5  | 1.72 | 6.9  | 1.67 | 8.1  | 1.86 |
|   |   | 24                 | 5.5                              | 2.00 | 6.1  | 2.13 | 6.4  | 1.86 | 6.8  | 1.81 | 8.0  | 2.00 |
| S-60PT2E5A<br>U-60PE2E5A                    | 220V-230V-240V<br>50Hz 1phase                                     | 16                 | 6.9                              | 2.02 | 8.0  | 2.25 | 8.2  | 1.83 | 8.2  | 1.59 | 8.9  | 1.63 |
|   |   | 20                 | 6.7                              | 2.16 | 7.8  | 2.39 | 8.0  | 1.95 | 8.0  | 1.69 | 8.7  | 1.74 |
|   |   | 24                 | 6.7                              | 2.30 | 7.8  | 2.56 | 8.0  | 2.08 | 8.0  | 1.81 | 8.6  | 1.86 |
| S-71PT2E5A<br>U-71PE1E5A<br>(U-71PE1E8A)    | 220V-230V-240V<br>50Hz 1phase<br>(380V-400V-415V<br>50Hz 3 phase) | 16                 | 8.2                              | 2.88 | 8.5  | 2.90 | 9.7  | 2.86 | 9.9  | 2.67 | 9.9  | 2.47 |
|   |   | 20                 | 7.8                              | 2.96 | 8.1  | 2.98 | 9.0  | 2.90 | 9.0  | 2.72 | 9.0  | 2.49 |
|   |   | 24                 | 7.4                              | 3.05 | 7.7  | 3.07 | 8.1  | 2.96 | 8.1  | 2.78 | 8.1  | 2.55 |
| S-100PT2E5A<br>U-100PE1E5A<br>(U-100PE1E8A) | 220V-230V-240V<br>50Hz 1phase<br>(380V-400V-415V<br>50Hz 3 phase) | 16                 | 15.1                             | 4.97 | 15.1 | 4.77 | 15.1 | 4.16 | 15.1 | 3.66 | 15.1 | 3.10 |
|   |   | 20                 | 14.0                             | 5.26 | 14.0 | 5.05 | 14.0 | 4.40 | 14.0 | 3.87 | 14.0 | 3.28 |
|   |   | 24                 | 13.1                             | 5.34 | 13.1 | 5.13 | 13.1 | 4.47 | 13.1 | 3.94 | 13.1 | 3.33 |
| S-125PT2E5A<br>U-125PE1E5A<br>(U-125PE1E8A) | 220V-230V-240V<br>50Hz 1phase<br>(380V-400V-415V<br>50Hz 3 phase) | 16                 | 16.7                             | 5.53 | 17.2 | 5.44 | 17.3 | 4.92 | 17.3 | 4.34 | 17.3 | 3.67 |
|   |   | 20                 | 15.5                             | 5.85 | 15.9 | 5.75 | 16.0 | 5.21 | 16.0 | 4.59 | 16.0 | 3.88 |
|   |   | 24                 | 14.5                             | 5.94 | 14.9 | 5.85 | 15.0 | 5.29 | 15.0 | 4.66 | 15.0 | 3.94 |
| S-140PT2E5A<br>U-140PE1E5A<br>(U-140PE1E8A) | 220V-230V-240V<br>50Hz 1phase<br>(380V-400V-415V<br>50Hz 3 phase) | 16                 | 18.1                             | 5.75 | 19.2 | 5.72 | 19.4 | 5.60 | 19.4 | 4.93 | 19.4 | 4.17 |
|   |   | 20                 | 16.7                             | 6.08 | 17.8 | 6.06 | 18.0 | 5.93 | 18.0 | 5.22 | 18.0 | 4.42 |
|   |   | 24                 | 15.7                             | 6.18 | 16.7 | 6.15 | 16.9 | 6.03 | 16.9 | 5.30 | 16.9 | 4.49 |

## 1-13. Capacity Table

## 2. Heating Capacity Performance Data

TC :Cooling Capacity

IPT :Cooling Power Consumption

## ● Combination of Multiple Unit

unit : kW

Ceiling Type

| Model  | Power Source  | Ambient Return Air | Outdoor air intake temp(°C W.B.) |      |      |      |      |      |      |      |      |      |
|--|---|--------------------|----------------------------------|------|------|------|------|------|------|------|------|------|
|  |   |                    | -5°C                             |      | 0°C  |      | 6°C  |      | 10°C |      | 15°C |      |
|  |   |                    | TC                               | IPT  | TC   | IPT  | TC   | IPT  | TC   | IPT  | TC   | IPT  |
| S-36PT2E5A×2<br>U-71PE1E5A<br>(U-71PE1E8A)   | 220V-230V-240V<br>50Hz 1phase<br>(380V-400V-415V<br>50Hz 3 phase) | 16                 | 8.2                              | 2.88 | 8.5  | 2.90 | 9.7  | 2.86 | 9.9  | 2.67 | 9.9  | 2.47 |
|  |   | 20                 | 7.8                              | 2.96 | 8.1  | 2.98 | 9.0  | 2.90 | 9.0  | 2.72 | 9.0  | 2.49 |
|  |   | 24                 | 7.4                              | 3.05 | 7.7  | 3.07 | 8.1  | 2.96 | 8.1  | 2.78 | 8.1  | 2.55 |
| S-36PT2E5A×3<br>U-100PE1E5A<br>(U-100PE1E8A) | 220V-230V-240V<br>50Hz 1phase<br>(380V-400V-415V<br>50Hz 3 phase) | 16                 | 15.1                             | 4.97 | 15.1 | 4.77 | 15.1 | 4.16 | 15.1 | 3.66 | 15.1 | 3.10 |
|  |   | 20                 | 14.0                             | 5.26 | 14.0 | 5.05 | 14.0 | 4.40 | 14.0 | 3.87 | 14.0 | 3.28 |
|  |   | 24                 | 13.1                             | 5.34 | 13.1 | 5.13 | 13.1 | 4.47 | 13.1 | 3.94 | 13.1 | 3.33 |
| S-50PT2E5A×2<br>U-100PE1E5A<br>(U-100PE1E8A) | 220V-230V-240V<br>50Hz 1phase<br>(380V-400V-415V<br>50Hz 3 phase) | 16                 | 15.1                             | 4.97 | 15.1 | 4.77 | 15.1 | 4.16 | 15.1 | 3.66 | 15.1 | 3.10 |
|  |   | 20                 | 14.0                             | 5.26 | 14.0 | 5.05 | 14.0 | 4.40 | 14.0 | 3.87 | 14.0 | 3.28 |
|  |   | 24                 | 13.1                             | 5.34 | 13.1 | 5.13 | 13.1 | 4.47 | 13.1 | 3.94 | 13.1 | 3.33 |
| S-36PT2E5A×4<br>U-125PE1E5A<br>(U-125PE1E8A) | 220V-230V-240V<br>50Hz 1phase<br>(380V-400V-415V<br>50Hz 3 phase) | 16                 | 16.7                             | 5.53 | 17.2 | 5.44 | 17.3 | 4.92 | 17.3 | 4.34 | 17.3 | 3.67 |
|  |   | 20                 | 15.5                             | 5.85 | 15.9 | 5.75 | 16.0 | 5.21 | 16.0 | 4.59 | 16.0 | 3.88 |
|  |   | 24                 | 14.5                             | 5.94 | 14.9 | 5.85 | 15.0 | 5.29 | 15.0 | 4.66 | 15.0 | 3.94 |
| S-45PT2E5A×3<br>U-125PE1E5A<br>(U-125PE1E8A) | 220V-230V-240V<br>50Hz 1phase<br>(380V-400V-415V<br>50Hz 3 phase) | 16                 | 16.7                             | 5.53 | 17.2 | 5.44 | 17.3 | 4.92 | 17.3 | 4.34 | 17.3 | 3.67 |
|  |   | 20                 | 15.5                             | 5.85 | 15.9 | 5.75 | 16.0 | 5.21 | 16.0 | 4.59 | 16.0 | 3.88 |
|  |   | 24                 | 14.5                             | 5.94 | 14.9 | 5.85 | 15.0 | 5.29 | 15.0 | 4.66 | 15.0 | 3.94 |
| S-60PT2E5A×2<br>U-125PE1E5A<br>(U-125PE1E8A) | 220V-230V-240V<br>50Hz 1phase<br>(380V-400V-415V<br>50Hz 3 phase) | 16                 | 16.7                             | 5.53 | 17.2 | 5.44 | 17.3 | 4.92 | 17.3 | 4.34 | 17.3 | 3.67 |
|  |   | 20                 | 15.5                             | 5.85 | 15.9 | 5.75 | 16.0 | 5.21 | 16.0 | 4.59 | 16.0 | 3.88 |
|  |   | 24                 | 14.5                             | 5.94 | 14.9 | 5.85 | 15.0 | 5.29 | 15.0 | 4.66 | 15.0 | 3.94 |
| S-50PT2E5A×3<br>U-140PE1E5A<br>(U-140PE1E8A) | 220V-230V-240V<br>50Hz 1phase<br>(380V-400V-415V<br>50Hz 3 phase) | 16                 | 18.1                             | 5.75 | 19.2 | 5.72 | 19.4 | 5.60 | 19.4 | 4.93 | 19.4 | 4.17 |
|  |   | 20                 | 16.7                             | 6.08 | 17.8 | 6.06 | 18.0 | 5.93 | 18.0 | 5.22 | 18.0 | 4.42 |
|  |   | 24                 | 15.7                             | 6.18 | 16.7 | 6.15 | 16.9 | 6.03 | 16.9 | 5.30 | 16.9 | 4.49 |
| S-71PT2E5A×2<br>U-140PE1E5A<br>(U-140PE1E8A) | 220V-230V-240V<br>50Hz 1phase<br>(380V-400V-415V<br>50Hz 3 phase) | 16                 | 18.1                             | 5.75 | 19.2 | 5.72 | 19.4 | 5.60 | 19.4 | 4.93 | 19.4 | 4.17 |
|  |   | 20                 | 16.7                             | 6.08 | 17.8 | 6.06 | 18.0 | 5.93 | 18.0 | 5.22 | 18.0 | 4.42 |
|  |   | 24                 | 15.7                             | 6.18 | 16.7 | 6.15 | 16.9 | 6.03 | 16.9 | 5.30 | 16.9 | 4.49 |

**1-13. Capacity Table**

**2. Heating Capacity Performance Data**

TC :Cooling Capacity

IPT :Cooling Power Consumption

**• Combination of Single Unit**

unit : kW

Wall Mounted Type

| Model                                       | Power Source  | Ambient Return Air | Outdoor air intake temp(°C W.B.) |      |      |      |      |      |      |      |      |      |
|---|---|--------------------|----------------------------------|------|------|------|------|------|------|------|------|------|
|   |   |                    | -5°C                             |      | 0°C  |      | 6°C  |      | 10°C |      | 15°C |      |
|   |   |                    | TC                               | IPT  | TC   | IPT  | TC   | IPT  | TC   | IPT  | TC   | IPT  |
|   |   | DB                 |                                  |      |      |      |      |      |      |      |      |      |
| S-36PK1E5A<br>U-36PE1E5A                    | 220V-230V-240V<br>50Hz 1phase                                     | 16                 | 4.4                              | 1.03 | 4.8  | 1.07 | 5.1  | 1.13 | 5.5  | 1.17 | 6.0  | 1.23 |
|   |   | 20                 | 4.3                              | 1.09 | 4.6  | 1.13 | 5.0  | 1.19 | 5.4  | 1.24 | 5.9  | 1.30 |
|   |   | 24                 | 4.2                              | 1.19 | 4.5  | 1.23 | 4.9  | 1.29 | 5.3  | 1.33 | 5.8  | 1.39 |
| S-50PK1E5A<br>U-50PE2E5A                    | 220V-230V-240V<br>50Hz 1phase                                     | 16                 | 5.8                              | 1.97 | 6.4  | 2.12 | 6.6  | 1.82 | 7.1  | 1.76 | 8.3  | 1.97 |
|   |   | 20                 | 5.6                              | 2.07 | 6.3  | 2.22 | 6.5  | 1.92 | 6.9  | 1.86 | 8.1  | 2.07 |
|   |   | 24                 | 5.5                              | 2.23 | 6.1  | 2.37 | 6.4  | 2.08 | 6.8  | 2.02 | 8.0  | 2.23 |
| S-60PK1E5A<br>U-60PE2E5A                    | 220V-230V-240V<br>50Hz 1phase                                     | 16                 | 6.9                              | 2.13 | 8.0  | 2.36 | 8.2  | 1.92 | 8.2  | 1.67 | 8.9  | 1.72 |
|   |   | 20                 | 6.7                              | 2.27 | 7.8  | 2.52 | 8.0  | 2.05 | 8.0  | 1.78 | 8.7  | 1.83 |
|   |   | 24                 | 6.7                              | 2.42 | 7.8  | 2.69 | 8.0  | 2.19 | 8.0  | 1.90 | 8.6  | 1.96 |
| S-71PK1E5A<br>U-71PE1E5A<br>(U-71PE1E8A)    | 220V-230V-240V<br>50Hz 1phase<br>(380V-400V-415V<br>50Hz 3 phase) | 16                 | 8.2                              | 2.88 | 8.5  | 2.90 | 9.7  | 2.86 | 9.9  | 2.67 | 9.9  | 2.47 |
|   |   | 20                 | 7.8                              | 2.96 | 8.1  | 2.98 | 9.0  | 2.90 | 9.0  | 2.72 | 9.0  | 2.49 |
|   |   | 24                 | 7.4                              | 3.05 | 7.7  | 3.07 | 8.1  | 2.96 | 8.1  | 2.78 | 8.1  | 2.55 |
| S-100PK1E5A<br>U-100PE1E5A<br>(U-100PE1E8A) | 220V-230V-240V<br>50Hz 1phase<br>(380V-400V-415V<br>50Hz 3 phase) | 16                 | 12.4                             | 3.78 | 12.4 | 3.63 | 12.4 | 3.17 | 12.4 | 2.79 | 12.4 | 2.36 |
|   |   | 20                 | 11.5                             | 4.00 | 11.5 | 3.85 | 11.5 | 3.35 | 11.5 | 2.95 | 11.5 | 2.50 |
|   |   | 24                 | 10.8                             | 4.07 | 10.8 | 3.91 | 10.8 | 3.40 | 10.8 | 3.00 | 10.8 | 2.54 |

## 1-13. Capacity Table

### 2. Heating Capacity Performance Data

TC :Cooling Capacity

IPT :Cooling Power Consumption

#### • Combination of Multiple Unit

unit : kW

Wall Mounted Type

| Model  | Power Source  | Ambient Return Air | Outdoor air intake temp(°C W.B.) |      |      |      |      |      |      |      |      |      |
|--|---|--------------------|----------------------------------|------|------|------|------|------|------|------|------|------|
|  |   |                    | -5°C                             |      | 0°C  |      | 6°C  |      | 10°C |      | 15°C |      |
|  |   |                    | TC                               | IPT  | TC   | IPT  | TC   | IPT  | TC   | IPT  | TC   | IPT  |
| S-36PK1E5A×2<br>U-71PE1E5A<br>(U-71PE1E8A)   | 220V-230V-240V<br>50Hz 1phase<br>(380V-400V-415V<br>50Hz 3 phase) | 16                 | 8.2                              | 2.88 | 8.5  | 2.90 | 9.7  | 2.86 | 9.9  | 2.67 | 9.9  | 2.47 |
|  |   | 20                 | 7.8                              | 2.96 | 8.1  | 2.98 | 9.0  | 2.90 | 9.0  | 2.72 | 9.0  | 2.49 |
|  |   | 24                 | 7.4                              | 3.05 | 7.7  | 3.07 | 8.1  | 2.96 | 8.1  | 2.78 | 8.1  | 2.55 |
| S-36PK1E5A×3<br>U-100PE1E5A<br>(U-100PE1E8A) | 220V-230V-240V<br>50Hz 1phase<br>(380V-400V-415V<br>50Hz 3 phase) | 16                 | 15.1                             | 4.97 | 15.1 | 4.77 | 15.1 | 4.16 | 15.1 | 3.66 | 15.1 | 3.10 |
|  |   | 20                 | 14.0                             | 5.26 | 14.0 | 5.05 | 14.0 | 4.40 | 14.0 | 3.87 | 14.0 | 3.28 |
|  |   | 24                 | 13.1                             | 5.34 | 13.1 | 5.13 | 13.1 | 4.47 | 13.1 | 3.94 | 13.1 | 3.33 |
| S-50PK1E5A×2<br>U-100PE1E5A<br>(U-100PE1E8A) | 220V-230V-240V<br>50Hz 1phase<br>(380V-400V-415V<br>50Hz 3 phase) | 16                 | 15.1                             | 4.97 | 15.1 | 4.77 | 15.1 | 4.16 | 15.1 | 3.66 | 15.1 | 3.10 |
|  |   | 20                 | 14.0                             | 5.26 | 14.0 | 5.05 | 14.0 | 4.40 | 14.0 | 3.87 | 14.0 | 3.28 |
|  |   | 24                 | 13.1                             | 5.34 | 13.1 | 5.13 | 13.1 | 4.47 | 13.1 | 3.94 | 13.1 | 3.33 |

**1-13. Capacity Table**

**2. Heating Capacity Performance Data**

TC :Cooling Capacity

IPT :Cooling Power Consumption

**• Combination of Single Unit**

Low Sihouette Ducted Type

unit : kW

| Model                                       | Power Source  | Ambient Return Air | Outdoor air intake temp(°C W.B.) |      |      |      |      |      |      |      |      |      |
|---|---|--------------------|----------------------------------|------|------|------|------|------|------|------|------|------|
|   |   |                    | -5°C                             |      | 0°C  |      | 6°C  |      | 10°C |      | 15°C |      |
|   |   |                    | TC                               | IPT  | TC   | IPT  | TC   | IPT  | TC   | IPT  | TC   | IPT  |
| S-36PF1E5A<br>U-36PE1E5A                    | 220V-230V-240V<br>50Hz 1phase                                     | 16                 | 4.4                              | 1.03 | 4.8  | 1.08 | 5.1  | 1.14 | 5.5  | 1.18 | 6.0  | 1.24 |
|   |   | 20                 | 4.3                              | 1.10 | 4.6  | 1.14 | 5.0  | 1.20 | 5.4  | 1.25 | 5.9  | 1.31 |
|   |   | 24                 | 4.2                              | 1.20 | 4.5  | 1.24 | 4.9  | 1.30 | 5.3  | 1.35 | 5.8  | 1.41 |
| S-50PF1E5A<br>U-50PE2E5A                    | 220V-230V-240V<br>50Hz 1phase                                     | 16                 | 5.8                              | 1.80 | 6.4  | 1.93 | 6.6  | 1.66 | 7.1  | 1.61 | 8.3  | 1.80 |
|   |   | 20                 | 5.6                              | 1.89 | 6.3  | 2.02 | 6.5  | 1.75 | 6.9  | 1.70 | 8.1  | 1.89 |
|   |   | 24                 | 5.5                              | 2.03 | 6.1  | 2.16 | 6.4  | 1.89 | 6.8  | 1.84 | 8.0  | 2.03 |
| S-60PF1E5A<br>U-60PE2E5A                    | 220V-230V-240V<br>50Hz 1phase                                     | 16                 | 6.9                              | 2.18 | 8.0  | 2.42 | 8.2  | 1.97 | 8.2  | 1.71 | 8.9  | 1.76 |
|   |   | 20                 | 6.7                              | 2.32 | 7.8  | 2.58 | 8.0  | 2.10 | 8.0  | 1.82 | 8.7  | 1.88 |
|   |   | 24                 | 6.7                              | 2.48 | 7.8  | 2.76 | 8.0  | 2.24 | 8.0  | 1.95 | 8.6  | 2.01 |
| S-71PF1E5A<br>U-71PE1E5A<br>(U-71PE1E8A)    | 220V-230V-240V<br>50Hz 1phase<br>(380V-400V-415V<br>50Hz 3 phase) | 16                 | 8.2                              | 2.88 | 8.5  | 2.90 | 9.7  | 2.86 | 9.9  | 2.67 | 9.9  | 2.47 |
|   |   | 20                 | 7.8                              | 2.96 | 8.1  | 2.98 | 9.0  | 2.90 | 9.0  | 2.72 | 9.0  | 2.49 |
|   |   | 24                 | 7.4                              | 3.05 | 7.7  | 3.07 | 8.1  | 2.96 | 8.1  | 2.78 | 8.1  | 2.55 |
| S-100PF1E5A<br>U-100PE1E5A<br>(U-100PE1E8A) | 220V-230V-240V<br>50Hz 1phase<br>(380V-400V-415V<br>50Hz 3 phase) | 16                 | 15.1                             | 4.97 | 15.1 | 4.77 | 15.1 | 4.16 | 15.1 | 3.66 | 15.1 | 3.10 |
|   |   | 20                 | 14.0                             | 5.26 | 14.0 | 5.05 | 14.0 | 4.40 | 14.0 | 3.87 | 14.0 | 3.28 |
|   |   | 24                 | 13.1                             | 5.34 | 13.1 | 5.13 | 13.1 | 4.47 | 13.1 | 3.94 | 13.1 | 3.33 |
| S-125PF1E5A<br>U-125PE1E5A<br>(U-125PE1E8A) | 220V-230V-240V<br>50Hz 1phase<br>(380V-400V-415V<br>50Hz 3 phase) | 16                 | 16.7                             | 5.52 | 17.2 | 5.43 | 17.3 | 4.91 | 17.3 | 4.33 | 17.3 | 3.66 |
|   |   | 20                 | 15.5                             | 5.84 | 15.9 | 5.74 | 16.0 | 5.20 | 16.0 | 4.58 | 16.0 | 3.87 |
|   |   | 24                 | 14.5                             | 5.93 | 14.9 | 5.84 | 15.0 | 5.28 | 15.0 | 4.65 | 15.0 | 3.94 |
| S-140PF1E5A<br>U-140PE1E5A<br>(U-140PE1E8A) | 220V-230V-240V<br>50Hz 1phase<br>(380V-400V-415V<br>50Hz 3 phase) | 16                 | 18.1                             | 5.72 | 19.2 | 5.69 | 19.4 | 5.57 | 19.4 | 4.91 | 19.4 | 4.15 |
|   |   | 20                 | 16.7                             | 6.05 | 17.8 | 6.02 | 18.0 | 5.90 | 18.0 | 5.19 | 18.0 | 4.40 |
|   |   | 24                 | 15.7                             | 6.15 | 16.7 | 6.12 | 16.9 | 6.00 | 16.9 | 5.28 | 16.9 | 4.47 |

## 1-13. Capacity Table

## 2. Heating Capacity Performance Data

TC :Cooling Capacity

IPT :Cooling Power Consumption

## • Combination of Multiple Unit

Low Silhouette Ducted Type

unit : kW

| Model  | Power Source  | Ambient Return Air | Outdoor air intake temp(°C W.B.) |      |      |      |      |      |      |      |      |      |
|--|---|--------------------|----------------------------------|------|------|------|------|------|------|------|------|------|
|  |   |                    | -5°C                             |      | 0°C  |      | 6°C  |      | 10°C |      | 15°C |      |
|  |   |                    | TC                               | IPT  | TC   | IPT  | TC   | IPT  | TC   | IPT  | TC   | IPT  |
| S-36PF1E5A×2<br>U-71PE1E5A<br>(U-71PE1E8A)   | 220V-230V-240V<br>50Hz 1phase<br>(380V-400V-415V<br>50Hz 3 phase) | 16                 | 8.2                              | 2.88 | 8.5  | 2.90 | 9.7  | 2.86 | 9.9  | 2.67 | 9.9  | 2.47 |
|  |   | 20                 | 7.8                              | 2.96 | 8.1  | 2.98 | 9.0  | 2.90 | 9.0  | 2.72 | 9.0  | 2.49 |
|  |   | 24                 | 7.4                              | 3.05 | 7.7  | 3.07 | 8.1  | 2.96 | 8.1  | 2.78 | 8.1  | 2.55 |
| S-36PF1E5A×3<br>U-100PE1E5A<br>(U-100PE1E8A) | 220V-230V-240V<br>50Hz 1phase<br>(380V-400V-415V<br>50Hz 3 phase) | 16                 | 15.1                             | 4.97 | 15.1 | 4.77 | 15.1 | 4.16 | 15.1 | 3.66 | 15.1 | 3.10 |
|  |   | 20                 | 14.0                             | 5.26 | 14.0 | 5.05 | 14.0 | 4.40 | 14.0 | 3.87 | 14.0 | 3.28 |
|  |   | 24                 | 13.1                             | 5.34 | 13.1 | 5.13 | 13.1 | 4.47 | 13.1 | 3.94 | 13.1 | 3.33 |
| S-50PF1E5A×2<br>U-100PE1E5A<br>(U-100PE1E8A) | 220V-230V-240V<br>50Hz 1phase<br>(380V-400V-415V<br>50Hz 3 phase) | 16                 | 15.1                             | 4.97 | 15.1 | 4.77 | 15.1 | 4.16 | 15.1 | 3.66 | 15.1 | 3.10 |
|  |   | 20                 | 14.0                             | 5.26 | 14.0 | 5.05 | 14.0 | 4.40 | 14.0 | 3.87 | 14.0 | 3.28 |
|  |   | 24                 | 13.1                             | 5.34 | 13.1 | 5.13 | 13.1 | 4.47 | 13.1 | 3.94 | 13.1 | 3.33 |
| S-36PF1E5A×4<br>U-125PE1E5A<br>(U-125PE1E8A) | 220V-230V-240V<br>50Hz 1phase<br>(380V-400V-415V<br>50Hz 3 phase) | 16                 | 16.7                             | 5.52 | 17.2 | 5.43 | 17.3 | 4.91 | 17.3 | 4.33 | 17.3 | 3.66 |
|  |   | 20                 | 15.5                             | 5.84 | 15.9 | 5.74 | 16.0 | 5.20 | 16.0 | 4.58 | 16.0 | 3.87 |
|  |   | 24                 | 14.5                             | 5.93 | 14.9 | 5.84 | 15.0 | 5.28 | 15.0 | 4.65 | 15.0 | 3.94 |
| S-45PF1E5A×3<br>U-125PE1E5A<br>(U-125PE1E8A) | 220V-230V-240V<br>50Hz 1phase<br>(380V-400V-415V<br>50Hz 3 phase) | 16                 | 16.7                             | 5.52 | 17.2 | 5.43 | 17.3 | 4.91 | 17.3 | 4.33 | 17.3 | 3.66 |
|  |   | 20                 | 15.5                             | 5.84 | 15.9 | 5.74 | 16.0 | 5.20 | 16.0 | 4.58 | 16.0 | 3.87 |
|  |   | 24                 | 14.5                             | 5.93 | 14.9 | 5.84 | 15.0 | 5.28 | 15.0 | 4.65 | 15.0 | 3.94 |
| S-60PF1E5A×2<br>U-125PE1E5A<br>(U-125PE1E8A) | 220V-230V-240V<br>50Hz 1phase<br>(380V-400V-415V<br>50Hz 3 phase) | 16                 | 16.7                             | 5.52 | 17.2 | 5.43 | 17.3 | 4.91 | 17.3 | 4.33 | 17.3 | 3.66 |
|  |   | 20                 | 15.5                             | 5.84 | 15.9 | 5.74 | 16.0 | 5.20 | 16.0 | 4.58 | 16.0 | 3.87 |
|  |   | 24                 | 14.5                             | 5.93 | 14.9 | 5.84 | 15.0 | 5.28 | 15.0 | 4.65 | 15.0 | 3.94 |
| S-50PF1E5A×3<br>U-140PE1E5A<br>(U-140PE1E8A) | 220V-230V-240V<br>50Hz 1phase<br>(380V-400V-415V<br>50Hz 3 phase) | 16                 | 18.1                             | 5.72 | 19.2 | 5.69 | 19.4 | 5.57 | 19.4 | 4.91 | 19.4 | 4.15 |
|  |   | 20                 | 16.7                             | 6.05 | 17.8 | 6.02 | 18.0 | 5.90 | 18.0 | 5.19 | 18.0 | 4.40 |
|  |   | 24                 | 15.7                             | 6.15 | 16.7 | 6.12 | 16.9 | 6.00 | 16.9 | 5.28 | 16.9 | 4.47 |
| S-71PF1E5A×2<br>U-140PE1E5A<br>(U-140PE1E8A) | 220V-230V-240V<br>50Hz 1phase<br>(380V-400V-415V<br>50Hz 3 phase) | 16                 | 18.1                             | 5.72 | 19.2 | 5.69 | 19.4 | 5.57 | 19.4 | 4.91 | 19.4 | 4.15 |
|  |   | 20                 | 16.7                             | 6.05 | 17.8 | 6.02 | 18.0 | 5.90 | 18.0 | 5.19 | 18.0 | 4.40 |
|  |   | 24                 | 15.7                             | 6.15 | 16.7 | 6.12 | 16.9 | 6.00 | 16.9 | 5.28 | 16.9 | 4.47 |

1-13. Capacity Table

2. Heating Capacity Performance Data

TC :Cooling Capacity

IPT :Cooling Power Consumption

• Combination of Single Unit

unit : kW

Ducted Type

| Model                                       | Power Source  | Ambient Return Air | Outdoor air intake temp(°C W.B.) |      |      |      |      |      |      |      |      |      |
|---|---|--------------------|----------------------------------|------|------|------|------|------|------|------|------|------|
|   |   |                    | -5°C                             |      | 0°C  |      | 6°C  |      | 10°C |      | 15°C |      |
|   |   |                    | TC                               | IPT  | TC   | IPT  | TC   | IPT  | TC   | IPT  | TC   | IPT  |
| S-36PN1E5A<br>U-36PE1E5A                    | 220V-230V-240V<br>50Hz 1phase                                     | DB                 |                                  |      |      |      |      |      |      |      |      |      |
|   |   | 16                 | 4.4                              | 1.08 | 4.8  | 1.13 | 5.1  | 1.18 | 5.5  | 1.23 | 6.0  | 1.30 |
|   |   | 20                 | 4.3                              | 1.14 | 4.6  | 1.19 | 5.0  | 1.25 | 5.4  | 1.30 | 5.9  | 1.36 |
|   |   | 24                 | 4.2                              | 1.25 | 4.5  | 1.29 | 4.9  | 1.35 | 5.3  | 1.40 | 5.8  | 1.46 |
| S-50PN1E5A<br>U-50PE2E5A                    | 220V-230V-240V<br>50Hz 1phase                                     | 16                 | 5.8                              | 1.91 | 6.4  | 2.05 | 6.6  | 1.76 | 7.1  | 1.71 | 8.3  | 1.91 |
|   |   | 20                 | 5.6                              | 2.01 | 6.3  | 2.15 | 6.5  | 1.86 | 6.9  | 1.81 | 8.1  | 2.01 |
|   |   | 24                 | 5.5                              | 2.16 | 6.1  | 2.30 | 6.4  | 2.01 | 6.8  | 1.96 | 8.0  | 2.16 |
| S-60PN1E5A<br>U-60PE2E5A                    | 220V-230V-240V<br>50Hz 1phase                                     | 16                 | 6.9                              | 2.28 | 8.0  | 2.54 | 8.2  | 2.07 | 8.2  | 1.80 | 8.9  | 1.84 |
|   |   | 20                 | 6.7                              | 2.43 | 7.8  | 2.70 | 8.0  | 2.20 | 8.0  | 1.91 | 8.7  | 1.96 |
|   |   | 24                 | 6.7                              | 2.60 | 7.8  | 2.89 | 8.0  | 2.35 | 8.0  | 2.04 | 8.6  | 2.10 |
| S-71PN1E5A<br>U-71PE1E5A<br>(U-71PE1E8A)    | 220V-230V-240V<br>50Hz 1phase<br>(380V-400V-415V<br>50Hz 3 phase) | 16                 | 8.2                              | 2.90 | 8.5  | 2.92 | 9.7  | 2.88 | 9.9  | 2.69 | 9.9  | 2.48 |
|   |   | 20                 | 7.8                              | 2.98 | 8.1  | 3.00 | 9.0  | 2.92 | 9.0  | 2.74 | 9.0  | 2.51 |
|   |   | 24                 | 7.4                              | 3.07 | 7.7  | 3.09 | 8.1  | 2.98 | 8.1  | 2.79 | 8.1  | 2.57 |
| S-100PN1E5A<br>U-100PE1E5A<br>(U-100PE1E8A) | 220V-230V-240V<br>50Hz 1phase<br>(380V-400V-415V<br>50Hz 3 phase) | 16                 | 15.1                             | 5.08 | 15.1 | 4.88 | 15.1 | 4.25 | 15.1 | 3.74 | 15.1 | 3.17 |
|   |   | 20                 | 14.0                             | 5.38 | 14.0 | 5.17 | 14.0 | 4.50 | 14.0 | 3.96 | 14.0 | 3.35 |
|   |   | 24                 | 13.1                             | 5.46 | 13.1 | 5.25 | 13.1 | 4.57 | 13.1 | 4.03 | 13.1 | 3.41 |
| S-125PN1E5A<br>U-125PE1E5A<br>(U-125PE1E8A) | 220V-230V-240V<br>50Hz 1phase<br>(380V-400V-415V<br>50Hz 3 phase) | 16                 | 16.7                             | 5.73 | 17.2 | 5.64 | 17.3 | 5.10 | 17.3 | 4.49 | 17.3 | 3.80 |
|   |   | 20                 | 15.5                             | 6.06 | 15.9 | 5.96 | 16.0 | 5.40 | 16.0 | 4.75 | 16.0 | 4.02 |
|   |   | 24                 | 14.5                             | 6.16 | 14.9 | 6.06 | 15.0 | 5.49 | 15.0 | 4.83 | 15.0 | 4.09 |
| S-140PN1E5A<br>U-140PE1E5A<br>(U-140PE1E8A) | 220V-230V-240V<br>50Hz 1phase<br>(380V-400V-415V<br>50Hz 3 phase) | 16                 | 18.1                             | 5.91 | 19.2 | 5.89 | 19.4 | 5.76 | 19.4 | 5.08 | 19.4 | 4.29 |
|   |   | 20                 | 16.7                             | 6.26 | 17.8 | 6.23 | 18.0 | 6.10 | 18.0 | 5.37 | 18.0 | 4.54 |
|   |   | 24                 | 15.7                             | 6.36 | 16.7 | 6.33 | 16.9 | 6.20 | 16.9 | 5.46 | 16.9 | 4.62 |

## 1-13. Capacity Table

## 2. Heating Capacity Performance Data

TC :Cooling Capacity

IPT :Cooling Power Consumption

## • Combination of Multiple Unit

unit : kW

Ducted Type

| Model  | Power Source  | Ambient Return Air | Outdoor air intake temp(°C W.B.) |      |      |      |      |      |      |      |      |      |
|--|---|--------------------|----------------------------------|------|------|------|------|------|------|------|------|------|
|  |   |                    | -5°C                             |      | 0°C  |      | 6°C  |      | 10°C |      | 15°C |      |
|  |   |                    | TC                               | IPT  | TC   | IPT  | TC   | IPT  | TC   | IPT  | TC   | IPT  |
| S-36PN1E5A×2<br>U-71PE1E5A<br>(U-71PE1E8A)   | 220V-230V-240V<br>50Hz 1phase<br>(380V-400V-415V<br>50Hz 3 phase) | 16                 | 8.2                              | 2.90 | 8.5  | 2.92 | 9.7  | 2.88 | 9.9  | 2.69 | 9.9  | 2.48 |
|  |   | 20                 | 7.8                              | 2.98 | 8.1  | 3.00 | 9.0  | 2.92 | 9.0  | 2.74 | 9.0  | 2.51 |
|  |   | 24                 | 7.4                              | 3.07 | 7.7  | 3.09 | 8.1  | 2.98 | 8.1  | 2.79 | 8.1  | 2.57 |
| S-36PN1E5A×3<br>U-100PE1E5A<br>(U-100PE1E8A) | 220V-230V-240V<br>50Hz 1phase<br>(380V-400V-415V<br>50Hz 3 phase) | 16                 | 15.1                             | 5.08 | 15.1 | 4.88 | 15.1 | 4.25 | 15.1 | 3.74 | 15.1 | 3.17 |
|  |   | 20                 | 14.0                             | 5.38 | 14.0 | 5.17 | 14.0 | 4.50 | 14.0 | 3.96 | 14.0 | 3.35 |
|  |   | 24                 | 13.1                             | 5.46 | 13.1 | 5.25 | 13.1 | 4.57 | 13.1 | 4.03 | 13.1 | 3.41 |
| S-50PN1E5A×2<br>U-100PE1E5A<br>(U-100PE1E8A) | 220V-230V-240V<br>50Hz 1phase<br>(380V-400V-415V<br>50Hz 3 phase) | 16                 | 15.1                             | 5.08 | 15.1 | 4.88 | 15.1 | 4.25 | 15.1 | 3.74 | 15.1 | 3.17 |
|  |   | 20                 | 14.0                             | 5.38 | 14.0 | 5.17 | 14.0 | 4.50 | 14.0 | 3.96 | 14.0 | 3.35 |
|  |   | 24                 | 13.1                             | 5.46 | 13.1 | 5.25 | 13.1 | 4.57 | 13.1 | 4.03 | 13.1 | 3.41 |
| S-36PN1E5A×4<br>U-125PE1E5A<br>(U-125PE1E8A) | 220V-230V-240V<br>50Hz 1phase<br>(380V-400V-415V<br>50Hz 3 phase) | 16                 | 16.7                             | 5.73 | 17.2 | 5.64 | 17.3 | 5.10 | 17.3 | 4.49 | 17.3 | 3.80 |
|  |   | 20                 | 15.5                             | 6.06 | 15.9 | 5.96 | 16.0 | 5.40 | 16.0 | 4.75 | 16.0 | 4.02 |
|  |   | 24                 | 14.5                             | 6.16 | 14.9 | 6.06 | 15.0 | 5.49 | 15.0 | 4.83 | 15.0 | 4.09 |
| S-45PN1E5A×3<br>U-125PE1E5A<br>(U-125PE1E8A) | 220V-230V-240V<br>50Hz 1phase<br>(380V-400V-415V<br>50Hz 3 phase) | 16                 | 16.7                             | 5.73 | 17.2 | 5.64 | 17.3 | 5.10 | 17.3 | 4.49 | 17.3 | 3.80 |
|  |   | 20                 | 15.5                             | 6.06 | 15.9 | 5.96 | 16.0 | 5.40 | 16.0 | 4.75 | 16.0 | 4.02 |
|  |   | 24                 | 14.5                             | 6.16 | 14.9 | 6.06 | 15.0 | 5.49 | 15.0 | 4.83 | 15.0 | 4.09 |
| S-60PN1E5A×2<br>U-125PE1E5A<br>(U-125PE1E8A) | 220V-230V-240V<br>50Hz 1phase<br>(380V-400V-415V<br>50Hz 3 phase) | 16                 | 16.7                             | 5.73 | 17.2 | 5.64 | 17.3 | 5.10 | 17.3 | 4.49 | 17.3 | 3.80 |
|  |   | 20                 | 15.5                             | 6.06 | 15.9 | 5.96 | 16.0 | 5.40 | 16.0 | 4.75 | 16.0 | 4.02 |
|  |   | 24                 | 14.5                             | 6.16 | 14.9 | 6.06 | 15.0 | 5.49 | 15.0 | 4.83 | 15.0 | 4.09 |
| S-50PN1E5A×3<br>U-140PE1E5A<br>(U-140PE1E8A) | 220V-230V-240V<br>50Hz 1phase<br>(380V-400V-415V<br>50Hz 3 phase) | 16                 | 18.1                             | 5.91 | 19.2 | 5.89 | 19.4 | 5.76 | 19.4 | 5.08 | 19.4 | 4.29 |
|  |   | 20                 | 16.7                             | 6.26 | 17.8 | 6.23 | 18.0 | 6.10 | 18.0 | 5.37 | 18.0 | 4.54 |
|  |   | 24                 | 15.7                             | 6.36 | 16.7 | 6.33 | 16.9 | 6.20 | 16.9 | 5.46 | 16.9 | 4.62 |
| S-71PN1E5A×2<br>U-140PE1E5A<br>(U-140PE1E8A) | 220V-230V-240V<br>50Hz 1phase<br>(380V-400V-415V<br>50Hz 3 phase) | 16                 | 18.1                             | 5.91 | 19.2 | 5.89 | 19.4 | 5.76 | 19.4 | 5.08 | 19.4 | 4.29 |
|  |   | 20                 | 16.7                             | 6.26 | 17.8 | 6.23 | 18.0 | 6.10 | 18.0 | 5.37 | 18.0 | 4.54 |
|  |   | 24                 | 15.7                             | 6.36 | 16.7 | 6.33 | 16.9 | 6.20 | 16.9 | 5.46 | 16.9 | 4.62 |



**1-13. Capacity Table**

**2. Heating Capacity Performance Data**

TC :Cooling Capacity

IPT :Cooling Power Consumption

**• Combination of Single Unit**

4-Way Cassette 60×60 Type

unit : kW

| Model                    | Power Source                  | Ambient Return Air | Outdoor air intake temp(°C W.B.) |      |     |      |     |      |      |      |      |      |
|--------------------------|-------------------------------|--------------------|----------------------------------|------|-----|------|-----|------|------|------|------|------|
|                          |                               |                    | -5°C                             |      | 0°C |      | 6°C |      | 10°C |      | 15°C |      |
|                          |                               |                    | DB                               | TC   | IPT | TC   | IPT | TC   | IPT  | TC   | IPT  | TC   |
| S-36PY2E5A<br>U-36PE1E5A | 220V-230V-240V<br>50Hz 1phase | 16                 | 4.4                              | 1.17 | 4.8 | 1.22 | 5.1 | 1.29 | 5.5  | 1.34 | 6.0  | 1.41 |
|                          |                               | 20                 | 4.3                              | 1.24 | 4.6 | 1.30 | 5.0 | 1.36 | 5.4  | 1.41 | 5.9  | 1.48 |
|                          |                               | 24                 | 4.2                              | 1.35 | 4.5 | 1.41 | 4.9 | 1.47 | 5.3  | 1.52 | 5.8  | 1.59 |
| S-50PY2E5A<br>U-50PE2E5A | 220V-230V-240V<br>50Hz 1phase | 16                 | 5.8                              | 2.23 | 6.4 | 2.39 | 6.6 | 2.05 | 7.1  | 1.99 | 8.3  | 2.23 |
|                          |                               | 20                 | 5.6                              | 2.34 | 6.3 | 2.51 | 6.5 | 2.17 | 6.9  | 2.11 | 8.1  | 2.34 |
|                          |                               | 24                 | 5.5                              | 2.52 | 6.1 | 2.68 | 6.4 | 2.35 | 6.8  | 2.28 | 8.0  | 2.52 |

## 1-13. Capacity Table

### 2. Heating Capacity Performance Data

TC :Cooling Capacity

IPT :Cooling Power Consumption

#### • Combination of Multiple Unit

4-Way Cassette 60×60 Type

unit : kW

| Model                                      | Power Source  | Ambient Return Air | Outdoor air intake temp(°C W.B.) |      |      |      |      |      |      |      |      |      |
|--|---|--------------------|----------------------------------|------|------|------|------|------|------|------|------|------|
|  |   |                    | -5°C                             |      | 0°C  |      | 6°C  |      | 10°C |      | 15°C |      |
|  |   |                    | TC                               | IPT  | TC   | IPT  | TC   | IPT  | TC   | IPT  | TC   | IPT  |
| S-36PY2E5A×2<br>U-71PE1E5<br>(U-71PE1E8)   | 220V-230V-240V<br>50Hz 1phase<br>(380V-400V-415V<br>50Hz 3 phase) | 16                 | 8.2                              | 2.88 | 8.5  | 2.90 | 9.7  | 2.86 | 9.9  | 2.67 | 9.9  | 2.47 |
|  |   | 20                 | 7.8                              | 2.96 | 8.1  | 2.98 | 9.0  | 2.90 | 9.0  | 2.72 | 9.0  | 2.49 |
|  |   | 24                 | 7.4                              | 3.05 | 7.7  | 3.07 | 8.1  | 2.96 | 8.1  | 2.78 | 8.1  | 2.55 |
| S-36PY2E5A×3<br>U-100PE1E5<br>(U-100PE1E8) | 220V-230V-240V<br>50Hz 1phase<br>(380V-400V-415V<br>50Hz 3 phase) | 16                 | 15.1                             | 4.97 | 15.1 | 4.77 | 15.1 | 4.16 | 15.1 | 3.66 | 15.1 | 3.10 |
|  |   | 20                 | 14.0                             | 5.26 | 14.0 | 5.05 | 14.0 | 4.40 | 14.0 | 3.87 | 14.0 | 3.28 |
|  |   | 24                 | 13.1                             | 5.34 | 13.1 | 5.13 | 13.1 | 4.47 | 13.1 | 3.94 | 13.1 | 3.33 |
| S-50PY2E5A×2<br>U-100PE1E5<br>(U-100PE1E8) | 220V-230V-240V<br>50Hz 1phase<br>(380V-400V-415V<br>50Hz 3 phase) | 16                 | 15.1                             | 4.97 | 15.1 | 4.77 | 15.1 | 4.16 | 15.1 | 3.66 | 15.1 | 3.10 |
|  |   | 20                 | 14.0                             | 5.26 | 14.0 | 5.05 | 14.0 | 4.40 | 14.0 | 3.87 | 14.0 | 3.28 |
|  |   | 24                 | 13.1                             | 5.34 | 13.1 | 5.13 | 13.1 | 4.47 | 13.1 | 3.94 | 13.1 | 3.33 |
| S-36PY2E5A×4<br>U-125PE1E5<br>(U-125PE1E8) | 220V-230V-240V<br>50Hz 1phase<br>(380V-400V-415V<br>50Hz 3 phase) | 16                 | 16.7                             | 5.52 | 17.2 | 5.43 | 17.3 | 4.91 | 17.3 | 4.33 | 17.3 | 3.66 |
|  |   | 20                 | 15.5                             | 5.84 | 15.9 | 5.74 | 16.0 | 5.20 | 16.0 | 4.58 | 16.0 | 3.87 |
|  |   | 24                 | 14.5                             | 5.93 | 14.9 | 5.84 | 15.0 | 5.28 | 15.0 | 4.65 | 15.0 | 3.94 |
| S-45PY2E5A×3<br>U-125PE1E5<br>(U-125PE1E8) | 220V-230V-240V<br>50Hz 1phase<br>(380V-400V-415V<br>50Hz 3 phase) | 16                 | 16.7                             | 5.52 | 17.2 | 5.43 | 17.3 | 4.91 | 17.3 | 4.33 | 17.3 | 3.66 |
|  |   | 20                 | 15.5                             | 5.84 | 15.9 | 5.74 | 16.0 | 5.20 | 16.0 | 4.58 | 16.0 | 3.87 |
|  |   | 24                 | 14.5                             | 5.93 | 14.9 | 5.84 | 15.0 | 5.28 | 15.0 | 4.65 | 15.0 | 3.94 |
| S-50PY2E5A×3<br>U-140PE1E5<br>(U-140PE1E8) | 220V-230V-240V<br>50Hz 1phase<br>(380V-400V-415V<br>50Hz 3 phase) | 16                 | 18.1                             | 5.72 | 19.2 | 5.69 | 19.4 | 5.57 | 19.4 | 4.91 | 19.4 | 4.15 |
|  |   | 20                 | 16.7                             | 6.05 | 17.8 | 6.02 | 18.0 | 5.90 | 18.0 | 5.19 | 18.0 | 4.40 |
|  |   | 24                 | 15.7                             | 6.15 | 16.7 | 6.12 | 16.9 | 6.00 | 16.9 | 5.28 | 16.9 | 4.47 |

**1-13. Capacity Table**

**2. Heating Capacity Performance Data**

TC :Cooling Capacity

IPT :Cooling Power Consumption

• **Combination of Single Unit**

4-Way Cassette Type

unit : kW

| Model                                       | Power Source  | Ambient Return Air | Outdoor air intake temp(°C W.B.) |      |      |      |      |      |      |      |      |      |  |
|---|---|--------------------|----------------------------------|------|------|------|------|------|------|------|------|------|--|
|   |   |                    | -5°C                             |      | 0°C  |      | 6°C  |      | 10°C |      | 15°C |      |  |
|   |   |                    | TC                               | IPT  | TC   | IPT  | TC   | IPT  | TC   | IPT  | TC   | IPT  |  |
| S-60PU2E5A<br>U-60PEY2E5                    | 220V-230V-240V<br>50Hz 1phase                                     | DB                 |                                  |      |      |      |      |      |      |      |      |      |  |
|   |   | 16                 | 6.1                              | 1.71 | 7.0  | 1.90 | 7.2  | 1.55 | 7.2  | 1.35 | 7.8  | 1.38 |  |
|   |   | 20                 | 5.9                              | 1.82 | 6.8  | 2.03 | 7.0  | 1.65 | 7.0  | 1.43 | 7.6  | 1.47 |  |
|   |   | 24                 | 5.9                              | 1.95 | 6.8  | 2.17 | 7.0  | 1.76 | 7.0  | 1.53 | 7.6  | 1.58 |  |
| S-71PU2E5A<br>U-71PEY2E5                    | 220V-230V-240V<br>50Hz 1phase                                     | 16                 | 7.0                              | 2.28 | 8.1  | 2.54 | 8.3  | 2.07 | 8.3  | 1.80 | 9.0  | 1.84 |  |
|   |   | 20                 | 6.8                              | 2.43 | 7.9  | 2.70 | 8.1  | 2.20 | 8.1  | 1.91 | 8.8  | 1.96 |  |
|   |   | 24                 | 6.8                              | 2.60 | 7.9  | 2.89 | 8.1  | 2.35 | 8.1  | 2.04 | 8.7  | 2.10 |  |
| S-100PU2E5A<br>U-100PEY1E5<br>(U-100PEY1E8) | 220V-230V-240V<br>50Hz 1phase<br>(380V-400V-415V<br>50Hz 3 phase) | 16                 | 13.4                             | 4.37 | 13.9 | 3.95 | 14.9 | 3.78 | 13.9 | 2.87 | 15.6 | 3.00 |  |
|   |   | 20                 | 12.4                             | 4.63 | 12.9 | 4.19 | 13.8 | 4.00 | 12.9 | 3.03 | 14.5 | 3.18 |  |
|   |   | 24                 | 11.6                             | 4.70 | 12.1 | 4.25 | 12.9 | 4.06 | 12.0 | 3.08 | 13.5 | 3.23 |  |
| S-125PU2E5A<br>U-125PEY1E5<br>(U-125PEY1E8) | 220V-230V-240V<br>50Hz 1phase<br>(380V-400V-415V<br>50Hz 3 phase) | 16                 | 14.5                             | 4.81 | 15.2 | 4.35 | 16.2 | 4.16 | 15.1 | 3.15 | 17.0 | 3.30 |  |
|   |   | 20                 | 13.5                             | 5.09 | 14.0 | 4.60 | 15.0 | 4.40 | 14.0 | 3.34 | 15.7 | 3.50 |  |
|   |   | 24                 | 12.6                             | 5.17 | 13.1 | 4.68 | 14.0 | 4.47 | 13.1 | 3.39 | 14.7 | 3.55 |  |
| S-140PU2E5A<br>U-140PEY1E8                  | 220V-230V-240V<br>50Hz 1phase<br>(380V-400V-415V<br>50Hz 3 phase) | 16                 | 16.7                             | 5.52 | 17.2 | 5.43 | 17.3 | 4.91 | 17.3 | 4.33 | 17.3 | 3.66 |  |
|   |   | 20                 | 15.5                             | 5.84 | 15.9 | 5.74 | 16.0 | 5.20 | 16.0 | 4.58 | 16.0 | 3.87 |  |
|   |   | 24                 | 14.5                             | 5.93 | 14.9 | 5.84 | 15.0 | 5.28 | 15.0 | 4.65 | 15.0 | 3.94 |  |

## 1-13. Capacity Table

### 2. Heating Capacity Performance Data

TC :Cooling Capacity

IPT :Cooling Power Consumption

#### • Combination of Multiple Unit

unit : kW

#### 4-Way Cassette Type

| Model  | Power Source  | Ambient Return Air | Outdoor air intake temp(°C W.B.) |      |      |      |      |      |      |      |      |      |
|--|---|--------------------|----------------------------------|------|------|------|------|------|------|------|------|------|
|  |   |                    | -5°C                             |      | 0°C  |      | 6°C  |      | 10°C |      | 15°C |      |
|  |   |                    | TC                               | IPT  | TC   | IPT  | TC   | IPT  | TC   | IPT  | TC   | IPT  |
| S-50PU2E5A×2<br>U-100PEY1E5<br>(U-100PEY1E8) | 220V-230V-240V<br>50Hz 1phase<br>(380V-400V-415V<br>50Hz 3 phase) | 16                 | 13.4                             | 4.37 | 13.9 | 3.95 | 14.9 | 3.78 | 13.9 | 2.87 | 15.6 | 3.00 |
|  |   | 20                 | 12.4                             | 4.63 | 12.9 | 4.19 | 13.8 | 4.00 | 12.9 | 3.03 | 14.5 | 3.18 |
|  |   | 24                 | 11.6                             | 4.70 | 12.1 | 4.25 | 12.9 | 4.06 | 12.0 | 3.08 | 13.5 | 3.23 |
| S-60PU2E5A×2<br>U-125PEY1E5<br>(U-125PEY1E8) | 220V-230V-240V<br>50Hz 1phase<br>(380V-400V-415V<br>50Hz 3 phase) | 16                 | 14.5                             | 4.81 | 15.2 | 4.35 | 16.2 | 4.16 | 15.1 | 3.15 | 17.0 | 3.30 |
|  |   | 20                 | 13.5                             | 5.09 | 14.0 | 4.60 | 15.0 | 4.40 | 14.0 | 3.34 | 15.7 | 3.50 |
|  |   | 24                 | 12.6                             | 5.17 | 13.1 | 4.68 | 14.0 | 4.47 | 13.1 | 3.39 | 14.7 | 3.55 |
| S-71PU2E5A×2<br>U-140PEY1E8                  | 220V-230V-240V<br>50Hz 1phase<br>380V-400V-415V<br>50Hz 3 phase   | 16                 | 16.7                             | 5.52 | 17.2 | 5.43 | 17.3 | 4.91 | 17.3 | 4.33 | 17.3 | 3.66 |
|  |   | 20                 | 15.5                             | 5.84 | 15.9 | 5.74 | 16.0 | 5.20 | 16.0 | 4.58 | 16.0 | 3.87 |
|  |   | 24                 | 14.5                             | 5.93 | 14.9 | 5.84 | 15.0 | 5.28 | 15.0 | 4.65 | 15.0 | 3.94 |

**1-13. Capacity Table**

**2. Heating Capacity Performance Data**

TC :Cooling Capacity

IPT :Cooling Power Consumption

**• Combination of Single Unit**

unit : kW

Ceiling Type

| Model                                       | Power Source  | Ambient Return Air | Outdoor air intake temp(°C W.B.) |      |      |      |      |      |      |      |      |      |
|---|---|--------------------|----------------------------------|------|------|------|------|------|------|------|------|------|
|   |   |                    | -5°C                             |      | 0°C  |      | 6°C  |      | 10°C |      | 15°C |      |
|   |   |                    | TC                               | IPT  | TC   | IPT  | TC   | IPT  | TC   | IPT  | TC   | IPT  |
| S-60PT2E5A<br>U-60PEY2E5                    | 220V-230V-240V<br>50Hz 1phase                                     | DB                 |                                  |      |      |      |      |      |      |      |      |      |
|   |   | 16                 | 6.1                              | 1.66 | 7.0  | 1.84 | 7.2  | 1.50 | 7.2  | 1.31 | 7.8  | 1.34 |
|   |   | 20                 | 5.9                              | 1.77 | 6.8  | 1.96 | 7.0  | 1.60 | 7.0  | 1.39 | 7.6  | 1.43 |
| S-71PT2E5A<br>U-71PEY2E5                    | 220V-230V-240V<br>50Hz 1phase                                     | 16                 | 7.0                              | 2.23 | 8.1  | 2.48 | 8.3  | 2.02 | 8.3  | 1.75 | 9.0  | 1.80 |
|   |   | 20                 | 6.8                              | 2.38 | 7.9  | 2.64 | 8.1  | 2.15 | 8.1  | 1.87 | 8.8  | 1.92 |
|   |   | 24                 | 6.8                              | 2.54 | 7.9  | 2.82 | 8.1  | 2.30 | 8.1  | 2.00 | 8.7  | 2.05 |
| S-100PT2E5A<br>U-100PEY1E5<br>(U-100PEY1E8) | 220V-230V-240V<br>50Hz 1phase<br>(380V-400V-415V<br>50Hz 3 phase) | 16                 | 13.4                             | 4.37 | 13.9 | 3.95 | 14.9 | 3.78 | 13.9 | 2.87 | 15.6 | 3.00 |
|   |   | 20                 | 12.4                             | 4.63 | 12.9 | 4.19 | 13.8 | 4.00 | 12.9 | 3.03 | 14.5 | 3.18 |
|   |   | 24                 | 11.6                             | 4.70 | 12.1 | 4.25 | 12.9 | 4.06 | 12.0 | 3.08 | 13.5 | 3.23 |
| S-125PT2E5A<br>U-125PEY1E5<br>(U-125PEY1E8) | 220V-230V-240V<br>50Hz 1phase<br>(380V-400V-415V<br>50Hz 3 phase) | 16                 | 14.5                             | 4.81 | 15.2 | 4.35 | 16.2 | 4.16 | 15.1 | 3.15 | 17.0 | 3.30 |
|   |   | 20                 | 13.5                             | 5.09 | 14.0 | 4.60 | 15.0 | 4.40 | 14.0 | 3.34 | 15.7 | 3.50 |
|   |   | 24                 | 12.6                             | 5.17 | 13.1 | 4.68 | 14.0 | 4.47 | 13.1 | 3.39 | 14.7 | 3.55 |
| S-140PT2E5A<br>U-140PEY1E8                  | 220V-230V-240V<br>50Hz 1phase<br>380V-400V-415V<br>50Hz 3 phase   | 16                 | 16.7                             | 5.53 | 17.2 | 5.44 | 17.3 | 4.92 | 17.3 | 4.34 | 17.3 | 3.67 |
|   |   | 20                 | 15.5                             | 5.85 | 15.9 | 5.75 | 16.0 | 5.21 | 16.0 | 4.59 | 16.0 | 3.88 |
|   |   | 24                 | 14.5                             | 5.94 | 14.9 | 5.85 | 15.0 | 5.29 | 15.0 | 4.66 | 15.0 | 3.94 |

## 1-13. Capacity Table

### 2. Heating Capacity Performance Data

TC :Cooling Capacity

IPT :Cooling Power Consumption

#### • Combination of Multiple Unit

unit : kW

Ceiling Type

| Model  | Power Source  | Ambient Return Air | Outdoor air intake temp(°C W.B.) |      |      |      |      |      |      |      |      |      |
|--|---|--------------------|----------------------------------|------|------|------|------|------|------|------|------|------|
|  |   |                    | -5°C                             |      | 0°C  |      | 6°C  |      | 10°C |      | 15°C |      |
|  |   |                    | TC                               | IPT  | TC   | IPT  | TC   | IPT  | TC   | IPT  | TC   | IPT  |
| S-50PT2E5A×2<br>U-100PEY1E5<br>(U-100PEY1E8) | 220V-230V-240V<br>50Hz 1phase<br>(380V-400V-415V<br>50Hz 3 phase) | 16                 | 13.4                             | 4.37 | 13.9 | 3.95 | 14.9 | 3.78 | 13.9 | 2.87 | 15.6 | 3.00 |
|  |   | 20                 | 12.4                             | 4.63 | 12.9 | 4.19 | 13.8 | 4.00 | 12.9 | 3.03 | 14.5 | 3.18 |
|  |   | 24                 | 11.6                             | 4.70 | 12.1 | 4.25 | 12.9 | 4.06 | 12.0 | 3.08 | 13.5 | 3.23 |
| S-60PT2E5A×2<br>U-125PEY1E5<br>(U-125PEY1E8) | 220V-230V-240V<br>50Hz 1phase<br>(380V-400V-415V<br>50Hz 3 phase) | 16                 | 14.5                             | 4.81 | 15.2 | 4.35 | 16.2 | 4.16 | 15.1 | 3.15 | 17.0 | 3.30 |
|  |   | 20                 | 13.5                             | 5.09 | 14.0 | 4.60 | 15.0 | 4.40 | 14.0 | 3.34 | 15.7 | 3.50 |
|  |   | 24                 | 12.6                             | 5.17 | 13.1 | 4.68 | 14.0 | 4.47 | 13.1 | 3.39 | 14.7 | 3.55 |
| S-71PT2E5A×2<br>U-140PEY1E8                  | 220V-230V-240V<br>50Hz 1phase<br>(380V-400V-415V<br>50Hz 3 phase) | 16                 | 16.7                             | 5.53 | 17.2 | 5.44 | 17.3 | 4.92 | 17.3 | 4.34 | 17.3 | 3.67 |
|  |   | 20                 | 15.5                             | 5.85 | 15.9 | 5.75 | 16.0 | 5.21 | 16.0 | 4.59 | 16.0 | 3.88 |
|  |   | 24                 | 14.5                             | 5.94 | 14.9 | 5.85 | 15.0 | 5.29 | 15.0 | 4.66 | 15.0 | 3.94 |

**1-13. Capacity Table**

**2. Heating Capacity Performance Data**

TC :Cooling Capacity

IPT :Cooling Power Consumption

**• Combination of Single Unit**

Wall Mounted Type

unit : kW

| Model                                       | Power Source  | Ambient Return Air | Outdoor air intake temp(°C W.B.) |      |      |      |      |      |      |      |      |      |
|---|---|--------------------|----------------------------------|------|------|------|------|------|------|------|------|------|
|   |   |                    | -5°C                             |      | 0°C  |      | 6°C  |      | 10°C |      | 15°C |      |
|   |   |                    | DB                               | TC   | IPT  | TC   | IPT  | TC   | IPT  | TC   | IPT  | TC   |
| S-60PK1E5A<br>U-60PEY2E5                    | 220V-230V-240V<br>50Hz 1phase                                     | 16                 | 6.1                              | 1.76 | 7.0  | 1.96 | 7.2  | 1.60 | 7.2  | 1.39 | 7.8  | 1.42 |
|   |   | 20                 | 5.9                              | 1.88 | 6.8  | 2.09 | 7.0  | 1.70 | 7.0  | 1.48 | 7.6  | 1.52 |
|   |   | 24                 | 5.9                              | 2.01 | 6.8  | 2.23 | 7.0  | 1.82 | 7.0  | 1.58 | 7.6  | 1.62 |
| S-71PK1E5A<br>U-71PEY2E5                    | 220V-230V-240V<br>50Hz 1phase                                     | 16                 | 7.0                              | 2.34 | 8.1  | 2.59 | 8.3  | 2.11 | 8.3  | 1.84 | 9.0  | 1.89 |
|   |   | 20                 | 6.8                              | 2.49 | 7.9  | 2.76 | 8.1  | 2.25 | 8.1  | 1.96 | 8.8  | 2.01 |
|   |   | 24                 | 6.8                              | 2.66 | 7.9  | 2.95 | 8.1  | 2.41 | 8.1  | 2.09 | 8.7  | 2.15 |
| S-100PK1E5A<br>U-100PEY1E5<br>(U-100PEY1E8) | 220V-230V-240V<br>50Hz 1phase<br>(380V-400V-415V<br>50Hz 3 phase) | 16                 | 10.2                             | 3.28 | 10.6 | 2.97 | 11.3 | 2.83 | 10.6 | 2.15 | 11.9 | 2.25 |
|   |   | 20                 | 9.4                              | 3.47 | 9.8  | 3.14 | 10.5 | 3.00 | 9.8  | 2.28 | 11.0 | 2.38 |
|   |   | 24                 | 8.8                              | 3.53 | 9.2  | 3.19 | 9.8  | 3.05 | 9.2  | 2.31 | 10.3 | 2.42 |

### 1-13. Capacity Table

#### 2. Heating Capacity Performance Data

TC :Cooling Capacity

IPT :Cooling Power Consumption

##### • Combination of Multiple Unit

Wall Mounted Type

unit : kW

| Model  | Power Source  | Ambient Return Air | Outdoor air intake temp(°C W.B.) |      |      |      |      |      |      |      |      |      |
|--|---|--------------------|----------------------------------|------|------|------|------|------|------|------|------|------|
|  |   |                    | -5°C                             |      | 0°C  |      | 6°C  |      | 10°C |      | 15°C |      |
|  |   |                    | TC                               | IPT  | TC   | IPT  | TC   | IPT  | TC   | IPT  | TC   | IPT  |
|  |   | DB                 |                                  |      |      |      |      |      |      |      |      |      |
| S-50PK1E5A×2<br>U-100PEY1E5<br>(U-100PEY1E8) | 220V-230V-240V<br>50Hz 1phase<br>(380V-400V-415V<br>50Hz 3 phase) | 16                 | 12.0                             | 4.37 | 12.5 | 3.95 | 13.4 | 3.78 | 12.5 | 2.87 | 14.0 | 3.00 |
|  |   | 20                 | 11.1                             | 4.63 | 11.6 | 4.19 | 12.4 | 4.00 | 11.6 | 3.03 | 13.0 | 3.18 |
|  |   | 24                 | 10.4                             | 4.70 | 10.9 | 4.25 | 11.6 | 4.06 | 10.8 | 3.08 | 12.2 | 3.23 |



**1-13. Capacity Table**

**2. Heating Capacity Performance Data**

TC :Cooling Capacity

IPT :Cooling Power Consumption

**• Combination of Single Unit**

Low Silhouette Ducted Type

unit : kW

| Model                                       | Power Source  | Ambient Return Air | Outdoor air intake temp(°C W.B.) |      |      |      |      |      |      |      |      |      |
|---|---|--------------------|----------------------------------|------|------|------|------|------|------|------|------|------|
|   |   |                    | -5°C                             |      | 0°C  |      | 6°C  |      | 10°C |      | 15°C |      |
|   |   |                    | TC                               | IPT  | TC   | IPT  | TC   | IPT  | TC   | IPT  | TC   | IPT  |
| S-60PF1E5A<br>U-60PEY2E5                    | 220V-230V-240V<br>50Hz 1phase                                     | 16                 | 6.1                              | 1.76 | 7.0  | 1.96 | 7.2  | 1.60 | 7.2  | 1.39 | 7.8  | 1.42 |
|   |   | 20                 | 5.9                              | 1.88 | 6.8  | 2.09 | 7.0  | 1.70 | 7.0  | 1.48 | 7.6  | 1.52 |
|   |   | 24                 | 5.9                              | 2.01 | 6.8  | 2.23 | 7.0  | 1.82 | 7.0  | 1.58 | 7.6  | 1.62 |
| S-71PF1E5A<br>U-71PEY2E5                    | 220V-230V-240V<br>50Hz 1phase                                     | 16                 | 7.0                              | 2.28 | 8.1  | 2.54 | 8.3  | 2.07 | 8.3  | 1.80 | 9.0  | 1.84 |
|   |   | 20                 | 6.8                              | 2.43 | 7.9  | 2.70 | 8.1  | 2.20 | 8.1  | 1.91 | 8.8  | 1.96 |
|   |   | 24                 | 6.8                              | 2.60 | 7.9  | 2.89 | 8.1  | 2.35 | 8.1  | 2.04 | 8.7  | 2.10 |
| S-100PF1E5A<br>U-100PEY1E5<br>(U-100PEY1E8) | 220V-230V-240V<br>50Hz 1phase<br>(380V-400V-415V<br>50Hz 3 phase) | 16                 | 13.4                             | 4.37 | 13.9 | 3.95 | 14.9 | 3.78 | 13.9 | 2.87 | 15.6 | 3.00 |
|   |   | 20                 | 12.4                             | 4.63 | 12.9 | 4.19 | 13.8 | 4.00 | 12.9 | 3.03 | 14.5 | 3.18 |
|   |   | 24                 | 11.6                             | 4.70 | 12.1 | 4.25 | 12.9 | 4.06 | 12.0 | 3.08 | 13.5 | 3.23 |
| S-125PF1E5A<br>U-125PEY1E5<br>(U-125PEY1E8) | 220V-230V-240V<br>50Hz 1phase<br>(380V-400V-415V<br>50Hz 3 phase) | 16                 | 14.5                             | 4.81 | 15.2 | 4.35 | 16.2 | 4.16 | 15.1 | 3.15 | 17.0 | 3.30 |
|   |   | 20                 | 13.5                             | 5.09 | 14.0 | 4.60 | 15.0 | 4.40 | 14.0 | 3.34 | 15.7 | 3.50 |
|   |   | 24                 | 12.6                             | 5.17 | 13.1 | 4.68 | 14.0 | 4.47 | 13.1 | 3.39 | 14.7 | 3.55 |
| S-140PF1E5A<br>U-140PEY1E8                  | 220V-230V-240V<br>50Hz 1phase<br>380V-400V-415V<br>50Hz 3 phase   | 16                 | 16.7                             | 5.52 | 17.2 | 5.43 | 17.3 | 4.91 | 17.3 | 4.33 | 17.3 | 3.66 |
|   |   | 20                 | 15.5                             | 5.84 | 15.9 | 5.74 | 16.0 | 5.20 | 16.0 | 4.58 | 16.0 | 3.87 |
|   |   | 24                 | 14.5                             | 5.93 | 14.9 | 5.84 | 15.0 | 5.28 | 15.0 | 4.65 | 15.0 | 3.94 |

## 1-13. Capacity Table

### 2. Heating Capacity Performance Data

TC :Cooling Capacity

IPT :Cooling Power Consumption

#### • Combination of Multiple Unit

Low Silhouette Ducted Type

unit : kW

| Model  | Power Source  | Ambient Return Air | Outdoor air intake temp(°C W.B.) |      |      |      |      |      |      |      |      |      |
|--|---|--------------------|----------------------------------|------|------|------|------|------|------|------|------|------|
|  |   |                    | -5°C                             |      | 0°C  |      | 6°C  |      | 10°C |      | 15°C |      |
|  |   |                    | TC                               | IPT  | TC   | IPT  | TC   | IPT  | TC   | IPT  | TC   | IPT  |
| S-50PF1E5A×2<br>U-100PEY1E5<br>(U-100PEY1E8) | 220V-230V-240V<br>50Hz 1phase<br>(380V-400V-415V<br>50Hz 3 phase) | 16                 | 13.4                             | 4.37 | 13.9 | 3.95 | 14.9 | 3.78 | 13.9 | 2.87 | 15.6 | 3.00 |
|  |   | 20                 | 12.4                             | 4.63 | 12.9 | 4.19 | 13.8 | 4.00 | 12.9 | 3.03 | 14.5 | 3.18 |
|  |   | 24                 | 11.6                             | 4.70 | 12.1 | 4.25 | 12.9 | 4.06 | 12.0 | 3.08 | 13.5 | 3.23 |
| S-60PF1E5A×2<br>U-125PEY1E5<br>(U-125PEY1E8) | 220V-230V-240V<br>50Hz 1phase<br>(380V-400V-415V<br>50Hz 3 phase) | 16                 | 14.5                             | 4.81 | 15.2 | 4.35 | 16.2 | 4.16 | 15.1 | 3.15 | 17.0 | 3.30 |
|  |   | 20                 | 13.5                             | 5.09 | 14.0 | 4.60 | 15.0 | 4.40 | 14.0 | 3.34 | 15.7 | 3.50 |
|  |   | 24                 | 12.6                             | 5.17 | 13.1 | 4.68 | 14.0 | 4.47 | 13.1 | 3.39 | 14.7 | 3.55 |
| S-71PF1E5A×2<br>U-140PEY1E8                  | 220V-230V-240V<br>50Hz 1phase<br>380V-400V-415V<br>50Hz 3 phase   | 16                 | 16.7                             | 5.52 | 17.2 | 5.43 | 17.3 | 4.91 | 17.3 | 4.33 | 17.3 | 3.66 |
|  |   | 20                 | 15.5                             | 5.84 | 15.9 | 5.74 | 16.0 | 5.20 | 16.0 | 4.58 | 16.0 | 3.87 |
|  |   | 24                 | 14.5                             | 5.93 | 14.9 | 5.84 | 15.0 | 5.28 | 15.0 | 4.65 | 15.0 | 3.94 |

**1-13. Capacity Table**

**2. Heating Capacity Performance Data**

TC :Cooling Capacity

IPT :Cooling Power Consumption

**• Combination of Single Unit**

unit : kW

Ducted Type

| Model                                       | Power Source  | Ambient Return Air | Outdoor air intake temp(°C W.B.) |      |      |      |      |      |      |      |      |      |
|---|---|--------------------|----------------------------------|------|------|------|------|------|------|------|------|------|
|   |   |                    | -5°C                             |      | 0°C  |      | 6°C  |      | 10°C |      | 15°C |      |
|   |   |                    | TC                               | IPT  | TC   | IPT  | TC   | IPT  | TC   | IPT  | TC   | IPT  |
| S-60PN1E5A<br>U-60PEY2E5                    | 220V-230V-240V<br>50Hz 1phase                                     | DB                 |                                  |      |      |      |      |      |      |      |      |      |
|   |   | 16                 | 6.1                              | 1.92 | 7.0  | 2.13 | 7.2  | 1.74 | 7.2  | 1.51 | 7.8  | 1.55 |
|   |   | 20                 | 5.9                              | 2.05 | 6.8  | 2.27 | 7.0  | 1.85 | 7.0  | 1.61 | 7.6  | 1.65 |
|   |   | 24                 | 5.9                              | 2.19 | 6.8  | 2.43 | 7.0  | 1.98 | 7.0  | 1.72 | 7.6  | 1.77 |
| S-71PN1E5A<br>U-71PEY2E5                    | 220V-230V-240V<br>50Hz 1phase                                     | 16                 | 7.0                              | 2.54 | 8.1  | 2.82 | 8.3  | 2.30 | 8.3  | 2.00 | 9.0  | 2.05 |
|   |   | 20                 | 6.8                              | 2.71 | 7.9  | 3.01 | 8.1  | 2.45 | 8.1  | 2.13 | 8.8  | 2.19 |
|   |   | 24                 | 6.8                              | 2.90 | 7.9  | 3.22 | 8.1  | 2.62 | 8.1  | 2.28 | 8.7  | 2.34 |
| S-100PN1E5A<br>U-100PEY1E5<br>(U-100PEY1E8) | 220V-230V-240V<br>50Hz 1phase<br>(380V-400V-415V<br>50Hz 3 phase) | 16                 | 13.4                             | 4.48 | 13.9 | 4.05 | 14.9 | 3.87 | 13.9 | 2.94 | 15.6 | 3.08 |
|   |   | 20                 | 12.4                             | 4.74 | 12.9 | 4.29 | 13.8 | 4.10 | 12.9 | 3.11 | 14.5 | 3.26 |
|   |   | 24                 | 11.6                             | 4.82 | 12.1 | 4.36 | 12.9 | 4.17 | 12.0 | 3.16 | 13.5 | 3.31 |
| S-125PN1E5A<br>U-125PEY1E5<br>(U-125PEY1E8) | 220V-230V-240V<br>50Hz 1phase<br>(380V-400V-415V<br>50Hz 3 phase) | 16                 | 14.5                             | 5.03 | 15.2 | 4.55 | 16.2 | 4.35 | 15.1 | 3.30 | 17.0 | 3.45 |
|   |   | 20                 | 13.5                             | 5.32 | 14.0 | 4.81 | 15.0 | 4.60 | 14.0 | 3.49 | 15.7 | 3.65 |
|   |   | 24                 | 12.6                             | 5.41 | 13.1 | 4.89 | 14.0 | 4.67 | 13.1 | 3.55 | 14.7 | 3.71 |
| S-140PN1E5A<br>U-140PEY1E8                  | 220V-230V-240V<br>50Hz 1phase<br>380V-400V-415V<br>50Hz 3 phase   | 16                 | 16.7                             | 5.52 | 17.2 | 5.43 | 17.3 | 4.91 | 17.3 | 4.33 | 17.3 | 3.66 |
|   |   | 20                 | 15.5                             | 5.84 | 15.9 | 5.74 | 16.0 | 5.20 | 16.0 | 4.58 | 16.0 | 3.87 |
|   |   | 24                 | 14.5                             | 5.93 | 14.9 | 5.84 | 15.0 | 5.28 | 15.0 | 4.65 | 15.0 | 3.94 |

## 1-13. Capacity Table

### 2. Heating Capacity Performance Data

TC :Cooling Capacity

IPT :Cooling Power Consumption

#### • Combination of Multiple Unit

unit : kW

Ducted Type

| Model  | Power Source  | Ambient Return Air | Outdoor air intake temp(°C W.B.) |      |      |      |      |      |      |      |      |      |
|--|---|--------------------|----------------------------------|------|------|------|------|------|------|------|------|------|
|  |   |                    | -5°C                             |      | 0°C  |      | 6°C  |      | 10°C |      | 15°C |      |
|  |   |                    | TC                               | IPT  | TC   | IPT  | TC   | IPT  | TC   | IPT  | TC   | IPT  |
| S-50PN1E5A×2<br>U-100PEY1E5<br>(U-100PEY1E8) | 220V-230V-240V<br>50Hz 1phase<br>(380V-400V-415V<br>50Hz 3 phase) | 16                 | 13.4                             | 4.48 | 13.9 | 4.05 | 14.9 | 3.87 | 13.9 | 2.94 | 15.6 | 3.08 |
|  |   | 20                 | 12.4                             | 4.74 | 12.9 | 4.29 | 13.8 | 4.10 | 12.9 | 3.11 | 14.5 | 3.26 |
|  |   | 24                 | 11.6                             | 4.82 | 12.1 | 4.36 | 12.9 | 4.17 | 12.0 | 3.16 | 13.5 | 3.31 |
| S-60PN1E5A×2<br>U-125PEY1E5<br>(U-125PEY1E8) | 220V-230V-240V<br>50Hz 1phase<br>(380V-400V-415V<br>50Hz 3 phase) | 16                 | 14.5                             | 5.03 | 15.2 | 4.55 | 16.2 | 4.35 | 15.1 | 3.30 | 17.0 | 3.45 |
|  |   | 20                 | 13.5                             | 5.32 | 14.0 | 4.81 | 15.0 | 4.60 | 14.0 | 3.49 | 15.7 | 3.65 |
|  |   | 24                 | 12.6                             | 5.41 | 13.1 | 4.89 | 14.0 | 4.67 | 13.1 | 3.55 | 14.7 | 3.71 |
| S-71PN1E5A×2<br>U-140PEY1E8                  | 220V-230V-240V<br>50Hz 1phase<br>380V-400V-415V<br>50Hz 3 phase)  | 16                 | 16.7                             | 5.52 | 17.2 | 5.43 | 17.3 | 4.91 | 17.3 | 4.33 | 17.3 | 3.66 |
|  |   | 20                 | 15.5                             | 5.84 | 15.9 | 5.74 | 16.0 | 5.20 | 16.0 | 4.58 | 16.0 | 3.87 |
|  |   | 24                 | 14.5                             | 5.93 | 14.9 | 5.84 | 15.0 | 5.28 | 15.0 | 4.65 | 15.0 | 3.94 |

### 1-13. Capacity Table

#### 2. Heating Capacity Performance Data

TC :Cooling Capacity

IPT :Cooling Power Consumption

##### • Combination of Multiple Unit




4-Way Cassette 60×60 Type

unit : kW

| Model  | Power Source  | Ambient Return Air | Outdoor air intake temp(°C W.B.) |      |      |      |      |      |      |      |      |      |
|--|---|--------------------|----------------------------------|------|------|------|------|------|------|------|------|------|
|  |   |                    | -5°C                             |      | 0°C  |      | 6°C  |      | 10°C |      | 15°C |      |
|  |   |                    | TC                               | IPT  | TC   | IPT  | TC   | IPT  | TC   | IPT  | TC   | IPT  |
|  |   | DB                 |                                  |      |      |      |      |      |      |      |      |      |
| S-50PY2E5A×2<br>U-100PEY1E5<br>(U-100PEY1E8) | 220V-230V-240V<br>50Hz 1phase<br>(380V-400V-415V<br>50Hz 3 phase) | 16                 | 12.0                             | 4.68 | 12.5 | 4.23 | 13.4 | 4.04 | 12.5 | 3.07 | 14.0 | 3.21 |
|  |   | 20                 | 11.1                             | 4.95 | 11.6 | 4.48 | 12.4 | 4.28 | 11.6 | 3.25 | 13.0 | 3.40 |
|  |   | 24                 | 10.4                             | 5.03 | 10.9 | 4.55 | 11.6 | 4.35 | 10.8 | 3.30 | 12.2 | 3.46 |

1-14. Product Fiche

U-36PE2E5A




|  |              |  |        |          |              |     |                                    |       |        |          |              |  |      |    |       |        |          |              |   |   |  |
|---|--------------|---|--------|----------|--------------|-----|------------------------------------|-------|--------|----------|--------------|---|------|----|-------|--------|----------|--------------|---|---|--|
|   |              | Warmer Heating Season (Optional)  |        |          |              |     | Average Heating Season (Mandatory) |       |        |          |              | Colder Heating Season (Optional)  |      |    |       |        |          |              |   |   |  |
| ①   | ②            | ③   | ④      | ⑤        | ⑥            | ⑦   | ⑧                                  | ⑨     | ⑩      | ⑪        | ⑫            | ⑬   | ⑭    | ⑮  | ⑯     | ⑰      | ⑱        | ⑲            | ⑳ |   |  |
| Indoor Unit   | Outdoor Unit | A ~ G   | kW XYZ | SEER X,Y | kWh/annum XY | ⑬   | ⑭                                  | A ~ G | kW XYZ | SCOP X,Y | kWh/annum XY | ⑮   | ⑯    | ⑰  | A ~ G | kW XYZ | SCOP X,Y | kWh/annum XY | ⑲ |   |  |
|   | S-36PU2E5A   | U-36PE2E5A  | A++    | 3.6      | 7.4          | 170 | 45                                 | 64    | -      | x        | x            | 4.6   | 1095 | 45 | 66    | -      | x        | x            | x | x |  |
|   | S-36PF1E5A   | U-36PE2E5A  | A+     | 3.6      | 5.7          | 221 | 55                                 | 64    | -      | x        | x            | 3.9   | 1292 | 55 | 66    | -      | x        | x            | x | x |  |
|   | S-36PN1E5A   | U-36PE2E5A  | B      | 3.6      | 4.6          | 274 | 57                                 | 64    | -      | x        | x            | 3.8   | 1326 | 57 | 66    | -      | x        | x            | x | x |  |
|   | S-36PK1E5A   | U-36PE2E5A  | A++    | 3.6      | 6.3          | 200 | 52                                 | 64    | -      | x        | x            | 4.2   | 1200 | 52 | 66    | -      | x        | x            | x | x |  |
|   | S-36PT2E5A   | U-36PE2E5A  | A++    | 3.6      | 6.7          | 188 | 54                                 | 64    | -      | x        | x            | 4.3   | 1172 | 54 | 66    | -      | x        | x            | x | x |  |
|   | S-36PY2E5A   | U-36PE2E5A  | A++    | 3.6      | 6.3          | 200 | 51                                 | 64    | -      | x        | x            | 4.1   | 1229 | 51 | 66    | -      | x        | x            | x | x |  |

ENERGIA EHEPTIR - ENERPIJA - ENERGIJA - ENERGI - ENERGI - ENERGI  
6/26/2011

- ① : Panasonic Corporation
- ② : Model Name
- ③ : SEER Grading
- ④ : SCOP Grading (Standard, mandatory)
- ⑤ : SCOP Grading (Warmer, optional)
- ⑥ : SCOP Grading (Colder, optional)
- ⑦ : Design Load kW (round up to one decimal) <Cooling>
- ⑧ : SEER (round up to one decimal)
- ⑨ : Annual Energy Consumption (rounded <Cooling> up to the nearest integer)
- ⑩ : Design Load kW (round up to one decimal) <Heating>
- ⑪ : SCOP (round up to one decimal) <Heating>
- ⑫ : Annual Energy Consumption (rounded up to the nearest integer) <Heating>
- ⑬ : Sound Power level for all indoor units dB (cooling)
- ⑭ : Sound Power level for all outdoor units dB (cooling)
- ⑮ : Sound Power level for all indoor units dB (heating)
- ⑯ : Sound Power level for all outdoor units dB (heating)
- ⑰ : backup heating capacity X,Y,Z kW name of refrigerant and GWP R410A (GWP 1975)
- ⑱ : Refrigerant leakage contributes to climate change. Refrigerant with lower global warming potential (GWP) would contribute less to global warming than a refrigerant with higher GWP, if leaked to the atmosphere. This appliance contains a refrigerant fluid with a GWP equal to 1975. This means that if 1 kg of this refrigerant fluid would be leaked to the atmosphere, the impact on global warming would be 1975 times higher than 1 kg of CO<sub>2</sub>, over a period of 100 years. Never try to interfere with the refrigerant circuit yourself or disassemble the product yourself and always ask a professional.
- ⑳ : Explanation on annual energy consumption based on standard test results. Actual energy consumption will depend on how the appliance is used and where it is located.

1-14. Product Fiche

U-50PE2E5A

|  |              |  |        |          |              |     |                                    |       |        |          |              |  |      |       |        |          |              |       |        |          |              |
|---|--------------|---|--------|----------|--------------|-----|------------------------------------|-------|--------|----------|--------------|---|------|-------|--------|----------|--------------|-------|--------|----------|--------------|
|   |              | Warmer Heating Season (Optional)  |        |          |              |     | Average Heating Season (Mandatory) |       |        |          |              | Colder Heating Season (Optional)  |      |       |        |          |              |       |        |          |              |
| ①   | ②            | ③   | ④      | ⑤        | ⑥            | ⑦   | ⑧                                  | ⑨     | ⑩      | ⑪        | ⑫            | ⑬   | ⑭    | ⑮     | ⑯      | ⑰        | ⑱            | ⑲     | ⑳      |          |              |
| Indoor Unit   | Outdoor Unit | A ~ G   | kW XYZ | SEER X,Y | kWh/annum XY | ⑬   | ⑭                                  | A ~ G | kW XYZ | SCOP X,Y | kWh/annum XY | ⑮   | ⑯    | A ~ G | kW XYZ | SCOP X,Y | kWh/annum XY | A ~ G | kW XYZ | SCOP X,Y | kWh/annum XY |
|   | S-50PU2E5A   | U-50PE2E5A  | A++    | 5.0      | 7.1          | 246 | 47                                 | 65    | -      | x        | x            | 4.4   | 1591 | A+    | 5.0    | 4.4      | 1591         | -     | x      | x        | x            |
|   | S-50PI1E5A   | U-50PE2E5A  | A+     | 5.0      | 5.7          | 307 | 56                                 | 65    | -      | x        | x            | 3.9   | 1436 | A     | 4.0    | 3.9      | 1436         | -     | x      | x        | x            |
|   | S-50PN1E5A   | U-50PE2E5A  | B      | 5.0      | 4.6          | 380 | 58                                 | 65    | -      | x        | x            | 3.8   | 1400 | A     | 3.8    | 3.8      | 1400         | -     | x      | x        | x            |
|   | S-50PK1E5A   | U-50PE2E5A  | A++    | 5.0      | 6.1          | 287 | 57                                 | 65    | -      | x        | x            | 4.0   | 1749 | A+    | 5.0    | 4.0      | 1749         | -     | x      | x        | x            |
|   | S-50PT2E5A   | U-50PE2E5A  | A++    | 5.0      | 6.5          | 269 | 55                                 | 65    | -      | x        | x            | 4.1   | 1707 | A+    | 5.0    | 4.1      | 1707         | -     | x      | x        | x            |
|   | S-50PY2E5A   | U-50PE2E5A  | A++    | 5.0      | 6.1          | 287 | 55                                 | 65    | -      | x        | x            | 3.9   | 1795 | A     | 5.0    | 3.9      | 1795         | -     | x      | x        | x            |

ENERGIA EHEPTIV - ENERPIEIA - ENERGIJA - ENERGI - ENERGI - ENERGI  
6/24/2011

- ① : Panasonic Corporation
- ② : Model Name
- ③ : SEER Grading
- ④ : SCOP Grading (Standard, mandatory)
- ⑤ : SCOP Grading (Warmer, optional)
- ⑥ : SCOP Grading (Colder, optional)
- ⑦ : Design Load kW (round up to one decimal) <Cooling>
- ⑧ : SEER (round up to one decimal)
- ⑨ : Annual Energy Consumption (rounded <Cooling> up to the nearest integer)
- ⑩ : Design Load kW (round up to one decimal) <Heating>
- ⑪ : SCOP (round up to one decimal) <Heating>
- ⑫ : Annual Energy Consumption (rounded up to the nearest integer) <Heating>
- ⑬ : Sound Power level for all indoor units dB (cooling)
- ⑭ : Sound Power level for all outdoor units dB (cooling)
- ⑮ : Sound Power level for all indoor units dB (heating)
- ⑯ : Sound Power level for all outdoor units dB (heating)
- ⑰ : backup heating capacity X,YZ kW name of refrigerant and GWP R410A (GWP 1975)
- ⑱ : Refrigerant leakage contributes to climate change. Refrigerant with lower global warming potential (GWP) would contribute less to global warming than a refrigerant with higher GWP, if leaked to the atmosphere. This appliance contains a refrigerant fluid with a GWP equal to 1975. This means that if 1 kg of this refrigerant fluid would be leaked to the atmosphere, the impact on global warming would be 1975 times higher than 1 kg of CO<sub>2</sub>, over a period of 100 years. Never try to interfere with the refrigerant circuit yourself or disassemble the product yourself and always ask a professional.
- ⑳ : Explanation on annual energy consumption based on standard test results. Actual energy consumption will depend on how the appliance is used and where it is located.









1-14. Product Fiche

U-71PE1E8A

|                  |              | SEER    |           |            |                | Warmer Heating Season (Optional) |                     |         |           | Average Heating Season (Mandatory) |                |                     |                     | Colder Heating Season (Optional) |         |           |            |                |
|------------------|--------------|---------|-----------|------------|----------------|----------------------------------|---------------------|---------|-----------|------------------------------------|----------------|---------------------|---------------------|----------------------------------|---------|-----------|------------|----------------|
| Indoor Unit      | Outdoor Unit | ③ A ~ G | ⑦ kW XY,Z | ⑧ SEER X,Y | ⑨ kWh/annum XY | ⑬ $\zeta_{heating}$              | ⑭ $\zeta_{cooling}$ | ⑤ A ~ G | ⑩ kW XY,Z | ⑪ SCOP X,Y                         | ⑫ kWh/annum XY | ⑮ $\zeta_{heating}$ | ⑯ $\zeta_{cooling}$ | ⑰ elhu. (-10°C) kW X,Y,Z         | ⑥ A ~ G | ⑩ kW XY,Z | ⑪ SCOP X,Y | ⑫ kWh/annum XY |
|                  |              |         |           |            |                |                                  |                     |         |           |                                    |                |                     |                     |                                  |         |           |            |                |
| S-71PU2E5A       | U-71PE1E8A   | A++     | 7.1       | 7.3        | 340            | 52                               | 65                  | A+      | 7.1       | 4.3                                | 2312           | 52                  | 67                  | 0.00                             | -       | x         | x          | x              |
| S-36PU2E5A<br>x2 | U-71PE1E8A   | A++     | 7.1       | 7.1        | 350            | 45                               | 65                  | A+      | 7.1       | 4.3                                | 2312           | 45                  | 67                  | 0.00                             | -       | x         | x          | x              |
| S-71PF1E5A       | U-71PE1E8A   | A+      | 7.1       | 6.0        | 414            | 57                               | 65                  | A       | 7.1       | 3.9                                | 2548           | 57                  | 67                  | 0.42                             | -       | x         | x          | x              |
| S-36PF1E5A<br>x2 | U-71PE1E8A   | A+      | 7.1       | 5.8        | 428            | 55                               | 65                  | A       | 7.1       | 3.9                                | 2548           | 55                  | 67                  | 0.42                             | -       | x         | x          | x              |
| S-71PN1E5A       | U-71PE1E8A   | A       | 7.1       | 5.1        | 487            | 60                               | 65                  | A       | 6.2       | 3.8                                | 2284           | 60                  | 67                  | 0.25                             | -       | x         | x          | x              |
| S-36PN1E5A<br>x2 | U-71PE1E8A   | B       | 7.1       | 4.7        | 531            | 57                               | 65                  | A       | 6.1       | 3.8                                | 2245           | 57                  | 67                  | 0.24                             | -       | x         | x          | x              |
| S-71PK1E5A       | U-71PE1E8A   | A++     | 7.1       | 6.1        | 407            | 64                               | 65                  | A       | 7.1       | 3.8                                | 2616           | 64                  | 67                  | 0.44                             | -       | x         | x          | x              |
| S-36PK1E5A<br>x2 | U-71PE1E8A   | A++     | 7.1       | 6.1        | 407            | 52                               | 65                  | A       | 7.1       | 3.8                                | 2616           | 52                  | 67                  | 0.83                             | -       | x         | x          | x              |
| S-71PT2E5A       | U-71PE1E8A   | A+      | 7.1       | 5.9        | 421            | 57                               | 65                  | A+      | 7.1       | 4.0                                | 2485           | 57                  | 67                  | 0.45                             | -       | x         | x          | x              |
| S-36PT2E5A<br>x2 | U-71PE1E8A   | A+      | 7.1       | 5.9        | 421            | 54                               | 65                  | A+      | 7.1       | 4.0                                | 2485           | 54                  | 67                  | 0.45                             | -       | x         | x          | x              |
| S-36PY2E5A<br>x2 | U-71PE1E8A   | A+      | 7.1       | 5.8        | 428            | 51                               | 65                  | A       | 7.1       | 3.8                                | 2616           | 51                  | 67                  | 1.25                             | -       | x         | x          | x              |

- ① : Panasonic Corporation
- ② : Model Name
- ③ : SEER Grading
- ④ : SCOP Grading (Standard, mandatory)
- ⑤ : SCOP Grading (Warmer, optional)
- ⑥ : SCOP Grading (Colder, optional)
- ⑦ : Design Load kW (round up to one decimal)  
<Cooling>
- ⑧ : SEER (round up to one decimal)
- ⑨ : Annual Energy Consumption (rounded <Cooling> up to the nearest integer)
- ⑩ : Design Load kW (round up to one decimal)  
<Heating>
- ⑪ : SCOP (round up to one decimal)  
<Heating>
- ⑫ : Annual Energy Consumption (rounded to the nearest integer)  
<Heating>
- ⑬ : Sound Power level for all indoor units dB (cooling)
- ⑭ : Sound Power level for all outdoor units dB (cooling)
- ⑮ : Sound Power level for all indoor units dB (heating)
- ⑯ : Sound Power level for all outdoor units dB (heating)
- ⑰ : backup heating capacity X,Y,Z kW name of refrigerant and GWP R410A (GWP 1975)
- ⑱ : Refrigerant leakage contributes to climate change. Refrigerant with lower global warming potential (GWP) would contribute less to global warming than a refrigerant with higher GWP, if leaked to the atmosphere. This appliance contains a refrigerant fluid with a GWP equal to 1975. This means that if 1 kg of this refrigerant fluid would be leaked to the atmosphere, the impact on global warming would be 1975 times higher than 1 kg of CO<sub>2</sub>, over a period of 100 years. Never try to interfere with the refrigerant circuit yourself or disassemble the product yourself and always ask a professional.
- ⑳ : Explanation on annual energy consumption based on standard test results. Actual energy consumption will depend on how the appliance is used and where it is located.





1-14. Product Fiche

U-100PE1E5A

|                  |              | SEER                             |      |          |              |              |                                    |       |         |          |              | SCOP                             |         |          |              |       |         |          |              |       |         |          |
|------------------|--------------|----------------------------------|------|----------|--------------|--------------|------------------------------------|-------|---------|----------|--------------|----------------------------------|---------|----------|--------------|-------|---------|----------|--------------|-------|---------|----------|
|                  |              | Warmer Heating Season (Optional) |      |          |              |              | Average Heating Season (Mandatory) |       |         |          |              | Colder Heating Season (Optional) |         |          |              |       |         |          |              |       |         |          |
| Indoor Unit      | Outdoor Unit | ③                                | ⑦    | ⑧        | ⑨            | ⑬            | ⑭                                  | ⑤     | ⑩       | ⑪        | ⑫            | ④                                | ⑩       | ⑪        | ⑫            | ⑬     | ⑮       | ⑯        | ⑰            | ⑱     | ⑲       | ⑳        |
|                  |              | A ~ G                            | kW   | SEER X,Y | kWh/annum XY | kWh/annum XY | kWh/annum XY                       | A ~ G | kW XY,Z | SCOP X,Y | kWh/annum XY | A ~ G                            | kW XY,Z | SCOP X,Y | kWh/annum XY | A ~ G | kW XY,Z | SCOP X,Y | kWh/annum XY | A ~ G | kW XY,Z | SCOP X,Y |
| S-100PK1E5A      | U-100PE1E5A  | A++                              | 9.5  | 6.2      | 536          | 65           | 69                                 | -     | x       | x        | x            | A                                | 9.5     | 3.8      | 3500         | 65    | 69      | 0.00     | -            | x     | x       | x        |
| S-50PK1E5A<br>x2 | U-100PE1E5A  | A++                              | 10.0 | 6.2      | 564          | 57           | 69                                 | -     | x       | x        | x            | A+                               | 10.0    | 4.0      | 3500         | 57    | 69      | 0.00     | -            | x     | x       | x        |
| S-36PK1E5A<br>x3 | U-100PE1E5A  | A++                              | 10.0 | 6.2      | 564          | 52           | 69                                 | -     | x       | x        | x            | A+                               | 10.0    | 4.0      | 3500         | 52    | 69      | 0.00     | -            | x     | x       | x        |
| S-100PT2E5A      | U-100PE1E5A  | A++                              | 10.0 | 6.7      | 523          | 60           | 69                                 | -     | x       | x        | x            | A+                               | 10.0    | 4.3      | 3256         | 60    | 69      | 0.00     | -            | x     | x       | x        |
| S-50PT2E5A<br>x2 | U-100PE1E5A  | A++                              | 10.0 | 6.5      | 539          | 55           | 69                                 | -     | x       | x        | x            | A+                               | 10.0    | 4.3      | 3256         | 55    | 69      | 0.00     | -            | x     | x       | x        |
| S-36PT2E5A<br>x3 | U-100PE1E5A  | A++                              | 10.0 | 6.5      | 539          | 54           | 69                                 | -     | x       | x        | x            | A+                               | 10.0    | 4.3      | 3256         | 54    | 69      | 0.00     | -            | x     | x       | x        |
| S-50PY2E5A<br>x2 | U-100PE1E5A  | A++                              | 10.0 | 6.5      | 538          | 55           | 69                                 | -     | x       | x        | x            | A                                | 9.5     | 3.8      | 3500         | 55    | 69      | 0.00     | -            | x     | x       | x        |
| S-36PY2E5A<br>x3 | U-100PE1E5A  | A++                              | 10.0 | 6.5      | 538          | 51           | 69                                 | -     | x       | x        | x            | A                                | 9.5     | 3.8      | 3500         | 51    | 69      | 0.00     | -            | x     | x       | x        |

- ① : Panasonic Corporation
- ② : Model Name
- ③ : SEER Grading
- ④ : SCOP Grading (Standard, mandatory)
- ⑤ : SCOP Grading (Warmer, optional)
- ⑥ : SCOP Grading (Colder, optional)
- ⑦ : Design Load kW (round up to one decimal)  
<Cooling>
- ⑧ : SEER (round up to one decimal)
- ⑨ : Annual Energy Consumption (rounded <Cooling> up to the nearest integer)
- ⑩ : Design Load kW (round up to one decimal)  
<Heating>
- ⑪ : SCOP (round up to one decimal)  
<Heating>
- ⑫ : Annual Energy Consumption (rounded up to the nearest integer)  
<Heating>
- ⑬ : Sound Power level for all indoor units dB (cooling)
- ⑭ : Sound Power level for all outdoor units dB (cooling)
- ⑮ : Sound Power level for all indoor units dB (heating)
- ⑯ : Sound Power level for all outdoor units dB (heating)
- ⑰ : backup heating capacity X,Y,Z kW name of refrigerant and GWP R410A (GWP 1975)
- ⑱ : Refrigerant leakage contributes to climate change. Refrigerant with lower global warming potential (GWP) would contribute less to global warming than a refrigerant with higher GWP, if leaked to the atmosphere. This appliance contains a refrigerant fluid with a GWP equal to 1975. This means that if 1 kg of this refrigerant fluid would be leaked to the atmosphere, the impact on global warming would be 1975 times higher than 1 kg of CO<sub>2</sub>, over a period of 100 years. Never try to interfere with the refrigerant circuit yourself or disassemble the product yourself and always ask a professional.
- ⑳ : Explanation on annual energy consumption based on standard test results. Actual energy consumption will depend on how the appliance is used and where it is located.

1-14. Product Fiche

U-100PE1E8A

| ENERGY LABEL   |              | ENERGIA |      | ENERGIA  |              | ENERGIA |    | ENERGIA  |              | ENERGIA |    | ENERGIA  |              | ENERGIA |      | ENERGIA  |              | ENERGIA |    |          |              |
|----------------|--------------|---------|------|----------|--------------|---------|----|----------|--------------|---------|----|----------|--------------|---------|------|----------|--------------|---------|----|----------|--------------|
| Indoor Unit    | Outdoor Unit | ③       | ⑦    | ⑧        | ⑨            | ⑩       | ⑪  | ⑫        | ⑬            | ⑭       | ⑮  | ⑯        | ⑰            | ⑱       | ⑲    | ⑳        | ㉑            | ㉒       | ㉓  |          |              |
|                |              | A ~ G   | kW   | SEER X,Y | kWh/annum XY | A ~ G   | kW | SCOP X,Y | kWh/annum XY | A ~ G   | kW | SCOP X,Y | kWh/annum XY | A ~ G   | kW   | SCOP X,Y | kWh/annum XY | A ~ G   | kW | SCOP X,Y | kWh/annum XY |
| S-100PU2E5A x2 | U-100PE1E8A  | A++     | 10.0 | 7.4      | 473          | -       | x  | x        | x            | 69      | 60 | 4.8      | 2917         | A++     | 10.0 | 4.8      | 2917         | -       | x  | x        | x            |
| S-50PU2E5A x2  | U-100PE1E8A  | A++     | 10.0 | 7.2      | 486          | -       | x  | x        | x            | 69      | 47 | 4.8      | 2917         | A++     | 10.0 | 4.8      | 2917         | -       | x  | x        | x            |
| S-36PU2E5A x3  | U-100PE1E8A  | A++     | 10.0 | 7.1      | 493          | -       | x  | x        | x            | 69      | 45 | 4.8      | 2917         | A++     | 10.0 | 4.8      | 2917         | -       | x  | x        | x            |
| S-100PF1E5A    | U-100PE1E8A  | A+      | 10.0 | 5.7      | 614          | -       | x  | x        | x            | 69      | 60 | 3.8      | 3684         | A       | 10.0 | 3.8      | 3684         | -       | x  | x        | x            |
| S-50PF1E5A x2  | U-100PE1E8A  | A+      | 10.0 | 5.7      | 614          | -       | x  | x        | x            | 69      | 56 | 3.8      | 3684         | A       | 10.0 | 3.8      | 3684         | -       | x  | x        | x            |
| S-36PF1E5A x3  | U-100PE1E8A  | A+      | 10.0 | 5.7      | 614          | -       | x  | x        | x            | 69      | 55 | 3.8      | 3684         | A       | 10.0 | 3.8      | 3684         | -       | x  | x        | x            |
| S-100PN1E5A    | U-100PE1E8A  | A+      | 10.0 | 5.6      | 621          | -       | x  | x        | x            | 69      | 65 | 3.8      | 3684         | A       | 10.0 | 3.8      | 3684         | -       | x  | x        | x            |
| S-50PN1E5A x2  | U-100PE1E8A  | A       | 10.0 | 5.3      | 659          | -       | x  | x        | x            | 69      | 58 | 3.8      | 3646         | A       | 9.9  | 3.8      | 3646         | -       | x  | x        | x            |
| S-36PN1E5A x3  | U-100PE1E8A  | B       | 10.0 | 5.0      | 700          | -       | x  | x        | x            | 69      | 57 | 3.8      | 3646         | A       | 9.9  | 3.8      | 3646         | -       | x  | x        | x            |

- ① : Panasonic Corporation
- ② : Model Name
- ③ : SEER Grading
- ④ : SCOP Grading (Standard, mandatory)
- ⑤ : SCOP Grading (Warmer, optional)
- ⑥ : SCOP Grading (Colder, optional)
- ⑦ : Design Load kW (round up to one decimal) <Cooling>
- ⑧ : SEER (round up to one decimal)
- ⑨ : Annual Energy Consumption (rounded <Cooling> up to the nearest integer)
- ⑩ : Design Load kW (round up to one decimal) <Heating>
- ⑪ : SCOP (round up to one decimal) <Heating>
- ⑫ : Annual Energy Consumption (rounded up to the nearest integer) <Heating>
- ⑬ : Sound Power level for all indoor units dB (cooling)
- ⑭ : Sound Power level for all outdoor units dB (cooling)
- ⑮ : Sound Power level for all indoor units dB (heating)
- ⑯ : Sound Power level for all outdoor units dB (heating)
- ⑰ : backup heating capacity X,Y,Z kW name of refrigerant and GWP R410A (GWP 1975)
- ⑱ : Refrigerant leakage contributes to climate change. Refrigerant with lower global warming potential (GWP) would contribute less to global warming than a refrigerant with higher GWP, if leaked to the atmosphere. This appliance contains a refrigerant fluid with a GWP equal to 1975. This means that if 1 kg of this refrigerant fluid would be leaked to the atmosphere, the impact on global warming would be 1975 times higher than 1 kg of CO<sub>2</sub>, over a period of 100 years. Never try to interfere with the refrigerant circuit yourself or disassemble the product yourself and always ask a professional.
- ⑳ : Explanation on annual energy consumption based on standard test results. Actual energy consumption will depend on how the appliance is used and where it is located.





1-14. Product Fiche

U-100PEY1E5

| ENERGY LABEL  |              | ENERGIA - ENERGIJA - ENERGIJA - ENERGIJA - ENERGIJA |           | SEER       |                | Warmer Heating Season (Optional) |                  | Average Heating Season (Mandatory) |                |                |                |                  | Colder Heating Season (Optional) |                  |                |                |
|---------------|--------------|---|-----------|------------|----------------|----------------------------------|------------------|------------------------------------|----------------|----------------|----------------|------------------|----------------------------------|------------------|----------------|----------------|
| Indoor Unit   | Outdoor Unit | ③ A ~ G   | ⑦ kW XY,Z | ⑧ SEER X,Y | ⑨ kWh/annum XY | ⑩ kWh/annum XY                   | ⑪ kWh/annum XY,Z | ⑫ kWh/annum XY                     | ⑬ kWh/annum XY | ⑭ kWh/annum XY | ⑮ kWh/annum XY | ⑯ kWh/annum XY,Z | ⑰ kWh/annum XY,Z                 | ⑱ kWh/annum XY,Z | ⑲ kWh/annum XY | ⑳ kWh/annum XY |
| S-100PU2E5A   | U-100PEY1E5  | A++   | 10.0      | 6.7        | 522            | 60                               | 70               | x                                  | A+             | 10.0           | 4.3            | 3256             | 60                               | 70               | x              | x              |
| S-50PU2E5A x2 | U-100PEY1E5  | A++   | 10.0      | 6.6        | 530            | 47                               | 70               | x                                  | A+             | 10.0           | 4.3            | 3256             | 47                               | 70               | x              | x              |
| S-100PF1E5A   | U-100PEY1E5  | A   | 10.0      | 5.4        | 648            | 60                               | 70               | x                                  | A              | 9.5            | 3.8            | 3500             | 60                               | 70               | x              | x              |
| S-50PF1E5A x2 | U-100PEY1E5  | A   | 10.0      | 5.4        | 648            | 56                               | 70               | x                                  | A              | 9.5            | 3.8            | 3500             | 56                               | 70               | x              | x              |
| S-100PN1E5A   | U-100PEY1E5  | A   | 10.0      | 5.3        | 661            | 65                               | 70               | x                                  | A              | 7.6            | 3.8            | 2800             | 65                               | 70               | x              | x              |
| S-50PN1E5A x2 | U-100PEY1E5  | B   | 10.0      | 4.9        | 715            | 58                               | 70               | x                                  | A              | 7.5            | 3.8            | 2761             | 58                               | 70               | x              | x              |
| S-100PK1E5A   | U-100PEY1E5  | A+  | 9.0       | 5.8        | 543            | 65                               | 70               | x                                  | A              | 9.0            | 3.8            | 3316             | 65                               | 70               | x              | x              |
| S-50PK1E5A x2 | U-100PEY1E5  | A++   | 10.0      | 6.1        | 574            | 57                               | 70               | x                                  | A              | 10.0           | 3.8            | 3684             | 57                               | 70               | x              | x              |
| S-100PT2E5A   | U-100PEY1E5  | A++   | 10.0      | 6.1        | 574            | 60                               | 70               | x                                  | A              | 10.0           | 3.9            | 3590             | 60                               | 70               | x              | x              |
| S-50PT2E5A x2 | U-100PEY1E5  | A+  | 10.0      | 5.9        | 594            | 55                               | 70               | x                                  | A              | 10.0           | 3.9            | 3590             | 55                               | 70               | x              | x              |
| S-50PY2E5A x2 | U-100PEY1E5  | A++   | 10.0      | 6.1        | 574            | 55                               | 70               | x                                  | A              | 9.2            | 3.8            | 3389             | 55                               | 70               | x              | x              |

- ① : Panasonic Corporation
- ② : Model Name
- ③ : SEER Grading
- ④ : SCOP Grading (Standard, mandatory)
- ⑤ : SCOP Grading (Warmer, optional)
- ⑥ : SCOP Grading (Colder, optional)
- ⑦ : Design Load kW (round up to one decimal) <Cooling>
- ⑧ : SEER (round up to one decimal)
- ⑨ : Annual Energy Consumption (rounded <Cooling> up to the nearest integer)
- ⑩ : Design Load kW (round up to one decimal) <Heating>
- ⑪ : SCOP (round up to one decimal) <Heating>
- ⑫ : Annual Energy Consumption (rounded up to the nearest integer) <Heating>
- ⑬ Sound Power level for all indoor units dB (cooling)
- ⑭ Sound Power level for all outdoor units dB (cooling)
- ⑮ Sound Power level for all indoor units dB (heating)
- ⑯ Sound Power level for all outdoor units dB (heating)
- ⑰ backup heating capacity X,Y,Z kW name of refrigerant and GWP R410A (GWP 1975)
- ⑱ Refrigerant leakage contributes to climate change. Refrigerant with lower global warming potential (GWP) would contribute less to global warming than a refrigerant with higher GWP, if leaked to the atmosphere. This appliance contains a refrigerant fluid with a GWP equal to 1975. This means that if 1 kg of this refrigerant fluid would be leaked to the atmosphere, the impact on global warming would be 1975 times higher than 1 kg of CO<sub>2</sub>, over a period of 100 years. Never try to interfere with the refrigerant circuit yourself or disassemble the product yourself and always ask a professional.
- ⑳ Explanation on annual energy consumption based on standard test results. Actual energy consumption will depend on how the appliance is used and where it is located.

1-14. Product Fiche

U-100PEY1E8

| Indoor Unit   |              | Outdoor Unit |      | SEER     |              |    |    | Warmer Heating Season (Optional) |         |          |              | Average Heating Season (Mandatory) |    |                       |       | Colder Heating Season (Optional) |          |              |   |
|---------------|--------------|--------------|------|----------|--------------|----|----|----------------------------------|---------|----------|--------------|------------------------------------|----|-----------------------|-------|----------------------------------|----------|--------------|---|
|               |              |              |      | ③        | ⑦            | ⑧  | ⑨  | ⑩                                | ⑪       | ⑫        | ⑬            | ⑭                                  | ⑤  | ⑥                     | ⑦     | ⑧                                | ⑨        | ⑩            | ⑪ |
| Indoor Unit   | Outdoor Unit | A ~ G        | kW   | SEER X,Y | kWh/annum XY | ⑬  | ⑭  | A ~ G                            | kW XY,Z | SCOP X,Y | kWh/annum XY | ⑮                                  | ⑯  | elbu (-10°C) kW X,Y,Z | A ~ G | kW XY,Z                          | SCOP X,Y | kWh/annum XY |   |
| S-100PU2E5A   | U-100PEY1E8  | A++          | 10.0 | 6.6      | 530          | 60 | 70 | -                                | x       | x        | x            | 60                                 | 70 | 1.16                  | -     | x                                | x        | x            |   |
| S-50PU2E5A x2 | U-100PEY1E8  | A++          | 10.0 | 6.5      | 538          | 47 | 70 | -                                | x       | x        | x            | 47                                 | 70 | 1.16                  | -     | x                                | x        | x            |   |
| S-100PF1E5A   | U-100PEY1E8  | A            | 10.0 | 5.2      | 673          | 60 | 70 | -                                | x       | x        | x            | 60                                 | 70 | 1.06                  | -     | x                                | x        | x            |   |
| S-50PF1E5A x2 | U-100PEY1E8  | A            | 10.0 | 5.2      | 673          | 56 | 70 | -                                | x       | x        | x            | 56                                 | 70 | 1.06                  | -     | x                                | x        | x            |   |
| S-100PN1E5A   | U-100PEY1E8  | A            | 10.0 | 5.2      | 677          | 65 | 70 | -                                | x       | x        | x            | 65                                 | 70 | 0.00                  | -     | x                                | x        | x            |   |
| S-50PN1E5A x2 | U-100PEY1E8  | B            | 10.0 | 4.8      | 728          | 58 | 70 | -                                | x       | x        | x            | 58                                 | 70 | 0.22                  | -     | x                                | x        | x            |   |
| S-100PK1E5A   | U-100PEY1E8  | A+           | 9.0  | 5.7      | 553          | 65 | 70 | -                                | x       | x        | x            | 65                                 | 70 | 1.14                  | -     | x                                | x        | x            |   |
| S-50PK1E5A x2 | U-100PEY1E8  | A+           | 10.0 | 5.9      | 593          | 57 | 70 | -                                | x       | x        | x            | 57                                 | 70 | 1.60                  | -     | x                                | x        | x            |   |
| S-100PT2E5A   | U-100PEY1E8  | A+           | 10.0 | 6.0      | 584          | 60 | 70 | -                                | x       | x        | x            | 60                                 | 70 | 1.52                  | -     | x                                | x        | x            |   |
| S-50PT2E5A x2 | U-100PEY1E8  | A+           | 10.0 | 5.8      | 604          | 55 | 70 | -                                | x       | x        | x            | 55                                 | 70 | 1.52                  | -     | x                                | x        | x            |   |
| S-50PY2E5A x2 | U-100PEY1E8  | A+           | 10.0 | 6.0      | 583          | 55 | 70 | -                                | x       | x        | x            | 55                                 | 70 | 0.52                  | -     | x                                | x        | x            |   |

- ① : Panasonic Corporation
- ② : Model Name
- ③ : SEER Grading
- ④ : SCOP Grading (Standard, mandatory)
- ⑤ : SCOP Grading (Warmer, optional)
- ⑥ : SCOP Grading (Colder, optional)
- ⑦ : Design Load kW (round up to one decimal) <Cooling>
- ⑧ : SEER (round up to one decimal)
- ⑨ : Annual Energy Consumption (rounded <Cooling> up to the nearest integer)
- ⑩ : Design Load kW (round up to one decimal) <Heating>
- ⑪ : SCOP (round up to one decimal) <Heating>
- ⑫ : Annual Energy Consumption (rounded up to the nearest integer) <Heating>
- ⑬ : Sound Power level for all indoor units dB (cooling)
- ⑭ : Sound Power level for all outdoor units dB (cooling)
- ⑮ : Sound Power level for all indoor units dB (heating)
- ⑯ : Sound Power level for all outdoor units dB (heating)
- ⑰ : backup heating capacity X,Y,Z kW name of refrigerant and GWP R410A (GWP 1975)
- ⑱ : Refrigerant leakage contributes to climate change. Refrigerant with lower global warming potential (GWP) would contribute less to global warming than a refrigerant with higher GWP, if leaked to the atmosphere. This appliance contains a refrigerant fluid with a GWP equal to 1975. This means that if 1 kg of this refrigerant fluid would be leaked to the atmosphere, the impact on global warming would be 1975 times higher than 1 kg of CO<sub>2</sub>, over a period of 100 years. Never try to interfere with the refrigerant circuit yourself or disassemble the product yourself and always ask a professional.
- ⑳ : Explanation on annual energy consumption based on standard test results. Actual energy consumption will depend on how the appliance is used and where it is located.

Information requirements for air-to-air air conditioners

Model(s): Outdoor Unit U-125PE1E5A X4  
 Indoor Unit S-36PUZE5A  
 Outdoor side heat exchanger of air conditioner:  
 Indoor side heat exchanger of air conditioner:  
 Type: compressor driven vapour compression or sorption process  
 if applicable; driver of compressor: [electric motor or fuel driven,  
 gaseous or liquid fuel, internal or external combustion engine]  
 electric motor

| Item   | Symbol   | Value    | Unit | Item   | Symbol                                     | Value | Unit                              |
|--|--|----------|------|--|--|-------|-----------------------------------|
| Rated cooling capacity   | $P_{rated,c}$  | 12.5     | kW   | Seasonal space cooling energy efficiency           | $\eta_{s,c}$                               | 277.5 | %                                 |
| Refrigeration load   | $P_{design,c}$   | 12.5     | kW   |  |  |       |                                   |
| Declared cooling capacity for part load at given outdoor temperatures $T_j$ and indoor 27°/19°C (dry/wet bulb)                             |  |          |      |  |  |       |                                   |
| $T_j = +35\text{ °C}$  |  | 12.5     | kW   | $T_j = +35\text{ °C}$                              |  | 3.7   | %                                 |
| $T_j = +30\text{ °C}$  |  | 9.2      | kW   | $T_j = +30\text{ °C}$                              | EER <sub>d</sub> or GUE <sub>c,bin</sub> / | 5.4   | %                                 |
| $T_j = +25\text{ °C}$  | $P_{dc}$   | 5.9      | kW   | $T_j = +25\text{ °C}$                              | AEF <sub>c,bin</sub>                       | 8.2   | %                                 |
| $T_j = +20\text{ °C}$  |  | 5.3      | kW   | $T_j = +20\text{ °C}$                              |  | 11.6  | %                                 |
| Degradation co-efficient for air conditioners**  | $C_{dc}$   | 0.25     | -    |  |  |       |                                   |
| Declared energy efficiency ratio or gas utilization efficiency / auxiliary energy factor for part load at given outdoor temperatures $T_j$ |  |          |      |  |  |       |                                   |
| Power consumption in modes other than 'active mode'  |  |          |      |  |  |       |                                   |
| Off mode   | $P_{off}$  | 0.012    | kW   | Crankcase heater mode                              | $P_{ck}$                                   | 0.000 | kW                                |
| Thermostat-off mode  | $P_{to}$   | 0.000    | kW   | Standby mode                                       | $P_{sb}$                                   | 0.012 | kW                                |
| Other items  |  |          |      |  |  |       |                                   |
| Capacity control   |  | variable |      | For air-to-air conditioner: air flow rate, outdoor |  | 7800  | m <sup>3</sup> /h                 |
| Sound power level, outdoor   | $L_{WA}$   | 70.0     | dB   |  |  |       |                                   |
| Sound power level, indoor  | $L_{WA}$   | 45.0     | dB   | if engine driven: Emissions of nitrogen oxides     | NO <sub>x</sub> ***                        | -     | mg/kWh fuel input GCV             |
|  |  |          |      | GWP of the refrigerant                             |  | 2088  | kg CO <sub>2</sub> eq (100 years) |
| Contact details  | Panasonic Testing Centre, Panasonic Marketing Europe GmbH Winsbergiring 15, 22525 Hamburg, Germany |          |      |  |  |       |                                   |

\*\* If  $C_{dc}$  is not determined by measurement then the default degradation coefficient air conditioners shall be 0.25.  
 \*\*\* from 26 September 2018.  
 Where information relates to multi-split air conditioners, the test result and performance data may be obtained on the basis of the performance of the outdoor unit, with a combination of indoor unit(s) recommended by the manufacturer or importer.

Information requirements for heat pumps

Model(s): Outdoor Unit U-125PE1E5A X4  
 Indoor Unit S-36PUZE5A  
 Outdoor side heat exchanger of heat pump:  
 Indoor side heat exchanger of heat pump:  
 Indication if the heater is equipped with a supplementary heater:  
 if applicable; driver of compressor: [electric motor or fuel driven,  
 gaseous or liquid fuel, internal or external combustion engine]  
 Parameters shall be declared for the average heating season, parameters for the warmer and colder heating seasons are optional.  
 electric motor

| Item  | Symbol   | Value    | Unit | Item  | Symbol  | Value | Unit                              |
|---|--|----------|------|---|---|-------|-----------------------------------|
| Rated heating capacity  | $P_{rated,h}$  | 14.0     | kW   | Seasonal space heating energy efficiency  | $\eta_{s,h}$  | 161.0 | %                                 |
| Refrigeration load  | $P_{design,h}$   | 12.5     | kW   |   |   |       |                                   |
| Declared heating capacity for part load at indoor temperature 20 °C and outdoor temperature $T_j$ |  |          |      |   |   |       |                                   |
| $T_j = -7\text{ °C}$  |  | 11.0     | kW   | $T_j = -7\text{ °C}$  |   | 2.5   | %                                 |
| $T_j = +2\text{ °C}$  |  | 6.7      | kW   | $T_j = +2\text{ °C}$  |   | 3.9   | %                                 |
| $T_j = +7\text{ °C}$  |  | 4.3      | kW   | $T_j = +7\text{ °C}$  |   | 5.8   | %                                 |
| $T_j = +12\text{ °C}$   |  | 4.5      | kW   | $T_j = +12\text{ °C}$   |   | 7.0   | %                                 |
| $T_{bw} = \text{bivalent temperature}$  | $P_{bh}$   | 12.5     | kW   | $T_{bw} = \text{bivalent temperature}$  | COP <sub>h</sub> or GUE <sub>h,bin</sub> / AEF <sub>h,bin</sub> | 2.3   | %                                 |
| $T_{ol} = \text{operation limit}$   |  | 9.3      | kW   | $T_{ol} = \text{operation limit}$   |   | 1.8   | %                                 |
| For air-to-water heat pumps: $T_j = -15\text{ °C}$ (if $T_{ol} < -20\text{ °C}$ )                 |  | -        | kW   | For water-to-air heat pumps: $T_j = -15\text{ °C}$ (if $T_{ol} < -20\text{ °C}$ )               |   | -     | %                                 |
| Bivalent temperature  | $T_{bw}$   | -10      | °C   | For water-to-air heat pumps: Operation limit temperature  | $T_{ol}$  | -20   | °C                                |
| Degradation co-efficient heat pumps**   | $C_{dh}$   | 0.25     | -    |   |   |       |                                   |
| Power consumption in modes other than 'active mode'   |  |          |      |   |   |       |                                   |
| Off mode  | $P_{off}$  | 0.012    | kW   | back-up heating capacity *  | elbu  | 0.0   | kW                                |
| Thermostat-off mode   | $P_{to}$   | 0.000    | kW   | Type of energy input  |   |       |                                   |
| Crankcase heater mode   | $P_{ck}$   | 0.000    | kW   | Standby mode  | $P_{sb}$  | 0.012 | kW                                |
| Other items   |  |          |      |   |   |       |                                   |
| Capacity control  |  | variable |      | For air-to-air heat pumps: air flow rate, outdoor   |   | 6600  | m <sup>3</sup> /h                 |
| Sound power level, outdoor  | $L_{WA}$   | 70.0     | dB   | For water-/brine-to-air heat pumps: Rated brine or water flow rate, outdoor side heat exchanger |   | -     | m <sup>3</sup> /h                 |
| Sound power level, indoor   | $L_{WA}$   | 45.0     | dB   | Emissions of nitrogen oxides (if applicable)  | NO <sub>x</sub> ***   | -     | mg/kWh fuel input GCV             |
|   |  |          |      | GWP of the refrigerant  |   | 2088  | kg CO <sub>2</sub> eq (100 years) |
| Contact details   | Panasonic Testing Centre, Panasonic Marketing Europe GmbH Winsbergiring 15, 22525 Hamburg, Germany |          |      |   |   |       |                                   |

\*\* If  $C_{dh}$  is not determined by measurement then the default degradation coefficient of heat pumps shall be 0.25.  
 \*\*\* from 26 September 2018.  
 Where information relates to multi-split heat pumps, the test result and performance data may be obtained on the basis of the performance of the outdoor unit, with a combination of indoor unit(s) recommended by the manufacturer or importer.

Information requirements for air-to-air air conditioners

Model(s): Outdoor Unit U-125PE1E5A X3  
 Indoor Unit S-45PUZE5A  
 Outdoor side heat exchanger of air conditioner: air  
 Indoor side heat exchanger of air conditioner: air  
 Type: compressor driven vapour compression or sorption process vapour compression  
 if applicable: driver of compressor: [electric motor or fuel driven, electric motor]  
 gaseous or liquid fuel, internal or external combustion engine] electric motor

| Item  | Symbol  | Value    | Unit | Item   | Symbol                                     | Value | Unit                              |
|---|---|----------|------|--|--|-------|-----------------------------------|
| Rated cooling capacity  | $P_{rated,c}$   | 12.5     | kW   | Seasonal space cooling energy efficiency   | $\eta_{s,c}$                               | 277.5 | %                                 |
| Refrigeration load  | $P_{design,c}$  | 12.5     | kW   | Declared energy efficiency ratio or gas utilization efficiency / auxiliary energy factor for part load at given outdoor temperatures T <sub>J</sub> and indoor 27°/19°C (dry/wet bulb) |  |       |                                   |
| Declared cooling capacity for part load at given outdoor temperatures T <sub>J</sub> and indoor 27°/19°C (dry/wet bulb) |   |          |      | Declared energy efficiency ratio or gas utilization efficiency / auxiliary energy factor for part load at given outdoor temperatures T <sub>J</sub>                                    |  |       |                                   |
| T <sub>J</sub> = + 35 °C  |   | 12.5     | kW   | T <sub>J</sub> = + 35 °C   |  | 3.7   | %                                 |
| T <sub>J</sub> = + 30 °C  |   | 9.2      | kW   | T <sub>J</sub> = + 30 °C   | EER <sub>d</sub> or GUE <sub>c,dbn</sub> / | 5.4   | %                                 |
| T <sub>J</sub> = + 25 °C  |   | 5.9      | kW   | T <sub>J</sub> = + 25 °C   | AEF <sub>c,dbn</sub>                       | 8.2   | %                                 |
| T <sub>J</sub> = + 20 °C  |   | 5.3      | kW   | T <sub>J</sub> = + 20 °C   |  | 11.6  | %                                 |
| Degradation co- efficient for air conditioners**  | $C_{de}$  | 0.25     | -    |  |  |       |                                   |
| Power consumption in modes other than 'active mode'   |   |          |      |  |  |       |                                   |
| Off mode  | $P_{off}$   | 0.012    | kW   | Crankcase heater mode  | $P_{ck}$                                   | 0.000 | kW                                |
| Thermostat-off mode   | $P_{to}$  | 0.000    | kW   | Standby mode   | $P_{sb}$                                   | 0.012 | kW                                |
| Other items   |   |          |      |  |  |       |                                   |
| Capacity control  |   | variable |      | For air-to-air air conditioner: air flow rate, outdoor   |  | 7800  | m³/h                              |
| Sound power level, outdoor  | $L_{WA}$  | 70.0     | dB   |  |  |       |                                   |
| Sound power level, indoor   | $L_{WA}$  | 46.0     | dB   | if engine driven: Emissions of nitrogen oxides   | $NO_x^{***}$                               | -     | mg/kWh fuel input GCV             |
|   |   |          |      | GWP of the refrigerant   |  | 2088  | kg CO <sub>2</sub> eq (100 years) |
| Contact details   | Panasonic Testing Centre, Panasonic Marketing Europe GmbH Wirsberg 15, 22525 Hamburg, Germany |          |      |  |  |       |                                   |

\*\* If  $C_{de}$  is not determined by measurement then the default degradation coefficient air conditioners shall be 0.25.  
 \*\*\* from 26 September 2018.

Where information relates to multi-split air conditioners, the test result and performance data may be obtained on the basis of the performance of the outdoor unit, with a combination of indoor unit(s) recommended by the manufacturer or importer.

Information requirements for heat pumps

Model(s): Outdoor Unit U-125PE1E5A X3  
 Indoor Unit S-45PUZE5A  
 Outdoor side heat exchanger of heat pump: air  
 Indoor side heat exchanger of heat pump: air  
 Indication if the heater is equipped with a supplementary heater: no  
 if applicable: driver of compressor: [electric motor or fuel driven, electric motor]  
 gaseous or liquid fuel, internal or external combustion engine] electric motor

Parameters shall be declared for the average heating season, parameters for the warmer and colder heating seasons are optional.

| Item   | Symbol  | Value    | Unit | Item   | Symbol  | Value | Unit                              |
|--|---|----------|------|--|---|-------|-----------------------------------|
| Rated heating capacity   | $P_{rated,h}$   | 14.0     | kW   | Seasonal space heating energy efficiency   | $\eta_{s,h}$  | 161.0 | %                                 |
| Refrigeration load   | $P_{design,h}$  | 12.5     | kW   | Declared coefficient of performance or gas utilization efficiency / auxiliary energy factor for part load at given outdoor temperatures T <sub>J</sub> |   |       |                                   |
| Declared heating capacity for part load at indoor temperature 20 °C and outdoor temperature T <sub>J</sub> |   |          |      | Declared coefficient of performance or gas utilization efficiency / auxiliary energy factor for part load at given outdoor temperatures T <sub>J</sub> |   |       |                                   |
| T <sub>J</sub> = - 7 °C  |   | 11.0     | kW   | T <sub>J</sub> = - 7 °C  |   | 2.5   | %                                 |
| T <sub>J</sub> = + 2 °C  |   | 6.7      | kW   | T <sub>J</sub> = + 2 °C  |   | 3.9   | %                                 |
| T <sub>J</sub> = + 7 °C  |   | 4.3      | kW   | T <sub>J</sub> = + 7 °C  |   | 5.8   | %                                 |
| T <sub>J</sub> = + 12 °C   |   | 4.5      | kW   | T <sub>J</sub> = + 12 °C   |   | 7.0   | %                                 |
| T <sub>bw</sub> = bivalent temperature   | $P_{bh}$  | 12.5     | kW   | T <sub>bw</sub> = bivalent temperature   | COP <sub>d</sub> or GUE <sub>h,dbn</sub> / AEF <sub>h,dbn</sub> | 2.3   | %                                 |
| T <sub>ol</sub> = operation limit  |   | 9.3      | kW   | T <sub>ol</sub> = operation limit  |   | 1.8   | %                                 |
| For air-to-water heat pumps: T <sub>J</sub> = - 15 °C (if T <sub>ol</sub> < - 20 °C)                       |   | -        | kW   | For water-to-air heat pumps: T <sub>J</sub> = - 15 °C (if T <sub>ol</sub> < - 20 °C)   |   | -     | %                                 |
| Bivalent temperature   | $T_{bv}$  | -10      | °C   | For water-to-air heat pumps: Operation limit temperature   | $T_{ol}$  | -20   | °C                                |
| Degradation co- efficient heat pumps**   | $C_{dh}$  | 0.25     | -    |  |   |       |                                   |
| Power consumption in modes other than 'active mode'  |   |          |      |  |   |       |                                   |
| Off mode   | $P_{off}$   | 0.012    | kW   | Supplementary heater back-up heating capacity*   | $e_{ibu}$   | 0.0   | kW                                |
| Thermostat-off mode  | $P_{to}$  | 0.000    | kW   | Type of energy input   |   |       |                                   |
| Crankcase heater mode  | $P_{ck}$  | 0.000    | kW   | Standby mode   | $P_{sb}$  | 0.012 | kW                                |
| Other items  |   |          |      |  |   |       |                                   |
| Capacity control   |   | variable |      | For air-to-air heat pumps: air flow rate, outdoor  |   | 6600  | m³/h                              |
| Sound power level, outdoor   | $L_{WA}$  | 70.0     | dB   | For water-/brine-to-air heat pumps: Rated brine or water flow rate, outdoor side heat exchanger  |   | -     | m³/h                              |
| Sound power level, indoor  | $L_{WA}$  | 46.0     | dB   | Emissions of nitrogen oxides (if applicable)   | $NO_x^{***}$  | -     | mg/kWh fuel input GCV             |
|  |   |          |      | GWP of the refrigerant   |   | 2088  | kg CO <sub>2</sub> eq (100 years) |
| Contact details  | Panasonic Testing Centre, Panasonic Marketing Europe GmbH Wirsberg 15, 22525 Hamburg, Germany |          |      |  |   |       |                                   |

\*\* If  $C_{dh}$  is not determined by measurement then the default degradation coefficient of heat pumps shall be 0.25.  
 \*\*\* from 26 September 2018.

Where information relates to multi-split heat pumps, the test result and performance data may be obtained on the basis of the performance of the outdoor unit, with a combination of indoor unit(s) recommended by the manufacturer or importer.

### Information requirements for air-to-air air conditioners

|  |  |                             |  |                           |  |    |  |
|--|--|-----------------------------|--|---------------------------|--|----|--|
| Model(s):  |  | Outdoor Unit<br>Indoor Unit |  | U-140PE1E5A<br>S-50PUZE5A |  | X3 |  |
| Outdoor side heat exchanger of air conditioner:  |  | air                         |  |                           |  |    |  |
| Indoor side heat exchanger of air conditioner:   |  | air                         |  |                           |  |    |  |
| Type: compressor driven vapour compression or sorption process   |  | vapour compression          |  |                           |  |    |  |
| if applicable: driver of compressor: [electric motor or fuel driven, gaseous or liquid fuel, internal or external combustion engine] |  | electric motor              |  |                           |  |    |  |

| Item  | Symbol   | Value    | Unit | Item  | Symbol                                     | Value | Unit                              |
|---|--|----------|------|---|--|-------|-----------------------------------|
| Rated cooling capacity  | $P_{rated,c}$  | 14.0     | kW   | Seasonal space cooling energy efficiency  | $\eta_{s,c}$                               | 260.9 | %                                 |
| Refrigeration load  | $P_{design,c}$   | 14.0     | kW   | Declared energy efficiency ratio or gas utilization efficiency / auxiliary energy factor for part load at given outdoor temperatures Tj |  |       |                                   |
| Declared cooling capacity for part load at given outdoor temperatures Tj and indoor 27°/19°C (dry/wet bulb) |  |          |      |   |  |       |                                   |
| Tj = + 35 °C  |  | 14.0     | kW   | Tj = + 35 °C  |  | 3.3   | %                                 |
| Tj = + 30 °C  |  | 10.3     | kW   | Tj = + 30 °C  | EER <sub>d</sub> or GUE <sub>c,bin</sub> / | 4.9   | %                                 |
| Tj = + 25 °C  | P <sub>dc</sub>  | 6.6      | kW   | Tj = + 25 °C  | AEF <sub>c,bin</sub>                       | 7.7   | %                                 |
| Tj = + 20 °C  |  | 5.3      | kW   | Tj = + 20 °C  |  | 11.6  | %                                 |
| Degradation co- efficient for air conditioners**  | C <sub>dc</sub>  | 0.25     | -    |   |  |       |                                   |
| Power consumption in modes other than 'active mode'   |  |          |      |   |  |       |                                   |
| Off mode  | P <sub>off</sub>   | 0.012    | kW   | Crankcase heater mode   | P <sub>ck</sub>                            | 0.000 | kW                                |
| Thermostat-off mode   | P <sub>to</sub>  | 0.000    | kW   | Standby mode  | P <sub>sb</sub>                            | 0.012 | kW                                |
| Other items   |  |          |      |   |  |       |                                   |
| Capacity control  |  | variable |      | For air-to-air air conditioner: air flow rate, outdoor  |  | 8100  | m <sup>3</sup> /h                 |
| Sound power level, outdoor  | L <sub>WA</sub>  | 71.0     | dB   |   |  |       |                                   |
| Sound power level, indoor   | L <sub>WA</sub>  | 47.0     | dB   | if engine driven: Emissions of nitrogen oxides  | NO <sub>x</sub> ***                        | -     | mg/kWh fuel input GCV             |
|   |  |          |      | GWP of the refrigerant  |  | 2088  | kg CO <sub>2</sub> eq (100 years) |
| Contact details   | Panasonic Testing Centre, Panasonic Marketing Europe GmbH Winsbergiring 15, 22525 Hamburg, Germany |          |      |   |  |       |                                   |

\*\* If C<sub>dc</sub> is not determined by measurement then the default degradation coefficient for air conditioners shall be 0.25.  
\*\*\* from 26 September 2018.

Where information relates to multi-split air conditioners, the test result and performance data may be obtained on the basis of the performance of the outdoor unit, with a combination of indoor unit(s) recommended by the manufacturer or importer.

### Information requirements for heat pumps

|  |  |                             |  |                           |  |    |  |
|--|--|-----------------------------|--|---------------------------|--|----|--|
| Model(s):  |  | Outdoor Unit<br>Indoor Unit |  | U-140PE1E5A<br>S-50PUZE5A |  | X3 |  |
| Outdoor side heat exchanger of heat pump:  |  | air                         |  |                           |  |    |  |
| Indoor side heat exchanger of heat pump:   |  | air                         |  |                           |  |    |  |
| Indication if the heater is equipped with a supplementary heater:  |  | no                          |  |                           |  |    |  |
| if applicable: driver of compressor: [electric motor or fuel driven, gaseous or liquid fuel, internal or external combustion engine] |  | electric motor              |  |                           |  |    |  |

Parameters shall be declared for the average heating season, parameters for the warmer and colder heating seasons are optional.

| Item   | Symbol   | Value    | Unit | Item   | Symbol  | Value | Unit                              |
|--|--|----------|------|--|---|-------|-----------------------------------|
| Rated heating capacity   | $P_{rated,h}$  | 16.0     | kW   | Seasonal space heating energy efficiency   | $\eta_{s,h}$  | 152.9 | %                                 |
| Refrigeration load   | $P_{design,h}$   | 14.0     | kW   | Declared coefficient of performance or gas utilization efficiency / auxiliary energy factor for part load at given outdoor temperatures Tj |   |       |                                   |
| Declared heating capacity for part load at indoor temperature 20 °C and outdoor temperature Tj |  |          |      |  |   |       |                                   |
| Tj = - 7 °C  |  | 12.3     | kW   | Tj = - 7 °C  |   | 2.4   | %                                 |
| Tj = + 2 °C  |  | 7.5      | kW   | Tj = + 2 °C  |   | 3.7   | %                                 |
| Tj = + 7 °C  |  | 4.8      | kW   | Tj = + 7 °C  |   | 5.5   | %                                 |
| Tj = + 12 °C   |  | 4.5      | kW   | Tj = + 12 °C   |   | 7.0   | %                                 |
| T <sub>bw</sub> = bivalent temperature   | P <sub>dh</sub>  | 12.3     | kW   | T <sub>bw</sub> = bivalent temperature   | COP <sub>d</sub> or GUE <sub>h,bin</sub> / AEF <sub>h,bin</sub> | 2.4   | %                                 |
| T <sub>ol</sub> = operation limit  |  | 9.5      | kW   | T <sub>ol</sub> = operation limit  |   | 1.7   | %                                 |
| For air-to-water heat pumps: Tj = - 15 °C (if T <sub>ol</sub> < - 20 °C)                       |  | -        | kW   | For water-to-air heat pumps: Tj = - 15 °C (if T <sub>ol</sub> < - 20 °C)   |   | -     | %                                 |
| Bivalent temperature   | T <sub>bv</sub>  | -7       | °C   | For water-to-air heat pumps: Operation limit temperature   | T <sub>ol</sub>   | -20   | °C                                |
| Degradation co- efficient heat pumps**   | C <sub>dh</sub>  | 0.25     | -    |  |   |       |                                   |
| Power consumption in modes other than 'active mode'  |  |          |      |  |   |       |                                   |
| Off mode   | P <sub>off</sub>   | 0.012    | kW   | Supplementary heater back-up heating capacity *  | elbu  | 2.4   | kW                                |
| Thermostat-off mode  | P <sub>to</sub>  | 0.000    | kW   | Type of energy input   |   |       |                                   |
| Crankcase heater mode  | P <sub>ck</sub>  | 0.000    | kW   | Standby mode   | P <sub>sb</sub>   | 0.012 | kW                                |
| Other items  |  |          |      |  |   |       |                                   |
| Capacity control   |  | variable |      | For air-to-air heat pumps: air flow rate, outdoor  |   | 7200  | m <sup>3</sup> /h                 |
| Sound power level, outdoor   | L <sub>WA</sub>  | 71.0     | dB   | For water-/brine-to-air heat pumps: Rated brine or water flow rate, outdoor side heat exchanger  |   | -     | m <sup>3</sup> /h                 |
| Sound power level, indoor  | L <sub>WA</sub>  | 47.0     | dB   | Emissions of nitrogen oxides (if applicable)   | NO <sub>x</sub> ***   | -     | mg/kWh fuel input GCV             |
|  |  |          |      | GWP of the refrigerant   |   | 2088  | kg CO <sub>2</sub> eq (100 years) |
| Contact details  | Panasonic Testing Centre, Panasonic Marketing Europe GmbH Winsbergiring 15, 22525 Hamburg, Germany |          |      |  |   |       |                                   |

\*\* If C<sub>dh</sub> is not determined by measurement then the default degradation coefficient of heat pumps shall be 0.25.  
\*\*\* from 26 September 2018.

Where information relates to multi-split heat pumps, the test result and performance data may be obtained on the basis of the performance of the outdoor unit, with a combination of indoor unit(s) recommended by the manufacturer or importer.



## Information requirements for air-to-air air conditioners

|  |  |                           |  |                    |  |
|--|--|---------------------------|--|--------------------|--|
| Model(s):  |  | U-140PE1E5A<br>S-71PUZE5A |  | X2                 |  |
| Outdoor side heat exchanger of air conditioner:  |  | Indoor Unit               |  | air                |  |
| Indoor side heat exchanger of air conditioner:   |  | Outdoor Unit              |  | air                |  |
| Type: compressor driven vapour compression or sorption process   |  |                           |  | vapour compression |  |
| if applicable: driver of compressor: [electric motor or fuel driven, gaseous or liquid fuel, internal or external combustion engine] |  |                           |  | electric motor     |  |

| Item   | Symbol   | Value    | Unit | Item   | Symbol                                     | Value | Unit                              |
|--|--|----------|------|--|--|-------|-----------------------------------|
| Rated cooling capacity   | $P_{rated,c}$  | 14.0     | kW   | Seasonal space cooling energy efficiency               | $\eta_{s,c}$                               | 260.6 | %                                 |
| Refrigeration load   | $P_{design,c}$   | 14.0     | kW   |  |  |       |                                   |
| Declared cooling capacity for part load at given outdoor temperatures $T_j$ and indoor 27°/19°C (dry/wet bulb)                             |  |          |      |  |  |       |                                   |
| $T_j = +35\text{ °C}$  |  | 14.0     | kW   | $T_j = +35\text{ °C}$                                  |  | 3.3   | %                                 |
| $T_j = +30\text{ °C}$  |  | 10.3     | kW   | $T_j = +30\text{ °C}$                                  | EER <sub>d</sub> or GUE <sub>d,bin</sub> / | 4.9   | %                                 |
| $T_j = +25\text{ °C}$  | $P_{dc}$   | 6.6      | kW   | $T_j = +25\text{ °C}$                                  | AEF <sub>c,bin</sub>                       | 7.7   | %                                 |
| $T_j = +20\text{ °C}$  |  | 5.5      | kW   | $T_j = +20\text{ °C}$                                  |  | 11.6  | %                                 |
| Degradation co-efficient for air conditioners**  | $C_{dc}$   | 0.25     | -    |  |  |       |                                   |
| Declared energy efficiency ratio or gas utilization efficiency / auxiliary energy factor for part load at given outdoor temperatures $T_j$ |  |          |      |  |  |       |                                   |
|  |  |          |      |  |  |       |                                   |
|  |  |          |      |  |  |       |                                   |
|  |  |          |      |  |  |       |                                   |
|  |  |          |      |  |  |       |                                   |
|  |  |          |      |  |  |       |                                   |
| Power consumption in modes other than 'active mode'  |  |          |      |  |  |       |                                   |
| Off mode   | $P_{off}$  | 0.012    | kW   | Crankcase heater mode                                  | $P_{ck}$                                   | 0.000 | kW                                |
| Thermostat-off mode  | $P_{to}$   | 0.000    | kW   | Standby mode   | $P_{sb}$                                   | 0.012 | kW                                |
| Other items  |  |          |      |  |  |       |                                   |
| Capacity control   |  | variable |      | For air-to-air air conditioner: air flow rate, outdoor |  | 8100  | m <sup>3</sup> /h                 |
| Sound power level, outdoor   | $L_{WA}$   | 71.0     | dB   |  |  |       |                                   |
| Sound power level, indoor  | $L_{WA}$   | 52.0     | dB   | if engine driven: Emissions of nitrogen oxides         | NO <sub>x</sub> ***                        | -     | mg/kWh fuel input GCV             |
|  |  |          |      | GWP of the refrigerant                                 |  | 2088  | kg CO <sub>2</sub> eq (100 years) |
| Contact details  | Panasonic Testing Centre, Panasonic Marketing Europe GmbH Winsbergiring 15, 22525 Hamburg, Germany |          |      |  |  |       |                                   |

\*\* If  $C_{dc}$  is not determined by measurement then the default degradation coefficient for air conditioners shall be 0.25.  
\*\*\* from 26 September 2018.

Where information relates to multi-split air conditioners, the test result and performance data may be obtained on the basis of the performance of the outdoor unit, with a combination of indoor unit(s) recommended by the manufacturer or importer.

## Information requirements for heat pumps

|  |  |                           |  |                |  |
|--|--|---------------------------|--|----------------|--|
| Model(s):  |  | U-140PE1E5A<br>S-71PUZE5A |  | X2             |  |
| Outdoor side heat exchanger of heat pump:  |  | Indoor Unit               |  | air            |  |
| Indoor side heat exchanger of heat pump:   |  | Outdoor Unit              |  | air            |  |
| Indication if the heater is equipped with a supplementary heater:  |  |                           |  | no             |  |
| if applicable: driver of compressor: [electric motor or fuel driven, gaseous or liquid fuel, internal or external combustion engine] |  |                           |  | electric motor |  |

Parameters shall be declared for the average heating season, parameters for the warmer and colder heating seasons are optional.

| Item  | Symbol   | Value    | Unit | Item  | Symbol  | Value | Unit                              |
|---|--|----------|------|---|---|-------|-----------------------------------|
| Rated heating capacity  | $P_{rated,h}$  | 16.0     | kW   | Seasonal space heating energy efficiency  | $\eta_{s,h}$  | 152.9 | %                                 |
| Refrigeration load  | $P_{design,h}$   | 14.0     | kW   |   |   |       |                                   |
| Declared heating capacity for part load at indoor temperature 20 °C and outdoor temperature $T_j$ |  |          |      |   |   |       |                                   |
| $T_j = -7\text{ °C}$  |  | 12.3     | kW   | $T_j = -7\text{ °C}$  |   | 2.4   | %                                 |
| $T_j = +2\text{ °C}$  |  | 7.5      | kW   | $T_j = +2\text{ °C}$  |   | 3.7   | %                                 |
| $T_j = +7\text{ °C}$  |  | 4.8      | kW   | $T_j = +7\text{ °C}$  |   | 5.5   | %                                 |
| $T_j = +12\text{ °C}$   |  | 4.5      | kW   | $T_j = +12\text{ °C}$   |   | 7.0   | %                                 |
| $T_{bv} = \text{bivalent temperature}$  | $P_{bh}$   | 12.3     | kW   | $T_{bv} = \text{bivalent temperature}$  | COP <sub>d</sub> or GUE <sub>d,bin</sub> / AEF <sub>d,bin</sub> | 2.4   | %                                 |
| $T_{ol} = \text{operation limit}$   |  | 9.5      | kW   | $T_{ol} = \text{operation limit}$   |   | 1.7   | %                                 |
| For air-to-water heat pumps: $T_j = -15\text{ °C}$ (if $T_{ol} < -20\text{ °C}$ )                 |  | -        | kW   | For water-to-air heat pumps: $T_j = -15\text{ °C}$ (if $T_{ol} < -20\text{ °C}$ )               |   | -     | %                                 |
| Bivalent temperature  | $T_{bv}$   | -7       | °C   | For water-to-air heat pumps: Operation limit temperature  | $T_{ol}$  | -20   | °C                                |
| Degradation co-efficient heat pumps**   | $C_{dh}$   | 0.25     | -    |   |   |       |                                   |
| Power consumption in modes other than 'active mode'   |  |          |      |   |   |       |                                   |
| Off mode  | $P_{off}$  | 0.012    | kW   | Supplementary heater back-up heating capacity*  | eibu  | 2.4   | kW                                |
| Thermostat-off mode   | $P_{to}$   | 0.000    | kW   | Type of energy input  |   |       |                                   |
| Crankcase heater mode   | $P_{ck}$   | 0.000    | kW   | Standby mode  | $P_{sb}$  | 0.012 | kW                                |
| Other items   |  |          |      |   |   |       |                                   |
| Capacity control  |  | variable |      | For air-to-air heat pumps: air flow rate, outdoor   |   | 7200  | m <sup>3</sup> /h                 |
| Sound power level, outdoor  | $L_{WA}$   | 71.0     | dB   | For water-/brine-to-air heat pumps: Rated brine or water flow rate, outdoor side heat exchanger |   | -     | m <sup>3</sup> /h                 |
| Sound power level, indoor   | $L_{WA}$   | 52.0     | dB   | Emissions of nitrogen oxides (if applicable)  | NO <sub>x</sub> ***   | -     | mg/kWh fuel input GCV             |
|   |  |          |      | GWP of the refrigerant  |   | 2088  | kg CO <sub>2</sub> eq (100 years) |
| Contact details   | Panasonic Testing Centre, Panasonic Marketing Europe GmbH Winsbergiring 15, 22525 Hamburg, Germany |          |      |   |   |       |                                   |

\*\* If  $C_{dh}$  is not determined by measurement then the default degradation coefficient of heat pumps shall be 0.25.  
\*\*\* from 26 September 2018.

Where information relates to multi-split heat pumps, the test result and performance data may be obtained on the basis of the performance of the outdoor unit, with a combination of indoor unit(s) recommended by the manufacturer or importer.

Information requirements for air-to-air air conditioners

Model(s): Outdoor Unit U-125PE1E5A  
Indoor Unit S-125PU2E5A

Outdoor side heat exchanger of air conditioner: air  
Indoor side heat exchanger of air conditioner: air  
Type: compressor driven vapour compression or sorption process vapour compression  
if applicable: driver of compressor: [electric motor or fuel driven, electric motor]  
gaseous or liquid fuel, internal or external combustion engine]

| Item  | Symbol  | Value    | Unit | Item   | Symbol                                     | Value | Unit                              |
|---|---|----------|------|--|--|-------|-----------------------------------|
| Rated cooling capacity  | $P_{rated,c}$   | 12.5     | kW   | Seasonal space cooling energy efficiency   | $\eta_{s,c}$                               | 273.4 | %                                 |
| Refrigeration load  | $P_{design,c}$  | 12.5     | kW   | Declared energy efficiency ratio or gas utilization efficiency / auxiliary energy factor for part load at given outdoor temperatures T <sub>J</sub> and indoor 27°/19°C (dry/wet bulb) |  |       |                                   |
| Declared cooling capacity for part load at given outdoor temperatures T <sub>J</sub> and indoor 27°/19°C (dry/wet bulb) |   |          |      | Declared energy efficiency ratio or gas utilization efficiency / auxiliary energy factor for part load at given outdoor temperatures T <sub>J</sub>                                    |  |       |                                   |
| T <sub>J</sub> = + 35 °C  |   | 12.5     | kW   | T <sub>J</sub> = + 35 °C   |  | 3.7   | %                                 |
| T <sub>J</sub> = + 30 °C  |   | 9.2      | kW   | T <sub>J</sub> = + 30 °C   | EER <sub>d</sub> or GUE <sub>c,dbn</sub> / | 5.4   | %                                 |
| T <sub>J</sub> = + 25 °C  |   | 5.9      | kW   | T <sub>J</sub> = + 25 °C   | AEF <sub>c,dbn</sub>                       | 8.2   | %                                 |
| T <sub>J</sub> = + 20 °C  |   | 5.2      | kW   | T <sub>J</sub> = + 20 °C   |  | 11.6  | %                                 |
| Degradation co- efficient for air conditioners**  | $C_{de}$  | 0.25     | -    |  |  |       |                                   |
| Power consumption in modes other than 'active mode'   |   |          |      |  |  |       |                                   |
| Off mode  | $P_{OFF}$   | 0.017    | kW   | Crankcase heater mode  | $P_{CK}$                                   | 0.000 | kW                                |
| Thermostat-off mode   | $P_{TO}$  | 0.014    | kW   | Standby mode   | $P_{SB}$                                   | 0.017 | kW                                |
| Other items   |   |          |      |  |  |       |                                   |
| Capacity control  |   | variable |      | For air-to-air air conditioner: air flow rate, outdoor   |  | 7800  | m³/h                              |
| Sound power level, outdoor  | $L_{WA}$  | 70.0     | dB   |  |  |       |                                   |
| Sound power level, indoor   | $L_{WA}$  | 61.0     | dB   | if engine driven: Emissions of nitrogen oxides   | $NO_x^{***}$                               | -     | mg/kWh fuel input GCV             |
|   |   |          |      | GWP of the refrigerant   |  | 2088  | kg CO <sub>2</sub> eq (100 years) |
| Contact details   | Panasonic Testing Centre, Panasonic Marketing Europe GmbH Wirsberg 15, 22525 Hamburg, Germany |          |      |  |  |       |                                   |

\*\* If  $C_{de}$  is not determined by measurement then the default degradation coefficient air conditioners shall be 0.25.  
\*\*\* from 26 September 2018.

Where information relates to multi-split air conditioners, the test result and performance data may be obtained on the basis of the performance of the outdoor unit, with a combination of indoor unit(s) recommended by the manufacturer or importer.

Information requirements for heat pumps

Model(s): Outdoor Unit U-125PE1E5A  
Indoor Unit S-125PU2E5A

Outdoor side heat exchanger of heat pump: air  
Indoor side heat exchanger of heat pump: air  
Indication if the heater is equipped with a supplementary heater: no  
if applicable: driver of compressor: [electric motor or fuel driven, electric motor]  
gaseous or liquid fuel, internal or external combustion engine]

Parameters shall be declared for the average heating season, parameters for the warmer and colder heating seasons are optional.

| Item   | Symbol  | Value    | Unit | Item   | Symbol  | Value | Unit                              |
|--|---|----------|------|--|---|-------|-----------------------------------|
| Rated heating capacity   | $P_{rated,h}$   | 14.0     | kW   | Seasonal space heating energy efficiency   | $\eta_{s,h}$  | 160.9 | %                                 |
| Refrigeration load   | $P_{design,h}$  | 12.5     | kW   | Declared coefficient of performance or gas utilization efficiency / auxiliary energy factor for part load at given outdoor temperatures T <sub>J</sub> |   |       |                                   |
| Declared heating capacity for part load at indoor temperature 20 °C and outdoor temperature T <sub>J</sub> |   |          |      | Declared coefficient of performance or gas utilization efficiency / auxiliary energy factor for part load at given outdoor temperatures T <sub>J</sub> |   |       |                                   |
| T <sub>J</sub> = - 7 °C  |   | 11.0     | kW   | T <sub>J</sub> = - 7 °C  |   | 2.5   | %                                 |
| T <sub>J</sub> = + 2 °C  |   | 6.7      | kW   | T <sub>J</sub> = + 2 °C  |   | 3.9   | %                                 |
| T <sub>J</sub> = + 7 °C  |   | 4.3      | kW   | T <sub>J</sub> = + 7 °C  |   | 5.8   | %                                 |
| T <sub>J</sub> = + 12 °C   |   | 4.5      | kW   | T <sub>J</sub> = + 12 °C   |   | 7.0   | %                                 |
| $T_{biv}$ = bivalent temperature   | $P_{bh}$  | 12.5     | kW   | $T_{biv}$ = bivalent temperature   | COP <sub>d</sub> or GUE <sub>h,dbn</sub> / AEF <sub>h,dbn</sub> | 2.3   | %                                 |
| $T_{ol}$ = operation limit   |   | 9.8      | kW   | $T_{ol}$ = operation limit   |   | 1.8   | %                                 |
| For air-to-water heat pumps: T <sub>J</sub> = - 15 °C (if T <sub>ol</sub> < - 20 °C)                       |   | -        | kW   | For water-to-air heat pumps: T <sub>J</sub> = - 15 °C (if T <sub>ol</sub> < - 20 °C)   |   | -     | %                                 |
| Bivalent temperature   | $T_{biv}$   | -10      | °C   | For water-to-air heat pumps: Operation limit temperature   | $T_{ol}$  | -20   | °C                                |
| Degradation co- efficient heat pumps**   | $C_{dh}$  | 0.25     | -    |  |   |       |                                   |
| Power consumption in modes other than 'active mode'  |   |          |      |  |   |       |                                   |
| Off mode   | $P_{OFF}$   | 0.017    | kW   | Supplementary heater back-up heating capacity*   | eibu  | 0.0   | kW                                |
| Thermostat-off mode  | $P_{TO}$  | 0.014    | kW   | Type of energy input   |   |       |                                   |
| Crankcase heater mode  | $P_{CK}$  | 0.000    | kW   | Standby mode   | $P_{SB}$  | 0.017 | kW                                |
| Other items  |   |          |      |  |   |       |                                   |
| Capacity control   |   | variable |      | For air-to-air heat pumps: air flow rate, outdoor  |   | 6600  | m³/h                              |
| Sound power level, outdoor   | $L_{WA}$  | 70.0     | dB   | For water-/brine-to-air heat pumps: Rated brine or water flow rate, outdoor side heat exchanger  |   | -     | m³/h                              |
| Sound power level, indoor  | $L_{WA}$  | 61.0     | dB   | Emissions of nitrogen oxides (if applicable)   | $NO_x^{***}$  | -     | mg/kWh fuel input GCV             |
|  |   |          |      | GWP of the refrigerant   |   | 2088  | kg CO <sub>2</sub> eq (100 years) |
| Contact details  | Panasonic Testing Centre, Panasonic Marketing Europe GmbH Wirsberg 15, 22525 Hamburg, Germany |          |      |  |   |       |                                   |

\*\* If  $C_{dh}$  is not determined by measurement then the default degradation coefficient of heat pumps shall be 0.25.  
\*\*\* from 26 September 2018.

Where information relates to multi-split heat pumps, the test result and performance data may be obtained on the basis of the performance of the outdoor unit, with a combination of indoor unit(s) recommended by the manufacturer or importer.



## Information requirements for air-to-air air conditioners

|                        |                |                             |      |  |              |
|------------------------|----------------|-----------------------------|------|--|--------------|
| Model(s):              |                | Outdoor Unit<br>Indoor Unit |      | U-140PE1E5A<br>S-140PU2E5A   |              |
| Rated cooling capacity | Symbol         | Value                       | Unit | Item   | Value        |
| 14.0                   | $P_{rated,c}$  | 14.0                        | kW   | Seasonal space cooling energy efficiency   | $\eta_{s,c}$ |
| 14.0                   | $P_{design,c}$ | 14.0                        | kW   | Declared energy efficiency ratio or gas utilization efficiency / auxiliary energy factor for part load at given outdoor temperatures T <sub>J</sub> and indoor 27°/19°C (dry/wet bulb) |              |
|                        |                |                             |      | T <sub>J</sub> = +35 °C  | 14.0         |
|                        |                |                             |      | T <sub>J</sub> = +30 °C  | 10.3         |
|                        |                |                             |      | T <sub>J</sub> = +25 °C  | 6.6          |
|                        |                |                             |      | T <sub>J</sub> = +20 °C  | 5.2          |
|                        |                |                             |      | T <sub>J</sub> = +15 °C  | 3.3          |
|                        |                |                             |      | T <sub>J</sub> = +10 °C  | 4.9          |
|                        |                |                             |      | T <sub>J</sub> = +5 °C   | 7.7          |
|                        |                |                             |      | T <sub>J</sub> = 0 °C  | 11.6         |
|                        |                |                             |      | T <sub>J</sub> = -5 °C   |              |
|                        |                |                             |      | T <sub>J</sub> = -10 °C  |              |
|                        |                |                             |      | T <sub>J</sub> = -15 °C  |              |
|                        |                |                             |      | T <sub>J</sub> = -20 °C  |              |
|                        |                |                             |      | T <sub>J</sub> = -25 °C  |              |
|                        |                |                             |      | T <sub>J</sub> = -30 °C  |              |
|                        |                |                             |      | T <sub>J</sub> = -35 °C  |              |
|                        |                |                             |      | T <sub>J</sub> = -40 °C  |              |
|                        |                |                             |      | T <sub>J</sub> = -45 °C  |              |
|                        |                |                             |      | T <sub>J</sub> = -50 °C  |              |
|                        |                |                             |      | T <sub>J</sub> = -55 °C  |              |
|                        |                |                             |      | T <sub>J</sub> = -60 °C  |              |
|                        |                |                             |      | T <sub>J</sub> = -65 °C  |              |
|                        |                |                             |      | T <sub>J</sub> = -70 °C  |              |
|                        |                |                             |      | T <sub>J</sub> = -75 °C  |              |
|                        |                |                             |      | T <sub>J</sub> = -80 °C  |              |
|                        |                |                             |      | T <sub>J</sub> = -85 °C  |              |
|                        |                |                             |      | T <sub>J</sub> = -90 °C  |              |
|                        |                |                             |      | T <sub>J</sub> = -95 °C  |              |
|                        |                |                             |      | T <sub>J</sub> = -100 °C   |              |
|                        |                |                             |      | T <sub>J</sub> = -105 °C   |              |
|                        |                |                             |      | T <sub>J</sub> = -110 °C   |              |
|                        |                |                             |      | T <sub>J</sub> = -115 °C   |              |
|                        |                |                             |      | T <sub>J</sub> = -120 °C   |              |
|                        |                |                             |      | T <sub>J</sub> = -125 °C   |              |
|                        |                |                             |      | T <sub>J</sub> = -130 °C   |              |
|                        |                |                             |      | T <sub>J</sub> = -135 °C   |              |
|                        |                |                             |      | T <sub>J</sub> = -140 °C   |              |
|                        |                |                             |      | T <sub>J</sub> = -145 °C   |              |
|                        |                |                             |      | T <sub>J</sub> = -150 °C   |              |
|                        |                |                             |      | T <sub>J</sub> = -155 °C   |              |
|                        |                |                             |      | T <sub>J</sub> = -160 °C   |              |
|                        |                |                             |      | T <sub>J</sub> = -165 °C   |              |
|                        |                |                             |      | T <sub>J</sub> = -170 °C   |              |
|                        |                |                             |      | T <sub>J</sub> = -175 °C   |              |
|                        |                |                             |      | T <sub>J</sub> = -180 °C   |              |
|                        |                |                             |      | T <sub>J</sub> = -185 °C   |              |
|                        |                |                             |      | T <sub>J</sub> = -190 °C   |              |
|                        |                |                             |      | T <sub>J</sub> = -195 °C   |              |
|                        |                |                             |      | T <sub>J</sub> = -200 °C   |              |
|                        |                |                             |      | T <sub>J</sub> = -205 °C   |              |
|                        |                |                             |      | T <sub>J</sub> = -210 °C   |              |
|                        |                |                             |      | T <sub>J</sub> = -215 °C   |              |
|                        |                |                             |      | T <sub>J</sub> = -220 °C   |              |
|                        |                |                             |      | T <sub>J</sub> = -225 °C   |              |
|                        |                |                             |      | T <sub>J</sub> = -230 °C   |              |
|                        |                |                             |      | T <sub>J</sub> = -235 °C   |              |
|                        |                |                             |      | T <sub>J</sub> = -240 °C   |              |
|                        |                |                             |      | T <sub>J</sub> = -245 °C   |              |
|                        |                |                             |      | T <sub>J</sub> = -250 °C   |              |
|                        |                |                             |      | T <sub>J</sub> = -255 °C   |              |
|                        |                |                             |      | T <sub>J</sub> = -260 °C   |              |
|                        |                |                             |      | T <sub>J</sub> = -265 °C   |              |
|                        |                |                             |      | T <sub>J</sub> = -270 °C   |              |
|                        |                |                             |      | T <sub>J</sub> = -275 °C   |              |
|                        |                |                             |      | T <sub>J</sub> = -280 °C   |              |
|                        |                |                             |      | T <sub>J</sub> = -285 °C   |              |
|                        |                |                             |      | T <sub>J</sub> = -290 °C   |              |
|                        |                |                             |      | T <sub>J</sub> = -295 °C   |              |
|                        |                |                             |      | T <sub>J</sub> = -300 °C   |              |
|                        |                |                             |      | T <sub>J</sub> = -305 °C   |              |
|                        |                |                             |      | T <sub>J</sub> = -310 °C   |              |
|                        |                |                             |      | T <sub>J</sub> = -315 °C   |              |
|                        |                |                             |      | T <sub>J</sub> = -320 °C   |              |
|                        |                |                             |      | T <sub>J</sub> = -325 °C   |              |
|                        |                |                             |      | T <sub>J</sub> = -330 °C   |              |
|                        |                |                             |      | T <sub>J</sub> = -335 °C   |              |
|                        |                |                             |      | T <sub>J</sub> = -340 °C   |              |
|                        |                |                             |      | T <sub>J</sub> = -345 °C   |              |
|                        |                |                             |      | T <sub>J</sub> = -350 °C   |              |
|                        |                |                             |      | T <sub>J</sub> = -355 °C   |              |
|                        |                |                             |      | T <sub>J</sub> = -360 °C   |              |
|                        |                |                             |      | T <sub>J</sub> = -365 °C   |              |
|                        |                |                             |      | T <sub>J</sub> = -370 °C   |              |
|                        |                |                             |      | T <sub>J</sub> = -375 °C   |              |
|                        |                |                             |      | T <sub>J</sub> = -380 °C   |              |
|                        |                |                             |      | T <sub>J</sub> = -385 °C   |              |
|                        |                |                             |      | T <sub>J</sub> = -390 °C   |              |
|                        |                |                             |      | T <sub>J</sub> = -395 °C   |              |
|                        |                |                             |      | T <sub>J</sub> = -400 °C   |              |
|                        |                |                             |      | T <sub>J</sub> = -405 °C   |              |
|                        |                |                             |      | T <sub>J</sub> = -410 °C   |              |
|                        |                |                             |      | T <sub>J</sub> = -415 °C   |              |
|                        |                |                             |      | T <sub>J</sub> = -420 °C   |              |
|                        |                |                             |      | T <sub>J</sub> = -425 °C   |              |
|                        |                |                             |      | T <sub>J</sub> = -430 °C   |              |
|                        |                |                             |      | T <sub>J</sub> = -435 °C   |              |
|                        |                |                             |      | T <sub>J</sub> = -440 °C   |              |
|                        |                |                             |      | T <sub>J</sub> = -445 °C   |              |
|                        |                |                             |      | T <sub>J</sub> = -450 °C   |              |
|                        |                |                             |      | T <sub>J</sub> = -455 °C   |              |
|                        |                |                             |      | T <sub>J</sub> = -460 °C   |              |
|                        |                |                             |      | T <sub>J</sub> = -465 °C   |              |
|                        |                |                             |      | T <sub>J</sub> = -470 °C   |              |
|                        |                |                             |      | T <sub>J</sub> = -475 °C   |              |
|                        |                |                             |      | T <sub>J</sub> = -480 °C   |              |
|                        |                |                             |      | T <sub>J</sub> = -485 °C   |              |
|                        |                |                             |      | T <sub>J</sub> = -490 °C   |              |
|                        |                |                             |      | T <sub>J</sub> = -495 °C   |              |
|                        |                |                             |      | T <sub>J</sub> = -500 °C   |              |
|                        |                |                             |      | T <sub>J</sub> = -505 °C   |              |
|                        |                |                             |      | T <sub>J</sub> = -510 °C   |              |
|                        |                |                             |      | T <sub>J</sub> = -515 °C   |              |
|                        |                |                             |      | T <sub>J</sub> = -520 °C   |              |
|                        |                |                             |      | T <sub>J</sub> = -525 °C   |              |
|                        |                |                             |      | T <sub>J</sub> = -530 °C   |              |
|                        |                |                             |      | T <sub>J</sub> = -535 °C   |              |
|                        |                |                             |      | T <sub>J</sub> = -540 °C   |              |
|                        |                |                             |      | T <sub>J</sub> = -545 °C   |              |
|                        |                |                             |      | T <sub>J</sub> = -550 °C   |              |
|                        |                |                             |      | T <sub>J</sub> = -555 °C   |              |
|                        |                |                             |      | T <sub>J</sub> = -560 °C   |              |
|                        |                |                             |      | T <sub>J</sub> = -565 °C   |              |
|                        |                |                             |      | T <sub>J</sub> = -570 °C   |              |
|                        |                |                             |      | T <sub>J</sub> = -575 °C   |              |
|                        |                |                             |      | T <sub>J</sub> = -580 °C   |              |
|                        |                |                             |      | T <sub>J</sub> = -585 °C   |              |
|                        |                |                             |      | T <sub>J</sub> = -590 °C   |              |
|                        |                |                             |      | T <sub>J</sub> = -595 °C   |              |
|                        |                |                             |      | T <sub>J</sub> = -600 °C   |              |
|                        |                |                             |      | T <sub>J</sub> = -605 °C   |              |
|                        |                |                             |      | T <sub>J</sub> = -610 °C   |              |
|                        |                |                             |      | T <sub>J</sub> = -615 °C   |              |
|                        |                |                             |      | T <sub>J</sub> = -620 °C   |              |
|                        |                |                             |      | T <sub>J</sub> = -625 °C   |              |
|                        |                |                             |      | T <sub>J</sub> = -630 °C   |              |
|                        |                |                             |      | T <sub>J</sub> = -635 °C   |              |
|                        |                |                             |      | T <sub>J</sub> = -640 °C   |              |
|                        |                |                             |      | T <sub>J</sub> = -645 °C   |              |
|                        |                |                             |      | T <sub>J</sub> = -650 °C   |              |
|                        |                |                             |      | T <sub>J</sub> = -655 °C   |              |
|                        |                |                             |      | T <sub>J</sub> = -660 °C   |              |
|                        |                |                             |      | T <sub>J</sub> = -665 °C   |              |
|                        |                |                             |      | T <sub>J</sub> = -670 °C   |              |
|                        |                |                             |      | T <sub>J</sub> = -675 °C   |              |
|                        |                |                             |      | T <sub>J</sub> = -680 °C   |              |
|                        |                |                             |      | T <sub>J</sub> = -685 °C   |              |
|                        |                |                             |      | T <sub>J</sub> = -690 °C   |              |
|                        |                |                             |      | T <sub>J</sub> = -695 °C   |              |
|                        |                |                             |      | T <sub>J</sub> = -700 °C   |              |
|                        |                |                             |      | T <sub>J</sub> = -705 °C   |              |
|                        |                |                             |      | T <sub>J</sub> = -710 °C   |              |
|                        |                |                             |      | T <sub>J</sub> = -715 °C   |              |
|                        |                |                             |      | T <sub>J</sub> = -720 °C   |              |
|                        |                |                             |      | T <sub>J</sub> = -725 °C   |              |
|                        |                |                             |      | T <sub>J</sub> = -730 °C   |              |
|                        |                |                             |      | T <sub>J</sub> = -735 °C   |              |
|                        |                |                             |      | T <sub>J</sub> = -740 °C   |              |
|                        |                |                             |      | T <sub>J</sub> = -745 °C   |              |
|                        |                |                             |      | T <sub>J</sub> = -750 °C   |              |
|                        |                |                             |      | T <sub>J</sub> = -755 °C   |              |
|                        |                |                             |      | T <sub>J</sub> = -760 °C   |              |
|                        |                |                             |      | T <sub>J</sub> = -765 °C   |              |
|                        |                |                             |      | T <sub>J</sub> = -770 °C   |              |
|                        |                |                             |      | T <sub>J</sub> = -775 °C   |              |
|                        |                |                             |      | T <sub>J</sub> = -780 °C   |              |
|                        |                |                             |      | T <sub>J</sub> = -785 °C   |              |
|                        |                |                             |      | T <sub>J</sub> = -790 °C   |              |
|                        |                |                             |      | T <sub>J</sub> = -795 °C   |              |
|                        |                |                             |      | T <sub>J</sub> = -800 °C   |              |
|                        |                |                             |      | T <sub>J</sub> = -805 °C   |              |
|                        |                |                             |      | T <sub>J</sub> = -810 °C   |              |
|                        |                |                             |      | T <sub>J</sub> = -815 °C   |              |
|                        |                |                             |      | T <sub>J</sub> = -820 °C   |              |
|                        |                |                             |      | T <sub>J</sub> = -825 °C   |              |
|                        |                |                             |      | T <sub>J</sub> = -830 °C   |              |
|                        |                |                             |      | T <sub>J</sub> = -835 °C   |              |
|                        |                |                             |      | T <sub>J</sub> = -840 °C   |              |
|                        |                |                             |      | T <sub>J</sub> = -845 °C   |              |
|                        |                |                             |      | T <sub>J</sub> = -850 °C   |              |
|                        |                |                             |      | T <sub>J</sub> = -855 °C   |              |
|                        |                |                             |      | T <sub>J</sub> = -860 °C   |              |
|                        |                |                             |      | T <sub>J</sub> = -865 °C   |              |
|                        |                |                             |      | T <sub>J</sub> = -870 °C   |              |
|                        |                |                             |      | T <sub>J</sub> = -875 °C   |              |
|                        |                |                             |      | T <sub>J</sub> = -880 °C   |              |
|                        |                |                             |      | T <sub>J</sub> = -885 °C   |              |
|                        |                |                             |      | T <sub>J</sub> = -890 °C   |              |
|                        |                |                             |      | T <sub>J</sub> = -895 °C   |              |
|                        |                |                             |      | T <sub>J</sub> = -900 °C   |              |
|                        |                |                             |      | T <sub>J</sub> = -905 °C   |              |
|                        |                |                             |      | T <sub>J</sub> = -910 °C   |              |
|                        |                |                             |      | T <sub>J</sub> = -915 °C   |              |
|                        |                |                             |      | T <sub>J</sub> = -920 °C   |              |
|                        |                |                             |      | T <sub>J</sub> = -925 °C   |              |
|                        |                |                             |      | T <sub>J</sub> = -930 °C   |              |
|                        |                |                             |      | T <sub>J</sub> = -935 °C   |              |
|                        |                |                             |      | T <sub>J</sub> = -940 °C   |              |
|                        |                |                             |      | T <sub>J</sub> = -945 °C   |              |
|                        |                |                             |      | T <sub>J</sub> = -950 °C   |              |
|                        |                |                             |      | T <sub>J</sub> = -955 °C   |              |
|                        |                |                             |      | T <sub>J</sub> = -960 °C   |              |
|                        |                |                             |      | T <sub>J</sub> = -965 °C   |              |
|                        |                |                             |      | T <sub>J</sub> = -970 °C   |              |
|                        |                |                             |      | T <sub>J</sub> = -975 °C   |              |
|                        |                |                             |      | T <sub>J</sub> = -980 °C   |              |
|                        |                |                             |      | T <sub>J</sub> = -985 °C   |              |
|                        |                |                             |      | T <sub>J</sub> = -990 °C   |              |
|                        |                |                             |      | T <sub>J</sub> = -995 °C   |              |
|                        |                |                             |      | T <sub>J</sub> = -1000 °C  |              |
|                        |                |                             |      | T <sub>J</sub> = -1005 °C  |              |
|                        |                |                             |      | T <sub>J</sub> = -1010 °C  |              |
|                        |                |                             |      | T <sub>J</sub> = -1015 °C  |              |
|                        |                |                             |      | T <sub>J</sub> = -1020 °C  |              |
|                        |                |                             |      | T <sub>J</sub> = -1025 °C  |              |
|                        |                |                             |      | T <sub>J</sub> = -1030 °C  |              |
|                        |                |                             |      | T <sub>J</sub> = -1035 °C  |              |
|                        |                |                             |      | T <sub>J</sub> = -1040 °C  |              |
|                        |                |                             |      | T <sub>J</sub> = -1045 °C  |              |
|                        |                |                             |      | T <sub>J</sub> = -1050 °C  |              |
|                        |                |                             |      | T <sub>J</sub> = -1055 °C  |              |
|                        |                |                             |      | T <sub>J</sub> = -1060 °C  |              |
|                        |                |                             |      | T <sub>J</sub> = -1065 °C  |              |
|                        |                |                             |      | T <sub>J</sub> = -1070 °C  |              |
|                        |                |                             |      | T <sub>J</sub> = -1075 °C  |              |
|                        |                |                             |      | T <sub>J</sub> = -1080 °C  |              |
|                        |                |                             |      | T <sub>J</sub> = -1085 °C  |              |
|                        |                |                             |      | T <sub>J</sub> = -1090 °C  |              |
|                        |                |                             |      | T <sub>J</sub> = -1095 °C  |              |
|                        |                |                             |      | T <sub>J</sub> = -1100 °C  |              |
|                        |                |                             |      | T <sub>J</sub> = -1105 °C  |              |
|                        |                |                             |      | T <sub>J</sub> = -1110 °C  |              |
|                        |                |                             |      | T <sub>J</sub> = -1115 °C  |              |
|                        |                |                             |      | T <sub>J</sub> = -1120 °C  |              |
|                        |                |                             |      | T <sub>J</sub> = -1125 °C  |              |
|                        |                |                             |      | T <sub>J</sub> = -1130 °C  |              |
|                        |                |                             |      | T <sub>J</sub> = -1135 °C  |              |

Information requirements for air-to-air air conditioners

Model(s): Outdoor Unit U-125PE1E8A X4  
 Indoor Unit S-36PUZE5A air  
 Outdoor side heat exchanger of air conditioner: air  
 Indoor side heat exchanger of air conditioner: air  
 Type: compressor driven vapour compression or sorption process vapour compression  
 if applicable: driver of compressor: [electric motor or fuel driven, electric motor]  
 gaseous or liquid fuel, internal or external combustion engine] electric motor

| Item  | Symbol   | Value    | Unit | Item  | Symbol              | Value | Unit                              |
|---|--|----------|------|---|---------------------|-------|-----------------------------------|
| Rated cooling capacity  | P <sub>rated,c</sub>   | 12.5     | kW   | Seasonal space cooling energy efficiency  | η <sub>s,c</sub>    | 276.4 | %                                 |
| Refrigeration load  | P <sub>design,c</sub>  | 12.5     | kW   | Declared energy efficiency ratio or gas utilization efficiency / auxiliary energy factor for part load at given outdoor temperatures T <sub>J</sub> |                     |       |                                   |
| Declared cooling capacity for part load at given outdoor temperatures T <sub>J</sub> and indoor 27°/19°C (dry/wet bulb) |  |          |      | Declared heating capacity for part load at indoor temperature 20 °C and outdoor temperature T <sub>J</sub>  |                     |       |                                   |
| T <sub>J</sub> = + 35 °C  |  | 12.5     | kW   | T <sub>J</sub> = + 35 °C  |                     | 11.0  | kW                                |
| T <sub>J</sub> = + 30 °C  |  | 9.2      | kW   | T <sub>J</sub> = + 30 °C  |                     | 6.7   | kW                                |
| T <sub>J</sub> = + 25 °C  |  | 5.9      | kW   | T <sub>J</sub> = + 25 °C  |                     | 4.3   | kW                                |
| T <sub>J</sub> = + 20 °C  |  | 5.3      | kW   | T <sub>J</sub> = + 20 °C  |                     | 4.5   | kW                                |
| Degradation co- efficient for air conditioners**  | C <sub>de</sub>  | 0.25     | -    | T <sub>bw</sub> = bivalent temperature  | P <sub>dh</sub>     | 12.5  | kW                                |
|   |  |          |      | T <sub>ol</sub> = operation limit   |                     | 9.3   | kW                                |
|   |  |          |      | For air-to-water heat pumps: T <sub>J</sub> = - 15 °C (if T <sub>ol</sub> < - 20 °C)  |                     | -     | kW                                |
|   |  |          |      | Bivalent temperature  | T <sub>bw</sub>     | - 10  | °C                                |
|   |  |          |      | Degradation co- efficient heat pumps**  | C <sub>dh</sub>     | 0.25  | -                                 |
|   |  |          |      | Power consumption in modes other than 'active mode'   |                     |       |                                   |
| Off mode  | P <sub>off</sub>   | 0.015    | kW   | Crankcase heater mode   | P <sub>ck</sub>     | 0.000 | kW                                |
| Thermostat-off mode   | P <sub>to</sub>  | 0.000    | kW   | Standby mode  | P <sub>sb</sub>     | 0.015 | kW                                |
|   |  |          |      | Other items   |                     |       |                                   |
| Capacity control  |  | variable |      | For air-to-air air conditioner: air flow rate, outdoor  |                     | 7800  | m³/h                              |
| Sound power level, outdoor  | L <sub>WA</sub>  | 70.0     | dB   |   |                     |       |                                   |
| Sound power level, indoor   | L <sub>WA</sub>  | 45.0     | dB   | if engine driven: Emissions of nitrogen oxides  | NO <sub>x</sub> *** | -     | mg/kWh fuel input GCV             |
|   |  |          |      | GWP of the refrigerant  |                     | 2088  | kg CO <sub>2</sub> eq (100 years) |
| Contact details   | Panasonic Testing Centre, Panasonic Marketing Europe GmbH Winsberging 15, 22525 Hamburg, Germany |          |      |   |                     |       |                                   |

\*\* If C<sub>de</sub> is not determined by measurement then the default degradation coefficient air conditioners shall be 0.25.  
 \*\*\* from 26 September 2018.  
 Where information relates to multi-split air conditioners, the test result and performance data may be obtained on the basis of the performance of the outdoor unit, with a combination of indoor unit(s) recommended by the manufacturer or importer.

Information requirements for heat pumps

Model(s): Outdoor Unit U-125PE1E8A X4  
 Indoor Unit S-36PUZE5A air  
 Outdoor side heat exchanger of heat pump: air  
 Indoor side heat exchanger of heat pump: air  
 Indication if the heater is equipped with a supplementary heater: no  
 if applicable: driver of compressor: [electric motor or fuel driven, electric motor]  
 gaseous or liquid fuel, internal or external combustion engine] electric motor  
 Parameters shall be declared for the average heating season, parameters for the warmer and colder heating seasons are optional.

| Item   | Symbol   | Value    | Unit | Item   | Symbol  | Value | Unit                              |
|--|--|----------|------|--|---|-------|-----------------------------------|
| Rated heating capacity   | P <sub>rated,h</sub>   | 14.0     | kW   | Seasonal space heating energy efficiency   | η <sub>s,h</sub>  | 161.0 | %                                 |
| Refrigeration load   | P <sub>design,h</sub>  | 12.5     | kW   | Declared coefficient of performance or gas utilization efficiency / auxiliary energy factor for part load at given outdoor temperatures T <sub>J</sub> |   |       |                                   |
| Declared heating capacity for part load at indoor temperature 20 °C and outdoor temperature T <sub>J</sub> |  |          |      | Declared heating capacity for part load at indoor temperature 20 °C and outdoor temperature T <sub>J</sub>   |   |       |                                   |
| T <sub>J</sub> = - 7 °C  |  | 11.0     | kW   | T <sub>J</sub> = - 7 °C  |   | 2.5   | %                                 |
| T <sub>J</sub> = + 2 °C  |  | 6.7      | kW   | T <sub>J</sub> = + 2 °C  |   | 3.9   | %                                 |
| T <sub>J</sub> = + 7 °C  |  | 4.3      | kW   | T <sub>J</sub> = + 7 °C  |   | 5.8   | %                                 |
| T <sub>J</sub> = + 12 °C   |  | 4.5      | kW   | T <sub>J</sub> = + 12 °C   |   | 7.0   | %                                 |
| T <sub>bw</sub> = bivalent temperature   | P <sub>dh</sub>  | 12.5     | kW   | T <sub>bw</sub> = bivalent temperature   | COP <sub>h</sub> or GUE <sub>h,brn</sub> / AEF <sub>h,brn</sub> | 2.3   | %                                 |
| T <sub>ol</sub> = operation limit  |  | 9.3      | kW   | T <sub>ol</sub> = operation limit  |   | 1.8   | %                                 |
| For air-to-water heat pumps: T <sub>J</sub> = - 15 °C (if T <sub>ol</sub> < - 20 °C)                       |  | -        | kW   | For water-to-air heat pumps: T <sub>J</sub> = - 15 °C (if T <sub>ol</sub> < - 20 °C)   |   | -     | %                                 |
| Bivalent temperature   | T <sub>bw</sub>  | - 10     | °C   | For water-to-air heat pumps: Operation limit temperature   | T <sub>ol</sub>   | - 20  | °C                                |
| Degradation co- efficient heat pumps**   | C <sub>dh</sub>  | 0.25     | -    |  |   |       |                                   |
| Power consumption in modes other than 'active mode'  |  |          |      |  |   |       |                                   |
| Off mode   | P <sub>off</sub>   | 0.015    | kW   | Supplementary heater back-up heating capacity *  | eibu  | 0.0   | kW                                |
| Thermostat-off mode  | P <sub>to</sub>  | 0.000    | kW   | Type of energy input   |   |       |                                   |
| Crankcase heater mode  | P <sub>ck</sub>  | 0.000    | kW   | Standby mode   | P <sub>sb</sub>   | 0.015 | kW                                |
|  |  |          |      | Other items  |   |       |                                   |
| Capacity control   |  | variable |      | For air-to-air heat pumps: air flow rate, outdoor  |   | 6600  | m³/h                              |
| Sound power level, outdoor   | L <sub>WA</sub>  | 70.0     | dB   | For water-/brine-to-air heat pumps: Rated brine or water flow rate, outdoor side heat exchanger  |   | -     | m³/h                              |
| Sound power level, indoor  | L <sub>WA</sub>  | 45.0     | dB   | Emissions of nitrogen oxides (if applicable)   | NO <sub>x</sub> ***   | -     | mg/kWh fuel input GCV             |
|  |  |          |      | GWP of the refrigerant   |   | 2088  | kg CO <sub>2</sub> eq (100 years) |
| Contact details  | Panasonic Testing Centre, Panasonic Marketing Europe GmbH Winsberging 15, 22525 Hamburg, Germany |          |      |  |   |       |                                   |

\*\* If C<sub>dh</sub> is not determined by measurement then the default degradation coefficient of heat pumps shall be 0.25.  
 \*\*\* from 26 September 2018.  
 Where information relates to multi-split heat pumps, the test result and performance data may be obtained on the basis of the performance of the outdoor unit, with a combination of indoor unit(s) recommended by the manufacturer or importer.

## Information requirements for air-to-air air conditioners

|  |  |                             |  |                           |  |    |  |
|--|--|-----------------------------|--|---------------------------|--|----|--|
| Model(s):  |  | Outdoor Unit<br>Indoor Unit |  | U-125PE1E8A<br>S-45PUZE8A |  | X3 |  |
| Outdoor side heat exchanger of air conditioner:  |  | air                         |  |                           |  |    |  |
| Indoor side heat exchanger of air conditioner:   |  | air                         |  |                           |  |    |  |
| Type: compressor driven vapour compression or sorption process   |  | vapour compression          |  |                           |  |    |  |
| if applicable: driver of compressor: [electric motor or fuel driven, gaseous or liquid fuel, internal or external combustion engine] |  | electric motor              |  |                           |  |    |  |

| Item  | Symbol  | Value    | Unit | Item  | Symbol  | Value | Unit                              |
|---|---|----------|------|---|---|-------|-----------------------------------|
| Rated cooling capacity  | $P_{rated,c}$   | 12.5     | kW   | Seasonal space cooling energy efficiency  | $\eta_{s,c}$  | 276.4 | %                                 |
| Refrigeration load  | $P_{design,c}$  | 12.5     | kW   | Declared energy efficiency ratio or gas utilization efficiency / auxiliary energy factor for part load at given outdoor temperatures T <sub>J</sub> |   |       |                                   |
| Declared cooling capacity for part load at given outdoor temperatures T <sub>J</sub> and indoor 27°/19°C (dry/wet bulb) |   |          |      |   |   |       |                                   |
| T <sub>J</sub> = + 35 °C  |   | 12.5     | kW   | T <sub>J</sub> = + 35 °C  |   | 3.7   | %                                 |
| T <sub>J</sub> = + 30 °C  |   | 9.2      | kW   | T <sub>J</sub> = + 30 °C  | EER <sub>d</sub> or GUE <sub>c,bin</sub> / AEF <sub>c,bin</sub> | 5.4   | %                                 |
| T <sub>J</sub> = + 25 °C  |   | 5.9      | kW   | T <sub>J</sub> = + 25 °C  |   | 8.2   | %                                 |
| T <sub>J</sub> = + 20 °C  |   | 5.3      | kW   | T <sub>J</sub> = + 20 °C  |   | 11.6  | %                                 |
| Degradation co- efficient for air conditioners**  | $C_{de}$  | 0.25     | -    |   |   |       |                                   |
| Power consumption in modes other than 'active mode'   |   |          |      |   |   |       |                                   |
| Off mode  | $P_{off}$   | 0.015    | kW   | Crankcase heater mode   | $P_{ck}$  | 0.000 | kW                                |
| Thermostat-off mode   | $P_{to}$  | 0.000    | kW   | Standby mode  | $P_{sb}$  | 0.015 | kW                                |
| Other items   |   |          |      |   |   |       |                                   |
| Capacity control  |   | variable |      | For air-to-air air conditioner: air flow rate, outdoor  |   | 7800  | m <sup>3</sup> /h                 |
| Sound power level, outdoor  | $L_{WA}$  | 70.0     | dB   |   |   |       |                                   |
| Sound power level, indoor   | $L_{WA}$  | 46.0     | dB   | if engine driven: Emissions of nitrogen oxides  | $NO_x^{***}$  | -     | mg/kWh fuel input GCV             |
|   |   |          |      | GWP of the refrigerant  |   | 2088  | kg CO <sub>2</sub> eq (100 years) |
| Contact details   | Panasonic Testing Centre, Panasonic Marketing Europe GmbH Wirsberg 15, 22525 Hamburg, Germany |          |      |   |   |       |                                   |

\*\* If  $C_{de}$  is not determined by measurement then the default degradation coefficient air conditioners shall be 0.25.  
\*\*\* from 26 September 2018.

Where information relates to multi-split air conditioners, the test result and performance data may be obtained on the basis of the performance of the outdoor unit, with a combination of indoor unit(s) recommended by the manufacturer or importer.

## Information requirements for heat pumps

|  |  |                             |  |                           |  |    |  |
|--|--|-----------------------------|--|---------------------------|--|----|--|
| Model(s):  |  | Outdoor Unit<br>Indoor Unit |  | U-125PE1E8A<br>S-45PUZE8A |  | X3 |  |
| Outdoor side heat exchanger of heat pump:  |  | air                         |  |                           |  |    |  |
| Indoor side heat exchanger of heat pump:   |  | air                         |  |                           |  |    |  |
| Indication if the heater is equipped with a supplementary heater:  |  | no                          |  |                           |  |    |  |
| if applicable: driver of compressor: [electric motor or fuel driven, gaseous or liquid fuel, internal or external combustion engine] |  | electric motor              |  |                           |  |    |  |

Parameters shall be declared for the average heating season, parameters for the warmer and colder heating seasons are optional.

| Item   | Symbol  | Value    | Unit | Item   | Symbol  | Value | Unit                              |
|--|---|----------|------|--|---|-------|-----------------------------------|
| Rated heating capacity   | $P_{rated,h}$   | 14.0     | kW   | Seasonal space heating energy efficiency   | $\eta_{s,h}$  | 161.0 | %                                 |
| Refrigeration load   | $P_{design,h}$  | 12.5     | kW   | Declared coefficient of performance or gas utilization efficiency / auxiliary energy factor for part load at given outdoor temperatures T <sub>J</sub> |   |       |                                   |
| Declared heating capacity for part load at indoor temperature 20 °C and outdoor temperature T <sub>J</sub> |   |          |      |  |   |       |                                   |
| T <sub>J</sub> = - 7 °C  |   | 11.0     | kW   | T <sub>J</sub> = - 7 °C  |   | 2.5   | %                                 |
| T <sub>J</sub> = + 2 °C  |   | 6.7      | kW   | T <sub>J</sub> = + 2 °C  |   | 3.9   | %                                 |
| T <sub>J</sub> = + 7 °C  |   | 4.3      | kW   | T <sub>J</sub> = + 7 °C  |   | 5.8   | %                                 |
| T <sub>J</sub> = + 12 °C   |   | 4.5      | kW   | T <sub>J</sub> = + 12 °C   |   | 7.0   | %                                 |
| $T_{bw}$ = bivalent temperature  | $P_{bh}$  | 12.5     | kW   | $T_{bw}$ = bivalent temperature  | COP <sub>d</sub> or GUE <sub>h,bin</sub> / AEF <sub>h,bin</sub> | 2.3   | %                                 |
| $T_{ol}$ = operation limit   |   | 9.3      | kW   | $T_{ol}$ = operation limit   |   | 1.8   | %                                 |
| For air-to-water heat pumps: T <sub>J</sub> = - 15 °C (if T <sub>ol</sub> < - 20 °C)                       |   | -        | kW   | For water-to-air heat pumps: T <sub>J</sub> = - 15 °C (if T <sub>ol</sub> < - 20 °C)   |   | -     | %                                 |
| Bivalent temperature   | $T_{bv}$  | - 10     | °C   | For water-to-air heat pumps: Operation limit temperature   | $T_{ol}$  | - 20  | °C                                |
| Degradation co- efficient heat pumps**   | $C_{dh}$  | 0.25     | -    |  |   |       |                                   |
| Power consumption in modes other than 'active mode'  |   |          |      |  |   |       |                                   |
| Off mode   | $P_{off}$   | 0.015    | kW   | Supplementary heater back-up heating capacity*   | $e_{ibu}$   | 0.0   | kW                                |
| Thermostat-off mode  | $P_{to}$  | 0.000    | kW   | Type of energy input   |   |       |                                   |
| Crankcase heater mode  | $P_{ck}$  | 0.000    | kW   | Standby mode   | $P_{sb}$  | 0.015 | kW                                |
| Other items  |   |          |      |  |   |       |                                   |
| Capacity control   |   | variable |      | For air-to-air heat pumps: air flow rate, outdoor  |   | 6600  | m <sup>3</sup> /h                 |
| Sound power level, outdoor   | $L_{WA}$  | 70.0     | dB   | For water-/brine-to-air heat pumps: Rated brine or water flow rate, outdoor side heat exchanger  |   | -     | m <sup>3</sup> /h                 |
| Sound power level, indoor  | $L_{WA}$  | 46.0     | dB   | Emissions of nitrogen oxides (if applicable)   | $NO_x^{***}$  | -     | mg/kWh fuel input GCV             |
|  |   |          |      | GWP of the refrigerant   |   | 2088  | kg CO <sub>2</sub> eq (100 years) |
| Contact details  | Panasonic Testing Centre, Panasonic Marketing Europe GmbH Wirsberg 15, 22525 Hamburg, Germany |          |      |  |   |       |                                   |

\*\* If  $C_{dh}$  is not determined by measurement then the default degradation coefficient of heat pumps shall be 0.25.  
\*\*\* from 26 September 2018.

Where information relates to multi-split heat pumps, the test result and performance data may be obtained on the basis of the performance of the outdoor unit, with a combination of indoor unit(s) recommended by the manufacturer or importer.

Information requirements for air-to-air air conditioners

|  |  |                             |  |                           |  |    |  |
|--|--|-----------------------------|--|---------------------------|--|----|--|
| Model(s):  |  | Outdoor Unit<br>Indoor Unit |  | U-140PE1E8A<br>S-50PUZE5A |  | X3 |  |
| Outdoor side heat exchanger of air conditioner:  |  | air                         |  |                           |  |    |  |
| Indoor side heat exchanger of air conditioner:   |  | air                         |  |                           |  |    |  |
| Type: compressor driven vapour compression or sorption process   |  | vapour compression          |  |                           |  |    |  |
| if applicable: driver of compressor: [electric motor or fuel driven, gaseous or liquid fuel, internal or external combustion engine] |  | electric motor              |  |                           |  |    |  |

| Item   | Symbol                | Value           | Unit | Item   | Symbol           | Value | Unit |
|--|-----------------------|-----------------|------|--|------------------|-------|------|
| Rated cooling capacity   | P <sub>rated,c</sub>  | 14.0            | kW   | Seasonal space cooling energy efficiency   | η <sub>s,c</sub> | 260.0 | %    |
| Refrigeration load   | P <sub>design,c</sub> | 14.0            | kW   | Declared energy efficiency ratio or gas utilization efficiency / auxiliary energy factor for part load at given outdoor temperatures T <sub>J</sub> and indoor 27°/19°C (dry/wet bulb) |                  |       |      |
| T <sub>J</sub> = + 35 °C   |                       | 14.0            | kW   | T <sub>J</sub> = + 35 °C   |                  | 3.3   | %    |
| T <sub>J</sub> = + 30 °C   |                       | 10.3            | kW   | T <sub>J</sub> = + 30 °C   |                  | 4.9   | %    |
| T <sub>J</sub> = + 25 °C   |                       | 6.6             | kW   | T <sub>J</sub> = + 25 °C   |                  | 7.7   | %    |
| T <sub>J</sub> = + 20 °C   |                       | 5.3             | kW   | T <sub>J</sub> = + 20 °C   |                  | 11.6  | %    |
| Degradation co- efficient for air conditioners**                                     | C <sub>de</sub>       | 0.25            | -    | Declared coefficient of performance or gas utilization efficiency / auxiliary energy factor for part load at given outdoor temperatures T <sub>J</sub>                                 |                  |       |      |
| T <sub>J</sub> = - 7 °C  |                       | 12.3            | kW   | T <sub>J</sub> = - 7 °C  |                  | 2.4   | %    |
| T <sub>J</sub> = + 2 °C  |                       | 7.5             | kW   | T <sub>J</sub> = + 2 °C  |                  | 3.7   | %    |
| T <sub>J</sub> = + 7 °C  |                       | 4.8             | kW   | T <sub>J</sub> = + 7 °C  |                  | 5.5   | %    |
| T <sub>J</sub> = + 12 °C   |                       | 4.5             | kW   | T <sub>J</sub> = + 12 °C   |                  | 7.0   | %    |
| T <sub>bw</sub> = bivalent temperature   |                       | 12.3            | kW   | T <sub>bw</sub> = bivalent temperature   |                  | 2.4   | %    |
| T <sub>ol</sub> = operation limit  |                       | 9.5             | kW   | T <sub>ol</sub> = operation limit  |                  | 1.7   | %    |
| For air-to-water heat pumps: T <sub>J</sub> = - 15 °C (if T <sub>ol</sub> < - 20 °C) |                       | -               | kW   | For water-to-air heat pumps: T <sub>J</sub> = - 15 °C (if T <sub>ol</sub> < - 20 °C)   |                  | -     | %    |
| Bivalent temperature   |                       | -7              | °C   | For water-to-air heat pumps: Operation limit temperature   |                  | -20   | °C   |
| Degradation co- efficient heat pumps**   |                       | C <sub>dh</sub> | 0.25 |  |                  |       |      |

| Item                       | Symbol  | Value    | Unit | Item   | Symbol | Value               | Unit                              |
|----------------------------|---|----------|------|--|--------|---------------------|-----------------------------------|
| Off mode                   | P <sub>OFF</sub>  | 0.015    | kW   | Power consumption in modes other than 'active mode'    |        |                     |                                   |
| Thermostat-off mode        | P <sub>TO</sub>   | 0.000    | kW   | Crankcase heater mode                                  |        | P <sub>CK</sub>     | 0.000                             |
|                            |   |          |      | Standby mode   |        | P <sub>SB</sub>     | 0.015                             |
| Other items                |   |          |      |  |        |                     |                                   |
| Capacity control           |   | variable |      | For air-to-air air conditioner: air flow rate, outdoor |        |                     | 8100                              |
| Sound power level, outdoor | L <sub>WA</sub>   | 71.0     | dB   |  |        |                     |                                   |
| Sound power level, indoor  | L <sub>WA</sub>   | 47.0     | dB   | if engine driven: Emissions of nitrogen oxides         |        | NO <sub>x</sub> *** | mg/kWh fuel input GCV             |
|                            |   |          |      | GWP of the refrigerant                                 |        |                     | kg CO <sub>2</sub> eq (100 years) |
| Contact details            | Panasonic Testing Centre, Panasonic Marketing Europe GmbH Winsberg 15, 22525 Hamburg, Germany |          |      |  |        |                     |                                   |

\*\* If C<sub>de</sub> is not determined by measurement then the default degradation coefficient of air conditioners shall be 0.25.  
 \*\*\* from 26 September 2018.  
 Where information relates to multi-split air conditioners, the test result and performance data may be obtained on the basis of the performance of the outdoor unit, with a combination of indoor unit(s) recommended by the manufacturer or importer.

Information requirements for heat pumps

|  |  |                             |  |                           |  |    |  |
|--|--|-----------------------------|--|---------------------------|--|----|--|
| Model(s):  |  | Outdoor Unit<br>Indoor Unit |  | U-140PE1E8A<br>S-50PUZE5A |  | X3 |  |
| Outdoor side heat exchanger of heat pump:  |  | air                         |  |                           |  |    |  |
| Indoor side heat exchanger of heat pump:   |  | air                         |  |                           |  |    |  |
| Indication if the heater is equipped with a supplementary heater: if applicable: driver of compressor: [electric motor or fuel driven, gaseous or liquid fuel, internal or external combustion engine] |  | no                          |  |                           |  |    |  |
| Parameters shall be declared for the average heating season, parameters for the warmer and colder heating seasons are optional.  |  | electric motor              |  |                           |  |    |  |

| Item   | Symbol  | Value           | Unit | Item   | Symbol           | Value               | Unit                              |
|--|---|-----------------|------|--|------------------|---------------------|-----------------------------------|
| Rated heating capacity   | P <sub>rated,h</sub>  | 16.0            | kW   | Seasonal space heating energy efficiency   | η <sub>s,h</sub> | 152.9               | %                                 |
| Refrigeration load   | P <sub>design,h</sub>   | 14.0            | kW   | Declared coefficient of performance or gas utilization efficiency / auxiliary energy factor for part load at given outdoor temperatures T <sub>J</sub> |                  |                     |                                   |
| T <sub>J</sub> = - 7 °C  |   | 12.3            | kW   | T <sub>J</sub> = - 7 °C  |                  | 2.4                 | %                                 |
| T <sub>J</sub> = + 2 °C  |   | 7.5             | kW   | T <sub>J</sub> = + 2 °C  |                  | 3.7                 | %                                 |
| T <sub>J</sub> = + 7 °C  |   | 4.8             | kW   | T <sub>J</sub> = + 7 °C  |                  | 5.5                 | %                                 |
| T <sub>J</sub> = + 12 °C   |   | 4.5             | kW   | T <sub>J</sub> = + 12 °C   |                  | 7.0                 | %                                 |
| T <sub>bw</sub> = bivalent temperature   |   | 12.3            | kW   | T <sub>bw</sub> = bivalent temperature   |                  | 2.4                 | %                                 |
| T <sub>ol</sub> = operation limit  |   | 9.5             | kW   | T <sub>ol</sub> = operation limit  |                  | 1.7                 | %                                 |
| For air-to-water heat pumps: T <sub>J</sub> = - 15 °C (if T <sub>ol</sub> < - 20 °C) |   | -               | kW   | For water-to-air heat pumps: T <sub>J</sub> = - 15 °C (if T <sub>ol</sub> < - 20 °C)   |                  | -                   | %                                 |
| Bivalent temperature   |   | -7              | °C   | For water-to-air heat pumps: Operation limit temperature   |                  | -20                 | °C                                |
| Degradation co- efficient heat pumps**   |   | C <sub>dh</sub> | 0.25 |  |                  |                     |                                   |
| Power consumption in modes other than 'active mode'                                  |   |                 |      |  |                  |                     |                                   |
| Off mode   | P <sub>OFF</sub>  | 0.015           | kW   | Supplementary heater back-up heating capacity *  |                  | eibu                | 2.4                               |
| Thermostat-off mode  | P <sub>TO</sub>   | 0.000           | kW   | Type of energy input   |                  |                     |                                   |
| Crankcase heater mode  | P <sub>CK</sub>   | 0.000           | kW   | Standby mode   |                  | P <sub>SB</sub>     | 0.015                             |
| Other items  |   |                 |      |  |                  |                     |                                   |
| Capacity control   |   | variable        |      | For air-to-air heat pumps: air flow rate, outdoor  |                  |                     | 7200                              |
| Sound power level, outdoor   | L <sub>WA</sub>   | 71.0            | dB   | For water-/brine-to-air heat pumps: Rated brine or water flow rate, outdoor side heat exchanger  |                  |                     | -                                 |
| Sound power level, indoor  | L <sub>WA</sub>   | 47.0            | dB   | Emissions of nitrogen oxides (if applicable)   |                  | NO <sub>x</sub> *** | mg/kWh fuel input GCV             |
|  |   |                 |      | GWP of the refrigerant   |                  |                     | kg CO <sub>2</sub> eq (100 years) |
| Contact details  | Panasonic Testing Centre, Panasonic Marketing Europe GmbH Winsberg 15, 22525 Hamburg, Germany |                 |      |  |                  |                     |                                   |

\*\* If C<sub>dh</sub> is not determined by measurement then the default degradation coefficient of heat pumps shall be 0.25.  
 \*\*\* from 26 September 2018.  
 Where information relates to multi-split heat pumps, the test result and performance data may be obtained on the basis of the performance of the outdoor unit, with a combination of indoor unit(s) recommended by the manufacturer or importer.

## Information requirements for air-to-air air conditioners

|  |  |                             |  |                           |  |    |  |
|--|--|-----------------------------|--|---------------------------|--|----|--|
| Model(s):  |  | Outdoor Unit<br>Indoor Unit |  | U-125PE1E8A<br>S-60PUZE8A |  | X2 |  |
| Outdoor side heat exchanger of air conditioner:  |  | air                         |  |                           |  |    |  |
| Indoor side heat exchanger of air conditioner:   |  | air                         |  |                           |  |    |  |
| Type: compressor driven vapour compression or sorption process   |  | vapour compression          |  |                           |  |    |  |
| if applicable: driver of compressor: [electric motor or fuel driven, gaseous or liquid fuel, internal or external combustion engine] |  | electric motor              |  |                           |  |    |  |

| Item  | Symbol   | Value    | Unit | Item  | Symbol       | Value | Unit                              |
|---|--|----------|------|---|--------------|-------|-----------------------------------|
| Rated cooling capacity  | $P_{rated,c}$  | 12.5     | kW   | Seasonal space cooling energy efficiency  | $\eta_{s,c}$ | 276.1 | %                                 |
| Refrigeration load  | $P_{design,c}$   | 12.5     | kW   | Declared energy efficiency ratio or gas utilization efficiency / auxiliary energy factor for part load at given outdoor temperatures T <sub>J</sub> |              |       |                                   |
| Declared cooling capacity for part load at given outdoor temperatures T <sub>J</sub> and indoor 27°/19°C (dry/wet bulb) |  |          |      | T <sub>J</sub> = + 35 °C  |              | 12.5  | kW                                |
|   |  |          |      | T <sub>J</sub> = + 30 °C  |              | 9.2   | kW                                |
|   |  |          |      | T <sub>J</sub> = + 25 °C  |              | 5.9   | kW                                |
|   |  |          |      | T <sub>J</sub> = + 20 °C  |              | 5.5   | kW                                |
| Degradation co- efficient for air conditioners**  | $C_{de}$   | 0.25     | -    |   |              |       |                                   |
| Power consumption in modes other than 'active mode'   |  |          |      |   |              |       |                                   |
| Off mode  | $P_{off}$  | 0.015    | kW   | Crankcase heater mode   | $P_{ck}$     | 0.000 | kW                                |
| Thermostat-off mode   | $P_{to}$   | 0.000    | kW   | Standby mode  | $P_{sb}$     | 0.015 | kW                                |
| Other items   |  |          |      |   |              |       |                                   |
| Capacity control  |  | variable |      | For air-to-air air conditioner: air flow rate, outdoor  |              | 7800  | m <sup>3</sup> /h                 |
| Sound power level, outdoor  | $L_{WA}$   | 70.0     | dB   |   |              |       |                                   |
| Sound power level, indoor   | $L_{WA}$   | 51.0     | dB   | if engine driven: Emissions of nitrogen oxides  | $NO_x^{***}$ | -     | mg/kWh fuel input GCV             |
|   |  |          |      | GWP of the refrigerant  |              | 2088  | kg CO <sub>2</sub> eq (100 years) |
| Contact details   | Panasonic Testing Centre, Panasonic Marketing Europe GmbH Winsberging 15, 22525 Hamburg, Germany |          |      |   |              |       |                                   |

\*\* If  $C_{de}$  is not determined by measurement then the default degradation coefficient air conditioners shall be 0.25.  
\*\*\* from 26 September 2018.

Where information relates to multi-split air conditioners, the test result and performance data may be obtained on the basis of the performance of the outdoor unit, with a combination of indoor unit(s) recommended by the manufacturer or importer.

## Information requirements for heat pumps

|  |  |                             |  |                           |  |    |  |
|--|--|-----------------------------|--|---------------------------|--|----|--|
| Model(s):  |  | Outdoor Unit<br>Indoor Unit |  | U-125PE1E8A<br>S-60PUZE8A |  | X2 |  |
| Outdoor side heat exchanger of heat pump:  |  | air                         |  |                           |  |    |  |
| Indoor side heat exchanger of heat pump:   |  | air                         |  |                           |  |    |  |
| Indication if the heater is equipped with a supplementary heater:  |  | no                          |  |                           |  |    |  |
| if applicable: driver of compressor: [electric motor or fuel driven, gaseous or liquid fuel, internal or external combustion engine] |  | electric motor              |  |                           |  |    |  |

Parameters shall be declared for the average heating season, parameters for the warmer and colder heating seasons are optional.

| Item   | Symbol   | Value    | Unit | Item   | Symbol  | Value | Unit                              |
|--|--|----------|------|--|---|-------|-----------------------------------|
| Rated heating capacity   | $P_{rated,h}$  | 14.0     | kW   | Seasonal space heating energy efficiency   | $\eta_{s,h}$  | 161.0 | %                                 |
| Refrigeration load   | $P_{design,h}$   | 12.5     | kW   | Declared coefficient of performance or gas utilization efficiency / auxiliary energy factor for part load at given outdoor temperatures T <sub>J</sub> |   |       |                                   |
| Declared heating capacity for part load at indoor temperature 20 °C and outdoor temperature T <sub>J</sub> |  |          |      | T <sub>J</sub> = - 7 °C  |   | 11.0  | kW                                |
|  |  |          |      | T <sub>J</sub> = + 2 °C  |   | 6.7   | kW                                |
|  |  |          |      | T <sub>J</sub> = + 7 °C  |   | 4.3   | kW                                |
|  |  |          |      | T <sub>J</sub> = + 12 °C   |   | 4.5   | kW                                |
| $T_{bw}$ = bivalent temperature  | $P_{bh}$   | 12.5     | kW   | $T_{bw}$ = bivalent temperature  | COP <sub>h</sub> or GUE <sub>h,bin</sub> / AEF <sub>h,bin</sub> | 2.3   | %                                 |
| $T_{ol}$ = operation limit   |  | 9.3      | kW   | $T_{ol}$ = operation limit   |   | 1.8   | %                                 |
| For air-to-water heat pumps: T <sub>J</sub> = - 15 °C (if T <sub>ol</sub> < - 20 °C)                       |  | -        | kW   | For water-to-air heat pumps: T <sub>J</sub> = - 15 °C (if T <sub>ol</sub> < - 20 °C)   |   | -     | %                                 |
| Bivalent temperature   | $T_{bv}$   | - 10     | °C   | For water-to-air heat pumps: Operation limit temperature   | $T_{ol}$  | - 20  | °C                                |
| Degradation co- efficient heat pumps**   | $C_{dh}$   | 0.25     | -    | Supplementary heater   |   |       |                                   |
| Power consumption in modes other than 'active mode'  |  |          |      | back-up heating capacity *   | elbu  | 0.0   | kW                                |
| Thermostat-off mode  | $P_{to}$   | 0.000    | kW   | Type of energy input   |   |       |                                   |
| Crankcase heater mode  | $P_{ck}$   | 0.000    | kW   | Standby mode   | $P_{sb}$  | 0.015 | kW                                |
| Other items  |  |          |      |  |   |       |                                   |
| Capacity control   |  | variable |      | For air-to-air heat pumps: air flow rate, outdoor  |   | 6600  | m <sup>3</sup> /h                 |
| Sound power level, outdoor   | $L_{WA}$   | 70.0     | dB   | For water-/brine-to-air heat pumps: Rated brine or water flow rate, outdoor side heat exchanger  |   | -     | m <sup>3</sup> /h                 |
| Sound power level, indoor  | $L_{WA}$   | 51.0     | dB   | Emissions of nitrogen oxides (if applicable)   | $NO_x^{***}$  | -     | mg/kWh fuel input GCV             |
|  |  |          |      | GWP of the refrigerant   |   | 2088  | kg CO <sub>2</sub> eq (100 years) |
| Contact details  | Panasonic Testing Centre, Panasonic Marketing Europe GmbH Winsberging 15, 22525 Hamburg, Germany |          |      |  |   |       |                                   |

\*\* If  $C_{dh}$  is not determined by measurement then the default degradation coefficient of heat pumps shall be 0.25.  
\*\*\* from 26 September 2018.

Where information relates to multi-split heat pumps, the test result and performance data may be obtained on the basis of the performance of the outdoor unit, with a combination of indoor unit(s) recommended by the manufacturer or importer.

Information requirements for air-to-air air conditioners

|  |  |                             |  |                           |  |    |  |
|--|--|-----------------------------|--|---------------------------|--|----|--|
| Model(s):  |  | Outdoor Unit<br>Indoor Unit |  | U-140PE1E8A<br>S-71PUZE5A |  | X2 |  |
| Outdoor side heat exchanger of air conditioner:  |  | air                         |  |                           |  |    |  |
| Indoor side heat exchanger of air conditioner:   |  | air                         |  |                           |  |    |  |
| Type: compressor driven vapour compression or sorption process   |  | vapour compression          |  |                           |  |    |  |
| if applicable: driver of compressor: [electric motor or fuel driven, gaseous or liquid fuel, internal or external combustion engine] |  | electric motor              |  |                           |  |    |  |

| Item  | Symbol  | Value    | Unit | Item   | Symbol                                     | Value | Unit                              |
|---|---|----------|------|--|--|-------|-----------------------------------|
| Rated cooling capacity  | $P_{rated,c}$   | 14.0     | kW   | Seasonal space cooling energy efficiency   | $\eta_{s,c}$                               | 259.7 | %                                 |
| Refrigeration load  | $P_{design,c}$  | 14.0     | kW   | Declared energy efficiency ratio or gas utilization efficiency / auxiliary energy factor for part load at given outdoor temperatures Tj    |  |       |                                   |
| Declared cooling capacity for part load at given outdoor temperatures Tj and indoor 27°/19°C (dry/wet bulb) |   |          |      | Declared coefficient of performance or gas utilization efficiency / auxiliary energy factor for part load at given outdoor temperatures Tj |  |       |                                   |
| Tj = + 35 °C  |   | 14.0     | kW   | Tj = + 35 °C   |  | 3.3   | %                                 |
| Tj = + 30 °C  |   | 10.3     | kW   | Tj = + 30 °C   | EER <sub>d</sub> or GUE <sub>c,bin</sub> / | 4.9   | %                                 |
| Tj = + 25 °C  |   | 6.6      | kW   | Tj = + 25 °C   | AEF <sub>c,bin</sub>                       | 7.7   | %                                 |
| Tj = + 20 °C  |   | 5.5      | kW   | Tj = + 20 °C   |  | 11.6  | %                                 |
| Degradation co-efficient for air conditioners**   | $C_{dc}$  | 0.25     | -    |  |  |       |                                   |
| Power consumption in modes other than 'active mode'   |   |          |      |  |  |       |                                   |
| Off mode  | $P_{off}$   | 0.015    | kW   | Crankcase heater mode  | $P_{ck}$                                   | 0.000 | kW                                |
| Thermostat-off mode   | $P_{to}$  | 0.000    | kW   | Standby mode   | $P_{sb}$                                   | 0.015 | kW                                |
| Other items   |   |          |      |  |  |       |                                   |
| Capacity control  |   | variable |      | For air-to-air air conditioner: air flow rate, outdoor   |  | 8100  | m³/h                              |
| Sound power level, outdoor  | $L_{WA}$  | 71.0     | dB   |  |  |       |                                   |
| Sound power level, indoor   | $L_{WA}$  | 52.0     | dB   | if engine driven: Emissions of nitrogen oxides   | $NO_x^{***}$                               | -     | mg/kWh fuel input GCV             |
|   |   |          |      | GWP of the refrigerant   |  | 2088  | kg CO <sub>2</sub> eq (100 years) |
| Contact details   | Panasonic Testing Centre, Panasonic Marketing Europe GmbH Winsbergring 15, 22525 Hamburg, Germany |          |      |  |  |       |                                   |

\*\* If  $C_{dc}$  is not determined by measurement then the default degradation coefficient air conditioners shall be 0.25.  
 \*\*\* from 26 September 2018.  
 Where information relates to multi-split air conditioners, the test result and performance data may be obtained on the basis of the performance of the outdoor unit, with a combination of indoor unit(s) recommended by the manufacturer or importer.

Information requirements for heat pumps

|  |  |                             |  |                           |  |    |  |
|--|--|-----------------------------|--|---------------------------|--|----|--|
| Model(s):  |  | Outdoor Unit<br>Indoor Unit |  | U-140PE1E8A<br>S-71PUZE5A |  | X2 |  |
| Outdoor side heat exchanger of heat pump:  |  | air                         |  |                           |  |    |  |
| Indoor side heat exchanger of heat pump:   |  | air                         |  |                           |  |    |  |
| Indication if the heater is equipped with a supplementary heater:  |  | no                          |  |                           |  |    |  |
| if applicable: driver of compressor: [electric motor or fuel driven, gaseous or liquid fuel, internal or external combustion engine] |  | electric motor              |  |                           |  |    |  |

Parameters shall be declared for the average heating season, parameters for the warmer and colder heating seasons are optional.

| Item   | Symbol  | Value    | Unit | Item   | Symbol  | Value | Unit                              |
|--|---|----------|------|--|---|-------|-----------------------------------|
| Rated heating capacity   | $P_{rated,h}$   | 16.0     | kW   | Seasonal space heating energy efficiency   | $\eta_{s,h}$  | 152.9 | %                                 |
| Refrigeration load   | $P_{design,h}$  | 14.0     | kW   | Declared heating capacity for part load at indoor temperature 20 °C and outdoor temperature Tj   |   |       |                                   |
| Declared heating capacity for part load at indoor temperature 20 °C and outdoor temperature Tj |   |          |      | Declared coefficient of performance or gas utilization efficiency / auxiliary energy factor for part load at given outdoor temperatures Tj |   |       |                                   |
| Tj = - 7 °C  |   | 12.3     | kW   | Tj = - 7 °C  |   | 2.4   | %                                 |
| Tj = + 2 °C  |   | 7.5      | kW   | Tj = + 2 °C  |   | 3.7   | %                                 |
| Tj = + 7 °C  |   | 4.8      | kW   | Tj = + 7 °C  |   | 5.5   | %                                 |
| Tj = + 12 °C   |   | 4.5      | kW   | Tj = + 12 °C   |   | 7.0   | %                                 |
| $T_{bw}$ = bivalent temperature  | $P_{bh}$  | 12.3     | kW   | $T_{bw}$ = bivalent temperature  | COP <sub>d</sub> or GUE <sub>h,bin</sub> / AEF <sub>h,bin</sub> | 2.4   | %                                 |
| $T_{ol}$ = operation limit   |   | 9.5      | kW   | $T_{ol}$ = operation limit   |   | 1.7   | %                                 |
| For air-to-water heat pumps: Tj = - 15 °C (if $T_{ol}$ < - 20 °C)                              |   | -        | kW   | For water-to-air heat pumps: Tj = - 15 °C (if $T_{ol}$ < - 20 °C)  |   | -     | %                                 |
| Bivalent temperature   | $T_{bv}$  | -7       | °C   | For water-to-air heat pumps: Operation limit temperature   | $T_{ol}$  | -20   | °C                                |
| Degradation co-efficient heat pumps**  | $C_{dh}$  | 0.25     | -    |  |   |       |                                   |
| Power consumption in modes other than 'active mode'  |   |          |      |  |   |       |                                   |
| Off mode   | $P_{off}$   | 0.015    | kW   | Supplementary heater back-up heating capacity*   | elbu  | 2.4   | kW                                |
| Thermostat-off mode  | $P_{to}$  | 0.000    | kW   | Type of energy input   |   |       |                                   |
| Crankcase heater mode  | $P_{ck}$  | 0.000    | kW   | Standby mode   | $P_{sb}$  | 0.015 | kW                                |
| Other items  |   |          |      |  |   |       |                                   |
| Capacity control   |   | variable |      | For air-to-air heat pumps: air flow rate, outdoor  |   | 7200  | m³/h                              |
| Sound power level, outdoor   | $L_{WA}$  | 71.0     | dB   | For water-/brine-to-air heat pumps: Rated brine or water flow rate, outdoor side heat exchanger  |   | -     | m³/h                              |
| Sound power level, indoor  | $L_{WA}$  | 52.0     | dB   | Emissions of nitrogen oxides (if applicable)   | $NO_x^{***}$  | -     | mg/kWh fuel input GCV             |
|  |   |          |      | GWP of the refrigerant   |   | 2088  | kg CO <sub>2</sub> eq (100 years) |
| Contact details  | Panasonic Testing Centre, Panasonic Marketing Europe GmbH Winsbergring 15, 22525 Hamburg, Germany |          |      |  |   |       |                                   |

\*\* If  $C_{dh}$  is not determined by measurement then the default degradation coefficient of heat pumps shall be 0.25.  
 \*\*\* from 26 September 2018.  
 Where information relates to multi-split heat pumps, the test result and performance data may be obtained on the basis of the performance of the outdoor unit, with a combination of indoor unit(s) recommended by the manufacturer or importer.

## Information requirements for air-to-air air conditioners

|  |  |                            |  |
|--|--|----------------------------|--|
| Model(s):  |  | U-125PE1E8A<br>S-125PU2E5A |  |
| Outdoor side heat exchanger of air conditioner:  |  | air                        |  |
| Indoor side heat exchanger of air conditioner:   |  | air                        |  |
| Type: compressor driven vapour compression or sorption process   |  | vapour compression         |  |
| if applicable: driver of compressor: [electric motor or fuel driven, gaseous or liquid fuel, internal or external combustion engine] |  | electric motor             |  |

| Item  | Symbol   | Value    | Unit | Item   | Symbol                                     | Value | Unit                              |
|---|--|----------|------|--|--|-------|-----------------------------------|
| Rated cooling capacity  | $P_{rated,c}$  | 12.5     | kW   | Seasonal space cooling energy efficiency   | $\eta_{s,c}$                               | 272.4 | %                                 |
| Refrigeration load  | $P_{design,c}$   | 12.5     | kW   | Declared energy efficiency ratio or gas utilization efficiency / auxiliary energy factor for part load at given outdoor temperatures T <sub>J</sub> and indoor 27°/19°C (dry/wet bulb) |  |       |                                   |
| Declared cooling capacity for part load at given outdoor temperatures T <sub>J</sub> and indoor 27°/19°C (dry/wet bulb) |  |          |      | Declared energy efficiency ratio or gas utilization efficiency / auxiliary energy factor for part load at given outdoor temperatures T <sub>J</sub>                                    |  |       |                                   |
| T <sub>J</sub> = + 35 °C  |  | 12.5     | kW   | T <sub>J</sub> = + 35 °C   |  | 3.7   | %                                 |
| T <sub>J</sub> = + 30 °C  |  | 9.2      | kW   | T <sub>J</sub> = + 30 °C   | EER <sub>d</sub> or GUE <sub>d,bin</sub> / | 5.4   | %                                 |
| T <sub>J</sub> = + 25 °C  |  | 5.9      | kW   | T <sub>J</sub> = + 25 °C   | AEF <sub>c,bin</sub>                       | 8.2   | %                                 |
| T <sub>J</sub> = + 20 °C  |  | 5.2      | kW   | T <sub>J</sub> = + 20 °C   |  | 11.6  | %                                 |
| Degradation co- efficient for air conditioners**  | $C_{de}$   | 0.25     | -    |  |  |       |                                   |
| Power consumption in modes other than 'active mode'   |  |          |      |  |  |       |                                   |
| Off mode  | $P_{off}$  | 0.020    | kW   | Crankcase heater mode  | $P_{ck}$                                   | 0.000 | kW                                |
| Thermostat-off mode   | $P_{to}$   | 0.014    | kW   | Standby mode   | $P_{sb}$                                   | 0.020 | kW                                |
| Other items   |  |          |      |  |  |       |                                   |
| Capacity control  |  | variable |      | For air-to-air air conditioner: air flow rate, outdoor   |  | 7800  | m <sup>3</sup> /h                 |
| Sound power level, outdoor  | $L_{WA}$   | 70.0     | dB   |  |  |       |                                   |
| Sound power level, indoor   | $L_{WA}$   | 61.0     | dB   | if engine driven: Emissions of nitrogen oxides   | NO <sub>x</sub> ***                        | -     | mg/kWh fuel input GCV             |
|   |  |          |      | GWP of the refrigerant   |  | 2088  | kg CO <sub>2</sub> eq (100 years) |
| Contact details   | Panasonic Testing Centre, Panasonic Marketing Europe GmbH Winsbergiring 15, 22525 Hamburg, Germany |          |      |  |  |       |                                   |

\*\* If  $C_{de}$  is not determined by measurement then the default degradation coefficient air conditioners shall be 0.25.  
 \*\*\* from 26 September 2018.  
 Where information relates to multi-split air conditioners, the test result and performance data may be obtained on the basis of the performance of the outdoor unit, with a combination of indoor unit(s) recommended by the manufacturer or importer.

## Information requirements for heat pumps

|  |  |                            |  |
|--|--|----------------------------|--|
| Model(s):  |  | U-125PE1E8A<br>S-125PU2E5A |  |
| Outdoor side heat exchanger of heat pump:  |  | air                        |  |
| Indoor side heat exchanger of heat pump:   |  | air                        |  |
| Indication if the heater is equipped with a supplementary heater: if applicable: driver of compressor: [electric motor or fuel driven, gaseous or liquid fuel, internal or external combustion engine] |  | no                         |  |
| Parameters shall be declared for the average heating season, parameters for the warmer and colder heating seasons are optional.  |  | electric motor             |  |

| Item   | Symbol   | Value    | Unit | Item   | Symbol  | Value | Unit                              |
|--|--|----------|------|--|---|-------|-----------------------------------|
| Rated heating capacity   | $P_{rated,h}$  | 14.0     | kW   | Seasonal space heating energy efficiency   | $\eta_{h,h}$  | 160.9 | %                                 |
| Refrigeration load   | $P_{design,h}$   | 12.5     | kW   | Declared coefficient of performance or gas utilization efficiency / auxiliary energy factor for part load at given outdoor temperatures T <sub>J</sub> |   |       |                                   |
| Declared heating capacity for part load at indoor temperature 20 °C and outdoor temperature T <sub>J</sub> |  |          |      | Declared coefficient of performance or gas utilization efficiency / auxiliary energy factor for part load at given outdoor temperatures T <sub>J</sub> |   |       |                                   |
| T <sub>J</sub> = - 7 °C  |  | 11.0     | kW   | T <sub>J</sub> = - 7 °C  |   | 2.5   | %                                 |
| T <sub>J</sub> = + 2 °C  |  | 6.7      | kW   | T <sub>J</sub> = + 2 °C  |   | 3.9   | %                                 |
| T <sub>J</sub> = + 7 °C  |  | 4.3      | kW   | T <sub>J</sub> = + 7 °C  |   | 5.8   | %                                 |
| T <sub>J</sub> = + 12 °C   |  | 4.5      | kW   | T <sub>J</sub> = + 12 °C   |   | 7.0   | %                                 |
| T <sub>bw</sub> = bivalent temperature   | $P_{bh}$   | 12.5     | kW   | T <sub>bw</sub> = bivalent temperature   | COP <sub>d</sub> or GUE <sub>d,bin</sub> / AEF <sub>d,bin</sub> | 2.3   | %                                 |
| T <sub>col</sub> = operation limit   |  | 9.8      | kW   | T <sub>col</sub> = operation limit   |   | 1.8   | %                                 |
| For air-to-water heat pumps: T <sub>J</sub> = - 15 °C (if T <sub>col</sub> < - 20 °C)                      |  | -        | kW   | For water-to-air heat pumps: T <sub>J</sub> = - 15 °C (if T <sub>col</sub> < - 20 °C)  |   | -     | %                                 |
| Bivalent temperature   | $T_{bw}$   | -10      | °C   | For water-to-air heat pumps: Operation limit temperature   | $T_{ol}$  | -20   | °C                                |
| Degradation co- efficient heat pumps**   | $C_{dh}$   | 0.25     | -    |  |   |       |                                   |
| Power consumption in modes other than 'active mode'  |  |          |      |  |   |       |                                   |
| Off mode   | $P_{off}$  | 0.020    | kW   | Supplementary heater back-up heating capacity *  | eibu  | 0.0   | kW                                |
| Thermostat-off mode  | $P_{to}$   | 0.014    | kW   | Type of energy input   |   |       |                                   |
| Crankcase heater mode  | $P_{ck}$   | 0.000    | kW   | Standby mode   | $P_{sb}$  | 0.020 | kW                                |
| Other items  |  |          |      |  |   |       |                                   |
| Capacity control   |  | variable |      | For air-to-air heat pumps: air flow rate, outdoor  |   | 6600  | m <sup>3</sup> /h                 |
| Sound power level, outdoor   | $L_{WA}$   | 70.0     | dB   | For water-/brine-to-air heat pumps: Rated brine or water flow rate, outdoor side heat exchanger  |   | -     | m <sup>3</sup> /h                 |
| Sound power level, indoor  | $L_{WA}$   | 61.0     | dB   | Emissions of nitrogen oxides (if applicable)   | NO <sub>x</sub> ***   | -     | mg/kWh fuel input GCV             |
|  |  |          |      | GWP of the refrigerant   |   | 2088  | kg CO <sub>2</sub> eq (100 years) |
| Contact details  | Panasonic Testing Centre, Panasonic Marketing Europe GmbH Winsbergiring 15, 22525 Hamburg, Germany |          |      |  |   |       |                                   |

\*\* If  $C_{dh}$  is not determined by measurement then the default degradation coefficient of heat pumps shall be 0.25.  
 \*\*\* from 26 September 2018.  
 Where information relates to multi-split heat pumps, the test result and performance data may be obtained on the basis of the performance of the outdoor unit, with a combination of indoor unit(s) recommended by the manufacturer or importer.

### Information requirements for air-to-air air conditioners

Model(s): Outdoor Unit U-140PETE8A  
Indoor Unit S-140PUZE5A

Outdoor side heat exchanger of air conditioner: air  
Indoor side heat exchanger of air conditioner: air  
Type: compressor driven vapour compression or sorption process vapour compression  
if applicable: driver of compressor: [electric motor or fuel driven, electric motor]  
gaseous or liquid fuel, internal or external combustion engine]

| Item  | Symbol  | Value    | Unit | Item   | Symbol                                     | Value | Unit                              |
|---|---|----------|------|--|--|-------|-----------------------------------|
| Rated cooling capacity  | P <sub>rated,c</sub>  | 14.0     | kW   | Seasonal space cooling energy efficiency   | η <sub>s,c</sub>                           | 256.9 | %                                 |
| Refrigeration load  | P <sub>design,c</sub>   | 14.0     | kW   |  |  |       |                                   |
| Declared cooling capacity for part load at given outdoor temperatures T <sub>J</sub> and indoor 27°/19°C (dry/wet bulb)                             |   |          |      |  |  |       |                                   |
|   |   | 14.0     | kW   | T <sub>J</sub> = + 35 °C   |  | 3.3   | %                                 |
|   |   | 10.3     | kW   | T <sub>J</sub> = + 30 °C   | EER <sub>d</sub> or GUE <sub>c,dbn</sub> / | 4.9   | %                                 |
|   | P <sub>dc</sub>   | 6.6      | kW   | T <sub>J</sub> = + 25 °C   | AEF <sub>c,dbn</sub>                       | 7.7   | %                                 |
|   |   | 5.2      | kW   | T <sub>J</sub> = + 20 °C   |  | 11.6  | %                                 |
| Degradation co- efficient for air conditioners**  | C <sub>de</sub>   | 0.25     | -    |  |  |       |                                   |
| Declared energy efficiency ratio or gas utilization efficiency / auxiliary energy factor for part load at given outdoor temperatures T <sub>J</sub> |   |          |      |  |  |       |                                   |
|   |   |          |      | T <sub>J</sub> = - 7 °C  |  |       |                                   |
|   |   |          |      | T <sub>J</sub> = + 2 °C  |  |       |                                   |
|   |   |          |      | T <sub>J</sub> = + 7 °C  |  |       |                                   |
|   |   |          |      | T <sub>J</sub> = + 12 °C   |  |       |                                   |
|   |   |          |      | T <sub>bw</sub> = bivalent temperature   |  |       |                                   |
|   |   |          |      | T <sub>ol</sub> = operation limit  |  |       |                                   |
|   |   |          |      | For air-to-water heat pumps: T <sub>J</sub> = - 15 °C (if T <sub>ol</sub> < - 20 °C) |  |       |                                   |
|   |   |          |      | Bivalent temperature   |  |       |                                   |
|   |   |          |      | Degradation co- efficient heat pumps**   |  |       |                                   |
| Power consumption in modes other than 'active mode'   |   |          |      |  |  |       |                                   |
| Off mode  | P <sub>off</sub>  | 0.020    | kW   | Crankcase heater mode  | P <sub>ck</sub>                            | 0.000 | kW                                |
| Thermostat-off mode   | P <sub>to</sub>   | 0.014    | kW   | Standby mode   | P <sub>sb</sub>                            | 0.020 | kW                                |
| Other items   |   |          |      |  |  |       |                                   |
| Capacity control  |   | variable |      | For air-to-air air conditioner: air flow rate, outdoor                               |  | 8100  | m <sup>3</sup> /h                 |
| Sound power level, outdoor  | L <sub>WA</sub>   | 71.0     | dB   |  |  |       |                                   |
| Sound power level, indoor   | L <sub>WA</sub>   | 62.0     | dB   | if engine driven: Emissions of nitrogen oxides                                       | NO <sub>x</sub> ***                        | -     | mg/kWh fuel input GCV             |
|   |   |          |      | GWP of the refrigerant   |  | 2088  | kg CO <sub>2</sub> eq (100 years) |
| Contact details   | Panasonic Testing Centre, Panasonic Marketing Europe GmbH Winsbergring 15, 22525 Hamburg, Germany |          |      |  |  |       |                                   |

\*\* If C<sub>de</sub> is not determined by measurement then the default degradation coefficient air conditioners shall be 0.25.  
\*\*\* from 26 September 2018.  
Where information relates to multi-split air conditioners, the test result and performance data may be obtained on the basis of the performance of the outdoor unit, with a combination of indoor unit(s) recommended by the manufacturer or importer.

### Information requirements for heat pumps

Model(s): Outdoor Unit U-140PE1E8A  
Indoor Unit S-140PUZE5A

Outdoor side heat exchanger of heat pump: air  
Indoor side heat exchanger of heat pump: air  
Indication if the heater is equipped with a supplementary heater: no  
if applicable: driver of compressor: [electric motor or fuel driven, electric motor]  
gaseous or liquid fuel, internal or external combustion engine]

Parameters shall be declared for the average heating season, parameters for the warmer and colder heating seasons are optional.

| Item   | Symbol  | Value    | Unit | Item  | Symbol              | Value | Unit                              |
|--|---|----------|------|---|---------------------|-------|-----------------------------------|
| Rated heating capacity   | P <sub>rated,h</sub>  | 16.0     | kW   | Seasonal space heating energy efficiency  | η <sub>s,h</sub>    | 152.9 | %                                 |
| Refrigeration load   | P <sub>design,h</sub>   | 14.0     | kW   |   |                     |       |                                   |
| Declared heating capacity for part load at indoor temperature 20 °C and outdoor temperature T <sub>J</sub> |   |          |      |   |                     |       |                                   |
|  |   |          |      | T <sub>J</sub> = - 7 °C   |                     |       |                                   |
|  |   |          |      | T <sub>J</sub> = + 2 °C   |                     |       |                                   |
|  |   |          |      | T <sub>J</sub> = + 7 °C   |                     |       |                                   |
|  |   |          |      | T <sub>J</sub> = + 12 °C  |                     |       |                                   |
|  |   |          |      | T <sub>bw</sub> = bivalent temperature  |                     |       |                                   |
|  |   |          |      | T <sub>ol</sub> = operation limit   |                     |       |                                   |
|  |   |          |      | For water-to-air heat pumps: T <sub>J</sub> = - 15 °C (if T <sub>ol</sub> < - 20 °C)            |                     |       |                                   |
|  |   |          |      | Bivalent temperature  |                     |       |                                   |
|  |   |          |      | Degradation co- efficient heat pumps**  |                     |       |                                   |
| Power consumption in modes other than 'active mode'  |   |          |      |   |                     |       |                                   |
| Off mode   | P <sub>off</sub>  | 0.020    | kW   | Supplementary heater back-up heating capacity *   | eibu                | 2.3   | kW                                |
| Thermostat-off mode  | P <sub>to</sub>   | 0.014    | kW   | Type of energy input  |                     |       |                                   |
| Crankcase heater mode  | P <sub>ck</sub>   | 0.000    | kW   | Standby mode  | P <sub>sb</sub>     | 0.020 | kW                                |
| Other items  |   |          |      |   |                     |       |                                   |
| Capacity control   |   | variable |      | For air-to-air heat pumps: air flow rate, outdoor   |                     | 7200  | m <sup>3</sup> /h                 |
| Sound power level, outdoor   | L <sub>WA</sub>   | 71.0     | dB   | For water-/brine-to-air heat pumps: Rated brine or water flow rate, outdoor side heat exchanger |                     | -     | m <sup>3</sup> /h                 |
| Sound power level, indoor  | L <sub>WA</sub>   | 62.0     | dB   | Emissions of nitrogen oxides (if applicable)  | NO <sub>x</sub> *** | -     | mg/kWh fuel input GCV             |
|  |   |          |      | GWP of the refrigerant  |                     | 2088  | kg CO <sub>2</sub> eq (100 years) |
| Contact details  | Panasonic Testing Centre, Panasonic Marketing Europe GmbH Winsbergring 15, 22525 Hamburg, Germany |          |      |   |                     |       |                                   |

\*\* If C<sub>de</sub> is not determined by measurement then the default degradation coefficient of heat pumps shall be 0.25.  
\*\*\* from 26 September 2018.  
Where information relates to multi-split heat pumps, the test result and performance data may be obtained on the basis of the performance of the outdoor unit, with a combination of indoor unit(s) recommended by the manufacturer or importer.



## Information requirements for air-to-air air conditioners

|  |  |                           |  |                    |  |
|--|--|---------------------------|--|--------------------|--|
| Model(s):  |  | U-125PE1E5A<br>S-36PT2E5A |  | X4                 |  |
| Outdoor side heat exchanger of air conditioner:  |  | Indoor Unit               |  | air                |  |
| Indoor side heat exchanger of air conditioner:   |  | Indoor Unit               |  | air                |  |
| Type: compressor driven vapour compression or sorption process   |  |                           |  | vapour compression |  |
| if applicable: driver of compressor: [electric motor or fuel driven, gaseous or liquid fuel, internal or external combustion engine] |  |                           |  | electric motor     |  |

|  |  |                           |  |                |  |
|--|--|---------------------------|--|----------------|--|
| Model(s):  |  | U-125PE1E5A<br>S-36PT2E5A |  | X4             |  |
| Outdoor side heat exchanger of heat pump:  |  | Indoor Unit               |  | air            |  |
| Indoor side heat exchanger of heat pump:   |  | Indoor Unit               |  | air            |  |
| Indication if the heater is equipped with a supplementary heater:  |  |                           |  | no             |  |
| if applicable: driver of compressor: [electric motor or fuel driven, gaseous or liquid fuel, internal or external combustion engine] |  |                           |  | electric motor |  |

Parameters shall be declared for the average heating season, parameters for the warmer and colder heating seasons are optional.

| Item  | Symbol  | Value     | Unit  | Item   | Symbol  | Value    | Unit                              |
|---|---|-----------|-------|--|---|----------|-----------------------------------|
| Rated cooling capacity  | $P_{rated,c}$   | 12.5      | kW    | Seasonal space cooling energy efficiency   | $\eta_{s,c}$  | 241.1    | %                                 |
| Refrigeration load  | $P_{design,c}$  | 12.5      | kW    | Declared energy efficiency ratio or gas utilization efficiency / auxiliary energy factor for part load at given outdoor temperatures T <sub>J</sub>    |   |          |                                   |
| Declared cooling capacity for part load at given outdoor temperatures T <sub>J</sub> and indoor 27°/19°C (dry/wet bulb) | T <sub>J</sub> = +35 °C   | 12.5      | kW    | T <sub>J</sub> = +35 °C  |   | 3.3      | %                                 |
|   | T <sub>J</sub> = +30 °C   | 9.2       | kW    | T <sub>J</sub> = +30 °C  | EER <sub>d</sub> or GUE <sub>d,bin</sub> /                      | 4.4      | %                                 |
|   | T <sub>J</sub> = +25 °C   | 5.9       | kW    | T <sub>J</sub> = +25 °C  | AEF <sub>c,bin</sub>  | 7.3      | %                                 |
|   | T <sub>J</sub> = +20 °C   | 5.1       | kW    | T <sub>J</sub> = +20 °C  |   | 10.3     | %                                 |
| Degradation co- efficient for air conditioners**  | $C_{dc}$  | 0.25      | -     | Declared heating capacity for part load at indoor temperature 20 °C and outdoor temperature T <sub>J</sub>   |   |          |                                   |
| Declared heating capacity for part load at indoor temperature 20 °C and outdoor temperature T <sub>J</sub>              | T <sub>J</sub> = -7 °C  | 11.0      | kW    | T <sub>J</sub> = -7 °C   |   | 2.4      | %                                 |
|   | T <sub>J</sub> = +2 °C  | 6.7       | kW    | T <sub>J</sub> = +2 °C   |   | 3.6      | %                                 |
|   | T <sub>J</sub> = +7 °C  | 4.3       | kW    | T <sub>J</sub> = +7 °C   |   | 5.4      | %                                 |
|   | T <sub>J</sub> = +12 °C   | 4.5       | kW    | T <sub>J</sub> = +12 °C  | COP <sub>d</sub> or GUE <sub>d,bin</sub> / AEF <sub>d,bin</sub> | 6.6      | %                                 |
| T <sub>bw</sub> = bivalent temperature  | $P_{bh}$  | 12.5      | kW    | T <sub>bw</sub> = bivalent temperature   |   | 2.2      | %                                 |
| T <sub>ol</sub> = operation limit   |   | 9.3       | kW    | T <sub>ol</sub> = operation limit  |   | 1.8      | %                                 |
| For air-to-water heat pumps: T <sub>J</sub> = -15 °C (if T <sub>ol</sub> < -20 °C)                                      |   | -         | kW    | For water-to-air heat pumps: T <sub>J</sub> = -15 °C (if T <sub>ol</sub> < -20 °C)   |   | -        | %                                 |
| Bivalent temperature  | T <sub>bw</sub>   | -10       | °C    | For water-to-air heat pumps: Operation limit temperature   | T <sub>ol</sub>   | -20      | °C                                |
| Degradation co- efficient heat pumps**  | $C_{dh}$  | 0.25      | -     | Declared coefficient of performance or gas utilization efficiency / auxiliary energy factor for part load at given outdoor temperatures T <sub>J</sub> |   |          |                                   |
| Power consumption in modes other than 'active mode'   | Off mode  | $P_{off}$ | 0.012 | kW   | Supplementary heater  |          |                                   |
|   | Thermostat-off mode   | $P_{to}$  | 0.000 | kW   | back-up heating capacity*                                       | eibu     | 0.0                               |
|   | Crankcase heater mode   | $P_{ck}$  | 0.000 | kW   | Type of energy input  |          |                                   |
|   |   |           |       |  | Standby mode  | $P_{ss}$ | 0.012                             |
| Other items   |   |           |       |  |   |          |                                   |
| Capacity control  |   | variable  |       | For air-to-air heat pumps: air flow rate, outdoor  |   | 6600     | m <sup>3</sup> /h                 |
| Sound power level, outdoor  | $L_{WA}$  | 70.0      | dB    | For water-/brine-to-air heat pumps: Rated brine or water flow rate, outdoor side heat exchanger  |   | -        | m <sup>3</sup> /h                 |
| Sound power level, indoor   | $L_{WA}$  | 54.0      | dB    | Emissions of nitrogen oxides (if applicable)   | NO <sub>x</sub> ***   | -        | mg/kWh fuel input GCV             |
|   |   |           |       | GWP of the refrigerant   |   | 2088     | kg CO <sub>2</sub> eq (100 years) |
| Contact details   | Panasonic Testing Centre, Panasonic Marketing Europe GmbH Winsbergring 15, 22525 Hamburg, Germany |           |       |  |   |          |                                   |

\*\* If  $C_{dc}$  is not determined by measurement then the default degradation coefficient air conditioners shall be 0.25. \*\*\* from 26 September 2018.

Where information relates to multi-split air conditioners, the test result and performance data may be obtained on the basis of the performance of the outdoor unit, with a combination of indoor unit(s) recommended by the manufacturer or importer.

## Information requirements for heat pumps

|  |  |                           |  |                |  |
|--|--|---------------------------|--|----------------|--|
| Model(s):  |  | U-125PE1E5A<br>S-36PT2E5A |  | X4             |  |
| Outdoor side heat exchanger of heat pump:  |  | Indoor Unit               |  | air            |  |
| Indoor side heat exchanger of heat pump:   |  | Indoor Unit               |  | air            |  |
| Indication if the heater is equipped with a supplementary heater:  |  |                           |  | no             |  |
| if applicable: driver of compressor: [electric motor or fuel driven, gaseous or liquid fuel, internal or external combustion engine] |  |                           |  | electric motor |  |

Parameters shall be declared for the average heating season, parameters for the warmer and colder heating seasons are optional.

| Item   | Symbol  | Value     | Unit  | Item   | Symbol  | Value    | Unit                              |
|--|---|-----------|-------|--|---|----------|-----------------------------------|
| Rated heating capacity   | $P_{rated,h}$   | 14.0      | kW    | Seasonal space heating energy efficiency   | $\eta_{s,h}$  | 150.1    | %                                 |
| Refrigeration load   | $P_{design,h}$  | 12.5      | kW    | Declared coefficient of performance or gas utilization efficiency / auxiliary energy factor for part load at given outdoor temperatures T <sub>J</sub> |   |          |                                   |
| Declared heating capacity for part load at indoor temperature 20 °C and outdoor temperature T <sub>J</sub> | T <sub>J</sub> = -7 °C  | 11.0      | kW    | T <sub>J</sub> = -7 °C   |   | 2.4      | %                                 |
|  | T <sub>J</sub> = +2 °C  | 6.7       | kW    | T <sub>J</sub> = +2 °C   |   | 3.6      | %                                 |
|  | T <sub>J</sub> = +7 °C  | 4.3       | kW    | T <sub>J</sub> = +7 °C   |   | 5.4      | %                                 |
|  | T <sub>J</sub> = +12 °C   | 4.5       | kW    | T <sub>J</sub> = +12 °C  | COP <sub>d</sub> or GUE <sub>d,bin</sub> / AEF <sub>d,bin</sub> | 6.6      | %                                 |
| T <sub>bw</sub> = bivalent temperature   | $P_{bh}$  | 12.5      | kW    | T <sub>bw</sub> = bivalent temperature   |   | 2.2      | %                                 |
| T <sub>ol</sub> = operation limit  |   | 9.3       | kW    | T <sub>ol</sub> = operation limit  |   | 1.8      | %                                 |
| For air-to-water heat pumps: T <sub>J</sub> = -15 °C (if T <sub>ol</sub> < -20 °C)                         |   | -         | kW    | For water-to-air heat pumps: T <sub>J</sub> = -15 °C (if T <sub>ol</sub> < -20 °C)   |   | -        | %                                 |
| Bivalent temperature   | T <sub>bw</sub>   | -10       | °C    | For water-to-air heat pumps: Operation limit temperature   | T <sub>ol</sub>   | -20      | °C                                |
| Degradation co- efficient heat pumps**   | $C_{dh}$  | 0.25      | -     | Declared coefficient of performance or gas utilization efficiency / auxiliary energy factor for part load at given outdoor temperatures T <sub>J</sub> |   |          |                                   |
| Power consumption in modes other than 'active mode'  | Off mode  | $P_{off}$ | 0.012 | kW   | Supplementary heater  |          |                                   |
|  | Thermostat-off mode   | $P_{to}$  | 0.000 | kW   | back-up heating capacity*                                       | eibu     | 0.0                               |
|  | Crankcase heater mode   | $P_{ck}$  | 0.000 | kW   | Type of energy input  |          |                                   |
|  |   |           |       |  | Standby mode  | $P_{ss}$ | 0.012                             |
| Other items  |   |           |       |  |   |          |                                   |
| Capacity control   |   | variable  |       | For air-to-air heat pumps: air flow rate, outdoor  |   | 6600     | m <sup>3</sup> /h                 |
| Sound power level, outdoor   | $L_{WA}$  | 70.0      | dB    | For water-/brine-to-air heat pumps: Rated brine or water flow rate, outdoor side heat exchanger  |   | -        | m <sup>3</sup> /h                 |
| Sound power level, indoor  | $L_{WA}$  | 54.0      | dB    | Emissions of nitrogen oxides (if applicable)   | NO <sub>x</sub> ***   | -        | mg/kWh fuel input GCV             |
|  |   |           |       | GWP of the refrigerant   |   | 2088     | kg CO <sub>2</sub> eq (100 years) |
| Contact details  | Panasonic Testing Centre, Panasonic Marketing Europe GmbH Winsbergring 15, 22525 Hamburg, Germany |           |       |  |   |          |                                   |

\*\* If  $C_{dh}$  is not determined by measurement then the default degradation coefficient of heat pumps shall be 0.25. \*\*\* from 26 September 2018.

Where information relates to multi-split heat pumps, the test result and performance data may be obtained on the basis of the performance of the outdoor unit, with a combination of indoor unit(s) recommended by the manufacturer or importer.

### Information requirements for air-to-air air conditioners

|  |  |                             |  |                           |  |    |  |
|--|--|-----------------------------|--|---------------------------|--|----|--|
| Model(s):  |  | Outdoor Unit<br>Indoor Unit |  | U-125PE1E5A<br>S-45PT2E5A |  | X3 |  |
| Outdoor side heat exchanger of air conditioner:  |  | air                         |  |                           |  |    |  |
| Indoor side heat exchanger of air conditioner:   |  | air                         |  |                           |  |    |  |
| Type: compressor driven vapour compression or sorption process   |  | vapour compression          |  |                           |  |    |  |
| if applicable: driver of compressor: [electric motor or fuel driven, gaseous or liquid fuel, internal or external combustion engine] |  | electric motor              |  |                           |  |    |  |

| Item  | Symbol   | Value    | Unit | Item  | Symbol                                     | Value | Unit                              |
|---|--|----------|------|---|--|-------|-----------------------------------|
| Rated cooling capacity  | $P_{rated,c}$  | 12.5     | kW   | Seasonal space cooling energy efficiency  | $\eta_{s,c}$                               | 241.1 | %                                 |
| Refrigeration load  | $P_{design,c}$   | 12.5     | kW   | Declared energy efficiency ratio or gas utilization efficiency / auxiliary energy factor for part load at given outdoor temperatures Tj |  |       |                                   |
| Declared cooling capacity for part load at given outdoor temperatures Tj and indoor 27°/19°C (dry/wet bulb) |  |          |      |   |  |       |                                   |
| Tj = + 35 °C  |  | 12.5     | kW   | Tj = + 35 °C  |  | 3.3   | %                                 |
| Tj = + 30 °C  |  | 9.2      | kW   | Tj = + 30 °C  | EER <sub>d</sub> or GUE <sub>c,bln</sub> / | 4.4   | %                                 |
| Tj = + 25 °C  |  | 5.9      | kW   | Tj = + 25 °C  | AEF <sub>c,bln</sub>                       | 7.3   | %                                 |
| Tj = + 20 °C  |  | 5.1      | kW   | Tj = + 20 °C  |  | 10.3  | %                                 |
| Degradation co- efficient for air conditioners**  | $C_{de}$   | 0.25     | -    |   |  |       |                                   |
| Power consumption in modes other than 'active mode'   |  |          |      |   |  |       |                                   |
| Off mode  | $P_{off}$  | 0.012    | kW   | Crankcase heater mode   | $P_{ck}$                                   | 0.000 | kW                                |
| Thermostat-off mode   | $P_{to}$   | 0.000    | kW   | Standby mode  | $P_{sb}$                                   | 0.012 | kW                                |
| Other items   |  |          |      |   |  |       |                                   |
| Capacity control  |  | variable |      | For air-to-air air conditioner: air flow rate, outdoor  |  | 7800  | m³/h                              |
| Sound power level, outdoor  | $L_{WA}$   | 70.0     | dB   |   |  |       |                                   |
| Sound power level, indoor   | $L_{WA}$   | 55.0     | dB   | if engine driven: Emissions of nitrogen oxides  | $NO_x^{***}$                               | -     | mg/kWh fuel input GCV             |
|   |  |          |      | GWP of the refrigerant  |  | 2088  | kg CO <sub>2</sub> eq (100 years) |
| Contact details   | Panasonic Testing Centre, Panasonic Marketing Europe GmbH Winsbergiring 15, 22525 Hamburg, Germany |          |      |   |  |       |                                   |

\*\* If  $C_{de}$  is not determined by measurement then the default degradation coefficient air conditioners shall be 0.25.  
\*\*\* from 26 September 2018.

Where information relates to multi-split air conditioners, the test result and performance data may be obtained on the basis of the performance of the outdoor unit, with a combination of indoor unit(s) recommended by the manufacturer or importer.

### Information requirements for heat pumps

|  |  |                             |  |                           |  |    |  |
|--|--|-----------------------------|--|---------------------------|--|----|--|
| Model(s):  |  | Outdoor Unit<br>Indoor Unit |  | U-125PE1E5A<br>S-45PT2E5A |  | X3 |  |
| Outdoor side heat exchanger of heat pump:  |  | air                         |  |                           |  |    |  |
| Indoor side heat exchanger of heat pump:   |  | air                         |  |                           |  |    |  |
| Indication if the heater is equipped with a supplementary heater:  |  | no                          |  |                           |  |    |  |
| if applicable: driver of compressor: [electric motor or fuel driven, gaseous or liquid fuel, internal or external combustion engine] |  | electric motor              |  |                           |  |    |  |

Parameters shall be declared for the average heating season, parameters for the warmer and colder heating seasons are optional.

| Item   | Symbol   | Value    | Unit | Item   | Symbol  | Value | Unit                              |
|--|--|----------|------|--|---|-------|-----------------------------------|
| Rated heating capacity   | $P_{rated,h}$  | 14.0     | kW   | Seasonal space heating energy efficiency   | $\eta_{s,h}$  | 150.1 | %                                 |
| Refrigeration load   | $P_{design,h}$   | 12.5     | kW   | Declared coefficient of performance or gas utilization efficiency / auxiliary energy factor for part load at given outdoor temperatures Tj |   |       |                                   |
| Declared heating capacity for part load at indoor temperature 20 °C and outdoor temperature Tj |  |          |      |  |   |       |                                   |
| Tj = - 7 °C  |  | 11.0     | kW   | Tj = - 7 °C  |   | 2.4   | %                                 |
| Tj = + 2 °C  |  | 6.7      | kW   | Tj = + 2 °C  |   | 3.6   | %                                 |
| Tj = + 7 °C  |  | 4.3      | kW   | Tj = + 7 °C  |   | 5.4   | %                                 |
| Tj = + 12 °C   |  | 4.5      | kW   | Tj = + 12 °C   |   | 6.6   | %                                 |
| $T_{biv}$ = bivalent temperature   | $P_{bh}$   | 12.5     | kW   | $T_{biv}$ = bivalent temperature   | COP <sub>d</sub> or GUE <sub>h,bln</sub> / AEF <sub>h,bln</sub> | 2.2   | %                                 |
| $T_{ol}$ = operation limit   |  | 9.3      | kW   | $T_{ol}$ = operation limit   |   | 1.8   | %                                 |
| For air-to-water heat pumps: Tj = - 15 °C (if $T_{ol}$ < - 20 °C)                              |  | -        | kW   | For water-to-air heat pumps: Tj = - 15 °C (if $T_{ol}$ < - 20 °C)  |   | -     | %                                 |
| Bivalent temperature   | $T_{biv}$  | - 10     | °C   | For water-to-air heat pumps: Operation limit temperature   | $T_{ol}$  | -20   | °C                                |
| Degradation co- efficient heat pumps**   | $C_{dh}$   | 0.25     | -    |  |   |       |                                   |
| Power consumption in modes other than 'active mode'  |  |          |      |  |   |       |                                   |
| Off mode   | $P_{off}$  | 0.012    | kW   | Supplementary heater back-up heating capacity*   | eibu  | 0.0   | kW                                |
| Thermostat-off mode  | $P_{to}$   | 0.000    | kW   | Type of energy input   |   |       |                                   |
| Crankcase heater mode  | $P_{ck}$   | 0.000    | kW   | Standby mode   | $P_{sb}$  | 0.012 | kW                                |
| Other items  |  |          |      |  |   |       |                                   |
| Capacity control   |  | variable |      | For air-to-air heat pumps: air flow rate, outdoor  |   | 6600  | m³/h                              |
| Sound power level, outdoor   | $L_{WA}$   | 70.0     | dB   | For water-/brine-to-air heat pumps: Rated brine or water flow rate, outdoor side heat exchanger  |   | -     | m³/h                              |
| Sound power level, indoor  | $L_{WA}$   | 55.0     | dB   | Emissions of nitrogen oxides (if applicable)   | $NO_x^{***}$  | -     | mg/kWh fuel input GCV             |
|  |  |          |      | GWP of the refrigerant   |   | 2088  | kg CO <sub>2</sub> eq (100 years) |
| Contact details  | Panasonic Testing Centre, Panasonic Marketing Europe GmbH Winsbergiring 15, 22525 Hamburg, Germany |          |      |  |   |       |                                   |

\*\* If  $C_{dh}$  is not determined by measurement then the default degradation coefficient of heat pumps shall be 0.25.  
\*\*\* from 26 September 2018.

Where information relates to multi-split heat pumps, the test result and performance data may be obtained on the basis of the performance of the outdoor unit, with a combination of indoor unit(s) recommended by the manufacturer or importer.

## Information requirements for air-to-air air conditioners

|  |  |                             |  |                           |  |    |  |
|--|--|-----------------------------|--|---------------------------|--|----|--|
| Model(s):  |  | Outdoor Unit<br>Indoor Unit |  | U-140PE1E5A<br>S-50PT2E5A |  | X3 |  |
| Outdoor side heat exchanger of air conditioner:  |  | air                         |  |                           |  |    |  |
| Indoor side heat exchanger of air conditioner:   |  | air                         |  |                           |  |    |  |
| Type: compressor driven vapour compression or sorption process   |  | vapour compression          |  |                           |  |    |  |
| if applicable: driver of compressor: [electric motor or fuel driven, gaseous or liquid fuel, internal or external combustion engine] |  | electric motor              |  |                           |  |    |  |

| Item  | Symbol  | Value    | Unit | Item   | Symbol  | Value | Unit                              |
|---|---|----------|------|--|---|-------|-----------------------------------|
| Rated cooling capacity  | $P_{rated,c}$   | 14.0     | kW   | Seasonal space cooling energy efficiency   | $\eta_{s,c}$  | 222.2 | %                                 |
| Refrigeration load  | $P_{design,c}$  | 14.0     | kW   | Declared energy efficiency ratio or gas utilization efficiency / auxiliary energy factor for part load at given outdoor temperatures T <sub>J</sub> and indoor 27°/19°C (dry/wet bulb) |   |       |                                   |
| Declared cooling capacity for part load at given outdoor temperatures T <sub>J</sub> and indoor 27°/19°C (dry/wet bulb) |   | 14.0     | kW   | T <sub>J</sub> = +35 °C  |   | 3.0   | %                                 |
|   |   | 10.3     | kW   | T <sub>J</sub> = +30 °C  | EER <sub>d</sub> or GUE <sub>d,dbn</sub> /                      | 4.0   | %                                 |
|   |   | 6.6      | kW   | T <sub>J</sub> = +25 °C  | AEF <sub>d,dbn</sub>  | 6.5   | %                                 |
|   |   | 5.1      | kW   | T <sub>J</sub> = +20 °C  |   | 10.2  | %                                 |
| Degradation co-efficient for air conditioners**   | $C_{dc}$  | 0.25     | -    |  |   |       |                                   |
| Declared heating capacity for part load at indoor temperature 20 °C and outdoor temperature T <sub>J</sub>              |   |          |      |  |   |       |                                   |
|   |   | 12.3     | kW   | T <sub>J</sub> = -7 °C   |   | 2.3   | %                                 |
|   |   | 7.5      | kW   | T <sub>J</sub> = +2 °C   |   | 3.5   | %                                 |
|   |   | 4.8      | kW   | T <sub>J</sub> = +7 °C   |   | 5.3   | %                                 |
|   |   | 4.6      | kW   | T <sub>J</sub> = +12 °C  |   | 6.6   | %                                 |
| T <sub>bw</sub> = bivalent temperature  |   | 12.3     | kW   | T <sub>bw</sub> = bivalent temperature   | COP <sub>d</sub> or GUE <sub>d,dbn</sub> / AEF <sub>d,dbn</sub> | 2.3   | %                                 |
| T <sub>ol</sub> = operation limit   |   | 9.5      | kW   | T <sub>ol</sub> = operation limit  |   | 1.7   | %                                 |
| For air-to-water heat pumps: T <sub>J</sub> = -15 °C (if T <sub>ol</sub> < -20 °C)                                      |   | -        | kW   | For water-to-air heat pumps: T <sub>J</sub> = -15 °C (if T <sub>ol</sub> < -20 °C)   |   | -     | %                                 |
| Bivalent temperature  |   | -7       | °C   | For water-to-air heat pumps: Operation limit temperature   | T <sub>ol</sub>   | -20   | °C                                |
| Degradation co-efficient heat pumps**   |   | 0.25     | -    |  |   |       |                                   |
| Power consumption in modes other than 'active mode'   |   |          |      |  |   |       |                                   |
| Off mode  | $P_{off}$   | 0.012    | kW   | Crankcase heater mode  | $P_{ck}$  | 0.000 | kW                                |
| Thermostat-off mode   | $P_{to}$  | 0.000    | kW   | Standby mode   | $P_{sb}$  | 0.012 | kW                                |
| Other items   |   |          |      |  |   |       |                                   |
| Capacity control  |   | variable |      | For air-to-air conditioner: air flow rate, outdoor   |   | 8100  | m <sup>3</sup> /h                 |
| Sound power level, outdoor  | L <sub>WA</sub>   | 71.0     | dB   |  |   |       |                                   |
| Sound power level, indoor   | L <sub>WA</sub>   | 55.0     | dB   | if engine driven: Emissions of nitrogen oxides   | NO <sub>x</sub> ***   | -     | mg/kWh fuel input GCV             |
|   |   |          |      | GWP of the refrigerant   |   | 2088  | kg CO <sub>2</sub> eq (100 years) |
| Contact details   | Panasonic Testing Centre, Panasonic Marketing Europe GmbH Winsbergring 15, 22525 Hamburg, Germany |          |      |  |   |       |                                   |

\*\* If  $C_{dc}$  is not determined by measurement then the default degradation coefficient air conditioners shall be 0.25.  
\*\*\* from 26 September 2018.

Where information relates to multi-split air conditioners, the test result and performance data may be obtained on the basis of the performance of the outdoor unit, with a combination of indoor unit(s) recommended by the manufacturer or importer.

## Information requirements for heat pumps

|  |  |                             |  |                           |  |    |  |
|--|--|-----------------------------|--|---------------------------|--|----|--|
| Model(s):  |  | Outdoor Unit<br>Indoor Unit |  | U-140PE1E5A<br>S-50PT2E5A |  | X3 |  |
| Outdoor side heat exchanger of heat pump:  |  | air                         |  |                           |  |    |  |
| Indoor side heat exchanger of heat pump:   |  | air                         |  |                           |  |    |  |
| Indication if the heater is equipped with a supplementary heater: if applicable: driver of compressor: [electric motor or fuel driven, gaseous or liquid fuel, internal or external combustion engine] |  | electric motor              |  |                           |  |    |  |
| Parameters shall be declared for the average heating season, parameters for the warmer and colder heating seasons are optional.  |  |                             |  |                           |  |    |  |

| Item   | Symbol  | Value    | Unit | Item   | Symbol  | Value | Unit                              |
|--|---|----------|------|--|---|-------|-----------------------------------|
| Rated heating capacity   | $P_{rated,h}$   | 16.0     | kW   | Seasonal space heating energy efficiency   | $\eta_{s,h}$  | 145.5 | %                                 |
| Refrigeration load   | $P_{design,h}$  | 14.0     | kW   | Declared coefficient of performance or gas utilization efficiency / auxiliary energy factor for part load at given outdoor temperatures T <sub>J</sub> |   |       |                                   |
| Declared heating capacity for part load at indoor temperature 20 °C and outdoor temperature T <sub>J</sub> |   | 12.3     | kW   | T <sub>J</sub> = -7 °C   |   | 2.3   | %                                 |
|  |   | 7.5      | kW   | T <sub>J</sub> = +2 °C   |   | 3.5   | %                                 |
|  |   | 4.8      | kW   | T <sub>J</sub> = +7 °C   |   | 5.3   | %                                 |
|  |   | 4.6      | kW   | T <sub>J</sub> = +12 °C  |   | 6.6   | %                                 |
| T <sub>bw</sub> = bivalent temperature   |   | 12.3     | kW   | T <sub>bw</sub> = bivalent temperature   | COP <sub>d</sub> or GUE <sub>d,dbn</sub> / AEF <sub>d,dbn</sub> | 2.3   | %                                 |
| T <sub>ol</sub> = operation limit  |   | 9.5      | kW   | T <sub>ol</sub> = operation limit  |   | 1.7   | %                                 |
| For air-to-water heat pumps: T <sub>J</sub> = -15 °C (if T <sub>ol</sub> < -20 °C)                         |   | -        | kW   | For water-to-air heat pumps: T <sub>J</sub> = -15 °C (if T <sub>ol</sub> < -20 °C)   |   | -     | %                                 |
| Bivalent temperature   |   | -7       | °C   | For water-to-air heat pumps: Operation limit temperature   | T <sub>ol</sub>   | -20   | °C                                |
| Degradation co-efficient heat pumps**  |   | 0.25     | -    |  |   |       |                                   |
| Power consumption in modes other than 'active mode'  |   |          |      |  |   |       |                                   |
| Off mode   | $P_{off}$   | 0.012    | kW   | Supplementary heater back-up heating capacity*   | eibu  | 2.4   | kW                                |
| Thermostat-off mode  | $P_{to}$  | 0.000    | kW   | Type of energy input   |   |       |                                   |
| Crankcase heater mode  | $P_{ck}$  | 0.000    | kW   | Standby mode   | $P_{sb}$  | 0.012 | kW                                |
| Other items  |   |          |      |  |   |       |                                   |
| Capacity control   |   | variable |      | For air-to-air heat pumps: air flow rate, outdoor  |   | 7200  | m <sup>3</sup> /h                 |
| Sound power level, outdoor   | L <sub>WA</sub>   | 71.0     | dB   | For water-/brine-to-air heat pumps: Rated brine or water flow rate, outdoor side heat exchanger  |   | -     | m <sup>3</sup> /h                 |
| Sound power level, indoor  | L <sub>WA</sub>   | 55.0     | dB   | Emissions of nitrogen oxides (if applicable)   | NO <sub>x</sub> ***   | -     | mg/kWh fuel input GCV             |
|  |   |          |      | GWP of the refrigerant   |   | 2088  | kg CO <sub>2</sub> eq (100 years) |
| Contact details  | Panasonic Testing Centre, Panasonic Marketing Europe GmbH Winsbergring 15, 22525 Hamburg, Germany |          |      |  |   |       |                                   |

\*\* If  $C_{dc}$  is not determined by measurement then the default degradation coefficient of heat pumps shall be 0.25.  
\*\*\* from 26 September 2018.

Where information relates to multi-split heat pumps, the test result and performance data may be obtained on the basis of the performance of the outdoor unit, with a combination of indoor unit(s) recommended by the manufacturer or importer.

## Information requirements for air-to-air air conditioners

|  |                             |                           |    |
|--|-----------------------------|---------------------------|----|
| Model(s):  | Outdoor Unit<br>Indoor Unit | U-125PE1E5A<br>S-60PT2E5A | X2 |
| Outdoor side heat exchanger of air conditioner:  | air                         |                           |    |
| Indoor side heat exchanger of air conditioner:   | air                         |                           |    |
| Type: compressor driven vapour compression or sorption process   | vapour compression          |                           |    |
| if applicable: driver of compressor: [electric motor or fuel driven, gaseous or liquid fuel, internal or external combustion engine] | electric motor              |                           |    |

| Item   | Symbol  | Value    | Unit | Item   | Symbol                                     | Value | Unit                              |
|--|---|----------|------|--|--|-------|-----------------------------------|
| Rated cooling capacity   | $P_{rated,c}$   | 12.5     | kW   | Seasonal space cooling energy efficiency               | $\eta_{s,c}$                               | 240.8 | %                                 |
| Refrigeration load   | $P_{design,c}$  | 12.5     | kW   |  |  |       |                                   |
| Declared cooling capacity for part load at given outdoor temperatures $T_j$ and indoor 27°/19°C (dry/wet bulb)                             |   |          |      |  |  |       |                                   |
| $T_j = +35\text{ °C}$  |   | 12.5     | kW   | $T_j = +35\text{ °C}$                                  |  | 3.3   | %                                 |
| $T_j = +30\text{ °C}$  |   | 9.2      | kW   | $T_j = +30\text{ °C}$                                  | EER <sub>d</sub> or GUE <sub>d,bin</sub> / | 4.4   | %                                 |
| $T_j = +25\text{ °C}$  | $P_{dc}$  | 5.9      | kW   | $T_j = +25\text{ °C}$                                  | AEF <sub>c,bin</sub>                       | 7.3   | %                                 |
| $T_j = +20\text{ °C}$  |   | 5.3      | kW   | $T_j = +20\text{ °C}$                                  |  | 10.3  | %                                 |
| Degradation co- efficient for air conditioners**   | $C_{dc}$  | 0.25     | -    |  |  |       |                                   |
| Declared energy efficiency ratio or gas utilization efficiency / auxiliary energy factor for part load at given outdoor temperatures $T_j$ |   |          |      |  |  |       |                                   |
| Power consumption in modes other than 'active mode'  |   |          |      |  |  |       |                                   |
| Off mode   | $P_{off}$   | 0.012    | kW   | Crankcase heater mode                                  | $P_{ck}$                                   | 0.000 | kW                                |
| Thermostat-off mode  | $P_{to}$  | 0.000    | kW   | Standby mode   | $P_{sb}$                                   | 0.012 | kW                                |
| Other items  |   |          |      |  |  |       |                                   |
| Capacity control   |   | variable |      | For air-to-air air conditioner: air flow rate, outdoor |  | 7800  | m <sup>3</sup> /h                 |
| Sound power level, outdoor   | $L_{WA}$  | 70.0     | dB   |  |  |       |                                   |
| Sound power level, indoor  | $L_{WA}$  | 56.0     | dB   | if engine driven: Emissions of nitrogen oxides         | NO <sub>x</sub> ***                        | -     | mg/kWh fuel input GCV             |
|  |   |          |      | GWP of the refrigerant                                 |  | 2088  | kg CO <sub>2</sub> eq (100 years) |
| Contact details  | Panasonic Testing Centre, Panasonic Marketing Europe GmbH Winsbergring 15, 22525 Hamburg, Germany |          |      |  |  |       |                                   |

\*\* If  $C_{dc}$  is not determined by measurement then the default degradation coefficient air conditioners shall be 0.25.

\*\*\* from 26 September 2018.

Where information relates to multi-split air conditioners, the test result and performance data may be obtained on the basis of the performance of the outdoor unit, with a combination of indoor unit(s) recommended by the manufacturer or importer.

## Information requirements for heat pumps

|  |                             |                           |    |
|--|-----------------------------|---------------------------|----|
| Model(s):  | Outdoor Unit<br>Indoor Unit | U-125PE1E5A<br>S-60PT2E5A | X2 |
| Outdoor side heat exchanger of heat pump:  | air                         |                           |    |
| Indoor side heat exchanger of heat pump:   | air                         |                           |    |
| Indication if the heater is equipped with a supplementary heater:  | no                          |                           |    |
| if applicable: driver of compressor: [electric motor or fuel driven, gaseous or liquid fuel, internal or external combustion engine] | electric motor              |                           |    |

Parameters shall be declared for the average heating season, parameters for the warmer and colder heating seasons are optional.

| Item  | Symbol  | Value    | Unit | Item  | Symbol  | Value | Unit                              |
|---|---|----------|------|---|---|-------|-----------------------------------|
| Rated heating capacity  | $P_{rated,h}$   | 14.0     | kW   | Seasonal space heating energy efficiency  | $\eta_{h,h}$  | 150.1 | %                                 |
| Refrigeration load  | $P_{design,h}$  | 12.5     | kW   |   |   |       |                                   |
| Declared heating capacity for part load at indoor temperature 20 °C and outdoor temperature $T_j$ |   |          |      |   |   |       |                                   |
| $T_j = -7\text{ °C}$  |   | 11.0     | kW   | $T_j = -7\text{ °C}$  |   | 2.4   | %                                 |
| $T_j = +2\text{ °C}$  |   | 6.7      | kW   | $T_j = +2\text{ °C}$  |   | 3.6   | %                                 |
| $T_j = +7\text{ °C}$  |   | 4.3      | kW   | $T_j = +7\text{ °C}$  |   | 5.4   | %                                 |
| $T_j = +12\text{ °C}$   |   | 4.5      | kW   | $T_j = +12\text{ °C}$   | COP <sub>d</sub> or GUE <sub>d,bin</sub> / AEF <sub>d,bin</sub> | 6.6   | %                                 |
| $T_{bh}$ = bivalent temperature   | $P_{bh}$  | 12.5     | kW   | $T_{bh}$ = bivalent temperature   |   | 2.2   | %                                 |
| $T_{ol}$ = operation limit  |   | 9.3      | kW   | $T_{ol}$ = operation limit  |   | 1.8   | %                                 |
| For air-to-water heat pumps: $T_j = -15\text{ °C}$ (if $T_{ol} < -20\text{ °C}$ )                 |   | -        | kW   | For water-to-air heat pumps: $T_j = -15\text{ °C}$ (if $T_{ol} < -20\text{ °C}$ )               |   | -     | %                                 |
| Bivalent temperature  | $T_{bv}$  | -10      | °C   | For water-to-air heat pumps: Operation limit temperature  | $T_{ol}$  | -20   | °C                                |
| Degradation co- efficient heat pumps**  | $C_{dh}$  | 0.25     | -    |   |   |       |                                   |
| Power consumption in modes other than 'active mode'   |   |          |      |   |   |       |                                   |
| Off mode  | $P_{off}$   | 0.012    | kW   | Supplementary heater back-up heating capacity*  | eibu  | 0.0   | kW                                |
| Thermostat-off mode   | $P_{to}$  | 0.000    | kW   | Type of energy input  |   |       |                                   |
| Crankcase heater mode   | $P_{ck}$  | 0.000    | kW   | Standby mode  | $P_{sb}$  | 0.012 | kW                                |
| Other items   |   |          |      |   |   |       |                                   |
| Capacity control  |   | variable |      | For air-to-air heat pumps: air flow rate, outdoor   |   | 6600  | m <sup>3</sup> /h                 |
| Sound power level, outdoor  | $L_{WA}$  | 70.0     | dB   | For water-/brine-to-air heat pumps: Rated brine or water flow rate, outdoor side heat exchanger |   | -     | m <sup>3</sup> /h                 |
| Sound power level, indoor   | $L_{WA}$  | 56.0     | dB   | Emissions of nitrogen oxides (if applicable)  | NO <sub>x</sub> ***   | -     | mg/kWh fuel input GCV             |
|   |   |          |      | GWP of the refrigerant  |   | 2088  | kg CO <sub>2</sub> eq (100 years) |
| Contact details   | Panasonic Testing Centre, Panasonic Marketing Europe GmbH Winsbergring 15, 22525 Hamburg, Germany |          |      |   |   |       |                                   |

\*\* If  $C_{dh}$  is not determined by measurement then the default degradation coefficient of heat pumps shall be 0.25.

\*\*\* from 26 September 2018.

Where information relates to multi-split heat pumps, the test result and performance data may be obtained on the basis of the performance of the outdoor unit, with a combination of indoor unit(s) recommended by the manufacturer or importer.

## Information requirements for air-to-air air conditioners

|  |                             |                           |    |
|--|-----------------------------|---------------------------|----|
| Model(s):  | Outdoor Unit<br>Indoor Unit | U-140PE1E5A<br>S-71PT2E5A | X2 |
| Outdoor side heat exchanger of air conditioner:  | air                         |                           |    |
| Indoor side heat exchanger of air conditioner:   | air                         |                           |    |
| Type: compressor driven vapour compression or sorption process   | vapour compression          |                           |    |
| if applicable: driver of compressor: [electric motor or fuel driven, gaseous or liquid fuel, internal or external combustion engine] | electric motor              |                           |    |

| Item   | Symbol   | Value    | Unit | Item   | Symbol       | Value | Unit                              |
|--|--|----------|------|--|--------------|-------|-----------------------------------|
| Rated cooling capacity   | $P_{rated,c}$  | 14.0     | kW   | Seasonal space cooling energy efficiency   | $\eta_{s,c}$ | 221.9 | %                                 |
| Refrigeration load   | $P_{design,c}$   | 14.0     | kW   |  |              |       |                                   |
| Declared cooling capacity for part load at given outdoor temperatures $T_j$ and indoor 27°/19°C (dry/wet bulb)                             |  |          |      |  |              |       |                                   |
| $T_j = +35\text{ °C}$  |  | 14.0     | kW   | $T_j = +35\text{ °C}$  |              | 3.0   | %                                 |
| $T_j = +30\text{ °C}$  |  | 10.3     | kW   | $T_j = +30\text{ °C}$  |              | 4.0   | %                                 |
| $T_j = +25\text{ °C}$  | $P_{dc}$   | 6.6      | kW   | $T_j = +25\text{ °C}$  |              | 6.5   | %                                 |
| $T_j = +20\text{ °C}$  |  | 5.3      | kW   | $T_j = +20\text{ °C}$  |              | 10.2  | %                                 |
| Degradation co-efficient for air conditioners**  | $C_{dc}$   | 0.25     | -    |  |              |       |                                   |
| Declared energy efficiency ratio or gas utilization efficiency / auxiliary energy factor for part load at given outdoor temperatures $T_j$ |  |          |      |  |              |       |                                   |
| $T_j = -7\text{ °C}$   |  | 12.3     | kW   | $T_j = -7\text{ °C}$   |              | 2.3   | %                                 |
| $T_j = +2\text{ °C}$   |  | 7.5      | kW   | $T_j = +2\text{ °C}$   |              | 3.5   | %                                 |
| $T_j = +7\text{ °C}$   |  | 4.8      | kW   | $T_j = +7\text{ °C}$   |              | 5.3   | %                                 |
| $T_j = +12\text{ °C}$  |  | 4.6      | kW   | $T_j = +12\text{ °C}$  |              | 6.6   | %                                 |
| $T_{bv} = \text{bivalent temperature}$   | $P_{ch}$   | 12.3     | kW   | $T_{bv} = \text{bivalent temperature}$   |              | 2.3   | %                                 |
| $T_{ol} = \text{operation limit}$  |  | 9.5      | kW   | $T_{ol} = \text{operation limit}$  |              | 1.7   | %                                 |
| For air-to-water heat pumps:<br>$T_j = -15\text{ °C}$ (if $T_{ol} < -20\text{ °C}$ )   |  | -        | kW   | For water-to-air heat pumps:<br>$T_j = -15\text{ °C}$ (if $T_{ol} < -20\text{ °C}$ ) |              | -     | %                                 |
| Bivalent temperature   | $T_{bv}$   | -7       | °C   | For water-to-air heat pumps:<br>Operation limit temperature                          | $T_{ol}$     | -20   | °C                                |
| Degradation co-efficient heat pumps**  | $C_{ch}$   | 0.25     | -    |  |              |       |                                   |
| Power consumption in modes other than 'active mode'  |  |          |      |  |              |       |                                   |
| Off mode   | $P_{off}$  | 0.012    | kW   | Crankcase heater mode  | $P_{ck}$     | 0.000 | kW                                |
| Thermostat-off mode  | $P_{to}$   | 0.000    | kW   | Standby mode   | $P_{sb}$     | 0.012 | kW                                |
| Other items  |  |          |      |  |              |       |                                   |
| Capacity control   |  | variable |      | For air-to-air conditioner: air flow rate, outdoor                                   |              | 8100  | m³/h                              |
| Sound power level, outdoor   | $L_{WA}$   | 71.0     | dB   |  |              |       |                                   |
| Sound power level, indoor  | $L_{WA}$   | 57.0     | dB   | if engine driven: Emissions of nitrogen oxides                                       | $NO_x^{***}$ | -     | mg/kWh fuel input GCV             |
|  |  |          |      | GWP of the refrigerant   |              | 2088  | kg CO <sub>2</sub> eq (100 years) |
| Contact details  | Panasonic Testing Centre, Panasonic Marketing Europe GmbH Winsbergiring 15, 22525 Hamburg, Germany |          |      |  |              |       |                                   |

\*\* If  $C_{dc}$  is not determined by measurement then the default degradation coefficient air conditioners shall be 0.25.  
\*\*\* from 26 September 2018.

Where information relates to multi-split air conditioners, the test result and performance data may be obtained on the basis of the performance of the outdoor unit, with a combination of indoor unit(s) recommended by the manufacturer or importer.

## Information requirements for heat pumps

|  |                             |                           |    |
|--|-----------------------------|---------------------------|----|
| Model(s):  | Outdoor Unit<br>Indoor Unit | U-140PE1E5A<br>S-71PT2E5A | X2 |
| Outdoor side heat exchanger of heat pump:  | air                         |                           |    |
| Indoor side heat exchanger of heat pump:   | air                         |                           |    |
| Indication if the heater is equipped with a supplementary heater:  | no                          |                           |    |
| if applicable: driver of compressor: [electric motor or fuel driven, gaseous or liquid fuel, internal or external combustion engine] | electric motor              |                           |    |

Parameters shall be declared for the average heating season, parameters for the warmer and colder heating seasons are optional.

| Item  | Symbol   | Value    | Unit | Item  | Symbol       | Value | Unit                              |
|---|--|----------|------|---|--------------|-------|-----------------------------------|
| Rated heating capacity  | $P_{rated,h}$  | 16.0     | kW   | Seasonal space heating energy efficiency  | $\eta_{s,h}$ | 145.5 | %                                 |
| Refrigeration load  | $P_{design,h}$   | 14.0     | kW   |   |              |       |                                   |
| Declared heating capacity for part load at indoor temperature 20 °C and outdoor temperature $T_j$ |  |          |      |   |              |       |                                   |
| $T_j = -7\text{ °C}$  |  | 12.3     | kW   | $T_j = -7\text{ °C}$  |              | 2.3   | %                                 |
| $T_j = +2\text{ °C}$  |  | 7.5      | kW   | $T_j = +2\text{ °C}$  |              | 3.5   | %                                 |
| $T_j = +7\text{ °C}$  |  | 4.8      | kW   | $T_j = +7\text{ °C}$  |              | 5.3   | %                                 |
| $T_j = +12\text{ °C}$   |  | 4.6      | kW   | $T_j = +12\text{ °C}$   |              | 6.6   | %                                 |
| $T_{bv} = \text{bivalent temperature}$  | $P_{ch}$   | 12.3     | kW   | $T_{bv} = \text{bivalent temperature}$  |              | 2.3   | %                                 |
| $T_{ol} = \text{operation limit}$   |  | 9.5      | kW   | $T_{ol} = \text{operation limit}$   |              | 1.7   | %                                 |
| For air-to-water heat pumps:<br>$T_j = -15\text{ °C}$ (if $T_{ol} < -20\text{ °C}$ )              |  | -        | kW   | For water-to-air heat pumps:<br>$T_j = -15\text{ °C}$ (if $T_{ol} < -20\text{ °C}$ )            |              | -     | %                                 |
| Bivalent temperature  | $T_{bv}$   | -7       | °C   | For water-to-air heat pumps:<br>Operation limit temperature                                     | $T_{ol}$     | -20   | °C                                |
| Degradation co-efficient heat pumps**   | $C_{ch}$   | 0.25     | -    |   |              |       |                                   |
| Power consumption in modes other than 'active mode'   |  |          |      |   |              |       |                                   |
| Off mode  | $P_{off}$  | 0.012    | kW   | Supplementary heater back-up heating capacity*  | eibu         | 2.4   | kW                                |
| Thermostat-off mode   | $P_{to}$   | 0.000    | kW   | Type of energy input  |              |       |                                   |
| Crankcase heater mode   | $P_{ck}$   | 0.000    | kW   | Standby mode  | $P_{sb}$     | 0.012 | kW                                |
| Other items   |  |          |      |   |              |       |                                   |
| Capacity control  |  | variable |      | For air-to-air heat pumps: air flow rate, outdoor   |              | 7200  | m³/h                              |
| Sound power level, outdoor  | $L_{WA}$   | 71.0     | dB   | For water-/brine-to-air heat pumps: Rated brine or water flow rate, outdoor side heat exchanger |              | -     | m³/h                              |
| Sound power level, indoor   | $L_{WA}$   | 57.0     | dB   | Emissions of nitrogen oxides (if applicable)  | $NO_x^{***}$ | -     | mg/kWh fuel input GCV             |
|   |  |          |      | GWP of the refrigerant  |              | 2088  | kg CO <sub>2</sub> eq (100 years) |
| Contact details   | Panasonic Testing Centre, Panasonic Marketing Europe GmbH Winsbergiring 15, 22525 Hamburg, Germany |          |      |   |              |       |                                   |

\*\* If  $C_{ch}$  is not determined by measurement then the default degradation coefficient of heat pumps shall be 0.25.  
\*\*\* from 26 September 2018.

Where information relates to multi-split heat pumps, the test result and performance data may be obtained on the basis of the performance of the outdoor unit, with a combination of indoor unit(s) recommended by the manufacturer or importer.

Information requirements for air-to-air air conditioners

Model(s): Outdoor Unit Indoor Unit  
 U-125PE1E5A S-125PT2E5A

Outdoor side heat exchanger of air conditioner: air  
 Indoor side heat exchanger of air conditioner: air  
 Type: compressor driven vapour compression or sorption process vapour compression  
 if applicable: driver of compressor: [electric motor or fuel driven, electric motor]  
 gaseous or liquid fuel, internal or external combustion engine]

| Item  | Symbol   | Value    | Unit | Item   | Symbol  | Value | Unit                              |
|---|--|----------|------|--|---|-------|-----------------------------------|
| Rated cooling capacity  | $P_{rated,c}$  | 12.5     | kW   | Seasonal space cooling energy efficiency   | $\eta_{s,c}$  | 227.4 | %                                 |
| Refrigeration load  | $P_{design,c}$   | 12.5     | kW   | Declared energy efficiency ratio or gas utilization efficiency / auxiliary energy factor for part load at given outdoor temperatures T <sub>J</sub> and indoor 27°/19°C (dry/wet bulb) |   |       |                                   |
| Declared cooling capacity for part load at given outdoor temperatures T <sub>J</sub> and indoor 27°/19°C (dry/wet bulb) |  |          |      | Declared energy efficiency ratio or gas utilization efficiency / auxiliary energy factor for part load at given outdoor temperatures T <sub>J</sub>                                    |   |       |                                   |
| T <sub>J</sub> = + 35 °C  |  | 12.5     | kW   | T <sub>J</sub> = + 35 °C   | EER <sub>d</sub> or GUE <sub>d,bin</sub> / AEF <sub>d,bin</sub> | 3.3   | %                                 |
| T <sub>J</sub> = + 30 °C  |  | 9.2      | kW   | T <sub>J</sub> = + 30 °C   |   | 4.4   | %                                 |
| T <sub>J</sub> = + 25 °C  |  | 5.9      | kW   | T <sub>J</sub> = + 25 °C   |   | 7.3   | %                                 |
| T <sub>J</sub> = + 20 °C  |  | 5.0      | kW   | T <sub>J</sub> = + 20 °C   |   | 10.3  | %                                 |
| Degradation co- efficient for air conditioners**  | $C_{de}$   | 0.25     | -    |  |   |       |                                   |
| Power consumption in modes other than 'active mode'   |  |          |      |  |   |       |                                   |
| Off mode  | $P_{off}$  | 0.017    | kW   | Crankcase heater mode  | $P_{ck}$  | 0.000 | kW                                |
| Thermostat-off mode   | $P_{to}$   | 0.101    | kW   | Standby mode   | $P_{sb}$  | 0.017 | kW                                |
| Other items   |  |          |      |  |   |       |                                   |
| Capacity control  |  | variable |      | For air-to-air air conditioner: air flow rate, outdoor   |   | 7800  | m <sup>3</sup> /h                 |
| Sound power level, outdoor  | $L_{WA}$   | 70.0     | dB   |  |   |       |                                   |
| Sound power level, indoor   | $L_{WA}$   | 64.0     | dB   | if engine driven: Emissions of nitrogen oxides   | $NO_x^{***}$  | -     | mg/kWh fuel input GCV             |
|   |  |          |      | GWP of the refrigerant   |   | 2088  | kg CO <sub>2</sub> eq (100 years) |
| Contact details   | Panasonic Testing Centre, Panasonic Marketing Europe GmbH Winsbergiring 15, 22525 Hamburg, Germany |          |      |  |   |       |                                   |

\*\* If  $C_{de}$  is not determined by measurement then the default degradation coefficient air conditioners shall be 0.25.  
 \*\*\* from 26 September 2018.

Where information relates to multi-split air conditioners, the test result and performance data may be obtained on the basis of the performance of the outdoor unit, with a combination of indoor unit(s) recommended by the manufacturer or importer.

Information requirements for heat pumps

Model(s): Outdoor Unit Indoor Unit  
 U-125PE1E5A S-125PT2E5A

Outdoor side heat exchanger of heat pump: air  
 Indoor side heat exchanger of heat pump: air  
 Indication if the heater is equipped with a supplementary heater: no  
 if applicable: driver of compressor: [electric motor or fuel driven, electric motor]  
 gaseous or liquid fuel, internal or external combustion engine]  
 Parameters shall be declared for the average heating season, parameters for the warmer and colder heating seasons are optional.

| Item   | Symbol   | Value    | Unit | Item   | Symbol  | Value | Unit                              |
|--|--|----------|------|--|---|-------|-----------------------------------|
| Rated heating capacity   | $P_{rated,h}$  | 14.0     | kW   | Seasonal space heating energy efficiency   | $\eta_{s,h}$  | 149.5 | %                                 |
| Refrigeration load   | $P_{design,h}$   | 12.5     | kW   | Declared coefficient of performance or gas utilization efficiency / auxiliary energy factor for part load at given outdoor temperatures T <sub>J</sub> |   |       |                                   |
| Declared heating capacity for part load at indoor temperature 20 °C and outdoor temperature T <sub>J</sub> |  |          |      | Declared coefficient of performance or gas utilization efficiency / auxiliary energy factor for part load at given outdoor temperatures T <sub>J</sub> |   |       |                                   |
| T <sub>J</sub> = - 7 °C  |  | 11.0     | kW   | T <sub>J</sub> = - 7 °C  |   | 2.4   | %                                 |
| T <sub>J</sub> = + 2 °C  |  | 6.7      | kW   | T <sub>J</sub> = + 2 °C  |   | 3.6   | %                                 |
| T <sub>J</sub> = + 7 °C  |  | 4.3      | kW   | T <sub>J</sub> = + 7 °C  |   | 5.4   | %                                 |
| T <sub>J</sub> = + 12 °C   |  | 4.5      | kW   | T <sub>J</sub> = + 12 °C   |   | 6.6   | %                                 |
| $T_{bv}$ = bivalent temperature  | $P_{bh}$   | 12.5     | kW   | $T_{bv}$ = bivalent temperature  | $COP_{h,or}$ / GUE <sub>h,bin</sub> / AEF <sub>h,bin}</sub> | 2.2   | %                                 |
| $T_{ol}$ = operation limit   |  | 9.8      | kW   | $T_{ol}$ = operation limit   |   | 1.8   | %                                 |
| For air-to-water heat pumps: T <sub>J</sub> = - 15 °C (if T <sub>ol</sub> < - 20 °C)                       |  | -        | kW   | For water-to-air heat pumps: T <sub>J</sub> = - 15 °C (if T <sub>ol</sub> < - 20 °C)   |   | -     | %                                 |
| Bivalent temperature   | $T_{bv}$   | -10      | °C   | For water-to-air heat pumps: Operation limit temperature   | $T_{ol}$  | -20   | °C                                |
| Degradation co- efficient heat pumps**   | $C_{dh}$   | 0.25     | -    |  |   |       |                                   |
| Power consumption in modes other than 'active mode'  |  |          |      |  |   |       |                                   |
| Off mode   | $P_{off}$  | 0.017    | kW   | Supplementary heater back-up heating capacity*   | $e_{ibu}$   | 0.0   | kW                                |
| Thermostat-off mode  | $P_{to}$   | 0.101    | kW   | Type of energy input   |   |       |                                   |
| Crankcase heater mode  | $P_{ck}$   | 0.000    | kW   | Standby mode   | $P_{sb}$  | 0.017 | kW                                |
| Other items  |  |          |      |  |   |       |                                   |
| Capacity control   |  | variable |      | For air-to-air heat pumps: air flow rate, outdoor  |   | 6600  | m <sup>3</sup> /h                 |
| Sound power level, outdoor   | $L_{WA}$   | 70.0     | dB   | For water-/brine-to-air heat pumps: Rated brine or water flow rate, outdoor side heat exchanger  |   | -     | m <sup>3</sup> /h                 |
| Sound power level, indoor  | $L_{WA}$   | 64.0     | dB   | Emissions of nitrogen oxides (if applicable)   | $NO_x^{***}$  | -     | mg/kWh fuel input GCV             |
|  |  |          |      | GWP of the refrigerant   |   | 2088  | kg CO <sub>2</sub> eq (100 years) |
| Contact details  | Panasonic Testing Centre, Panasonic Marketing Europe GmbH Winsbergiring 15, 22525 Hamburg, Germany |          |      |  |   |       |                                   |

\*\* If  $C_{dh}$  is not determined by measurement then the default degradation coefficient of heat pumps shall be 0.25.  
 \*\*\* from 26 September 2018.

Where information relates to multi-split heat pumps, the test result and performance data may be obtained on the basis of the performance of the outdoor unit, with a combination of indoor unit(s) recommended by the manufacturer or importer.

## Information requirements for air-to-air air conditioners

|  |  |                             |  |                            |  |
|--|--|-----------------------------|--|----------------------------|--|
| Model(s):  |  | Outdoor Unit<br>Indoor Unit |  | U-140PE1E5A<br>S-140PT2E5A |  |
| Outdoor side heat exchanger of air conditioner:  |  | air                         |  |                            |  |
| Indoor side heat exchanger of air conditioner:   |  | air                         |  |                            |  |
| Type: compressor driven vapour compression or sorption process   |  | vapour compression          |  |                            |  |
| if applicable: driver of compressor: [electric motor or fuel driven, gaseous or liquid fuel, internal or external combustion engine] |  | electric motor              |  |                            |  |

| Item  | Symbol   | Value    | Unit | Item   | Symbol  | Value | Unit                              |
|---|--|----------|------|--|---|-------|-----------------------------------|
| Rated cooling capacity  | $P_{rated,c}$  | 14.0     | kW   | Seasonal space cooling energy efficiency   | $\eta_{s,c}$  | 211.3 | %                                 |
| Refrigeration load  | $P_{design,c}$   | 14.0     | kW   | Declared energy efficiency ratio or gas utilization efficiency / auxiliary energy factor for part load at given outdoor temperatures T <sub>J</sub> and indoor 27°/19°C (dry/wet bulb) |   |       |                                   |
| Declared cooling capacity for part load at given outdoor temperatures T <sub>J</sub> and indoor 27°/19°C (dry/wet bulb) | T <sub>J</sub> = + 35 °C   | 14.0     | kW   | T <sub>J</sub> = + 35 °C   | EER <sub>d</sub> or<br>GUE <sub>c,dbn</sub> /<br>AEF <sub>c,dbn</sub> | 3.0   | %                                 |
|   | T <sub>J</sub> = + 30 °C   | 10.3     | kW   | T <sub>J</sub> = + 30 °C   |   | 4.0   | %                                 |
|   | T <sub>J</sub> = + 25 °C   | 6.6      | kW   | T <sub>J</sub> = + 25 °C   |   | 6.5   | %                                 |
|   | T <sub>J</sub> = + 20 °C   | 5.0      | kW   | T <sub>J</sub> = + 20 °C   |   | 10.2  | %                                 |
| Degradation co- efficient for air conditioners**  | $C_{de}$   | 0.25     | -    |  |   |       |                                   |
| Power consumption in modes other than 'active mode'   |  |          |      |  |   |       |                                   |
| Off mode  | $P_{off}$  | 0.017    | kW   | Crankcase heater mode  | $P_{ck}$  | 0.000 | kW                                |
| Thermostat-off mode   | $P_{to}$   | 0.106    | kW   | Standby mode   | $P_{sb}$  | 0.017 | kW                                |
| Other items   |  |          |      |  |   |       |                                   |
| Capacity control  |  | variable |      | For air-to-air air conditioner: air flow rate, outdoor   |   | 8100  | m <sup>3</sup> /h                 |
| Sound power level, outdoor  | $L_{WA}$   | 71.0     | dB   |  |   |       |                                   |
| Sound power level, indoor   | $L_{WA}$   | 65.0     | dB   | if engine driven: Emissions of nitrogen oxides   | $NO_x^{***}$  | -     | mg/kWh fuel input GCV             |
|   |  |          |      | GWP of the refrigerant   |   | 2088  | kg CO <sub>2</sub> eq (100 years) |
| Contact details   | Panasonic Testing Centre, Panasonic Marketing Europe GmbH Winsbergiring 15, 22525 Hamburg, Germany |          |      |  |   |       |                                   |

\*\* If  $C_{de}$  is not determined by measurement then the default degradation coefficient air conditioners shall be 0.25.  
\*\*\* from 26 September 2018.

Where information relates to multi-split air conditioners, the test result and performance data may be obtained on the basis of the performance of the outdoor unit, with a combination of indoor unit(s) recommended by the manufacturer or importer.

## Information requirements for heat pumps

|  |  |                             |  |                            |  |
|--|--|-----------------------------|--|----------------------------|--|
| Model(s):  |  | Outdoor Unit<br>Indoor Unit |  | U-140PE1E5A<br>S-140PT2E5A |  |
| Outdoor side heat exchanger of heat pump:  |  | air                         |  |                            |  |
| Indoor side heat exchanger of heat pump:   |  | air                         |  |                            |  |
| Indication if the heater is equipped with a supplementary heater:  |  | no                          |  |                            |  |
| if applicable: driver of compressor: [electric motor or fuel driven, gaseous or liquid fuel, internal or external combustion engine] |  | electric motor              |  |                            |  |

Parameters shall be declared for the average heating season, parameters for the warmer and colder heating seasons are optional.

| Item   | Symbol   | Value    | Unit | Item   | Symbol  | Value | Unit                              |
|--|--|----------|------|--|---|-------|-----------------------------------|
| Rated heating capacity   | $P_{rated,h}$  | 16.0     | kW   | Seasonal space heating energy efficiency   | $\eta_{s,h}$  | 145.0 | %                                 |
| Refrigeration load   | $P_{design,h}$   | 14.0     | kW   | Declared coefficient of performance or gas utilization efficiency / auxiliary energy factor for part load at given outdoor temperatures T <sub>J</sub> |   |       |                                   |
| Declared heating capacity for part load at indoor temperature 20 °C and outdoor temperature T <sub>J</sub> | T <sub>J</sub> = - 7 °C  | 12.3     | kW   | T <sub>J</sub> = - 7 °C  | COP <sub>d</sub> or<br>GUE <sub>h,dbn</sub> /<br>AEF <sub>h,dbn</sub> | 2.3   | %                                 |
|  | T <sub>J</sub> = + 2 °C  | 7.5      | kW   | T <sub>J</sub> = + 2 °C  |   | 3.5   | %                                 |
|  | T <sub>J</sub> = + 7 °C  | 4.8      | kW   | T <sub>J</sub> = + 7 °C  |   | 5.3   | %                                 |
|  | T <sub>J</sub> = + 12 °C   | 4.6      | kW   | T <sub>J</sub> = + 12 °C   |   | 6.6   | %                                 |
| $T_{bw}$ = bivalent temperature  | $P_{bh}$   | 12.3     | kW   | $T_{bw}$ = bivalent temperature  |   | 2.3   | %                                 |
| $T_{ol}$ = operation limit   |  | 10.0     | kW   | $T_{ol}$ = operation limit   |   | 1.7   | %                                 |
| For air-to-water heat pumps: T <sub>J</sub> = - 15 °C (if T <sub>ol</sub> < - 20 °C)                       |  | -        | kW   | For water-to-air heat pumps: T <sub>J</sub> = - 15 °C (if T <sub>ol</sub> < - 20 °C)   |   | -     | %                                 |
| Bivalent temperature   | $T_{bv}$   | -7       | °C   | For water-to-air heat pumps: Operation limit temperature   | $T_{ol}$  | -20   | °C                                |
| Degradation co- efficient heat pumps**   | $C_{dh}$   | 0.25     | -    |  |   |       |                                   |
| Power consumption in modes other than 'active mode'  |  |          |      |  |   |       |                                   |
| Off mode   | $P_{off}$  | 0.017    | kW   | Supplementary heater back-up heating capacity *  | eibu  | 2.3   | kW                                |
| Thermostat-off mode  | $P_{to}$   | 0.106    | kW   | Type of energy input   |   |       |                                   |
| Crankcase heater mode  | $P_{ck}$   | 0.000    | kW   | Standby mode   | $P_{sb}$  | 0.017 | kW                                |
| Other items  |  |          |      |  |   |       |                                   |
| Capacity control   |  | variable |      | For air-to-air heat pumps: air flow rate, outdoor  |   | 7200  | m <sup>3</sup> /h                 |
| Sound power level, outdoor   | $L_{WA}$   | 71.0     | dB   | For water-/brine-to-air heat pumps: Rated brine or water flow rate, outdoor side heat exchanger  |   | -     | m <sup>3</sup> /h                 |
| Sound power level, indoor  | $L_{WA}$   | 65.0     | dB   | Emissions of nitrogen oxides (if applicable)   | $NO_x^{***}$  | -     | mg/kWh fuel input GCV             |
|  |  |          |      | GWP of the refrigerant   |   | 2088  | kg CO <sub>2</sub> eq (100 years) |
| Contact details  | Panasonic Testing Centre, Panasonic Marketing Europe GmbH Winsbergiring 15, 22525 Hamburg, Germany |          |      |  |   |       |                                   |

\*\* If  $C_{dh}$  is not determined by measurement then the default degradation coefficient of heat pumps shall be 0.25.  
\*\*\* from 26 September 2018.

Where information relates to multi-split heat pumps, the test result and performance data may be obtained on the basis of the performance of the outdoor unit, with a combination of indoor unit(s) recommended by the manufacturer or importer.

### Information requirements for air-to-air air conditioners

|  |  |                           |  |                    |  |
|--|--|---------------------------|--|--------------------|--|
| Model(s):  |  | U-125PE1E8A<br>S-36PT2E5A |  | X4                 |  |
| Outdoor side heat exchanger of air conditioner:  |  | Indoor Unit               |  | air                |  |
| Indoor side heat exchanger of air conditioner:   |  | Outdoor Unit              |  | air                |  |
| Type: compressor driven vapour compression or sorption process   |  |                           |  | vapour compression |  |
| if applicable: driver of compressor: [electric motor or fuel driven, gaseous or liquid fuel, internal or external combustion engine] |  |                           |  | electric motor     |  |

| Item  | Symbol  | Value    | Unit | Item  | Symbol                                       | Value | Unit                              |
|---|---|----------|------|---|--|-------|-----------------------------------|
| Rated cooling capacity  | $P_{rated,c}$   | 12.5     | kW   | Seasonal space cooling energy efficiency  | $\eta_{sc}$                                  | 240.2 | %                                 |
| Refrigeration load  | $P_{design,c}$  | 12.5     | kW   | Declared energy efficiency ratio or gas utilization efficiency / auxiliary energy factor for part load at given outdoor temperatures Tj |  |       |                                   |
| Declared cooling capacity for part load at given outdoor temperatures Tj and indoor 27°/19°C (dry/wet bulb) |   |          |      |   |  |       |                                   |
| Tj = + 35 °C  |   | 12.5     | kW   | Tj = + 35 °C  |  | 3.3   | %                                 |
| Tj = + 30 °C  |   | 9.2      | kW   | Tj = + 30 °C  | EER <sub>cl</sub> or GUE <sub>cl,bin</sub> / | 4.4   | %                                 |
| Tj = + 25 °C  | P <sub>dc</sub>   | 5.9      | kW   | Tj = + 25 °C  | AEF <sub>cl,bin</sub>                        | 7.3   | %                                 |
| Tj = + 20 °C  |   | 5.1      | kW   | Tj = + 20 °C  |  | 10.3  | %                                 |
| Degradation co- efficient for air conditioners**  | C <sub>dc</sub>   | 0.25     | -    |   |  |       |                                   |
| Power consumption in modes other than 'active mode'   |   |          |      |   |  |       |                                   |
| Off mode  | P <sub>off</sub>  | 0.015    | kW   | Crankcase heater mode   | P <sub>ck</sub>                              | 0.000 | kW                                |
| Thermostat-off mode   | P <sub>to</sub>   | 0.000    | kW   | Standby mode  | P <sub>sb</sub>                              | 0.015 | kW                                |
| Other items   |   |          |      |   |  |       |                                   |
| Capacity control  |   | variable |      | For air-to-air conditioner: air flow rate, outdoor  |  | 7800  | m <sup>3</sup> /h                 |
| Sound power level, outdoor  | L <sub>WA</sub>   | 70.0     | dB   |   |  |       |                                   |
| Sound power level, indoor   | L <sub>WA</sub>   | 54.0     | dB   | if engine driven: Emissions of nitrogen oxides  | NO <sub>x</sub> ***                          | -     | mg/kWh fuel input GCV             |
|   |   |          |      | GWP of the refrigerant  |  | 2088  | kg CO <sub>2</sub> eq (100 years) |
| Contact details   | Panasonic Testing Centre, Panasonic Marketing Europe GmbH Winsberg 15, 22525 Hamburg, Germany |          |      |   |  |       |                                   |

\*\* If C<sub>dc</sub> is not determined by measurement then the default degradation coefficient air conditioners shall be 0.25.

\*\*\* from 26 September 2018.

Where information relates to multi-split air conditioners, the test result and performance data may be obtained on the basis of the performance of the outdoor unit, with a combination of indoor unit(s) recommended by the manufacturer or importer.

### Information requirements for heat pumps

|  |  |                           |  |                |  |
|--|--|---------------------------|--|----------------|--|
| Model(s):  |  | U-125PE1E8A<br>S-36PT2E5A |  | X4             |  |
| Outdoor: side heat exchanger of heat pump:   |  | Indoor Unit               |  | air            |  |
| Indoor: side heat exchanger of heat pump:  |  | Outdoor Unit              |  | air            |  |
| Indication if the heater is equipped with a supplementary heater:  |  |                           |  | no             |  |
| if applicable: driver of compressor: [electric motor or fuel driven, gaseous or liquid fuel, internal or external combustion engine] |  |                           |  | electric motor |  |

Parameters shall be declared for the average heating season, parameters for the warmer and colder heating seasons are optional.

| Item   | Symbol  | Value    | Unit | Item   | Symbol  | Value | Unit                              |
|--|---|----------|------|--|---|-------|-----------------------------------|
| Rated heating capacity   | $P_{rated,h}$   | 14.0     | kW   | Seasonal space heating energy efficiency   | $\eta_{sh}$   | 150.1 | %                                 |
| Refrigeration load   | $P_{design,h}$  | 12.5     | kW   | Declared coefficient of performance or gas utilization efficiency / auxiliary energy factor for part load at given outdoor temperatures Tj |   |       |                                   |
| Declared heating capacity for part load at indoor temperature 20 °C and outdoor temperature Tj |   |          |      |  |   |       |                                   |
| Tj = - 7 °C  |   | 11.0     | kW   | Tj = - 7 °C  |   | 2.4   | %                                 |
| Tj = + 2 °C  |   | 6.7      | kW   | Tj = + 2 °C  |   | 3.6   | %                                 |
| Tj = + 7 °C  |   | 4.3      | kW   | Tj = + 7 °C  |   | 5.4   | %                                 |
| Tj = + 12 °C   |   | 4.5      | kW   | Tj = + 12 °C   | COP <sub>d</sub> or GUE <sub>h,bin</sub> / AEF <sub>h,bin</sub> | 6.6   | %                                 |
| T <sub>bw</sub> = bivalent temperature   | P <sub>th</sub>   | 12.5     | kW   | T <sub>bw</sub> = bivalent temperature   |   | 2.2   | %                                 |
| T <sub>ol</sub> = operation limit  |   | 9.3      | kW   | T <sub>ol</sub> = operation limit  |   | 1.8   | %                                 |
| For air-to-water heat pumps: Tj = - 15 °C (if T <sub>ol</sub> < - 20 °C)                       |   | -        | kW   | For water-to-air heat pumps: Tj = - 15 °C (if T <sub>ol</sub> < - 20 °C)   |   | -     | %                                 |
| Bivalent temperature   | T <sub>bw</sub>   | -10      | °C   | For water-to-air heat pumps: Operation limit temperature   | T <sub>ol</sub>   | -20   | °C                                |
| Degradation co- efficient heat pumps**   | C <sub>th</sub>   | 0.25     | -    |  |   |       |                                   |
| Power consumption in modes other than 'active mode'  |   |          |      |  |   |       |                                   |
| Off mode   | P <sub>off</sub>  | 0.015    | kW   | back-up heating capacity *   | elbu  | 0.0   | kW                                |
| Thermostat-off mode  | P <sub>to</sub>   | 0.000    | kW   | Type of energy input   |   |       |                                   |
| Crankcase heater mode  | P <sub>ck</sub>   | 0.000    | kW   | Standby mode   | P <sub>sb</sub>   | 0.015 | kW                                |
| Other items  |   |          |      |  |   |       |                                   |
| Capacity control   |   | variable |      | For air-to-air heat pumps: air flow rate, outdoor  |   | 6600  | m <sup>3</sup> /h                 |
| Sound power level, outdoor   | L <sub>WA</sub>   | 70.0     | dB   | For water-/brine-to-air heat pumps: Rated brine or water flow rate, outdoor side heat exchanger  |   | -     | m <sup>3</sup> /h                 |
| Sound power level, indoor  | L <sub>WA</sub>   | 54.0     | dB   | Emissions of nitrogen oxides (if applicable)   | NO <sub>x</sub> ***   | -     | mg/kWh fuel input GCV             |
|  |   |          |      | GWP of the refrigerant   |   | 2088  | kg CO <sub>2</sub> eq (100 years) |
| Contact details  | Panasonic Testing Centre, Panasonic Marketing Europe GmbH Winsberg 15, 22525 Hamburg, Germany |          |      |  |   |       |                                   |

\*\* If C<sub>th</sub> is not determined by measurement then the default degradation coefficient of heat pumps shall be 0.25.

\*\*\* from 26 September 2018.

Where information relates to multi-split heat pumps, the test result and performance data may be obtained on the basis of the performance of the outdoor unit, with a combination of indoor unit(s) recommended by the manufacturer or importer.





Information requirements for air-to-air air conditioners

Model(s): Outdoor Unit U-140PE1E8A X3  
 Indoor Unit S-50PT2E5A  
 Outdoor side heat exchanger of air conditioner:  
 Indoor side heat exchanger of air conditioner:  
 Type: compressor driven vapour compression or sorption process  
 if applicable: driver of compressor: [electric motor or fuel driven, gaseous or liquid fuel, internal or external combustion engine]  
 electric motor

| Item   | Symbol   | Value    | Unit | Item  | Symbol  | Value | Unit                              |
|--|--|----------|------|---|---|-------|-----------------------------------|
| Rated cooling capacity   | $P_{rated,c}$  | 14.0     | kW   | Seasonal space cooling energy efficiency  | $\eta_{s,c}$  | 221.5 | %                                 |
| Refrigeration load   | $P_{design,c}$   | 14.0     | kW   |   |   |       |                                   |
| Declared cooling capacity for part load at given outdoor temperatures $T_j$ and indoor 27°/19°C (dry/wet bulb)                             |  |          |      |   |   |       |                                   |
|  |  | 14.0     | kW   | $T_j = +35\text{ °C}$   |   | 3.0   | %                                 |
|  |  | 10.3     | kW   | $T_j = +30\text{ °C}$   | EER <sub>d</sub> or GUE <sub>a,bin</sub> /                      | 4.0   | %                                 |
|  | $P_{dc}$   | 6.6      | kW   | $T_j = +25\text{ °C}$   | AEF <sub>c,bin</sub>  | 6.5   | %                                 |
|  |  | 5.1      | kW   | $T_j = +20\text{ °C}$   |   | 10.2  | %                                 |
| Degradation co- efficient for air conditioners**   | $C_{dc}$   | 0.25     | -    |   |   |       |                                   |
| Declared energy efficiency ratio or gas utilization efficiency / auxiliary energy factor for part load at given outdoor temperatures $T_j$ |  |          |      |   |   |       |                                   |
|  |  | 12.3     | kW   | $T_j = -7\text{ °C}$  |   | 2.3   | %                                 |
|  |  | 7.5      | kW   | $T_j = +2\text{ °C}$  |   | 3.5   | %                                 |
|  |  | 4.8      | kW   | $T_j = +7\text{ °C}$  |   | 5.3   | %                                 |
|  |  | 4.6      | kW   | $T_j = +12\text{ °C}$   |   | 6.6   | %                                 |
|  | $P_{bh}$   | 12.3     | kW   | $T_{bh} = \text{bivalent temperature}$  | COP <sub>d</sub> or GUE <sub>h,bin</sub> / AEF <sub>h,bin</sub> | 2.3   | %                                 |
|  |  | 9.5      | kW   | $T_{ol} = \text{operation limit}$   |   | 1.7   | %                                 |
|  |  | -        | kW   | For air-to-water heat pumps: $T_j = -15\text{ °C}$ (if $T_{ol} < -20\text{ °C}$ ) |   | -     | %                                 |
| Bivalent temperature   | $T_{bh}$   | -7       | °C   | For water-to-air heat pumps: Operation limit temperature                          | $T_{ol}$  | -20   | °C                                |
| Degradation co- efficient heat pumps**   | $C_{dh}$   | 0.25     | -    |   |   |       |                                   |
| Power consumption in modes other than 'active mode'  |  |          |      |   |   |       |                                   |
| Off mode   | $P_{off}$  | 0.015    | kW   | Crankcase heater mode   | $P_{c,k}$   | 0.000 | kW                                |
| Thermostat-off mode  | $P_{to}$   | 0.000    | kW   | Standby mode  | $P_{s,b}$   | 0.015 | kW                                |
| Other items  |  |          |      |   |   |       |                                   |
| Capacity control   |  | variable |      | For air-to-air conditioner: air flow rate, outdoor                                |   | 8100  | m³/h                              |
| Sound power level, outdoor   | $L_{WA}$   | 71.0     | dB   |   |   |       |                                   |
| Sound power level, indoor  | $L_{WA}$   | 55.0     | dB   | if engine driven: Emissions of nitrogen oxides                                    | NO <sub>x</sub> ***   | -     | mg/kWh fuel input GCV             |
|  |  |          |      | GWP of the refrigerant  |   | 2088  | kg CO <sub>2</sub> eq (100 years) |
| Contact details  | Panasonic Testing Centre, Panasonic Marketing Europe GmbH Winsbergiring 15, 22525 Hamburg, Germany |          |      |   |   |       |                                   |

\*\* If  $C_{dc}$  is not determined by measurement then the default degradation coefficient air conditioners shall be 0.25.  
 \*\*\* from 26 September 2018.  
 Where information relates to multi-split air conditioners, the test result and performance data may be obtained on the basis of the performance of the outdoor unit, with a combination of indoor unit(s) recommended by the manufacturer or importer.

Information requirements for heat pumps

Model(s): Outdoor Unit U-140PE1E8A X3  
 Indoor Unit S-50PT2E5A  
 Outdoor side heat exchanger of heat pump:  
 Indoor side heat exchanger of heat pump:  
 Indication if the heater is equipped with a supplementary heater:  
 if applicable: driver of compressor: [electric motor or fuel driven, gaseous or liquid fuel, internal or external combustion engine]  
 electric motor  
 Parameters shall be declared for the average heating season, parameters for the warmer and colder heating seasons are optional.

| Item  | Symbol   | Value    | Unit | Item  | Symbol  | Value | Unit                              |
|---|--|----------|------|---|---|-------|-----------------------------------|
| Rated heating capacity  | $P_{rated,h}$  | 16.0     | kW   | Seasonal space heating energy efficiency  | $\eta_{h,h}$  | 145.5 | %                                 |
| Refrigeration load  | $P_{design,h}$   | 14.0     | kW   |   |   |       |                                   |
| Declared heating capacity for part load at indoor temperature 20 °C and outdoor temperature $T_j$ |  |          |      |   |   |       |                                   |
|   |  | 12.3     | kW   | $T_j = -7\text{ °C}$  |   | 2.3   | %                                 |
|   |  | 7.5      | kW   | $T_j = +2\text{ °C}$  |   | 3.5   | %                                 |
|   |  | 4.8      | kW   | $T_j = +7\text{ °C}$  |   | 5.3   | %                                 |
|   |  | 4.6      | kW   | $T_j = +12\text{ °C}$   |   | 6.6   | %                                 |
|   | $P_{dh}$   | 12.3     | kW   | $T_{bh} = \text{bivalent temperature}$  | COP <sub>d</sub> or GUE <sub>h,bin</sub> / AEF <sub>h,bin</sub> | 2.3   | %                                 |
|   |  | 9.5      | kW   | $T_{ol} = \text{operation limit}$   |   | 1.7   | %                                 |
|   |  | -        | kW   | For water-to-air heat pumps: $T_j = -15\text{ °C}$ (if $T_{ol} < -20\text{ °C}$ )               |   | -     | %                                 |
| Bivalent temperature  | $T_{bh}$   | -7       | °C   | For water-to-air heat pumps: Operation limit temperature  | $T_{ol}$  | -20   | °C                                |
| Degradation co- efficient heat pumps**  | $C_{dh}$   | 0.25     | -    |   |   |       |                                   |
| Power consumption in modes other than 'active mode'   |  |          |      |   |   |       |                                   |
| Off mode  | $P_{off}$  | 0.015    | kW   | Supplementary heater back-up heating capacity*  | eibu  | 2.4   | kW                                |
| Thermostat-off mode   | $P_{to}$   | 0.000    | kW   | Type of energy input  |   |       |                                   |
| Crankcase heater mode   | $P_{c,k}$  | 0.000    | kW   | Standby mode  | $P_{s,b}$   | 0.015 | kW                                |
| Other items   |  |          |      |   |   |       |                                   |
| Capacity control  |  | variable |      | For air-to-air heat pumps: air flow rate, outdoor   |   | 7200  | m³/h                              |
| Sound power level, outdoor  | $L_{WA}$   | 71.0     | dB   | For water-/brine-to-air heat pumps: Rated brine or water flow rate, outdoor side heat exchanger |   | -     | m³/h                              |
| Sound power level, indoor   | $L_{WA}$   | 55.0     | dB   | Emissions of nitrogen oxides (if applicable)  | NO <sub>x</sub> ***   | -     | mg/kWh fuel input GCV             |
|   |  |          |      | GWP of the refrigerant  |   | 2088  | kg CO <sub>2</sub> eq (100 years) |
| Contact details   | Panasonic Testing Centre, Panasonic Marketing Europe GmbH Winsbergiring 15, 22525 Hamburg, Germany |          |      |   |   |       |                                   |

\*\* If  $C_{dh}$  is not determined by measurement then the default degradation coefficient of heat pumps shall be 0.25.  
 \*\*\* from 26 September 2018.  
 Where information relates to multi-split heat pumps, the test result and performance data may be obtained on the basis of the performance of the outdoor unit, with a combination of indoor unit(s) recommended by the manufacturer or importer.

## Information requirements for air-to-air air conditioners

|  |  |                             |  |    |  |
|--|--|-----------------------------|--|----|--|
| Model(s):  |  | Outdoor Unit<br>Indoor Unit |  | X2 |  |
|  |  | U-125PE1E8A<br>S-60PT2E5A   |  |    |  |
| Outdoor side heat exchanger of air conditioner:  |  |                             |  |    |  |
| Indoor side heat exchanger of air conditioner:   |  |                             |  |    |  |
| Type: compressor driven vapour compression or sorption process   |  |                             |  |    |  |
| if applicable: driver of compressor: [electric motor or fuel driven, gaseous or liquid fuel, internal or external combustion engine] |  |                             |  |    |  |
| electric motor   |  |                             |  |    |  |

| Item  | Symbol   | Value    | Unit | Item   | Symbol       | Value | Unit                              |
|---|--|----------|------|--|--------------|-------|-----------------------------------|
| Rated cooling capacity                              | $P_{rated,c}$  | 12.5     | kW   | Seasonal space cooling energy efficiency   | $\eta_{s,c}$ | 240.0 | %                                 |
| Refrigeration load                                  | $P_{design,c}$   | 12.5     | kW   | Declared energy efficiency ratio or gas utilization efficiency / auxiliary energy factor for part load at given outdoor temperatures T <sub>J</sub> and indoor 27°/19°C (dry/wet bulb) |              |       |                                   |
| T <sub>J</sub> = + 35 °C                            |  |          |      | T <sub>J</sub> = + 35 °C   |              |       |                                   |
| T <sub>J</sub> = + 30 °C                            |  |          |      | T <sub>J</sub> = + 30 °C   |              |       |                                   |
| T <sub>J</sub> = + 25 °C                            |  |          |      | T <sub>J</sub> = + 25 °C   |              |       |                                   |
| T <sub>J</sub> = + 20 °C                            |  |          |      | T <sub>J</sub> = + 20 °C   |              |       |                                   |
| Degradation co- efficient for air conditioners**    | $C_{dc}$   | 0.25     | -    |  |              |       |                                   |
|   |  |          |      |  |              |       |                                   |
|   |  |          |      |  |              |       |                                   |
|   |  |          |      |  |              |       |                                   |
| Power consumption in modes other than 'active mode' |  |          |      |  |              |       |                                   |
| Off mode  | $P_{off}$  | 0.015    | kW   | Crankcase heater mode  | $P_{ck}$     | 0.000 | kW                                |
| Thermostat-off mode                                 | $P_{to}$   | 0.000    | kW   | Standby mode   | $P_{sb}$     | 0.015 | kW                                |
| Other items   |  |          |      |  |              |       |                                   |
| Capacity control                                    |  | variable |      | For air-to-air conditioner: air flow rate, outdoor   |              | 7800  | m <sup>3</sup> /h                 |
| Sound power level, outdoor                          | $L_{WA}$   | 70.0     | dB   |  |              |       |                                   |
| Sound power level, indoor                           | $L_{WA}$   | 56.0     | dB   | if engine driven: Emissions of nitrogen oxides   | $NO_x^{***}$ | -     | mg/kWh fuel input GCV             |
|   |  |          |      | GWP of the refrigerant   |              | 2088  | kg CO <sub>2</sub> eq (100 years) |
| Contact details                                     | Panasonic Testing Centre, Panasonic Marketing Europe GmbH Winsbergiring 15, 22525 Hamburg, Germany |          |      |  |              |       |                                   |

\*\* If  $C_{dc}$  is not determined by measurement then the default degradation coefficient air conditioners shall be 0.25.  
\*\*\* from 26 September 2018.

Where information relates to multi-split air conditioners, the test result and performance data may be obtained on the basis of the performance of the outdoor unit, with a combination of indoor unit(s) recommended by the manufacturer or importer.

## Information requirements for heat pumps

|  |  |                             |  |    |  |
|--|--|-----------------------------|--|----|--|
| Model(s):  |  | Outdoor Unit<br>Indoor Unit |  | X2 |  |
|  |  | U-125PE1E8A<br>S-60PT2E5A   |  |    |  |
| Outdoor side heat exchanger of heat pump:  |  |                             |  |    |  |
| Indoor side heat exchanger of heat pump:   |  |                             |  |    |  |
| Indication if the heater is equipped with a supplementary heater:  |  |                             |  |    |  |
| if applicable: driver of compressor: [electric motor or fuel driven, gaseous or liquid fuel, internal or external combustion engine] |  |                             |  |    |  |
| Parameters shall be declared for the average heating season, parameters for the warmer and colder heating seasons are optional.      |  |                             |  |    |  |
| electric motor   |  |                             |  |    |  |

| Item   | Symbol   | Value    | Unit | Item   | Symbol                    | Value | Unit                              |
|--|--|----------|------|--|---------------------------|-------|-----------------------------------|
| Rated heating capacity   | $P_{rated,h}$  | 14.0     | kW   | Seasonal space heating energy efficiency   | $\eta_{s,h}$              | 150.1 | %                                 |
| Refrigeration load   | $P_{design,h}$   | 12.5     | kW   | Declared coefficient of performance or gas utilization efficiency / auxiliary energy factor for part load at given outdoor temperatures T <sub>J</sub> |                           |       |                                   |
| T <sub>J</sub> = - 7 °C  |  |          |      | T <sub>J</sub> = - 7 °C  |                           |       |                                   |
| T <sub>J</sub> = + 2 °C  |  |          |      | T <sub>J</sub> = + 2 °C  |                           |       |                                   |
| T <sub>J</sub> = + 7 °C  |  |          |      | T <sub>J</sub> = + 7 °C  |                           |       |                                   |
| T <sub>J</sub> = + 12 °C   |  |          |      | T <sub>J</sub> = + 12 °C   |                           |       |                                   |
| $T_{bv}$ = bivalent temperature  | $P_{bh}$   | 12.5     | kW   | $T_{bv}$ = bivalent temperature  | $GUE_{h,bn} / AEF_{h,bn}$ | 2.2   | %                                 |
| $T_{ol}$ = operation limit   |  | 9.3      | kW   | $T_{ol}$ = operation limit   |                           | 1.8   | %                                 |
| For air-to-water heat pumps: T <sub>J</sub> = - 15 °C (if T <sub>ol</sub> < - 20 °C) |  | -        | kW   | For water-to-air heat pumps: T <sub>J</sub> = - 15 °C (if T <sub>ol</sub> < - 20 °C)   |                           | -     | %                                 |
| Bivalent temperature   | $T_{bv}$   | -10      | °C   | For water-to-air heat pumps: Operation limit temperature   | $T_{ol}$                  | -20   | °C                                |
| Degradation co- efficient heat pumps**   | $C_{dh}$   | 0.25     | -    | Supplementary heater   |                           |       |                                   |
| Power consumption in modes other than 'active mode'                                  |  |          |      |  |                           |       |                                   |
| Off mode   | $P_{off}$  | 0.015    | kW   | back-up heating capacity *   | $e_{ibu}$                 | 0.0   | kW                                |
| Thermostat-off mode  | $P_{to}$   | 0.000    | kW   | Type of energy input   |                           |       |                                   |
| Crankcase heater mode  | $P_{ck}$   | 0.000    | kW   | Standby mode   | $P_{sb}$                  | 0.015 | kW                                |
| Other items  |  |          |      |  |                           |       |                                   |
| Capacity control   |  | variable |      | For air-to-air heat pumps: air flow rate, outdoor  |                           | 6600  | m <sup>3</sup> /h                 |
| Sound power level, outdoor   | $L_{WA}$   | 70.0     | dB   | For water-/brine-to-air heat pumps: Rated brine or water flow rate, outdoor side heat exchanger  |                           | -     | m <sup>3</sup> /h                 |
| Sound power level, indoor  | $L_{WA}$   | 56.0     | dB   | Emissions of nitrogen oxides (if applicable)   | $NO_x^{***}$              | -     | mg/kWh fuel input GCV             |
|  |  |          |      | GWP of the refrigerant   |                           | 2088  | kg CO <sub>2</sub> eq (100 years) |
| Contact details  | Panasonic Testing Centre, Panasonic Marketing Europe GmbH Winsbergiring 15, 22525 Hamburg, Germany |          |      |  |                           |       |                                   |

\*\* If  $C_{dh}$  is not determined by measurement then the default degradation coefficient of heat pumps shall be 0.25.  
\*\*\* from 26 September 2018.

Where information relates to multi-split heat pumps, the test result and performance data may be obtained on the basis of the performance of the outdoor unit, with a combination of indoor unit(s) recommended by the manufacturer or importer.



## Information requirements for air-to-air air conditioners

|  |  |                             |  |                            |  |
|--|--|-----------------------------|--|----------------------------|--|
| Model(s):  |  | Outdoor Unit<br>Indoor Unit |  | U-125PE1E8A<br>S-125PT2E5A |  |
| Outdoor side heat exchanger of air conditioner:  |  | air                         |  |                            |  |
| Indoor side heat exchanger of air conditioner:   |  | air                         |  |                            |  |
| Type: compressor driven vapour compression or sorption process   |  | vapour compression          |  |                            |  |
| if applicable: driver of compressor: [electric motor or fuel driven, gaseous or liquid fuel, internal or external combustion engine] |  | electric motor              |  |                            |  |

| Item  | Symbol  | Value    | Unit | Item   | Symbol  | Value | Unit                              |
|---|---|----------|------|--|---|-------|-----------------------------------|
| Rated cooling capacity  | $P_{rated,c}$   | 12.5     | kW   | Seasonal space cooling energy efficiency   | $\eta_{s,c}$  | 226.7 | %                                 |
| Refrigeration load  | $P_{design,c}$  | 12.5     | kW   | Declared energy efficiency ratio or gas utilization efficiency / auxiliary energy factor for part load at given outdoor temperatures T <sub>J</sub> and indoor 27°/19°C (dry/wet bulb) |   |       |                                   |
| Declared cooling capacity for part load at given outdoor temperatures T <sub>J</sub> and indoor 27°/19°C (dry/wet bulb) |   |          |      |  |   |       |                                   |
| T <sub>J</sub> = + 35 °C  |   | 12.5     | kW   | T <sub>J</sub> = + 35 °C   |   | 3.3   | %                                 |
| T <sub>J</sub> = + 30 °C  |   | 9.2      | kW   | T <sub>J</sub> = + 30 °C   | EER <sub>d</sub> or GUE <sub>c,dbn</sub> /                      | 4.4   | %                                 |
| T <sub>J</sub> = + 25 °C  |   | 5.9      | kW   | T <sub>J</sub> = + 25 °C   | AEF <sub>c,dbn</sub>  | 7.3   | %                                 |
| T <sub>J</sub> = + 20 °C  |   | 5.0      | kW   | T <sub>J</sub> = + 20 °C   |   | 10.3  | %                                 |
| Degradation co- efficient for air conditioners**  | $C_{dc}$  | 0.25     | -    |  |   |       |                                   |
| Declared heating capacity for part load at indoor temperature 20 °C and outdoor temperature T <sub>J</sub>              |   |          |      |  |   |       |                                   |
| T <sub>J</sub> = - 7 °C   |   | 11.0     | kW   | T <sub>J</sub> = - 7 °C  |   | 2.4   | %                                 |
| T <sub>J</sub> = + 2 °C   |   | 6.7      | kW   | T <sub>J</sub> = + 2 °C  |   | 3.6   | %                                 |
| T <sub>J</sub> = + 7 °C   |   | 4.3      | kW   | T <sub>J</sub> = + 7 °C  |   | 5.4   | %                                 |
| T <sub>J</sub> = + 12 °C  |   | 4.5      | kW   | T <sub>J</sub> = + 12 °C   |   | 6.6   | %                                 |
| T <sub>bw</sub> = bivalent temperature  | $P_{bh}$  | 12.5     | kW   | T <sub>bw</sub> = bivalent temperature   | COP <sub>d</sub> or GUE <sub>c,dbn</sub> / AEF <sub>c,dbn</sub> | 2.2   | %                                 |
| T <sub>ol</sub> = operation limit   |   | 9.8      | kW   | T <sub>ol</sub> = operation limit  |   | 1.8   | %                                 |
| For air-to-water heat pumps: T <sub>J</sub> = - 15 °C (if T <sub>ol</sub> < - 20 °C)                                    |   | -        | kW   | For water-to-air heat pumps: T <sub>J</sub> = - 15 °C (if T <sub>ol</sub> < - 20 °C)   |   | -     | %                                 |
| Bivalent temperature  | T <sub>bw</sub>   | -10      | °C   | For water-to-air heat pumps: Operation limit temperature   | T <sub>ol</sub>   | -20   | °C                                |
| Degradation co- efficient heat pumps**  | $C_{dh}$  | 0.25     | -    |  |   |       |                                   |
| Power consumption in modes other than 'active mode'   |   |          |      |  |   |       |                                   |
| Off mode  | $P_{off}$   | 0.020    | kW   | Crankcase heater mode  | $P_{ck}$  | 0.000 | kW                                |
| Thermostat-off mode   | $P_{to}$  | 0.101    | kW   | Standby mode   | $P_{sb}$  | 0.020 | kW                                |
| Other items   |   |          |      |  |   |       |                                   |
| Capacity control  |   | variable |      | For air-to-air air conditioner: air flow rate, outdoor   |   | 7800  | m <sup>3</sup> /h                 |
| Sound power level, outdoor  | L <sub>WA</sub>   | 70.0     | dB   |  |   |       |                                   |
| Sound power level, indoor   | L <sub>WA</sub>   | 64.0     | dB   | if engine driven: Emissions of nitrogen oxides   | NO <sub>x</sub> ***   | -     | mg/kWh fuel input GCV             |
|   |   |          |      | GWP of the refrigerant   |   | 2088  | kg CO <sub>2</sub> eq (100 years) |
| Contact details   | Panasonic Testing Centre, Panasonic Marketing Europe GmbH Wirsberg 15, 22525 Hamburg, Germany |          |      |  |   |       |                                   |

\*\* If  $C_{dc}$  is not determined by measurement then the default degradation coefficient air conditioners shall be 0.25.  
\*\*\* from 26 September 2018.

Where information relates to multi-split air conditioners, the test result and performance data may be obtained on the basis of the performance of the outdoor unit, with a combination of indoor unit(s) recommended by the manufacturer or importer.

## Information requirements for heat pumps

|  |  |                             |  |                            |  |
|--|--|-----------------------------|--|----------------------------|--|
| Model(s):  |  | Outdoor Unit<br>Indoor Unit |  | U-125PE1E8A<br>S-125PT2E5A |  |
| Outdoor side heat exchanger of heat pump:  |  | air                         |  |                            |  |
| Indoor side heat exchanger of heat pump:   |  | air                         |  |                            |  |
| Indication if the heater is equipped with a supplementary heater:  |  | no                          |  |                            |  |
| if applicable: driver of compressor: [electric motor or fuel driven, gaseous or liquid fuel, internal or external combustion engine] |  | electric motor              |  |                            |  |

Parameters shall be declared for the average heating season, parameters for the warmer and colder heating seasons are optional.

| Item   | Symbol  | Value    | Unit | Item   | Symbol  | Value | Unit                              |
|--|---|----------|------|--|---|-------|-----------------------------------|
| Rated heating capacity   | $P_{rated,h}$   | 14.0     | kW   | Seasonal space heating energy efficiency   | $\eta_{s,h}$  | 149.5 | %                                 |
| Refrigeration load   | $P_{design,h}$  | 12.5     | kW   | Declared coefficient of performance or gas utilization efficiency / auxiliary energy factor for part load at given outdoor temperatures T <sub>J</sub> |   |       |                                   |
| Declared heating capacity for part load at indoor temperature 20 °C and outdoor temperature T <sub>J</sub> |   |          |      |  |   |       |                                   |
| T <sub>J</sub> = - 7 °C  |   | 11.0     | kW   | T <sub>J</sub> = - 7 °C  |   | 2.4   | %                                 |
| T <sub>J</sub> = + 2 °C  |   | 6.7      | kW   | T <sub>J</sub> = + 2 °C  |   | 3.6   | %                                 |
| T <sub>J</sub> = + 7 °C  |   | 4.3      | kW   | T <sub>J</sub> = + 7 °C  |   | 5.4   | %                                 |
| T <sub>J</sub> = + 12 °C   |   | 4.5      | kW   | T <sub>J</sub> = + 12 °C   |   | 6.6   | %                                 |
| T <sub>bw</sub> = bivalent temperature   | $P_{bh}$  | 12.5     | kW   | T <sub>bw</sub> = bivalent temperature   | COP <sub>d</sub> or GUE <sub>c,dbn</sub> / AEF <sub>c,dbn</sub> | 2.2   | %                                 |
| T <sub>ol</sub> = operation limit  |   | 9.8      | kW   | T <sub>ol</sub> = operation limit  |   | 1.8   | %                                 |
| For air-to-water heat pumps: T <sub>J</sub> = - 15 °C (if T <sub>ol</sub> < - 20 °C)                       |   | -        | kW   | For water-to-air heat pumps: T <sub>J</sub> = - 15 °C (if T <sub>ol</sub> < - 20 °C)   |   | -     | %                                 |
| Bivalent temperature   | T <sub>bw</sub>   | -10      | °C   | For water-to-air heat pumps: Operation limit temperature   | T <sub>ol</sub>   | -20   | °C                                |
| Degradation co- efficient heat pumps**   | $C_{dh}$  | 0.25     | -    |  |   |       |                                   |
| Power consumption in modes other than 'active mode'  |   |          |      |  |   |       |                                   |
| Off mode   | $P_{off}$   | 0.020    | kW   | Supplementary heater back-up heating capacity*   | elbu  | 0.0   | kW                                |
| Thermostat-off mode  | $P_{to}$  | 0.101    | kW   | Type of energy input   |   |       |                                   |
| Crankcase heater mode  | $P_{ck}$  | 0.000    | kW   | Standby mode   | $P_{sb}$  | 0.020 | kW                                |
| Other items  |   |          |      |  |   |       |                                   |
| Capacity control   |   | variable |      | For air-to-air heat pumps: air flow rate, outdoor  |   | 6600  | m <sup>3</sup> /h                 |
| Sound power level, outdoor   | L <sub>WA</sub>   | 70.0     | dB   | For water-/brine-to-air heat pumps: Rated brine or water flow rate, outdoor side heat exchanger  |   | -     | m <sup>3</sup> /h                 |
| Sound power level, indoor  | L <sub>WA</sub>   | 64.0     | dB   | Emissions of nitrogen oxides (if applicable)   | NO <sub>x</sub> ***   | -     | mg/kWh fuel input GCV             |
|  |   |          |      | GWP of the refrigerant   |   | 2088  | kg CO <sub>2</sub> eq (100 years) |
| Contact details  | Panasonic Testing Centre, Panasonic Marketing Europe GmbH Wirsberg 15, 22525 Hamburg, Germany |          |      |  |   |       |                                   |

\*\* If  $C_{dh}$  is not determined by measurement then the default degradation coefficient of heat pumps shall be 0.25.  
\*\*\* from 26 September 2018.

Where information relates to multi-split heat pumps, the test result and performance data may be obtained on the basis of the performance of the outdoor unit, with a combination of indoor unit(s) recommended by the manufacturer or importer.



## Information requirements for air-to-air air conditioners

|  |                             |                              |
|--|-----------------------------|------------------------------|
| Model(s):  | Outdoor Unit<br>Indoor Unit | U-125PE1E5A<br>S-36PF1E5A x4 |
| Outdoor side heat exchanger of air conditioner:  | air                         |                              |
| Indoor side heat exchanger of air conditioner:   | air                         |                              |
| Type: compressor driven vapour compression or sorption process   | vapour compression          |                              |
| if applicable: driver of compressor: [electric motor or fuel driven, gaseous or liquid fuel, internal or external combustion engine] | electric motor              |                              |

| Item  | Symbol   | Value    | Unit | Item  | Symbol                 | Value | Unit                              |
|---|--|----------|------|---|------------------------|-------|-----------------------------------|
| Rated cooling capacity                              | $P_{\text{elec,c}}$  | 12.5     | kW   | Seasonal space cooling energy efficiency  | $\eta_{\text{h,c}}$    | 234.1 | %                                 |
| Refrigeration load                                  | $P_{\text{design,c}}$  | 12.5     | kW   | Declared energy efficiency ratio or gas utilization efficiency / auxiliary energy factor for part load at given outdoor temperatures $T_j$ and indoor 27°/19°C (dry/wet bulb) |                        |       |                                   |
|   |  | 12.5     | kW   | $T_j = +35\text{ °C}$   |                        | 3.5   | %                                 |
|   |  | 9.2      | kW   | $T_j = +30\text{ °C}$   | EER <sub>d</sub> of    | 4.9   | %                                 |
|   |  | 5.9      | kW   | $T_j = +25\text{ °C}$   | GUE <sub>c,bln</sub> / | 7.3   | %                                 |
|   |  | 5.1      | kW   | $T_j = +20\text{ °C}$   | AEF <sub>c,bln</sub>   | 9.9   | %                                 |
| Degradation co-efficient for air conditioners**     | $C_{\text{dc}}$  | 0.25     | -    | Declared heating capacity for part load at indoor temperature 20 °C and outdoor temperature $T_j$   |                        |       |                                   |
|   |  |          |      | $T_j = -7\text{ °C}$  |                        | 11.0  | kW                                |
|   |  |          |      | $T_j = +2\text{ °C}$  |                        | 6.7   | kW                                |
|   |  |          |      | $T_j = +7\text{ °C}$  |                        | 4.3   | kW                                |
|   |  |          |      | $T_j = +12\text{ °C}$   |                        | 4.4   | kW                                |
|   |  |          |      | $T_{\text{bv}}$ = bivalent temperature  | $P_{\text{th}}$        | 12.0  | kW                                |
|   |  |          |      | $T_{\text{ol}}$ = operation limit   |                        | 9.8   | kW                                |
|   |  |          |      | For air-to-water heat pumps:<br>$T_j = -15\text{ °C}$ (if $T_{\text{ol}} < -20\text{ °C}$ )   |                        | -     | kW                                |
|   |  |          |      | Bivalent temperature  | $T_{\text{bv}}$        | -9    | °C                                |
|   |  |          |      | Degradation co-efficient heat pumps**   | $C_{\text{th}}$        | 0.25  | -                                 |
| Power consumption in modes other than 'active mode' |  |          |      |   |                        |       |                                   |
| Off mode  | $P_{\text{off}}$   | 0.021    | kW   | Crankcase heater mode   | $P_{\text{ck}}$        | 0.000 | kW                                |
| Thermostat-off mode                                 | $P_{\text{to}}$  | 0.090    | kW   | Standby mode  | $P_{\text{sb}}$        | 0.021 | kW                                |
| Other items   |  |          |      |   |                        |       |                                   |
| Capacity control                                    |  | variable |      | For air-to-air air conditioner: air flow rate, outdoor  |                        | 7800  | m³/h                              |
| Sound power level, outdoor                          | $L_{\text{WA}}$  | 70.0     | dB   |   |                        |       |                                   |
| Sound power level, indoor                           | $L_{\text{WA}}$  | 55.0     | dB   | if engine driven: Emissions of nitrogen oxides  | $\text{NO}_x^{***}$    | -     | mg/kWh fuel input GCV             |
|   |  |          |      | GWP of the refrigerant  |                        | 2088  | kg CO <sub>2</sub> eq (100 years) |
| Contact details                                     | Panasonic Testing Centre, Panasonic Marketing Europe GmbH Winsbergweg 15, 22525 Hamburg, Germany |          |      |   |                        |       |                                   |

\*\* If  $C_{\text{dc}}$  is not determined by measurement then the default degradation coefficient air conditioners shall be 0.25.

\*\*\* from 26 September 2018.

Where information relates to multi-split air conditioners, the test result and performance data may be obtained on the basis of the performance of the outdoor unit, with a combination of indoor unit(s) recommended by the manufacturer or importer.

\*\*\*\* Refer to Information requirements for UnitList

## Information requirements for heat pumps

|  |                             |                              |
|--|-----------------------------|------------------------------|
| Model(s):  | Outdoor Unit<br>Indoor Unit | U-125PE1E5A<br>S-36PF1E5A x4 |
| Outdoor side heat exchanger of heat pump:  | air                         |                              |
| Indoor side heat exchanger of heat pump:   | air                         |                              |
| Indication if the heater is equipped with a supplementary heater:  | no                          |                              |
| if applicable: driver of compressor: [electric motor or fuel driven, gaseous or liquid fuel, internal or external combustion engine] | electric motor              |                              |

Parameters shall be declared for the average heating season, parameters for the warmer and colder heating seasons are optional.

| Item  | Symbol   | Value    | Unit | Item  | Symbol  | Value | Unit                              |
|---|--|----------|------|---|---|-------|-----------------------------------|
| Rated heating capacity                              | $P_{\text{rated,h}}$   | 14.0     | kW   | Seasonal space heating energy efficiency  | $\eta_{\text{h,h}}$   | 146.6 | %                                 |
| Refrigeration load                                  | $P_{\text{design,h}}$  | 12.5     | kW   | Declared coefficient of performance or gas utilization efficiency / auxiliary energy factor for part load at given outdoor temperatures $T_j$ |   |       |                                   |
|   |  |          |      | $T_j = -7\text{ °C}$  |   | 2.4   | %                                 |
|   |  |          |      | $T_j = +2\text{ °C}$  |   | 3.6   | %                                 |
|   |  |          |      | $T_j = +7\text{ °C}$  |   | 5.1   | %                                 |
|   |  |          |      | $T_j = +12\text{ °C}$   |   | 6.1   | %                                 |
|   |  |          |      | $T_{\text{bv}}$ = bivalent temperature  | COP <sub>d</sub> or GUE <sub>h,bln</sub> / AEF <sub>h,bln</sub> | 2.2   | %                                 |
|   |  |          |      | $T_{\text{ol}}$ = operation limit   |   | 1.7   | %                                 |
|   |  |          |      | For water-to-air heat pumps:<br>$T_j = -15\text{ °C}$ (if $T_{\text{ol}} < -20\text{ °C}$ )   |   | -     | %                                 |
|   |  |          |      | Bivalent temperature  | $T_{\text{bv}}$   | -20   | °C                                |
|   |  |          |      | Degradation co-efficient heat pumps**   |   |       |                                   |
| Power consumption in modes other than 'active mode' |  |          |      |   |   |       |                                   |
| Off mode  | $P_{\text{off}}$   | 0.021    | kW   | Supplementary heater  |   |       |                                   |
| Thermostat-off mode                                 | $P_{\text{to}}$  | 0.090    | kW   | back-up heating capacity*   | elbu  | 0.7   | kW                                |
| Crankcase heater mode                               | $P_{\text{ck}}$  | 0.000    | kW   | Type of energy input  |   |       |                                   |
| Other items   |  |          |      |   |   |       |                                   |
| Capacity control                                    |  | variable |      | For air-to-air heat pumps: air flow rate, outdoor   |   | 6600  | m³/h                              |
| Sound power level, outdoor                          | $L_{\text{WA}}$  | 70.0     | dB   | For water-/brine-to-air heat pumps: Rated brine or water flow rate, outdoor side heat exchanger   |   | -     | m³/h                              |
| Sound power level, indoor                           | $L_{\text{WA}}$  | 55.0     | dB   | Emissions of nitrogen oxides (if applicable)  | $\text{NO}_x^{***}$   | -     | mg/kWh fuel input GCV             |
|   |  |          |      | GWP of the refrigerant  |   | 2088  | kg CO <sub>2</sub> eq (100 years) |
| Contact details                                     | Panasonic Testing Centre, Panasonic Marketing Europe GmbH Winsbergweg 15, 22525 Hamburg, Germany |          |      |   |   |       |                                   |

\*\* If  $C_{\text{th}}$  is not determined by measurement then the default degradation coefficient of heat pumps shall be 0.25.

\*\*\* from 26 September 2018.

Where information relates to multi-split heat pumps, the test result and performance data may be obtained on the basis of the performance of the outdoor unit, with a combination of indoor unit(s) recommended by the manufacturer or importer.

\*\*\*\* Refer to Information requirements for UnitList

### Information requirements for air-to-air air conditioners

Model(s): Outdoor Unit U-125PE1E5A Indoor Unit S-45PF1E5A x3

Outdoor side heat exchanger of air conditioner:  
 Indoor side heat exchanger of air conditioner:  
 Type: compressor driven vapour compression or sorption process  
 if applicable: driver of compressor: [electric motor or fuel driven, gaseous or liquid fuel, internal or external combustion engine]

|                    |
|--------------------|
| air                |
| air                |
| vapour compression |
| electric motor     |

| Item   | Symbol   | Value    | Unit | Item   | Symbol                                   | Value | Unit                              |
|--|--|----------|------|--|--|-------|-----------------------------------|
| Rated cooling capacity   | $P_{rated,c}$  | 12.5     | kW   | Seasonal space cooling energy efficiency   | $\eta_{b,c}$                             | 234.1 | %                                 |
| Refrigeration load   | $P_{design,c}$   | 12.5     | kW   | Declared energy efficiency ratio or gas utilization efficiency / auxiliary energy factor for part load at given outdoor temperatures $T_j$ |  |       |                                   |
| Declared cooling capacity for part load at given outdoor temperatures $T_j$ and indoor 27°/19°C (dry/wet bulb) |  |          |      |  |  |       |                                   |
| $T_j = +35^\circ\text{C}$  |  | 12.5     | kW   | $T_j = +35^\circ\text{C}$  |  | 3.5   | %                                 |
| $T_j = +30^\circ\text{C}$  |  | 9.2      | kW   | $T_j = +30^\circ\text{C}$  | $EER_d$ or $GUE_{c,bln}$ / $AEF_{c,bln}$ | 4.9   | %                                 |
| $T_j = +25^\circ\text{C}$  | $P_{dc}$   | 5.9      | kW   | $T_j = +25^\circ\text{C}$  |  | 7.3   | %                                 |
| $T_j = +20^\circ\text{C}$  |  | 5.1      | kW   | $T_j = +20^\circ\text{C}$  |  | 9.9   | %                                 |
| Degradation co-efficient for air conditioners**  | $C_{dc}$   | 0.25     | -    |  |  |       |                                   |
| Power consumption in modes other than 'active mode'  |  |          |      |  |  |       |                                   |
| Off mode   | $P_{off}$  | 0.021    | kW   | Crankcase heater mode  | $P_{ck}$                                 | 0.000 | kW                                |
| Thermostat-off mode  | $P_{to}$   | 0.090    | kW   | Standby mode   | $P_{sb}$                                 | 0.021 | kW                                |
| Other items  |  |          |      |  |  |       |                                   |
| Capacity control   |  | variable |      | For air-to-air air conditioner: air flow rate, outdoor   |  | 7800  | m <sup>3</sup> /h                 |
| Sound power level, outdoor   | $L_{WA}$   | 70.0     | dB   |  |  |       |                                   |
| Sound power level, indoor  | $L_{WA}$   | 56.0     | dB   | if engine driven: Emissions of nitrogen oxides   | $NO_x^{***}$                             | -     | mg/kWh fuel input GCV             |
|  |  |          |      | GWP of the refrigerant   |  | 2088  | kg CO <sub>2</sub> eq (100 years) |
| Contact details  | Panasonic Testing Centre, Panasonic Marketing Europe GmbH Winsbergiring 15, 22525 Hamburg, Germany |          |      |  |  |       |                                   |

\*\* If  $C_{dc}$  is not determined by measurement then the default degradation coefficient air conditioners shall be 0.25.  
 \*\*\* from 26 September 2018.  
 Where information relates to multi-split air conditioners, the test result and performance data may be obtained on the basis of the performance of the outdoor unit, with a combination of indoor unit(s) recommended by the manufacturer or importer.  
 \*\*\*\* Refer to Information requirements for UnitList.

### Information requirements for heat pumps

Model(s): Outdoor Unit U-125PE1E5A Indoor Unit S-45PF1E5A x3

Outdoor side heat exchanger of heat pump:  
 Indoor side heat exchanger of heat pump:  
 Indication if the heater is equipped with a supplementary heater:  
 if applicable: driver of compressor: [electric motor or fuel driven, gaseous or liquid fuel, internal or external combustion engine]

|                |
|----------------|
| air            |
| air            |
| no             |
| electric motor |

Parameters shall be declared for the average heating season, parameters for the warmer and colder heating seasons are optional.

| Item  | Symbol   | Value    | Unit | Item  | Symbol  | Value | Unit                              |
|---|--|----------|------|---|---|-------|-----------------------------------|
| Rated heating capacity  | $P_{rated,h}$  | 14.0     | kW   | Seasonal space heating energy efficiency  | $\eta_{h,h}$                                      | 146.6 | %                                 |
| Refrigeration load  | $P_{design,h}$   | 12.5     | kW   | Declared coefficient of performance or gas utilization efficiency / auxiliary energy factor for part load at given outdoor temperatures $T_j$ |   |       |                                   |
| Declared heating capacity for part load at indoor temperature 20 °C and outdoor temperature $T_j$ |  |          |      |   |   |       |                                   |
| $T_j = -7^\circ\text{C}$  |  | 11.0     | kW   | $T_j = -7^\circ\text{C}$  |   | 2.4   | %                                 |
| $T_j = +2^\circ\text{C}$  |  | 6.7      | kW   | $T_j = +2^\circ\text{C}$  |   | 3.6   | %                                 |
| $T_j = +7^\circ\text{C}$  |  | 4.3      | kW   | $T_j = +7^\circ\text{C}$  |   | 5.1   | %                                 |
| $T_j = +12^\circ\text{C}$   |  | 4.4      | kW   | $T_j = +12^\circ\text{C}$   | COP <sub>a</sub> or $GUE_{h,bln}$ / $AEF_{h,bln}$ | 6.1   | %                                 |
| $T_{biv} = \text{bivalent temperature}$   | $P_{biv}$  | 12.0     | kW   | $T_{biv} = \text{bivalent temperature}$   |   | 2.2   | %                                 |
| $T_{ol} = \text{operation limit}$   |  | 9.8      | kW   | $T_{ol} = \text{operation limit}$   |   | 1.7   | %                                 |
| For air-to-water heat pumps: $T_j = -15^\circ\text{C}$ (if $T_{ol} < -20^\circ\text{C}$ )         |  | -        | kW   | For water-to-air heat pumps: $T_j = -15^\circ\text{C}$ (if $T_{ol} < -20^\circ\text{C}$ )   |   | -     | %                                 |
| Bivalent temperature  | $T_{biv}$  | -9       | °C   | For water-to-air heat pumps: Operation limit temperature  | $T_{ol}$  | -20   | °C                                |
| Degradation co-efficient heat pumps**   | $C_{dh}$   | 0.25     | -    |   |   |       |                                   |
| Power consumption in modes other than 'active mode'   |  |          |      |   |   |       |                                   |
| Off mode  | $P_{off}$  | 0.021    | kW   | Supplementary heater  |   |       |                                   |
| Thermostat-off mode   | $P_{to}$   | 0.090    | kW   | back-up heating capacity *  | elbu  | 0.7   | kW                                |
| Crankcase heater mode   | $P_{ck}$   | 0.000    | kW   | Type of energy input  |   |       |                                   |
|   |  |          |      | Standby mode  | $P_{sb}$  | 0.021 | kW                                |
| Other items   |  |          |      |   |   |       |                                   |
| Capacity control  |  | variable |      | For air-to-air heat pumps: air flow rate, outdoor   |   | 6600  | m <sup>3</sup> /h                 |
| Sound power level, outdoor  | $L_{WA}$   | 70.0     | dB   | For water-/brine-to-air heat pumps: Rated brine or water flow rate, outdoor side heat exchanger   |   | -     | m <sup>3</sup> /h                 |
| Sound power level, indoor   | $L_{WA}$   | 56.0     | dB   | Emissions of nitrogen oxides (if applicable)  | $NO_x^{***}$                                      | -     | mg/kWh fuel input GCV             |
|   |  |          |      | GWP of the refrigerant  |   | 2088  | kg CO <sub>2</sub> eq (100 years) |
| Contact details   | Panasonic Testing Centre, Panasonic Marketing Europe GmbH Winsbergiring 15, 22525 Hamburg, Germany |          |      |   |   |       |                                   |

\*\* If  $C_{dh}$  is not determined by measurement then the default degradation coefficient of heat pumps shall be 0.25.  
 \*\*\* from 26 September 2018.  
 Where information relates to multi-split heat pumps, the test result and performance data may be obtained on the basis of the performance of the outdoor unit, with a combination of indoor unit(s) recommended by the manufacturer or importer.  
 \*\*\*\* Refer to Information requirements for UnitList.



## Information requirements for air-to-air air conditioners

|  |                             |                              |
|--|-----------------------------|------------------------------|
| Model(s):  | Outdoor Unit<br>Indoor Unit | U-140PE1E5A<br>S-50PF1E5A x3 |
| Outdoor side heat exchanger of air conditioner:  | air                         |                              |
| Indoor side heat exchanger of air conditioner:   | air                         |                              |
| Type: compressor driven vapour compression or sorption process   | vapour compression          |                              |
| if applicable: driver of compressor: [electric motor or fuel driven, gaseous or liquid fuel, internal or external combustion engine] | electric motor              |                              |

| Item   | Symbol         | Value    | Unit | Item   | Symbol       | Value | Unit                              |
|--|----------------|----------|------|--|--------------|-------|-----------------------------------|
| Rated cooling capacity   | $P_{med,c}$    | 14.0     | kW   | Seasonal space cooling energy efficiency   | $\eta_{s,c}$ | 226.3 | %                                 |
| Refrigeration load   | $P_{design,c}$ | 14.0     | kW   |  |              |       |                                   |
| Declared cooling capacity for part load at given outdoor temperatures $T_j$ and indoor 27°/19°C (dry/wet bulb)                             |                |          |      |  |              |       |                                   |
| $T_j = +35\text{ °C}$  |                | 14.0     | kW   | $T_j = +35\text{ °C}$  |              | 3.2   | %                                 |
| $T_j = +30\text{ °C}$  |                | 10.3     | kW   | $T_j = +30\text{ °C}$  |              | 4.6   | %                                 |
| $T_j = +25\text{ °C}$  |                | 6.6      | kW   | $T_j = +25\text{ °C}$  |              | 7.0   | %                                 |
| $T_j = +20\text{ °C}$  |                | 5.1      | kW   | $T_j = +20\text{ °C}$  |              | 9.8   | %                                 |
| Degradation co-efficient for air conditioners**  | $C_{dk}$       | 0.25     | -    |  |              |       |                                   |
| Declared energy efficiency ratio or gas utilization efficiency / auxiliary energy factor for part load at given outdoor temperatures $T_j$ |                |          |      |  |              |       |                                   |
| $T_j = -7\text{ °C}$   |                | 12.3     | kW   | $T_j = -7\text{ °C}$   |              | 2.3   | %                                 |
| $T_j = +2\text{ °C}$   |                | 7.5      | kW   | $T_j = +2\text{ °C}$   |              | 3.5   | %                                 |
| $T_j = +7\text{ °C}$   |                | 4.8      | kW   | $T_j = +7\text{ °C}$   |              | 5.1   | %                                 |
| $T_j = +12\text{ °C}$  |                | 4.4      | kW   | $T_j = +12\text{ °C}$  |              | 6.0   | %                                 |
| $T_{bw} = \text{bivalent temperature}$   |                | 12.3     | kW   | $T_{bw} = \text{bivalent temperature}$   |              | 2.3   | %                                 |
| $T_{ol} = \text{operation limit}$  |                | 10.0     | kW   | $T_{ol} = \text{operation limit}$  |              | 1.7   | %                                 |
| For air-to-water heat pumps:<br>$T_j = -15\text{ °C}$ (if $T_{ol} < -20\text{ °C}$ )   |                | -        | kW   | For water-to-air heat pumps:<br>$T_j = -15\text{ °C}$ (if $T_{ol} < -20\text{ °C}$ )               |              | -     | %                                 |
| Bivalent temperature   | $T_{bw}$       | -7       | °C   | Operation limit temperature  | $T_{ol}$     | -20   | °C                                |
| Degradation co-efficient heat pumps**  | $C_{dh}$       | 0.25     | -    |  |              |       |                                   |
| Power consumption in modes other than 'active mode'  |                |          |      |  |              |       |                                   |
| Off mode   | $P_{off}$      | 0.021    | kW   | Crankcase heater mode  | $P_{ck}$     | 0.000 | kW                                |
| Thermostat-off mode  | $P_{to}$       | 0.090    | kW   | Standby mode   | $P_{sb}$     | 0.021 | kW                                |
| Other items  |                |          |      |  |              |       |                                   |
| Capacity control   |                | variable |      | For air-to-air conditioner: air flow rate, outdoor   |              | 8100  | m³/h                              |
| Sound power level, outdoor   | $L_{WA}$       | 71.0     | dB   |  |              |       |                                   |
| Sound power level, indoor  | $L_{WA}$       | 56.0     | dB   | if engine driven: Emissions of nitrogen oxides   | $NO_x^{***}$ | -     | mg/kWh fuel input GCV             |
|  |                |          |      | GWP of the refrigerant   |              | 2088  | kg CO <sub>2</sub> eq (100 years) |
| Contact details  |                |          |      | Panasonic Testing Centre, Panasonic Marketing Europe GmbH Winsberggring 15, 22525 Hamburg, Germany |              |       |                                   |

\*\* If  $C_{dk}$  is not determined by measurement then the default degradation coefficient air conditioners shall be 0.25.

\*\*\* from 26 September 2018.

Where information relates to multi-split air conditioners, the test result and performance data may be obtained on the basis of the performance of the outdoor unit, with a combination of indoor unit(s) recommended by the manufacturer or importer.

\*\*\*\* Refer to Information requirements for UnitList

## Information requirements for heat pumps

|  |                             |                              |
|--|-----------------------------|------------------------------|
| Model(s):  | Outdoor Unit<br>Indoor Unit | U-140PE1E5A<br>S-50PF1E5A x3 |
| Outdoor side heat exchanger of heat pump:  | air                         |                              |
| Indoor side heat exchanger of heat pump:   | air                         |                              |
| Indication if the heater is equipped with a supplementary heater:  | no                          |                              |
| if applicable: driver of compressor: [electric motor or fuel driven, gaseous or liquid fuel, internal or external combustion engine] | electric motor              |                              |

Parameters shall be declared for the average heating season, parameters for the warmer and colder heating seasons are optional.

| Item  | Symbol         | Value    | Unit | Item   | Symbol       | Value | Unit                              |
|---|----------------|----------|------|--|--------------|-------|-----------------------------------|
| Rated heating capacity  | $P_{med,h}$    | 16.0     | kW   | Seasonal space heating energy efficiency   | $\eta_{s,h}$ | 143.0 | %                                 |
| Refrigeration load  | $P_{design,h}$ | 14.0     | kW   |  |              |       |                                   |
| Declared heating capacity for part load at indoor temperature 20 °C and outdoor temperature $T_j$ |                |          |      |  |              |       |                                   |
| $T_j = -7\text{ °C}$  |                | 12.3     | kW   | $T_j = -7\text{ °C}$   |              | 2.3   | %                                 |
| $T_j = +2\text{ °C}$  |                | 7.5      | kW   | $T_j = +2\text{ °C}$   |              | 3.5   | %                                 |
| $T_j = +7\text{ °C}$  |                | 4.8      | kW   | $T_j = +7\text{ °C}$   |              | 5.1   | %                                 |
| $T_j = +12\text{ °C}$   |                | 4.4      | kW   | $T_j = +12\text{ °C}$  |              | 6.0   | %                                 |
| $T_{bw} = \text{bivalent temperature}$  |                | 12.3     | kW   | $T_{bw} = \text{bivalent temperature}$   |              | 2.3   | %                                 |
| $T_{ol} = \text{operation limit}$   |                | 10.0     | kW   | $T_{ol} = \text{operation limit}$  |              | 1.7   | %                                 |
| For air-to-water heat pumps:<br>$T_j = -15\text{ °C}$ (if $T_{ol} < -20\text{ °C}$ )              |                | -        | kW   | For water-to-air heat pumps:<br>$T_j = -15\text{ °C}$ (if $T_{ol} < -20\text{ °C}$ )               |              | -     | %                                 |
| Bivalent temperature  | $T_{bw}$       | -7       | °C   | Operation limit temperature  | $T_{ol}$     | -20   | °C                                |
| Degradation co-efficient heat pumps**   | $C_{dh}$       | 0.25     | -    |  |              |       |                                   |
| Power consumption in modes other than 'active mode'   |                |          |      |  |              |       |                                   |
| Off mode  | $P_{off}$      | 0.021    | kW   | back-up heating capacity*  | elbu         | 2.3   | kW                                |
| Thermostat-off mode   | $P_{to}$       | 0.090    | kW   | Type of energy input   |              |       |                                   |
| Crankcase heater mode   | $P_{ck}$       | 0.000    | kW   | Standby mode   | $P_{sb}$     | 0.021 | kW                                |
| Other items   |                |          |      |  |              |       |                                   |
| Capacity control  |                | variable |      | For air-to-air heat pumps: air flow rate, outdoor  |              | 7200  | m³/h                              |
| Sound power level, outdoor  | $L_{WA}$       | 71.0     | dB   | For water-/brine-to-air heat pumps: Rated brine or water flow rate, outdoor side heat exchanger    |              | -     | m³/h                              |
| Sound power level, indoor   | $L_{WA}$       | 56.0     | dB   | Emissions of nitrogen oxides (if applicable)   | $NO_x^{***}$ | -     | mg/kWh fuel input GCV             |
|   |                |          |      | GWP of the refrigerant   |              | 2088  | kg CO <sub>2</sub> eq (100 years) |
| Contact details   |                |          |      | Panasonic Testing Centre, Panasonic Marketing Europe GmbH Winsberggring 15, 22525 Hamburg, Germany |              |       |                                   |

\*\* If  $C_{dh}$  is not determined by measurement then the default degradation coefficient of heat pumps shall be 0.25.

\*\*\* from 26 September 2018.

Where information relates to multi-split heat pumps, the test result and performance data may be obtained on the basis of the performance of the outdoor unit, with a combination of indoor unit(s) recommended by the manufacturer or importer.

\*\*\*\* Refer to Information requirements for UnitList

### Information requirements for air-to-air air conditioners

Model(s): Outdoor Unit U-125PE1E5A  
Indoor Unit S-60PF1E5A x2

Outdoor side heat exchanger of air conditioner: air  
Indoor side heat exchanger of air conditioner: air  
Type: compressor driven vapour compression or sorption process vapour compression  
if applicable: driver of compressor: electric motor or fuel driven, electric motor  
gaseous or liquid fuel, internal or external combustion engine

| Item  | Symbol                   | Value    | Unit | Item   | Symbol  | Value | Unit                              |
|---|--------------------------|----------|------|--|---|-------|-----------------------------------|
| Rated cooling capacity  | P <sub>rated,c</sub>     | 12.5     | kW   | Seasonal space cooling energy efficiency   | η <sub>p,c</sub>  | 234.1 | %                                 |
| Refrigeration load  | P <sub>design,c</sub>    | 12.5     | kW   | Declared energy efficiency ratio or gas utilization efficiency / auxiliary energy factor for part load at given outdoor temperatures T <sub>j</sub> and indoor 27°/19°C (dry/wet bulb) |   |       |                                   |
| Declared cooling capacity for part load at given outdoor temperatures T <sub>j</sub> and indoor 27°/19°C (dry/wet bulb) | T <sub>j</sub> = + 35 °C | 12.5     | kW   | T <sub>j</sub> = + 35 °C   |   | 3.5   | %                                 |
|   | T <sub>j</sub> = + 30 °C | 9.2      | kW   | T <sub>j</sub> = + 30 °C   | EER <sub>d</sub> or GUE <sub>c,dbn</sub> / AEF <sub>c,dbn</sub> | 4.9   | %                                 |
|   | T <sub>j</sub> = + 25 °C | 5.9      | kW   | T <sub>j</sub> = + 25 °C   |   | 7.3   | %                                 |
|   | T <sub>j</sub> = + 20 °C | 5.1      | kW   | T <sub>j</sub> = + 20 °C   |   | 9.9   | %                                 |
| Degradation co-efficient for air conditioners**   | C <sub>dc</sub>          | 0.25     | -    |  |   |       |                                   |
| Power consumption in modes other than 'active mode'   |                          |          |      |  |   |       |                                   |
| Off mode  | P <sub>OFF</sub>         | 0.021    | kW   | Crankcase heater mode  | P <sub>CK</sub>   | 0.000 | kW                                |
| Thermostat-off mode   | P <sub>TO</sub>          | 0.090    | kW   | Standby mode   | P <sub>SB</sub>   | 0.021 | kW                                |
| Other items   |                          |          |      |  |   |       |                                   |
| Capacity control  |                          | variable |      | For air-to-air air conditioner: air flow rate, outdoor   |   | 7800  | m³/h                              |
| Sound power level, outdoor  | L <sub>WA</sub>          | 70.0     | dB   |  |   |       |                                   |
| Sound power level, indoor   | L <sub>WA</sub>          | 57.0     | dB   | if engine driven: Emissions of nitrogen oxides   | NO <sub>x</sub> ***   | -     | mg/kWh fuel input GCV             |
|   |                          |          |      | GWP of the refrigerant   |   | 2088  | kg CO <sub>2</sub> eq (100 years) |
| Contact details   |                          |          |      | Panasonic Testing Centre, Panasonic Marketing Europe GmbH Winsberggring 15, 22525 Hamburg, Germany   |   |       |                                   |

\*\* If C<sub>dc</sub> is not determined by measurement then the default degradation coefficient air conditioners shall be 0.25.  
\*\*\* from 26 September 2018.  
Where information relates to multi-split air conditioners, the test result and performance data may be obtained on the basis of the performance of the outdoor unit, with a combination of indoor unit(s) recommended by the manufacturer or importer.  
\*\*\*\* Refer to information requirements for UnitLi.st

### Information requirements for heat pumps

Model(s): Outdoor Unit U-125PE1E5A  
Indoor Unit S-60PF1E5A x2

Outdoor side heat exchanger of heat pump: air  
Indoor side heat exchanger of heat pump: air  
Indication if the heater is equipped with a supplementary heater: no  
if applicable: driver of compressor: electric motor or fuel driven, electric motor  
gaseous or liquid fuel, internal or external combustion engine

Parameters shall be declared for the average heating season, parameters for the warmer and colder heating seasons are optional.

| Item   | Symbol                   | Value    | Unit | Item   | Symbol  | Value | Unit                              |
|--|--------------------------|----------|------|--|---|-------|-----------------------------------|
| Rated heating capacity   | P <sub>rated,h</sub>     | 14.0     | kW   | Seasonal space heating energy efficiency   | η <sub>p,h</sub>  | 146.6 | %                                 |
| Refrigeration load   | P <sub>design,h</sub>    | 12.5     | kW   | Declared coefficient of performance or gas utilization efficiency / auxiliary energy factor for part load at given outdoor temperatures T <sub>j</sub> |   |       |                                   |
| Declared heating capacity for part load at indoor temperature 20 °C and outdoor temperature T <sub>j</sub> | T <sub>j</sub> = - 7 °C  | 11.0     | kW   | T <sub>j</sub> = - 7 °C  |   | 2.4   | %                                 |
|  | T <sub>j</sub> = + 2 °C  | 6.3      | kW   | T <sub>j</sub> = + 2 °C  |   | 3.6   | %                                 |
|  | T <sub>j</sub> = + 7 °C  | 4.7      | kW   | T <sub>j</sub> = + 7 °C  |   | 5.1   | %                                 |
|  | T <sub>j</sub> = + 12 °C | 4.4      | kW   | T <sub>j</sub> = + 12 °C   | COP <sub>d</sub> or GUE <sub>h,dbn</sub> / AEF <sub>h,dbn</sub> | 6.1   | %                                 |
| T <sub>bw</sub> = bivalent temperature   |                          | 12.0     | kW   | T <sub>bw</sub> = bivalent temperature   |   | 2.2   | %                                 |
| T <sub>ol</sub> = operation limit  |                          | 9.8      | kW   | T <sub>ol</sub> = operation limit  |   | 1.7   | %                                 |
| For air-to-water heat pumps: T <sub>j</sub> = - 15 °C (if T <sub>ol</sub> < - 20 °C)                       |                          | -        | kW   | For water-to-air heat pumps: T <sub>j</sub> = - 15 °C (if T <sub>ol</sub> < - 20 °C)   |   | -     | %                                 |
| Bivalent temperature   | T <sub>bw</sub>          | -9       | °C   | For water-to-air heat pumps: Operation limit temperature   | T <sub>ol</sub>   | -20   | °C                                |
| Degradation co-efficient heat pumps**  | C <sub>eh</sub>          | 0.25     | -    |  |   |       |                                   |
| Power consumption in modes other than 'active mode'  |                          |          |      |  |   |       |                                   |
| Off mode   | P <sub>OFF</sub>         | 0.021    | kW   | Supplementary heater   |   |       |                                   |
| Thermostat-off mode  | P <sub>TO</sub>          | 0.090    | kW   | back-up heating capacity *   | elbu  | 0.7   | kW                                |
| Crankcase heater mode  | P <sub>CK</sub>          | 0.000    | kW   | Type of energy input   |   |       |                                   |
| Other items  |                          |          |      |  |   |       |                                   |
| Capacity control   |                          | variable |      | For air-to-air heat pumps: air flow rate, outdoor  |   | 6600  | m³/h                              |
| Sound power level, outdoor   | L <sub>WA</sub>          | 70.0     | dB   | For water-ibine-to-air heat pumps: Rated brine or water flow rate, outdoor side heat exchanger   |   | -     | m³/h                              |
| Sound power level, indoor  | L <sub>WA</sub>          | 57.0     | dB   | Emissions of nitrogen oxides (if applicable)   | NO <sub>x</sub> ***   | -     | mg/kWh fuel input GCV             |
|  |                          |          |      | GWP of the refrigerant   |   | 2088  | kg CO <sub>2</sub> eq (100 years) |
| Contact details  |                          |          |      | Panasonic Testing Centre, Panasonic Marketing Europe GmbH Winsberggring 15, 22525 Hamburg, Germany   |   |       |                                   |

\*\* If C<sub>eh</sub> is not determined by measurement then the default degradation coefficient of heat pumps shall be 0.25.  
\*\*\* from 26 September 2018.  
Where information relates to multi-split heat pumps, the test result and performance data may be obtained on the basis of the performance of the outdoor unit, with a combination of indoor unit(s) recommended by the manufacturer or importer.  
\*\*\*\* Refer to information requirements for UnitLi.st

## Information requirements for air-to-air air conditioners

|  |                             |                              |
|--|-----------------------------|------------------------------|
| Model(s):  | Outdoor Unit<br>Indoor Unit | U-140PE1E5A<br>S-71PF1E5A x2 |
| Outdoor side heat exchanger of air conditioner:  | air                         |                              |
| Indoor side heat exchanger of air conditioner:   | air                         |                              |
| Type: compressor driven vapour compression or sorption process   | vapour compression          |                              |
| if applicable: driver of compressor: [electric motor or fuel driven, gaseous or liquid fuel, internal or external combustion engine] | electric motor              |                              |

| Item   | Symbol         | Value    | Unit | Item   | Symbol       | Value | Unit                              |
|--|----------------|----------|------|--|--------------|-------|-----------------------------------|
| Rated cooling capacity   | $P_{rated,c}$  | 14.0     | kW   | Seasonal space cooling energy efficiency   | $\eta_{s,c}$ | 226.3 | %                                 |
| Refrigeration load   | $P_{design,c}$ | 14.0     | kW   | Declared energy efficiency ratio or gas utilization efficiency / auxiliary energy factor for part load at given outdoor temperatures $T_j$ |              |       |                                   |
| Declared cooling capacity for part load at given outdoor temperatures $T_j$ and indoor 27%/19°C (dry/wet bulb) |                |          |      |  |              |       |                                   |
| $T_j = +35\text{ °C}$  |                | 14.0     | kW   | $T_j = +35\text{ °C}$  |              | 3.2   | %                                 |
| $T_j = +30\text{ °C}$  |                | 10.3     | kW   | $T_j = +30\text{ °C}$  |              | 4.6   | %                                 |
| $T_j = +25\text{ °C}$  | $P_{dc}$       | 6.6      | kW   | $T_j = +25\text{ °C}$  |              | 7.0   | %                                 |
| $T_j = +20\text{ °C}$  |                | 5.1      | kW   | $T_j = +20\text{ °C}$  |              | 9.8   | %                                 |
| Degradation co-efficient for air conditioners**  | $C_{dc}$       | 0.25     | -    | Power consumption in modes other than 'active mode'  |              |       |                                   |
| Off mode   |                |          |      |  |              |       |                                   |
| Off mode   | $P_{off}$      | 0.021    | kW   | Crankcase heater mode  | $P_{ck}$     | 0.000 | kW                                |
| Thermostat-off mode  | $P_{to}$       | 0.090    | kW   | Standby mode   | $P_{sb}$     | 0.021 | kW                                |
| Other items  |                |          |      |  |              |       |                                   |
| Capacity control   |                | variable |      | For air-to-air conditioner: air flow rate, outdoor   |              | 8100  | m <sup>3</sup> /h                 |
| Sound power level, outdoor   | $L_{WA}$       | 71.0     | dB   |  |              |       |                                   |
| Sound power level, indoor  | $L_{WA}$       | 57.0     | dB   | if engine driven: Emissions of nitrogen oxides   | $NO_x^{***}$ | -     | mg/kWh fuel input GCV             |
|  |                |          |      | GWP of the refrigerant   |              | 2088  | kg CO <sub>2</sub> eq (100 years) |
| Contact details  |                |          |      | Panasonic Testing Centre, Panasonic Marketing Europe GmbH Winsberggiring 15, 22525 Hamburg, Germany  |              |       |                                   |

\*\* If  $C_{dc}$  is not determined by measurement then the default degradation coefficient air conditioners shall be 0.25.  
 \*\*\* from 26 September 2018.  
 Where information relates to multi-split air conditioners, the test result and performance data may be obtained on the basis of the performance of the outdoor unit, with a combination of indoor unit(s) recommended by the manufacturer or importer.  
 \*\*\*\* Refer to Information requirements for UnitList

## Information requirements for heat pumps

|  |                             |                              |
|--|-----------------------------|------------------------------|
| Model(s):  | Outdoor Unit<br>Indoor Unit | U-140PE1E5A<br>S-71PF1E5A x2 |
| Outdoor side heat exchanger of heat pump:  | air                         |                              |
| Indoor side heat exchanger of heat pump:   | air                         |                              |
| Indication if the heater is equipped with a supplementary heater:  | no                          |                              |
| if applicable: driver of compressor: [electric motor or fuel driven, gaseous or liquid fuel, internal or external combustion engine] | electric motor              |                              |

Parameters shall be declared for the average heating season, parameters for the warmer and colder heating seasons are optional.

| Item  | Symbol         | Value    | Unit | Item   | Symbol       | Value | Unit                              |
|---|----------------|----------|------|--|--------------|-------|-----------------------------------|
| Rated heating capacity  | $P_{rated,h}$  | 16.0     | kW   | Seasonal space heating energy efficiency   | $\eta_{s,h}$ | 143.0 | %                                 |
| Refrigeration load  | $P_{design,h}$ | 14.0     | kW   | Declared coefficient of performance or gas utilization efficiency / auxiliary energy factor for part load at given outdoor temperatures °C and outdoor temperature $T_j$ |              |       |                                   |
| Declared heating capacity for part load at indoor temperature 20 °C and outdoor temperature $T_j$ |                |          |      |  |              |       |                                   |
| $T_j = -7\text{ °C}$  |                | 12.3     | kW   | $T_j = -7\text{ °C}$   |              | 2.3   | %                                 |
| $T_j = +2\text{ °C}$  |                | 7.5      | kW   | $T_j = +2\text{ °C}$   |              | 3.5   | %                                 |
| $T_j = +7\text{ °C}$  |                | 4.8      | kW   | $T_j = +7\text{ °C}$   |              | 5.1   | %                                 |
| $T_j = +12\text{ °C}$   |                | 4.4      | kW   | $T_j = +12\text{ °C}$  |              | 6.0   | %                                 |
| $T_{bv} = \text{bivalent temperature}$  | $P_{bh}$       | 12.3     | kW   | $T_{bv} = \text{bivalent temperature}$   |              | 2.3   | %                                 |
| $T_{ol} = \text{operation limit}$   |                | 10.0     | kW   | $T_{ol} = \text{operation limit}$  |              | 1.7   | %                                 |
| For air-to-water heat pumps: $T_j = -15\text{ °C}$ (if $T_{ol} < -20\text{ °C}$ )                 |                | -        | kW   | For water-to-air heat pumps: $T_j = -15\text{ °C}$ (if $T_{ol} < -20\text{ °C}$ )  |              | -     | %                                 |
| Bivalent temperature  | $T_{bv}$       | -7       | °C   | For water-to-air heat pumps: Operation limit temperature   | $T_{ol}$     | -20   | °C                                |
| Degradation co-efficient heat pumps**   | $C_{dh}$       | 0.25     | -    | Power consumption in modes other than 'active mode'  |              |       |                                   |
| Off mode  |                |          |      |  |              |       |                                   |
| Off mode  | $P_{off}$      | 0.021    | kW   | back-up heating capacity *   | $e_{ibu}$    | 2.3   | kW                                |
| Thermostat-off mode   | $P_{to}$       | 0.090    | kW   | Type of energy input   |              |       |                                   |
| Crankcase heater mode   | $P_{ck}$       | 0.000    | kW   | Standby mode   | $P_{sb}$     | 0.021 | kW                                |
| Other items   |                |          |      |  |              |       |                                   |
| Capacity control  |                | variable |      | For air-to-air heat pumps: air flow rate, outdoor  |              | 7200  | m <sup>3</sup> /h                 |
| Sound power level, outdoor  | $L_{WA}$       | 71.0     | dB   | For water-/brine-to-air heat pumps: Rated brine or water flow rate, outdoor side heat exchanger  |              | -     | m <sup>3</sup> /h                 |
| Sound power level, indoor   | $L_{WA}$       | 57.0     | dB   | Emissions of nitrogen oxides (if applicable)   | $NO_x^{***}$ | -     | mg/kWh fuel input GCV             |
|   |                |          |      | GWP of the refrigerant   |              | 2088  | kg CO <sub>2</sub> eq (100 years) |
| Contact details   |                |          |      | Panasonic Testing Centre, Panasonic Marketing Europe GmbH Winsberggiring 15, 22525 Hamburg, Germany  |              |       |                                   |

\*\* If  $C_{dh}$  is not determined by measurement then the default degradation coefficient of heat pumps shall be 0.25.  
 \*\*\* from 26 September 2018.  
 Where information relates to multi-split heat pumps, the test result and performance data may be obtained on the basis of the performance of the outdoor unit, with a combination of indoor unit(s) recommended by the manufacturer or importer.  
 \*\*\*\* Refer to Information requirements for UnitList

Information requirements for air-to-air air conditioners

Model(s): Outdoor Unit U-125PE1E5A  
Indoor Unit S-125PF1E5A

Outdoor side heat exchanger of air conditioner: air  
Indoor side heat exchanger of air conditioner: air  
Type: compressor driven vapour compression or sorption process  
if applicable: driver of compressor: electric motor or fuel driven, vapour compression  
gaseous or liquid fuel, internal or external combustion engine electric motor

| Item  | Symbol                   | Value    | Unit | Item   | Symbol  | Value | Unit                              |
|---|--------------------------|----------|------|--|---|-------|-----------------------------------|
| Rated cooling capacity  | P <sub>rated,c</sub>     | 12.5     | kW   | Seasonal space cooling energy efficiency   | η <sub>p,c</sub>  | 219.6 | %                                 |
| Refrigeration load  | P <sub>design,c</sub>    | 12.5     | kW   | Declared energy efficiency ratio or gas utilization efficiency / auxiliary energy factor for part load at given outdoor temperatures T <sub>j</sub> and indoor 27°/19°C (dry/wet bulb) |   |       |                                   |
| Declared cooling capacity for part load at given outdoor temperatures T <sub>j</sub> and indoor 27°/19°C (dry/wet bulb) | T <sub>j</sub> = + 35 °C | 12.5     | kW   | T <sub>j</sub> = + 35 °C   |   | 3.5   | %                                 |
|   | T <sub>j</sub> = + 30 °C | 9.2      | kW   | T <sub>j</sub> = + 30 °C   | EER <sub>d</sub> or GUE <sub>c,dbn</sub> / AEF <sub>c,dbn</sub> | 4.9   | %                                 |
|   | T <sub>j</sub> = + 25 °C | 5.9      | kW   | T <sub>j</sub> = + 25 °C   |   | 7.3   | %                                 |
|   | T <sub>j</sub> = + 20 °C | 5.1      | kW   | T <sub>j</sub> = + 20 °C   |   | 9.9   | %                                 |
| Degradation co-efficient for air conditioners**   | C <sub>dc</sub>          | 0.25     | -    |  |   |       |                                   |
| Power consumption in modes other than 'active mode'   |                          |          |      |  |   |       |                                   |
| Off mode  | P <sub>OFF</sub>         | 0.021    | kW   | Crankcase heater mode  | P <sub>CK</sub>   | 0.000 | kW                                |
| Thermostat-off mode   | P <sub>TO</sub>          | 0.215    | kW   | Standby mode   | P <sub>SB</sub>   | 0.021 | kW                                |
| Other items   |                          |          |      |  |   |       |                                   |
| Capacity control  |                          | variable |      | For air-to-air air conditioner: air flow rate, outdoor   |   | 7800  | m³/h                              |
| Sound power level, outdoor  | L <sub>WA</sub>          | 70.0     | dB   |  |   |       |                                   |
| Sound power level, indoor   | L <sub>WA</sub>          | 61.0     | dB   | if engine driven: Emissions of nitrogen oxides   | NO <sub>x</sub> ***   | -     | mg/kWh fuel input GCV             |
|   |                          |          |      | GWP of the refrigerant   |   | 2088  | kg CO <sub>2</sub> eq (100 years) |
| Contact details   |                          |          |      | Panasonic Testing Centre, Panasonic Marketing Europe GmbH Winsberggring 15, 22525 Hamburg, Germany   |   |       |                                   |

\*\* If C<sub>dc</sub> is not determined by measurement then the default degradation coefficient air conditioners shall be 0.25.  
\*\*\* from 26 September 2018.  
Where information relates to multi-split air conditioners, the test result and performance data may be obtained on the basis of the performance of the outdoor unit, with a combination of indoor unit(s) recommended by the manufacturer or importer.  
\*\*\*\* Refer to information requirements for UnitLi.st

Information requirements for heat pumps

Model(s): Outdoor Unit U-125PE1E5A  
Indoor Unit S-125PF1E5A

Outdoor side heat exchanger of heat pump: air  
Indoor side heat exchanger of heat pump: air  
Indication if the heater is equipped with a supplementary heater: no  
if applicable: driver of compressor: electric motor or fuel driven, electric motor  
gaseous or liquid fuel, internal or external combustion engine electric motor

Parameters shall be declared for the average heating season, parameters for the warmer and colder heating seasons are optional.

| Item   | Symbol                   | Value    | Unit | Item   | Symbol  | Value | Unit                              |
|--|--------------------------|----------|------|--|---|-------|-----------------------------------|
| Rated heating capacity   | P <sub>rated,h</sub>     | 14.0     | kW   | Seasonal space heating energy efficiency   | η <sub>p,h</sub>  | 145.9 | %                                 |
| Refrigeration load   | P <sub>design,h</sub>    | 12.5     | kW   | Declared coefficient of performance or gas utilization efficiency / auxiliary energy factor for part load at given outdoor temperatures T <sub>j</sub> |   |       |                                   |
| Declared heating capacity for part load at indoor temperature 20 °C and outdoor temperature T <sub>j</sub> | T <sub>j</sub> = - 7 °C  | 11.0     | kW   | T <sub>j</sub> = - 7 °C  |   | 2.4   | %                                 |
|  | T <sub>j</sub> = + 2 °C  | 6.7      | kW   | T <sub>j</sub> = + 2 °C  |   | 3.6   | %                                 |
|  | T <sub>j</sub> = + 7 °C  | 4.3      | kW   | T <sub>j</sub> = + 7 °C  |   | 5.1   | %                                 |
|  | T <sub>j</sub> = + 12 °C | 4.4      | kW   | T <sub>j</sub> = + 12 °C   | COP <sub>d</sub> or GUE <sub>h,dbn</sub> / AEF <sub>h,dbn</sub> | 6.1   | %                                 |
| T <sub>bw</sub> = bivalent temperature   |                          | 12.0     | kW   | T <sub>bw</sub> = bivalent temperature   |   | 2.2   | %                                 |
| T <sub>OL</sub> = operation limit  |                          | 9.8      | kW   | T <sub>OL</sub> = operation limit  |   | 1.7   | %                                 |
| For air-to-water heat pumps: T <sub>j</sub> = - 15 °C (if T <sub>OL</sub> < - 20 °C)                       |                          | -        | kW   | For water-to-air heat pumps: T <sub>j</sub> = - 15 °C (if T <sub>OL</sub> < - 20 °C)   |   | -     | %                                 |
| Bivalent temperature   | T <sub>bw</sub>          | -9       | °C   | For water-to-air heat pumps: Operation limit temperature   | T <sub>OL</sub>   | -20   | °C                                |
| Degradation co-efficient heat pumps**  | C <sub>dh</sub>          | 0.25     | -    |  |   |       |                                   |
| Power consumption in modes other than 'active mode'  |                          |          |      |  |   |       |                                   |
| Off mode   | P <sub>OFF</sub>         | 0.021    | kW   | Supplementary heater   |   |       |                                   |
| Thermostat-off mode  | P <sub>TO</sub>          | 0.215    | kW   | back-up heating capacity *   | elbu  | 0.7   | kW                                |
| Crankcase heater mode  | P <sub>CK</sub>          | 0.000    | kW   | Type of energy input   |   |       |                                   |
| Other items  |                          |          |      |  |   |       |                                   |
| Capacity control   |                          | variable |      | For air-to-air heat pumps: air flow rate,outdoor   |   | 6600  | m³/h                              |
| Sound power level, outdoor   | L <sub>WA</sub>          | 70.0     | dB   | For water-/brine-to-air heat pumps: Rated brine or water flow rate, outdoor side heat exchanger  |   | -     | m³/h                              |
| Sound power level, indoor  | L <sub>WA</sub>          | 61.0     | dB   | Emissions of nitrogen oxides (if applicable)   | NO <sub>x</sub> ***   | -     | mg/kWh fuel input GCV             |
|  |                          |          |      | GWP of the refrigerant   |   | 2088  | kg CO <sub>2</sub> eq (100 years) |
| Contact details  |                          |          |      | Panasonic Testing Centre, Panasonic Marketing Europe GmbH Winsberggring 15, 22525 Hamburg, Germany   |   |       |                                   |

\*\* If C<sub>dh</sub> is not determined by measurement then the default degradation coefficient of heat pumps shall be 0.25.  
\*\*\* from 26 September 2018.  
Where information relates to multi-split heat pumps, the test result and performance data may be obtained on the basis of the performance of the outdoor unit, with a combination of indoor unit(s) recommended by the manufacturer or importer.  
\*\*\*\* Refer to information requirements for UnitLi.st

## Information requirements for air-to-air air conditioners

|  |                             |                            |
|--|-----------------------------|----------------------------|
| Model(s):  | Outdoor Unit<br>Indoor Unit | U-140PE1E5A<br>S-140PF1E5A |
| Outdoor side heat exchanger of air conditioner:  | air                         |                            |
| Indoor side heat exchanger of air conditioner:   | vapour compression          |                            |
| Type: compressor driven vapour compression or sorption process   | electric motor              |                            |
| if applicable: driver of compressor: [electric motor or fuel driven, gaseous or liquid fuel, internal or external combustion engine] |                             |                            |

| Item   | Symbol                            | Value    | Unit | Item  | Symbol       | Value | Unit                              |
|--|-----------------------------------|----------|------|---|--------------|-------|-----------------------------------|
| Rated cooling capacity   | $P_{med,c}$                       | 14.0     | kW   | Seasonal space cooling energy efficiency  | $\eta_{s,c}$ | 213.4 | %                                 |
| Refrigeration load   | $P_{design,c}$                    | 14.0     | kW   | Declared energy efficiency ratio or gas utilization efficiency / auxiliary energy factor for part load at given outdoor temperatures $T_j$ and indoor 27°/19°C (dry/wet bulb) |              |       |                                   |
| Declared cooling capacity for part load at given outdoor temperatures $T_j$ and indoor 27°/19°C (dry/wet bulb) |                                   |          |      | Declared energy efficiency ratio or gas utilization efficiency / auxiliary energy factor for part load at given outdoor temperatures $T_j$                                    |              |       |                                   |
| $T_j = +35\text{ °C}$  |                                   | 14.0     | kW   | $T_j = +35\text{ °C}$   |              | 3.2   | %                                 |
| $T_j = +30\text{ °C}$  |                                   | 10.3     | kW   | $T_j = +30\text{ °C}$   |              | 4.6   | %                                 |
| $T_j = +25\text{ °C}$  | $P_{dc}$                          | 6.6      | kW   | $T_j = +25\text{ °C}$   |              | 7.0   | %                                 |
| $T_j = +20\text{ °C}$  |                                   | 5.1      | kW   | $T_j = +20\text{ °C}$   |              | 9.8   | %                                 |
| Degradation co-efficient for air conditioners**  | $C_{dc}$                          | 0.25     | -    |   |              |       |                                   |
| Power consumption in modes other than 'active mode'  |                                   |          |      | Power consumption in modes other than 'active mode'   |              |       |                                   |
| Off mode   | $P_{off}$                         | 0.021    | kW   | Crankcase heater mode   | $P_{ck}$     | 0.000 | kW                                |
| Thermostat-off mode  | $P_{to}$                          | 0.223    | kW   | Standby mode  | $P_{sb}$     | 0.021 | kW                                |
| Other items  |                                   |          |      | Other items   |              |       |                                   |
| Capacity control   |                                   | variable |      | For air-to-air air conditioner: air flow rate, outdoor  |              | 8100  | m³/h                              |
| Sound power level, outdoor   | $L_{WA}$                          | 71.0     | dB   |   |              |       |                                   |
| Sound power level, indoor  | $L_{WA}$                          | 62.0     | dB   | if engine driven: Emissions of nitrogen oxides  | $NO_x^{***}$ | -     | mg/kWh fuel input GCV             |
|  |                                   |          |      | GWP of the refrigerant  |              | 2088  | kg CO <sub>2</sub> eq (100 years) |
| Contact details  | Panasonic Testing Centre, Germany |          |      | Panasonic Marketing Europe GmbH Winsberg 15, 22525 Hamburg, Germany   |              |       |                                   |

\*\* If  $C_{dc}$  is not determined by measurement then the default degradation coefficient air conditioners shall be 0.25.  
 \*\*\* from 26 September 2018.  
 Where information relates to multi-split air conditioners, the test result and performance data may be obtained on the basis of the performance of the outdoor unit, with a combination of indoor unit(s) recommended by the manufacturer or importer.  
 \*\*\*\* Refer to Information requirements for UnitList

## Information requirements for heat pumps

|  |                             |                            |
|--|-----------------------------|----------------------------|
| Model(s):  | Outdoor Unit<br>Indoor Unit | U-140PE1E5A<br>S-140PF1E5A |
| Outdoor side heat exchanger of heat pump:  | air                         |                            |
| Indoor side heat exchanger of heat pump:   | air                         |                            |
| Indication if the heater is equipped with a supplementary heater:  | no                          |                            |
| if applicable: driver of compressor: [electric motor or fuel driven, gaseous or liquid fuel, internal or external combustion engine] | electric motor              |                            |
| Parameters shall be declared for the average heating season, parameters for the warmer and colder heating seasons are optional.      |                             |                            |

| Item  | Symbol                            | Value    | Unit | Item   | Symbol       | Value | Unit                              |
|---|-----------------------------------|----------|------|--|--------------|-------|-----------------------------------|
| Rated heating capacity  | $P_{med,h}$                       | 16.0     | kW   | Seasonal space heating energy efficiency   | $\eta_{s,h}$ | 142.3 | %                                 |
| Refrigeration load  | $P_{design,h}$                    | 14.0     | kW   | Declared coefficient of performance or gas utilization efficiency / auxiliary energy factor for part load at given outdoor temperatures °C and outdoor temperature $T_j$ |              |       |                                   |
| Declared heating capacity for part load at indoor temperature 20 °C and outdoor temperature $T_j$ |                                   |          |      | Declared coefficient of performance or gas utilization efficiency / auxiliary energy factor for part load at given outdoor temperatures °C and outdoor temperature $T_j$ |              |       |                                   |
| $T_j = -7\text{ °C}$  |                                   | 12.3     | kW   | $T_j = -7\text{ °C}$   |              | 2.3   | %                                 |
| $T_j = +2\text{ °C}$  |                                   | 7.5      | kW   | $T_j = +2\text{ °C}$   |              | 3.5   | %                                 |
| $T_j = +7\text{ °C}$  |                                   | 4.8      | kW   | $T_j = +7\text{ °C}$   |              | 5.1   | %                                 |
| $T_j = +12\text{ °C}$   |                                   | 4.4      | kW   | $T_j = +12\text{ °C}$  |              | 6.0   | %                                 |
| $T_{bw} = \text{bivalent temperature}$  | $P_{bh}$                          | 12.3     | kW   | $T_{bw} = \text{bivalent temperature}$   |              | 2.3   | %                                 |
| $T_{ol} = \text{operation limit}$   |                                   | 10.0     | kW   | $T_{ol} = \text{operation limit}$  |              | 1.7   | %                                 |
| For air-to-water heat pumps: $T_j = -15\text{ °C}$ (if $T_{ox} < -20\text{ °C}$ )                 |                                   | -        | kW   | For water-to-air heat pumps: $T_j = -15\text{ °C}$ (if $T_{ox} < -20\text{ °C}$ )  |              | -     | %                                 |
| Bivalent temperature  | $T_{bw}$                          | -7       | °C   | For water-to-air heat pumps: Operation limit temperature   | $T_{ol}$     | -20   | °C                                |
| Degradation co-efficient heat pumps**   | $C_{bh}$                          | 0.25     | -    | Supplementary heater   |              |       |                                   |
| Power consumption in modes other than 'active mode'   |                                   |          |      | Supplementary heater   |              |       |                                   |
| Off mode  | $P_{off}$                         | 0.021    | kW   | back-up heating capacity*  | elbu         | 2.3   | kW                                |
| Thermostat-off mode   | $P_{to}$                          | 0.223    | kW   | Type of energy input   |              |       |                                   |
| Crankcase heater mode   | $P_{ck}$                          | 0.000    | kW   | Standby mode   | $P_{sb}$     | 0.021 | kW                                |
| Other items   |                                   |          |      | Other items  |              |       |                                   |
| Capacity control  |                                   | variable |      | For air-to-air heat pumps: air flow rate outdoor   |              | 7200  | m³/h                              |
| Sound power level, outdoor  | $L_{WA}$                          | 71.0     | dB   | For water-/brine-to-air heat pumps: Rated brine or water flow rate, outdoor side heat exchanger  |              | -     | m³/h                              |
| Sound power level, indoor   | $L_{WA}$                          | 62.0     | dB   | Emissions of nitrogen oxides (if applicable)   | $NO_x^{***}$ | -     | mg/kWh fuel input GCV             |
|   |                                   |          |      | GWP of the refrigerant   |              | 2088  | kg CO <sub>2</sub> eq (100 years) |
| Contact details   | Panasonic Testing Centre, Germany |          |      | Panasonic Marketing Europe GmbH Winsberg 15, 22525 Hamburg, Germany  |              |       |                                   |

\*\* If  $C_{bh}$  is not determined by measurement then the default degradation coefficient of heat pumps shall be 0.25.  
 \*\*\* from 26 September 2018.  
 Where information relates to multi-split heat pumps, the test result and performance data may be obtained on the basis of the performance of the outdoor unit, with a combination of indoor unit(s) recommended by the manufacturer or importer.  
 \*\*\*\* Refer to Information requirements for UnitList

## Information requirements for air-to-air air conditioners

|  |                             |                              |
|--|-----------------------------|------------------------------|
| Model(s):  | Outdoor Unit<br>Indoor Unit | U-125PE1E8A<br>S-36PF1E5A x4 |
| Outdoor side heat exchanger of air conditioner:  | air                         |                              |
| Indoor side heat exchanger of air conditioner:   | vapour compression          |                              |
| Type: compressor driven vapour compression or sorption process   | electric motor              |                              |
| if applicable: driver of compressor: (electric motor or fuel driven, gaseous or liquid fuel, internal or external combustion engine) |                             |                              |

| Item   | Symbol   | Value    | Unit | Item  | Symbol  | Value | Unit                              |
|--|--|----------|------|---|---|-------|-----------------------------------|
| Rated cooling capacity   | $P_{med,c}$  | 12.5     | kW   | Seasonal space cooling energy efficiency  | $\eta_{s,c}$  | 233.4 | %                                 |
| Refrigeration load   | $P_{design,c}$   | 12.5     | kW   | Declared energy efficiency ratio or gas utilization efficiency / auxiliary energy factor for part load at given outdoor temperatures $T_j$ and indoor 27*/19°C (dry/wet bulb) |   |       |                                   |
| Declared cooling capacity for part load at given outdoor temperatures $T_j$ and indoor 27*/19°C (dry/wet bulb) | $T_j = +35^\circ\text{C}$  | 12.5     | kW   | $T_j = +35^\circ\text{C}$   | EER <sub>d</sub> or GUE <sub>d,br</sub> / AEF <sub>d,br</sub> | 3.5   | %                                 |
|  | $T_j = +30^\circ\text{C}$  | 9.2      | kW   | $T_j = +30^\circ\text{C}$   |   | 4.9   | %                                 |
|  | $T_j = +25^\circ\text{C}$  | 5.9      | kW   | $T_j = +25^\circ\text{C}$   |   | 7.3   | %                                 |
|  | $T_j = +20^\circ\text{C}$  | 5.1      | kW   | $T_j = +20^\circ\text{C}$   |   | 9.9   | %                                 |
| Degradation co-efficient for air conditioners**  | $C_{de}$   | 0.25     | -    |   |   |       |                                   |
| Power consumption in modes other than 'active mode'  |  |          |      |   |   |       |                                   |
| Off mode   | $P_{off}$  | 0.024    | kW   | Crankcase heater mode   | $P_{ck}$  | 0.000 | kW                                |
| Thermostat-off mode  | $P_{to}$   | 0.090    | kW   | Standby mode  | $P_{sb}$  | 0.024 | kW                                |
| Other items  |  |          |      |   |   |       |                                   |
| Capacity control   |  | variable |      | For air-to-air air conditioner: air flow rate, outdoor  |   | 7800  | m <sup>3</sup> /h                 |
| Sound power level, outdoor   | $L_{WA}$   | 70.0     | dB   |   |   |       |                                   |
| Sound power level, indoor  | $L_{WA}$   | 55.0     | dB   | if engine driven: Emissions of nitrogen oxides  | $\text{NO}_x^{***}$   | -     | mg/kWh fuel input GCV             |
|  |  |          |      | GWP of the refrigerant  |   | 2088  | kg CO <sub>2</sub> eq (100 years) |
| Contact details  | Panasonic Testing Centre, Panasonic Marketing Europe GmbH Winsbergstr 15, 22525 Hamburg, Germany |          |      |   |   |       |                                   |

\*\* If  $C_{de}$  is not determined by measurement then the default degradation coefficient air conditioners shall be 0.25.

\*\*\* from 26 September 2018.

Where information relates to multi-split air conditioners, the test result and performance data may be obtained on the basis of the performance of the outdoor unit, with a combination of indoor unit(s) recommended by the manufacturer or importer.

\*\*\*\* Refer to Information requirements for UnitList

## Information requirements for heat pumps

|  |                             |                              |
|--|-----------------------------|------------------------------|
| Model(s):  | Outdoor Unit<br>Indoor Unit | U-125PE1E8A<br>S-36PF1E5A x4 |
| Outdoor side heat exchanger of heat pump:  | air                         |                              |
| Indoor side heat exchanger of heat pump:   | air                         |                              |
| Indication if the heater is equipped with a supplementary heater:  | no                          |                              |
| if applicable: driver of compressor: (electric motor or fuel driven, gaseous or liquid fuel, internal or external combustion engine) | electric motor              |                              |
| Parameters shall be declared for the average heating season, parameters for the warmer and colder heating seasons are optional.      |                             |                              |

| Item  | Symbol   | Value    | Unit | Item   | Symbol  | Value | Unit                              |
|---|--|----------|------|--|---|-------|-----------------------------------|
| Rated heating capacity  | $P_{med,h}$  | 14.0     | kW   | Seasonal space heating energy efficiency   | $\eta_{s,h}$  | 146.6 | %                                 |
| Refrigeration load  | $P_{design,h}$   | 12.5     | kW   | Declared coefficient of performance or gas utilization efficiency / auxiliary energy factor for part load at given outdoor temperatures °C and outdoor temperature $T_j$ |   |       |                                   |
| Declared heating capacity for part load at indoor temperature 20 °C and outdoor temperature $T_j$ | $T_j = -7^\circ\text{C}$   | 11.0     | kW   | $T_j = -7^\circ\text{C}$   | COP <sub>d</sub> or GUE <sub>d,br</sub> / AEF <sub>d,br</sub> | 2.4   | %                                 |
|   | $T_j = +2^\circ\text{C}$   | 6.7      | kW   | $T_j = +2^\circ\text{C}$   |   | 3.6   | %                                 |
|   | $T_j = +7^\circ\text{C}$   | 4.3      | kW   | $T_j = +7^\circ\text{C}$   |   | 5.1   | %                                 |
|   | $T_j = +12^\circ\text{C}$  | 4.4      | kW   | $T_j = +12^\circ\text{C}$  |   | 6.1   | %                                 |
| Degradation co-efficient for heat pumps**   | $C_{de}$   | 0.25     | -    |  |   |       |                                   |
| Power consumption in modes other than 'active mode'   |  |          |      |  |   |       |                                   |
| Off mode  | $P_{off}$  | 0.024    | kW   | Supplementary heater back-up heating capacity *  | elbu  | 0.7   | kW                                |
| Thermostat-off mode   | $P_{to}$   | 0.090    | kW   | Type of energy input   |   |       |                                   |
| Crankcase heater mode   | $P_{ck}$   | 0.000    | kW   | Standby mode   | $P_{sb}$  | 0.024 | kW                                |
| Other items   |  |          |      |  |   |       |                                   |
| Capacity control  |  | variable |      | For air-to-air heat pumps: air flow rate outdoor   |   | 6600  | m <sup>3</sup> /h                 |
| Sound power level, outdoor  | $L_{WA}$   | 70.0     | dB   | For water-/brine-to-air heat pumps: Rated brine or water flow rate, outdoor side heat exchanger  |   | -     | m <sup>3</sup> /h                 |
| Sound power level, indoor   | $L_{WA}$   | 55.0     | dB   | Emissions of nitrogen oxides (if applicable)   | $\text{NO}_x^{***}$   | -     | mg/kWh fuel input GCV             |
|   |  |          |      | GWP of the refrigerant   |   | 2088  | kg CO <sub>2</sub> eq (100 years) |
| Contact details   | Panasonic Testing Centre, Panasonic Marketing Europe GmbH Winsbergstr 15, 22525 Hamburg, Germany |          |      |  |   |       |                                   |

\*\* If  $C_{de}$  is not determined by measurement then the default degradation coefficient of heat pumps shall be 0.25.

\*\*\* from 26 September 2018.

Where information relates to multi-split heat pumps, the test result and performance data may be obtained on the basis of the performance of the outdoor unit, with a combination of indoor unit(s) recommended by the manufacturer or importer.

\*\*\*\* Refer to Information requirements for UnitList

## Information requirements for air-to-air air conditioners

|  |                             |                              |
|--|-----------------------------|------------------------------|
| Model(s):  | Outdoor Unit<br>Indoor Unit | U-125PE1E8A<br>S-45PF1E5A x3 |
| Outdoor side heat exchanger of air conditioner:  | air                         |                              |
| Indoor side heat exchanger of air conditioner:   | air                         |                              |
| Type: compressor driven vapour compression or sorption process   | vapour compression          |                              |
| if applicable: driver of compressor: [electric motor or fuel driven, gaseous or liquid fuel, internal or external combustion engine] | electric motor              |                              |

| Item   | Symbol           | Value    | Unit | Item   | Symbol  | Value | Unit                              |
|--|------------------|----------|------|--|---|-------|-----------------------------------|
| Rated cooling capacity   | $P_{rated,c}$    | 12.5     | kW   | Seasonal space cooling energy efficiency   | $\eta_{p,c}$  | 233.4 | %                                 |
| Refrigeration load   | $P_{design,c}$   | 12.5     | kW   | Declared energy efficiency ratio or gas utilization efficiency / auxiliary energy factor for part load at given outdoor temperatures $T_j$ |   |       |                                   |
| Declared cooling capacity for part load at given outdoor temperatures $T_j$ and indoor 27%/19°C (dry/wet bulb)   |                  |          |      |  |   |       |                                   |
| $T_j = +35\text{ °C}$  |                  | 12.5     | kW   | $T_j = +35\text{ °C}$  |   | 3.5   | %                                 |
| $T_j = +30\text{ °C}$  |                  | 9.2      | kW   | $T_j = +30\text{ °C}$  | EER <sub>0</sub> or GUE <sub>0,br</sub> / AEF <sub>0,br</sub> | 4.9   | %                                 |
| $T_j = +25\text{ °C}$  | P <sub>dc</sub>  | 5.9      | kW   | $T_j = +25\text{ °C}$  |   | 7.3   | %                                 |
| $T_j = +20\text{ °C}$  |                  | 5.1      | kW   | $T_j = +20\text{ °C}$  |   | 9.9   | %                                 |
| Degradation co-efficient for air conditioners**  | C <sub>dc</sub>  | 0.25     | -    | Power consumption in modes other than 'active mode'  |   |       |                                   |
| Off mode   |                  |          |      |  |   |       |                                   |
|  | P <sub>off</sub> | 0.024    | kW   | Crankcase heater mode  | P <sub>ck</sub>   | 0.000 | kW                                |
| Thermostat-off mode  | P <sub>to</sub>  | 0.090    | kW   | Standby mode   | P <sub>sb</sub>   | 0.024 | kW                                |
| Other items  |                  |          |      |  |   |       |                                   |
| Capacity control   |                  | variable |      | For air-to-air conditioner: air flow rate, outdoor   |   | 7800  | m <sup>3</sup> /h                 |
| Sound power level, outdoor   | L <sub>WA</sub>  | 70.0     | dB   |  |   |       |                                   |
| Sound power level, indoor  | L <sub>WA</sub>  | 56.0     | dB   | if engine driven: Emissions of nitrogen oxides   | NO <sub>x</sub> ***   | -     | mg/kWh fuel input GCV             |
|  |                  |          |      | GWP of the refrigerant   |   | 2088  | kg CO <sub>2</sub> eq (100 years) |
| Contact details  |                  |          |      | Panasonic Testing Centre, Panasonic Marketing Europe GmbH Winsbergiring 15, 22525 Hamburg, Germany   |   |       |                                   |
| ** If C <sub>dc</sub> is not determined by measurement then the default degradation coefficient air conditioners shall be 0.25.  |                  |          |      |  |   |       |                                   |
| *** from 26 September 2018.  |                  |          |      |  |   |       |                                   |
| Where information relates to multi-split air conditioners, the test result and performance data may be obtained on the basis of the performance of the outdoor unit, with a combination of indoor unit(s) recommended by the manufacturer or importer. |                  |          |      |  |   |       |                                   |
| **** Refer to information requirements for UnitList  |                  |          |      |  |   |       |                                   |

## Information requirements for heat pumps

|  |                             |                              |
|--|-----------------------------|------------------------------|
| Model(s):  | Outdoor Unit<br>Indoor Unit | U-125PE1E8A<br>S-45PF1E5A x3 |
| Outdoor side heat exchanger of heat pump:  | air                         |                              |
| Indoor side heat exchanger of heat pump:   | air                         |                              |
| Indication if the heater is equipped with a supplementary heater:  | no                          |                              |
| if applicable: driver of compressor: [electric motor or fuel driven, gaseous or liquid fuel, internal or external combustion engine] | electric motor              |                              |

Parameters shall be declared for the average heating season, parameters for the warmer and colder heating seasons are optional.

| Item   | Symbol           | Value    | Unit | Item   | Symbol  | Value | Unit                              |
|--|------------------|----------|------|--|---|-------|-----------------------------------|
| Rated heating capacity   | $P_{rated,h}$    | 14.0     | kW   | Seasonal space heating energy efficiency   | $\eta_{p,h}$  | 146.6 | %                                 |
| Refrigeration load   | $P_{design,h}$   | 12.5     | kW   | Declared coefficient of performance or gas utilization efficiency / auxiliary energy factor for part load at given outdoor temperatures °C and outdoor temperature $T_j$ |   |       |                                   |
| Declared heating capacity for part load at indoor temperature 20 °C and outdoor temperature $T_j$  |                  |          |      |  |   |       |                                   |
| $T_j = -7\text{ °C}$   |                  | 11.0     | kW   | $T_j = -7\text{ °C}$   |   | 2.4   | %                                 |
| $T_j = +2\text{ °C}$   |                  | 6.7      | kW   | $T_j = +2\text{ °C}$   |   | 3.6   | %                                 |
| $T_j = +7\text{ °C}$   |                  | 4.3      | kW   | $T_j = +7\text{ °C}$   |   | 5.1   | %                                 |
| $T_j = +12\text{ °C}$  |                  | 4.4      | kW   | $T_j = +12\text{ °C}$  | COP <sub>0</sub> or GUE <sub>0,br</sub> / AEF <sub>0,br</sub> | 6.1   | %                                 |
| $T_{br} = \text{bivalent temperature}$   | P <sub>br</sub>  | 12.0     | kW   | $T_{br} = \text{bivalent temperature}$   |   | 2.2   | %                                 |
| $T_{ol} = \text{operation limit}$  |                  | 9.8      | kW   | $T_{ol} = \text{operation limit}$  |   | 1.7   | %                                 |
| For air-to-water heat pumps: $T_j = -15\text{ °C}$ (if $T_{ol} < -20\text{ °C}$ )  |                  | -        | kW   | For water-to-air heat pumps: $T_j = -15\text{ °C}$ (if $T_{ol} < -20\text{ °C}$ )  |   | -     | %                                 |
| Bivalent temperature   | $T_{br}$         | -9       | °C   | For water-to-air heat pumps: Operation limit temperature   | $T_{ol}$  | -20   | °C                                |
| Degradation co-efficient heat pumps**  | C <sub>dh</sub>  | 0.25     | -    | Power consumption in modes other than 'active mode'  |   |       |                                   |
| Off mode   |                  |          |      |  |   |       |                                   |
|  | P <sub>off</sub> | 0.024    | kW   | back-up heating capacity*  | elbu  | 0.7   | kW                                |
| Thermostat-off mode  | P <sub>to</sub>  | 0.090    | kW   | Type of energy input   |   |       |                                   |
| Crankcase heater mode  | P <sub>ck</sub>  | 0.000    | kW   | Standby mode   | P <sub>sb</sub>   | 0.024 | kW                                |
| Other items  |                  |          |      |  |   |       |                                   |
| Capacity control   |                  | variable |      | For air-to-air heat pumps: air flow rate, outdoor  |   | 6600  | m <sup>3</sup> /h                 |
| Sound power level, outdoor   | L <sub>WA</sub>  | 70.0     | dB   | For water-/brine-to-air heat pumps: Rated brine or water flow rate, outdoor side heat exchanger  |   | -     | m <sup>3</sup> /h                 |
| Sound power level, indoor  | L <sub>WA</sub>  | 56.0     | dB   | Emissions of nitrogen oxides (if applicable)   | NO <sub>x</sub> ***   | -     | mg/kWh fuel input GCV             |
|  |                  |          |      | GWP of the refrigerant   |   | 2088  | kg CO <sub>2</sub> eq (100 years) |
| Contact details  |                  |          |      | Panasonic Testing Centre, Panasonic Marketing Europe GmbH Winsbergiring 15, 22525 Hamburg, Germany   |   |       |                                   |
| ** If C <sub>dh</sub> is not determined by measurement then the default degradation coefficient of heat pumps shall be 0.25.   |                  |          |      |  |   |       |                                   |
| *** from 26 September 2018.  |                  |          |      |  |   |       |                                   |
| Where information relates to multi-split heat pumps, the test result and performance data may be obtained on the basis of the performance of the outdoor unit, with a combination of indoor unit(s) recommended by the manufacturer or importer. |                  |          |      |  |   |       |                                   |
| **** Refer to information requirements for UnitList  |                  |          |      |  |   |       |                                   |

### Information requirements for air-to-air air conditioners

|  |                             |                              |
|--|-----------------------------|------------------------------|
| Model(s):  | Outdoor Unit<br>Indoor Unit | U-140PE1E8A<br>S-50PF1E5A x3 |
| Outdoor side heat exchanger of air conditioner:  | air                         |                              |
| Indoor side heat exchanger of air conditioner:   | air                         |                              |
| Type: compressor driven vapour compression or sorption process   | vapour compression          |                              |
| if applicable: driver of compressor: [electric motor or fuel driven, gaseous or liquid fuel, internal or external combustion engine] | electric motor              |                              |

| Item  | Symbol                    | Value    | Unit | Item   | Symbol  | Value | Unit                              |
|---|---------------------------|----------|------|--|---|-------|-----------------------------------|
| Rated cooling capacity  | $P_{med,c}$               | 14.0     | kW   | Seasonal space cooling energy efficiency   | $\eta_{s,c}$  | 225.7 | %                                 |
| Refrigeration load  | $P_{design,c}$            | 14.0     | kW   | Declared energy efficiency ratio or gas utilization efficiency / auxiliary energy factor for part load at given outdoor temperatures $T_j$ and indoor $27^\circ/19^\circ\text{C}$ (dry/wet bulb) |   |       |                                   |
| Declared cooling capacity for part load at given outdoor temperatures $T_j$ and indoor $27^\circ/19^\circ\text{C}$ (dry/wet bulb) | $T_j = +35^\circ\text{C}$ | 14.0     | kW   | $T_j = +35^\circ\text{C}$  | EER <sub>d</sub> or GUE <sub>chb</sub> / AEF <sub>chb</sub> | 3.2   | %                                 |
|   | $T_j = +30^\circ\text{C}$ | 10.3     | kW   | $T_j = +30^\circ\text{C}$  |   | 4.6   | %                                 |
|   | $T_j = +25^\circ\text{C}$ | 6.6      | kW   | $T_j = +25^\circ\text{C}$  |   | 7.0   | %                                 |
|   | $T_j = +20^\circ\text{C}$ | 5.1      | kW   | $T_j = +20^\circ\text{C}$  |   | 9.8   | %                                 |
| Degradation co-efficient for air conditioners**   | $C_{dc}$                  | 0.25     | -    |  |   |       |                                   |
| Power consumption in modes other than 'active mode'   |                           |          |      |  |   |       |                                   |
| Off mode  | $P_{OFF}$                 | 0.024    | kW   | Crankcase heater mode  | $P_{CK}$  | 0.000 | kW                                |
| Thermostat-off mode   | $P_{TO}$                  | 0.090    | kW   | Standby mode   | $P_{SB}$  | 0.024 | kW                                |
| Other items   |                           |          |      |  |   |       |                                   |
| Capacity control  |                           | variable |      | For air-to-air air conditioner: air flow rate, outdoor   |   | 8100  | m <sup>3</sup> /h                 |
| Sound power level, outdoor  | $L_{WA}$                  | 71.0     | dB   |  |   |       |                                   |
| Sound power level, indoor   | $L_{WA}$                  | 56.0     | dB   | if engine driven: Emissions of nitrogen oxides   | $NO_x^{***}$  | -     | mg/kWh fuel input GCV             |
|   |                           |          |      | GWP of the refrigerant   |   | 2088  | kg CO <sub>2</sub> eq (100 years) |
| Contact details   |                           |          |      | Panasonic Testing Centre, Panasonic Marketing Europe GmbH Winsberggiring 15, 22525 Hamburg, Germany  |   |       |                                   |

\*\* If  $C_{dc}$  is not determined by measurement then the default degradation coefficient air conditioners shall be 0.25.  
 \*\*\* from 26 September 2018.  
 Where information relates to multi-split air conditioners, the test result and performance data may be obtained on the basis of the performance of the outdoor unit, with a combination of indoor unit(s) recommended by the manufacturer or importer.  
 \*\*\*\* Refer to Information requirements for UnitList

### Information requirements for heat pumps

|  |                             |                              |
|--|-----------------------------|------------------------------|
| Model(s):  | Outdoor Unit<br>Indoor Unit | U-140PE1E8A<br>S-50PF1E5A x3 |
| Outdoor side heat exchanger of heat pump:  | air                         |                              |
| Indoor side heat exchanger of heat pump:   | air                         |                              |
| Indication if the heater is equipped with a supplementary heater:  | no                          |                              |
| if applicable: driver of compressor: [electric motor or fuel driven, gaseous or liquid fuel, internal or external combustion engine] | electric motor              |                              |

Parameters shall be declared for the average heating season, parameters for the warmer and colder heating seasons are optional.

| Item  | Symbol                    | Value    | Unit | Item  | Symbol  | Value | Unit                              |
|---|---------------------------|----------|------|---|---|-------|-----------------------------------|
| Rated heating capacity  | $P_{med,h}$               | 16.0     | kW   | Seasonal space heating energy efficiency  | $\eta_{p,h}$  | 143.0 | %                                 |
| Refrigeration load  | $P_{design,h}$            | 14.0     | kW   | Declared coefficient of performance or gas utilization efficiency / auxiliary energy factor for part load at given outdoor temperatures $T_j$ |   |       |                                   |
| Declared heating capacity for part load at indoor temperature 20 °C and outdoor temperature $T_j$ | $T_j = -7^\circ\text{C}$  | 12.3     | kW   | $T_j = -7^\circ\text{C}$  | COP <sub>d</sub> or GUE <sub>h,db</sub> / AEF <sub>h,db</sub> | 2.3   | %                                 |
|   | $T_j = +2^\circ\text{C}$  | 7.5      | kW   | $T_j = +2^\circ\text{C}$  |   | 3.5   | %                                 |
|   | $T_j = +7^\circ\text{C}$  | 4.8      | kW   | $T_j = +7^\circ\text{C}$  |   | 5.1   | %                                 |
|   | $T_j = +12^\circ\text{C}$ | 4.4      | kW   | $T_j = +12^\circ\text{C}$   |   | 6.0   | %                                 |
| $T_{bw} =$ bivalent temperature   | $P_{db}$                  | 12.3     | kW   | $T_{bw} =$ bivalent temperature   |   | 2.3   | %                                 |
| $T_{ol} =$ operation limit  |                           | 10.0     | kW   | $T_{ol} =$ operation limit  |   | 1.7   | %                                 |
| For air-to-water heat pumps: $T_j = -15^\circ\text{C}$ (if $T_{ol} < -20^\circ\text{C}$ )         |                           | -        | kW   | For water-to-air heat pumps: $T_j = -15^\circ\text{C}$ (if $T_{ol} < -20^\circ\text{C}$ )   |   | -     | %                                 |
| Bivalent temperature  | $T_{bw}$                  | -7       | °C   | For water-to-air heat pumps: Operation limit temperature  | $T_{ol}$  | -20   | °C                                |
| Degradation co-efficient heat pumps**   | $C_{dh}$                  | 0.25     | -    |   |   |       |                                   |
| Power consumption in modes other than 'active mode'   |                           |          |      |   |   |       |                                   |
| Off mode  | $P_{OFF}$                 | 0.024    | kW   | Supplementary heater back-up heating capacity *   | elbu  | 2.3   | kW                                |
| Thermostat-off mode   | $P_{TO}$                  | 0.090    | kW   | Type of energy input  |   |       |                                   |
| Crankcase heater mode   | $P_{CK}$                  | 0.000    | kW   | Standby mode  | $P_{SB}$  | 0.024 | kW                                |
| Other items   |                           |          |      |   |   |       |                                   |
| Capacity control  |                           | variable |      | For air-to-air heat pumps: air flow rate, outdoor   |   | 7200  | m <sup>3</sup> /h                 |
| Sound power level, outdoor  | $L_{WA}$                  | 71.0     | dB   | For water-/brine-to-air heat pumps: Rated brine or water flow rate, outdoor side heat exchanger   |   | -     | m <sup>3</sup> /h                 |
| Sound power level, indoor   | $L_{WA}$                  | 56.0     | dB   | Emissions of nitrogen oxides (if applicable)  | $NO_x^{***}$  | -     | mg/kWh fuel input GCV             |
|   |                           |          |      | GWP of the refrigerant  |   | 2088  | kg CO <sub>2</sub> eq (100 years) |
| Contact details   |                           |          |      | Panasonic Testing Centre, Panasonic Marketing Europe GmbH Winsberggiring 15, 22525 Hamburg, Germany   |   |       |                                   |

\*\* If  $C_{dh}$  is not determined by measurement then the default degradation coefficient of heat pumps shall be 0.25.  
 \*\*\* from 26 September 2018.  
 Where information relates to multi-split heat pumps, the test result and performance data may be obtained on the basis of the performance of the outdoor unit, with a combination of indoor unit(s) recommended by the manufacturer or importer.  
 \*\*\*\* Refer to Information requirements for UnitList



## Information requirements for air-to-air air conditioners

|  |                             |                              |
|--|-----------------------------|------------------------------|
| Model(s):  | Outdoor Unit<br>Indoor Unit | U-125PE1E8A<br>S-60PF1E5A x2 |
| Outdoor side heat exchanger of air conditioner:  | air                         |                              |
| Indoor side heat exchanger of air conditioner:   | air                         |                              |
| Type: compressor driven vapour compression or sorption process   | vapour compression          |                              |
| if applicable: driver of compressor: [electric motor or fuel driven, gaseous or liquid fuel, internal or external combustion engine] | electric motor              |                              |

|  |                             |                              |
|--|-----------------------------|------------------------------|
| Model(s):  | Outdoor Unit<br>Indoor Unit | U-125PE1E8A<br>S-60PF1E5A x2 |
| Outdoor side heat exchanger of heat pump:  | air                         |                              |
| Indoor side heat exchanger of heat pump:   | air                         |                              |
| Indication if the heater is equipped with a supplementary heater:  | no                          |                              |
| if applicable: driver of compressor: [electric motor or fuel driven, gaseous or liquid fuel, internal or external combustion engine] | electric motor              |                              |
| Parameters shall be declared for the average heating season, parameters for the warmer and colder heating seasons are optional.      |                             |                              |

| Item   | Symbol                | Value    | Unit | Item  | Symbol  | Value               | Unit                              |
|--|-----------------------|----------|------|---|---|---------------------|-----------------------------------|
| Rated cooling capacity   | $P_{rated,c}$         | 12.5     | kW   | Seasonal space cooling energy efficiency  | $\eta_{s,c}$  | 233.4               | %                                 |
| Refrigeration load   | $P_{design,c}$        | 12.5     | kW   | Declared energy efficiency ratio or gas utilization efficiency / auxiliary energy factor for part load at given outdoor temperatures $T_j$ and indoor 27%/19°C (dry/wet bulb) |   |                     |                                   |
| Declared cooling capacity for part load at given outdoor temperatures $T_j$ and indoor 27%/19°C (dry/wet bulb) | $T_j = +35\text{ °C}$ | 12.5     | kW   | $T_j = +35\text{ °C}$   | EER <sub>o</sub> or GUE <sub>o,br</sub> / AEF <sub>o,br</sub> | 3.5                 | %                                 |
|  | $T_j = +30\text{ °C}$ | 9.2      | kW   | $T_j = +30\text{ °C}$   |   | 4.9                 | %                                 |
|  | $T_j = +25\text{ °C}$ | 5.9      | kW   | $T_j = +25\text{ °C}$   |   | 7.3                 | %                                 |
|  | $T_j = +20\text{ °C}$ | 5.1      | kW   | $T_j = +20\text{ °C}$   |   | 9.9                 | %                                 |
| Degradation co-efficient for air conditioners**  | $C_{dc}$              | 0.25     | -    | Power consumption in modes other than 'active mode'   |   |                     |                                   |
| Other items  |                       |          |      |   |   |                     |                                   |
| Off mode   | $P_{off}$             | 0.024    | kW   | Crankcase heater mode   | $P_{ck}$  | 0.000               | kW                                |
| Thermostat-off mode  | $P_{to}$              | 0.090    | kW   | Standby mode  | $P_{sb}$  | 0.024               | kW                                |
| Capacity control   |                       | variable |      | For air-to-air conditioner: air flow rate, outdoor  |   | 7800                | m <sup>3</sup> /h                 |
| Sound power level, outdoor   | $L_{WA}$              | 70.0     | dB   |   |   |                     |                                   |
| Sound power level, indoor  | $L_{WA}$              | 57.0     | dB   | if engine driven: Emissions of nitrogen oxides  |   | NO <sub>x</sub> *** | mg/kWh fuel input GCV             |
|  |                       |          |      | GWP of the refrigerant  |   | 2088                | kg CO <sub>2</sub> eq (100 years) |
| Contact details  |                       |          |      | Panasonic Testing Centre, Panasonic Marketing Europe GmbH Winsberggring 15, 22525 Hamburg, Germany  |   |                     |                                   |

\*\* If  $C_{dc}$  is not determined by measurement then the default degradation coefficient air conditioners shall be 0.25.

\*\*\* from 26 September 2018.

Where information relates to multi-split air conditioners, the test result and performance data may be obtained on the basis of the performance of the outdoor unit, with a combination of indoor unit(s) recommended by the manufacturer or importer.

\*\*\*\* Refer to Information requirements for UnitList

## Information requirements for heat pumps

|  |                             |                              |
|--|-----------------------------|------------------------------|
| Model(s):  | Outdoor Unit<br>Indoor Unit | U-125PE1E8A<br>S-60PF1E5A x2 |
| Outdoor side heat exchanger of heat pump:  | air                         |                              |
| Indoor side heat exchanger of heat pump:   | air                         |                              |
| Indication if the heater is equipped with a supplementary heater:  | no                          |                              |
| if applicable: driver of compressor: [electric motor or fuel driven, gaseous or liquid fuel, internal or external combustion engine] | electric motor              |                              |
| Parameters shall be declared for the average heating season, parameters for the warmer and colder heating seasons are optional.      |                             |                              |

| Item  | Symbol                | Value    | Unit | Item   | Symbol  | Value               | Unit                  |
|---|-----------------------|----------|------|--|---|---------------------|-----------------------|
| Rated heating capacity  | $P_{rated,h}$         | 14.0     | kW   | Seasonal space heating energy efficiency   | $\eta_{s,h}$  | 146.6               | %                     |
| Refrigeration load  | $P_{design,h}$        | 12.5     | kW   | Declared coefficient of performance or gas utilization efficiency / auxiliary energy factor for part load at given outdoor temperatures °C and outdoor temperature $T_j$ |   |                     |                       |
| Declared heating capacity for part load at indoor temperature 20 °C and outdoor temperature $T_j$ | $T_j = -7\text{ °C}$  | 11.0     | kW   | $T_j = -7\text{ °C}$   | COP <sub>o</sub> or GUE <sub>o,br</sub> / AEF <sub>o,br</sub> | 2.4                 | %                     |
|   | $T_j = +2\text{ °C}$  | 6.7      | kW   | $T_j = +2\text{ °C}$   |   | 3.6                 | %                     |
|   | $T_j = +7\text{ °C}$  | 4.3      | kW   | $T_j = +7\text{ °C}$   |   | 5.1                 | %                     |
|   | $T_j = +12\text{ °C}$ | 4.4      | kW   | $T_j = +12\text{ °C}$  |   | 6.1                 | %                     |
| Degradation co-efficient for heat pumps**   | $C_{dh}$              | 0.25     | -    | Power consumption in modes other than 'active mode'  |   |                     |                       |
| Other items   |                       |          |      |  |   |                     |                       |
| Off mode  | $P_{off}$             | 0.024    | kW   | Supplementary heater   |   |                     |                       |
| Thermostat-off mode   | $P_{to}$              | 0.090    | kW   | back-up heating capacity *   | eibu  | 0.7                 | kW                    |
| Crankcase heater mode   | $P_{ck}$              | 0.000    | kW   | Type of energy input   |   |                     |                       |
| Capacity control  |                       | variable |      | Standby mode   | $P_{sb}$  | 0.024               | kW                    |
| Sound power level, outdoor  | $L_{WA}$              | 70.0     | dB   | For air-to-air heat pumps: air flow rate, outdoor  |   |                     |                       |
| Sound power level, indoor   | $L_{WA}$              | 57.0     | dB   | For water-/brine-to-air heat pumps: Rated brine or water flow rate, outdoor side heat exchanger  |   |                     | m <sup>3</sup> /h     |
|   |                       |          |      | Emissions of nitrogen oxides (if applicable)   |   | NO <sub>x</sub> *** | mg/kWh fuel input GCV |
| Contact details   |                       |          |      | Panasonic Testing Centre, Panasonic Marketing Europe GmbH Winsberggring 15, 22525 Hamburg, Germany   |   |                     |                       |

\*\* If  $C_{dh}$  is not determined by measurement then the default degradation coefficient of heat pumps shall be 0.25.

\*\*\* from 26 September 2018.

Where information relates to multi-split heat pumps, the test result and performance data may be obtained on the basis of the performance of the outdoor unit, with a combination of indoor unit(s) recommended by the manufacturer or importer.

\*\*\*\* Refer to Information requirements for UnitList



### Information requirements for air-to-air air conditioners

Model(s): Outdoor Unit U-125PE1E8A  
Indoor Unit S-125PF1E5A

Outdoor side heat exchanger of air conditioner: air  
Indoor side heat exchanger of air conditioner: air  
Type: compressor driven vapour compression or sorption process vapour compression  
if applicable: driver of compressor: [electric motor or fuel driven, gaseous or liquid fuel, internal or external combustion engine] electric motor

| Item   | Symbol                | Value     | Unit  | Item  | Symbol  | Value               | Unit  |    |
|--|-----------------------|-----------|-------|---|---|---------------------|-------|----|
| Rated cooling capacity   | $P_{med,c}$           | 12.5      | kW    | Seasonal space cooling energy efficiency  | $\eta_{s,c}$  | 219.0               | %     |    |
| Refrigeration load   | $P_{design,c}$        | 12.5      | kW    | Declared energy efficiency ratio or gas utilization efficiency / auxiliary energy factor for part load at given outdoor temperatures $T_j$ and indoor 27°/19°C (dry/wet bulb) |   |                     |       |    |
| Declared cooling capacity for part load at given outdoor temperatures $T_j$ and indoor 27°/19°C (dry/wet bulb) | $T_j = +35\text{ °C}$ | 12.5      | kW    | $T_j = +35\text{ °C}$   |   | 3.5                 | %     |    |
|  | $T_j = +30\text{ °C}$ | 9.2       | kW    | $T_j = +30\text{ °C}$   | EER <sub>0</sub> or GUE <sub>0,db</sub> / AEF <sub>0,db</sub> | 4.9                 | %     |    |
|  | $T_j = +25\text{ °C}$ | 5.9       | kW    | $T_j = +25\text{ °C}$   |   | 7.3                 | %     |    |
|  | $T_j = +20\text{ °C}$ | 5.1       | kW    | $T_j = +20\text{ °C}$   |   | 9.9                 | %     |    |
| Degradation co-efficient for air conditioners**  | $C_{de}$              | 0.25      | -     | Declared heating capacity for part load at indoor temperature 20 °C and outdoor temperature $T_j$   |   |                     |       |    |
| Declared heating capacity for part load at indoor temperature 20 °C and outdoor temperature $T_j$              | $T_j = -7\text{ °C}$  | 11.0      | kW    | $T_j = -7\text{ °C}$  |   | 2.4                 | %     |    |
|  | $T_j = +2\text{ °C}$  | 6.7       | kW    | $T_j = +2\text{ °C}$  |   | 3.6                 | %     |    |
|  | $T_j = +7\text{ °C}$  | 4.3       | kW    | $T_j = +7\text{ °C}$  |   | 5.1                 | %     |    |
|  | $T_j = +12\text{ °C}$ | 4.4       | kW    | $T_j = +12\text{ °C}$   |   | 6.1                 | %     |    |
| $T_{bv} = \text{bivalent temperature}$   |                       | 12.0      | kW    | $T_{bv} = \text{bivalent temperature}$  |   | 2.2                 | %     |    |
| $T_{ol} = \text{operation limit}$  |                       | 9.8       | kW    | $T_{ol} = \text{operation limit}$   |   | 1.7                 | %     |    |
| For air-to-water heat pumps: $T_j = -15\text{ °C}$ (if $T_{ol} < -20\text{ °C}$ )                              |                       | -         | kW    | For water-to-air heat pumps: $T_j = -15\text{ °C}$ (if $T_{ol} < -20\text{ °C}$ )   |   | -                   | %     |    |
| Bivalent temperature   | $T_{bv}$              | -9        | °C    | Operation limit temperature   | $T_{ol}$  | -20                 | °C    |    |
| Degradation co-efficient heat pumps**  | $C_{de}$              | 0.25      | -     | Power consumption in modes other than 'active mode'   |   |                     |       |    |
| Power consumption in modes other than 'active mode'  | Off mode              | $P_{off}$ | 0.024 | kW  | Crankcase heater mode   | $P_{ck}$            | 0.000 | kW |
|  | Thermostat-off mode   | $P_{to}$  | 0.215 | kW  | Standby mode  | $P_{sb}$            | 0.024 | kW |
|  | Crankcase heater mode | $P_{ck}$  | 0.000 | kW  | Standby mode  | $P_{sb}$            | 0.024 | kW |
| Other items  |                       |           |       |   |   |                     |       |    |
| Capacity control   |                       | variable  |       | For air-to-air air conditioner: air flow rate, outdoor  |   | 7800                | m³/h  |    |
| Sound power level, outdoor   | $L_{WA}$              | 70.0      | dB    |   |   |                     |       |    |
| Sound power level, indoor  | $L_{WA}$              | 61.0      | dB    | if engine driven: Emissions of nitrogen oxides  |   | NO <sub>x</sub> *** |       |    |
|  |                       |           |       | GWP of the refrigerant  |   |                     | 2088  |    |
| Contact details  |                       |           |       | Panasonic Testing Centre, Panasonic Marketing Europe GmbH Winsberggiring 15, 22525 Hamburg, Germany   |   |                     |       |    |

\*\* If  $C_{de}$  is not determined by measurement then the default degradation coefficient air conditioners shall be 0.25.  
\*\*\* from 26 September 2018.  
Where information relates to multi-split air conditioners, the test result and performance data may be obtained on the basis of the performance of the outdoor unit, with a combination of indoor unit(s) recommended by the manufacturer or importer.  
\*\*\*\* Refer to information requirements for UnitLi.st

### Information requirements for heat pumps

Model(s): Outdoor Unit U-125PE1E8A  
Indoor Unit S-125PF1E5A

Outdoor side heat exchanger of heat pump: air  
Indoor side heat exchanger of heat pump: air  
Indication if the heater is equipped with a supplementary heater: no  
if applicable: driver of compressor: [electric motor or fuel driven, gaseous or liquid fuel, internal or external combustion engine] electric motor

Parameters shall be declared for the average heating season, parameters for the warmer and colder heating seasons are optional.

| Item  | Symbol                | Value     | Unit  | Item  | Symbol                     | Value               | Unit |    |
|---|-----------------------|-----------|-------|---|----------------------------|---------------------|------|----|
| Rated heating capacity  | $P_{med,h}$           | 14.0      | kW    | Seasonal space heating energy efficiency  | $\eta_{s,h}$               | 145.9               | %    |    |
| Refrigeration load  | $P_{design,h}$        | 12.5      | kW    | Declared coefficient of performance or gas utilization efficiency / auxiliary energy factor for part load at given outdoor temperatures $T_j$ |                            |                     |      |    |
| Declared heating capacity for part load at indoor temperature 20 °C and outdoor temperature $T_j$ | $T_j = -7\text{ °C}$  | 11.0      | kW    | $T_j = -7\text{ °C}$  |                            | 2.4                 | %    |    |
|   | $T_j = +2\text{ °C}$  | 6.7       | kW    | $T_j = +2\text{ °C}$  |                            | 3.6                 | %    |    |
|   | $T_j = +7\text{ °C}$  | 4.3       | kW    | $T_j = +7\text{ °C}$  |                            | 5.1                 | %    |    |
|   | $T_j = +12\text{ °C}$ | 4.4       | kW    | $T_j = +12\text{ °C}$   |                            | 6.1                 | %    |    |
| $T_{bv} = \text{bivalent temperature}$  |                       | 12.0      | kW    | $T_{bv} = \text{bivalent temperature}$  |                            | 2.2                 | %    |    |
| $T_{ol} = \text{operation limit}$   |                       | 9.8       | kW    | $T_{ol} = \text{operation limit}$   |                            | 1.7                 | %    |    |
| For air-to-water heat pumps: $T_j = -15\text{ °C}$ (if $T_{ol} < -20\text{ °C}$ )                 |                       | -         | kW    | For water-to-air heat pumps: $T_j = -15\text{ °C}$ (if $T_{ol} < -20\text{ °C}$ )   |                            | -                   | %    |    |
| Bivalent temperature  | $T_{bv}$              | -9        | °C    | Operation limit temperature   | $T_{ol}$                   | -20                 | °C   |    |
| Degradation co-efficient heat pumps**   | $C_{de}$              | 0.25      | -     | Power consumption in modes other than 'active mode'   |                            |                     |      |    |
| Power consumption in modes other than 'active mode'   | Off mode              | $P_{off}$ | 0.024 | kW  | Supplementary heater       |                     |      |    |
|   | Thermostat-off mode   | $P_{to}$  | 0.215 | kW  | back-up heating capacity * | elbu                | 0.7  | kW |
|   | Crankcase heater mode | $P_{ck}$  | 0.000 | kW  | Type of energy input       |                     |      |    |
| Other items   |                       |           |       |   |                            |                     |      |    |
| Capacity control  |                       | variable  |       | For air-to-air heat pumps: air flow rate, outdoor   |                            | 6600                | m³/h |    |
| Sound power level, outdoor  | $L_{WA}$              | 70.0      | dB    | For water-/brine-to-air heat pumps: Rated brine or water flow rate, outdoor side heat exchanger   |                            | -                   | m³/h |    |
| Sound power level, indoor   | $L_{WA}$              | 61.0      | dB    | Emissions of nitrogen oxides (if applicable)  |                            | NO <sub>x</sub> *** |      |    |
|   |                       |           |       | GWP of the refrigerant  |                            |                     | 2088 |    |
| Contact details   |                       |           |       | Panasonic Testing Centre, Panasonic Marketing Europe GmbH Winsberggiring 15, 22525 Hamburg, Germany   |                            |                     |      |    |

\*\* If  $C_{de}$  is not determined by measurement then the default degradation coefficient of heat pumps shall be 0.25.  
\*\*\* from 26 September 2018.  
Where information relates to multi-split heat pumps, the test result and performance data may be obtained on the basis of the performance of the outdoor unit, with a combination of indoor unit(s) recommended by the manufacturer or importer.  
\*\*\*\* Refer to information requirements for UnitLi.st

## Information requirements for air-to-air air conditioners

|  |                             |                            |
|--|-----------------------------|----------------------------|
| Model(s):  | Outdoor Unit<br>Indoor Unit | U-140PE1E8A<br>S-140PF1E5A |
| Outdoor side heat exchanger of air conditioner:  | air                         |                            |
| Indoor side heat exchanger of air conditioner:   | air                         |                            |
| Type: compressor driven vapour compression or sorption process   | vapour compression          |                            |
| if applicable: driver of compressor: [electric motor or fuel driven, gaseous or liquid fuel, internal or external combustion engine] | electric motor              |                            |

## Information requirements for heat pumps

|  |                             |                            |
|--|-----------------------------|----------------------------|
| Model(s):  | Outdoor Unit<br>Indoor Unit | U-140PE1E8A<br>S-140PF1E5A |
| Outdoor side heat exchanger of heat pump:  | air                         |                            |
| Indoor side heat exchanger of heat pump:   | air                         |                            |
| Indication if the heater is equipped with a supplementary heater:  | no                          |                            |
| if applicable: driver of compressor: [electric motor or fuel driven, gaseous or liquid fuel, internal or external combustion engine] | electric motor              |                            |

Parameters shall be declared for the average heating season, parameters for the warmer and colder heating seasons are optional.

| Item   | Symbol         | Value    | Unit | Item   | Symbol       | Value | Unit                              |
|--|----------------|----------|------|--|--------------|-------|-----------------------------------|
| Rated cooling capacity   | $P_{rated,c}$  | 14.0     | kW   | Seasonal space cooling efficiency  | $\eta_{s,c}$ | 212.8 | %                                 |
| Refrigeration load   | $P_{design,c}$ | 14.0     | kW   |  |              |       |                                   |
| Declared cooling capacity for part load at given outdoor temperatures $T_{j,indoor}$ and indoor 27%/19°C (dry/wet bulb)                    |                |          |      |  |              |       |                                   |
| $T_j = +35\text{ °C}$  |                | 14.0     | kW   | $T_j = +35\text{ °C}$  |              | 3.2   | %                                 |
| $T_j = +30\text{ °C}$  |                | 10.3     | kW   | $T_j = +30\text{ °C}$  |              | 4.6   | %                                 |
| $T_j = +25\text{ °C}$  | $P_{dc}$       | 6.6      | kW   | $T_j = +25\text{ °C}$  |              | 7.0   | %                                 |
| $T_j = +20\text{ °C}$  |                | 5.1      | kW   | $T_j = +20\text{ °C}$  |              | 9.8   | %                                 |
| Degradation co-efficient for air conditioners**  | $C_{dc}$       | 0.25     | -    |  |              |       |                                   |
| Declared energy efficiency ratio or gas utilization efficiency / auxiliary energy factor for part load at given outdoor temperatures $T_j$ |                |          |      |  |              |       |                                   |
| $T_j = -7\text{ °C}$   |                | 12.3     | kW   | $T_j = -7\text{ °C}$   |              | 2.3   | %                                 |
| $T_j = +2\text{ °C}$   |                | 7.5      | kW   | $T_j = +2\text{ °C}$   |              | 3.5   | %                                 |
| $T_j = +7\text{ °C}$   |                | 4.8      | kW   | $T_j = +7\text{ °C}$   |              | 5.1   | %                                 |
| $T_j = +12\text{ °C}$  |                | 4.4      | kW   | $T_j = +12\text{ °C}$  |              | 6.0   | %                                 |
| $T_{bw} = \text{bivalent temperature}$   | $P_{bh}$       | 12.3     | kW   | $T_{bw} = \text{bivalent temperature}$   |              | 2.3   | %                                 |
| $T_{ol} = \text{operation limit}$  |                | 10.0     | kW   | $T_{ol} = \text{operation limit}$  |              | 1.7   | %                                 |
| For air-to-water heat pumps:<br>$T_j = -15\text{ °C}$ (if $T_{ol} < -20\text{ °C}$ )   |                | -        | kW   | For water-to-air heat pumps:<br>$T_j = -15\text{ °C}$ (if $T_{ol} < -20\text{ °C}$ ) |              | -     | %                                 |
| Bivalent temperature   | $T_{bw}$       | -7       | °C   | For water-to-air heat pumps:<br>Operation limit temperature                          | $T_{ol}$     | -20   | °C                                |
| Degradation co-efficient heat pumps**  | $C_{bh}$       | 0.25     | -    |  |              |       |                                   |
| Power consumption in modes other than 'active mode'  |                |          |      |  |              |       |                                   |
| Off mode   | $P_{off}$      | 0.024    | kW   | Crankcase heater mode  | $P_{ck}$     | 0.000 | kW                                |
| Thermostat-off mode  | $P_{to}$       | 0.223    | kW   | Standby mode   | $P_{sb}$     | 0.024 | kW                                |
| Other items  |                |          |      |  |              |       |                                   |
| Capacity control   |                | variable |      | For air-to-air conditioner: air flow rate, outdoor                                   |              | 8100  | m <sup>3</sup> /h                 |
| Sound power level, outdoor   | $L_{WA}$       | 71.0     | dB   |  |              |       |                                   |
| Sound power level, indoor  | $L_{WA}$       | 62.0     | dB   | if engine driven: Emissions of nitrogen oxides                                       | $NO_x^{***}$ | -     | mg/kWh fuel input GCV             |
|  |                |          |      | GWP of the refrigerant   |              | 2088  | kg CO <sub>2</sub> eq (100 years) |
| Contact details Panasonic Testing Centre, Panasonic Marketing Europe GmbH Winsberggring 15, 22525 Hamburg, Germany                         |                |          |      |  |              |       |                                   |

\*\* If  $C_{dc}$  is not determined by measurement then the default degradation coefficient air conditioners shall be 0.25.

\*\*\* from 26 September 2018.

Where information relates to multi-split air conditioners, the test result and performance data may be obtained on the basis of the performance of the outdoor unit, with a combination of indoor unit(s) recommended by the manufacturer or importer.

\*\*\*\* Refer to information requirements for UnitList

| Item   | Symbol         | Value    | Unit | Item  | Symbol       | Value | Unit                              |
|--|----------------|----------|------|---|--------------|-------|-----------------------------------|
| Rated heating capacity   | $P_{rated,h}$  | 16.0     | kW   | Seasonal space heating energy efficiency  | $\eta_{s,h}$ | 142.3 | %                                 |
| Refrigeration load   | $P_{design,h}$ | 14.0     | kW   |   |              |       |                                   |
| Declared heating capacity for part load at indoor temperature 20 °C and outdoor temperature $T_j$                  |                |          |      |   |              |       |                                   |
| $T_j = -7\text{ °C}$   |                | 12.3     | kW   | $T_j = -7\text{ °C}$  |              | 2.3   | %                                 |
| $T_j = +2\text{ °C}$   |                | 7.5      | kW   | $T_j = +2\text{ °C}$  |              | 3.5   | %                                 |
| $T_j = +7\text{ °C}$   |                | 4.8      | kW   | $T_j = +7\text{ °C}$  |              | 5.1   | %                                 |
| $T_j = +12\text{ °C}$  |                | 4.4      | kW   | $T_j = +12\text{ °C}$   |              | 6.0   | %                                 |
| $T_{bw} = \text{bivalent temperature}$   | $P_{bh}$       | 12.3     | kW   | $T_{bw} = \text{bivalent temperature}$  |              | 2.3   | %                                 |
| $T_{ol} = \text{operation limit}$  |                | 10.0     | kW   | $T_{ol} = \text{operation limit}$   |              | 1.7   | %                                 |
| For air-to-water heat pumps:<br>$T_j = -15\text{ °C}$ (if $T_{ol} < -20\text{ °C}$ )                               |                | -        | kW   | For water-to-air heat pumps:<br>$T_j = -15\text{ °C}$ (if $T_{ol} < -20\text{ °C}$ )            |              | -     | %                                 |
| Bivalent temperature   | $T_{bw}$       | -7       | °C   | For water-to-air heat pumps:<br>Operation limit temperature                                     | $T_{ol}$     | -20   | °C                                |
| Degradation co-efficient heat pumps**  | $C_{bh}$       | 0.25     | -    |   |              |       |                                   |
| Power consumption in modes other than 'active mode'  |                |          |      |   |              |       |                                   |
| Off mode   | $P_{off}$      | 0.024    | kW   | Supplementary heater  |              |       |                                   |
| Thermostat-off mode  | $P_{to}$       | 0.223    | kW   | back-up heating capacity*   | elbu         | 2.3   | kW                                |
| Crackcase heater mode  | $P_{ck}$       | 0.000    | kW   | Type of energy input  |              |       |                                   |
| Other items  |                |          |      |   |              |       |                                   |
| Capacity control   |                | variable |      | For air-to-air heat pumps:<br>air flow rate, outdoor  |              | 7200  | m <sup>3</sup> /h                 |
| Sound power level, outdoor   | $L_{WA}$       | 71.0     | dB   | For water-/brine-to-air heat pumps: Rated brine or water flow rate, outdoor side heat exchanger |              | -     | m <sup>3</sup> /h                 |
| Sound power level, indoor  | $L_{WA}$       | 62.0     | dB   | Emissions of nitrogen oxides (if applicable)  | $NO_x^{***}$ | -     | mg/kWh fuel input GCV             |
|  |                |          |      | GWP of the refrigerant  |              | 2088  | kg CO <sub>2</sub> eq (100 years) |
| Contact details Panasonic Testing Centre, Panasonic Marketing Europe GmbH Winsberggring 15, 22525 Hamburg, Germany |                |          |      |   |              |       |                                   |

\*\* If  $C_{bh}$  is not determined by measurement then the default degradation coefficient of heat pumps shall be 0.25.

\*\*\* from 26 September 2018.

Where information relates to multi-split heat pumps, the test result and performance data may be obtained on the basis of the performance of the outdoor unit, with a combination of indoor unit(s) recommended by the manufacturer or importer.

\*\*\*\* Refer to information requirements for UnitList

## Information requirements for air-to-air air conditioners

|  |                             |                              |
|--|-----------------------------|------------------------------|
| Model(s):  | Outdoor Unit<br>Indoor Unit | U-125PE1E5A<br>S-36PN1E5A x4 |
| Outdoor side heat exchanger of air conditioner:  | air                         |                              |
| Indoor side heat exchanger of air conditioner:   | vapour compression          |                              |
| Type: compressor driven vapour compression or sorption process   | electric motor              |                              |
| if applicable: driver of compressor: [electric motor or fuel driven, gaseous or liquid fuel, internal or external combustion engine] |                             |                              |

| Item   | Symbol  | Value    | Unit | Item  | Symbol  | Value | Unit                              |
|--|---|----------|------|---|---|-------|-----------------------------------|
| Rated cooling capacity   | $P_{med,c}$   | 12.5     | kW   | Seasonal space cooling energy efficiency  | $\eta_{s,c}$  | 229.0 | %                                 |
| Refrigeration load   | $P_{design,c}$  | 12.5     | kW   | Declared energy efficiency ratio or gas utilization efficiency / auxiliary energy factor for part load at given outdoor temperatures $T_j$ and indoor 27°/19°C (dry/wet bulb) |   |       |                                   |
| Declared cooling capacity for part load at given outdoor temperatures $T_j$ and indoor 27°/19°C (dry/wet bulb) | $T_j = +35\text{ °C}$   | 12.5     | kW   | $T_j = +35\text{ °C}$   | EER <sub>d</sub> or GUE <sub>d,h,h</sub> / AEF <sub>d,h,h</sub> | 3.2   | %                                 |
|  | $T_j = +30\text{ °C}$   | 9.2      | kW   | $T_j = +30\text{ °C}$   |   | 4.8   | %                                 |
|  | $T_j = +25\text{ °C}$   | 5.9      | kW   | $T_j = +25\text{ °C}$   |   | 7.2   | %                                 |
|  | $T_j = +20\text{ °C}$   | 5.2      | kW   | $T_j = +20\text{ °C}$   |   | 9.8   | %                                 |
| Degradation co-efficient for air conditioners**  | $C_{de}$  | 0.25     | -    |   |   |       |                                   |
| Power consumption in modes other than 'active mode'  |   |          |      |   |   |       |                                   |
| Off mode   | $P_{off}$   | 0.020    | kW   | Crankcase heater mode   | $P_{ck}$  | 0.000 | kW                                |
| Thermostat-off mode  | $P_{to}$  | 0.090    | kW   | Standby mode  | $P_{sb}$  | 0.020 | kW                                |
| Other items  |   |          |      |   |   |       |                                   |
| Capacity control   |   | variable |      | For air-to-air air conditioner: air flow rate, outdoor  |   | 4591  | m <sup>3</sup> /h                 |
| Sound power level, outdoor   | $L_{WA}$  | 70.0     | dB   |   |   |       |                                   |
| Sound power level, indoor  | $L_{WA}$  | 57.0     | dB   | if engine driven: Emissions of nitrogen oxides  | $NO_x^{***}$  | -     | mg/kWh fuel input GCV             |
|  |   |          |      | GWP of the refrigerant  |   | 2088  | kg CO <sub>2</sub> eq (100 years) |
| Contact details  | Panasonic Testing Centre, Panasonic Marketing Europe GmbH Winsberggiring 15, 22525 Hamburg, Germany |          |      |   |   |       |                                   |

\*\* If  $C_{de}$  is not determined by measurement then the default degradation coefficient air conditioners shall be 0.25.  
 \*\*\* from 26 September 2018.  
 Where information relates to multi-split air conditioners, the test result and performance data may be obtained on the basis of the performance of the outdoor unit, with a combination of indoor unit(s) recommended by the manufacturer or importer.  
 \*\*\*\* Refer to Information requirements for UnitList

## Information requirements for heat pumps

|  |                             |                              |
|--|-----------------------------|------------------------------|
| Model(s):  | Outdoor Unit<br>Indoor Unit | U-125PE1E5A<br>S-36PN1E5A x4 |
| Outdoor side heat exchanger of heat pump:  | air                         |                              |
| Indoor side heat exchanger of heat pump:   | air                         |                              |
| Indication if the heater is equipped with a supplementary heater:  | no                          |                              |
| if applicable: driver of compressor: [electric motor or fuel driven, gaseous or liquid fuel, internal or external combustion engine] | electric motor              |                              |
| Parameters shall be declared for the average heating season, parameters for the warmer and colder heating seasons are optional.      |                             |                              |

| Item  | Symbol  | Value    | Unit | Item  | Symbol  | Value | Unit                              |
|---|---|----------|------|---|---|-------|-----------------------------------|
| Rated heating capacity  | $P_{med,h}$   | 14.0     | kW   | Seasonal space heating energy efficiency  | $\eta_{s,h}$  | 144.1 | %                                 |
| Refrigeration load  | $P_{design,h}$  | 12.5     | kW   | Declared coefficient of performance or gas utilization efficiency / auxiliary energy factor for part load at given outdoor temperatures $T_j$ |   |       |                                   |
| Declared heating capacity for part load at indoor temperature 20 °C and outdoor temperature $T_j$ | $T_j = -7\text{ °C}$  | 11.0     | kW   | $T_j = -7\text{ °C}$  | COP <sub>d</sub> or GUE <sub>d,h,h</sub> / AEF <sub>d,h,h</sub> | 2.4   | %                                 |
|   | $T_j = +2\text{ °C}$  | 6.7      | kW   | $T_j = +2\text{ °C}$  |   | 3.5   | %                                 |
|   | $T_j = +7\text{ °C}$  | 4.3      | kW   | $T_j = +7\text{ °C}$  |   | 5.1   | %                                 |
|   | $T_j = +12\text{ °C}$   | 4.5      | kW   | $T_j = +12\text{ °C}$   |   | 6.1   | %                                 |
| Degradation co-efficient for heat pumps**   | $C_{de}$  | 0.25     | -    |   |   |       |                                   |
| Power consumption in modes other than 'active mode'   |   |          |      |   |   |       |                                   |
| Off mode  | $P_{off}$   | 0.020    | kW   | Supplementary heater back-up heating capacity *   | $el_{bu}$   | 2.0   | kW                                |
| Thermostat-off mode   | $P_{to}$  | 0.090    | kW   | Type of energy input  |   |       |                                   |
| Crankcase heater mode   | $P_{ck}$  | 0.000    | kW   | Standby mode  | $P_{sb}$  | 0.020 | kW                                |
| Other items   |   |          |      |   |   |       |                                   |
| Capacity control  |   | variable |      | For air-to-air heat pumps: air flow rate, outdoor   |   | 3385  | m <sup>3</sup> /h                 |
| Sound power level, outdoor  | $L_{WA}$  | 70.0     | dB   | For water-/brine-to-air heat pumps: Rated brine or water flow rate, outdoor side heat exchanger   |   | -     | m <sup>3</sup> /h                 |
| Sound power level, indoor   | $L_{WA}$  | 57.0     | dB   | Emissions of nitrogen oxides (if applicable)  | $NO_x^{***}$  | -     | mg/kWh fuel input GCV             |
|   |   |          |      | GWP of the refrigerant  |   | 2088  | kg CO <sub>2</sub> eq (100 years) |
| Contact details   | Panasonic Testing Centre, Panasonic Marketing Europe GmbH Winsberggiring 15, 22525 Hamburg, Germany |          |      |   |   |       |                                   |

\*\* If  $C_{de}$  is not determined by measurement then the default degradation coefficient of heat pumps shall be 0.25.  
 \*\*\* from 26 September 2018.  
 Where information relates to multi-split heat pumps, the test result and performance data may be obtained on the basis of the performance of the outdoor unit, with a combination of indoor unit(s) recommended by the manufacturer or importer.  
 \*\*\*\* Refer to Information requirements for UnitList

## Information requirements for air-to-air air conditioners

|  |                             |                              |
|--|-----------------------------|------------------------------|
| Model(s):  | Outdoor Unit<br>Indoor Unit | U-125PE1E5A<br>S-45PN1E5A x3 |
| Outdoor side heat exchanger of air conditioner:  | air                         |                              |
| Indoor side heat exchanger of air conditioner:   | vapour compression          |                              |
| Type: compressor driven vapour compression or sorption process   | electric motor              |                              |
| if applicable: driver of compressor: [electric motor or fuel driven, gaseous or liquid fuel, internal or external combustion engine] |                             |                              |

## Information requirements for heat pumps

|  |                             |                              |
|--|-----------------------------|------------------------------|
| Model(s):  | Outdoor Unit<br>Indoor Unit | U-125PE1E5A<br>S-45PN1E5A x3 |
| Outdoor side heat exchanger of heat pump:  | air                         |                              |
| Indoor side heat exchanger of heat pump:   | air                         |                              |
| Indication if the heater is equipped with a supplementary heater:  | no                          |                              |
| if applicable: driver of compressor: [electric motor or fuel driven, gaseous or liquid fuel, internal or external combustion engine] | electric motor              |                              |
| Parameters shall be declared for the average heating season, parameters for the warmer and colder heating seasons are optional.      |                             |                              |

| Item   | Symbol                            | Value    | Unit | Item  | Symbol  | Value | Unit                              |
|--|-----------------------------------|----------|------|---|---|-------|-----------------------------------|
| Rated cooling capacity   | $P_{med,c}$                       | 12.5     | kW   | Seasonal space cooling energy efficiency  | $\eta_{s,c}$  | 229.0 | %                                 |
| Refrigeration load   | $P_{design,c}$                    | 12.5     | kW   | Declared energy efficiency ratio or gas utilization efficiency / auxiliary energy factor for part load at given outdoor temperatures $T_j$ and indoor 27°/19°C (dry/wet bulb) |   |       |                                   |
| Declared cooling capacity for part load at given outdoor temperatures $T_j$ and indoor 27°/19°C (dry/wet bulb) | $T_j = +35\text{ °C}$             | 12.5     | kW   | $T_j = +35\text{ °C}$   | EER <sub>d</sub> or<br>GUE <sub>d,br</sub> /<br>AEF <sub>d,br</sub> | 3.2   | %                                 |
|  | $T_j = +30\text{ °C}$             | 9.2      | kW   | $T_j = +30\text{ °C}$   |   | 4.8   | %                                 |
|  | $T_j = +25\text{ °C}$             | 5.9      | kW   | $T_j = +25\text{ °C}$   |   | 7.2   | %                                 |
|  | $T_j = +20\text{ °C}$             | 5.2      | kW   | $T_j = +20\text{ °C}$   |   | 9.8   | %                                 |
| Degradation co-efficient for air conditioners**  | $C_{de}$                          | 0.25     | -    |   |   |       |                                   |
| Power consumption in modes other than 'active mode'  |                                   |          |      |   |   |       |                                   |
| Off mode   | $P_{off}$                         | 0.020    | kW   | Crankcase heater mode   | $P_{ck}$  | 0.000 | kW                                |
| Thermostat-off mode  | $P_{to}$                          | 0.090    | kW   | Standby mode  | $P_{sb}$  | 0.020 | kW                                |
| Other items  |                                   |          |      |   |   |       |                                   |
| Capacity control   |                                   | variable |      | For air-to-air air conditioner: air flow rate, outdoor  |   | 4591  | m <sup>3</sup> /h                 |
| Sound power level, outdoor   | $L_{WA}$                          | 70.0     | dB   |   |   |       |                                   |
| Sound power level, indoor  | $L_{WA}$                          | 56.0     | dB   | if engine driven: Emissions of nitrogen oxides  | $NO_x^{***}$  | -     | mg/kWh fuel input GCV             |
|  |                                   |          |      | GWP of the refrigerant  |   | 2088  | Kg CO <sub>2</sub> eq (100 years) |
| Contact details  | Panasonic Testing Centre, Germany |          |      | Panasonic Marketing Europe GmbH Winsberggring 15, 22525 Hamburg, Germany  |   |       |                                   |

\*\* If  $C_{de}$  is not determined by measurement then the default degradation coefficient air conditioners shall be 0.25.

\*\*\* from 26 September 2018.

Where information relates to multi-split air conditioners, the test result and performance data may be obtained on the basis of the performance of the outdoor unit, with a combination of indoor unit(s) recommended by the manufacturer or importer.

\*\*\*\* Refer to Information requirements for UnitList

| Item  | Symbol                            | Value    | Unit | Item  | Symbol  | Value | Unit                              |
|---|-----------------------------------|----------|------|---|---|-------|-----------------------------------|
| Rated heating capacity  | $P_{med,h}$                       | 14.0     | kW   | Seasonal space heating energy efficiency  | $\eta_{s,h}$  | 144.1 | %                                 |
| Refrigeration load  | $P_{design,h}$                    | 12.5     | kW   | Declared coefficient of performance or gas utilization efficiency / auxiliary energy factor for part load at given outdoor temperatures $T_j$ |   |       |                                   |
| Declared heating capacity for part load at indoor temperature 20 °C and outdoor temperature $T_j$ | $T_j = -7\text{ °C}$              | 11.0     | kW   | $T_j = -7\text{ °C}$  | COP <sub>d</sub> or<br>GUE <sub>d,br</sub> /<br>AEF <sub>d,br</sub> | 2.4   | %                                 |
|   | $T_j = +2\text{ °C}$              | 6.7      | kW   | $T_j = +2\text{ °C}$  |   | 3.5   | %                                 |
|   | $T_j = +7\text{ °C}$              | 4.3      | kW   | $T_j = +7\text{ °C}$  |   | 5.1   | %                                 |
|   | $T_j = +12\text{ °C}$             | 4.5      | kW   | $T_j = +12\text{ °C}$   |   | 6.1   | %                                 |
| Degradation co-efficient for heat pumps**   | $C_{de}$                          | 0.25     | -    |   |   |       |                                   |
| Power consumption in modes other than 'active mode'   |                                   |          |      |   |   |       |                                   |
| Off mode  | $P_{off}$                         | 0.020    | kW   | Supplementary heater back-up heating capacity *   | $elbu$  | 2.0   | kW                                |
| Thermostat-off mode   | $P_{to}$                          | 0.090    | kW   | Type of energy input  |   |       |                                   |
| Crankcase heater mode   | $P_{ck}$                          | 0.000    | kW   | Standby mode  | $P_{sb}$  | 0.020 | kW                                |
| Other items   |                                   |          |      |   |   |       |                                   |
| Capacity control  |                                   | variable |      | For air-to-air heat pumps: air flow rate outdoor  |   | 3885  | m <sup>3</sup> /h                 |
| Sound power level, outdoor  | $L_{WA}$                          | 70.0     | dB   | For water-/brine-to-air heat pumps: Rated brine or water flow rate, outdoor side heat exchanger   |   | -     | m <sup>3</sup> /h                 |
| Sound power level, indoor   | $L_{WA}$                          | 56.0     | dB   | Emissions of nitrogen oxides (if applicable)  | $NO_x^{***}$  | -     | mg/kWh fuel input GCV             |
|   |                                   |          |      | GWP of the refrigerant  |   | 2088  | Kg CO <sub>2</sub> eq (100 years) |
| Contact details   | Panasonic Testing Centre, Germany |          |      | Panasonic Marketing Europe GmbH Winsberggring 15, 22525 Hamburg, Germany  |   |       |                                   |

\*\* If  $C_{de}$  is not determined by measurement then the default degradation coefficient of heat pumps shall be 0.25.

\*\*\* from 26 September 2018.

Where information relates to multi-split heat pumps, the test result and performance data may be obtained on the basis of the performance of the outdoor unit, with a combination of indoor unit(s) recommended by the manufacturer or importer.

\*\*\*\* Refer to Information requirements for UnitList

### Information requirements for air-to-air air conditioners

|  |                             |                              |
|--|-----------------------------|------------------------------|
| Model(s):  | Outdoor Unit<br>Indoor Unit | U-140PE1E5A<br>S-50PN1E5A x3 |
| Outdoor side heat exchanger of air conditioner:  | air                         |                              |
| Type: compressor driven vapour compression or sorption process   | air                         |                              |
| if applicable: driver of compressor: [electric motor or fuel driven, gaseous or liquid fuel, internal or external combustion engine] | vapour compression          |                              |
|  | electric motor              |                              |

| Item   | Symbol         | Value    | Unit | Item   | Symbol              | Value                  | Unit                              |
|--|----------------|----------|------|--|---------------------|------------------------|-----------------------------------|
| Rated cooling capacity   | $P_{rated,c}$  | 14.0     | kW   | Seasonal space cooling energy efficiency   | $\eta_{s,c}$        | 219.8                  | %                                 |
| Refrigeration load   | $P_{design,c}$ | 14.0     | kW   |  |                     |                        |                                   |
| Declared cooling capacity for part load at given outdoor temperatures $T_{j,indoor}$ and indoor 27%/19°C (dry/wet bulb) $T_j$              |                |          |      |  |                     |                        |                                   |
| $T_j = +35^\circ\text{C}$  |                | 14.0     | kW   | $T_j = +35^\circ\text{C}$  |                     | 3.0                    | %                                 |
| $T_j = +30^\circ\text{C}$  |                | 10.3     | kW   | $T_j = +30^\circ\text{C}$  |                     | 4.4                    | %                                 |
| $T_j = +25^\circ\text{C}$  | $P_{dc}$       | 6.6      | kW   | $T_j = +25^\circ\text{C}$  |                     | 6.9                    | %                                 |
| $T_j = +20^\circ\text{C}$  |                | 5.3      | kW   | $T_j = +20^\circ\text{C}$  |                     | 9.6                    | %                                 |
| Degradation co-efficient for air conditioners**  | $C_{dc}$       | 0.25     | -    |  |                     |                        |                                   |
| Declared energy efficiency ratio or gas utilization efficiency / auxiliary energy factor for part load at given outdoor temperatures $T_j$ |                |          |      |  |                     |                        |                                   |
| $T_j = -7^\circ\text{C}$   |                | 12.3     | kW   | $T_j = +35^\circ\text{C}$  |                     | EER <sub>d</sub> or    | %                                 |
| $T_j = +2^\circ\text{C}$   |                | 7.5      | kW   | $T_j = +30^\circ\text{C}$  |                     | GUE <sub>d,brn</sub> / | %                                 |
| $T_j = +7^\circ\text{C}$   |                | 4.8      | kW   | $T_j = +25^\circ\text{C}$  |                     | AEF <sub>d,brn</sub>   | %                                 |
| $T_j = +12^\circ\text{C}$  |                | 4.7      | kW   |  |                     |                        | %                                 |
| $T_{brn} = \text{bivalent temperature}$  | $P_{ch}$       | 12.3     | kW   |  |                     |                        |                                   |
| $T_{ol} = \text{operation limit}$  |                | 9.3      | kW   |  |                     |                        |                                   |
| For air-to-water heat pumps:<br>$T_j = -15^\circ\text{C}$ (if $T_{ol} < -20^\circ\text{C}$ )   |                | -        | kW   |  |                     |                        |                                   |
| Bivalent temperature   | $T_{brn}$      | -7       | °C   |  |                     |                        |                                   |
| Degradation co-efficient heat pumps**  | $C_{ch}$       | 0.25     | -    |  |                     |                        |                                   |
| Power consumption in modes other than 'active mode'  |                |          |      |  |                     |                        |                                   |
| Off mode   | $P_{off}$      | 0.020    | kW   | Crankcase heater mode  | $P_{ck}$            | 0.000                  | kW                                |
| Thermostat-off mode  | $P_{to}$       | 0.090    | kW   | Standby mode   | $P_{sb}$            | 0.020                  | kW                                |
| Other items  |                |          |      |  |                     |                        |                                   |
| Capacity control   |                | variable |      | For air-to-air conditioner: air flow rate, outdoor   |                     | 4767                   | m <sup>3</sup> /h                 |
| Sound power level, outdoor   | $L_{WA}$       | 71.0     | dB   |  |                     |                        |                                   |
| Sound power level, indoor  | $L_{WA}$       | 58.0     | dB   | if engine driven: Emissions of nitrogen oxides   | $\text{NO}_x^{***}$ | -                      | mg/kWh fuel input GCV             |
|  |                |          |      | GWP of the refrigerant   |                     | 2088                   | kg CO <sub>2</sub> eq (100 years) |
| Contact details  |                |          |      | Panasonic Testing Centre, Panasonic Marketing Europe GmbH Winsberggring 15, 22525 Hamburg, Germany |                     |                        |                                   |

\*\* If  $C_{dc}$  is not determined by measurement then the default degradation coefficient air conditioners shall be 0.25.  
 \*\*\* from 26 September 2018.  
 Where information relates to multi-split air conditioners, the test result and performance data may be obtained on the basis of the performance of the outdoor unit, with a combination of indoor unit(s) recommended by the manufacturer or importer.  
 \*\*\*\* Refer to Information requirements for UnitList

### Information requirements for heat pumps

|  |                             |                              |
|--|-----------------------------|------------------------------|
| Model(s):  | Outdoor Unit<br>Indoor Unit | U-140PE1E5A<br>S-50PN1E5A x3 |
| Outdoor side heat exchanger of heat pump:  | air                         |                              |
| Indoor side heat exchanger of heat pump:   | air                         |                              |
| Indication if the heater is equipped with a supplementary heater:  | no                          |                              |
| if applicable: driver of compressor: [electric motor or fuel driven, gaseous or liquid fuel, internal or external combustion engine] | electric motor              |                              |

Parameters shall be declared for the average heating season, parameters for the warmer and colder heating seasons are optional.

| Item   | Symbol         | Value    | Unit | Item   | Symbol              | Value | Unit                              |
|--|----------------|----------|------|--|---------------------|-------|-----------------------------------|
| Rated heating capacity   | $P_{rated,h}$  | 16.0     | kW   | Seasonal space heating energy efficiency   | $\eta_{s,h}$        | 140.7 | %                                 |
| Refrigeration load   | $P_{design,h}$ | 14.0     | kW   |  |                     |       |                                   |
| Declared heating capacity for part load at indoor temperature 20°C and outdoor temperature $T_j$ |                |          |      |  |                     |       |                                   |
| $T_j = -7^\circ\text{C}$   |                | 12.3     | kW   | $T_j = -7^\circ\text{C}$   |                     | 2.3   | %                                 |
| $T_j = +2^\circ\text{C}$   |                | 7.5      | kW   | $T_j = +2^\circ\text{C}$   |                     | 3.4   | %                                 |
| $T_j = +7^\circ\text{C}$   |                | 4.8      | kW   | $T_j = +7^\circ\text{C}$   |                     | 5.1   | %                                 |
| $T_j = +12^\circ\text{C}$  |                | 4.7      | kW   |  |                     |       |                                   |
| $T_{brn} = \text{bivalent temperature}$  | $P_{ch}$       | 12.3     | kW   | $T_{brn} = \text{bivalent temperature}$  |                     | 2.3   | %                                 |
| $T_{ol} = \text{operation limit}$  |                | 9.3      | kW   | $T_{ol} = \text{operation limit}$  |                     | 1.6   | %                                 |
| For air-to-water heat pumps:<br>$T_j = -15^\circ\text{C}$ (if $T_{ol} < -20^\circ\text{C}$ )     |                | -        | kW   | For water-to-air heat pumps:<br>$T_j = -15^\circ\text{C}$ (if $T_{ol} < -20^\circ\text{C}$ )       |                     | -     | %                                 |
| Bivalent temperature   | $T_{brn}$      | -7       | °C   | For water-to-air heat pumps:<br>Operation limit temperature  | $T_{ol}$            | -20   | °C                                |
| Degradation co-efficient heat pumps**  | $C_{ch}$       | 0.25     | -    |  |                     |       |                                   |
| Power consumption in modes other than 'active mode'  |                |          |      |  |                     |       |                                   |
| Off mode   | $P_{off}$      | 0.020    | kW   | back-up heating capacity*  | $e_{bu}$            | 2.4   | kW                                |
| Thermostat-off mode  | $P_{to}$       | 0.090    | kW   | Type of energy input   |                     |       |                                   |
| Crankcase heater mode  | $P_{ck}$       | 0.000    | kW   | Standby mode   | $P_{sb}$            | 0.020 | kW                                |
| Other items  |                |          |      |  |                     |       |                                   |
| Capacity control   |                | variable |      | For air-to-air heat pumps: air flow rate, outdoor  |                     | 4238  | m <sup>3</sup> /h                 |
| Sound power level, outdoor   | $L_{WA}$       | 71.0     | dB   | For water-/brine-to-air heat pumps: Rated brine or water flow rate, outdoor side heat exchanger    |                     | -     | m <sup>3</sup> /h                 |
| Sound power level, indoor  | $L_{WA}$       | 58.0     | dB   | Emissions of nitrogen oxides (if applicable)   | $\text{NO}_x^{***}$ | -     | mg/kWh fuel input GCV             |
|  |                |          |      | GWP of the refrigerant   |                     | 2088  | kg CO <sub>2</sub> eq (100 years) |
| Contact details  |                |          |      | Panasonic Testing Centre, Panasonic Marketing Europe GmbH Winsberggring 15, 22525 Hamburg, Germany |                     |       |                                   |

\*\* If  $C_{ch}$  is not determined by measurement then the default degradation coefficient of heat pumps shall be 0.25.  
 \*\*\* from 26 September 2018.  
 Where information relates to multi-split heat pumps, the test result and performance data may be obtained on the basis of the performance of the outdoor unit, with a combination of indoor unit(s) recommended by the manufacturer or importer.  
 \*\*\*\* Refer to Information requirements for UnitList

## Information requirements for air-to-air air conditioners

|  |                             |                              |
|--|-----------------------------|------------------------------|
| Model(s):  | Outdoor Unit<br>Indoor Unit | U-125PE1E5A<br>S-60PN1E5A x2 |
| Outdoor side heat exchanger of air conditioner:  | air                         |                              |
| Indoor side heat exchanger of air conditioner:   | air                         |                              |
| Type: compressor driven vapour compression or sorption process   | vapour compression          |                              |
| if applicable: driver of compressor: [electric motor or fuel driven, gaseous or liquid fuel, internal or external combustion engine] | electric motor              |                              |

| Item   | Symbol           | Value | Unit | Item                                     | Symbol  | Value | Unit |
|--|------------------|-------|------|--|---|-------|------|
| Rated cooling capacity   | $P_{medic}$      | 12.5  | kW   | Seasonal space cooling energy efficiency | $\eta_{sc}$   | 229.0 | %    |
| Refrigeration load   | $P_{design,c}$   | 12.5  | kW   |  |   |       |      |
| Declared cooling capacity for part load at given outdoor temperatures $T_j$ and indoor 27%/19°C (dry/wet bulb) |                  |       |      |  |   |       |      |
| $T_j = +35\text{ °C}$  |                  | 12.5  | kW   | $T_j = +35\text{ °C}$                    |   | 3.2   | %    |
| $T_j = +30\text{ °C}$  |                  | 9.2   | kW   | $T_j = +30\text{ °C}$                    | EER <sub>d</sub> or GUE <sub>d,bin</sub> / AEF <sub>d,bin</sub> | 4.8   | %    |
| $T_j = +25\text{ °C}$  | P <sub>dc</sub>  | 5.9   | kW   | $T_j = +25\text{ °C}$                    |   | 7.2   | %    |
| $T_j = +20\text{ °C}$  |                  | 5.2   | kW   | $T_j = +20\text{ °C}$                    |   | 9.8   | %    |
| Degradation co-efficient for air conditioners**  | C <sub>de</sub>  | 0.25  | -    |  |   |       |      |
| Power consumption in modes other than 'active mode'  |                  |       |      |  |   |       |      |
| Off mode   | P <sub>off</sub> | 0.020 | kW   | Crankcase heater mode                    | P <sub>ck</sub>   | 0.000 | kW   |
| Thermostat-off mode  | P <sub>to</sub>  | 0.090 | kW   | Standby mode                             | P <sub>sb</sub>   | 0.020 | kW   |

| Other items                |                 |  |    |  |                     |      |                                   |
|----------------------------|-----------------|--|----|--|---------------------|------|-----------------------------------|
| Capacity control           |                 | variable   |    | For air-to-air air conditioner: air flow rate, outdoor |                     | 4591 | m <sup>3</sup> /h                 |
| Sound power level, outdoor | L <sub>WA</sub> | 70.0   | dB |  |                     |      |                                   |
| Sound power level, indoor  | L <sub>WA</sub> | 60.0   | dB | if engine driven: Emissions of nitrogen oxides         | NO <sub>x</sub> *** | -    | mg/kWh fuel input GCV             |
|                            |                 |  |    | GWP of the refrigerant                                 |                     | 2088 | kg CO <sub>2</sub> eq (100 years) |
| Contact details            |                 | Panasonic Testing Centre, Panasonic Marketing Europe GmbH Winsbergg 15, 22525 Hamburg, Germany |    |  |                     |      |                                   |

\*\* If C<sub>de</sub> is not determined by measurement then the default degradation coefficient air conditioners shall be 0.25.

\*\*\* from 26 September 2018.

Where information relates to multi-split air conditioners, the test result and performance data may be obtained on the basis of the performance of the outdoor unit, with a combination of indoor unit(s) recommended by the manufacturer or importer.

\*\*\*\* Refer to Information requirements for UnitList

## Information requirements for heat pumps

|  |                             |                              |
|--|-----------------------------|------------------------------|
| Model(s):  | Outdoor Unit<br>Indoor Unit | U-125PE1E5A<br>S-60PN1E5A x2 |
| Outdoor side heat exchanger of heat pump:  | air                         |                              |
| Indoor side heat exchanger of heat pump:   | air                         |                              |
| Indication if the heater is equipped with a supplementary heater:  | no                          |                              |
| if applicable: driver of compressor: [electric motor or fuel driven, gaseous or liquid fuel, internal or external combustion engine] | electric motor              |                              |

Parameters shall be declared for the average heating season, parameters for the warmer and colder heating seasons are optional.

| Item  | Symbol           | Value | Unit | Item   | Symbol  | Value | Unit |
|---|------------------|-------|------|--|---|-------|------|
| Rated heating capacity  | $P_{med,h}$      | 14.0  | kW   | Seasonal space heating energy efficiency                 | $\eta_{ph}$   | 144.1 | %    |
| Refrigeration load  | $P_{design,h}$   | 12.5  | kW   |  |   |       |      |
| Declared heating capacity for part load at indoor temperature 20 °C and outdoor temperature $T_j$ |                  |       |      |  |   |       |      |
| $T_j = -7\text{ °C}$  |                  | 11.0  | kW   | $T_j = -7\text{ °C}$                                     |   | 2.4   | %    |
| $T_j = +2\text{ °C}$  |                  | 6.7   | kW   | $T_j = +2\text{ °C}$                                     |   | 3.5   | %    |
| $T_j = +7\text{ °C}$  |                  | 4.3   | kW   | $T_j = +7\text{ °C}$                                     |   | 5.1   | %    |
| $T_j = +12\text{ °C}$   |                  | 4.5   | kW   | $T_j = +12\text{ °C}$                                    | COP <sub>d</sub> or GUE <sub>d,bin</sub> / AEF <sub>d,bin</sub> | 6.1   | %    |
| $T_{bw} = \text{bivalent temperature}$  |                  | 11.0  | kW   | $T_{bw} = \text{bivalent temperature}$                   |   | 2.4   | %    |
| $T_{ol} = \text{operation limit}$   |                  | 9.0   | kW   | $T_{ol} = \text{operation limit}$                        |   | 1.8   | %    |
| For air-to-water heat pumps: $T_j = -15\text{ °C}$ (if $T_{ol} < -20\text{ °C}$ )                 |                  | -     | kW   | For water-to-air heat pumps:                             |   | -     | %    |
| Bivalent temperature  | $T_{bw}$         | -7    | °C   | For water-to-air heat pumps: Operation limit temperature | $T_{ol}$  | -20   | °C   |
| Degradation co-efficient heat pumps**   | C <sub>dh</sub>  | 0.25  | -    |  |   |       |      |
| Power consumption in modes other than 'active mode'   |                  |       |      |  |   |       |      |
| Off mode  | P <sub>off</sub> | 0.020 | kW   | Supplementary heater back-up heating capacity *          | elbu  | 2.0   | kW   |
| Thermostat-off mode   | P <sub>to</sub>  | 0.090 | kW   | Type of energy input                                     |   |       |      |
| Crankcase heater mode   | P <sub>ck</sub>  | 0.000 | kW   | Standby mode   | P <sub>sb</sub>   | 0.020 | kW   |

| Other items                |                 |  |    |   |                     |      |                                   |
|----------------------------|-----------------|--|----|---|---------------------|------|-----------------------------------|
| Capacity control           |                 | variable   |    | For air-to-air heat pumps: air flow rate, outdoor   |                     | 3885 | m <sup>3</sup> /h                 |
| Sound power level, outdoor | L <sub>WA</sub> | 70.0   | dB | For water-/brine-to-air heat pumps: Rated brine or water flow rate, outdoor side heat exchanger |                     | -    | m <sup>3</sup> /h                 |
| Sound power level, indoor  | L <sub>WA</sub> | 60.0   | dB | Emissions of nitrogen oxides (if applicable)  | NO <sub>x</sub> *** | -    | mg/kWh fuel input GCV             |
|                            |                 |  |    | GWP of the refrigerant  |                     | 2088 | kg CO <sub>2</sub> eq (100 years) |
| Contact details            |                 | Panasonic Testing Centre, Panasonic Marketing Europe GmbH Winsbergg 15, 22525 Hamburg, Germany |    |   |                     |      |                                   |

\*\* If C<sub>dh</sub> is not determined by measurement then the default degradation coefficient of heat pumps shall be 0.25.

\*\*\* from 26 September 2018.

Where information relates to multi-split heat pumps, the test result and performance data may be obtained on the basis of the performance of the outdoor unit, with a combination of indoor unit(s) recommended by the manufacturer or importer.

\*\*\*\* Refer to Information requirements for UnitList



## Information requirements for air-to-air air conditioners

|  |                             |                              |
|--|-----------------------------|------------------------------|
| Model(s):  | Outdoor Unit<br>Indoor Unit | U-140PE1E5A<br>S-71PN1E5A x2 |
| Outdoor side heat exchanger of air conditioner:  | air                         |                              |
| Indoor side heat exchanger of air conditioner:   | air                         |                              |
| Type: compressor driven vapour compression or sorption process   | vapour compression          |                              |
| if applicable: driver of compressor: [electric motor or fuel driven, gaseous or liquid fuel, internal or external combustion engine] | electric motor              |                              |

| Item   | Symbol         | Value    | Unit | Item  | Symbol  | Value | Unit                              |
|--|----------------|----------|------|---|---|-------|-----------------------------------|
| Rated cooling capacity   | $P_{med,c}$    | 14.0     | kW   | Seasonal space cooling energy efficiency  | $\eta_{s,c}$  | 219.8 | %                                 |
| Refrigeration load   | $P_{design,c}$ | 14.0     | kW   | Declared energy efficiency ratio or gas utilization efficiency / auxiliary energy factor for part load at given outdoor temperatures $T_j$ and indoor 27°/19°C (dry/wet bulb) |   |       |                                   |
| Declared cooling capacity for part load at given outdoor temperatures $T_j$ and indoor 27°/19°C (dry/wet bulb) |                |          |      | Declared energy efficiency ratio or gas utilization efficiency / auxiliary energy factor for part load at given outdoor temperatures $T_j$                                    |   |       |                                   |
| $T_j = +35\text{ °C}$  |                | 14.0     | kW   | $T_j = +35\text{ °C}$   |   | 3.0   | %                                 |
| $T_j = +30\text{ °C}$  |                | 10.3     | kW   | $T_j = +30\text{ °C}$   | EER <sub>d</sub> or GUE <sub>d,db</sub> / AEF <sub>d,db</sub> | 4.4   | %                                 |
| $T_j = +25\text{ °C}$  | $P_{dc}$       | 6.6      | kW   | $T_j = +25\text{ °C}$   |   | 6.9   | %                                 |
| $T_j = +20\text{ °C}$  |                | 5.3      | kW   | $T_j = +20\text{ °C}$   |   | 9.6   | %                                 |
| Degradation co-efficient for air conditioners**  | $C_{de}$       | 0.25     | -    |   |   |       |                                   |
| Power consumption in modes other than 'active mode'  |                |          |      |   |   |       |                                   |
| Off mode   | $P_{off}$      | 0.020    | kW   | Crankcase heater mode   | $P_{ck}$  | 0.000 | kW                                |
| Thermostat-off mode  | $P_{to}$       | 0.090    | kW   | Standby mode  | $P_{sb}$  | 0.020 | kW                                |
| Other items  |                |          |      |   |   |       |                                   |
| Capacity control   |                | variable |      | For air-to-air conditioner: air flow rate, outdoor  |   | 4767  | m³/h                              |
| Sound power level, outdoor   | $L_{WA}$       | 71.0     | dB   |   |   |       |                                   |
| Sound power level, indoor  | $L_{WA}$       | 60.0     | dB   | if engine driven: Emissions of nitrogen oxides  | $NO_x^{***}$  | -     | mg/kWh fuel input GCV             |
|  |                |          |      | GWP of the refrigerant  |   | 2088  | kg CO <sub>2</sub> eq (100 years) |
| Contact details  |                |          |      | Panasonic Testing Centre, Panasonic Marketing Europe GmbH Winsberggring 15, 22525 Hamburg, Germany  |   |       |                                   |

\*\* If  $C_{de}$  is not determined by measurement then the default degradation coefficient air conditioners shall be 0.25.  
 \*\*\* from 26 September 2018.  
 Where information relates to multi-split air conditioners, the test result and performance data may be obtained on the basis of the performance of the outdoor unit, with a combination of indoor unit(s) recommended by the manufacturer or importer.  
 \*\*\*\* Refer to Information requirements for Unit/LiSt

## Information requirements for heat pumps

|  |                             |                              |
|--|-----------------------------|------------------------------|
| Model(s):  | Outdoor Unit<br>Indoor Unit | U-140PE1E5A<br>S-71PN1E5A x2 |
| Outdoor side heat exchanger of heat pump:  | air                         |                              |
| Indoor side heat exchanger of heat pump:   | air                         |                              |
| Indication if the heater is equipped with a supplementary heater:  | no                          |                              |
| if applicable: driver of compressor: [electric motor or fuel driven, gaseous or liquid fuel, internal or external combustion engine] | electric motor              |                              |

Parameters shall be declared for the average heating season, parameters for the warmer and colder heating seasons are optional.

| Item  | Symbol         | Value    | Unit | Item  | Symbol  | Value | Unit                              |
|---|----------------|----------|------|---|---|-------|-----------------------------------|
| Rated heating capacity  | $P_{med,h}$    | 16.0     | kW   | Seasonal space heating energy efficiency  | $\eta_{p,h}$  | 140.7 | %                                 |
| Refrigeration load  | $P_{design,h}$ | 14.0     | kW   | Declared coefficient of performance or gas utilization efficiency / auxiliary energy factor for part load at given outdoor temperatures $T_j$ |   |       |                                   |
| Declared heating capacity for part load at indoor temperature 20 °C and outdoor temperature $T_j$ |                |          |      | Declared coefficient of performance or gas utilization efficiency / auxiliary energy factor for part load at given outdoor temperatures $T_j$ |   |       |                                   |
| $T_j = -7\text{ °C}$  |                | 12.3     | kW   | $T_j = -7\text{ °C}$  |   | 2.3   | %                                 |
| $T_j = +2\text{ °C}$  |                | 7.5      | kW   | $T_j = +2\text{ °C}$  |   | 3.4   | %                                 |
| $T_j = +7\text{ °C}$  |                | 4.8      | kW   | $T_j = +7\text{ °C}$  |   | 5.1   | %                                 |
| $T_j = +12\text{ °C}$   |                | 4.7      | kW   | $T_j = +12\text{ °C}$   | COP <sub>d</sub> or GUE <sub>d,db</sub> / AEF <sub>d,db</sub> | 6.0   | %                                 |
| $T_{bw} =$ bivalent temperature   | $P_{bh}$       | 12.3     | kW   | $T_{bw} =$ bivalent temperature   |   | 2.3   | %                                 |
| $T_{ol} =$ operation limit  |                | 9.3      | kW   | $T_{ol} =$ operation limit  |   | 1.6   | %                                 |
| For air-to-water heat pumps: $T_j = -15\text{ °C}$ (if $T_{ol} < -20\text{ °C}$ )                 |                | -        | kW   | For water-to-air heat pumps: $T_{ol} = -20\text{ °C}$   |   | -     | %                                 |
| Bivalent temperature  | $T_{bw}$       | -7       | °C   | For water-to-air heat pumps: Operation limit temperature  | $T_{ol}$  | -20   | °C                                |
| Degradation co-efficient heat pumps**   | $C_{dh}$       | 0.25     | -    | Supplementary heater  |   |       |                                   |
| Power consumption in modes other than 'active mode'   |                |          |      |   |   |       |                                   |
| Off mode  | $P_{off}$      | 0.020    | kW   | back-up heating capacity*   | elbu  | 2.4   | kW                                |
| Thermostat-off mode   | $P_{to}$       | 0.090    | kW   | Type of energy input  |   |       |                                   |
| Crankcase heater mode   | $P_{ck}$       | 0.000    | kW   | Standby mode  | $P_{sb}$  | 0.020 | kW                                |
| Other items   |                |          |      |   |   |       |                                   |
| Capacity control  |                | variable |      | For air-to-air heat pumps: air flow rate outdoor  |   | 4238  | m³/h                              |
| Sound power level, outdoor  | $L_{WA}$       | 71.0     | dB   | For water-/brine-to-air heat pumps: Rated brine or water flow rate, outdoor side heat exchanger   |   | -     | m³/h                              |
| Sound power level, indoor   | $L_{WA}$       | 60.0     | dB   | Emissions of nitrogen oxides (if applicable)  | $NO_x^{***}$  | -     | mg/kWh fuel input GCV             |
|   |                |          |      | GWP of the refrigerant  |   | 2088  | kg CO <sub>2</sub> eq (100 years) |
| Contact details   |                |          |      | Panasonic Testing Centre, Panasonic Marketing Europe GmbH Winsberggring 15, 22525 Hamburg, Germany  |   |       |                                   |

\*\* If  $C_{dh}$  is not determined by measurement then the default degradation coefficient of heat pumps shall be 0.25.  
 \*\*\* from 26 September 2018.  
 Where information relates to multi-split heat pumps, the test result and performance data may be obtained on the basis of the performance of the outdoor unit, with a combination of indoor unit(s) recommended by the manufacturer or importer.  
 \*\*\*\* Refer to Information requirements for Unit/LiSt

## Information requirements for air-to-air air conditioners

|  |                             |                            |
|--|-----------------------------|----------------------------|
| Model(s):  | Outdoor Unit<br>Indoor Unit | U-125PE1E5A<br>S-125PN1E5A |
| Outdoor side heat exchanger of air conditioner:  | air                         |                            |
| Indoor side heat exchanger of air conditioner:   | air                         |                            |
| Type: compressor driven vapour compression or sorption process   | vapour compression          |                            |
| if applicable: driver of compressor: [electric motor or fuel driven, gaseous or liquid fuel, internal or external combustion engine] | electric motor              |                            |

## Information requirements for heat pumps

|  |                             |                            |
|--|-----------------------------|----------------------------|
| Model(s):  | Outdoor Unit<br>Indoor Unit | U-125PE1E5A<br>S-125PN1E5A |
| Outdoor side heat exchanger of heat pump:  | air                         |                            |
| Indoor side heat exchanger of heat pump:   | air                         |                            |
| Indication if the heater is equipped with a supplementary heater:  | no                          |                            |
| if applicable: driver of compressor: [electric motor or fuel driven, gaseous or liquid fuel, internal or external combustion engine] | electric motor              |                            |

Parameters shall be declared for the average heating season, parameters for the warmer and colder heating seasons are optional.

| Item   | Symbol         | Value    | Unit | Item  | Symbol                                 | Value | Unit                              |
|--|----------------|----------|------|---|--|-------|-----------------------------------|
| Rated cooling capacity   | $P_{rated,c}$  | 12.5     | kW   | Seasonal space cooling energy efficiency  | $\eta_{p,c}$                           | 214.6 | %                                 |
| Refrigeration load   | $P_{design,c}$ | 12.5     | kW   |   |  |       |                                   |
| Declared cooling capacity for part load at given outdoor temperatures $T_j$ and indoor 27%/19°C (dry/wet bulb)                             |                |          |      |   |  |       |                                   |
| $T_j = +35\text{ °C}$  |                | 12.5     | kW   | $T_j = +35\text{ °C}$   |  | 3.2   | %                                 |
| $T_j = +30\text{ °C}$  |                | 9.2      | kW   | $T_j = +30\text{ °C}$   |  | 4.8   | %                                 |
| $T_j = +25\text{ °C}$  | $P_{dc}$       | 5.9      | kW   | $T_j = +25\text{ °C}$   | $EER_d$ or $GUE_{d,br}$ / $AEF_{d,br}$ | 7.2   | %                                 |
| $T_j = +20\text{ °C}$  |                | 5.2      | kW   | $T_j = +20\text{ °C}$   |  | 9.8   | %                                 |
| Degradation co-efficient for air conditioners**  | $C_{dc}$       | 0.25     | -    |   |  |       |                                   |
| Declared energy efficiency ratio or gas utilization efficiency / auxiliary energy factor for part load at given outdoor temperatures $T_j$ |                |          |      |   |  |       |                                   |
| $T_j = -7\text{ °C}$   |                | 11.0     | kW   | $T_j = -7\text{ °C}$  |  | 2.4   | %                                 |
| $T_j = +2\text{ °C}$   |                | 6.7      | kW   | $T_j = +2\text{ °C}$  |  | 3.5   | %                                 |
| $T_j = +7\text{ °C}$   |                | 4.3      | kW   | $T_j = +7\text{ °C}$  |  | 5.1   | %                                 |
| $T_j = +12\text{ °C}$  |                | 4.5      | kW   | $T_j = +12\text{ °C}$   |  | 6.1   | %                                 |
| $T_{br} = \text{bivalent temperature}$   | $P_{ch}$       | 11.0     | kW   | $T_{br} = \text{bivalent temperature}$  | $COP_d$ or $GUE_{d,br}$ / $AEF_{d,br}$ | 2.4   | %                                 |
| $T_{ol} = \text{operation limit}$  |                | 9.0      | kW   | $T_{ol} = \text{operation limit}$   |  | 1.8   | %                                 |
| For air-to-water heat pumps:<br>$T_j = -15\text{ °C}$ (if $T_{ol} < -20\text{ °C}$ )   |                | -        | kW   | For water-to-air heat pumps:<br>$T_j = -15\text{ °C}$ (if $T_{ol} < -20\text{ °C}$ )          |  | -     | %                                 |
| Bivalent temperature   | $T_{br}$       | -7       | °C   | For water-to-air heat pumps:<br>Operation limit temperature                                   | $T_{ol}$                               | -20   | °C                                |
| Degradation co-efficient heat pumps**  | $C_{ch}$       | 0.25     | -    |   |  |       |                                   |
| Power consumption in modes other than 'active mode'  |                |          |      |   |  |       |                                   |
| Off mode   | $P_{off}$      | 0.020    | kW   | Crankcase heater mode   | $P_{ck}$                               | 0.000 | kW                                |
| Thermostat-off mode  | $P_{to}$       | 0.220    | kW   | Standby mode  | $P_{sb}$                               | 0.020 | kW                                |
| Other items  |                |          |      |   |  |       |                                   |
| Capacity control   |                | variable |      | For air-to-air conditioner: air flow rate, outdoor  |  | 4591  | m <sup>3</sup> /h                 |
| Sound power level, outdoor   | $L_{WA}$       | 70.0     | dB   |   |  |       |                                   |
| Sound power level, indoor  | $L_{WA}$       | 66.0     | dB   | if engine driven: Emissions of nitrogen oxides  | $NO_x^{***}$                           | -     | mg/kWh fuel input GCV             |
|  |                |          |      | GWP of the refrigerant  |  | 2088  | kg CO <sub>2</sub> eq (100 years) |
| Contact details  |                |          |      | Panasonic Testing Centre, Panasonic Marketing Europe GmbH Winsberg 15, 22525 Hamburg, Germany |  |       |                                   |

\*\* If  $C_{dc}$  is not determined by measurement then the default degradation coefficient air conditioners shall be 0.25.

\*\*\* from 26 September 2018.

Where information relates to multi-split air conditioners, the test result and performance data may be obtained on the basis of the performance of the outdoor unit, with a combination of indoor unit(s) recommended by the manufacturer or importer.

\*\*\*\* Refer to Information requirements for UnitList

| Item  | Symbol         | Value    | Unit | Item  | Symbol                                 | Value | Unit                              |
|---|----------------|----------|------|---|--|-------|-----------------------------------|
| Rated heating capacity  | $P_{rated,h}$  | 14.0     | kW   | Seasonal space heating energy efficiency  | $\eta_{p,h}$                           | 143.4 | %                                 |
| Refrigeration load  | $P_{design,h}$ | 12.5     | kW   |   |  |       |                                   |
| Declared heating capacity for part load at indoor temperature 20 °C and outdoor temperature $T_j$ |                |          |      |   |  |       |                                   |
| $T_j = -7\text{ °C}$  |                | 11.0     | kW   | $T_j = -7\text{ °C}$  |  | 2.4   | %                                 |
| $T_j = +2\text{ °C}$  |                | 6.7      | kW   | $T_j = +2\text{ °C}$  |  | 3.5   | %                                 |
| $T_j = +7\text{ °C}$  |                | 4.3      | kW   | $T_j = +7\text{ °C}$  |  | 5.1   | %                                 |
| $T_j = +12\text{ °C}$   |                | 4.5      | kW   | $T_j = +12\text{ °C}$   |  | 6.1   | %                                 |
| $T_{br} = \text{bivalent temperature}$  | $P_{ch}$       | 11.0     | kW   | $T_{br} = \text{bivalent temperature}$  | $COP_d$ or $GUE_{d,br}$ / $AEF_{d,br}$ | 2.4   | %                                 |
| $T_{ol} = \text{operation limit}$   |                | 9.0      | kW   | $T_{ol} = \text{operation limit}$   |  | 1.8   | %                                 |
| For air-to-water heat pumps:<br>$T_j = -15\text{ °C}$ (if $T_{ol} < -20\text{ °C}$ )              |                | -        | kW   | For water-to-air heat pumps:<br>$T_j = -15\text{ °C}$ (if $T_{ol} < -20\text{ °C}$ )            |  | -     | %                                 |
| Bivalent temperature  | $T_{br}$       | -7       | °C   | For water-to-air heat pumps:<br>Operation limit temperature                                     | $T_{ol}$                               | -20   | °C                                |
| Degradation co-efficient heat pumps**   | $C_{ch}$       | 0.25     | -    |   |  |       |                                   |
| Power consumption in modes other than 'active mode'   |                |          |      |   |  |       |                                   |
| Off mode  | $P_{off}$      | 0.020    | kW   | back-up heating capacity*   | $el_{bu}$                              | 2.0   | kW                                |
| Thermostat-off mode   | $P_{to}$       | 0.220    | kW   | Type of energy input  |  |       |                                   |
| Crankcase heater mode   | $P_{ck}$       | 0.000    | kW   | Standby mode  | $P_{sb}$                               | 0.020 | kW                                |
| Other items   |                |          |      |   |  |       |                                   |
| Capacity control  |                | variable |      | For air-to-air heat pumps: air flow rate, outdoor   |  | 3885  | m <sup>3</sup> /h                 |
| Sound power level, outdoor  | $L_{WA}$       | 70.0     | dB   | For water-/brine-to-air heat pumps: Rated brine or water flow rate, outdoor side heat exchanger |  | -     | m <sup>3</sup> /h                 |
| Sound power level, indoor   | $L_{WA}$       | 66.0     | dB   | Emissions of nitrogen oxides (if applicable)  | $NO_x^{***}$                           | -     | mg/kWh fuel input GCV             |
|   |                |          |      | GWP of the refrigerant  |  | 2088  | kg CO <sub>2</sub> eq (100 years) |
| Contact details   |                |          |      | Panasonic Testing Centre, Panasonic Marketing Europe GmbH Winsberg 15, 22525 Hamburg, Germany   |  |       |                                   |

\*\* If  $C_{ch}$  is not determined by measurement then the default degradation coefficient of heat pumps shall be 0.25.

\*\*\* from 26 September 2018.

Where information relates to multi-split heat pumps, the test result and performance data may be obtained on the basis of the performance of the outdoor unit, with a combination of indoor unit(s) recommended by the manufacturer or importer.

\*\*\*\* Refer to Information requirements for UnitList

Information requirements for air-to-air air conditioners

Model(s): Outdoor Unit U-140PE1E5A  
Indoor Unit S-140PN1E5A

Outdoor side heat exchanger of air conditioner: air

Indoor side heat exchanger of air conditioner: air

Type: compressor driven vapour compression or sorption process vapour compression

if applicable: driver of compressor: [electric motor or fuel driven, electric motor, gaseous or liquid fuel, internal or external combustion engine]

| Item  | Symbol                | Value    | Unit | Item   | Symbol  | Value | Unit                              |
|---|-----------------------|----------|------|--|---|-------|-----------------------------------|
| Rated cooling capacity  | P <sub>med,c</sub>    | 14.0     | kW   | Seasonal space cooling energy efficiency   | η <sub>p,c</sub>  | 207.8 | %                                 |
| Refrigeration load  | P <sub>design,c</sub> | 14.0     | kW   | Declared energy efficiency ratio or gas utilization efficiency / auxiliary energy factor for part load at given outdoor temperatures T <sub>j</sub> and indoor 27%/19°C (dry/wet bulb) |   |       |                                   |
| Declared cooling capacity for part load at given outdoor temperatures T <sub>j</sub> and indoor 27%/19°C (dry/wet bulb) |                       |          |      | T <sub>j</sub>   |   |       |                                   |
| T <sub>j</sub> = + 35 °C  |                       | 14.0     | kW   | T <sub>j</sub> = + 35 °C   |   | 3.0   | %                                 |
| T <sub>j</sub> = + 30 °C  |                       | 10.3     | kW   | T <sub>j</sub> = + 30 °C   | EER <sub>d</sub> or GUE <sub>d,db</sub> / AEF <sub>d,db</sub> | 4.4   | %                                 |
| T <sub>j</sub> = + 25 °C  | P <sub>dc</sub>       | 6.6      | kW   | T <sub>j</sub> = + 25 °C   |   | 6.9   | %                                 |
| T <sub>j</sub> = + 20 °C  |                       | 5.3      | kW   | T <sub>j</sub> = + 20 °C   |   | 9.6   | %                                 |
| Degradation co-efficient for air conditioners**   | C <sub>dc</sub>       | 0.25     | -    |  |   |       |                                   |
| Power consumption in modes other than 'active mode'   |                       |          |      |  |   |       |                                   |
| Off mode  | P <sub>off</sub>      | 0.020    | kW   | Crankcase heater mode  | P <sub>ck</sub>   | 0.000 | kW                                |
| Thermostat-off mode   | P <sub>to</sub>       | 0.220    | kW   | Standby mode   | P <sub>sb</sub>   | 0.020 | kW                                |
| Other items   |                       |          |      |  |   |       |                                   |
| Capacity control  |                       | variable |      | For air-to-air conditioner: air flow rate, outdoor   |   | 4767  | m <sup>3</sup> /h                 |
| Sound power level, outdoor  | L <sub>WA</sub>       | 71.0     | dB   |  |   |       |                                   |
| Sound power level, indoor   | L <sub>WA</sub>       | 67.0     | dB   | if engine driven: Emissions of nitrogen oxides   | NO <sub>x</sub> ***   | -     | mg/kWh fuel input GCV             |
|   |                       |          |      | GWP of the refrigerant   |   | 2088  | kg CO <sub>2</sub> eq (100 years) |
| Contact details   |                       |          |      | Panasonic Testing Centre, Panasonic Marketing Europe GmbH Winsberggring 15, 22525 Hamburg, Germany   |   |       |                                   |

\*\* If C<sub>dc</sub> is not determined by measurement then the default degradation coefficient air conditioners shall be 0.25.  
\*\*\* from 26 September 2018.  
Where information relates to multi-split air conditioners, the test result and performance data may be obtained on the basis of the performance of the outdoor unit, with a combination of indoor unit(s) recommended by the manufacturer or importer.  
\*\*\*\* Refer to Information requirements for UnitList

Information requirements for heat pumps

Model(s): Outdoor Unit U-140PE1E5A  
Indoor Unit S-140PN1E5A

Outdoor side heat exchanger of heat pump: air

Indoor side heat exchanger of heat pump: air

Indication if the heater is equipped with a supplementary heater: no

if applicable: driver of compressor: [electric motor or fuel driven, electric motor, gaseous or liquid fuel, internal or external combustion engine]

Parameters shall be declared for the average heating season, parameters for the warmer and colder heating seasons are optional.

| Item   | Symbol                | Value    | Unit | Item  | Symbol  | Value | Unit                              |
|--|-----------------------|----------|------|---|---|-------|-----------------------------------|
| Rated heating capacity   | P <sub>med,h</sub>    | 16.0     | kW   | Seasonal space heating energy efficiency  | η <sub>p,h</sub>  | 140.1 | %                                 |
| Refrigeration load   | P <sub>design,h</sub> | 14.0     | kW   | Declared coefficient of performance or gas utilization efficiency / auxiliary energy factor for part load at given outdoor temperatures °C and outdoor temperature T <sub>j</sub> |   |       |                                   |
| Declared heating capacity for part load at indoor temperature 20 °C and outdoor temperature T <sub>j</sub> |                       |          |      | T <sub>j</sub>  |   |       |                                   |
| T <sub>j</sub> = - 7 °C  |                       | 12.3     | kW   | T <sub>j</sub> = - 7 °C   |   | 2.3   | %                                 |
| T <sub>j</sub> = + 2 °C  |                       | 7.5      | kW   | T <sub>j</sub> = + 2 °C   |   | 3.4   | %                                 |
| T <sub>j</sub> = + 7 °C  |                       | 4.8      | kW   | T <sub>j</sub> = + 7 °C   |   | 5.1   | %                                 |
| T <sub>j</sub> = + 12 °C   |                       | 4.7      | kW   | T <sub>j</sub> = + 12 °C  | COP <sub>d</sub> or GUE <sub>d,db</sub> / AEF <sub>d,db</sub> | 6.0   | %                                 |
| T <sub>bw</sub> = bivalent temperature   | P <sub>bh</sub>       | 12.3     | kW   | T <sub>bw</sub> = bivalent temperature  |   | 2.3   | %                                 |
| T <sub>ol</sub> = operation limit  |                       | 9.3      | kW   | T <sub>ol</sub> = operation limit   |   | 1.6   | %                                 |
| For air-to-water heat pumps: T <sub>j</sub> = - 15 °C (if T <sub>ol</sub> < - 20 °C)                       |                       | -        | kW   | For water-to-air heat pumps: T <sub>j</sub> = - 15 °C (if T <sub>ol</sub> < - 20 °C)  |   | -     | %                                 |
| Bivalent temperature   | T <sub>bw</sub>       | -7       | °C   | For water-to-air heat pumps: Operation limit temperature  | T <sub>ol</sub>   | -20   | °C                                |
| Degradation co-efficient heat pumps**  | C <sub>dh</sub>       | 0.25     | -    |   |   |       |                                   |
| Power consumption in modes other than 'active mode'  |                       |          |      |   |   |       |                                   |
| Off mode   | P <sub>off</sub>      | 0.020    | kW   | Supplementary heater  |   |       |                                   |
| Thermostat-off mode  | P <sub>to</sub>       | 0.220    | kW   | back-up heating capacity *  | elbu  | 2.4   | kW                                |
| Crankcase heater mode  | P <sub>ck</sub>       | 0.000    | kW   | Type of energy input  |   |       |                                   |
| Other items  |                       |          |      |   |   |       |                                   |
| Capacity control   |                       | variable |      | For air-to-air heat pumps: air flow rate, outdoor   |   | 4238  | m <sup>3</sup> /h                 |
| Sound power level, outdoor   | L <sub>WA</sub>       | 71.0     | dB   | For water-/brine-to-air heat pumps: Rated brine or water flow rate, outdoor side heat exchanger   |   | -     | m <sup>3</sup> /h                 |
| Sound power level, indoor  | L <sub>WA</sub>       | 67.0     | dB   | Emissions of nitrogen oxides (if applicable)  | NO <sub>x</sub> ***   | -     | mg/kWh fuel input GCV             |
|  |                       |          |      | GWP of the refrigerant  |   | 2088  | kg CO <sub>2</sub> eq (100 years) |
| Contact details  |                       |          |      | Panasonic Testing Centre, Panasonic Marketing Europe GmbH Winsberggring 15, 22525 Hamburg, Germany  |   |       |                                   |

\*\* If C<sub>dh</sub> is not determined by measurement then the default degradation coefficient of heat pumps shall be 0.25.  
\*\*\* from 26 September 2018.  
Where information relates to multi-split heat pumps, the test result and performance data may be obtained on the basis of the performance of the outdoor unit, with a combination of indoor unit(s) recommended by the manufacturer or importer.  
\*\*\*\* Refer to Information requirements for UnitList

Information requirements for air-to-air air conditioners

|  |                             |                              |
|--|-----------------------------|------------------------------|
| Model(s):  | Outdoor Unit<br>Indoor Unit | U-125PE1E8A<br>S-36PN1E5A x4 |
| Outdoor side heat exchanger of air conditioner:  | air                         |                              |
| Indoor side heat exchanger of air conditioner:   | air                         |                              |
| Type: compressor driven vapour compression or sorption process   | vapour compression          |                              |
| if applicable: driver of compressor: [electric motor or fuel driven, gaseous or liquid fuel, internal or external combustion engine] | electric motor              |                              |

| Item   | Symbol         | Value    | Unit | Item  | Symbol  | Value | Unit                              |
|--|----------------|----------|------|---|---|-------|-----------------------------------|
| Rated cooling capacity   | $P_{mech,c}$   | 12.5     | kW   | Seasonal space cooling energy efficiency  | $\eta_{s,c}$  | 229.0 | %                                 |
| Refrigeration load   | $P_{design,c}$ | 12.5     | kW   | Declared energy efficiency ratio or gas utilization efficiency / auxiliary energy factor for part load at given outdoor temperatures $T_j$ and indoor 27%/19°C (dry/wet bulb) |   |       |                                   |
| Declared cooling capacity for part load at given outdoor temperatures $T_j$ and indoor 27%/19°C (dry/wet bulb) |                |          |      | Declared energy efficiency ratio or gas utilization efficiency / auxiliary energy factor for part load at given outdoor temperatures $T_j$                                    |   |       |                                   |
| $T_j = +35^\circ\text{C}$  |                | 12.5     | kW   | $T_j = +35^\circ\text{C}$   |   | 3.2   | %                                 |
| $T_j = +30^\circ\text{C}$  |                | 9.2      | kW   | $T_j = +30^\circ\text{C}$   | EER <sub>d</sub> or GUE <sub>o,brn</sub> / AEF <sub>o,brn</sub> | 4.8   | %                                 |
| $T_j = +25^\circ\text{C}$  | $P_{dc}$       | 5.9      | kW   | $T_j = +25^\circ\text{C}$   |   | 7.2   | %                                 |
| $T_j = +20^\circ\text{C}$  |                | 5.2      | kW   | $T_j = +20^\circ\text{C}$   |   | 9.8   | %                                 |
| Degradation co-efficient for air conditioners**  | $C_{dc}$       | 0.25     | -    |   |   |       |                                   |
| Power consumption in modes other than 'active mode'  |                |          |      |   |   |       |                                   |
| Off mode   | $P_{off}$      | 0.020    | kW   | Crankcase heater mode   | $P_{ck}$  | 0.000 | kW                                |
| Thermostat-off mode  | $P_{to}$       | 0.090    | kW   | Standby mode  | $P_{sb}$  | 0.020 | kW                                |
| Other items  |                |          |      |   |   |       |                                   |
| Capacity control   |                | variable |      | For air-to-air conditioner: air flow rate, outdoor  |   | 4591  | m <sup>3</sup> /h                 |
| Sound power level, outdoor   | $L_{WA}$       | 70.0     | dB   |   |   |       |                                   |
| Sound power level, indoor  | $L_{WA}$       | 57.0     | dB   | if engine driven: Emissions of nitrogen oxides  | $\text{NO}_x^{***}$   | -     | mg/kWh fuel input GCV             |
|  |                |          |      | GWP of the refrigerant  |   | 2088  | kg CO <sub>2</sub> eq (100 years) |
| Contact details  |                |          |      | Panasonic Testing Centre, Panasonic Marketing Europe GmbH Winsbergiring 15, 22525 Hamburg, Germany  |   |       |                                   |

\*\* If  $C_{dc}$  is not determined by measurement then the default degradation coefficient air conditioners shall be 0.25.  
 \*\*\* from 26 September 2018.  
 Where information relates to multi-split air conditioners, the test result and performance data may be obtained on the basis of the performance of the outdoor unit, with a combination of indoor unit(s) recommended by the manufacturer or importer.  
 \*\*\*\* Refer to Information requirements for UnitList

Information requirements for heat pumps

|  |                             |                              |
|--|-----------------------------|------------------------------|
| Model(s):  | Outdoor Unit<br>Indoor Unit | U-125PE1E8A<br>S-36PN1E5A x4 |
| Outdoor side heat exchanger of heat pump:  | air                         |                              |
| Indoor side heat exchanger of heat pump:   | air                         |                              |
| Indication if the heater is equipped with a supplementary heater:  | no                          |                              |
| if applicable: driver of compressor: [electric motor or fuel driven, gaseous or liquid fuel, internal or external combustion engine] | electric motor              |                              |

Parameters shall be declared for the average heating season, parameters for the warmer and colder heating seasons are optional.

| Item  | Symbol         | Value    | Unit | Item   | Symbol  | Value | Unit                              |
|---|----------------|----------|------|--|---|-------|-----------------------------------|
| Rated heating capacity  | $P_{rated,h}$  | 14.0     | kW   | Seasonal space heating energy efficiency   | $\eta_{p,h}$  | 144.1 | %                                 |
| Refrigeration load  | $P_{design,h}$ | 12.5     | kW   | Declared coefficient of performance or gas utilization efficiency / auxiliary energy factor for part load at given outdoor temperatures °C and outdoor temperature $T_j$ |   |       |                                   |
| Declared heating capacity for part load at indoor temperature 20 °C and outdoor temperature $T_j$ |                |          |      | Declared coefficient of performance or gas utilization efficiency / auxiliary energy factor for part load at given outdoor temperatures °C and outdoor temperature $T_j$ |   |       |                                   |
| $T_j = -7^\circ\text{C}$  |                | 11.0     | kW   | $T_j = -7^\circ\text{C}$   |   | 2.4   | %                                 |
| $T_j = +2^\circ\text{C}$  |                | 6.7      | kW   | $T_j = +2^\circ\text{C}$   |   | 3.5   | %                                 |
| $T_j = +7^\circ\text{C}$  |                | 4.3      | kW   | $T_j = +7^\circ\text{C}$   |   | 5.1   | %                                 |
| $T_j = +12^\circ\text{C}$   |                | 4.5      | kW   | $T_j = +12^\circ\text{C}$  |   | 6.1   | %                                 |
| $T_{br} = \text{bivalent temperature}$  | $P_{ch}$       | 11.0     | kW   | $T_{br} = \text{bivalent temperature}$   | COP <sub>t</sub> or GUE <sub>o,brn</sub> / AEF <sub>o,brn</sub> | 2.4   | %                                 |
| $T_{ol} = \text{operation limit}$   |                | 9.0      | kW   | $T_{ol} = \text{operation limit}$  |   | 1.8   | %                                 |
| For air-to-water heat pumps: $T_j = -15^\circ\text{C}$ (if $T_{ol} < -20^\circ\text{C}$ )         |                | -        | kW   | For water-to-air heat pumps: $T_j = -15^\circ\text{C}$ (if $T_{ol} < -20^\circ\text{C}$ )  |   | -     | %                                 |
| Bivalent temperature  | $T_{br}$       | -7       | °C   | For water-to-air heat pumps: Operation limit temperature   | $T_{ol}$  | -20   | °C                                |
| Degradation co-efficient heat pumps**   | $C_{ch}$       | 0.25     | -    |  |   |       |                                   |
| Power consumption in modes other than 'active mode'   |                |          |      |  |   |       |                                   |
| Off mode  | $P_{off}$      | 0.020    | kW   | back-up heating capacity*  | $e_{bu}$  | 2.0   | kW                                |
| Thermostat-off mode   | $P_{to}$       | 0.090    | kW   | Type of energy input   |   |       |                                   |
| Crankcase heater mode   | $P_{ck}$       | 0.000    | kW   | Standby mode   | $P_{sb}$  | 0.020 | kW                                |
| Other items   |                |          |      |  |   |       |                                   |
| Capacity control  |                | variable |      | For air-to-air heat pumps: air flow rate, outdoor  |   | 3385  | m <sup>3</sup> /h                 |
| Sound power level, outdoor  | $L_{WA}$       | 70.0     | dB   | For water-/brine-to-air heat pumps: Rated brine or water flow rate, outdoor side heat exchanger  |   | -     | m <sup>3</sup> /h                 |
| Sound power level, indoor   | $L_{WA}$       | 57.0     | dB   | Emissions of nitrogen oxides (if applicable)   | $\text{NO}_x^{***}$   | -     | mg/kWh fuel input GCV             |
|   |                |          |      | GWP of the refrigerant   |   | 2088  | kg CO <sub>2</sub> eq (100 years) |
| Contact details   |                |          |      | Panasonic Testing Centre, Panasonic Marketing Europe GmbH Winsbergiring 15, 22525 Hamburg, Germany   |   |       |                                   |

\*\* If  $C_{ch}$  is not determined by measurement then the default degradation coefficient of heat pumps shall be 0.25.  
 \*\*\* from 26 September 2018.  
 Where information relates to multi-split heat pumps, the test result and performance data may be obtained on the basis of the performance of the outdoor unit, with a combination of indoor unit(s) recommended by the manufacturer or importer.  
 \*\*\*\* Refer to Information requirements for UnitList

### Information requirements for air-to-air air conditioners

|  |                             |                              |
|--|-----------------------------|------------------------------|
| Model(s):  | Outdoor Unit<br>Indoor Unit | U-125PE1E8A<br>S-45PN1E5A x3 |
| Outdoor side heat exchanger of air conditioner:  | air                         |                              |
| Indoor side heat exchanger of air conditioner:   | air                         |                              |
| Type: compressor driven vapour compression or sorption process   | vapour compression          |                              |
| if applicable: driver of compressor: [electric motor or fuel driven, gaseous or liquid fuel, internal or external combustion engine] | electric motor              |                              |

| Item   | Symbol         | Value    | Unit | Item  | Symbol       | Value | Unit                              |
|--|----------------|----------|------|---|--------------|-------|-----------------------------------|
| Rated cooling capacity   | $P_{med,c}$    | 12.5     | kW   | Seasonal space cooling energy efficiency  | $\eta_{s,c}$ | 229.0 | %                                 |
| Refrigeration load   | $P_{design,c}$ | 12.5     | kW   | Declared energy efficiency ratio or gas utilization efficiency / auxiliary energy factor for part load at given outdoor temperatures $T_j$ and indoor 27°/19°C (dry/wet bulb) |              |       |                                   |
| Declared cooling capacity for part load at given outdoor temperatures $T_j$ and indoor 27°/19°C (dry/wet bulb) |                |          |      | Declared energy efficiency ratio or gas utilization efficiency / auxiliary energy factor for part load at given outdoor temperatures $T_j$                                    |              |       |                                   |
| $T_j = +35\text{ °C}$  |                | 12.5     | kW   | $T_j = +35\text{ °C}$   |              | 3.2   | %                                 |
| $T_j = +30\text{ °C}$  |                | 9.2      | kW   | $T_j = +30\text{ °C}$   |              | 4.8   | %                                 |
| $T_j = +25\text{ °C}$  |                | 5.9      | kW   | $T_j = +25\text{ °C}$   |              | 7.2   | %                                 |
| $T_j = +20\text{ °C}$  |                | 5.2      | kW   | $T_j = +20\text{ °C}$   |              | 9.8   | %                                 |
| Degradation co-efficient for air conditioners**  | $C_{dc}$       | 0.25     | -    |   |              |       |                                   |
| Power consumption in modes other than 'active mode'  |                |          |      |   |              |       |                                   |
| Off mode   | $P_{off}$      | 0.020    | kW   | Crankcase heater mode   | $P_{ck}$     | 0.000 | kW                                |
| Thermostat-off mode  | $P_{to}$       | 0.090    | kW   | Standby mode  | $P_{sb}$     | 0.020 | kW                                |
| Other items  |                |          |      |   |              |       |                                   |
| Capacity control   |                | variable |      | For air-to-air conditioner: air flow rate, outdoor  |              | 4591  | m³/h                              |
| Sound power level, outdoor   | $L_{WA}$       | 70.0     | dB   |   |              |       |                                   |
| Sound power level, indoor  | $L_{WA}$       | 58.0     | dB   | if engine driven: Emissions of nitrogen oxides  | $NO_x^{***}$ | -     | mg/kWh fuel input GCV             |
|  |                |          |      | GWP of the refrigerant  |              | 2088  | kg CO <sub>2</sub> eq (100 years) |
| Contact details  |                |          |      | Panasonic Testing Centre, Panasonic Marketing Europe GmbH Winsberggring 15, 22525 Hamburg, Germany  |              |       |                                   |

\*\* If  $C_{dc}$  is not determined by measurement then the default degradation coefficient air conditioners shall be 0.25.  
 \*\*\* from 26 September 2018.  
 Where information relates to multi-split air conditioners, the test result and performance data may be obtained on the basis of the performance of the outdoor unit, with a combination of indoor unit(s) recommended by the manufacturer or importer.  
 \*\*\*\* Refer to Information requirements for UnitList

### Information requirements for heat pumps

|  |                             |                              |
|--|-----------------------------|------------------------------|
| Model(s):  | Outdoor Unit<br>Indoor Unit | U-125PE1E8A<br>S-45PN1E5A x3 |
| Outdoor side heat exchanger of heat pump:  | air                         |                              |
| Indoor side heat exchanger of heat pump:   | air                         |                              |
| Indication if the heater is equipped with a supplementary heater:  | no                          |                              |
| if applicable: driver of compressor: [electric motor or fuel driven, gaseous or liquid fuel, internal or external combustion engine] | electric motor              |                              |

Parameters shall be declared for the average heating season, parameters for the warmer and colder heating seasons are optional.

| Item  | Symbol         | Value    | Unit | Item  | Symbol       | Value | Unit                              |
|---|----------------|----------|------|---|--------------|-------|-----------------------------------|
| Rated heating capacity  | $P_{med,h}$    | 14.0     | kW   | Seasonal space heating energy efficiency  | $\eta_{s,h}$ | 144.1 | %                                 |
| Refrigeration load  | $P_{design,h}$ | 12.5     | kW   | Declared coefficient of performance or gas utilization efficiency / auxiliary energy factor for part load at given outdoor temperatures $T_j$ |              |       |                                   |
| Declared heating capacity for part load at indoor temperature 20 °C and outdoor temperature $T_j$ |                |          |      | Declared coefficient of performance or gas utilization efficiency / auxiliary energy factor for part load at given outdoor temperatures $T_j$ |              |       |                                   |
| $T_j = -7\text{ °C}$  |                | 11.0     | kW   | $T_j = -7\text{ °C}$  |              | 2.4   | %                                 |
| $T_j = +2\text{ °C}$  |                | 6.7      | kW   | $T_j = +2\text{ °C}$  |              | 3.5   | %                                 |
| $T_j = +7\text{ °C}$  |                | 4.3      | kW   | $T_j = +7\text{ °C}$  |              | 5.1   | %                                 |
| $T_j = +12\text{ °C}$   |                | 4.5      | kW   | $T_j = +12\text{ °C}$   |              | 6.1   | %                                 |
| $T_{bw}$ = bivalent temperature   | $P_{bh}$       | 11.0     | kW   | $T_{bw}$ = bivalent temperature   |              | 2.4   | %                                 |
| $T_{ol}$ = operation limit  |                | 9.0      | kW   | $T_{ol}$ = operation limit  |              | 1.8   | %                                 |
| For air-to-water heat pumps: $T_j = -15\text{ °C}$ (if $T_{ol} < -20\text{ °C}$ )                 |                | -        | kW   | For water-to-air heat pumps: $T_j = -15\text{ °C}$ (if $T_{ol} < -20\text{ °C}$ )   |              | -     | %                                 |
| Bivalent temperature  | $T_{bw}$       | -7       | °C   | For water-to-air heat pumps: Operation limit temperature  | $T_{ol}$     | -20   | °C                                |
| Degradation co-efficient heat pumps**   | $C_{dh}$       | 0.25     | -    | Supplementary heater  |              |       |                                   |
| Power consumption in modes other than 'active mode'   |                |          |      |   |              |       |                                   |
| Off mode  | $P_{off}$      | 0.020    | kW   | back-up heating capacity *  | elbu         | 2.0   | kW                                |
| Thermostat-off mode   | $P_{to}$       | 0.090    | kW   | Type of energy input  |              |       |                                   |
| Crankcase heater mode   | $P_{ck}$       | 0.000    | kW   | Standby mode  | $P_{sb}$     | 0.020 | kW                                |
| Other items   |                |          |      |   |              |       |                                   |
| Capacity control  |                | variable |      | For air-to-air heat pumps: air flow rate, outdoor   |              | 3885  | m³/h                              |
| Sound power level, outdoor  | $L_{WA}$       | 70.0     | dB   | For water-/brine-to-air heat pumps: Rated brine or water flow rate, outdoor side heat exchanger   |              | -     | m³/h                              |
| Sound power level, indoor   | $L_{WA}$       | 58.0     | dB   | Emissions of nitrogen oxides (if applicable)  | $NO_x^{***}$ | -     | mg/kWh fuel input GCV             |
|   |                |          |      | GWP of the refrigerant  |              | 2088  | kg CO <sub>2</sub> eq (100 years) |
| Contact details   |                |          |      | Panasonic Testing Centre, Panasonic Marketing Europe GmbH Winsberggring 15, 22525 Hamburg, Germany  |              |       |                                   |

\*\* If  $C_{dh}$  is not determined by measurement then the default degradation coefficient of heat pumps shall be 0.25.  
 \*\*\* from 26 September 2018.  
 Where information relates to multi-split heat pumps, the test result and performance data may be obtained on the basis of the performance of the outdoor unit, with a combination of indoor unit(s) recommended by the manufacturer or importer.  
 \*\*\*\* Refer to Information requirements for UnitList

## Information requirements for air-to-air air conditioners

|  |                             |                              |
|--|-----------------------------|------------------------------|
| Model(s):  | Outdoor Unit<br>Indoor Unit | U-140PE1E8A<br>S-50PN1E5A x3 |
| Outdoor side heat exchanger of air conditioner:  | air                         |                              |
| Indoor side heat exchanger of air conditioner:   | air                         |                              |
| Type: compressor driven vapour compression or sorption process   | vapour compression          |                              |
| if applicable: driver of compressor: [electric motor or fuel driven, gaseous or liquid fuel, internal or external combustion engine] | electric motor              |                              |

## Information requirements for heat pumps

|  |                             |                              |
|--|-----------------------------|------------------------------|
| Model(s):  | Outdoor Unit<br>Indoor Unit | U-140PE1E8A<br>S-50PN1E5A x3 |
| Outdoor side heat exchanger of heat pump:  | air                         |                              |
| Indoor side heat exchanger of heat pump:   | air                         |                              |
| Indication if the heater is equipped with a supplementary heater:  | no                          |                              |
| if applicable: driver of compressor: [electric motor or fuel driven, gaseous or liquid fuel, internal or external combustion engine] | electric motor              |                              |

Parameters shall be declared for the average heating season, parameters for the warmer and colder heating seasons are optional.

| Item   | Symbol         | Value    | Unit             | Item   | Symbol              | Value | Unit                              |
|--|----------------|----------|------------------|--|---------------------|-------|-----------------------------------|
| Rated cooling capacity   | $P_{med,c}$    | 14.0     | kW               | Seasonal space cooling energy efficiency   | $\eta_{p,c}$        | 219.8 | %                                 |
| Refrigeration load   | $P_{design,c}$ | 14.0     | kW               |  |                     |       |                                   |
| Declared cooling capacity for part load at given outdoor temperatures $T_j$ and indoor 27%/19°C (dry/wet bulb)                             |                |          |                  |  |                     |       |                                   |
| $T_j = +35^\circ\text{C}$  |                | 14.0     | kW               | $T_j = +35^\circ\text{C}$  |                     | 3.0   | %                                 |
| $T_j = +30^\circ\text{C}$  |                | 10.3     | kW               | $T_j = +30^\circ\text{C}$  |                     | 4.4   | %                                 |
| $T_j = +25^\circ\text{C}$  |                | 6.8      | kW               | $T_j = +25^\circ\text{C}$  |                     | 6.9   | %                                 |
| $T_j = +20^\circ\text{C}$  |                | 5.3      | kW               | $T_j = +20^\circ\text{C}$  |                     | 9.6   | %                                 |
| Degradation co-efficient for air conditioners**  | $C_{dc}$       | 0.25     | -                |  |                     |       |                                   |
| Declared energy efficiency ratio or gas utilization efficiency / auxiliary energy factor for part load at given outdoor temperatures $T_j$ |                |          |                  |  |                     |       |                                   |
| $T_j = -7^\circ\text{C}$   |                | 12.3     | kW               | $T_j = -7^\circ\text{C}$   |                     | 2.3   | %                                 |
| $T_j = +2^\circ\text{C}$   |                | 7.5      | kW               | $T_j = +2^\circ\text{C}$   |                     | 3.4   | %                                 |
| $T_j = +7^\circ\text{C}$   |                | 4.8      | kW               | $T_j = +7^\circ\text{C}$   |                     | 5.1   | %                                 |
| $T_j = +12^\circ\text{C}$  |                | 4.7      | kW               | $T_j = +12^\circ\text{C}$  |                     | 6.0   | %                                 |
| $T_{bw} = \text{bivalent temperature}$   | $P_{th}$       | 12.3     | kW               | $T_{bw} = \text{bivalent temperature}$   |                     | 2.3   | %                                 |
| $T_{ol} = \text{operation limit}$  |                | 9.3      | kW               | $T_{ol} = \text{operation limit}$  |                     | 1.6   | %                                 |
| For air-to-water heat pumps:<br>$T_j = -15^\circ\text{C}$ (if $T_{ol} < -20^\circ\text{C}$ )   |                | -        | kW               | For water-to-air heat pumps:<br>$T_j = -15^\circ\text{C}$ (if $T_{ol} < -20^\circ\text{C}$ )   |                     | -     | %                                 |
| Bivalent temperature   | $T_{bw}$       | -7       | $^\circ\text{C}$ | Operation limit temperature  | $T_{ol}$            | -20   | $^\circ\text{C}$                  |
| Degradation co-efficient heat pumps**  | $C_{ch}$       | 0.25     | -                |  |                     |       |                                   |
| Power consumption in modes other than 'active mode'  |                |          |                  |  |                     |       |                                   |
| Off mode   | $P_{off}$      | 0.020    | kW               | Crankcase heater mode  | $P_{ck}$            | 0.000 | kW                                |
| Thermostat-off mode  | $P_{to}$       | 0.090    | kW               | Standby mode   | $P_{sb}$            | 0.020 | kW                                |
| Other items  |                |          |                  |  |                     |       |                                   |
| Capacity control   |                | variable |                  | For air-to-air air conditioner: air flow rate, outdoor   |                     | 4767  | $\text{m}^3/\text{h}$             |
| Sound power level, outdoor   | $L_{WA}$       | 71.0     | dB               |  |                     |       |                                   |
| Sound power level, indoor  | $L_{WA}$       | 58.0     | dB               | if engine driven: Emissions of nitrogen oxides   | $\text{NO}_x^{***}$ | -     | mg/kWh fuel input GCV             |
|  |                |          |                  | GWP of the refrigerant   |                     | 2088  | kg CO <sub>2</sub> eq (100 years) |
| Contact details  |                |          |                  | Panasonic Testing Centre, Panasonic Marketing Europe GmbH Winsbergg 15, 22525 Hamburg, Germany |                     |       |                                   |

\*\* If  $C_{dc}$  is not determined by measurement then the default degradation coefficient air conditioners shall be 0.25.

\*\*\* from 26 September 2018.

Where information relates to multi-split air conditioners, the test result and performance data may be obtained on the basis of the performance of the outdoor unit, with a combination of indoor unit(s) recommended by the manufacturer or importer.

\*\*\*\* Refer to Information requirements for UnitList

| Item  | Symbol         | Value    | Unit             | Item  | Symbol              | Value | Unit                              |
|---|----------------|----------|------------------|---|---------------------|-------|-----------------------------------|
| Rated heating capacity  | $P_{med,h}$    | 16.0     | kW               | Seasonal space heating energy efficiency  | $\eta_{p,h}$        | 140.7 | %                                 |
| Refrigeration load  | $P_{design,h}$ | 14.0     | kW               |   |                     |       |                                   |
| Declared heating capacity for part load at indoor temperature 20 °C and outdoor temperature $T_j$ |                |          |                  |   |                     |       |                                   |
| $T_j = -7^\circ\text{C}$  |                | 12.3     | kW               | $T_j = -7^\circ\text{C}$  |                     | 2.3   | %                                 |
| $T_j = +2^\circ\text{C}$  |                | 7.5      | kW               | $T_j = +2^\circ\text{C}$  |                     | 3.4   | %                                 |
| $T_j = +7^\circ\text{C}$  |                | 4.8      | kW               | $T_j = +7^\circ\text{C}$  |                     | 5.1   | %                                 |
| $T_j = +12^\circ\text{C}$   |                | 4.7      | kW               | $T_j = +12^\circ\text{C}$   |                     | 6.0   | %                                 |
| $T_{bw} = \text{bivalent temperature}$  | $P_{th}$       | 12.3     | kW               | $T_{bw} = \text{bivalent temperature}$  |                     | 2.3   | %                                 |
| $T_{ol} = \text{operation limit}$   |                | 9.3      | kW               | $T_{ol} = \text{operation limit}$   |                     | 1.6   | %                                 |
| For air-to-water heat pumps:<br>$T_j = -15^\circ\text{C}$ (if $T_{ol} < -20^\circ\text{C}$ )      |                | -        | kW               | For water-to-air heat pumps:<br>$T_j = -15^\circ\text{C}$ (if $T_{ol} < -20^\circ\text{C}$ )    |                     | -     | %                                 |
| Bivalent temperature  | $T_{bw}$       | -7       | $^\circ\text{C}$ | Operation limit temperature   | $T_{ol}$            | -20   | $^\circ\text{C}$                  |
| Degradation co-efficient heat pumps**   | $C_{ch}$       | 0.25     | -                |   |                     |       |                                   |
| Power consumption in modes other than 'active mode'   |                |          |                  |   |                     |       |                                   |
| Off mode  | $P_{off}$      | 0.020    | kW               | Supplementary heater  |                     |       |                                   |
| Thermostat-off mode   | $P_{to}$       | 0.090    | kW               | back-up heating capacity *  | elbu                | 2.4   | kW                                |
| Crankcase heater mode   | $P_{ck}$       | 0.000    | kW               | Type of energy input  |                     |       |                                   |
| Other items   |                |          |                  |   |                     |       |                                   |
| Capacity control  |                | variable |                  | For air-to-air heat pumps: air flow rate, outdoor   |                     | 4238  | $\text{m}^3/\text{h}$             |
| Sound power level, outdoor  | $L_{WA}$       | 71.0     | dB               | For water-/brine-to-air heat pumps: Rated brine or water flow rate, outdoor side heat exchanger |                     | -     | $\text{m}^3/\text{h}$             |
| Sound power level, indoor   | $L_{WA}$       | 58.0     | dB               | Emissions of nitrogen oxides (if applicable)  | $\text{NO}_x^{***}$ | -     | mg/kWh fuel input GCV             |
|   |                |          |                  | GWP of the refrigerant  |                     | 2088  | kg CO <sub>2</sub> eq (100 years) |
| Contact details   |                |          |                  | Panasonic Testing Centre, Panasonic Marketing Europe GmbH Winsbergg 15, 22525 Hamburg, Germany  |                     |       |                                   |

\*\* If  $C_{ch}$  is not determined by measurement then the default degradation coefficient of heat pumps shall be 0.25.

\*\*\* from 26 September 2018.

Where information relates to multi-split heat pumps, the test result and performance data may be obtained on the basis of the performance of the outdoor unit, with a combination of indoor unit(s) recommended by the manufacturer or importer.

\*\*\*\* Refer to Information requirements for UnitList

Information requirements for air-to-air air conditioners

Model(s): Outdoor Unit U-125PE1E8A  
Indoor Unit S-60PN1E5A x2

Outdoor side heat exchanger of air conditioner: air

Indoor side heat exchanger of air conditioner: air

Type: compressor driven vapour compression or sorption process vapour compression

if applicable: driver of compressor: [electric motor or fuel driven, gaseous or liquid fuel, internal or external combustion engine] electric motor

| Item  | Symbol                  | Value    | Unit | Item  | Symbol  | Value | Unit                              |
|---|-------------------------|----------|------|---|---|-------|-----------------------------------|
| Rated cooling capacity  | P <sub>rated,c</sub>    | 12.5     | kW   | Seasonal space cooling energy efficiency  | η <sub>s,c</sub>  | 229.0 | %                                 |
| Refrigeration load  | P <sub>design,r,c</sub> | 12.5     | kW   | Declared energy efficiency ratio or gas utilization efficiency / auxiliary energy factor for part load at given outdoor temperatures T <sub>j</sub> |   |       |                                   |
| Declared cooling capacity for part load at given outdoor temperatures T <sub>j</sub> and indoor 27%/19°C (dry/wet bulb) |                         |          |      |   |   |       |                                   |
| T <sub>j</sub> = + 35 °C  |                         | 12.5     | kW   | T <sub>j</sub> = + 35 °C  |   | 3.2   | %                                 |
| T <sub>j</sub> = + 30 °C  |                         | 9.2      | kW   | T <sub>j</sub> = + 30 °C  | EER <sub>d</sub> or GUE <sub>d,db</sub> / AEF <sub>d,db</sub> | 4.8   | %                                 |
| T <sub>j</sub> = + 25 °C  | P <sub>dc</sub>         | 5.9      | kW   | T <sub>j</sub> = + 25 °C  |   | 7.2   | %                                 |
| T <sub>j</sub> = + 20 °C  |                         | 5.2      | kW   | T <sub>j</sub> = + 20 °C  |   | 9.8   | %                                 |
| Degradation co-efficient for air conditioners**   | C <sub>dc</sub>         | 0.25     | -    |   |   |       |                                   |
| Power consumption in modes other than 'active mode'   |                         |          |      |   |   |       |                                   |
| Off mode  | P <sub>off</sub>        | 0.020    | kW   | Crankcase heater mode   | P <sub>ck</sub>   | 0.000 | kW                                |
| Thermostat-off mode   | P <sub>to</sub>         | 0.090    | kW   | Standby mode  | P <sub>sb</sub>   | 0.020 | kW                                |
| Other items   |                         |          |      |   |   |       |                                   |
| Capacity control  |                         | variable |      | For air-to-air air conditioner: air flow rate, outdoor  |   | 4591  | m <sup>3</sup> /h                 |
| Sound power level, outdoor  | L <sub>WA</sub>         | 70.0     | dB   |   |   |       |                                   |
| Sound power level, indoor   | L <sub>WA</sub>         | 60.0     | dB   | if engine driven: Emissions of nitrogen oxides  | NO <sub>x</sub> ***   | -     | mg/kWh fuel input GCV             |
|   |                         |          |      | GWP of the refrigerant  |   | 2088  | kg CO <sub>2</sub> eq (100 years) |
| Contact details   |                         |          |      | Panasonic Testing Centre, Panasonic Marketing Europe GmbH Winsberggring 15, 22525 Hamburg, Germany  |   |       |                                   |

\*\* If C<sub>dc</sub> is not determined by measurement then the default degradation coefficient air conditioners shall be 0.25.  
\*\*\* from 26 September 2018.  
Where information relates to multi-split air conditioners, the test result and performance data may be obtained on the basis of the performance of the outdoor unit, with a combination of indoor unit(s) recommended by the manufacturer or importer.  
\*\*\*\* Refer to Information requirements for UnitList

Information requirements for heat pumps

Model(s): Outdoor Unit U-125PE1E8A  
Indoor Unit S-60PN1E5A x2

Outdoor side heat exchanger of heat pump: air

Indoor side heat exchanger of heat pump: air

Indication if the heater is equipped with a supplementary heater: no

if applicable: driver of compressor: [electric motor or fuel driven, gaseous or liquid fuel, internal or external combustion engine] electric motor

Parameters shall be declared for the average heating season, parameters for the warmer and colder heating seasons are optional.

| Item   | Symbol                  | Value    | Unit | Item  | Symbol  | Value | Unit                              |
|--|-------------------------|----------|------|---|---|-------|-----------------------------------|
| Rated heating capacity   | P <sub>rated,h</sub>    | 14.0     | kW   | Seasonal space heating energy efficiency  | η <sub>s,h</sub>  | 144.1 | %                                 |
| Refrigeration load   | P <sub>design,r,h</sub> | 12.5     | kW   | Declared coefficient of performance or gas utilization efficiency / auxiliary energy factor for part load at given outdoor temperatures °C and outdoor temperature T <sub>j</sub> |   |       |                                   |
| Declared heating capacity for part load at indoor temperature 20 °C and outdoor temperature T <sub>j</sub> |                         |          |      |   |   |       |                                   |
| T <sub>j</sub> = - 7 °C  |                         | 11.0     | kW   | T <sub>j</sub> = - 7 °C   |   | 2.4   | %                                 |
| T <sub>j</sub> = + 2 °C  |                         | 6.7      | kW   | T <sub>j</sub> = + 2 °C   |   | 3.5   | %                                 |
| T <sub>j</sub> = + 7 °C  |                         | 4.3      | kW   | T <sub>j</sub> = + 7 °C   |   | 5.1   | %                                 |
| T <sub>j</sub> = + 12 °C   |                         | 4.5      | kW   | T <sub>j</sub> = + 12 °C  | COP <sub>d</sub> or GUE <sub>d,db</sub> / AEF <sub>d,db</sub> | 6.1   | %                                 |
| T <sub>bw</sub> = bivalent temperature   | P <sub>dh</sub>         | 11.0     | kW   | T <sub>bw</sub> = bivalent temperature  |   | 2.4   | %                                 |
| T <sub>ol</sub> = operation limit  |                         | 9.0      | kW   | T <sub>ol</sub> = operation limit   |   | 1.8   | %                                 |
| For air-to-water heat pumps: T <sub>j</sub> = - 15 °C (if T <sub>ol</sub> < - 20 °C)                       |                         | -        | kW   | For water-to-air heat pumps: T <sub>j</sub> = - 15 °C (if T <sub>ol</sub> < - 20 °C)  |   | -     | %                                 |
| Bivalent temperature   | T <sub>bw</sub>         | -7       | °C   | For water-to-air heat pumps: Operation limit temperature  | T <sub>ol</sub>   | -20   | °C                                |
| Degradation co-efficient heat pumps**  | C <sub>dh</sub>         | 0.25     | -    |   |   |       |                                   |
| Power consumption in modes other than 'active mode'  |                         |          |      |   |   |       |                                   |
| Off mode   | P <sub>off</sub>        | 0.020    | kW   | back-up heating capacity *  | eibu  | 2.0   | kW                                |
| Thermostat-off mode  | P <sub>to</sub>         | 0.090    | kW   | Type of energy input  |   |       |                                   |
| Crankcase heater mode  | P <sub>ck</sub>         | 0.000    | kW   | Standby mode  | P <sub>sb</sub>   | 0.020 | kW                                |
| Other items  |                         |          |      |   |   |       |                                   |
| Capacity control   |                         | variable |      | For air-to-air heat pumps: air flow rate, outdoor   |   | 3885  | m <sup>3</sup> /h                 |
| Sound power level, outdoor   | L <sub>WA</sub>         | 70.0     | dB   | For water-/brine-to-air heat pumps: Rated brine or water flow rate, outdoor side heat exchanger   |   | -     | m <sup>3</sup> /h                 |
| Sound power level, indoor  | L <sub>WA</sub>         | 60.0     | dB   | Emissions of nitrogen oxides (if applicable)  | NO <sub>x</sub> ***   | -     | mg/kWh fuel input GCV             |
|  |                         |          |      | GWP of the refrigerant  |   | 2088  | kg CO <sub>2</sub> eq (100 years) |
| Contact details  |                         |          |      | Panasonic Testing Centre, Panasonic Marketing Europe GmbH Winsberggring 15, 22525 Hamburg, Germany  |   |       |                                   |

\*\* If C<sub>dh</sub> is not determined by measurement then the default degradation coefficient of heat pumps shall be 0.25.  
\*\*\* from 26 September 2018.  
Where information relates to multi-split heat pumps, the test result and performance data may be obtained on the basis of the performance of the outdoor unit, with a combination of indoor unit(s) recommended by the manufacturer or importer.  
\*\*\*\* Refer to Information requirements for UnitList

Information requirements for air-to-air air conditioners

|  |                             |                              |
|--|-----------------------------|------------------------------|
| Model(s):  | Outdoor Unit<br>Indoor Unit | U-140PE1E8A<br>S-71PN1E5A x2 |
| Outdoor side heat exchanger of air conditioner:  | air                         |                              |
| Indoor side heat exchanger of air conditioner:   | air                         |                              |
| Type: compressor driven vapour compression or sorption process   | vapour compression          |                              |
| if applicable: driver of compressor: [electric motor or fuel driven, gaseous or liquid fuel, internal or external combustion engine] | electric motor              |                              |

| Item   | Symbol   | Value    | Unit | Item   | Symbol  | Value | Unit                              |
|--|--|----------|------|--|---|-------|-----------------------------------|
| Rated cooling capacity   | $P_{rated,c}$  | 14.0     | kW   | Seasonal space cooling energy efficiency   | $\eta_{s,c}$  | 219.8 | %                                 |
| Refrigeration load   | $P_{design,c}$   | 14.0     | kW   | Declared energy efficiency ratio or gas utilization efficiency / auxiliary energy factor for part load at given outdoor temperatures $T_j$ |   |       |                                   |
| Declared cooling capacity for part load at given outdoor temperatures $T_j$ and indoor 27%/19°C (dry/wet bulb) |  |          |      |  |   |       |                                   |
| $T_j = +35\text{ °C}$  |  | 14.0     | kW   | $T_j = +35\text{ °C}$  |   | 3.0   | %                                 |
| $T_j = +30\text{ °C}$  |  | 10.3     | kW   | $T_j = +30\text{ °C}$  | EER <sub>0</sub> or GUE <sub>0,br</sub> / AEF <sub>0,br</sub> | 4.4   | %                                 |
| $T_j = +25\text{ °C}$  | P <sub>dc</sub>  | 6.6      | kW   | $T_j = +25\text{ °C}$  |   | 6.9   | %                                 |
| $T_j = +20\text{ °C}$  |  | 5.3      | kW   | $T_j = +20\text{ °C}$  |   | 9.6   | %                                 |
| Degradation co-efficient for air conditioners**  | C <sub>dc</sub>  | 0.25     | -    | Power consumption in modes other than 'active mode'  |   |       |                                   |
| Off mode   |  |          |      |  |   |       |                                   |
|  | P <sub>off</sub>   | 0.020    | kW   | Crankcase heater mode  | P <sub>ck</sub>   | 0.000 | kW                                |
| Thermostat-off mode  | P <sub>to</sub>  | 0.090    | kW   | Standby mode   | P <sub>sb</sub>   | 0.020 | kW                                |
| Other items  |  |          |      |  |   |       |                                   |
| Capacity control   |  | variable |      | For air-to-air conditioner: air flow rate, outdoor   |   | 4767  | m <sup>3</sup> /h                 |
| Sound power level, outdoor   | L <sub>WA</sub>  | 71.0     | dB   |  |   |       |                                   |
| Sound power level, indoor  | L <sub>WA</sub>  | 60.0     | dB   | if engine driven: Emissions of nitrogen oxides   | NO <sub>x</sub> ***   | -     | mg/kWh fuel input GCV             |
|  |  |          |      | GWP of the refrigerant   |   | 2088  | kg CO <sub>2</sub> eq (100 years) |
| Contact details  | Panasonic Testing Centre, Panasonic Marketing Europe GmbH Winsbergiring 15, 22525 Hamburg, Germany |          |      |  |   |       |                                   |

\*\* If C<sub>dc</sub> is not determined by measurement then the default degradation coefficient air conditioners shall be 0.25.  
 \*\*\* from 26 September 2018.  
 Where information relates to multi-split air conditioners, the test result and performance data may be obtained on the basis of the performance of the outdoor unit, with a combination of indoor unit(s) recommended by the manufacturer or importer.  
 \*\*\*\* Refer to Information requirements for UnitList

Information requirements for heat pumps

|  |                             |                              |
|--|-----------------------------|------------------------------|
| Model(s):  | Outdoor Unit<br>Indoor Unit | U-140PE1E8A<br>S-71PN1E5A x2 |
| Outdoor side heat exchanger of heat pump:  | air                         |                              |
| Indoor side heat exchanger of heat pump:   | air                         |                              |
| Indication if the heater is equipped with a supplementary heater:  | no                          |                              |
| if applicable: driver of compressor: [electric motor or fuel driven, gaseous or liquid fuel, internal or external combustion engine] | electric motor              |                              |

Parameters shall be declared for the average heating season, parameters for the warmer and colder heating seasons are optional.

| Item  | Symbol   | Value    | Unit | Item   | Symbol  | Value | Unit                              |
|---|--|----------|------|--|---|-------|-----------------------------------|
| Rated heating capacity  | $P_{rated,h}$  | 16.0     | kW   | Seasonal space heating energy efficiency   | $\eta_{s,h}$  | 140.7 | %                                 |
| Refrigeration load  | $P_{design,h}$   | 14.0     | kW   | Declared coefficient of performance or gas utilization efficiency / auxiliary energy factor for part load at given outdoor temperatures °C and outdoor temperature $T_j$ |   |       |                                   |
| Declared heating capacity for part load at indoor temperature 20 °C and outdoor temperature $T_j$ |  |          |      |  |   |       |                                   |
| $T_j = -7\text{ °C}$  |  | 12.3     | kW   | $T_j = -7\text{ °C}$   |   | 2.3   | %                                 |
| $T_j = +2\text{ °C}$  |  | 7.5      | kW   | $T_j = +2\text{ °C}$   |   | 3.4   | %                                 |
| $T_j = +7\text{ °C}$  |  | 4.8      | kW   | $T_j = +7\text{ °C}$   |   | 5.1   | %                                 |
| $T_j = +12\text{ °C}$   |  | 4.7      | kW   | $T_j = +12\text{ °C}$  | COP <sub>0</sub> or GUE <sub>0,br</sub> / AEF <sub>0,br</sub> | 6.0   | %                                 |
| $T_{br} = \text{bivalent temperature}$  | P <sub>ch</sub>  | 12.3     | kW   | $T_{br} = \text{bivalent temperature}$   |   | 2.3   | %                                 |
| $T_{ol} = \text{operation limit}$   |  | 9.3      | kW   | $T_{ol} = \text{operation limit}$  |   | 1.6   | %                                 |
| For air-to-water heat pumps: $T_j = -15\text{ °C}$ (if $T_{ol} < -20\text{ °C}$ )                 |  | -        | kW   | For water-to-air heat pumps: $T_j = -15\text{ °C}$ (if $T_{ol} < -20\text{ °C}$ )  |   | -     | %                                 |
| Bivalent temperature  | T <sub>br</sub>  | -7       | °C   | For water-to-air heat pumps: Operation limit temperature   | T <sub>ol</sub>   | -20   | °C                                |
| Degradation co-efficient heat pumps**   | C <sub>ch</sub>  | 0.25     | -    | Power consumption in modes other than 'active mode'  |   |       |                                   |
| Off mode  |  |          |      |  |   |       |                                   |
|   | P <sub>off</sub>   | 0.020    | kW   | back-up heating capacity *   | eibu  | 2.4   | kW                                |
| Thermostat-off mode   | P <sub>to</sub>  | 0.090    | kW   | Type of energy input   |   |       |                                   |
| Crankcase heater mode   | P <sub>ck</sub>  | 0.000    | kW   | Standby mode   | P <sub>sb</sub>   | 0.020 | kW                                |
| Other items   |  |          |      |  |   |       |                                   |
| Capacity control  |  | variable |      | For air-to-air heat pumps: air flow rate, outdoor  |   | 4238  | m <sup>3</sup> /h                 |
| Sound power level, outdoor  | L <sub>WA</sub>  | 71.0     | dB   | For water-/brine-to-air heat pumps: Rated brine or water flow rate, outdoor side heat exchanger  |   | -     | m <sup>3</sup> /h                 |
| Sound power level, indoor   | L <sub>WA</sub>  | 60.0     | dB   | Emissions of nitrogen oxides (if applicable)   | NO <sub>x</sub> ***   | -     | mg/kWh fuel input GCV             |
|   |  |          |      | GWP of the refrigerant   |   | 2088  | kg CO <sub>2</sub> eq (100 years) |
| Contact details   | Panasonic Testing Centre, Panasonic Marketing Europe GmbH Winsbergiring 15, 22525 Hamburg, Germany |          |      |  |   |       |                                   |

\*\* If C<sub>ch</sub> is not determined by measurement then the default degradation coefficient of heat pumps shall be 0.25.  
 \*\*\* from 26 September 2018.  
 Where information relates to multi-split heat pumps, the test result and performance data may be obtained on the basis of the performance of the outdoor unit, with a combination of indoor unit(s) recommended by the manufacturer or importer.  
 \*\*\*\* Refer to Information requirements for UnitList



## Information requirements for air-to-air air conditioners

|  |                             |                             |
|--|-----------------------------|-----------------------------|
| Model(s):  | Outdoor Unit<br>Indoor Unit | U-125PE1E8A<br>S-125PNI E5A |
| Outdoor side heat exchanger of air conditioner:  | air                         |                             |
| Indoor side heat exchanger of air conditioner:   | air                         |                             |
| Type: compressor driven vapour compression or sorption process   | vapour compression          |                             |
| if applicable: driver of compressor: [electric motor or fuel driven, gaseous or liquid fuel, internal or external combustion engine] | electric motor              |                             |

| Item   | Symbol                | Value    | Unit | Item  | Symbol  | Value               | Unit                              |       |    |
|--|-----------------------|----------|------|---|---|---------------------|-----------------------------------|-------|----|
| Rated cooling capacity   | $P_{rated,c}$         | 12.5     | kW   | Seasonal space cooling energy efficiency  | $\eta_{p,c}$  | 214.6               | %                                 |       |    |
| Refrigeration load   | $P_{design,c}$        | 12.5     | kW   | Declared energy efficiency ratio or gas utilization efficiency / auxiliary energy factor for part load at given outdoor temperatures $T_j$ and indoor 27°/19°C (dry/wet bulb) |   |                     |                                   |       |    |
| Declared cooling capacity for part load at given outdoor temperatures $T_j$ and indoor 27°/19°C (dry/wet bulb) | $T_j = +35\text{ °C}$ | 12.5     | kW   | $T_j = +35\text{ °C}$   | EER <sub>d</sub> or<br>GUE <sub>d,br</sub> /<br>AEF <sub>d,br</sub> | 3.2                 | %                                 |       |    |
|  | $T_j = +30\text{ °C}$ | 9.2      | kW   | $T_j = +30\text{ °C}$   |   | 4.8                 | %                                 |       |    |
|  | $T_j = +25\text{ °C}$ | 5.9      | kW   | $T_j = +25\text{ °C}$   |   | 7.2                 | %                                 |       |    |
|  | $T_j = +20\text{ °C}$ | 5.2      | kW   | $T_j = +20\text{ °C}$   |   | 9.8                 | %                                 |       |    |
| Degradation co-efficient for air conditioners**  | $C_{de}$              | 0.25     | -    | Power consumption in modes other than 'active mode'   |   |                     |                                   |       |    |
| Off mode   |                       |          |      | $P_{off}$   | 0.020   | kW                  | $P_{ck}$                          | 0.000 | kW |
| Thermostat-off mode  |                       |          |      | $P_{to}$  | 0.220   | kW                  | $P_{sb}$                          | 0.020 | kW |
| Other items  |                       |          |      |   |   |                     |                                   |       |    |
| Capacity control   |                       | variable |      | For air-to-air conditioner: air flow rate, outdoor  |   | 4591                | m <sup>3</sup> /h                 |       |    |
| Sound power level, outdoor   | $L_{WA}$              | 70.0     | dB   |   |   |                     |                                   |       |    |
| Sound power level, indoor  | $L_{WA}$              | 66.0     | dB   | if engine driven: Emissions of nitrogen oxides  |   | NO <sub>x</sub> *** | mg/kWh fuel input GCV             |       |    |
|  |                       |          |      | GWP of the refrigerant  |   | 2088                | kg CO <sub>2</sub> eq (100 years) |       |    |
| Contact details  |                       |          |      | Panasonic Testing Centre, Panasonic Marketing Europe GmbH Winsbergiring 15, 22525 Hamburg, Germany  |   |                     |                                   |       |    |

\*\* If  $C_{de}$  is not determined by measurement then the default degradation coefficient air conditioners shall be 0.25.  
 \*\*\* from 26 September 2018.  
 Where information relates to multi-split air conditioners, the test result and performance data may be obtained on the basis of the performance of the outdoor unit, with a combination of indoor unit(s) recommended by the manufacturer or importer.  
 \*\*\*\* Refer to Information requirements for UnitList

## Information requirements for heat pumps

|  |                             |                             |
|--|-----------------------------|-----------------------------|
| Model(s):  | Outdoor Unit<br>Indoor Unit | U-125PE1E8A<br>S-125PNI E5A |
| Outdoor side heat exchanger of heat pump:  | air                         |                             |
| Indoor side heat exchanger of heat pump:   | air                         |                             |
| Indication if the heater is equipped with a supplementary heater:  | no                          |                             |
| if applicable: driver of compressor: [electric motor or fuel driven, gaseous or liquid fuel, internal or external combustion engine] | electric motor              |                             |

Parameters shall be declared for the average heating season, parameters for the warmer and colder heating seasons are optional.

| Item  | Symbol                | Value    | Unit | Item   | Symbol  | Value               | Unit                              |     |    |
|---|-----------------------|----------|------|--|---|---------------------|-----------------------------------|-----|----|
| Rated heating capacity  | $P_{rated,h}$         | 14.0     | kW   | Seasonal space heating energy efficiency   | $\eta_{p,h}$  | 143.4               | %                                 |     |    |
| Refrigeration load  | $P_{design,h}$        | 12.5     | kW   | Declared coefficient of performance or gas utilization efficiency / auxiliary energy factor for part load at given outdoor temperatures °C and outdoor temperature $T_j$ |   |                     |                                   |     |    |
| Declared heating capacity for part load at indoor temperature 20 °C and outdoor temperature $T_j$ | $T_j = -7\text{ °C}$  | 11.0     | kW   | $T_j = -7\text{ °C}$   | COP <sub>d</sub> or<br>GUE <sub>d,br</sub> /<br>AEF <sub>d,br</sub> | 2.4                 | %                                 |     |    |
|   | $T_j = +2\text{ °C}$  | 6.7      | kW   | $T_j = +2\text{ °C}$   |   | 3.5                 | %                                 |     |    |
|   | $T_j = +7\text{ °C}$  | 4.3      | kW   | $T_j = +7\text{ °C}$   |   | 5.1                 | %                                 |     |    |
|   | $T_j = +12\text{ °C}$ | 4.5      | kW   | $T_j = +12\text{ °C}$  |   | 6.1                 | %                                 |     |    |
| Degradation co-efficient for heat pumps**   | $C_{de}$              | 0.25     | -    | Power consumption in modes other than 'active mode'  |   |                     |                                   |     |    |
| Off mode  |                       |          |      | $P_{off}$  | 0.020   | kW                  | $e_{ibu}$                         | 2.0 | kW |
| Thermostat-off mode   |                       |          |      | $P_{to}$   | 0.220   | kW                  | Type of energy input              |     |    |
| Crankcase heater mode   |                       |          |      | $P_{ck}$   | 0.000   | kW                  | Standby mode                      |     |    |
| Other items   |                       |          |      |  |   |                     |                                   |     |    |
| Capacity control  |                       | variable |      | For air-to-air heat pumps: air flow rate, outdoor  |   | 3885                | m <sup>3</sup> /h                 |     |    |
| Sound power level, outdoor  | $L_{WA}$              | 70.0     | dB   | For water-/brine-to-air heat pumps: Rated brine or water flow rate, outdoor side heat exchanger  |   | -                   | m <sup>3</sup> /h                 |     |    |
| Sound power level, indoor   | $L_{WA}$              | 66.0     | dB   | Emissions of nitrogen oxides (if applicable)   |   | NO <sub>x</sub> *** | mg/kWh fuel input GCV             |     |    |
|   |                       |          |      | GWP of the refrigerant   |   | 2088                | kg CO <sub>2</sub> eq (100 years) |     |    |
| Contact details   |                       |          |      | Panasonic Testing Centre, Panasonic Marketing Europe GmbH Winsbergiring 15, 22525 Hamburg, Germany   |   |                     |                                   |     |    |

\*\* If  $C_{de}$  is not determined by measurement then the default degradation coefficient of heat pumps shall be 0.25.  
 \*\*\* from 26 September 2018.  
 Where information relates to multi-split heat pumps, the test result and performance data may be obtained on the basis of the performance of the outdoor unit, with a combination of indoor unit(s) recommended by the manufacturer or importer.  
 \*\*\*\* Refer to Information requirements for UnitList

Information requirements for air-to-air air conditioners

Model(s): Outdoor Unit U-140PE1E8A  
Indoor Unit S-140PN1E5A

Outdoor side heat exchanger of air conditioner: air

Outdoor side heat exchanger of air conditioner: air

Type: compressor driven vapour compression or sorption process  
if applicable: driver of compressor: [electric motor or fuel driven, gaseous or liquid fuel, internal or external combustion engine]  
vapour compression  
electric motor

| Item  | Symbol                | Value    | Unit | Item   | Symbol  | Value | Unit                              |
|---|-----------------------|----------|------|--|---|-------|-----------------------------------|
| Rated cooling capacity  | P <sub>med,c</sub>    | 14.0     | kW   | Seasonal space cooling energy efficiency   | η <sub>sc</sub>   | 207.8 | %                                 |
| Refrigeration load  | P <sub>design,c</sub> | 14.0     | kW   | Declared energy efficiency ratio or gas utilization efficiency / auxiliary energy factor for part load at given outdoor temperatures T <sub>j</sub> and indoor 27%/19°C (dry/wet bulb) |   |       |                                   |
| Declared cooling capacity for part load at given outdoor temperatures T <sub>j</sub> and indoor 27%/19°C (dry/wet bulb) |                       |          |      | T <sub>j</sub>   |   |       |                                   |
| T <sub>j</sub> = + 35 °C  |                       | 14.0     | kW   | T <sub>j</sub> = + 35 °C   |   | 3.0   | %                                 |
| T <sub>j</sub> = + 30 °C  |                       | 10.3     | kW   | T <sub>j</sub> = + 30 °C   | EER <sub>d</sub> or GUE <sub>d,db</sub> / AEF <sub>d,db</sub> | 4.4   | %                                 |
| T <sub>j</sub> = + 25 °C  | P <sub>dc</sub>       | 6.6      | kW   | T <sub>j</sub> = + 25 °C   |   | 6.9   | %                                 |
| T <sub>j</sub> = + 20 °C  |                       | 5.3      | kW   | T <sub>j</sub> = + 20 °C   |   | 9.6   | %                                 |
| Degradation co-efficient for air conditioners**   | C <sub>dc</sub>       | 0.25     | -    |  |   |       |                                   |
| Power consumption in modes other than 'active mode'   |                       |          |      |  |   |       |                                   |
| Off mode  | P <sub>off</sub>      | 0.020    | kW   | Crankcase heater mode  | P <sub>ck</sub>   | 0.000 | kW                                |
| Thermostat-off mode   | P <sub>to</sub>       | 0.220    | kW   | Standby mode   | P <sub>sb</sub>   | 0.020 | kW                                |
| Other items   |                       |          |      |  |   |       |                                   |
| Capacity control  |                       | variable |      | For air-to-air air conditioner: air flow rate, outdoor   |   | 4767  | m <sup>3</sup> /h                 |
| Sound power level, outdoor  | L <sub>WA</sub>       | 71.0     | dB   |  |   |       |                                   |
| Sound power level, indoor   | L <sub>WA</sub>       | 67.0     | dB   | if engine driven: Emissions of nitrogen oxides   | NO <sub>x</sub> ***   | -     | mg/kWh fuel input GCV             |
|   |                       |          |      | GWP of the refrigerant   |   | 2088  | kg CO <sub>2</sub> eq (100 years) |
| Contact details   |                       |          |      | Panasonic Testing Centre, Panasonic Marketing Europe GmbH Winsberggring 15, 22525 Hamburg, Germany   |   |       |                                   |

\*\* If C<sub>dc</sub> is not determined by measurement then the default degradation coefficient air conditioners shall be 0.25.  
\*\*\* from 26 September 2018.  
Where information relates to multi-split air conditioners, the test result and performance data may be obtained on the basis of the performance of the outdoor unit, with a combination of indoor unit(s) recommended by the manufacturer or importer.  
\*\*\*\* Refer to Information requirements for UnitList

Information requirements for heat pumps

Model(s): Outdoor Unit U-140PE1E8A  
Indoor Unit S-140PN1E5A

Outdoor side heat exchanger of heat pump: air

Outdoor side heat exchanger of heat pump: air

Indication if the heater is equipped with a supplementary heater: no

if applicable: driver of compressor: [electric motor or fuel driven, gaseous or liquid fuel, internal or external combustion engine]  
electric motor

Parameters shall be declared for the average heating season, parameters for the warmer and colder heating seasons are optional.

| Item   | Symbol                | Value    | Unit | Item  | Symbol  | Value | Unit                              |
|--|-----------------------|----------|------|---|---|-------|-----------------------------------|
| Rated heating capacity   | P <sub>med,h</sub>    | 16.0     | kW   | Seasonal space heating energy efficiency  | η <sub>sh</sub>   | 140.1 | %                                 |
| Refrigeration load   | P <sub>design,h</sub> | 14.0     | kW   | Declared coefficient of performance or gas utilization efficiency / auxiliary energy factor for part load at given outdoor temperatures °C and outdoor temperature T <sub>j</sub> |   |       |                                   |
| Declared heating capacity for part load at indoor temperature 20 °C and outdoor temperature T <sub>j</sub> |                       |          |      | T <sub>j</sub>  |   |       |                                   |
| T <sub>j</sub> = - 7 °C  |                       | 12.3     | kW   | T <sub>j</sub> = - 7 °C   |   | 2.3   | %                                 |
| T <sub>j</sub> = + 2 °C  |                       | 7.5      | kW   | T <sub>j</sub> = + 2 °C   |   | 3.4   | %                                 |
| T <sub>j</sub> = + 7 °C  |                       | 4.8      | kW   | T <sub>j</sub> = + 7 °C   |   | 5.1   | %                                 |
| T <sub>j</sub> = + 12 °C   |                       | 4.7      | kW   | T <sub>j</sub> = + 12 °C  | COP <sub>d</sub> or GUE <sub>d,db</sub> / AEF <sub>d,db</sub> | 6.0   | %                                 |
| T <sub>bw</sub> = bivalent temperature   | P <sub>sh</sub>       | 12.3     | kW   | T <sub>bw</sub> = bivalent temperature  |   | 2.3   | %                                 |
| T <sub>ol</sub> = operation limit  |                       | 9.3      | kW   | T <sub>ol</sub> = operation limit   |   | 1.6   | %                                 |
| For air-to-water heat pumps: T <sub>j</sub> = - 15 °C (if T <sub>ol</sub> < - 20 °C)                       |                       | -        | kW   | For water-to-air heat pumps: T <sub>j</sub> = - 15 °C (if T <sub>ol</sub> < - 20 °C)  |   | -     | %                                 |
| Bivalent temperature   | T <sub>bw</sub>       | -7       | °C   | For water-to-air heat pumps: Operation limit temperature  | T <sub>ol</sub>   | -20   | °C                                |
| Degradation co-efficient heat pumps**  | C <sub>sh</sub>       | 0.25     | -    |   |   |       |                                   |
| Power consumption in modes other than 'active mode'  |                       |          |      |   |   |       |                                   |
| Off mode   | P <sub>off</sub>      | 0.020    | kW   | back-up heating capacity *  | elbu  | 2.4   | kW                                |
| Thermostat-off mode  | P <sub>to</sub>       | 0.220    | kW   | Type of energy input  |   |       |                                   |
| Crankcase heater mode  | P <sub>ck</sub>       | 0.000    | kW   | Standby mode  | P <sub>sb</sub>   | 0.020 | kW                                |
| Other items  |                       |          |      |   |   |       |                                   |
| Capacity control   |                       | variable |      | For air-to-air heat pumps: air flow rate, outdoor   |   | 4238  | m <sup>3</sup> /h                 |
| Sound power level, outdoor   | L <sub>WA</sub>       | 71.0     | dB   | For water-/brine-to-air heat pumps: Rated brine or water flow rate, outdoor side heat exchanger   |   | -     | m <sup>3</sup> /h                 |
| Sound power level, indoor  | L <sub>WA</sub>       | 67.0     | dB   | Emissions of nitrogen oxides (if applicable)  | NO <sub>x</sub> ***   | -     | mg/kWh fuel input GCV             |
|  |                       |          |      | GWP of the refrigerant  |   | 2088  | kg CO <sub>2</sub> eq (100 years) |
| Contact details  |                       |          |      | Panasonic Testing Centre, Panasonic Marketing Europe GmbH Winsberggring 15, 22525 Hamburg, Germany  |   |       |                                   |

\*\* If C<sub>sh</sub> is not determined by measurement then the default degradation coefficient of heat pumps shall be 0.25.  
\*\*\* from 26 September 2018.  
Where information relates to multi-split heat pumps, the test result and performance data may be obtained on the basis of the performance of the outdoor unit, with a combination of indoor unit(s) recommended by the manufacturer or importer.  
\*\*\*\* Refer to Information requirements for UnitList

## Information requirements for air-to-air air conditioners

|   |                             |                           |    |
|---|-----------------------------|---------------------------|----|
| Model(s):   | Outdoor Unit<br>Indoor Unit | U-125PE1E5A<br>S-36PY2E5A | X4 |
| Outdoor side heat exchanger of air conditioner:   | air                         |                           |    |
| Indoor side heat exchanger of air conditioner:  | air                         |                           |    |
| Type: compressor driven vapour compression or sorption process if applicable; driver of compressor: [electric motor or fuel driven, gaseous or liquid fuel, internal or external combustion engine] | vapour compression          |                           |    |
|   | electric motor              |                           |    |

## Information requirements for heat pumps

|  |                             |                           |    |
|--|-----------------------------|---------------------------|----|
| Model(s):  | Outdoor Unit<br>Indoor Unit | U-125PE1E5A<br>S-36PY2E5A | X4 |
| Outdoor side heat exchanger of heat pump:  | air                         |                           |    |
| Indoor side heat exchanger of heat pump:   | air                         |                           |    |
| Indication if the heater is equipped with a supplementary heater: if applicable; driver of compressor: [electric motor or fuel driven, gaseous or liquid fuel, internal or external combustion engine] | no                          |                           |    |
| Parameters shall be declared for the average heating season, parameters for the warmer and colder heating seasons are optional.  | electric motor              |                           |    |

| Item   | Symbol   | Value            | Unit  | Item  | Symbol  | Value           | Unit                              |    |
|--|--|------------------|-------|---|---|-----------------|-----------------------------------|----|
| Rated cooling capacity   | $P_{rated,c}$  | 12.5             | kW    | Seasonal space cooling energy efficiency  | $\eta_{se}$   | 209.2           | %                                 |    |
| Refrigeration load   | $P_{design,c}$   | 12.5             | kW    | Declared energy efficiency ratio or gas utilization efficiency / auxiliary energy factor for part load at given outdoor temperatures $T_j$ and indoor 27°/19°C (dry/wet bulb) |   |                 |                                   |    |
| Declared cooling capacity for part load at given outdoor temperatures $T_j$ and indoor 27°/19°C (dry/wet bulb) | $T_j = +35\text{ °C}$  | 12.5             | kW    | $T_j = +35\text{ °C}$   | EER <sub>d</sub> or GUE <sub>c,bin</sub> / AEF <sub>c,bin</sub> | 3.2             | %                                 |    |
|  | $T_j = +30\text{ °C}$  | 9.2              | kW    | $T_j = +30\text{ °C}$   |   | 4.4             | %                                 |    |
|  | $T_j = +25\text{ °C}$  | 5.9              | kW    | $T_j = +25\text{ °C}$   |   | 6.6             | %                                 |    |
|  | $T_j = +20\text{ °C}$  | 4.8              | kW    | $T_j = +20\text{ °C}$   |   | 8.9             | %                                 |    |
| Degradation co-efficient for air conditioners**  | $C_{dc}$   | 0.25             | -     | Declared heating capacity for part load at indoor temperature 20 °C and outdoor temperature $T_j$   |   |                 |                                   |    |
| Declared heating capacity for part load at indoor temperature 20 °C and outdoor temperature $T_j$              | $T_j = -7\text{ °C}$   | 11.0             | kW    | $T_j = -7\text{ °C}$  | COP <sub>d</sub> or GUE <sub>h,bin</sub> / AEF <sub>h,bin</sub> | 2.3             | %                                 |    |
|  | $T_j = +2\text{ °C}$   | 6.7              | kW    | $T_j = +2\text{ °C}$  |   | 3.5             | %                                 |    |
|  | $T_j = +7\text{ °C}$   | 4.3              | kW    | $T_j = +7\text{ °C}$  |   | 4.9             | %                                 |    |
|  | $T_j = +12\text{ °C}$  | 4.1              | kW    | $T_j = +12\text{ °C}$   |   | 5.7             | %                                 |    |
| T <sub>bin</sub> = bivalent temperature  | P <sub>bh</sub>  | 12.0             | kW    | T <sub>bin</sub> = bivalent temperature   | T <sub>ol</sub> = operation limit                               | 2.1             | %                                 |    |
|  |  | 9.5              | kW    | T <sub>ol</sub> = operation limit   |   | 1.6             | %                                 |    |
| For air-to-water heat pumps: $T_j = -15\text{ °C}$ (if T <sub>ol</sub> < -20 °C)                               |  | -                | kW    | For water-to-air heat pumps: $T_j = -15\text{ °C}$ (if T <sub>ol</sub> < -20 °C)  |   | -               | %                                 |    |
| Bivalent temperature   | T <sub>bw</sub>  | -9               | °C    | For water-to-air heat pumps: Operation limit temperature  | T <sub>ol</sub>   | -20             | °C                                |    |
| Degradation co-efficient heat pumps**  | C <sub>dh</sub>  | 0.25             | -     | Power consumption in modes other than 'active mode'   |   |                 |                                   |    |
| Power consumption in modes other than 'active mode'  | Off mode   | P <sub>off</sub> | 0.040 | kW  | Crankcase heater mode   | P <sub>ck</sub> | 0.000                             | kW |
|  | Thermostat-off mode  | P <sub>to</sub>  | 0.087 | kW  | Standby mode  | P <sub>sb</sub> | 0.040                             | kW |
|  | Crankcase heater mode  | P <sub>ck</sub>  | 0.000 | kW  | Other items   |                 |                                   |    |
| Capacity control   |  | variable         |       | For air-to-air air conditioner: air flow rate, outdoor  |   | 7800            | m³/h                              |    |
| Sound power level, outdoor   | L <sub>WA</sub>  | 70.0             | dB    |   |   |                 |                                   |    |
| Sound power level, indoor  | L <sub>WA</sub>  | 51.0             | dB    | if engine driven: Emissions of nitrogen oxides  | NO <sub>x</sub> ***   |                 | mg/kWh fuel input GCV             |    |
|  |  |                  |       | GWP of the refrigerant  |   | 2088            | kg CO <sub>2</sub> eq (100 years) |    |
| Contact details  | Panasonic Testing Centre, Panasonic Marketing Europe GmbH Winsbergweg 15, 22525 Hamburg, Germany |                  |       |   |   |                 |                                   |    |

\*\* If C<sub>dc</sub> is not determined by measurement then the default degradation coefficient air conditioners shall be 0.25.  
 \*\*\* from 26 September 2018.  
 Where information relates to multi-split air conditioners, the test result and performance data may be obtained on the basis of the performance of the outdoor unit, with a combination of indoor unit(s) recommended by the manufacturer or importer.

| Item  | Symbol   | Value            | Unit  | Item  | Symbol  | Value | Unit                              |    |
|---|--|------------------|-------|---|---|-------|-----------------------------------|----|
| Rated heating capacity  | $P_{rated,h}$  | 14.0             | kW    | Seasonal space heating energy efficiency  | $\eta_{sh}$   | 141.4 | %                                 |    |
| Refrigeration load  | $P_{design,h}$   | 12.5             | kW    | Declared coefficient of performance or gas utilization efficiency / auxiliary energy factor for part load at given outdoor temperatures $T_j$ |   |       |                                   |    |
| Declared heating capacity for part load at indoor temperature 20 °C and outdoor temperature $T_j$ | $T_j = -7\text{ °C}$   | 11.0             | kW    | $T_j = -7\text{ °C}$  | COP <sub>d</sub> or GUE <sub>h,bin</sub> / AEF <sub>h,bin</sub> | 2.3   | %                                 |    |
|   | $T_j = +2\text{ °C}$   | 6.7              | kW    | $T_j = +2\text{ °C}$  |   | 3.5   | %                                 |    |
|   | $T_j = +7\text{ °C}$   | 4.3              | kW    | $T_j = +7\text{ °C}$  |   | 4.9   | %                                 |    |
|   | $T_j = +12\text{ °C}$  | 4.1              | kW    | $T_j = +12\text{ °C}$   |   | 5.7   | %                                 |    |
| T <sub>bin</sub> = bivalent temperature   | P <sub>bh</sub>  | 12.0             | kW    | T <sub>bin</sub> = bivalent temperature   | T <sub>ol</sub> = operation limit                               | 2.1   | %                                 |    |
|   |  | 9.5              | kW    | T <sub>ol</sub> = operation limit   |   | 1.6   | %                                 |    |
| For air-to-water heat pumps: $T_j = -15\text{ °C}$ (if T <sub>ol</sub> < -20 °C)                  |  | -                | kW    | For water-to-air heat pumps: $T_j = -15\text{ °C}$ (if T <sub>ol</sub> < -20 °C)  |   | -     | %                                 |    |
| Bivalent temperature  | T <sub>bw</sub>  | -9               | °C    | For water-to-air heat pumps: Operation limit temperature  | T <sub>ol</sub>   | -20   | °C                                |    |
| Degradation co-efficient heat pumps**   | C <sub>dh</sub>  | 0.25             | -     | Power consumption in modes other than 'active mode'   |   |       |                                   |    |
| Power consumption in modes other than 'active mode'   | Off mode   | P <sub>off</sub> | 0.040 | kW  | Supplementary heater  |       |                                   |    |
|   | Thermostat-off mode  | P <sub>to</sub>  | 0.087 | kW  | back-up heating capacity *                                      | elbu  | 0.8                               | kW |
|   | Crankcase heater mode  | P <sub>ck</sub>  | 0.000 | kW  | Type of energy input  |       |                                   |    |
| Capacity control  |  | variable         |       | Standby mode  | P <sub>sb</sub>   | 0.040 | kW                                |    |
| Sound power level, outdoor  | L <sub>WA</sub>  | 70.0             | dB    | Other items   |   |       |                                   |    |
| Sound power level, indoor   | L <sub>WA</sub>  | 51.0             | dB    | For air-to-air heat pumps: air flow rate, outdoor   |   | 6600  | m³/h                              |    |
|   |  |                  |       | For water-/brine-to-air heat pumps: Rated brine or water flow rate, outdoor side heat exchanger   |   | -     | m³/h                              |    |
|   |  |                  |       | Emissions of nitrogen oxides (if applicable)  | NO <sub>x</sub> ***   |       | mg/kWh fuel input GCV             |    |
|   |  |                  |       | GWP of the refrigerant  |   | 2088  | kg CO <sub>2</sub> eq (100 years) |    |
| Contact details   | Panasonic Testing Centre, Panasonic Marketing Europe GmbH Winsbergweg 15, 22525 Hamburg, Germany |                  |       |   |   |       |                                   |    |

\*\* If C<sub>dh</sub> is not determined by measurement then the default degradation coefficient of heat pumps shall be 0.25.  
 \*\*\* from 26 September 2018.  
 Where information relates to multi-split heat pumps, the test result and performance data may be obtained on the basis of the performance of the outdoor unit, with a combination of indoor unit(s) recommended by the manufacturer or importer.

## Information requirements for air-to-air air conditioners

|  |                             |                           |    |
|--|-----------------------------|---------------------------|----|
| Model(s):  | Outdoor Unit<br>Indoor Unit | U-125PE1E5A<br>S-45PY2E5A | X3 |
| Outdoor side heat exchanger of air conditioner:  | air                         |                           |    |
| Indoor side heat exchanger of air conditioner:   | air                         |                           |    |
| Type: compressor driven vapour compression or sorption process   | vapour compression          |                           |    |
| if applicable: driver of compressor: (electric motor or fuel driven, gaseous or liquid fuel, internal or external combustion engine) | electric motor              |                           |    |

## Information requirements for heat pumps

|  |                             |                           |    |
|--|-----------------------------|---------------------------|----|
| Model(s):  | Outdoor Unit<br>Indoor Unit | U-125PE1E5A<br>S-45PY2E5A | X3 |
| Outdoor side heat exchanger of heat pump:  | air                         |                           |    |
| Indoor side heat exchanger of heat pump:   | air                         |                           |    |
| Indication if the heater is equipped with a supplementary heater:  | no                          |                           |    |
| if applicable: driver of compressor: (electric motor or fuel driven, gaseous or liquid fuel, internal or external combustion engine) | electric motor              |                           |    |
| Parameters shall be declared for the average heating season, parameters for the warmer and colder heating seasons are optional.      |                             |                           |    |

| Item   | Symbol  | Value    | Unit | Item  | Symbol  | Value | Unit                              |
|--|---|----------|------|---|---|-------|-----------------------------------|
| Rated cooling capacity   | $P_{rated,c}$   | 12.5     | kW   | Seasonal space cooling energy efficiency  | $\eta_{se}$   | 212.6 | %                                 |
| Refrigeration load   | $P_{design,c}$  | 12.5     | kW   | Declared energy efficiency ratio or gas utilization efficiency / auxiliary energy factor for part load at given outdoor temperatures $T_j$ and indoor 27°/19°C (dry/wet bulb) |   |       |                                   |
| Declared cooling capacity for part load at given outdoor temperatures $T_j$ and indoor 27°/19°C (dry/wet bulb) | $T_j = +35\text{ °C}$   | 12.5     | kW   | $T_j = +35\text{ °C}$   | EER <sub>d</sub> or<br>GUE <sub>c,bin</sub> /<br>AEF <sub>c,bin</sub> | 3.2   | %                                 |
|  | $T_j = +30\text{ °C}$   | 9.2      | kW   | $T_j = +30\text{ °C}$   |   | 4.4   | %                                 |
|  | $T_j = +25\text{ °C}$   | 5.9      | kW   | $T_j = +25\text{ °C}$   |   | 6.6   | %                                 |
|  | $T_j = +20\text{ °C}$   | 4.8      | kW   | $T_j = +20\text{ °C}$   |   | 8.9   | %                                 |
| Degradation co-efficient for air conditioners**  | $C_{de}$  | 0.25     | -    |   |   |       |                                   |
| Power consumption in modes other than 'active mode'  |   |          |      |   |   |       |                                   |
| Off mode   | $P_{off}$   | 0.033    | kW   | Crankcase heater mode   | $P_{ck}$  | 0.000 | kW                                |
| Thermostat-off mode  | $P_{to}$  | 0.068    | kW   | Standby mode  | $P_{sa}$  | 0.033 | kW                                |
| Other items  |   |          |      |   |   |       |                                   |
| Capacity control   |   | variable |      | For air-to-air air conditioner: air flow rate, outdoor  |   | 7800  | m <sup>3</sup> /h                 |
| Sound power level, outdoor   | $L_{WA}$  | 70.0     | dB   |   |   |       |                                   |
| Sound power level, indoor  | $L_{WA}$  | 53.0     | dB   | if engine driven: Emissions of nitrogen oxides  | NO <sub>x</sub> ***   | -     | mg/kWh fuel input GCV             |
|  |   |          |      | GWP of the refrigerant  |   | 2088  | kg CO <sub>2</sub> eq (100 years) |
| Contact details  | Panasonic Testing Centre, Panasonic Marketing Europe GmbH Winsbergstr. 15, 22525 Hamburg, Germany |          |      |   |   |       |                                   |

\*\* If  $C_{de}$  is not determined by measurement then the default degradation coefficient air conditioners shall be 0.25.  
\*\*\* from 26 September 2018.

Where information relates to multi-split air conditioners, the test result and performance data may be obtained on the basis of the performance of the outdoor unit, with a combination of indoor unit(s) recommended by the manufacturer or importer.

| Item  | Symbol  | Value    | Unit | Item  | Symbol  | Value | Unit                              |
|---|---|----------|------|---|---|-------|-----------------------------------|
| Rated heating capacity  | $P_{rated,h}$   | 14.0     | kW   | Seasonal space heating energy efficiency  | $\eta_{h,h}$  | 141.5 | %                                 |
| Refrigeration load  | $P_{design,h}$  | 12.5     | kW   | Declared coefficient of performance or gas utilization efficiency / auxiliary energy factor for part load at given outdoor temperatures $T_j$ |   |       |                                   |
| Declared heating capacity for part load at indoor temperature 20 °C and outdoor temperature $T_j$ | $T_j = -7\text{ °C}$  | 11.0     | kW   | $T_j = -7\text{ °C}$  | COP <sub>d</sub> or<br>GUE <sub>h,bin</sub> /<br>AEF <sub>h,bin</sub> | 2.3   | %                                 |
|   | $T_j = +2\text{ °C}$  | 6.7      | kW   | $T_j = +2\text{ °C}$  |   | 3.5   | %                                 |
|   | $T_j = +7\text{ °C}$  | 4.3      | kW   | $T_j = +7\text{ °C}$  |   | 4.9   | %                                 |
|   | $T_j = +12\text{ °C}$   | 4.1      | kW   | $T_j = +12\text{ °C}$   |   | 5.7   | %                                 |
| $T_{sw} =$ bivalent temperature   | $P_{th}$  | 12.0     | kW   | $T_{sw} =$ bivalent temperature   |   | 2.1   | %                                 |
| $T_{ol} =$ operation limit  |   | 9.5      | kW   | $T_{ol} =$ operation limit  |   | 1.6   | %                                 |
| For air-to-water heat pumps:<br>$T_j = -15\text{ °C}$ (if $T_{ol} < -20\text{ °C}$ )              |   | -        | kW   | For water-to-air heat pumps:<br>$T_j = -15\text{ °C}$ (if $T_{ol} < -20\text{ °C}$ )  |   | -     | %                                 |
| Bivalent temperature  | $T_{bw}$  | -9       | °C   | For water-to-air heat pumps:<br>Operation limit temperature   | $T_{ol}$  | -20   | °C                                |
| Degradation co-efficient heat pumps**   | $C_{th}$  | 0.25     | -    |   |   |       |                                   |
| Power consumption in modes other than 'active mode'   |   |          |      |   |   |       |                                   |
| Off mode  | $P_{off}$   | 0.033    | kW   | Supplementary heater  |   |       |                                   |
| Thermostat-off mode   | $P_{to}$  | 0.068    | kW   | Back-up heating capacity *  | elbu  | 0.8   | kW                                |
| Crankcase heater mode   | $P_{ck}$  | 0.000    | kW   | Type of energy input  |   |       |                                   |
| Other items   |   |          |      |   |   |       |                                   |
| Capacity control  |   | variable |      | For air-to-air heat pumps:<br>air flow rate, outdoor  |   | 6600  | m <sup>3</sup> /h                 |
| Sound power level, outdoor  | $L_{WA}$  | 70.0     | dB   | For water-/brine-to-air heat pumps: Rated brine or water flow rate, outdoor side heat exchanger   |   | -     | m <sup>3</sup> /h                 |
| Sound power level, indoor   | $L_{WA}$  | 53.0     | dB   | Emissions of nitrogen oxides (if applicable)  | NO <sub>x</sub> ***   | -     | mg/kWh fuel input GCV             |
|   |   |          |      | GWP of the refrigerant  |   | 2088  | kg CO <sub>2</sub> eq (100 years) |
| Contact details   | Panasonic Testing Centre, Panasonic Marketing Europe GmbH Winsbergstr. 15, 22525 Hamburg, Germany |          |      |   |   |       |                                   |

\*\* If  $C_{th}$  is not determined by measurement then the default degradation coefficient of heat pumps shall be 0.25.  
\*\*\* from 26 September 2018.

Where information relates to multi-split heat pumps, the test result and performance data may be obtained on the basis of the performance of the outdoor unit, with a combination of indoor unit(s) recommended by the manufacturer or importer.

## Information requirements for air-to-air air conditioners

|  |                             |                           |    |
|--|-----------------------------|---------------------------|----|
| Model(s):  | Outdoor Unit<br>Indoor Unit | U-140PE1E5A<br>S-50PY2E5A | X3 |
| Outdoor side heat exchanger of air conditioner:  | air                         |                           |    |
| Indoor side heat exchanger of air conditioner:   | air                         |                           |    |
| Type: compressor driven vapour compression or sorption process   | vapour compression          |                           |    |
| if applicable: driver of compressor: [electric motor or fuel driven, gaseous or liquid fuel, internal or external combustion engine] | electric motor              |                           |    |

## Information requirements for heat pumps

|  |                             |                           |    |
|--|-----------------------------|---------------------------|----|
| Model(s):  | Outdoor Unit<br>Indoor Unit | U-140PE1E5A<br>S-50PY2E5A | X3 |
| Outdoor side heat exchanger of heat pump:  | air                         |                           |    |
| Indoor side heat exchanger of heat pump:   | air                         |                           |    |
| Indication if the heater is equipped with a supplementary heater:  | no                          |                           |    |
| if applicable: driver of compressor: [electric motor or fuel driven, gaseous or liquid fuel, internal or external combustion engine] | electric motor              |                           |    |
| Parameters shall be declared for the average heating season, parameters for the warmer and colder heating seasons are optional.      |                             |                           |    |

| Item  | Symbol   | Value    | Unit | Item  | Symbol  | Value | Unit                              |
|---|--|----------|------|---|---|-------|-----------------------------------|
| Rated cooling capacity  | $P_{cool,c}$   | 14.0     | kW   | Seasonal space cooling energy efficiency  | $\eta_{L,c}$  | 203.1 | %                                 |
| Refrigeration load  | $P_{design,c}$   | 14.0     | kW   | Declared energy efficiency ratio or gas utilization efficiency / auxiliary energy factor for part load at given outdoor temperatures Tj |   |       |                                   |
| Declared cooling capacity for part load at given outdoor temperatures Tj and indoor 27°/19°C (dry/wet bulb) |  |          |      |   |   |       |                                   |
| Tj = +35 °C   |  | 14.0     | kW   | Tj = +35 °C   |   | 2.9   | %                                 |
| Tj = +30 °C   |  | 10.3     | kW   | Tj = +30 °C   | EER <sub>d</sub> or GUE <sub>s,bin</sub> / AEF <sub>s,bin</sub> | 4.1   | %                                 |
| Tj = +25 °C   | P <sub>dc</sub>  | 6.6      | kW   | Tj = +25 °C   |   | 6.3   | %                                 |
| Tj = +20 °C   |  | 4.9      | kW   | Tj = +20 °C   |   | 8.7   | %                                 |
| Degradation co-efficient for air conditioners**   | C <sub>dc</sub>  | 0.25     | -    |   |   |       |                                   |
| Power consumption in modes other than 'active mode'   |  |          |      |   |   |       |                                   |
| Off mode  | P <sub>off</sub>   | 0.033    | kW   | Crankcase heater mode   | P <sub>ck</sub>   | 0.000 | kW                                |
| Thermostat-off mode   | P <sub>to</sub>  | 0.076    | kW   | Standby mode  | P <sub>sb</sub>   | 0.033 | kW                                |
| Other items   |  |          |      |   |   |       |                                   |
| Capacity control  |  | variable |      | For air-to-air air conditioner: air flow rate, outdoor  |   | 8100  | m <sup>3</sup> /h                 |
| Sound power level, outdoor  | L <sub>WA</sub>  | 71.0     | dB   |   |   |       |                                   |
| Sound power level, indoor   | L <sub>WA</sub>  | 55.0     | dB   | if engine driven: Emissions of nitrogen oxides  | NO <sub>x</sub> ***   | -     | mg/kWh fuel input GCV             |
|   |  |          |      | GWP of the refrigerant  |   | 2088  | kg CO <sub>2</sub> eq (100 years) |
| Contact details   | Panasonic Testing Centre, Panasonic Marketing Europe GmbH Winsbergiring 15, 22525 Hamburg, Germany |          |      |   |   |       |                                   |

\*\* If C<sub>dc</sub> is not determined by measurement then the default degradation coefficient air conditioners shall be 0.25.

\*\*\* from 26 September 2018.

Where information relates to multi-split air conditioners, the test result and performance data may be obtained on the basis of the performance of the outdoor unit, with a combination of indoor unit(s) recommended by the manufacturer or importer.

| Item   | Symbol   | Value    | Unit | Item   | Symbol  | Value | Unit                              |
|--|--|----------|------|--|---|-------|-----------------------------------|
| Rated heating capacity   | $P_{heat,h}$   | 16.0     | kW   | Seasonal space heating energy efficiency   | $\eta_{L,h}$  | 139.2 | %                                 |
| Refrigeration load   | $P_{design,h}$   | 14.0     | kW   | Declared coefficient of performance or gas utilization efficiency / auxiliary energy factor for part load at given outdoor temperatures Tj |   |       |                                   |
| Declared heating capacity for part load at indoor temperature 20 °C and outdoor temperature Tj |  |          |      |  |   |       |                                   |
| Tj = -7 °C   |  | 12.3     | kW   | Tj = -7 °C   |   | 2.2   | %                                 |
| Tj = +2 °C   |  | 7.5      | kW   | Tj = +2 °C   |   | 3.5   | %                                 |
| Tj = +7 °C   |  | 4.8      | kW   | Tj = +7 °C   |   | 4.8   | %                                 |
| Tj = +12 °C  |  | 4.1      | kW   | Tj = +12 °C  |   | 5.6   | %                                 |
| T <sub>bw</sub> = bivalent temperature   | P <sub>dh</sub>  | 12.3     | kW   | T <sub>bw</sub> = bivalent temperature   | COP <sub>d</sub> or GUE <sub>h,bin</sub> / AEF <sub>h,bin</sub> | 2.2   | %                                 |
| T <sub>col</sub> = operation limit   |  | 9.6      | kW   | T <sub>col</sub> = operation limit   |   | 1.5   | %                                 |
| For air-to-water heat pumps:   |  |          |      | For water-to-air heat pumps:   |   |       |                                   |
| Tj = -15 °C (if T <sub>col</sub> < -20 °C)   |  | -        | kW   | Tj = -15 °C (if T <sub>col</sub> < -20 °C)   |   | -     | %                                 |
| Bivalent temperature   | T <sub>bw</sub>  | -7       | °C   | For water-to-air heat pumps: Operation limit temperature   | T <sub>ol</sub>   | -20   | °C                                |
| Degradation co-efficient heat pumps**  | C <sub>ah</sub>  | 0.25     | -    |  |   |       |                                   |
| Power consumption in modes other than 'active mode'  |  |          |      |  |   |       |                                   |
| Off mode   | P <sub>off</sub>   | 0.033    | kW   | Supplementary heater   |   |       |                                   |
| Thermostat-off mode  | P <sub>to</sub>  | 0.076    | kW   | back-up heating capacity*  | elbu  | 2.4   | kW                                |
| Crankcase heater mode  | P <sub>ck</sub>  | 0.000    | kW   | Standby mode   | P <sub>sb</sub>   | 0.033 | kW                                |
| Other items  |  |          |      |  |   |       |                                   |
| Capacity control   |  | variable |      | For air-to-air heat pumps: air flow rate, outdoor  |   | 7200  | m <sup>3</sup> /h                 |
| Sound power level, outdoor   | L <sub>WA</sub>  | 71.0     | dB   | For water-/brine-to-air heat pumps: Rated brine or water flow rate, outdoor side heat exchanger  |   | -     | m <sup>3</sup> /h                 |
| Sound power level, indoor  | L <sub>WA</sub>  | 55.0     | dB   | Emissions of nitrogen oxides (if applicable)   | NO <sub>x</sub> ***   | -     | mg/kWh fuel input GCV             |
|  |  |          |      | GWP of the refrigerant   |   | 2088  | kg CO <sub>2</sub> eq (100 years) |
| Contact details  | Panasonic Testing Centre, Panasonic Marketing Europe GmbH Winsbergiring 15, 22525 Hamburg, Germany |          |      |  |   |       |                                   |

\*\* If C<sub>ah</sub> is not determined by measurement then the default degradation coefficient of heat pumps shall be 0.25.

\*\*\* from 26 September 2018.

Where information relates to multi-split heat pumps, the test result and performance data may be obtained on the basis of the performance of the outdoor unit, with a combination of indoor unit(s) recommended by the manufacturer or importer.

## Information requirements for air-to-air air conditioners

|   |                             |                           |    |
|---|-----------------------------|---------------------------|----|
| Model(s):   | Outdoor Unit<br>Indoor Unit | U-125PE1E8A<br>S-36PY2E5A | X4 |
| Outdoor side heat exchanger of air conditioner:   | air                         |                           |    |
| Indoor side heat exchanger of air conditioner:  | air                         |                           |    |
| Type: compressor driven vapour compression or sorption process  | vapour compression          |                           |    |
| if applicable: driver of compressor: [electric motor or fuel driven,<br>gaseous or liquid fuel, internal or external combustion engine] | electric motor              |                           |    |

## Information requirements for heat pumps

|   |                             |                           |    |
|---|-----------------------------|---------------------------|----|
| Model(s):   | Outdoor Unit<br>Indoor Unit | U-125PE1E8A<br>S-36PY2E5A | X4 |
| Outdoor side heat exchanger of heat pump:   | air                         |                           |    |
| Indoor side heat exchanger of heat pump:  | air                         |                           |    |
| Indication if the heater is equipped with a supplementary heater:   | no                          |                           |    |
| if applicable: driver of compressor: [electric motor or fuel driven,<br>gaseous or liquid fuel, internal or external combustion engine] | electric motor              |                           |    |

Parameters shall be declared for the average heating season, parameters for the warmer and colder heating seasons are optional.

| Item   | Symbol   | Value    | Unit | Item  | Symbol  | Value | Unit                              |
|--|--|----------|------|---|---|-------|-----------------------------------|
| Rated cooling capacity   | $P_{rated,c}$  | 12.5     | kW   | Seasonal space cooling energy efficiency  | $\eta_{s,c}$  | 208.6 | %                                 |
| Refrigeration load   | $P_{design,c}$   | 12.5     | kW   | Declared energy efficiency ratio or gas utilization efficiency / auxiliary energy factor for part load at given outdoor temperatures $T_j$ and indoor 27°/19°C (dry/wet bulb) |   |       |                                   |
| Declared cooling capacity for part load at given outdoor temperatures $T_j$ and indoor 27°/19°C (dry/wet bulb) | $T_j = +35\text{ °C}$  | 12.5     | kW   | $T_j = +35\text{ °C}$   |   | 3.2   | %                                 |
|  | $T_j = +30\text{ °C}$  | 9.2      | kW   | $T_j = +30\text{ °C}$   | EER <sub>d</sub> or GUE <sub>s,bln</sub> / AEF <sub>s,bln</sub> | 4.4   | %                                 |
|  | $T_j = +25\text{ °C}$  | 5.9      | kW   | $T_j = +25\text{ °C}$   |   | 6.6   | %                                 |
|  | $T_j = +20\text{ °C}$  | 4.8      | kW   | $T_j = +20\text{ °C}$   |   | 8.9   | %                                 |
| Degradation co-efficient for air conditioners**  | $C_{dc}$   | 0.25     | -    | Declared heating capacity for part load at indoor temperature 20 °C and outdoor temperature $T_j$   |   |       |                                   |
| Declared heating capacity for part load at indoor temperature 20 °C and outdoor temperature $T_j$              | $T_j = -7\text{ °C}$   | 11.0     | kW   | $T_j = -7\text{ °C}$  |   | 2.3   | %                                 |
|  | $T_j = +2\text{ °C}$   | 6.7      | kW   | $T_j = +2\text{ °C}$  |   | 3.5   | %                                 |
|  | $T_j = +7\text{ °C}$   | 4.3      | kW   | $T_j = +7\text{ °C}$  |   | 4.9   | %                                 |
|  | $T_j = +12\text{ °C}$  | 4.1      | kW   | $T_j = +12\text{ °C}$   |   | 5.7   | %                                 |
| $T_{bw} = \text{bivalent temperature}$   | $P_{bh}$   | 12.0     | kW   | $T_{bw} = \text{bivalent temperature}$  | COP <sub>d</sub> or GUE <sub>s,bln</sub> / AEF <sub>s,bln</sub> | 2.1   | %                                 |
| $T_{ol} = \text{operation limit}$  |  | 9.5      | kW   | $T_{ol} = \text{operation limit}$   |   | 1.6   | %                                 |
| For air-to-water heat pumps:   |  | -        | kW   | For water-to-air heat pumps:  |   | -     | %                                 |
| $T_j = -15\text{ °C}$ (if $T_{ol} < -20\text{ °C}$ )   |  | -        | kW   | $T_j = -15\text{ °C}$ (if $T_{ol} < -20\text{ °C}$ )  |   | -     | %                                 |
| Bivalent temperature   | $T_{bw}$   | -9       | °C   | For water-to-air heat pumps:  | $T_{ol}$  | -20   | °C                                |
| Degradation co-efficient heat pumps**  | $C_{dh}$   | 0.25     | -    | Operation limit temperature   |   |       |                                   |
| Power consumption in modes other than 'active mode'  |  |          |      |   |   |       |                                   |
| Off mode   | $P_{off}$  | 0.043    | kW   | Supplementary heater  |   |       |                                   |
| Thermostat-off mode  | $P_{to}$   | 0.087    | kW   | back-up heating capacity *  | elbu  | 0.8   | kW                                |
|  |  |          |      | Type of energy input  |   |       |                                   |
|  |  |          |      | Standby mode  | $P_{sb}$  | 0.043 | kW                                |
| Other items  |  |          |      |   |   |       |                                   |
| Capacity control   |  | variable |      | For air-to-air heat pumps:  |   | 6600  | m³/h                              |
|  |  |          |      | air flow rate, outdoor  |   |       |                                   |
| Sound power level, outdoor   | $L_{WA}$   | 70.0     | dB   | For water-/brine-to-air heat pumps: Rated brine or water flow rate, outdoor side heat exchanger   |   | -     | m³/h                              |
| Sound power level, indoor  | $L_{WA}$   | 51.0     | dB   | Emissions of nitrogen oxides (if applicable)  | NO <sub>x</sub> ***   | -     | mg/KWh fuel input GCV             |
|  |  |          |      | GWP of the refrigerant  |   | 2088  | kg CO <sub>2</sub> eq (100 years) |
| Contact details  | Panasonic Testing Centre, Panasonic Marketing Europe GmbH Winsbergstr 15, 22525 Hamburg, Germany |          |      |   |   |       |                                   |

\*\* If  $C_{dc}$  is not determined by measurement then the default degradation coefficient air conditioners shall be 0.25.

\*\*\* from 26 September 2018.

Where information relates to multi-split air conditioners, the test result and performance data may be obtained on the basis of the performance of the outdoor unit, with a combination of indoor unit(s) recommended by the manufacturer or importer.

| Item  | Symbol   | Value    | Unit | Item  | Symbol  | Value | Unit                              |
|---|--|----------|------|---|---|-------|-----------------------------------|
| Rated heating capacity  | $P_{rated,h}$  | 14.0     | kW   | Seasonal space heating energy efficiency  | $\eta_{s,h}$  | 141.4 | %                                 |
| Refrigeration load  | $P_{design,h}$   | 12.5     | kW   | Declared coefficient of performance or gas utilization efficiency / auxiliary energy factor for part load at given outdoor temperatures $T_j$ |   |       |                                   |
| Declared heating capacity for part load at indoor temperature 20 °C and outdoor temperature $T_j$ | $T_j = -7\text{ °C}$   | 11.0     | kW   | $T_j = -7\text{ °C}$  |   | 2.3   | %                                 |
|   | $T_j = +2\text{ °C}$   | 6.7      | kW   | $T_j = +2\text{ °C}$  |   | 3.5   | %                                 |
|   | $T_j = +7\text{ °C}$   | 4.3      | kW   | $T_j = +7\text{ °C}$  |   | 4.9   | %                                 |
|   | $T_j = +12\text{ °C}$  | 4.1      | kW   | $T_j = +12\text{ °C}$   |   | 5.7   | %                                 |
| $T_{bw} = \text{bivalent temperature}$  | $P_{bh}$   | 12.0     | kW   | $T_{bw} = \text{bivalent temperature}$  | COP <sub>d</sub> or GUE <sub>s,bln</sub> / AEF <sub>s,bln</sub> | 2.1   | %                                 |
| $T_{ol} = \text{operation limit}$   |  | 9.5      | kW   | $T_{ol} = \text{operation limit}$   |   | 1.6   | %                                 |
| For water-to-air heat pumps:  |  | -        | kW   | For water-to-air heat pumps:  |   | -     | %                                 |
| $T_j = -15\text{ °C}$ (if $T_{ol} < -20\text{ °C}$ )  |  | -        | kW   | $T_j = -15\text{ °C}$ (if $T_{ol} < -20\text{ °C}$ )  |   | -     | %                                 |
| Bivalent temperature  | $T_{bw}$   | -9       | °C   | For water-to-air heat pumps:  | $T_{ol}$  | -20   | °C                                |
| Degradation co-efficient heat pumps**   | $C_{dh}$   | 0.25     | -    | Operation limit temperature   |   |       |                                   |
| Power consumption in modes other than 'active mode'   |  |          |      |   |   |       |                                   |
| Off mode  | $P_{off}$  | 0.043    | kW   | Supplementary heater  |   |       |                                   |
| Thermostat-off mode   | $P_{to}$   | 0.087    | kW   | back-up heating capacity *  | elbu  | 0.8   | kW                                |
|   |  |          |      | Type of energy input  |   |       |                                   |
|   |  |          |      | Standby mode  | $P_{sb}$  | 0.043 | kW                                |
| Other items   |  |          |      |   |   |       |                                   |
| Capacity control  |  | variable |      | For air-to-air heat pumps:  |   | 6600  | m³/h                              |
|   |  |          |      | air flow rate, outdoor  |   |       |                                   |
| Sound power level, outdoor  | $L_{WA}$   | 70.0     | dB   | For water-/brine-to-air heat pumps: Rated brine or water flow rate, outdoor side heat exchanger   |   | -     | m³/h                              |
| Sound power level, indoor   | $L_{WA}$   | 51.0     | dB   | Emissions of nitrogen oxides (if applicable)  | NO <sub>x</sub> ***   | -     | mg/KWh fuel input GCV             |
|   |  |          |      | GWP of the refrigerant  |   | 2088  | kg CO <sub>2</sub> eq (100 years) |
| Contact details   | Panasonic Testing Centre, Panasonic Marketing Europe GmbH Winsbergstr 15, 22525 Hamburg, Germany |          |      |   |   |       |                                   |

\*\* If  $C_{dh}$  is not determined by measurement then the default degradation coefficient of heat pumps shall be 0.25.

\*\*\* from 26 September 2018.

Where information relates to multi-split heat pumps, the test result and performance data may be obtained on the basis of the performance of the outdoor unit, with a combination of indoor unit(s) recommended by the manufacturer or importer.

## Information requirements for air-to-air air conditioners

|  |                             |                           |    |
|--|-----------------------------|---------------------------|----|
| Model(s):  | Outdoor Unit<br>Indoor Unit | U-125PETE8A<br>S-45PY2E5A | X3 |
| Outdoor side heat exchanger of air conditioner:  | air                         |                           |    |
| Indoor side heat exchanger of air conditioner:   | air                         |                           |    |
| Type: compressor driven vapour compression or sorption process   | vapour compression          |                           |    |
| if applicable: driver of compressor: [electric motor or fuel driven, gaseous or liquid fuel, internal or external combustion engine] | electric motor              |                           |    |

## Information requirements for heat pumps

|  |                             |                           |    |
|--|-----------------------------|---------------------------|----|
| Model(s):  | Outdoor Unit<br>Indoor Unit | U-125PETE8A<br>S-45PY2E5A | X3 |
| Outdoor side heat exchanger of heat pump:  | air                         |                           |    |
| Indoor side heat exchanger of heat pump:   | air                         |                           |    |
| Indication if the heater is equipped with a supplementary heater:  | no                          |                           |    |
| if applicable: driver of compressor: [electric motor or fuel driven, gaseous or liquid fuel, internal or external combustion engine] | electric motor              |                           |    |
| Parameters shall be declared for the average heating season, parameters for the warmer and colder heating seasons are optional.      |                             |                           |    |

| Item  | Symbol  | Value    | Unit | Item   | Symbol  | Value | Unit                              |
|---|---|----------|------|--|---|-------|-----------------------------------|
| Rated cooling capacity  | $P_{rated,c}$   | 12.5     | kW   | Seasonal space cooling energy efficiency   | $\eta_{s,c}$  | 211.9 | %                                 |
| Refrigeration load  | $P_{design,c}$  | 12.5     | kW   | Declared energy efficiency ratio or gas utilization efficiency / auxiliary energy factor for part load at given outdoor temperatures T <sub>J</sub> and indoor 27°/19°C (dry/wet bulb) |   |       |                                   |
| Declared cooling capacity for part load at given outdoor temperatures T <sub>J</sub> and indoor 27°/19°C (dry/wet bulb) | T <sub>J</sub> = + 35 °C  | 12.5     | kW   | T <sub>J</sub> = + 35 °C   |   | 3.2   | %                                 |
|   | T <sub>J</sub> = + 30 °C  | 9.2      | kW   | T <sub>J</sub> = + 30 °C   | EER <sub>d</sub> or GUE <sub>s,brn</sub> / AEF <sub>s,brn</sub> | 4.4   | %                                 |
|   | T <sub>J</sub> = + 25 °C  | 5.9      | kW   | T <sub>J</sub> = + 25 °C   |   | 6.6   | %                                 |
|   | T <sub>J</sub> = + 20 °C  | 4.8      | kW   | T <sub>J</sub> = + 20 °C   |   | 8.9   | %                                 |
| Degradation co-efficient for air conditioners**   | $C_{dc}$  | 0.25     | -    | Power consumption in modes other than 'active mode'  |   |       |                                   |
| Off mode  | $P_{off}$   | 0.036    | kW   | Crankcase heater mode  | $P_{ck}$  | 0.000 | kW                                |
|   | $P_{to}$  | 0.068    | kW   | Standby mode   | $P_{sb}$  | 0.036 | kW                                |
|   | Other items   |          |      |  |   |       |                                   |
| Capacity control  |   | variable |      | For air-to-air air conditioner: air flow rate, outdoor   |   | 7800  | m <sup>3</sup> /h                 |
| Sound power level, outdoor  | $L_{WA}$  | 70.0     | dB   |  |   |       |                                   |
| Sound power level, indoor   | $L_{WA}$  | 53.0     | dB   | If engine driven: Emissions of nitrogen oxides   | NO <sub>x</sub> ***   | -     | mg/kWh fuel input GCV             |
|   |   |          |      | GWP of the refrigerant   |   | 2088  | kg CO <sub>2</sub> eq (100 years) |
| Contact details   | Panasonic Testing Centre, Panasonic Marketing Europe GmbH Winsbergstr. 15, 22525 Hamburg, Germany |          |      |  |   |       |                                   |

\*\* If  $C_{dc}$  is not determined by measurement then the default degradation coefficient air conditioners shall be 0.25.

\*\*\* from 26 September 2018.

Where information relates to multi-split air conditioners, the test result and performance data may be obtained on the basis of the performance of the outdoor unit, with a combination of indoor unit(s) recommended by the manufacturer or importer.

| Item   | Symbol  | Value    | Unit | Item   | Symbol  | Value | Unit                              |
|--|---|----------|------|--|---|-------|-----------------------------------|
| Rated heating capacity   | $P_{rated,h}$   | 14.0     | kW   | Seasonal space heating energy efficiency   | $\eta_{s,h}$  | 141.5 | %                                 |
| Refrigeration load   | $P_{design,h}$  | 12.5     | kW   | Declared coefficient of performance or gas utilization efficiency / auxiliary energy factor for part load at given outdoor temperatures T <sub>J</sub> |   |       |                                   |
| Declared heating capacity for part load at indoor temperature 20 °C and outdoor temperature T <sub>J</sub> | T <sub>J</sub> = - 7 °C   | 11.0     | kW   | T <sub>J</sub> = - 7 °C  |   | 2.3   | %                                 |
|  | T <sub>J</sub> = + 2 °C   | 6.7      | kW   | T <sub>J</sub> = + 2 °C  |   | 3.5   | %                                 |
|  | T <sub>J</sub> = + 7 °C   | 4.3      | kW   | T <sub>J</sub> = + 7 °C  |   | 4.9   | %                                 |
|  | T <sub>J</sub> = + 12 °C  | 4.1      | kW   | T <sub>J</sub> = + 12 °C   |   | 5.7   | %                                 |
| $T_{bw}$ = bivalent temperature  | $P_{dh}$  | 12.0     | kW   | $T_{bw}$ = bivalent temperature  | COP <sub>d</sub> or GUE <sub>s,brn</sub> / AEF <sub>s,brn</sub> | 2.1   | %                                 |
| $T_{ol}$ = operation limit   |   | 9.5      | kW   | $T_{ol}$ = operation limit   |   | 1.6   | %                                 |
| For air-to-water heat pumps: T <sub>J</sub> = - 15 °C (if T <sub>col</sub> < - 20 °C)                      |   | -        | kW   | For water-to-air heat pumps: T <sub>J</sub> = - 15 °C (if T <sub>col</sub> < - 20 °C)  |   | -     | %                                 |
| Bivalent temperature   | $T_{bw}$  | -9       | °C   | For water-to-air heat pumps: Operation limit temperature   | $T_{ol}$  | -20   | °C                                |
| Degradation co-efficient heat pumps**  | $C_{dh}$  | 0.25     | -    | Supplementary heater   |   |       |                                   |
| Power consumption in modes other than 'active mode'  |   |          |      |  |   |       |                                   |
| Off mode   | $P_{off}$   | 0.036    | kW   | back-up heating capacity*  | elbu  | 0.8   | kW                                |
| Thermostat-off mode  | $P_{to}$  | 0.068    | kW   | Type of energy input   |   |       |                                   |
| Crankcase heater mode  | $P_{ck}$  | 0.000    | kW   | Standby mode   | $P_{sb}$  | 0.036 | kW                                |
| Other items  |   |          |      |  |   |       |                                   |
| Capacity control   |   | variable |      | For air-to-air heat pumps: air flow rate, outdoor  |   | 6600  | m <sup>3</sup> /h                 |
| Sound power level, outdoor   | $L_{WA}$  | 70.0     | dB   | For water-/brine-to-air heat pumps: Rated brine or water flow rate, outdoor side heat exchanger  |   | -     | m <sup>3</sup> /h                 |
| Sound power level, indoor  | $L_{WA}$  | 53.0     | dB   | Emissions of nitrogen oxides (if applicable)   | NO <sub>x</sub> ***   | -     | mg/kWh fuel input GCV             |
|  |   |          |      | GWP of the refrigerant   |   | 2088  | kg CO <sub>2</sub> eq (100 years) |
| Contact details  | Panasonic Testing Centre, Panasonic Marketing Europe GmbH Winsbergstr. 15, 22525 Hamburg, Germany |          |      |  |   |       |                                   |

\*\* If  $C_{dh}$  is not determined by measurement then the default degradation coefficient of heat pumps shall be 0.25.

\*\*\* from 26 September 2018.

Where information relates to multi-split heat pumps, the test result and performance data may be obtained on the basis of the performance of the outdoor unit, with a combination of indoor unit(s) recommended by the manufacturer or importer.

### Information requirements for air-to-air air conditioners

|  |                             |                           |    |
|--|-----------------------------|---------------------------|----|
| Model(s):  | Outdoor Unit<br>Indoor Unit | U-140PE1E8A<br>S-50PY2E5A | X3 |
| Outdoor side heat exchanger of air conditioner:  | air                         |                           |    |
| Indoor side heat exchanger of air conditioner:   | air                         |                           |    |
| Type: compressor driven vapour compression or sorption process   | vapour compression          |                           |    |
| if applicable: driver of compressor: [electric motor or fuel driven, gaseous or liquid fuel, internal or external combustion engine] | electric motor              |                           |    |

### Information requirements for heat pumps

|  |                             |                           |    |
|--|-----------------------------|---------------------------|----|
| Model(s):  | Outdoor Unit<br>Indoor Unit | U-140PE1E8A<br>S-50PY2E5A | X3 |
| Outdoor side heat exchanger of heat pump:  | air                         |                           |    |
| Indoor side heat exchanger of heat pump:   | air                         |                           |    |
| Indication if the heater is equipped with a supplementary heater:  | no                          |                           |    |
| if applicable: driver of compressor: [electric motor or fuel driven, gaseous or liquid fuel, internal or external combustion engine] | electric motor              |                           |    |
| Parameters shall be declared for the average heating season, parameters for the warmer and colder heating seasons are optional.      |                             |                           |    |

| Item  | Symbol   | Value    | Unit | Item   | Symbol  | Value               | Unit                              |
|---|--|----------|------|--|---|---------------------|-----------------------------------|
| Rated cooling capacity  | $P_{rated,c}$  | 14.0     | kW   | Seasonal space cooling energy efficiency   | $\eta_{s,c}$  | 202.7               | %                                 |
| Refrigeration load  | $P_{design,c}$   | 14.0     | kW   | Declared energy efficiency ratio or gas utilization efficiency / auxiliary energy factor for part load at given outdoor temperatures T <sub>j</sub> and indoor 27°/19°C (dry/wet bulb) |   |                     |                                   |
| Declared cooling capacity for part load at given outdoor temperatures T <sub>j</sub> and indoor 27°/19°C (dry/wet bulb) | T <sub>j</sub> = + 35 °C   | 14.0     | kW   | T <sub>j</sub> = + 35 °C   | EER <sub>s</sub> or GUE <sub>s,brn</sub> / AEF <sub>s,brn</sub> | 2.9                 | %                                 |
|   | T <sub>j</sub> = + 30 °C   | 10.3     | kW   | T <sub>j</sub> = + 30 °C   |   | 4.1                 | %                                 |
|   | T <sub>j</sub> = + 25 °C   | 6.6      | kW   | T <sub>j</sub> = + 25 °C   |   | 6.3                 | %                                 |
|   | T <sub>j</sub> = + 20 °C   | 4.8      | kW   | T <sub>j</sub> = + 20 °C   |   | 8.7                 | %                                 |
| Degradation co-efficient for air conditioners**   | $C_{dc}$   | 0.25     | -    |  |   |                     |                                   |
| Power consumption in modes other than 'active mode'   |  |          |      |  |   |                     |                                   |
| Off mode  | $P_{off}$  | 0.036    | kW   | Crankcase heater mode  | $P_{ck}$  | 0.000               | kW                                |
| Thermostat-off mode   | $P_{to}$   | 0.076    | kW   | Standby mode   | $P_{sb}$  | 0.036               | kW                                |
| Other items   |  |          |      |  |   |                     |                                   |
| Capacity control  |  | variable |      | For air-to-air air conditioner: air flow rate, outdoor   |   | 8100                | m³/h                              |
| Sound power level, outdoor  | $L_{WA}$   | 71.0     | dB   |  |   |                     |                                   |
| Sound power level, indoor   | $L_{WA}$   | 55.0     | dB   | if engine driven: Emissions of nitrogen oxides   |   | NO <sub>x</sub> *** | mg/KWh fuel input GCV             |
|   |  |          |      | GWP of the refrigerant   |   |                     | kg CO <sub>2</sub> eq (100 years) |
| Contact details   | Panasonic Testing Centre, Panasonic Marketing Europe GmbH Wfnsberggring 15, 22525 Hamburg, Germany |          |      |  |   |                     |                                   |

\*\* If  $C_{dc}$  is not determined by measurement then the default degradation coefficient air conditioners shall be 0.25.  
 \*\*\* from 26 September 2018.  
 Where information relates to multi-split air conditioners, the test result and performance data may be obtained on the basis of the performance of the outdoor unit, with a combination of indoor unit(s) recommended by the manufacturer or importer.

| Item   | Symbol   | Value    | Unit | Item   | Symbol  | Value               | Unit                              |
|--|--|----------|------|--|---|---------------------|-----------------------------------|
| Rated heating capacity   | $P_{rated,h}$  | 16.0     | kW   | Seasonal space heating energy efficiency   | $\eta_{s,h}$  | 139.2               | %                                 |
| Refrigeration load   | $P_{design,h}$   | 14.0     | kW   | Declared coefficient of performance or gas utilization efficiency / auxiliary energy factor for part load at given outdoor temperatures T <sub>j</sub> |   |                     |                                   |
| Declared heating capacity for part load at indoor temperature 20 °C and outdoor temperature T <sub>j</sub> | T <sub>j</sub> = - 7 °C  | 12.3     | kW   | T <sub>j</sub> = - 7 °C  | COP <sub>s</sub> or GUE <sub>s,brn</sub> / AEF <sub>s,brn</sub> | 2.2                 | %                                 |
|  | T <sub>j</sub> = + 2 °C  | 7.5      | kW   | T <sub>j</sub> = + 2 °C  |   | 3.5                 | %                                 |
|  | T <sub>j</sub> = + 7 °C  | 4.8      | kW   | T <sub>j</sub> = + 7 °C  |   | 4.8                 | %                                 |
|  | T <sub>j</sub> = + 12 °C   | 4.1      | kW   | T <sub>j</sub> = + 12 °C   |   | 5.6                 | %                                 |
| $T_{bw}$ = bivalent temperature  | $P_{bh}$   | 12.3     | kW   | $T_{bw}$ = bivalent temperature  |   | 2.2                 | %                                 |
| $T_{oh}$ = operation limit   |  | 9.6      | kW   | $T_{oh}$ = operation limit   |   | 1.5                 | %                                 |
| For air-to-water heat pumps: T <sub>j</sub> = - 15 °C (if T <sub>oh</sub> < - 20 °C)                       |  | -        | kW   | For water-to-air heat pumps: T <sub>j</sub> = - 15 °C (if T <sub>oh</sub> < - 20 °C)   |   | -                   | %                                 |
| Bivalent temperature   | $T_{bw}$   | -7       | °C   | For water-to-air heat pumps: Operation limit temperature   | $T_{oh}$  | -20                 | °C                                |
| Degradation co-efficient heat pumps**  | $C_{dh}$   | 0.25     | -    |  |   |                     |                                   |
| Power consumption in modes other than 'active mode'  |  |          |      |  |   |                     |                                   |
| Off mode   | $P_{off}$  | 0.036    | kW   | Supplementary heater   |   |                     |                                   |
| Thermostat-off mode  | $P_{to}$   | 0.076    | kW   | back-up heating capacity *   | elbu  | 2.4                 | kW                                |
| Crankcase heater mode  | $P_{ck}$   | 0.000    | kW   | Type of energy input   |   |                     |                                   |
| Other items  |  |          |      |  |   |                     |                                   |
| Capacity control   |  | variable |      | For air-to-air heat pumps: air flow rate, outdoor  |   | 7200                | m³/h                              |
| Sound power level, outdoor   | $L_{WA}$   | 71.0     | dB   | For water-/brine-to-air heat pumps: Rated brine or water flow rate, outdoor side heat exchanger  |   | -                   | m³/h                              |
| Sound power level, indoor  | $L_{WA}$   | 55.0     | dB   | Emissions of nitrogen oxides (if applicable)   |   | NO <sub>x</sub> *** | mg/KWh fuel input GCV             |
|  |  |          |      | GWP of the refrigerant   |   |                     | kg CO <sub>2</sub> eq (100 years) |
| Contact details  | Panasonic Testing Centre, Panasonic Marketing Europe GmbH Wfnsberggring 15, 22525 Hamburg, Germany |          |      |  |   |                     |                                   |

\*\* If  $C_{dh}$  is not determined by measurement then the default degradation coefficient of heat pumps shall be 0.25.  
 \*\*\* from 26 September 2018.  
 Where information relates to multi-split heat pumps, the test result and performance data may be obtained on the basis of the performance of the outdoor unit, with a combination of indoor unit(s) recommended by the manufacturer or importer.









Information requirements for air-to-air air conditioners

Model(s): U-140PEY1E8 X2  
S-71PU2E5A

Outdoor Unit  
Indoor Unit

Outdoor side heat exchanger of air conditioner:  
Indoor side heat exchanger of air conditioner:  
Type: compressor driven vapour compression or sorption process  
if applicable: driver of compressor: [electric motor or fuel driven,  
gaseous or liquid fuel, internal or external combustion engine]

electric motor

| Item   | Symbol   | Value    | Unit | Item   | Symbol       | Value | Unit                              |
|--|--|----------|------|--|--------------|-------|-----------------------------------|
| Rated cooling capacity   | $P_{rated,c}$  | 14.0     | kW   | Seasonal space cooling energy efficiency               | $\eta_{s,c}$ | 255.5 | %                                 |
| Refrigeration load   | $P_{design,c}$   | 14.0     | kW   |  |              |       |                                   |
| Declared cooling capacity for part load at given outdoor temperatures $T_j$ and indoor 27°/19°C (dry/wet bulb)                             |  |          |      |  |              |       |                                   |
|  |  |          |      | $T_j = +35\text{ °C}$                                  |              | 14.0  | kW                                |
|  |  |          |      | $T_j = +30\text{ °C}$                                  |              | 10.3  | kW                                |
|  |  |          |      | $T_j = +25\text{ °C}$                                  |              | 6.6   | kW                                |
|  |  |          |      | $T_j = +20\text{ °C}$                                  |              | 5.5   | kW                                |
| Degradation co-efficient for air conditioners**  | $C_{cc}$   | 0.25     | -    |  |              |       |                                   |
| Declared energy efficiency ratio or gas utilization efficiency / auxiliary energy factor for part load at given outdoor temperatures $T_j$ |  |          |      |  |              |       |                                   |
|  |  |          |      | $T_j = +35\text{ °C}$                                  |              | 3.2   | %                                 |
|  |  |          |      | $T_j = +30\text{ °C}$                                  |              | 4.8   | %                                 |
|  |  |          |      | $T_j = +25\text{ °C}$                                  |              | 7.6   | %                                 |
|  |  |          |      | $T_j = +20\text{ °C}$                                  |              | 11.5  | %                                 |
| Power consumption in modes other than 'active mode'  |  |          |      |  |              |       |                                   |
| Off mode   | $P_{off}$  | 0.015    | kW   | Crankcase heater mode                                  | $P_{ck}$     | 0.000 | kW                                |
| Thermostat-off mode  | $P_{to}$   | 0.000    | kW   | Standby mode   | $P_{sb}$     | 0.015 | kW                                |
| Other items  |  |          |      |  |              |       |                                   |
| Capacity control   |  | variable |      | For air-to-air air conditioner: air flow rate, outdoor |              | 8100  | m³/h                              |
| Sound power level, outdoor   | $L_{WA}$   | 71.0     | dB   |  |              |       |                                   |
| Sound power level, indoor  | $L_{WA}$   | 52.0     | dB   | if engine driven: Emissions of nitrogen oxides         | $NO_x^{***}$ | -     | mg/KWh fuel input GCV             |
|  |  |          |      | GWP of the refrigerant                                 |              | 2088  | kg CO <sub>2</sub> eq (100 years) |
| Contact details  | Panasonic Testing Centre, Panasonic Marketing Europe GmbH Winsbergiring 15, 22525 Hamburg, Germany |          |      |  |              |       |                                   |

\*\* If  $C_{cc}$  is not determined by measurement then the default degradation coefficient air conditioners shall be 0.25.  
\*\*\* from 26 September 2018.  
Where information relates to multi-split air conditioners, the test result and performance data may be obtained on the basis of the performance of the outdoor unit, with a combination of indoor unit(s) recommended by the manufacturer or importer.

Information requirements for heat pumps

Model(s): U-140PEY1E8 X2  
S-71PU2E5A

Outdoor Unit  
Indoor Unit

Outdoor side heat exchanger of heat pump:  
Indoor side heat exchanger of heat pump:  
Indication if the heater is equipped with a supplementary heater:  
if applicable: driver of compressor: [electric motor or fuel driven,  
gaseous or liquid fuel, internal or external combustion engine]

electric motor

| Item  | Symbol   | Value    | Unit | Item  | Symbol       | Value | Unit                              |
|---|--|----------|------|---|--------------|-------|-----------------------------------|
| Rated heating capacity  | $P_{rated,h}$  | 14.0     | kW   | Seasonal space heating energy efficiency  | $\eta_{s,h}$ | 148.5 | %                                 |
| Refrigeration load  | $P_{design,h}$   | 14.0     | kW   |   |              |       |                                   |
| Declared heating capacity for part load at indoor temperature 20 °C and outdoor temperature $T_j$ |  |          |      |   |              |       |                                   |
|   |  |          |      | $T_j = -7\text{ °C}$  |              | 12.3  | kW                                |
|   |  |          |      | $T_j = +2\text{ °C}$  |              | 7.5   | kW                                |
|   |  |          |      | $T_j = +7\text{ °C}$  |              | 4.8   | kW                                |
|   |  |          |      | $T_j = +12\text{ °C}$   |              | 4.5   | kW                                |
| $T_{hw}$ = bivalent temperature   | $P_{bh}$   | 12.3     | kW   | $T_{hw}$ = bivalent temperature   |              |       |                                   |
| $T_{col}$ = operation limit   |  | 9.3      | kW   | $T_{col}$ = operation limit   |              |       |                                   |
| For air-to-water heat pumps:<br>$T_j = -15\text{ °C}$ (if $T_{col} < -20\text{ °C}$ )             |  | -        | kW   | For water-to-air heat pumps:<br>$T_j = -15\text{ °C}$ (if $T_{col} < -20\text{ °C}$ )           |              |       |                                   |
| Bivalent temperature  | $T_{bw}$   | -7       | °C   | For water-to-air heat pumps:<br>Operation limit temperature                                     | $T_{ol}$     | -15   | °C                                |
| Degradation co-efficient heat pumps**   | $C_{ch}$   | 0.25     | -    |   |              |       |                                   |
| Power consumption in modes other than 'active mode'   |  |          |      |   |              |       |                                   |
| Off mode  | $P_{off}$  | 0.015    | kW   | Supplementary heater back-up heating capacity*  | elbu         | 2.9   | kW                                |
| Thermostat-off mode   | $P_{to}$   | 0.000    | kW   | Type of energy input  |              |       |                                   |
| Crankcase heater mode   | $P_{ck}$   | 0.000    | kW   | Standby mode  | $P_{sb}$     | 0.015 | kW                                |
| Other items   |  |          |      |   |              |       |                                   |
| Capacity control  |  | variable |      | For air-to-air heat pumps: air flow rate, outdoor   |              | 7200  | m³/h                              |
| Sound power level, outdoor  | $L_{WA}$   | 70.0     | dB   | For water-/brine-to-air heat pumps: Rated brine or water flow rate, outdoor side heat exchanger |              | -     | m³/h                              |
| Sound power level, indoor   | $L_{WA}$   | 52.0     | dB   | Emissions of nitrogen oxides (if applicable)  | $NO_x^{***}$ | -     | mg/KWh fuel input GCV             |
|   |  |          |      | GWP of the refrigerant  |              | 2088  | kg CO <sub>2</sub> eq (100 years) |
| Contact details   | Panasonic Testing Centre, Panasonic Marketing Europe GmbH Winsbergiring 15, 22525 Hamburg, Germany |          |      |   |              |       |                                   |

\*\* If  $C_{ch}$  is not determined by measurement then the default degradation coefficient of heat pumps shall be 0.25.  
\*\*\* from 26 September 2018.  
Where information relates to multi-split heat pumps, the test result and performance data may be obtained on the basis of the performance of the outdoor unit, with a combination of indoor unit(s) recommended by the manufacturer or importer.

## Information requirements for air-to-air air conditioners

|  |                |                             |      |   |              |
|--|----------------|-----------------------------|------|---|--------------|
| Model(s):  |                | Outdoor Unit<br>Indoor Unit |      | U-125PEY1E8<br>S-125PUZE5A  |              |
| Rated cooling capacity   | Symbol         | Value                       | Unit | Item  | Value        |
|  | $P_{rated,c}$  | 12.5                        | kW   | Seasonal space cooling energy efficiency  | $\eta_{s,c}$ |
| Refrigeration load   | Symbol         | Value                       | Unit | Item  | Value        |
|  | $P_{design,c}$ | 12.5                        | kW   | Declared energy efficiency ratio or gas utilization efficiency / auxiliary energy factor for part load at given outdoor temperatures Tj |              |
| Declared cooling capacity for part load at given outdoor temperatures Tj and indoor 27/19°C (dry/wet bulb)   |                |                             |      |   |              |
|  |                | 12.5                        | kW   | Tj = +35 °C   | 3.1          |
|  |                | 9.2                         | kW   | Tj = +30 °C   | 4.8          |
|  |                | 5.9                         | kW   | Tj = +25 °C   | 7.5          |
|  |                | 5.1                         | kW   | Tj = +20 °C   | 10.6         |
| Degradation co-efficient for air conditioners**  | C <sub>d</sub> | 0.25                        | -    |   |              |
| Type: compressor driven vapour compression or sorption process<br>if applicable: driver of compressor: (electric motor or fuel driven, gaseous or liquid fuel, internal or external combustion engine)<br>electric motor |                |                             |      |   |              |

| Item   | Symbol   | Value    | Unit | Item  | Value               | Unit                              |
|--|--|----------|------|---|---------------------|-----------------------------------|
| Rated cooling capacity   | $P_{rated,c}$  | 12.5     | kW   | Seasonal space cooling energy efficiency  | $\eta_{s,c}$        | %                                 |
| Refrigeration load   | $P_{design,c}$   | 12.5     | kW   | Declared energy efficiency ratio or gas utilization efficiency / auxiliary energy factor for part load at given outdoor temperatures Tj |                     |                                   |
| Declared cooling capacity for part load at given outdoor temperatures Tj and indoor 27/19°C (dry/wet bulb)   |  |          |      |   |                     |                                   |
|  |  | 12.5     | kW   | Tj = +35 °C   | 3.1                 | %                                 |
|  |  | 9.2      | kW   | Tj = +30 °C   | 4.8                 | %                                 |
|  |  | 5.9      | kW   | Tj = +25 °C   | 7.5                 | %                                 |
|  |  | 5.1      | kW   | Tj = +20 °C   | 10.6                | %                                 |
| Degradation co-efficient for air conditioners**  | C <sub>d</sub>   | 0.25     | -    |   |                     |                                   |
| Type: compressor driven vapour compression or sorption process<br>if applicable: driver of compressor: (electric motor or fuel driven, gaseous or liquid fuel, internal or external combustion engine)<br>electric motor |  |          |      |   |                     |                                   |
| Power consumption in modes other than 'active mode'  |  |          |      |   |                     |                                   |
| Off mode   | $P_{off}$  | 0.020    | kW   | Crankcase heater mode   | $P_{ck}$            | 0.000 kW                          |
| Thermostat-off mode  | $P_{to}$   | 0.014    | kW   | Standby mode  | $P_{sb}$            | 0.020 kW                          |
| Other items  |  |          |      |   |                     |                                   |
| Capacity control   |  | variable |      | For air-to-air conditioner: air flow rate, outdoor  |                     | m³/h                              |
| Sound power level, outdoor   | L <sub>WA</sub>  | 73.0     | dB   |   |                     |                                   |
| Sound power level, indoor  | L <sub>WA</sub>  | 61.0     | dB   | If engine driven: Emissions of nitrogen oxides  | NO <sub>x</sub> *** | mg/kWh fuel input GCV             |
|  |  |          |      | GWP of the refrigerant  |                     | kg CO <sub>2</sub> eq (100 years) |
| Contact details  | Panasonic Testing Centre, Panasonic Marketing Europe GmbH Winsbergstr 15, 22525 Hamburg, Germany |          |      |   |                     |                                   |

\*\* If C<sub>d</sub> is not determined by measurement then the default degradation coefficient air conditioners shall be 0.25.  
\*\*\* from 26 September 2018.

Where information relates to multi-split air conditioners, the test result and performance data may be obtained on the basis of the performance of the outdoor unit, with a combination of indoor unit(s) recommended by the manufacturer or importer.

## Information requirements for heat pumps

|  |  |                             |      |  |  |
|--|--|-----------------------------|------|--|--|
| Model(s):  |  | Outdoor Unit<br>Indoor Unit |      | U-125PEY1E8<br>S-125PUZE5A   |  |
| Rated heating capacity   | Symbol   | Value                       | Unit | Item   | Value                                    |
|  | $P_{rated,h}$  | 12.5                        | kW   | Seasonal space heating energy efficiency   | $\eta_{s,h}$                             |
| Refrigeration load   | Symbol   | Value                       | Unit | Item   | Value                                    |
|  | $P_{design,h}$   | 12.5                        | kW   | Declared coefficient of performance or gas utilization efficiency / auxiliary energy factor for part load at given outdoor temperatures Tj |  |
| Declared heating capacity for part load at indoor temperature 20 °C and outdoor temperature Tj |  |                             |      |  |  |
|  |  | 11.0                        | kW   | Tj = -7 °C   | 2.3                                      |
|  |  | 6.7                         | kW   | Tj = +2 °C   | 3.7                                      |
|  |  | 4.3                         | kW   | Tj = +7 °C   | 5.6                                      |
|  |  | 4.5                         | kW   | Tj = +12 °C  | 6.9                                      |
| T <sub>biv</sub> = bivalent temperature  | P <sub>biv</sub>   | 11.0                        | kW   | T <sub>biv</sub> = bivalent temperature  | GUE <sub>biv</sub> or AEF <sub>biv</sub> |
| T <sub>ol</sub> = operation limit  |  | 9.8                         | kW   | T <sub>ol</sub> = operation limit  |  |
| For air-to-water heat pumps: Tj = -15 °C (if T <sub>ol</sub> < -20 °C)                         |  | -                           | kW   | For water-to-air heat pumps: Tj = -15 °C (if T <sub>ol</sub> < -20 °C)   |  |
| Bivalent temperature   | T <sub>biv</sub>   | -7                          | °C   | For water-to-air heat pumps: Operation limit temperature   | T <sub>ol</sub>                          |
| Degradation co-efficient heat pumps**  | C <sub>h</sub>   | 0.25                        | -    |  |  |
| Power consumption in modes other than 'active mode'  |  |                             |      |  |  |
| Off mode   | $P_{off}$  | 0.020                       | kW   | back-up heating capacity*  | elbu                                     |
| Thermostat-off mode  | $P_{to}$   | 0.014                       | kW   | Type of energy input   |  |
| Crankcase heater mode  | $P_{ck}$   | 0.000                       | kW   | Standby mode   | $P_{sb}$                                 |
| Other items  |  |                             |      |  |  |
| Capacity control   |  | variable                    |      | For air-to-air heat pumps: air flow rate, outdoor  | 4380                                     |
| Sound power level, outdoor   | L <sub>WA</sub>  | 73.0                        | dB   | For water-/brine-to-air heat pumps: Rated brine or water flow rate, outdoor side heat exchanger  | -  |
| Sound power level, indoor  | L <sub>WA</sub>  | 61.0                        | dB   | Emissions of nitrogen oxides (if applicable)   | NO <sub>x</sub> ***                      |
|  |  |                             |      | GWP of the refrigerant   | 2088                                     |
| Contact details  | Panasonic Testing Centre, Panasonic Marketing Europe GmbH Winsbergstr 15, 22525 Hamburg, Germany |                             |      |  |  |

\*\* If C<sub>h</sub> is not determined by measurement then the default degradation coefficient of heat pumps shall be 0.25.  
\*\*\* from 26 September 2018.

Where information relates to multi-split heat pumps, the test result and performance data may be obtained on the basis of the performance of the outdoor unit, with a combination of indoor unit(s) recommended by the manufacturer or importer.



## Information requirements for air-to-air air conditioners

|  |  |                           |  |                    |  |
|--|--|---------------------------|--|--------------------|--|
| Model(s):  |  | U-125PEY1E5<br>S-60PT2E5A |  | X2                 |  |
| Outdoor side heat exchanger of air conditioner:  |  | Indoor Unit               |  | air                |  |
| Indoor side heat exchanger of air conditioner:   |  | Outdoor Unit              |  | air                |  |
| Type: compressor driven vapour compression or sorption process   |  |                           |  | vapour compression |  |
| if applicable: driver of compressor: [electric motor or fuel driven, gaseous or liquid fuel, internal or external combustion engine] |  |                           |  | electric motor     |  |

|  |  |                           |  |                |  |
|--|--|---------------------------|--|----------------|--|
| Model(s):  |  | U-125PEY1E5<br>S-60PT2E5A |  | X2             |  |
| Outdoor side heat exchanger of heat pump:  |  | Indoor Unit               |  | air            |  |
| Indoor side heat exchanger of heat pump:   |  | Outdoor Unit              |  | air            |  |
| Indication if the heater is equipped with a supplementary heater:  |  |                           |  | no             |  |
| if applicable: driver of compressor: [electric motor or fuel driven, gaseous or liquid fuel, internal or external combustion engine] |  |                           |  | electric motor |  |

Parameters shall be declared for the average heating season, parameters for the warmer and colder heating seasons are optional.

| Item  | Symbol           | Value  | Unit | Item  | Symbol  | Value | Unit                              |
|---|------------------|--|------|---|---|-------|-----------------------------------|
| Rated cooling capacity  | $P_{rated,c}$    | 12.5   | kW   | Seasonal space cooling energy efficiency  | $\eta_{s,c}$  | 218.3 | %                                 |
| Refrigeration load  | $P_{design,c}$   | 12.5   | kW   | Declared energy efficiency ratio or gas utilization efficiency / auxiliary energy factor for part load at given outdoor temperatures Tj |   |       |                                   |
| Declared cooling capacity for part load at given outdoor temperatures Tj and indoor 27°/19°C (dry/wet bulb) |                  |  |      |   |   |       |                                   |
| Tj = +35 °C   |                  | 12.5   | kW   | Tj = +35 °C   |   | 3.0   | %                                 |
| Tj = +30 °C   |                  | 9.2  | kW   | Tj = +30 °C   | EER <sub>d</sub> or GUE <sub>d,brn</sub> / AEF <sub>d,brn</sub> | 4.0   | %                                 |
| Tj = +25 °C   | P <sub>dc</sub>  | 5.9  | kW   | Tj = +25 °C   |   | 6.7   | %                                 |
| Tj = +20 °C   |                  | 5.0  | kW   | Tj = +20 °C   |   | 9.0   | %                                 |
| Degradation co-efficient for air conditioners**   | C <sub>dc</sub>  | 0.25   | -    | Declared heating capacity for part load at indoor temperature 20 °C and outdoor temperature Tj  |   |       |                                   |
| Declared heating capacity for part load at indoor temperature 20 °C and outdoor temperature Tj              |                  |  |      |   |   |       |                                   |
| Tj = -7 °C  |                  | 11.0   | kW   | Tj = -7 °C  |   | 2.1   | %                                 |
| Tj = +2 °C  |                  | 6.7  | kW   | Tj = +2 °C  |   | 3.4   | %                                 |
| Tj = +7 °C  |                  | 4.3  | kW   | Tj = +7 °C  |   | 5.3   | %                                 |
| Tj = +12 °C   |                  | 4.4  | kW   | Tj = +12 °C   |   | 6.5   | %                                 |
| T <sub>bw</sub> = bivalent temperature  | P <sub>bh</sub>  | 11.0   | kW   | T <sub>bw</sub> = bivalent temperature  | COP <sub>d</sub> or GUE <sub>d,brn</sub> / AEF <sub>d,brn</sub> | 2.1   | %                                 |
| T <sub>ol</sub> = operation limit   |                  | 9.3  | kW   | T <sub>ol</sub> = operation limit   |   | 1.7   | %                                 |
| For air-to-water heat pumps: Tj = -15 °C (if T <sub>ca</sub> < -20 °C)                                      |                  | -  | kW   | For water-to-air heat pumps: Tj = -15 °C (if T <sub>ca</sub> < -20 °C)  |   | -     | %                                 |
| Bivalent temperature  | T <sub>bw</sub>  | -7   | °C   | For water-to-air heat pumps: Operation limit temperature  | T <sub>ol</sub>   | -15   | °C                                |
| Degradation co-efficient heat pumps**   | C <sub>dh</sub>  | 0.25   | -    | Power consumption in modes other than 'active mode'   |   |       |                                   |
| Power consumption in modes other than 'active mode'   |                  |  |      |   |   |       |                                   |
| Off mode  | P <sub>off</sub> | 0.012  | kW   | Crankcase heater mode   | P <sub>ck</sub>   | 0.000 | kW                                |
| Thermostat-off mode   | P <sub>to</sub>  | 0.000  | kW   | Standby mode  | P <sub>sb</sub>   | 0.012 | kW                                |
| Crankcase heater mode   | P <sub>ck</sub>  | 0.000  | kW   | Other items   |   |       |                                   |
| Capacity control  |                  |  |      |   |   |       |                                   |
| Capacity control  |                  | variable   |      | For air-to-air conditioner: air flow rate, outdoor  |   | 4800  | m³/h                              |
| Sound power level, outdoor  | L <sub>WA</sub>  | 73.0   | dB   |   |   |       |                                   |
| Sound power level, indoor   | L <sub>WA</sub>  | 56.0   | dB   | if engine driven: Emissions of nitrogen oxides  | NO <sub>x</sub> ***   | -     | mg/KWh fuel input GCV             |
|   |                  |  |      | GWP of the refrigerant  |   | 2088  | kg CO <sub>2</sub> eq (100 years) |
| Contact details   |                  | Panasonic Testing Centre, Panasonic Marketing Europe GmbH Winsbergiring 15, 22625 Hamburg, Germany |      |   |   |       |                                   |

\*\* If C<sub>dc</sub> is not determined by measurement then the default degradation coefficient air conditioners shall be 0.25.

\*\*\* from 26 September 2018.

Where information relates to multi-split air conditioners, the test result and performance data may be obtained on the basis of the performance of the outdoor unit, with a combination of indoor unit(s) recommended by the manufacturer or importer.

## Information requirements for heat pumps

|  |  |                           |  |                |  |
|--|--|---------------------------|--|----------------|--|
| Model(s):  |  | U-125PEY1E5<br>S-60PT2E5A |  | X2             |  |
| Outdoor side heat exchanger of heat pump:  |  | Indoor Unit               |  | air            |  |
| Indoor side heat exchanger of heat pump:   |  | Outdoor Unit              |  | air            |  |
| Indication if the heater is equipped with a supplementary heater:  |  |                           |  | no             |  |
| if applicable: driver of compressor: [electric motor or fuel driven, gaseous or liquid fuel, internal or external combustion engine] |  |                           |  | electric motor |  |

Parameters shall be declared for the average heating season, parameters for the warmer and colder heating seasons are optional.

| Item   | Symbol           | Value  | Unit | Item   | Symbol  | Value | Unit                              |
|--|------------------|--|------|--|---|-------|-----------------------------------|
| Rated heating capacity   | $P_{rated,h}$    | 12.5   | kW   | Seasonal space heating energy efficiency   | $\eta_{s,h}$  | 140.5 | %                                 |
| Refrigeration load   | $P_{design,h}$   | 12.5   | kW   | Declared coefficient of performance or gas utilization efficiency / auxiliary energy factor for part load at given outdoor temperatures Tj |   |       |                                   |
| Declared heating capacity for part load at indoor temperature 20 °C and outdoor temperature Tj |                  |  |      |  |   |       |                                   |
| Tj = -7 °C   |                  | 11.0   | kW   | Tj = -7 °C   |   | 2.1   | %                                 |
| Tj = +2 °C   |                  | 6.7  | kW   | Tj = +2 °C   |   | 3.4   | %                                 |
| Tj = +7 °C   |                  | 4.3  | kW   | Tj = +7 °C   |   | 5.3   | %                                 |
| Tj = +12 °C  |                  | 4.4  | kW   | Tj = +12 °C  |   | 6.5   | %                                 |
| T <sub>bw</sub> = bivalent temperature   | P <sub>bh</sub>  | 11.0   | kW   | T <sub>bw</sub> = bivalent temperature   | COP <sub>d</sub> or GUE <sub>d,brn</sub> / AEF <sub>d,brn</sub> | 2.1   | %                                 |
| T <sub>ol</sub> = operation limit  |                  | 9.3  | kW   | T <sub>ol</sub> = operation limit  |   | 1.7   | %                                 |
| For air-to-water heat pumps: Tj = -15 °C (if T <sub>ca</sub> < -20 °C)                         |                  | -  | kW   | For water-to-air heat pumps: Tj = -15 °C (if T <sub>ca</sub> < -20 °C)   |   | -     | %                                 |
| Bivalent temperature   | T <sub>bw</sub>  | -7   | °C   | For water-to-air heat pumps: Operation limit temperature   | T <sub>ol</sub>   | -15   | °C                                |
| Degradation co-efficient heat pumps**  | C <sub>dh</sub>  | 0.25   | -    | Power consumption in modes other than 'active mode'  |   |       |                                   |
| Power consumption in modes other than 'active mode'  |                  |  |      |  |   |       |                                   |
| Off mode   | P <sub>off</sub> | 0.012  | kW   | Supplementary heater back-up heating capacity*   | e <sub>bu</sub>   | 2.2   | kW                                |
| Thermostat-off mode  | P <sub>to</sub>  | 0.000  | kW   | Type of energy input   |   |       |                                   |
| Crankcase heater mode  | P <sub>ck</sub>  | 0.000  | kW   | Standby mode   | P <sub>sb</sub>   | 0.012 | kW                                |
| Capacity control   |                  |  |      |  |   |       |                                   |
| Capacity control   |                  | variable   |      | For air-to-air heat pumps: air flow rate, outdoor  |   | 4380  | m³/h                              |
| Sound power level, outdoor   | L <sub>WA</sub>  | 73.0   | dB   | For water-/brine-to-air heat pumps: Rated brine or water flow rate, outdoor side heat exchanger  |   | -     | m³/h                              |
| Sound power level, indoor  | L <sub>WA</sub>  | 56.0   | dB   | Emissions of nitrogen oxides (if applicable)   | NO <sub>x</sub> ***   | -     | mg/KWh fuel input GCV             |
|  |                  |  |      | GWP of the refrigerant   |   | 2088  | kg CO <sub>2</sub> eq (100 years) |
| Contact details  |                  | Panasonic Testing Centre, Panasonic Marketing Europe GmbH Winsbergiring 15, 22625 Hamburg, Germany |      |  |   |       |                                   |

\*\* If C<sub>dh</sub> is not determined by measurement then the default degradation coefficient of heat pumps shall be 0.25.

\*\*\* from 26 September 2018.

Where information relates to multi-split heat pumps, the test result and performance data may be obtained on the basis of the performance of the outdoor unit, with a combination of indoor unit(s) recommended by the manufacturer or importer.





## Information requirements for air-to-air air conditioners

|  |  |                           |  |                |  |
|--|--|---------------------------|--|----------------|--|
| Model(s):  |  | U-125PEY1E8<br>S-60PT2E5A |  | X2             |  |
| Indoor Unit  |  | air                       |  | air            |  |
| Outdoor side heat exchanger of air conditioner:  |  | vapour compression        |  | electric motor |  |
| Indoor side heat exchanger of air conditioner:   |  | vapour compression        |  | electric motor |  |
| Type: compressor driven vapour compression or sorption process   |  | vapour compression        |  | electric motor |  |
| if applicable: driver of compressor: [electric motor or fuel driven, gaseous or liquid fuel, internal or external combustion engine] |  | electric motor            |  | electric motor |  |

| Item   | Symbol         | Value | Unit | Item   | Symbol                                     | Value | Unit |
|--|----------------|-------|------|--|--|-------|------|
| Rated cooling capacity   | $P_{rated,c}$  | 12.5  | kW   | Seasonal space cooling energy efficiency   | $\eta_{s,c}$                               | 217.7 | %    |
| Refrigeration load   | $P_{design,c}$ | 12.5  | kW   | Declared energy efficiency ratio or gas utilization efficiency / auxiliary energy factor for part load at given outdoor temperatures $T_j$ |  |       |      |
| Declared cooling capacity for part load at given outdoor temperatures $T_j$ and indoor 27°/19°C (dry/wet bulb) |                |       |      |  |  |       |      |
| $T_j = +35\text{ °C}$  |                | 12.5  | kW   | $T_j = +35\text{ °C}$  |  | 3.0   | %    |
| $T_j = +30\text{ °C}$  |                | 9.2   | kW   | $T_j = +30\text{ °C}$  | EER <sub>d</sub> or GUE <sub>d,inh</sub> / | 4.0   | %    |
| $T_j = +25\text{ °C}$  |                | 5.9   | kW   | $T_j = +25\text{ °C}$  | AEF <sub>d,inh</sub>                       | 6.7   | %    |
| $T_j = +20\text{ °C}$  |                | 5.0   | kW   | $T_j = +20\text{ °C}$  |  | 9.0   | %    |
| Degradation co-efficient for air conditioners**  | $C_{dc}$       | 0.25  | -    |  |  |       |      |

| Power consumption in modes other than 'active mode' |           | Other items |    |  |          |  |      |  |
|---|-----------|-------------|----|--|----------|--|------|--|
| Off mode  | $P_{off}$ | 0.015       | kW | Capacity control   | variable | For air-to-air air conditioner: air flow rate, outdoor | 4800 | m <sup>3</sup> /h                              |
| Thermostat-off mode                                 | $P_{to}$  | 0.000       | kW | Sound power level, outdoor   | $L_{WA}$ | 73.0   | dB   |  |
| Crankcase heater mode                               | $P_{ck}$  | 0.000       | kW | Sound power level, indoor  | $L_{WA}$ | 56.0   | dB   | if engine driven: Emissions of nitrogen oxides |
|   |           |             |    | GWP of the refrigerant   |          |  |      |  |
|   |           |             |    | NO <sub>x</sub> ***  |          |  |      |  |
|   |           |             |    | mg/kWh fuel input GCV  |          |  |      |  |
|   |           |             |    | kg CO <sub>2</sub> eq (100 years)  |          |  |      |  |
|   |           |             |    | 2088   |          |  |      |  |
|   |           |             |    | Panasonic Testing Centre, Panasonic Marketing Europe GmbH Winsbergstr 15, 22525 Hamburg, Germany |          |  |      |  |

\*\* If  $C_{dc}$  is not determined by measurement then the default degradation coefficient air conditioners shall be 0.25.  
 \*\*\* from 26 September 2018.  
 Where information relates to multi-split air conditioners, the test result and performance data may be obtained on the basis of the performance of the outdoor unit, with a combination of indoor unit(s) recommended by the manufacturer or importer.

## Information requirements for heat pumps

|  |  |                           |  |                |  |
|--|--|---------------------------|--|----------------|--|
| Model(s):  |  | U-125PEY1E8<br>S-60PT2E5A |  | X2             |  |
| Indoor Unit  |  | air                       |  | air            |  |
| Outdoor side heat exchanger of heat pump:  |  | air                       |  | no             |  |
| Indoor side heat exchanger of heat pump:   |  | air                       |  | electric motor |  |
| Indication if the heater is equipped with a supplementary heater:  |  | no                        |  | electric motor |  |
| if applicable: driver of compressor: [electric motor or fuel driven, gaseous or liquid fuel, internal or external combustion engine] |  | electric motor            |  | electric motor |  |
| Parameters shall be declared for the average heating season, parameters for the warmer and colder heating seasons are optional.      |  | electric motor            |  | electric motor |  |

| Item  | Symbol         | Value | Unit | Item  | Symbol  | Value | Unit |
|---|----------------|-------|------|---|---|-------|------|
| Rated heating capacity  | $P_{rated,h}$  | 12.5  | kW   | Seasonal space heating energy efficiency  | $\eta_{s,h}$  | 140.5 | %    |
| Refrigeration load  | $P_{design,h}$ | 12.5  | kW   | Declared coefficient of performance or gas utilization efficiency / auxiliary energy factor for part load at given outdoor temperatures $T_j$ |   |       |      |
| Declared heating capacity for part load at indoor temperature 20 °C and outdoor temperature $T_j$ |                |       |      |   |   |       |      |
| $T_j = -7\text{ °C}$  |                | 11.0  | kW   | $T_j = -7\text{ °C}$  |   | 2.1   | %    |
| $T_j = +2\text{ °C}$  |                | 6.7   | kW   | $T_j = +2\text{ °C}$  |   | 3.4   | %    |
| $T_j = +7\text{ °C}$  |                | 4.3   | kW   | $T_j = +7\text{ °C}$  |   | 5.3   | %    |
| $T_j = +12\text{ °C}$   |                | 4.4   | kW   | $T_j = +12\text{ °C}$   |   | 6.5   | %    |
| $T_{sw} = \text{bivalent temperature}$  | $P_{th}$       | 11.0  | kW   | $T_{sw} = \text{bivalent temperature}$  | COP <sub>d</sub> or GUE <sub>d,inh</sub> / AEF <sub>d,inh</sub> | 2.1   | %    |
| $T_{ol} = \text{operation limit}$   |                | 9.3   | kW   | $T_{ol} = \text{operation limit}$   |   | 1.7   | %    |
| For air-to-water heat pumps: $T_j = -15\text{ °C}$ (if $T_{ol} < -20\text{ °C}$ )                 |                | -     | kW   | For water-to-air heat pumps: $T_j = -15\text{ °C}$ (if $T_{ol} < -20\text{ °C}$ )   |   | -     | %    |
| Bivalent temperature  | $T_{bv}$       | -7    | °C   | For water-to-air heat pumps: Operation limit temperature  | $T_{ol}$  | -15   | °C   |
| Degradation co-efficient heat pumps**   | $C_{th}$       | 0.25  | -    |   |   |       |      |

| Power consumption in modes other than 'active mode' |           | Other items |    |  |          |   |      |   |
|---|-----------|-------------|----|--|----------|---|------|---|
| Off mode  | $P_{off}$ | 0.015       | kW | Capacity control   | variable | For air-to-air heat pumps: air flow rate, outdoor | 4380 | m <sup>3</sup> /h   |
| Thermostat-off mode                                 | $P_{to}$  | 0.000       | kW | Sound power level, outdoor   | $L_{WA}$ | 73.0  | dB   | For water-/brine-to-air heat pumps: Rated brine or water flow rate, outdoor side heat exchanger |
| Crankcase heater mode                               | $P_{ck}$  | 0.000       | kW | Sound power level, indoor  | $L_{WA}$ | 56.0  | dB   | Emissions of nitrogen oxides (if applicable)  |
|   |           |             |    | GWP of the refrigerant   |          |   |      |   |
|   |           |             |    | NO <sub>x</sub> ***  |          |   |      |   |
|   |           |             |    | mg/kWh fuel input GCV  |          |   |      |   |
|   |           |             |    | kg CO <sub>2</sub> eq (100 years)  |          |   |      |   |
|   |           |             |    | 2088   |          |   |      |   |
|   |           |             |    | Panasonic Testing Centre, Panasonic Marketing Europe GmbH Winsbergstr 15, 22525 Hamburg, Germany |          |   |      |   |

\*\* If  $C_{th}$  is not determined by measurement then the default degradation coefficient of heat pumps shall be 0.25.  
 \*\*\* from 26 September 2018.  
 Where information relates to multi-split heat pumps, the test result and performance data may be obtained on the basis of the performance of the outdoor unit, with a combination of indoor unit(s) recommended by the manufacturer or importer.

### Information requirements for air-to-air air conditioners

Model(s): U-140PEY1E8 X2  
S-71PT2E5A

Outdoor Unit  
Indoor Unit

Outdoor side heat exchanger of air conditioner:  
Indoor side heat exchanger of air conditioner:  
Type: compressor driven vapour compression or sorption process  
if applicable; driver of compressor: [electric motor or fuel driven,  
gaseous or liquid fuel, internal or external combustion engine]

air  
air  
vapour compression  
electric motor

| Item  | Symbol   | Value    | Unit | Item   | Symbol  | Value | Unit                              |
|---|--|----------|------|--|---|-------|-----------------------------------|
| Rated cooling capacity  | $P_{rated,c}$  | 14.0     | kW   | Seasonal space cooling energy efficiency   | $\eta_{s,c}$  | 217.0 | %                                 |
| Refrigeration load  | $P_{design,c}$   | 14.0     | kW   |  |   |       |                                   |
| Declared cooling capacity for part load at given outdoor temperatures T <sub>j</sub> and indoor 27°/19°C (dry/wet bulb)                             |  |          |      |  |   |       |                                   |
|   |  | 14.0     | kW   | T <sub>j</sub> = + 35 °C   |   | 2.9   | %                                 |
|   |  | 10.3     | kW   | T <sub>j</sub> = + 30 °C   | EER <sub>d</sub> or GUE <sub>o,ah</sub> /                     | 3.9   | %                                 |
|   | P <sub>dc</sub>  | 6.6      | kW   | T <sub>j</sub> = + 25 °C   | AEF <sub>o,ah</sub>   | 6.4   | %                                 |
|   |  | 5.3      | kW   | T <sub>j</sub> = + 20 °C   |   | 10.1  | %                                 |
| Degradation co- efficient for air conditioners**  | C <sub>dc</sub>  | 0.25     | -    |  |   |       |                                   |
| Declared energy efficiency ratio or gas utilization efficiency / auxiliary energy factor for part load at given outdoor temperatures T <sub>j</sub> |  |          |      |  |   |       |                                   |
|   |  | 12.3     | kW   | T <sub>j</sub> = - 7 °C  |   | 2.2   | %                                 |
|   |  | 7.5      | kW   | T <sub>j</sub> = + 2 °C  |   | 3.4   | %                                 |
|   |  | 4.8      | kW   | T <sub>j</sub> = + 7 °C  |   | 5.1   | %                                 |
|   |  | 4.5      | kW   | T <sub>j</sub> = + 12 °C   |   | 6.4   | %                                 |
|   | T <sub>biv</sub> = bivalent temperature  | 12.3     | kW   | T <sub>av</sub> = bivalent temperature   | COP <sub>d</sub> or GUE <sub>o,ah</sub> / AEF <sub>o,ah</sub> | 2.2   | %                                 |
|   | T <sub>ol</sub> = operation limit  | 9.3      | kW   | T <sub>ol</sub> = operation limit  |   | 1.6   | %                                 |
|   | For air-to-water heat pumps: T <sub>j</sub> = - 15 °C (if T <sub>oa</sub> < - 20 °C)               | -        | kW   | For water-to-air heat pumps: T <sub>j</sub> = - 15 °C (if T <sub>oa</sub> < - 20 °C) |   | -     | %                                 |
| Bivalent temperature  | T <sub>biv</sub>   | -7       | °C   | For water-to-air heat pumps: Operation limit temperature                             | T <sub>ol</sub>   | -15   | °C                                |
| Degradation co- efficient heat pumps**  | C <sub>dh</sub>  | 0.25     | -    |  |   |       |                                   |
| Power consumption in modes other than 'active mode'   |  |          |      |  |   |       |                                   |
| Off mode  | P <sub>off</sub>   | 0.015    | kW   | Craneckase heater mode   | P <sub>ck</sub>   | 0.000 | kW                                |
| Thermostat-off mode   | P <sub>to</sub>  | 0.000    | kW   | Standby mode   | P <sub>sb</sub>   | 0.015 | kW                                |
| Other items   |  |          |      |  |   |       |                                   |
| Capacity control  |  | variable |      | For air-to-air air conditioner: air flow rate, outdoor                               |   | 8100  | m <sup>3</sup> /h                 |
| Sound power level, outdoor  | L <sub>WA</sub>  | 71.0     | dB   |  |   |       |                                   |
| Sound power level, indoor   | L <sub>WA</sub>  | 57.0     | dB   | if engine driven: Emissions of nitrogen oxides                                       | NO <sub>x</sub> ***   | -     | mg/kWh fuel input GCV             |
|   |  |          |      | GWP of the refrigerant   |   | 2088  | kg CO <sub>2</sub> eq (100 years) |
| Contact details   | Panasonic Testing Centre, Panasonic Marketing Europe GmbH Winsbergiring 15, 22525 Hamburg, Germany |          |      |  |   |       |                                   |

\*\* If C<sub>dc</sub> is not determined by measurement then the default degradation coefficient air conditioners shall be 0.25.  
\*\*\* from 26 September 2018.  
Where information relates to multi-split air conditioners, the test result and performance data may be obtained on the basis of the performance of the outdoor unit, with a combination of indoor unit(s) recommended by the manufacturer or importer.

### Information requirements for heat pumps

Model(s): U-140PEY1E8 X2  
S-71PT2E5A

Outdoor Unit  
Indoor Unit

Outdoor side heat exchanger of heat pump:  
Indoor side heat exchanger of heat pump:  
Indication if the heater is equipped with a supplementary heater:  
if applicable; driver of compressor: [electric motor or fuel driven,  
gaseous or liquid fuel, internal or external combustion engine]

electric motor

| Item   | Symbol   | Value    | Unit | Item  | Symbol  | Value | Unit                              |
|--|--|----------|------|---|---|-------|-----------------------------------|
| Rated heating capacity   | $P_{rated,h}$  | 14.0     | kW   | Seasonal space heating energy efficiency  | $\eta_{s,h}$  | 140.4 | %                                 |
| Refrigeration load   | $P_{design,h}$   | 14.0     | kW   |   |   |       |                                   |
| Declared heating capacity for part load at indoor temperature 20 °C and outdoor temperature T <sub>j</sub> |  |          |      |   |   |       |                                   |
|  |  | 12.3     | kW   | T <sub>j</sub> = - 7 °C   |   | 2.2   | %                                 |
|  |  | 7.5      | kW   | T <sub>j</sub> = + 2 °C   |   | 3.4   | %                                 |
|  |  | 4.8      | kW   | T <sub>j</sub> = + 7 °C   |   | 5.1   | %                                 |
|  |  | 4.5      | kW   | T <sub>j</sub> = + 12 °C  |   | 6.4   | %                                 |
|  | T <sub>biv</sub> = bivalent temperature  | 12.3     | kW   | T <sub>av</sub> = bivalent temperature  | COP <sub>d</sub> or GUE <sub>o,ah</sub> / AEF <sub>o,ah</sub> | 2.2   | %                                 |
|  | T <sub>ol</sub> = operation limit  | 9.3      | kW   | T <sub>ol</sub> = operation limit   |   | 1.6   | %                                 |
|  | For air-to-water heat pumps: T <sub>j</sub> = - 15 °C (if T <sub>oa</sub> < - 20 °C)               | -        | kW   | For water-to-air heat pumps: T <sub>j</sub> = - 15 °C (if T <sub>oa</sub> < - 20 °C)            |   | -     | %                                 |
| Bivalent temperature   | T <sub>biv</sub>   | -7       | °C   | For water-to-air heat pumps: Operation limit temperature  | T <sub>ol</sub>   | -15   | °C                                |
| Degradation co- efficient heat pumps**   | C <sub>dh</sub>  | 0.25     | -    |   |   |       |                                   |
| Power consumption in modes other than 'active mode'  |  |          |      |   |   |       |                                   |
| Off mode   | P <sub>off</sub>   | 0.015    | kW   | Supplementary heater back-up heating capacity*  | elbu  | 2.9   | kW                                |
| Thermostat-off mode  | P <sub>to</sub>  | 0.000    | kW   | Type of energy input  |   |       |                                   |
| Craneckase heater mode   | P <sub>ck</sub>  | 0.000    | kW   | Standby mode  | P <sub>sb</sub>   | 0.015 | kW                                |
| Other items  |  |          |      |   |   |       |                                   |
| Capacity control   |  | variable |      | For air-to-air heat pumps: air flow rate, outdoor   |   | 7200  | m <sup>3</sup> /h                 |
| Sound power level, outdoor   | L <sub>WA</sub>  | 70.0     | dB   | For water-/brine-to-air heat pumps: Rated brine or water flow rate, outdoor side heat exchanger |   | -     | m <sup>3</sup> /h                 |
| Sound power level, indoor  | L <sub>WA</sub>  | 57.0     | dB   | Emissions of nitrogen oxides (if applicable)  | NO <sub>x</sub> ***   | -     | mg/kWh fuel input GCV             |
|  |  |          |      | GWP of the refrigerant  |   | 2088  | kg CO <sub>2</sub> eq (100 years) |
| Contact details  | Panasonic Testing Centre, Panasonic Marketing Europe GmbH Winsbergiring 15, 22525 Hamburg, Germany |          |      |   |   |       |                                   |

\*\* If C<sub>dh</sub> is not determined by measurement then the default degradation coefficient of heat pumps shall be 0.25.  
\*\*\* from 26 September 2018.  
Where information relates to multi-split heat pumps, the test result and performance data may be obtained on the basis of the performance of the outdoor unit, with a combination of indoor unit(s) recommended by the manufacturer or importer.

## Information requirements for air-to-air air conditioners

|  |  |                            |  |
|--|--|----------------------------|--|
| Model(s):  |  | U-125PEY1E8<br>S-125PT2E5A |  |
| Outdoor side heat exchanger of air conditioner:  |  | air                        |  |
| Indoor side heat exchanger of air conditioner:   |  | air                        |  |
| Type: compressor driven vapour compression or sorption process   |  | vapour compression         |  |
| if applicable: driver of compressor: [electric motor or fuel driven, gaseous or liquid fuel, internal or external combustion engine] |  | electric motor             |  |

| Item  | Symbol   | Value    | Unit | Item  | Symbol  | Value | Unit                              |
|---|--|----------|------|---|---|-------|-----------------------------------|
| Rated cooling capacity  | $P_{rated,c}$  | 12.5     | kW   | Seasonal space cooling energy efficiency  | $\eta_{s,c}$  | 206.7 | %                                 |
| Refrigeration load  | $P_{design,c}$   | 12.5     | kW   | Declared energy efficiency ratio or gas utilization efficiency / auxiliary energy factor for part load at given outdoor temperatures T <sub>J</sub> |   |       |                                   |
| Declared cooling capacity for part load at given outdoor temperatures T <sub>J</sub> and indoor 27°/19°C (dry/wet bulb) |  |          |      |   |   |       |                                   |
|   |  | 12.5     | kW   | T <sub>J</sub> = + 35 °C  |   | 3.0   | %                                 |
|   |  | 9.2      | kW   | T <sub>J</sub> = + 30 °C  | EER <sub>d</sub> or GUE <sub>d,brn</sub> / AEF <sub>d,brn</sub> | 4.0   | %                                 |
|   | $P_{dc}$   | 5.9      | kW   | T <sub>J</sub> = + 25 °C  |   | 6.7   | %                                 |
|   |  | 4.7      | kW   | T <sub>J</sub> = + 20 °C  |   | 9.0   | %                                 |
| Degradation co- efficient for air conditioners**  | $C_{dc}$   | 0.25     | -    | Declared heating capacity for part load at indoor temperature 20 °C and outdoor temperature T <sub>J</sub>  |   |       |                                   |
| Declared heating capacity for part load at indoor temperature 20 °C and outdoor temperature T <sub>J</sub>              |  |          |      |   |   |       |                                   |
|   |  | 11.0     | kW   | T <sub>J</sub> = - 7 °C   |   | 2.1   | %                                 |
|   |  | 6.7      | kW   | T <sub>J</sub> = + 2 °C   |   | 3.4   | %                                 |
|   |  | 4.3      | kW   | T <sub>J</sub> = + 7 °C   |   | 5.3   | %                                 |
|   |  | 4.4      | kW   | T <sub>J</sub> = + 12 °C  |   | 6.5   | %                                 |
|   | $P_{th}$   | 11.0     | kW   | T <sub>br</sub> = bivalent temperature  | COP <sub>d</sub> or GUE <sub>d,brn</sub> / AEF <sub>d,brn</sub> | 2.1   | %                                 |
|   |  | 9.8      | kW   | T <sub>ol</sub> = operation limit   |   | 1.7   | %                                 |
|   |  | -        | kW   | For water-to-air heat pumps: T <sub>J</sub> = - 15 °C (if T <sub>ca</sub> < - 20 °C)  |   | -     | %                                 |
|   |  | -7       | °C   | Bivalent temperature  | T <sub>br</sub>   | -15   | °C                                |
|   |  | 0.25     | -    | Degradation co- efficient heat pumps**  | C <sub>th</sub>   | -     |                                   |
| Power consumption in modes other than 'active mode'   |  |          |      |   |   |       |                                   |
| Off mode  | $P_{off}$  | 0.020    | kW   | Supplementary heater back-up heating capacity*  | elbu  | 2.0   | kW                                |
| Thermostat-off mode   | $P_{to}$   | 0.101    | kW   | Type of energy input  |   |       |                                   |
| Crankcase heater mode   | $P_{ck}$   | 0.000    | kW   | Standby mode  | $P_{sb}$  | 0.020 | kW                                |
| Other items   |  |          |      |   |   |       |                                   |
| Capacity control  |  | variable |      | For air-to-air heat pumps: air flow rate, outdoor   |   | 4380  | m <sup>3</sup> /h                 |
| Sound power level, outdoor  | $L_{WA}$   | 73.0     | dB   | For water-/brine-to-air heat pumps: Rated brine or water flow rate, outdoor side heat exchanger   |   | -     | m <sup>3</sup> /h                 |
| Sound power level, indoor   | $L_{WA}$   | 64.0     | dB   | Emissions of nitrogen oxides (if applicable)  | NO <sub>x</sub> **  | -     | mg/KWh fuel input GCV             |
|   |  |          |      | GWP of the refrigerant  |   | 2088  | kg CO <sub>2</sub> eq (100 years) |
| Contact details   | Panasonic Testing Centre, Panasonic Marketing Europe GmbH Winsberggring 15, 22625 Hamburg, Germany |          |      |   |   |       |                                   |

\*\* If  $C_{dc}$  is not determined by measurement then the default degradation coefficient air conditioners shall be 0.25.

\*\*\* from 26 September 2018.

Where information relates to multi-split air conditioners, the test result and performance data may be obtained on the basis of the performance of the outdoor unit, with a combination of indoor unit(s) recommended by the manufacturer or importer.

## Information requirements for heat pumps

|  |  |                            |  |
|--|--|----------------------------|--|
| Model(s):  |  | U-125PEY1E8<br>S-125PT2E5A |  |
| Outdoor side heat exchanger of heat pump:  |  | air                        |  |
| Indoor side heat exchanger of heat pump:   |  | air                        |  |
| Indication if the heater is equipped with a supplementary heater: if applicable: driver of compressor: [electric motor or fuel driven, gaseous or liquid fuel, internal or external combustion engine] |  | electric motor             |  |

Parameters shall be declared for the average heating season, parameters for the warmer and colder heating seasons are optional.

| Item   | Symbol   | Value    | Unit | Item   | Symbol  | Value | Unit                              |
|--|--|----------|------|--|---|-------|-----------------------------------|
| Rated heating capacity   | $P_{rated,h}$  | 12.5     | kW   | Seasonal space heating energy efficiency   | $\eta_{s,h}$  | 140.0 | %                                 |
| Refrigeration load   | $P_{design,h}$   | 12.5     | kW   | Declared coefficient of performance or gas utilization efficiency / auxiliary energy factor for part load at given outdoor temperatures T <sub>J</sub> |   |       |                                   |
| Declared heating capacity for part load at indoor temperature 20 °C and outdoor temperature T <sub>J</sub> |  |          |      |  |   |       |                                   |
|  |  | 11.0     | kW   | T <sub>J</sub> = - 7 °C  |   | 2.1   | %                                 |
|  |  | 6.7      | kW   | T <sub>J</sub> = + 2 °C  |   | 3.4   | %                                 |
|  |  | 4.3      | kW   | T <sub>J</sub> = + 7 °C  |   | 5.3   | %                                 |
|  |  | 4.4      | kW   | T <sub>J</sub> = + 12 °C   |   | 6.5   | %                                 |
|  | $P_{th}$   | 11.0     | kW   | T <sub>br</sub> = bivalent temperature   | COP <sub>d</sub> or GUE <sub>d,brn</sub> / AEF <sub>d,brn</sub> | 2.1   | %                                 |
|  |  | 9.8      | kW   | T <sub>ol</sub> = operation limit  |   | 1.7   | %                                 |
|  |  | -        | kW   | For water-to-air heat pumps: T <sub>J</sub> = - 15 °C (if T <sub>ca</sub> < - 20 °C)   |   | -     | %                                 |
|  |  | -7       | °C   | For water-to-air heat pumps: Operation limit temperature   | T <sub>ol</sub>   | -15   | °C                                |
|  |  | 0.25     | -    | Degradation co- efficient heat pumps**   | C <sub>th</sub>   | -     |                                   |
| Power consumption in modes other than 'active mode'  |  |          |      |  |   |       |                                   |
| Off mode   | $P_{off}$  | 0.020    | kW   | Supplementary heater back-up heating capacity*   | elbu  | 2.0   | kW                                |
| Thermostat-off mode  | $P_{to}$   | 0.101    | kW   | Type of energy input   |   |       |                                   |
| Crankcase heater mode  | $P_{ck}$   | 0.000    | kW   | Standby mode   | $P_{sb}$  | 0.020 | kW                                |
| Other items  |  |          |      |  |   |       |                                   |
| Capacity control   |  | variable |      | For air-to-air heat pumps: air flow rate, outdoor  |   | 4380  | m <sup>3</sup> /h                 |
| Sound power level, outdoor   | $L_{WA}$   | 73.0     | dB   | For water-/brine-to-air heat pumps: Rated brine or water flow rate, outdoor side heat exchanger  |   | -     | m <sup>3</sup> /h                 |
| Sound power level, indoor  | $L_{WA}$   | 64.0     | dB   | Emissions of nitrogen oxides (if applicable)   | NO <sub>x</sub> **  | -     | mg/KWh fuel input GCV             |
|  |  |          |      | GWP of the refrigerant   |   | 2088  | kg CO <sub>2</sub> eq (100 years) |
| Contact details  | Panasonic Testing Centre, Panasonic Marketing Europe GmbH Winsberggring 15, 22625 Hamburg, Germany |          |      |  |   |       |                                   |

\*\* If  $C_{th}$  is not determined by measurement then the default degradation coefficient of heat pumps shall be 0.25.

\*\*\* from 26 September 2018.

Where information relates to multi-split heat pumps, the test result and performance data may be obtained on the basis of the performance of the outdoor unit, with a combination of indoor unit(s) recommended by the manufacturer or importer.

Information requirements for air-to-air air conditioners

Model(s): U-140PEY1E8 Outdoor Unit  
S-140PTZE5A Indoor Unit

Outdoor side heat exchanger of air conditioner: air  
Indoor side heat exchanger of air conditioner: air  
Type: compressor driven vapour compression or sorption process vapour compression  
if applicable: driver of compressor: [electric motor or fuel driven, gaseous or liquid fuel, internal or external combustion engine] electric motor

| Item   | Symbol   | Value    | Unit | Item   | Symbol   | Value | Unit                              |
|--|--|----------|------|--|--|-------|-----------------------------------|
| Rated cooling capacity   | $P_{rated,c}$  | 14.0     | kW   | Seasonal space cooling energy efficiency               | $\eta_{s,c}$   | 206.8 | %                                 |
| Refrigeration load   | $P_{design,c}$   | 14.0     | kW   |  |  |       |                                   |
| Declared cooling capacity for part load at given outdoor temperatures $T_j$ and indoor 27°/19°C (dry/wet bulb)                             |  |          |      |  |  |       |                                   |
|  |  | 14.0     | kW   | $T_j = +35\text{ °C}$                                  |  | 2.9   | %                                 |
|  |  | 10.3     | kW   | $T_j = +30\text{ °C}$                                  | EER <sub>d</sub> or GUE <sub>d,inh</sub> /   | 3.9   | %                                 |
|  | $P_{dc}$   | 6.6      | kW   | $T_j = +25\text{ °C}$                                  | AEF <sub>d,inh</sub>   | 6.4   | %                                 |
|  |  | 5.0      | kW   | $T_j = +20\text{ °C}$                                  |  | 10.1  | %                                 |
| Degradation co- efficient for air conditioners**   | $C_{dc}$   | 0.25     | -    |  |  |       |                                   |
| Declared energy efficiency ratio or gas utilization efficiency / auxiliary energy factor for part load at given outdoor temperatures $T_j$ |  |          |      |  |  |       |                                   |
|  |  | 12.3     | kW   | $T_j = -7\text{ °C}$                                   |  | 2.2   | %                                 |
|  |  | 7.5      | kW   | $T_j = +2\text{ °C}$                                   |  | 3.4   | %                                 |
|  |  | 4.8      | kW   | $T_j = +7\text{ °C}$                                   |  | 5.1   | %                                 |
|  |  | 4.5      | kW   | $T_j = +12\text{ °C}$                                  |  | 6.4   | %                                 |
|  | $T_{biv} =$ bivalent temperature   | 12.3     | kW   |  | $T_{biv} =$ bivalent temperature   | 2.2   | %                                 |
|  | $T_{ol} =$ operation limit   | 9.8      | kW   |  | $T_{ol} =$ operation limit   | 1.6   | %                                 |
|  | For air-to-water heat pumps: $T_j = -15\text{ °C}$ (if $T_{col} < -20\text{ °C}$ )                 | -        | kW   |  | For water-to-air heat pumps: $T_j = -15\text{ °C}$ (if $T_{col} < -20\text{ °C}$ ) | -     | %                                 |
|  | Bivalent temperature   | -7       | °C   |  | For water-to-air heat pumps: Operation limit temperature                           | -15   | °C                                |
|  | Degradation co- efficient heat pumps**   | 0.25     | -    |  | $C_{dh}$   |       |                                   |
| Power consumption in modes other than 'active mode'  |  |          |      |  |  |       |                                   |
| Off mode   | $P_{off}$  | 0.020    | kW   | Crankcase heater mode                                  | $P_{ck}$   | 0.000 | kW                                |
| Thermostat-off mode  | $P_{to}$   | 0.106    | kW   | Standby mode   | $P_{sb}$   | 0.020 | kW                                |
| Other items  |  |          |      |  |  |       |                                   |
| Capacity control   |  | variable |      | For air-to-air air conditioner: air flow rate, outdoor |  | 8100  | m³/h                              |
| Sound power level, outdoor   | $L_{WA}$   | 71.0     | dB   |  |  |       |                                   |
| Sound power level, indoor  | $L_{WA}$   | 65.0     | dB   | if engine driven: Emissions of nitrogen oxides         | NO <sub>x</sub> ***  | -     | mg/kWh fuel input GCV             |
|  |  |          |      | GWP of the refrigerant                                 |  | 2088  | kg CO <sub>2</sub> eq (100 years) |
| Contact details  | Panasonic Testing Centre, Panasonic Marketing Europe GmbH Winsbergiring 15, 22525 Hamburg, Germany |          |      |  |  |       |                                   |

\*\* If  $C_{dc}$  is not determined by measurement then the default degradation coefficient air conditioners shall be 0.25.  
\*\*\* from 26 September 2018.  
Where information relates to multi-split air conditioners, the test result and performance data may be obtained on the basis of the performance of the outdoor unit, with a combination of indoor unit(s) recommended by the manufacturer or importer.

Information requirements for heat pumps

Model(s): U-140PEY1E8 Outdoor Unit  
S-140PTZE5A Indoor Unit

Outdoor side heat exchanger of heat pump: air  
Indoor side heat exchanger of heat pump: air  
Indication if the heater is equipped with a supplementary heater: no  
if applicable: driver of compressor: [electric motor or fuel driven, gaseous or liquid fuel, internal or external combustion engine] electric motor  
Parameters shall be declared for the average heating season, parameters for the warmer and colder heating seasons are optional.

| Item  | Symbol   | Value    | Unit | Item  | Symbol   | Value | Unit                              |
|---|--|----------|------|---|--|-------|-----------------------------------|
| Rated heating capacity  | $P_{rated,h}$  | 14.0     | kW   | Seasonal space heating energy efficiency  | $\eta_{s,h}$   | 139.9 | %                                 |
| Refrigeration load  | $P_{design,h}$   | 14.0     | kW   |   |  |       |                                   |
| Declared heating capacity for part load at indoor temperature 20 °C and outdoor temperature $T_j$ |  |          |      |   |  |       |                                   |
|   |  | 12.3     | kW   | $T_j = -7\text{ °C}$  |  | 2.2   | %                                 |
|   |  | 7.5      | kW   | $T_j = +2\text{ °C}$  |  | 3.4   | %                                 |
|   |  | 4.8      | kW   | $T_j = +7\text{ °C}$  |  | 5.1   | %                                 |
|   |  | 4.5      | kW   | $T_j = +12\text{ °C}$   |  | 6.4   | %                                 |
|   | $T_{biv} =$ bivalent temperature   | 12.3     | kW   |   | $T_{biv} =$ bivalent temperature   | 2.2   | %                                 |
|   | $T_{ol} =$ operation limit   | 9.8      | kW   |   | $T_{ol} =$ operation limit   | 1.6   | %                                 |
|   | For air-to-water heat pumps: $T_j = -15\text{ °C}$ (if $T_{col} < -20\text{ °C}$ )                 | -        | kW   |   | For water-to-air heat pumps: $T_j = -15\text{ °C}$ (if $T_{col} < -20\text{ °C}$ ) | -     | %                                 |
|   | Bivalent temperature   | -7       | °C   |   | For water-to-air heat pumps: Operation limit temperature                           | -15   | °C                                |
|   | Degradation co- efficient heat pumps**   | 0.25     | -    |   | $C_{dh}$   |       |                                   |
| Power consumption in modes other than 'active mode'   |  |          |      |   |  |       |                                   |
| Off mode  | $P_{off}$  | 0.020    | kW   | Supplementary heater back-up heating capacity *   | elbu   | 2.7   | kW                                |
| Thermostat-off mode   | $P_{to}$   | 0.106    | kW   | Type of energy input  |  |       |                                   |
| Crankcase heater mode   | $P_{ck}$   | 0.000    | kW   | Standby mode  | $P_{sb}$   | 0.020 | kW                                |
| Other items   |  |          |      |   |  |       |                                   |
| Capacity control  |  | variable |      | For air-to-air heat pumps: air flow rate, outdoor   |  | 7200  | m³/h                              |
| Sound power level, outdoor  | $L_{WA}$   | 70.0     | dB   | For water-/brine-to-air heat pumps: Rated brine or water flow rate, outdoor side heat exchanger |  | -     | m³/h                              |
| Sound power level, indoor   | $L_{WA}$   | 65.0     | dB   | Emissions of nitrogen oxides (if applicable)  | NO <sub>x</sub> ***  | -     | mg/kWh fuel input GCV             |
|   |  |          |      | GWP of the refrigerant  |  | 2088  | kg CO <sub>2</sub> eq (100 years) |
| Contact details   | Panasonic Testing Centre, Panasonic Marketing Europe GmbH Winsbergiring 15, 22525 Hamburg, Germany |          |      |   |  |       |                                   |

\*\* If  $C_{dh}$  is not determined by measurement then the default degradation coefficient of heat pumps shall be 0.25.  
\*\*\* from 26 September 2018.  
Where information relates to multi-split heat pumps, the test result and performance data may be obtained on the basis of the performance of the outdoor unit, with a combination of indoor unit(s) recommended by the manufacturer or importer.

## Information requirements for air-to-air air conditioners

|   |                             |                              |
|---|-----------------------------|------------------------------|
| Model(s):   | Outdoor Unit<br>Indoor Unit | U-125PEY1E5<br>S-60PF1E5A X2 |
| Outdoor side heat exchanger of air conditioner:   | air                         |                              |
| Indoor side heat exchanger of air conditioner:  | air                         |                              |
| Type: compressor driven vapour compression or sorption process  | vapour compression          |                              |
| if applicable: driver of compressor; electric motor or fuel driven, gaseous or liquid fuel, internal or external combustion engine] | electric motor              |                              |

## Information requirements for heat pumps

|   |                             |                              |
|---|-----------------------------|------------------------------|
| Model(s):   | Outdoor Unit<br>Indoor Unit | U-125PEY1E5<br>S-60PF1E5A X2 |
| Outdoor side heat exchanger of heat pump:   | air                         |                              |
| Indoor side heat exchanger of heat pump:  | air                         |                              |
| Indication if the heater is equipped with a supplementary heater:   | no                          |                              |
| if applicable: driver of compressor; electric motor or fuel driven, gaseous or liquid fuel, internal or external combustion engine] | electric motor              |                              |

Parameters shall be declared for the average heating season, parameters for the warmer and colder heating seasons are optional.

| Item   | Symbol                | Value    | Unit | Item  | Symbol  | Value | Unit                              |
|--|-----------------------|----------|------|---|---|-------|-----------------------------------|
| Rated cooling capacity   | $P_{res,c}$           | 12.5     | kW   | Seasonal space cooling energy efficiency  | $\eta_{s,c}$  | 213.5 | %                                 |
| Refrigeration load   | $P_{design,c}$        | 12.5     | kW   | Declared energy efficiency ratio or gas utilization efficiency / auxiliary energy factor for part load at given outdoor temperatures $T_j$ and indoor 27°/19°C (dry/wet bulb) |   |       |                                   |
| Declared cooling capacity for part load at given outdoor temperatures $T_j$ and indoor 27°/19°C (dry/wet bulb) | $T_j = +35\text{ °C}$ | 12.5     | kW   | $T_j = +35\text{ °C}$   |   | 3.0   | %                                 |
|  | $T_j = +30\text{ °C}$ | 9.2      | kW   | $T_j = +30\text{ °C}$   | EER <sub>d</sub> or GUE <sub>d,br</sub> / AEF <sub>d,br</sub> | 4.5   | %                                 |
|  | $T_j = +25\text{ °C}$ | 5.9      | kW   | $T_j = +25\text{ °C}$   |   | 6.7   | %                                 |
|  | $T_j = +20\text{ °C}$ | 5.1      | kW   | $T_j = +20\text{ °C}$   |   | 8.8   | %                                 |
| Degradation co-efficient for air conditioners**  | $C_{ic}$              | 0.25     | -    |   |   |       |                                   |
| Power consumption in modes other than 'active mode'  |                       |          |      |   |   |       |                                   |
| Off mode   | $P_{OFF}$             | 0.018    | kW   | Crankcase heater mode   | $P_{CK}$  | 0.000 | kW                                |
| Thermostat-off mode  | $P_{TO}$              | 0.090    | kW   | Standby mode  | $P_{SB}$  | 0.018 | kW                                |
| Other items  |                       |          |      |   |   |       |                                   |
| Capacity control   |                       | variable |      | For air-to-air air conditioner: air flow rate, outdoor  |   | 4800  | m³/h                              |
| Sound power level, outdoor   | $L_{WA}$              | 73.0     | dB   |   |   |       |                                   |
| Sound power level, indoor  | $L_{WA}$              | 57.0     | dB   | if engine driven: Emissions of nitrogen oxides  | $NO_x^{***}$  | -     | mg/kWh fuel input GCV             |
|  |                       |          |      | GWP of the refrigerant  |   | 2088  | kg CO <sub>2</sub> eq (100 years) |
| Contact details  |                       |          |      | Panasonic Testing Centre, Panasonic Marketing Europe GmbH Winsberggiring 15, 22525 Hamburg, Germany   |   |       |                                   |

\*\* If  $C_{ic}$  is not determined by measurement then the default degradation coefficient air conditioners shall be 0.25.

\*\*\* from 26 September 2018.

Where information relates to multi-split air conditioners, the test result and performance data may be obtained on the basis of the performance of the outdoor unit, with a combination of indoor unit(s) recommended by the manufacturer or importer.

\*\*\*\* Refer to information requirements for UnitLIst

| Item  | Symbol                | Value    | Unit | Item  | Symbol  | Value | Unit                              |
|---|-----------------------|----------|------|---|---|-------|-----------------------------------|
| Rated heating capacity  | $P_{res,h}$           | 14.0     | kW   | Seasonal space heating energy efficiency  | $\eta_{s,h}$  | 141.6 | %                                 |
| Refrigeration load  | $P_{design,h}$        | 12.5     | kW   | Declared coefficient of performance or gas utilization efficiency / auxiliary energy factor for part load at given outdoor temperatures $T_j$ |   |       |                                   |
| Declared heating capacity for part load at indoor temperature 20 °C and outdoor temperature $T_j$ | $T_j = -7\text{ °C}$  | 11.0     | kW   | $T_j = -7\text{ °C}$  |   | 2.2   | %                                 |
|   | $T_j = +2\text{ °C}$  | 6.7      | kW   | $T_j = +2\text{ °C}$  |   | 3.5   | %                                 |
|   | $T_j = +7\text{ °C}$  | 4.3      | kW   | $T_j = +7\text{ °C}$  |   | 5.1   | %                                 |
|   | $T_j = +12\text{ °C}$ | 4.6      | kW   | $T_j = +12\text{ °C}$   | COP <sub>d</sub> or GUE <sub>d,br</sub> / AEF <sub>d,br</sub> | 6.1   | %                                 |
| $T_{bv} = \text{bivalent temperature}$  | $P_{bh}$              | 11.0     | kW   | $T_{bv} = \text{bivalent temperature}$  |   | 2.2   | %                                 |
| $T_{ol} = \text{operation limit}$   |                       | 9.8      | kW   | $T_{ol} = \text{operation limit}$   |   | 1.7   | %                                 |
| For air-to-water heat pumps: $T_j = -15\text{ °C}$ (if $T_{ol} < -20\text{ °C}$ )                 |                       | -        | kW   | For water-to-air heat pumps: $T_j = -15\text{ °C}$ (if $T_{ol} < -20\text{ °C}$ )   |   | -     | %                                 |
| Bivalent temperature  | $T_{bv}$              | -7       | °C   | For water-to-air heat pumps: Operation limit temperature  | $T_{ol}$  | -15   | °C                                |
| Degradation co-efficient heat pumps**   | $C_{ch}$              | 0.25     | -    |   |   |       |                                   |
| Power consumption in modes other than 'active mode'   |                       |          |      |   |   |       |                                   |
| Off mode  | $P_{OFF}$             | 0.018    | kW   | Supplementary heater  |   |       |                                   |
| Thermostat-off mode   | $P_{TO}$              | 0.090    | kW   | back-up heating capacity *  | elbu  | 2.0   | kW                                |
| Crankcase heater mode   | $P_{CK}$              | 0.000    | kW   | Type of energy input  |   |       |                                   |
| Other items   |                       |          |      |   |   |       |                                   |
| Capacity control  |                       | variable |      | For air-to-air heat pumps: air flow rate, outdoor   |   | 4380  | m³/h                              |
| Sound power level, outdoor  | $L_{WA}$              | 73.0     | dB   | For water-/brine-to-air heat pumps: Rated brine or water flow rate, outdoor side heat exchanger   |   | -     | m³/h                              |
| Sound power level, indoor   | $L_{WA}$              | 57.0     | dB   | Emissions of nitrogen oxides (if applicable)  | $NO_x^{***}$  | -     | mg/kWh fuel input GCV             |
|   |                       |          |      | GWP of the refrigerant  |   | 2088  | kg CO <sub>2</sub> eq (100 years) |
| Contact details   |                       |          |      | Panasonic Testing Centre, Panasonic Marketing Europe GmbH Winsberggiring 15, 22525 Hamburg, Germany   |   |       |                                   |

\*\* If  $C_{ch}$  is not determined by measurement then the default degradation coefficient of heat pumps shall be 0.25.

\*\*\* from 26 September 2018.

Where information relates to multi-split heat pumps, the test result and performance data may be obtained on the basis of the performance of the outdoor unit, with a combination of indoor unit(s) recommended by the manufacturer or importer.

\*\*\*\* Refer to information requirements for UnitLIst

Information requirements for air-to-air air conditioners

Model(s): Outdoor Unit U-125PEY1E5  
Indoor Unit S-125PFI1E5A

Outdoor side heat exchanger of air conditioner: air

Indoor side heat exchanger of air conditioner: air

Type: compressor driven vapour compression or sorption process vapour compression

if applicable: driver of compressor: [electric motor or fuel driven, gaseous or liquid fuel, internal or external combustion engine] electric motor

| Item  | Symbol                | Value    | Unit | Item   | Symbol              | Value | Unit                              |
|---|-----------------------|----------|------|--|---------------------|-------|-----------------------------------|
| Rated cooling capacity  | P <sub>medic</sub>    | 12.5     | kW   | Seasonal space cooling energy efficiency   | η <sub>sc</sub>     | 201.4 | %                                 |
| Refrigeration load  | P <sub>design,c</sub> | 12.5     | kW   | Declared energy efficiency ratio or gas utilization efficiency / auxiliary energy factor for part load at given outdoor temperatures T <sub>J</sub> and indoor 27°/19°C (dry/wet bulb) |                     |       |                                   |
| Declared cooling capacity for part load at given outdoor temperatures T <sub>J</sub> and indoor 27°/19°C (dry/wet bulb) |                       |          |      | Declared energy efficiency ratio or gas utilization efficiency / auxiliary energy factor for part load at given outdoor temperatures T <sub>J</sub>                                    |                     |       |                                   |
| T <sub>J</sub> = + 35 °C  |                       | 12.5     | kW   | T <sub>J</sub> = + 35 °C   |                     | 3.0   | %                                 |
| T <sub>J</sub> = + 30 °C  |                       | 9.2      | kW   | T <sub>J</sub> = + 30 °C   |                     | 4.5   | %                                 |
| T <sub>J</sub> = + 25 °C  | P <sub>dc</sub>       | 5.9      | kW   | T <sub>J</sub> = + 25 °C   |                     | 6.7   | %                                 |
| T <sub>J</sub> = + 20 °C  |                       | 5.1      | kW   | T <sub>J</sub> = + 20 °C   |                     | 8.8   | %                                 |
| Degradation co-efficient for air conditioners**   | C <sub>dc</sub>       | 0.25     | -    | EER <sub>d</sub> or GUE <sub>d,brn</sub> / AEF <sub>d,brn</sub>  |                     |       |                                   |
| Power consumption in modes other than 'active mode'   |                       |          |      | Power consumption in modes other than 'active mode'  |                     |       |                                   |
| Off mode  | P <sub>off</sub>      | 0.018    | kW   | Crankcase heater mode  | P <sub>ck</sub>     | 0.000 | kW                                |
| Thermostat-off mode   | P <sub>to</sub>       | 0.215    | kW   | Standby mode   | P <sub>sb</sub>     | 0.018 | kW                                |
| Other items   |                       |          |      |  |                     |       |                                   |
| Capacity control  |                       | variable |      | For air-to-air conditioner: air flow rate, outdoor   |                     | 4800  | m³/h                              |
| Sound power level, outdoor  | L <sub>WA</sub>       | 73.0     | dB   |  |                     |       |                                   |
| Sound power level, indoor   | L <sub>WA</sub>       | 61.0     | dB   | if engine driven: Emissions of nitrogen oxides   | NO <sub>x</sub> *** | -     | mg/kWh fuel input GCV             |
|   |                       |          |      | GWP of the refrigerant   |                     | 2088  | kg CO <sub>2</sub> eq (100 years) |
| Contact details   |                       |          |      | Panasonic Testing Centre, Panasonic Marketing Europe GmbH Winsberggring 15, 22525 Hamburg, Germany   |                     |       |                                   |

\*\* If C<sub>dc</sub> is not determined by measurement then the default degradation coefficient air conditioners shall be 0.25.  
\*\*\* from 26 September 2018.  
Where information relates to multi-split air conditioners, the test result and performance data may be obtained on the basis of the performance of the outdoor unit, with a combination of indoor unit(s) recommended by the manufacturer or importer.  
\*\*\*\* Refer to Information requirements for UnitList

Information requirements for heat pumps

Model(s): Outdoor Unit U-125PEY1E5  
Indoor Unit S-125PFI1E5A

Outdoor side heat exchanger of heat pump: air

Indoor side heat exchanger of heat pump: air

Indication if the heater is equipped with a supplementary heater: no

if applicable: driver of compressor: [electric motor or fuel driven, gaseous or liquid fuel, internal or external combustion engine] electric motor

Parameters shall be declared for the average heating season, parameters for the warmer and colder heating seasons are optional.

| Item   | Symbol                | Value    | Unit | Item  | Symbol              | Value | Unit                              |
|--|-----------------------|----------|------|---|---------------------|-------|-----------------------------------|
| Rated heating capacity   | P <sub>med,h</sub>    | 14.0     | kW   | Seasonal space heating energy efficiency  | η <sub>h</sub>      | 140.9 | %                                 |
| Refrigeration load   | P <sub>design,h</sub> | 12.5     | kW   | Declared coefficient of performance or gas utilization efficiency / auxiliary energy factor for part load at given outdoor temperatures °C and outdoor temperature T <sub>J</sub> |                     |       |                                   |
| Declared heating capacity for part load at indoor temperature 20 °C and outdoor temperature T <sub>J</sub> |                       |          |      | Declared coefficient of performance or gas utilization efficiency / auxiliary energy factor for part load at given outdoor temperatures °C and outdoor temperature T <sub>J</sub> |                     |       |                                   |
| T <sub>J</sub> = - 7 °C  |                       | 11.0     | kW   | T <sub>J</sub> = - 7 °C   |                     | 2.2   | %                                 |
| T <sub>J</sub> = + 2 °C  |                       | 6.7      | kW   | T <sub>J</sub> = + 2 °C   |                     | 3.5   | %                                 |
| T <sub>J</sub> = + 7 °C  |                       | 4.3      | kW   | T <sub>J</sub> = + 7 °C   |                     | 5.1   | %                                 |
| T <sub>J</sub> = + 12 °C   |                       | 4.6      | kW   | T <sub>J</sub> = + 12 °C  |                     | 6.1   | %                                 |
| T <sub>br</sub> = bivalent temperature   | P <sub>br</sub>       | 11.0     | kW   | T <sub>br</sub> = bivalent temperature  |                     | 2.2   | %                                 |
| T <sub>OL</sub> = operation limit  |                       | 9.8      | kW   | T <sub>OL</sub> = operation limit   |                     | 1.7   | %                                 |
| For air-to-water heat pumps: T <sub>J</sub> = - 15 °C (if T <sub>OL</sub> < - 20 °C)                       |                       | -        | kW   | For water-to-air heat pumps: T <sub>J</sub> = - 15 °C (if T <sub>OL</sub> < - 20 °C)  |                     | -     | %                                 |
| Bivalent temperature   | T <sub>br</sub>       | -7       | °C   | For water-to-air heat pumps: Operation limit temperature  | T <sub>OL</sub>     | -15   | °C                                |
| Degradation co-efficient heat pumps**  | C <sub>dh</sub>       | 0.25     | -    | Supplementary heater  |                     |       |                                   |
| Power consumption in modes other than 'active mode'  |                       |          |      | Supplementary heater  |                     |       |                                   |
| Off mode   | P <sub>off</sub>      | 0.018    | kW   | back-up heating capacity*   | elbu                | 2.0   | kW                                |
| Thermostat-off mode  | P <sub>to</sub>       | 0.215    | kW   | Type of energy input  |                     |       |                                   |
| Crankcase heater mode  | P <sub>ck</sub>       | 0.000    | kW   | Standby mode  | P <sub>sb</sub>     | 0.018 | kW                                |
| Other items  |                       |          |      |   |                     |       |                                   |
| Capacity control   |                       | variable |      | For air-to-air heat pumps: air flow rate, outdoor   |                     | 4380  | m³/h                              |
| Sound power level, outdoor   | L <sub>WA</sub>       | 73.0     | dB   | For water-/brine-to-air heat pumps: Rated brine or water flow rate, outdoor side heat exchanger   |                     | -     | m³/h                              |
| Sound power level, indoor  | L <sub>WA</sub>       | 61.0     | dB   | Emissions of nitrogen oxides (if applicable)  | NO <sub>x</sub> *** | -     | mg/kWh fuel input GCV             |
|  |                       |          |      | GWP of the refrigerant  |                     | 2088  | kg CO <sub>2</sub> eq (100 years) |
| Contact details  |                       |          |      | Panasonic Testing Centre, Panasonic Marketing Europe GmbH Winsberggring 15, 22525 Hamburg, Germany  |                     |       |                                   |

\*\* If C<sub>dh</sub> is not determined by measurement then the default degradation coefficient of heat pumps shall be 0.25.  
\*\*\* from 26 September 2018.  
Where information relates to multi-split heat pumps, the test result and performance data may be obtained on the basis of the performance of the outdoor unit, with a combination of indoor unit(s) recommended by the manufacturer or importer.  
\*\*\*\* Refer to Information requirements for UnitList

## Information requirements for air-to-air air conditioners

|  |                              |
|--|------------------------------|
| Model(s):  | Outdoor Unit<br>Indoor Unit  |
|  | U-125PEY1E8<br>S-60PF1E5A x2 |
| Outdoor side heat exchanger of air conditioner:  | air                          |
| Indoor side heat exchanger of air conditioner:   | air                          |
| Type: compressor driven vapour compression or sorption process   | vapour compression           |
| if applicable: driver of compressor: [electric motor or fuel driven, gaseous or liquid fuel, internal or external combustion engine] | electric motor               |

| Item   | Symbol         | Value    | Unit | Item   | Symbol       | Value | Unit                              |
|--|----------------|----------|------|--|--------------|-------|-----------------------------------|
| Rated cooling capacity   | $P_{med,c}$    | 12.5     | kW   | Seasonal space cooling energy efficiency   | $\eta_{s,c}$ | 212.9 | %                                 |
| Refrigeration load   | $P_{design,c}$ | 12.5     | kW   |  |              |       |                                   |
| Declared cooling capacity for part load at given outdoor temperatures $T_{j}$ and indoor 27°/19°C (dry/wet bulb)                           |                |          |      |  |              |       |                                   |
| $T_j = +35\text{ °C}$  |                | 12.5     | kW   | $T_j = +35\text{ °C}$  |              | 3.0   | %                                 |
| $T_j = +30\text{ °C}$  |                | 9.2      | kW   | $T_j = +30\text{ °C}$  |              | 4.5   | %                                 |
| $T_j = +25\text{ °C}$  | $P_{dc}$       | 5.9      | kW   | $T_j = +25\text{ °C}$  |              | 6.7   | %                                 |
| $T_j = +20\text{ °C}$  |                | 5.1      | kW   | $T_j = +20\text{ °C}$  |              | 8.8   | %                                 |
| Degradation co-efficient for air conditioners**  | $C_{dk}$       | 0.25     | -    |  |              |       |                                   |
| Declared energy efficiency ratio or gas utilization efficiency / auxiliary energy factor for part load at given outdoor temperatures $T_j$ |                |          |      |  |              |       |                                   |
| $T_j = -7\text{ °C}$   |                | 11.0     | kW   | $T_j = -7\text{ °C}$   |              | 2.2   | %                                 |
| $T_j = +2\text{ °C}$   |                | 6.7      | kW   | $T_j = +2\text{ °C}$   |              | 3.5   | %                                 |
| $T_j = +7\text{ °C}$   |                | 4.3      | kW   | $T_j = +7\text{ °C}$   |              | 5.1   | %                                 |
| $T_j = +12\text{ °C}$  |                | 4.6      | kW   | $T_j = +12\text{ °C}$  |              | 6.1   | %                                 |
| $T_{bw} = \text{bivalent temperature}$   | $P_{th}$       | 11.0     | kW   | $T_{bw} = \text{bivalent temperature}$   |              | 2.2   | %                                 |
| $T_{ol} = \text{operation limit}$  |                | 9.8      | kW   | $T_{ol} = \text{operation limit}$  |              | 1.7   | %                                 |
| For air-to-water heat pumps:<br>$T_j = -15\text{ °C}$ (if $T_{ol} < -20\text{ °C}$ )   |                | -        | kW   | For water-to-air heat pumps:<br>$T_{ol} = -15\text{ °C}$ (if $T_{ol} < -20\text{ °C}$ )            |              | -     | %                                 |
| Bivalent temperature   | $T_{bw}$       | -7       | °C   | For water-to-air heat pumps:<br>Operation limit temperature  | $T_{ol}$     | -15   | °C                                |
| Degradation co-efficient heat pumps**  | $C_{dh}$       | 0.25     | -    |  |              |       |                                   |
| Power consumption in modes other than 'active mode'  |                |          |      |  |              |       |                                   |
| Off mode   | $P_{off}$      | 0.021    | kW   | Crankcase heater mode  | $P_{ck}$     | 0.000 | kW                                |
| Thermostat-off mode  | $P_{to}$       | 0.090    | kW   | Standby mode   | $P_{sb}$     | 0.021 | kW                                |
| Other items  |                |          |      |  |              |       |                                   |
| Capacity control   |                | variable |      | For air-to-air conditioner: air flow rate, outdoor   |              | 4800  | m³/h                              |
| Sound power level, outdoor   | $L_{WA}$       | 73.0     | dB   |  |              |       |                                   |
| Sound power level, indoor  | $L_{WA}$       | 57.0     | dB   | if engine driven: Emissions of nitrogen oxides   | $NO_x^{***}$ | -     | mg/kWh fuel input GCV             |
|  |                |          |      | GWP of the refrigerant   |              | 2088  | kg CO <sub>2</sub> eq (100 years) |
| Contact details  |                |          |      | Panasonic Testing Centre, Panasonic Marketing Europe GmbH Winsberggring 15, 22525 Hamburg, Germany |              |       |                                   |

\*\* If  $C_{dk}$  is not determined by measurement then the default degradation coefficient air conditioners shall be 0.25.

\*\*\* from 26 September 2018.

Where information relates to multi-split air conditioners, the test result and performance data may be obtained on the basis of the performance of the outdoor unit, with a combination of indoor unit(s) recommended by the manufacturer or importer.

\*\*\*\* Refer to Information requirements for Unit/List

## Information requirements for heat pumps

|  |                              |
|--|------------------------------|
| Model(s):  | Outdoor Unit<br>Indoor Unit  |
|  | U-125PEY1E8<br>S-60PF1E5A x2 |
| Outdoor side heat exchanger of heat pump:  | air                          |
| Indoor side heat exchanger of heat pump:   | air                          |
| Indication if the heater is equipped with a supplementary heater:  | no                           |
| if applicable: driver of compressor: [electric motor or fuel driven, gaseous or liquid fuel, internal or external combustion engine] | electric motor               |

Parameters shall be declared for the average heating season, parameters for the warmer and colder heating seasons are optional.

| Item  | Symbol         | Value    | Unit | Item   | Symbol       | Value | Unit                              |
|---|----------------|----------|------|--|--------------|-------|-----------------------------------|
| Rated heating capacity  | $P_{med,h}$    | 14.0     | kW   | Seasonal space heating energy efficiency   | $\eta_{p,h}$ | 141.6 | %                                 |
| Refrigeration load  | $P_{design,h}$ | 12.5     | kW   |  |              |       |                                   |
| Declared heating capacity for part load at indoor temperature 20 °C and outdoor temperature $T_j$ |                |          |      |  |              |       |                                   |
| $T_j = -7\text{ °C}$  |                | 11.0     | kW   | $T_j = -7\text{ °C}$   |              | 2.2   | %                                 |
| $T_j = +2\text{ °C}$  |                | 6.7      | kW   | $T_j = +2\text{ °C}$   |              | 3.5   | %                                 |
| $T_j = +7\text{ °C}$  |                | 4.3      | kW   | $T_j = +7\text{ °C}$   |              | 5.1   | %                                 |
| $T_j = +12\text{ °C}$   |                | 4.6      | kW   | $T_j = +12\text{ °C}$  |              | 6.1   | %                                 |
| $T_{bw} = \text{bivalent temperature}$  | $P_{th}$       | 11.0     | kW   | $T_{bw} = \text{bivalent temperature}$   |              | 2.2   | %                                 |
| $T_{ol} = \text{operation limit}$   |                | 9.8      | kW   | $T_{ol} = \text{operation limit}$  |              | 1.7   | %                                 |
| For air-to-water heat pumps:<br>$T_j = -15\text{ °C}$ (if $T_{ol} < -20\text{ °C}$ )              |                | -        | kW   | For water-to-air heat pumps:<br>$T_{ol} = -15\text{ °C}$ (if $T_{ol} < -20\text{ °C}$ )            |              | -     | %                                 |
| Bivalent temperature  | $T_{bw}$       | -7       | °C   | For water-to-air heat pumps:<br>Operation limit temperature  | $T_{ol}$     | -15   | °C                                |
| Degradation co-efficient heat pumps**   | $C_{dh}$       | 0.25     | -    |  |              |       |                                   |
| Power consumption in modes other than 'active mode'   |                |          |      |  |              |       |                                   |
| Off mode  | $P_{off}$      | 0.021    | kW   | Supplementary heater   |              |       |                                   |
| Thermostat-off mode   | $P_{to}$       | 0.090    | kW   | back-up heating capacity*  | elbu         | 2.0   | kW                                |
| Crankcase heater mode   | $P_{ck}$       | 0.000    | kW   | Type of energy input   |              |       |                                   |
| Other items   |                |          |      |  |              |       |                                   |
| Capacity control  |                | variable |      | For air-to-air heat pumps: air flow rate outdoor   |              | 4380  | m³/h                              |
| Sound power level, outdoor  | $L_{WA}$       | 73.0     | dB   | For water-/brine-to-air heat pumps: Rated brine or water flow rate, outdoor side heat exchanger    |              | -     | m³/h                              |
| Sound power level, indoor   | $L_{WA}$       | 57.0     | dB   | Emissions of nitrogen oxides (if applicable)   | $NO_x^{***}$ | -     | mg/kWh fuel input GCV             |
|   |                |          |      | GWP of the refrigerant   |              | 2088  | kg CO <sub>2</sub> eq (100 years) |
| Contact details   |                |          |      | Panasonic Testing Centre, Panasonic Marketing Europe GmbH Winsberggring 15, 22525 Hamburg, Germany |              |       |                                   |

\*\* If  $C_{dh}$  is not determined by measurement then the default degradation coefficient of heat pumps shall be 0.25.

\*\*\* from 26 September 2018.

Where information relates to multi-split heat pumps, the test result and performance data may be obtained on the basis of the performance of the outdoor unit, with a combination of indoor unit(s) recommended by the manufacturer or importer.

\*\*\*\* Refer to Information requirements for Unit/List

### Information requirements for air-to-air air conditioners

|  |                             |                              |
|--|-----------------------------|------------------------------|
| Model(s):  | Outdoor Unit<br>Indoor Unit | U-140PEY1E8<br>S-71PF1E5A x2 |
| Outdoor side heat exchanger of air conditioner:  | air                         |                              |
| Indoor side heat exchanger of air conditioner:   | air                         |                              |
| Type: compressor driven vapour compression or sorption process   | vapour compression          |                              |
| if applicable: driver of compressor: [electric motor or fuel driven, gaseous or liquid fuel, internal or external combustion engine] | electric motor              |                              |

| Item   | Symbol         | Value    | Unit | Item  | Symbol       | Value | Unit                              |
|--|----------------|----------|------|---|--------------|-------|-----------------------------------|
| Rated cooling capacity   | $P_{rated,c}$  | 14.0     | kW   | Seasonal space cooling energy efficiency  | $\eta_{s,c}$ | 221.9 | %                                 |
| Refrigeration load   | $P_{design,c}$ | 14.0     | kW   | Declared energy efficiency ratio or gas utilization efficiency / auxiliary energy factor for part load at given outdoor temperatures $T_j$ and indoor 27°/19°C (dry/wet bulb) |              |       |                                   |
| Declared cooling capacity for part load at given outdoor temperatures $T_j$ and indoor 27°/19°C (dry/wet bulb) |                |          |      |   |              |       |                                   |
| $T_j = +35\text{ °C}$  |                | 14.0     | kW   | $T_j = +35\text{ °C}$   |              | 3.1   | %                                 |
| $T_j = +30\text{ °C}$  |                | 10.3     | kW   | $T_j = +30\text{ °C}$   |              | 4.5   | %                                 |
| $T_j = +25\text{ °C}$  |                | 6.6      | kW   | $T_j = +25\text{ °C}$   |              | 6.9   | %                                 |
| $T_j = +20\text{ °C}$  |                | 5.1      | kW   | $T_j = +20\text{ °C}$   |              | 9.7   | %                                 |
| Degradation co-efficient for air conditioners**  | $C_{dk}$       | 0.25     | -    |   |              |       |                                   |
| Power consumption in modes other than 'active mode'  |                |          |      |   |              |       |                                   |
| Off mode   | $P_{off}$      | 0.024    | kW   | Crankcase heater mode   | $P_{ck}$     | 0.000 | kW                                |
| Thermostat-off mode  | $P_{to}$       | 0.090    | kW   | Standby mode  | $P_{sb}$     | 0.024 | kW                                |
| Other items  |                |          |      |   |              |       |                                   |
| Capacity control   |                | variable |      | For air-to-air conditioner: air flow rate, outdoor  |              | 8100  | m³/h                              |
| Sound power level, outdoor   | $L_{WA}$       | 71.0     | dB   |   |              |       |                                   |
| Sound power level, indoor  | $L_{WA}$       | 57.0     | dB   | if engine driven: Emissions of nitrogen oxides  | $NO_x^{***}$ | -     | mg/kWh fuel input GCV             |
|  |                |          |      | GWP of the refrigerant  |              | 2088  | kg CO <sub>2</sub> eq (100 years) |
| Contact details  |                |          |      | Panasonic Testing Centre, Panasonic Marketing Europe GmbH Winsberggring 15, 22525 Hamburg, Germany  |              |       |                                   |

\*\* If  $C_{dk}$  is not determined by measurement then the default degradation coefficient air conditioners shall be 0.25.  
 \*\*\* from 26 September 2018.  
 Where information relates to multi-split air conditioners, the test result and performance data may be obtained on the basis of the performance of the outdoor unit, with a combination of indoor unit(s) recommended by the manufacturer or importer.  
 \*\*\*\* Refer to Information requirements for Unit/IList

### Information requirements for heat pumps

|  |                             |                              |
|--|-----------------------------|------------------------------|
| Model(s):  | Outdoor Unit<br>Indoor Unit | U-140PEY1E8<br>S-71PF1E5A x2 |
| Outdoor side heat exchanger of heat pump:  | air                         |                              |
| Indoor side heat exchanger of heat pump:   | air                         |                              |
| Indication if the heater is equipped with a supplementary heater:  | no                          |                              |
| if applicable: driver of compressor: [electric motor or fuel driven, gaseous or liquid fuel, internal or external combustion engine] | electric motor              |                              |

Parameters shall be declared for the average heating season, parameters for the warmer and colder heating seasons are optional.

| Item  | Symbol         | Value    | Unit | Item   | Symbol       | Value | Unit                              |
|---|----------------|----------|------|--|--------------|-------|-----------------------------------|
| Rated heating capacity  | $P_{rated,h}$  | 16.0     | kW   | Seasonal space heating energy efficiency   | $\eta_{p,h}$ | 138.6 | %                                 |
| Refrigeration load  | $P_{design,h}$ | 14.0     | kW   | Declared coefficient of performance or gas utilization efficiency / auxiliary energy factor for part load at given outdoor temperatures °C and outdoor temperature $T_j$ |              |       |                                   |
| Declared heating capacity for part load at indoor temperature 20 °C and outdoor temperature $T_j$ |                |          |      |  |              |       |                                   |
| $T_j = -7\text{ °C}$  |                | 12.3     | kW   | $T_j = -7\text{ °C}$   |              | 2.2   | %                                 |
| $T_j = +2\text{ °C}$  |                | 7.5      | kW   | $T_j = +2\text{ °C}$   |              | 3.4   | %                                 |
| $T_j = +7\text{ °C}$  |                | 4.8      | kW   | $T_j = +7\text{ °C}$   |              | 5.0   | %                                 |
| $T_j = +12\text{ °C}$   |                | 4.4      | kW   | $T_j = +12\text{ °C}$  |              | 5.9   | %                                 |
| $T_{bw} = \text{bivalent temperature}$  | $P_{bh}$       | 12.3     | kW   | $T_{bw} = \text{bivalent temperature}$   |              | 2.2   | %                                 |
| $T_{ol} = \text{operation limit}$   |                | 9.8      | kW   | $T_{ol} = \text{operation limit}$  |              | 1.6   | %                                 |
| For air-to-water heat pumps: $T_j = -15\text{ °C}$ (if $T_{ol} < -20\text{ °C}$ )                 |                | -        | kW   | For water-to-air heat pumps: $T_{ol} = -15\text{ °C}$ (if $T_{ol} < -20\text{ °C}$ )   |              | -     | %                                 |
| Bivalent temperature  | $T_{bw}$       | -7       | °C   | For water-to-air heat pumps: Operation limit temperature   | $T_{ol}$     | -15   | °C                                |
| Degradation co-efficient heat pumps**   | $C_{dh}$       | 0.25     | -    |  |              |       |                                   |
| Power consumption in modes other than 'active mode'   |                |          |      |  |              |       |                                   |
| Off mode  | $P_{off}$      | 0.024    | kW   | Supplementary heater   |              |       |                                   |
| Thermostat-off mode   | $P_{to}$       | 0.090    | kW   | back-up heating capacity*  | elbu         | 2.7   | kW                                |
| Crankcase heater mode   | $P_{ck}$       | 0.000    | kW   | Type of energy input   |              |       |                                   |
| Other items   |                |          |      |  |              |       |                                   |
| Capacity control  |                | variable |      | For air-to-air heat pumps: air flow rate outdoor   |              | 7200  | m³/h                              |
| Sound power level, outdoor  | $L_{WA}$       | 70.0     | dB   | For water-/brine-to-air heat pumps: Rated brine or water flow rate, outdoor side heat exchanger  |              | -     | m³/h                              |
| Sound power level, indoor   | $L_{WA}$       | 57.0     | dB   | Emissions of nitrogen oxides (if applicable)   | $NO_x^{***}$ | -     | mg/kWh fuel input GCV             |
|   |                |          |      | GWP of the refrigerant   |              | 2088  | kg CO <sub>2</sub> eq (100 years) |
| Contact details   |                |          |      | Panasonic Testing Centre, Panasonic Marketing Europe GmbH Winsberggring 15, 22525 Hamburg, Germany   |              |       |                                   |

\*\* If  $C_{dh}$  is not determined by measurement then the default degradation coefficient of heat pumps shall be 0.25.  
 \*\*\* from 26 September 2018.  
 Where information relates to multi-split heat pumps, the test result and performance data may be obtained on the basis of the performance of the outdoor unit, with a combination of indoor unit(s) recommended by the manufacturer or importer.  
 \*\*\*\* Refer to Information requirements for Unit/IList



## Information requirements for air-to-air air conditioners

|  |                             |                            |  |
|--|-----------------------------|----------------------------|--|
| Model(s):  | Outdoor Unit<br>Indoor Unit | U-125PEY1E8<br>S-125PF1E5A | air<br>air<br>vapour compression<br>electric motor |
| Outdoor side heat exchanger of air conditioner:<br>Indoor side heat exchanger of air conditioner:<br>Type: compressor driven vapour compression or sorption process<br>if applicable: driver of compressor: electric motor or fuel driven,<br>gaseous or liquid fuel, internal or external combustion engine |                             |                            |  |

| Item   | Symbol                | Value    | Unit | Item  | Symbol  | Value | Unit                              |
|--|-----------------------|----------|------|---|---|-------|-----------------------------------|
| Rated cooling capacity   | $P_{res,c}$           | 12.5     | kW   | Seasonal space cooling energy efficiency  | $\eta_{s,c}$  | 200.8 | %                                 |
| Refrigeration load   | $P_{design,c}$        | 12.5     | kW   | Declared energy efficiency ratio or gas utilization efficiency / auxiliary energy factor for part load at given outdoor temperatures $T_j$ and indoor 27°/19°C (dry/wet bulb) |   |       |                                   |
| Declared cooling capacity for part load at given outdoor temperatures $T_j$ and indoor 27°/19°C (dry/wet bulb) | $T_j = +35\text{ °C}$ | 12.5     | kW   | $T_j = +35\text{ °C}$   | EER <sub>d</sub> or<br>GUE <sub>c,db</sub> /<br>AEF <sub>c,db</sub> | 3.0   | %                                 |
|  | $T_j = +30\text{ °C}$ | 9.2      | kW   | $T_j = +30\text{ °C}$   |   | 4.5   | %                                 |
|  | $T_j = +25\text{ °C}$ | 5.9      | kW   | $T_j = +25\text{ °C}$   |   | 6.7   | %                                 |
|  | $T_j = +20\text{ °C}$ | 5.1      | kW   | $T_j = +20\text{ °C}$   |   | 8.8   | %                                 |
| Degradation co-efficient for air conditioners**  | $C_{dc}$              | 0.25     | -    |   |   |       |                                   |
| Power consumption in modes other than 'active mode'  |                       |          |      |   |   |       |                                   |
| Off mode   | $P_{OFF}$             | 0.021    | kW   | Crankcase heater mode   | $P_{CK}$  | 0.000 | kW                                |
| Thermostat-off mode  | $P_{TO}$              | 0.215    | kW   | Standby mode  | $P_{SB}$  | 0.021 | kW                                |
| Other items  |                       |          |      |   |   |       |                                   |
| Capacity control   |                       | variable |      | For air-to-air air conditioner: air flow rate, outdoor  |   | 4800  | m³/h                              |
| Sound power level, outdoor   | $L_{WA}$              | 73.0     | dB   |   |   |       |                                   |
| Sound power level, indoor  | $L_{WA}$              | 61.0     | dB   | if engine driven: Emissions of nitrogen oxides  | $NO_x^{***}$  | -     | mg/kWh fuel input GCV             |
|  |                       |          |      | GWP of the refrigerant  |   | 2088  | kg CO <sub>2</sub> eq (100 years) |
| Contact details  |                       |          |      | Panasonic Testing Centre, Panasonic Marketing Europe GmbH Winsberggring 15, 22525 Hamburg, Germany  |   |       |                                   |

\*\* If  $C_{dc}$  is not determined by measurement then the default degradation coefficient air conditioners shall be 0.25.

\*\*\* from 26 September 2018.

Where information relates to multi-split air conditioners, the test result and performance data may be obtained on the basis of the performance of the outdoor unit, with a combination of indoor unit(s) recommended by the manufacturer or importer.

\*\*\*\* Refer to Information requirements for UnitList

## Information requirements for heat pumps

|   |                             |                            |                                    |
|---|-----------------------------|----------------------------|------------------------------------|
| Model(s):   | Outdoor Unit<br>Indoor Unit | U-125PEY1E8<br>S-125PF1E5A | air<br>air<br>no<br>electric motor |
| Outdoor side heat exchanger of heat pump:<br>Indoor side heat exchanger of heat pump:<br>Indication if the heater is equipped with a supplementary heater:<br>if applicable: driver of compressor: electric motor or fuel driven,<br>gaseous or liquid fuel, internal or external combustion engine |                             |                            |                                    |
| Parameters shall be declared for the average heating season, parameters for the warmer and colder heating seasons are optional.   |                             |                            |                                    |

| Item  | Symbol                | Value    | Unit | Item  | Symbol  | Value | Unit                              |
|---|-----------------------|----------|------|---|---|-------|-----------------------------------|
| Rated heating capacity  | $P_{he,h}$            | 14.0     | kW   | Seasonal space heating energy efficiency  | $\eta_{h,h}$  | 140.9 | %                                 |
| Refrigeration load  | $P_{design,h}$        | 12.5     | kW   | Declared coefficient of performance or gas utilization efficiency / auxiliary energy factor for part load at given outdoor temperatures $T_j$ |   |       |                                   |
| Declared heating capacity for part load at indoor temperature 20 °C and outdoor temperature $T_j$ | $T_j = -7\text{ °C}$  | 11.0     | kW   | $T_j = -7\text{ °C}$  | COP <sub>d</sub> or<br>GUE <sub>h,db</sub> /<br>AEF <sub>h,db</sub> | 2.2   | %                                 |
|   | $T_j = +2\text{ °C}$  | 6.7      | kW   | $T_j = +2\text{ °C}$  |   | 3.5   | %                                 |
|   | $T_j = +7\text{ °C}$  | 4.3      | kW   | $T_j = +7\text{ °C}$  |   | 5.1   | %                                 |
|   | $T_j = +12\text{ °C}$ | 4.6      | kW   | $T_j = +12\text{ °C}$   |   | 6.1   | %                                 |
| $T_{bw}$ = bivalent temperature   |                       | 11.0     | kW   | $T_{bw}$ = bivalent temperature   |   | 2.2   | %                                 |
| $T_{ol}$ = operation limit  |                       | 9.8      | kW   | $T_{ol}$ = operation limit  |   | 1.7   | %                                 |
| For air-to-water heat pumps:<br>$T_j = -15\text{ °C}$ (if $T_{ol} < -20\text{ °C}$ )              |                       | -        | kW   | For water-to-air heat pumps:<br>$T_j = -15\text{ °C}$ (if $T_{ol} < -20\text{ °C}$ )  |   | -     | %                                 |
| Bivalent temperature  | $T_{bw}$              | -7       | °C   | For water-to-air heat pumps:<br>Operation limit temperature   | $T_{ol}$  | -15   | °C                                |
| Degradation co-efficient heat pumps**   | $C_{dh}$              | 0.25     | -    |   |   |       |                                   |
| Power consumption in modes other than 'active mode'   |                       |          |      |   |   |       |                                   |
| Off mode  | $P_{OFF}$             | 0.021    | kW   | Supplementary heater<br>back-up heating capacity *  | elbu  | 2.0   | kW                                |
| Thermostat-off mode   | $P_{TO}$              | 0.215    | kW   | Type of energy input  |   |       |                                   |
| Crankcase heater mode   | $P_{CK}$              | 0.000    | kW   | Standby mode  | $P_{SB}$  | 0.021 | kW                                |
| Other items   |                       |          |      |   |   |       |                                   |
| Capacity control  |                       | variable |      | For air-to-air heat pumps:<br>air flow rate, outdoor  |   | 4380  | m³/h                              |
| Sound power level, outdoor  | $L_{WA}$              | 73.0     | dB   | For water-/brine-to-air heat pumps: Rated brine or water flow rate, outdoor side heat exchanger   |   | -     | m³/h                              |
| Sound power level, indoor   | $L_{WA}$              | 61.0     | dB   | Emissions of nitrogen oxides (if applicable)  | $NO_x^{***}$  | -     | mg/kWh fuel input GCV             |
|   |                       |          |      | GWP of the refrigerant  |   | 2088  | kg CO <sub>2</sub> eq (100 years) |
| Contact details   |                       |          |      | Panasonic Testing Centre, Panasonic Marketing Europe GmbH Winsberggring 15, 22525 Hamburg, Germany  |   |       |                                   |

\*\* If  $C_{dh}$  is not determined by measurement then the default degradation coefficient of heat pumps shall be 0.25.

\*\*\* from 26 September 2018.

Where information relates to multi-split heat pumps, the test result and performance data may be obtained on the basis of the performance of the outdoor unit, with a combination of indoor unit(s) recommended by the manufacturer or importer.

\*\*\*\* Refer to Information requirements for UnitList

Information requirements for air-to-air air conditioners

Model(s): Outdoor Unit U-140PEY1E8 Indoor Unit S-140PF1E5A

Outdoor side heat exchanger of air conditioner: air

Indoor side heat exchanger of air conditioner: air

Type: compressor driven vapour compression or sorption process vapour compression

if applicable: driver of compressor: electric motor or fuel driven, electric motor

gaseous or liquid fuel, internal or external combustion engine

| Item  | Symbol                   | Value    | Unit | Item   | Symbol  | Value | Unit                              |
|---|--------------------------|----------|------|--|---|-------|-----------------------------------|
| Rated cooling capacity  | P <sub>elec,c</sub>      | 14.0     | kW   | Seasonal space cooling energy efficiency   | η <sub>s,c</sub>  | 209.4 | %                                 |
| Refrigeration load  | P <sub>design,c</sub>    | 14.0     | kW   | Declared energy efficiency ratio or gas utilization efficiency / auxiliary energy factor for part load at given outdoor temperatures T <sub>J</sub> and indoor 27°/19°C (dry/wet bulb) |   |       |                                   |
| Declared cooling capacity for part load at given outdoor temperatures T <sub>J</sub> and indoor 27°/19°C (dry/wet bulb) | T <sub>J</sub> = + 35 °C | 14.0     | kW   | T <sub>J</sub> = + 35 °C   |   | 3.1   | %                                 |
|   | T <sub>J</sub> = + 30 °C | 10.3     | kW   | T <sub>J</sub> = + 30 °C   | EER <sub>d</sub> or GUE <sub>c,db</sub> / AEF <sub>c,db</sub> | 4.5   | %                                 |
|   | T <sub>J</sub> = + 25 °C | 6.6      | kW   | T <sub>J</sub> = + 25 °C   |   | 6.9   | %                                 |
|   | T <sub>J</sub> = + 20 °C | 5.1      | kW   | T <sub>J</sub> = + 20 °C   |   | 9.7   | %                                 |
| Degradation co-efficient for air conditioners**   | C <sub>dc</sub>          | 0.25     | -    |  |   |       |                                   |
| Power consumption in modes other than 'active mode'   |                          |          |      |  |   |       |                                   |
| Off mode  | P <sub>OFF</sub>         | 0.024    | kW   | Crankcase heater mode  | P <sub>CK</sub>   | 0.000 | kW                                |
| Thermostat-off mode   | P <sub>TO</sub>          | 0.223    | kW   | Standby mode   | P <sub>SB</sub>   | 0.024 | kW                                |
| Other items   |                          |          |      |  |   |       |                                   |
| Capacity control  |                          | variable |      | For air-to-air air conditioner: air flow rate, outdoor   |   | 8100  | m³/h                              |
| Sound power level, outdoor  | L <sub>WA</sub>          | 71.0     | dB   |  |   |       |                                   |
| Sound power level, indoor   |                          |          |      | if engine driven: Emissions of nitrogen oxides   | NO <sub>x</sub> ***   | -     | mg/kWh fuel input GCV             |
|   | L <sub>WA</sub>          | 62.0     | dB   | GWP of the refrigerant   |   | 2088  | kg CO <sub>2</sub> eq (100 years) |
| Contact details Panasonic Testing Centre, Panasonic Marketing Europe GmbH Winsberggiring 15, 22525 Hamburg, Germany     |                          |          |      |  |   |       |                                   |

\*\* If C<sub>dc</sub> is not determined by measurement then the default degradation coefficient air conditioners shall be 0.25.  
 \*\*\* from 26 September 2018.  
 Where information relates to multi-split air conditioners, the test result and performance data may be obtained on the basis of the performance of the outdoor unit, with a combination of indoor unit(s) recommended by the manufacturer or importer.  
 \*\*\*\* Refer to information requirements for UnitList

Information requirements for heat pumps

Model(s): Outdoor Unit U-140PEY1E8 Indoor Unit S-140PF1E5A

Outdoor side heat exchanger of heat pump: air

Indoor side heat exchanger of heat pump: air

Indication if the heater is equipped with a supplementary heater: no

if applicable: driver of compressor: electric motor or fuel driven, electric motor

gaseous or liquid fuel, internal or external combustion engine

Parameters shall be declared for the average heating season, parameters for the warmer and colder heating seasons are optional.

| Item  | Symbol                   | Value    | Unit | Item   | Symbol  | Value | Unit                              |
|---|--------------------------|----------|------|--|---|-------|-----------------------------------|
| Rated heating capacity  | P <sub>elec,h</sub>      | 16.0     | kW   | Seasonal space heating energy efficiency   | η <sub>s,h</sub>  | 138.0 | %                                 |
| Refrigeration load  | P <sub>design,h</sub>    | 14.0     | kW   | Declared coefficient of performance or gas utilization efficiency / auxiliary energy factor for part load at given outdoor temperatures T <sub>J</sub> |   |       |                                   |
| Declared heating capacity for part load at indoor temperature 20 °C and outdoor temperature T <sub>J</sub>          | T <sub>J</sub> = - 7 °C  | 12.3     | kW   | T <sub>J</sub> = - 7 °C  |   | 2.2   | %                                 |
|   | T <sub>J</sub> = + 2 °C  | 7.5      | kW   | T <sub>J</sub> = + 2 °C  |   | 3.4   | %                                 |
|   | T <sub>J</sub> = + 7 °C  | 4.8      | kW   | T <sub>J</sub> = + 7 °C  |   | 5.0   | %                                 |
|   | T <sub>J</sub> = + 12 °C | 4.4      | kW   | T <sub>J</sub> = + 12 °C   | COP <sub>d</sub> or GUE <sub>h,db</sub> / AEF <sub>h,db</sub> | 5.9   | %                                 |
| T <sub>bw</sub> = bivalent temperature  |                          | 12.3     | kW   | T <sub>bw</sub> = bivalent temperature   |   | 2.2   | %                                 |
| T <sub>ol</sub> = operation limit   |                          | 9.8      | kW   | T <sub>ol</sub> = operation limit  |   | 1.6   | %                                 |
| For air-to-water heat pumps: T <sub>J</sub> = - 15 °C (if T <sub>ol</sub> < - 20 °C)                                |                          | -        | kW   | For water-to-air heat pumps: T <sub>J</sub> = - 15 °C (if T <sub>ol</sub> < - 20 °C)   |   | -     | %                                 |
| Bivalent temperature  | T <sub>bw</sub>          | -7       | °C   | For water-to-air heat pumps: Operation limit temperature   | T <sub>ol</sub>   | -15   | °C                                |
| Degradation co-efficient heat pumps**   | C <sub>dh</sub>          | 0.25     | -    |  |   |       |                                   |
| Power consumption in modes other than 'active mode'   |                          |          |      |  |   |       |                                   |
| Off mode  | P <sub>OFF</sub>         | 0.024    | kW   | Supplementary heater   |   |       |                                   |
| Thermostat-off mode   | P <sub>TO</sub>          | 0.223    | kW   | back-up heating capacity *   | elbu  | 2.7   | kW                                |
| Crankcase heater mode   | P <sub>CK</sub>          | 0.000    | kW   | Type of energy input   |   |       |                                   |
| Other items   |                          |          |      |  |   |       |                                   |
| Capacity control  |                          | variable |      | For air-to-air heat pumps: air flow rate, outdoor  |   | 7200  | m³/h                              |
| Sound power level, outdoor  | L <sub>WA</sub>          | 70.0     | dB   | For water-/brine-to-air heat pumps: Rated brine or water flow rate, outdoor side heat exchanger  |   | -     | m³/h                              |
| Sound power level, indoor   |                          |          |      | Emissions of nitrogen oxides (if applicable)   | NO <sub>x</sub> ***   | -     | mg/kWh fuel input GCV             |
|   | L <sub>WA</sub>          | 62.0     | dB   | GWP of the refrigerant   |   | 2088  | kg CO <sub>2</sub> eq (100 years) |
| Contact details Panasonic Testing Centre, Panasonic Marketing Europe GmbH Winsberggiring 15, 22525 Hamburg, Germany |                          |          |      |  |   |       |                                   |

\*\* If C<sub>dh</sub> is not determined by measurement then the default degradation coefficient of heat pumps shall be 0.25.  
 \*\*\* from 26 September 2018.  
 Where information relates to multi-split heat pumps, the test result and performance data may be obtained on the basis of the performance of the outdoor unit, with a combination of indoor unit(s) recommended by the manufacturer or importer.  
 \*\*\*\* Refer to information requirements for UnitList

## Information requirements for air-to-air air conditioners

|  |                             |                              |
|--|-----------------------------|------------------------------|
| Model(s):  | Outdoor Unit<br>Indoor Unit | U-125PEY1E5<br>S-60PN1E5A x2 |
| Outdoor side heat exchanger of air conditioner:  | air                         |                              |
| Indoor side heat exchanger of air conditioner:   | air                         |                              |
| Type: compressor driven vapour compression or sorption process   | vapour compression          |                              |
| if applicable: driver of compressor: [electric motor or fuel driven, gaseous or liquid fuel, internal or external combustion engine] | electric motor              |                              |

## Information requirements for heat pumps

|  |                             |                              |
|--|-----------------------------|------------------------------|
| Model(s):  | Outdoor Unit<br>Indoor Unit | U-125PEY1E5<br>S-60PN1E5A x2 |
| Outdoor side heat exchanger of heat pump:  | air                         |                              |
| Indoor side heat exchanger of heat pump:   | air                         |                              |
| Indication if the heater is equipped with a supplementary heater:  | no                          |                              |
| if applicable: driver of compressor: [electric motor or fuel driven, gaseous or liquid fuel, internal or external combustion engine] | electric motor              |                              |
| Parameters shall be declared for the average heating season, parameters for the warmer and colder heating seasons are optional.      |                             |                              |

| Item   | Symbol         | Value    | Unit | Item   | Symbol       | Value | Unit                              |
|--|----------------|----------|------|--|--------------|-------|-----------------------------------|
| Rated cooling capacity   | $P_{rated,c}$  | 12.5     | kW   | Seasonal space cooling energy efficiency   | $\eta_{s,c}$ | 206.9 | %                                 |
| Refrigeration load   | $P_{design,h}$ | 12.5     | kW   | Declared energy efficiency ratio or gas utilization efficiency / auxiliary energy factor for part load at given outdoor temperatures $T_j$ |              |       |                                   |
| Declared cooling capacity for part load at given outdoor temperatures $T_j$ and indoor 27°/19°C (dry/wet bulb) |                |          |      |  |              |       |                                   |
| $T_j = +35\text{ °C}$  |                | 12.5     | kW   | $T_j = +35\text{ °C}$  |              | 2.8   | %                                 |
| $T_j = +30\text{ °C}$  |                | 9.2      | kW   | $T_j = +30\text{ °C}$  |              | 4.2   | %                                 |
| $T_j = +25\text{ °C}$  |                | 5.9      | kW   | $T_j = +25\text{ °C}$  |              | 6.5   | %                                 |
| $T_j = +20\text{ °C}$  |                | 5.2      | kW   | $T_j = +20\text{ °C}$  |              | 8.8   | %                                 |
| Degradation co-efficient for air conditioners**  | $C_{dc}$       | 0.25     | -    | Power consumption in modes other than 'active mode'  |              |       |                                   |
| Off mode   |                |          |      |  |              |       |                                   |
| Off mode   | $P_{off}$      | 0.018    | kW   | Crankcase heater mode  | $P_{ck}$     | 0.000 | kW                                |
| Thermostat-off mode  | $P_{to}$       | 0.075    | kW   | Standby mode   | $P_{sb}$     | 0.018 | kW                                |
| Other items  |                |          |      |  |              |       |                                   |
| Capacity control   |                | variable |      | For air-to-air conditioner: air flow rate, outdoor   |              | 2825  | m <sup>3</sup> /h                 |
| Sound power level, outdoor   | $L_{WA}$       | 73.0     | dB   |  |              |       |                                   |
| Sound power level, indoor  | $L_{WA}$       | 60.0     | dB   | if engine driven: Emissions of nitrogen oxides   | $NO_x^{***}$ | -     | mg/kWh fuel input GCV             |
|  |                |          |      | GWP of the refrigerant   |              | 2088  | kg CO <sub>2</sub> eq (100 years) |
| Contact details  |                |          |      | Panasonic Testing Centre, Panasonic Marketing Europe GmbH Winsbergiring 15, 22525 Hamburg, Germany   |              |       |                                   |

\*\* If  $C_{dc}$  is not determined by measurement then the default degradation coefficient air conditioners shall be 0.25.

\*\*\* from 26 September 2018.

Where information relates to multi-split air conditioners, the test result and performance data may be obtained on the basis of the performance of the outdoor unit, with a combination of indoor unit(s) recommended by the manufacturer or importer.

\*\*\*\* Refer to Information requirements for UnitLi18t

| Item  | Symbol         | Value    | Unit | Item  | Symbol       | Value | Unit                              |
|---|----------------|----------|------|---|--------------|-------|-----------------------------------|
| Rated heating capacity  | $P_{rated,h}$  | 12.5     | kW   | Seasonal space heating energy efficiency  | $\eta_{s,h}$ | 138.5 | %                                 |
| Refrigeration load  | $P_{design,h}$ | 12.5     | kW   | Declared coefficient of performance or gas utilization efficiency / auxiliary energy factor for part load at given outdoor temperatures $T_j$ |              |       |                                   |
| Declared heating capacity for part load at indoor temperature 20 °C and outdoor temperature $T_j$ |                |          |      |   |              |       |                                   |
| $T_j = -7\text{ °C}$  |                | 11.0     | kW   | $T_j = -7\text{ °C}$  |              | 2.4   | %                                 |
| $T_j = +2\text{ °C}$  |                | 6.7      | kW   | $T_j = +2\text{ °C}$  |              | 3.3   | %                                 |
| $T_j = +7\text{ °C}$  |                | 4.3      | kW   | $T_j = +7\text{ °C}$  |              | 5.0   | %                                 |
| $T_j = +12\text{ °C}$   |                | 4.4      | kW   | $T_j = +12\text{ °C}$   |              | 5.7   | %                                 |
| $T_{bv} = \text{bivalent temperature}$  | $P_{bh}$       | 11.0     | kW   | $T_{bv} = \text{bivalent temperature}$  |              | 2.4   | %                                 |
| $T_{ol} = \text{operation limit}$   |                | 9.8      | kW   | $T_{ol} = \text{operation limit}$   |              | 1.6   | %                                 |
| For air-to-water heat pumps: $T_j = -15\text{ °C}$ (if $T_{ol} < -20\text{ °C}$ )                 |                | -        | kW   | For water-to-air heat pumps: $T_{ol} = -15\text{ °C}$ (if $T_{ol} < -20\text{ °C}$ )  |              | -     | %                                 |
| Bivalent temperature  | $T_{bv}$       | -7       | °C   | For water-to-air heat pumps: Operation limit temperature  | $T_{ol}$     | -15   | °C                                |
| Degradation co-efficient heat pumps**   | $C_{dh}$       | 0.25     | -    | Supplementary heater  |              |       |                                   |
| Power consumption in modes other than 'active mode'   |                |          |      |   |              |       |                                   |
| Off mode  | $P_{off}$      | 0.018    | kW   | back-up heating capacity *  | $e_{ibu}$    | 2.0   | kW                                |
| Thermostat-off mode   | $P_{to}$       | 0.075    | kW   | Type of energy input  |              |       |                                   |
| Crankcase heater mode   | $P_{ck}$       | 0.000    | kW   | Standby mode  | $P_{sb}$     | 0.018 | kW                                |
| Other items   |                |          |      |   |              |       |                                   |
| Capacity control  |                | variable |      | For air-to-air heat pumps: air flow rate, outdoor   |              | 2578  | m <sup>3</sup> /h                 |
| Sound power level, outdoor  | $L_{WA}$       | 73.0     | dB   | For water-/brine-to-air heat pumps: Rated brine or water flow rate, outdoor side heat exchanger   |              | -     | m <sup>3</sup> /h                 |
| Sound power level, indoor   | $L_{WA}$       | 60.0     | dB   | Emissions of nitrogen oxides (if applicable)  | $NO_x^{***}$ | -     | mg/kWh fuel input GCV             |
|   |                |          |      | GWP of the refrigerant  |              | 2088  | kg CO <sub>2</sub> eq (100 years) |
| Contact details   |                |          |      | Panasonic Testing Centre, Panasonic Marketing Europe GmbH Winsbergiring 15, 22525 Hamburg, Germany  |              |       |                                   |

\*\* If  $C_{dh}$  is not determined by measurement then the default degradation coefficient of heat pumps shall be 0.25.

\*\*\* from 26 September 2018.

Where information relates to multi-split heat pumps, the test result and performance data may be obtained on the basis of the performance of the outdoor unit, with a combination of indoor unit(s) recommended by the manufacturer or importer.

\*\*\*\* Refer to Information requirements for UnitLi18t

## Information requirements for air-to-air air conditioners

|  |                             |
|--|-----------------------------|
| Model(s):  | Outdoor Unit<br>Indoor Unit |
|  | U-125PEY1E5<br>S-125PN1E5A  |
| Outdoor side heat exchanger of air conditioner:  | air                         |
| Indoor side heat exchanger of air conditioner:   | air                         |
| Type: compressor driven vapour compression or sorption process   | vapour compression          |
| if applicable: driver of compressor: [electric motor or fuel driven, gaseous or liquid fuel, internal or external combustion engine] | electric motor              |

| Item   | Symbol         | Value    | Unit | Item   | Symbol                                    | Value | Unit                              |
|--|----------------|----------|------|--|---|-------|-----------------------------------|
| Rated cooling capacity   | $P_{medic}$    | 12.5     | kW   | Seasonal space cooling energy efficiency   | $\eta_{sc}$                               | 195.0 | %                                 |
| Refrigeration load   | $P_{design,c}$ | 12.5     | kW   |  |   |       |                                   |
| Declared cooling capacity for part load at given outdoor temperatures $T_j$ and indoor 27%/19°C (dry/wet bulb)                             |                |          |      |  |   |       |                                   |
| $T_j = +35\text{ °C}$  |                | 12.5     | kW   | $T_j = +35\text{ °C}$  |   | 2.8   | %                                 |
| $T_j = +30\text{ °C}$  |                | 9.2      | kW   | $T_j = +30\text{ °C}$  |   | 4.2   | %                                 |
| $T_j = +25\text{ °C}$  | $P_{dc}$       | 5.9      | kW   | $T_j = +25\text{ °C}$  | $EER_c$ or $GUE_{c,bn}$ / $A_{EF}_{c,bn}$ | 6.5   | %                                 |
| $T_j = +20\text{ °C}$  |                | 5.2      | kW   | $T_j = +20\text{ °C}$  |   | 8.8   | %                                 |
| Degradation co-efficient for air conditioners**  | $C_{dc}$       | 0.25     | -    |  |   |       |                                   |
| Declared energy efficiency ratio or gas utilization efficiency / auxiliary energy factor for part load at given outdoor temperatures $T_j$ |                |          |      |  |   |       |                                   |
|  |                |          |      |  |   |       |                                   |
|  |                |          |      |  |   |       |                                   |
|  |                |          |      |  |   |       |                                   |
|  |                |          |      |  |   |       |                                   |
|  |                |          |      |  |   |       |                                   |
| Power consumption in modes other than 'active mode'  |                |          |      |  |   |       |                                   |
| Off mode   | $P_{off}$      | 0.018    | kW   | Crankcase heater mode  | $P_{ck}$                                  | 0.000 | kW                                |
| Thermostat-off mode  | $P_{to}$       | 0.205    | kW   | Standby mode   | $P_{sb}$                                  | 0.018 | kW                                |
| Other items  |                |          |      |  |   |       |                                   |
| Capacity control   |                | variable |      | For air-to-air conditioner: air flow rate, outdoor   |   | 2825  | m <sup>3</sup> /h                 |
| Sound power level, outdoor   | $L_{WA}$       | 73.0     | dB   |  |   |       |                                   |
| Sound power level, indoor  | $L_{WA}$       | 66.0     | dB   | if engine driven: Emissions of nitrogen oxides   | $NO_x^{***}$                              | -     | mg/kWh fuel input GCV             |
|  |                |          |      | GWP of the refrigerant   |   | 2088  | kg CO <sub>2</sub> eq (100 years) |
| Contact details  |                |          |      | Panasonic Testing Centre, Panasonic Marketing Europe GmbH Winsberggring 15, 22525 Hamburg, Germany |   |       |                                   |

\*\* If  $C_{dc}$  is not determined by measurement then the default degradation coefficient air conditioners shall be 0.25.

\*\*\* from 26 September 2018.

Where information relates to multi-split air conditioners, the test result and performance data may be obtained on the basis of the performance of the outdoor unit, with a combination of indoor unit(s) recommended by the manufacturer or importer.

\*\*\*\* Refer to Information requirements for UnitList

## Information requirements for heat pumps

|  |                             |
|--|-----------------------------|
| Model(s):  | Outdoor Unit<br>Indoor Unit |
|  | U-125PEY1E5<br>S-125PN1E5A  |
| Outdoor side heat exchanger of heat pump:  | air                         |
| Indoor side heat exchanger of heat pump:   | air                         |
| Indication if the heater is equipped with a supplementary heater:  | no                          |
| if applicable: driver of compressor: [electric motor or fuel driven, gaseous or liquid fuel, internal or external combustion engine] | electric motor              |

Parameters shall be declared for the average heating season, parameters for the warmer and colder heating seasons are optional.

| Item  | Symbol         | Value    | Unit | Item   | Symbol   | Value | Unit                              |
|---|----------------|----------|------|--|--|-------|-----------------------------------|
| Rated heating capacity  | $P_{med,h}$    | 12.5     | kW   | Seasonal space heating energy efficiency   | $\eta_{sh}$  | 137.8 | %                                 |
| Refrigeration load  | $P_{design,h}$ | 12.5     | kW   |  |  |       |                                   |
| Declared heating capacity for part load at indoor temperature 20 °C and outdoor temperature $T_j$ |                |          |      |  |  |       |                                   |
| $T_j = -7\text{ °C}$  |                | 11.0     | kW   | $T_j = -7\text{ °C}$   |  | 2.4   | %                                 |
| $T_j = +2\text{ °C}$  |                | 6.7      | kW   | $T_j = +2\text{ °C}$   |  | 3.3   | %                                 |
| $T_j = +7\text{ °C}$  |                | 4.3      | kW   | $T_j = +7\text{ °C}$   |  | 5.0   | %                                 |
| $T_j = +12\text{ °C}$   |                | 4.4      | kW   | $T_j = +12\text{ °C}$  | COP <sub>s</sub> or $GUE_{h,bn}$ / $A_{EF}_{h,bn}$ | 5.7   | %                                 |
| $T_{bw} = \text{bivalent temperature}$  | $P_{bh}$       | 11.0     | kW   | $T_{bw} = \text{bivalent temperature}$   |  | 2.4   | %                                 |
| $T_{ol} = \text{operation limit}$   |                | 9.8      | kW   | $T_{ol} = \text{operation limit}$  |  | 1.6   | %                                 |
| For air-to-water heat pumps: $T_j = -15\text{ °C}$ (if $T_{ol} < -20\text{ °C}$ )                 |                | -        | kW   | For water-to-air heat pumps: $T_j = -15\text{ °C}$ (if $T_{ol} < -20\text{ °C}$ )                  |  | -     | %                                 |
| Bivalent temperature  | $T_{bw}$       | -7       | °C   | For water-to-air heat pumps: Operation limit temperature   | $T_{ol}$   | -15   | °C                                |
| Degradation co-efficient heat pumps**   | $C_{bh}$       | 0.25     | -    |  |  |       |                                   |
| Power consumption in modes other than 'active mode'   |                |          |      |  |  |       |                                   |
| Off mode  | $P_{off}$      | 0.018    | kW   | back-up heating capacity*  | $elbu$   | 2.0   | kW                                |
| Thermostat-off mode   | $P_{to}$       | 0.205    | kW   | Type of energy input   |  |       |                                   |
| Crankcase heater mode   | $P_{ck}$       | 0.000    | kW   | Standby mode   | $P_{sb}$   | 0.018 | kW                                |
| Other items   |                |          |      |  |  |       |                                   |
| Capacity control  |                | variable |      | For air-to-air heat pumps: air flow rate, outdoor  |  | 2578  | m <sup>3</sup> /h                 |
| Sound power level, outdoor  | $L_{WA}$       | 73.0     | dB   | For water-/brine-to-air heat pumps: Rated brine or water flow rate, outdoor side heat exchanger    |  | -     | m <sup>3</sup> /h                 |
| Sound power level, indoor   | $L_{WA}$       | 66.0     | dB   | Emissions of nitrogen oxides (if applicable)   | $NO_x^{***}$                                       | -     | mg/kWh fuel input GCV             |
|   |                |          |      | GWP of the refrigerant   |  | 2088  | kg CO <sub>2</sub> eq (100 years) |
| Contact details   |                |          |      | Panasonic Testing Centre, Panasonic Marketing Europe GmbH Winsberggring 15, 22525 Hamburg, Germany |  |       |                                   |

\*\* If  $C_{bh}$  is not determined by measurement then the default degradation coefficient of heat pumps shall be 0.25.

\*\*\* from 26 September 2018.

Where information relates to multi-split heat pumps, the test result and performance data may be obtained on the basis of the performance of the outdoor unit, with a combination of indoor unit(s) recommended by the manufacturer or importer.

\*\*\*\* Refer to Information requirements for UnitList

## Information requirements for air-to-air air conditioners

|   |                             |                              |
|---|-----------------------------|------------------------------|
| Model(s):   | Outdoor Unit<br>Indoor Unit | U-125PEY1E8<br>S-60PN1E5A x2 |
| Outdoor side heat exchanger of air conditioner:   | air                         |                              |
| Indoor side heat exchanger of air conditioner:  | air                         |                              |
| Type: compressor driven vapour compression or sorption process if applicable: driver of compressor: [electric motor or fuel driven, gaseous or liquid fuel, internal or external combustion engine] | vapour compression          |                              |
|   | electric motor              |                              |

| Item   | Symbol         | Value    | Unit | Item   | Symbol   | Value | Unit                              |
|--|----------------|----------|------|--|--|-------|-----------------------------------|
| Rated cooling capacity   | $P_{amb,c}$    | 12.5     | kW   | Seasonal space cooling energy efficiency   | $\eta_{s,c}$   | 206.9 | %                                 |
| Refrigeration load   | $P_{design,c}$ | 12.5     | kW   | Declared energy efficiency ratio or gas utilization efficiency /auxiliary energy factor for part load at given outdoor temperatures $T_j$ and indoor: 27/19°C (dry/wet bulb) |  |       |                                   |
| Declared cooling capacity for part load at given outdoor temperatures $T_j$ and indoor: 27/19°C (dry/wet bulb) |                |          |      |  |  |       |                                   |
| $T_j = +35\text{ }^\circ\text{C}$  |                | 12.5     | kW   | $T_j = +35\text{ }^\circ\text{C}$  |  | 2.8   | %                                 |
| $T_j = +30\text{ }^\circ\text{C}$  |                | 9.2      | kW   | $T_j = +30\text{ }^\circ\text{C}$  | EER <sub>td</sub> or GUE <sub>td,br</sub> / AEF <sub>td,br</sub> | 4.2   | %                                 |
| $T_j = +25\text{ }^\circ\text{C}$  | $P_{dc}$       | 5.9      | kW   | $T_j = +25\text{ }^\circ\text{C}$  |  | 6.5   | %                                 |
| $T_j = +20\text{ }^\circ\text{C}$  |                | 5.2      | kW   | $T_j = +20\text{ }^\circ\text{C}$  |  | 8.8   | %                                 |
| Degradation co-efficient for air conditioners**  | $C_{dc}$       | 0.25     | -    |  |  |       |                                   |
| Power consumption in modes other than 'active mode'  |                |          |      |  |  |       |                                   |
| Off mode   | $P_{off}$      | 0.018    | kW   | Crankcase heater mode  | $P_{ck}$   | 0.000 | kW                                |
| Thermostat-off mode  | $P_{to}$       | 0.075    | kW   | Standby mode   | $P_{sb}$   | 0.018 | kW                                |
| Other items  |                |          |      |  |  |       |                                   |
| Capacity control   |                | variable |      | For air-to-air conditioner: air flow rate, outdoor   |  | 2825  | m <sup>3</sup> /h                 |
| Sound power level, outdoor   | $L_{wa}$       | 73.0     | dB   |  |  |       |                                   |
| Sound power level, indoor  | $L_{wa}$       | 60.0     | dB   | if engine driven: Emissions of nitrogen oxides   | NO <sub>x</sub> ***  | -     | mg/kWh fuel input GCV             |
|  |                |          |      | GWP of the refrigerant   |  | 2088  | kg CO <sub>2</sub> eq (100 years) |
| Contact details  |                |          |      | Panasonic Testing Centre, Panasonic Marketing Europe GmbH Winsberggring 15, 22525 Hamburg, Germany   |  |       |                                   |

\*\* If  $C_{dc}$  is not determined by measurement then the default degradation coefficient air conditioners shall be 0.25.

\*\*\* from 26 September 2018.

Where information relates to multi-split air conditioners, the test result and performance data may be obtained on the basis of the performance of the outdoor unit, with a combination of indoor unit(s) recommended by the manufacturer or importer.

\*\*\*\* Refer to Information requirements for UnitList

## Information requirements for heat pumps

|  |                             |                              |
|--|-----------------------------|------------------------------|
| Model(s):  | Outdoor Unit<br>Indoor Unit | U-125PEY1E8<br>S-60PN1E5A x2 |
| Outdoor side heat exchanger of heat pump:  | air                         |                              |
| Indoor side heat exchanger of heat pump:   | air                         |                              |
| Indication if the heater is equipped with a supplementary heater: if applicable: driver of compressor: [electric motor or fuel driven, gaseous or liquid fuel, internal or external combustion engine] | no                          |                              |
| Parameters shall be declared for the average heating season, parameters for the warmer and colder heating seasons are optional.  | electric motor              |                              |

| Item  | Symbol         | Value    | Unit | Item  | Symbol  | Value | Unit                              |
|---|----------------|----------|------|---|---|-------|-----------------------------------|
| Rated heating capacity  | $P_{amb,h}$    | 12.5     | kW   | Seasonal space heating energy efficiency  | $\eta_{s,h}$  | 138.5 | %                                 |
| Refrigeration load  | $P_{design,h}$ | 12.5     | kW   | Declared coefficient of performance or gas utilization efficiency / auxiliary energy factor for part load at given outdoor temperatures $T_j$ and outdoor temperature $T_j$ |   |       |                                   |
| Declared heating capacity for part load at indoor temperature 20 °C and outdoor temperature $T_j$         |                |          |      |   |   |       |                                   |
| $T_j = -7\text{ }^\circ\text{C}$  |                | 11.0     | kW   | $T_j = -7\text{ }^\circ\text{C}$  |   | 2.4   | %                                 |
| $T_j = +2\text{ }^\circ\text{C}$  |                | 6.7      | kW   | $T_j = +2\text{ }^\circ\text{C}$  |   | 3.3   | %                                 |
| $T_j = +7\text{ }^\circ\text{C}$  |                | 4.3      | kW   | $T_j = +7\text{ }^\circ\text{C}$  |   | 5.0   | %                                 |
| $T_j = +12\text{ }^\circ\text{C}$   |                | 4.4      | kW   | $T_j = +12\text{ }^\circ\text{C}$   |   | 5.7   | %                                 |
| $T_{bw}$ = bivalent temperature   | $P_{bh}$       | 11.0     | kW   | $T_{bw}$ = bivalent temperature   | COP <sub>s</sub> or GUE <sub>s,br</sub> / AEF <sub>s,br</sub> | 2.4   | %                                 |
| $T_{ol}$ = operation limit  |                | 9.8      | kW   | $T_{ol}$ = operation limit  |   | 1.6   | %                                 |
| For air-to-water heat pumps: $T_j = -15\text{ }^\circ\text{C}$ (if $T_{Ox} < -20\text{ }^\circ\text{C}$ ) |                | -        | kW   | For water-to-air heat pumps: $T_j = -15\text{ }^\circ\text{C}$ (if $T_{Ox} < -20\text{ }^\circ\text{C}$ )   |   | -     | %                                 |
| Bivalent temperature  | $T_{bw}$       | -7       | °C   | For water-to-air heat pumps: Operation limit temperature  | $T_{ol}$  | -15   | °C                                |
| Degradation co-efficient heat pumps**   | $C_{bh}$       | 0.25     | -    |   |   |       |                                   |
| Power consumption in modes other than 'active mode'   |                |          |      |   |   |       |                                   |
| Off mode  | $P_{off}$      | 0.018    | kW   | Supplementary heater  |   |       |                                   |
| Thermostat-off mode   | $P_{to}$       | 0.075    | kW   | back-up heating capacity *  | elbu  | 2.0   | kW                                |
| Crankcase heater mode   | $P_{ck}$       | 0.000    | kW   | Type of energy input  |   |       |                                   |
| Other items   |                |          |      |   |   |       |                                   |
| Capacity control  |                | variable |      | For air-to-air heat pumps: air flow rate, outdoor   |   | 2578  | m <sup>3</sup> /h                 |
| Sound power level, outdoor  | $L_{wa}$       | 73.0     | dB   | For water-/brine-to-air heat pumps: Rated brine or water flow rate, outdoor side heat exchanger   |   | -     | m <sup>3</sup> /h                 |
| Sound power level, indoor   | $L_{wa}$       | 60.0     | dB   | Emissions of nitrogen oxides (if applicable)  | NO <sub>x</sub> ***   | -     | mg/kWh fuel input GCV             |
|   |                |          |      | GWP of the refrigerant  |   | 2088  | kg CO <sub>2</sub> eq (100 years) |
| Contact details   |                |          |      | Panasonic Testing Centre, Panasonic Marketing Europe GmbH Winsberggring 15, 22525 Hamburg, Germany  |   |       |                                   |

\*\* If  $C_{bh}$  is not determined by measurement then the default degradation coefficient of heat pumps shall be 0.25.

\*\*\* from 26 September 2018.

Where information relates to multi-split heat pumps, the test result and performance data may be obtained on the basis of the performance of the outdoor unit, with a combination of indoor unit(s) recommended by the manufacturer or importer.

\*\*\*\* Refer to Information requirements for UnitList

## Information requirements for air-to-air air conditioners

|  |                             |                              |
|--|-----------------------------|------------------------------|
| Model(s):  | Outdoor Unit<br>Indoor Unit | U-140PEY1E8<br>S-71PN1E5A x2 |
| Outdoor side heat exchanger of air conditioner:  | air                         |                              |
| Indoor side heat exchanger of air conditioner:   | air                         |                              |
| Type: compressor driven vapour compression or sorption process   | vapour compression          |                              |
| if applicable: driver of compressor: [electric motor or fuel driven, gaseous or liquid fuel, internal or external combustion engine] | electric motor              |                              |

| Item   | Symbol                | Value | Unit | Item  | Symbol  | Value | Unit |
|--|-----------------------|-------|------|---|---|-------|------|
| Rated cooling capacity   | $P_{med,c}$           | 14.0  | kW   | Seasonal space cooling energy efficiency  | $\eta_{s,c}$  | 215.9 | %    |
| Refrigeration load   | $P_{design,c}$        | 14.0  | kW   | Declared energy efficiency ratio or gas utilization efficiency / auxiliary energy factor for part load at given outdoor temperatures $T_j$ and indoor 27°/19°C (dry/wet bulb) |   |       |      |
| Declared cooling capacity for part load at given outdoor temperatures $T_j$ and indoor 27°/19°C (dry/wet bulb) | $T_j = +35\text{ °C}$ | 14.0  | kW   | $T_j = +35\text{ °C}$   | EER <sub>d</sub> or<br>GUE <sub>d,bin</sub> /<br>AEF <sub>d,bin</sub> | 2.9   | %    |
|  | $T_j = +30\text{ °C}$ | 10.3  | kW   | $T_j = +30\text{ °C}$   |   | 4.3   | %    |
|  | $T_j = +25\text{ °C}$ | 6.6   | kW   | $T_j = +25\text{ °C}$   |   | 6.8   | %    |
|  | $T_j = +20\text{ °C}$ | 5.3   | kW   | $T_j = +20\text{ °C}$   |   | 9.5   | %    |
| Degradation co-efficient for air conditioners**  | $C_{dc}$              | 0.25  | -    |   |   |       |      |
| Power consumption in modes other than 'active mode'  |                       |       |      |   |   |       |      |
| Off mode   | $P_{off}$             | 0.020 | kW   | Crankcase heater mode   | $P_{ck}$  | 0.000 | kW   |
| Thermostat-off mode  | $P_{to}$              | 0.090 | kW   | Standby mode  | $P_{sb}$  | 0.020 | kW   |

| Other items                |  |  |    |  |                     |      |                                   |
|----------------------------|--|--|----|--|---------------------|------|-----------------------------------|
| Capacity control           | variable   | For air-to-air conditioner: air flow rate, outdoor |    | 4767   | m <sup>3</sup> /h   |      |                                   |
| Sound power level, outdoor | $L_{WA}$   | 71.0   | dB |  |                     |      |                                   |
| Sound power level, indoor  | $L_{WA}$   | 60.0   | dB | if engine driven: Emissions of nitrogen oxides | NO <sub>x</sub> *** | -    | mg/kWh fuel input GCV             |
|                            |  |  |    | GWP of the refrigerant                         |                     | 2088 | kg CO <sub>2</sub> eq (100 years) |
| Contact details            | Panasonic Testing Centre, Panasonic Marketing Europe GmbH Winsberggring 15, 22525 Hamburg, Germany |  |    |  |                     |      |                                   |

\*\* If  $C_{dc}$  is not determined by measurement then the default degradation coefficient air conditioners shall be 0.25.

\*\*\* from 26 September 2018.

Where information relates to multi-split air conditioners, the test result and performance data may be obtained on the basis of the performance of the outdoor unit, with a combination of indoor unit(s) recommended by the manufacturer or importer.

\*\*\*\* Refer to Information requirements for UnitList

## Information requirements for heat pumps

|  |                             |                              |
|--|-----------------------------|------------------------------|
| Model(s):  | Outdoor Unit<br>Indoor Unit | U-140PEY1E8<br>S-71PN1E5A x2 |
| Outdoor side heat exchanger of heat pump:  | air                         |                              |
| Indoor side heat exchanger of heat pump:   | air                         |                              |
| Indication if the heater is equipped with a supplementary heater:  | no                          |                              |
| if applicable: driver of compressor: [electric motor or fuel driven, gaseous or liquid fuel, internal or external combustion engine] | electric motor              |                              |

Parameters shall be declared for the average heating season, parameters for the warmer and colder heating seasons are optional.

| Item  | Symbol                | Value | Unit | Item  | Symbol  | Value | Unit |
|---|-----------------------|-------|------|---|---|-------|------|
| Rated heating capacity  | $P_{med,h}$           | 14.0  | kW   | Seasonal space heating energy efficiency  | $\eta_{p,h}$  | 138.2 | %    |
| Refrigeration load  | $P_{design,h}$        | 14.0  | kW   | Declared coefficient of performance or gas utilization efficiency / auxiliary energy factor for part load at given outdoor temperatures $T_j$ |   |       |      |
| Declared heating capacity for part load at indoor temperature 20 °C and outdoor temperature $T_j$ | $T_j = -7\text{ °C}$  | 12.3  | kW   | $T_j = -7\text{ °C}$  | COP <sub>d</sub> or<br>GUE <sub>d,bin</sub> /<br>AEF <sub>d,bin</sub> | 2.3   | %    |
|   | $T_j = +2\text{ °C}$  | 7.5   | kW   | $T_j = +2\text{ °C}$  |   | 3.3   | %    |
|   | $T_j = +7\text{ °C}$  | 4.8   | kW   | $T_j = +7\text{ °C}$  |   | 5.1   | %    |
|   | $T_j = +12\text{ °C}$ | 4.7   | kW   | $T_j = +12\text{ °C}$   |   | 5.9   | %    |
| $T_{bw} = \text{bivalent temperature}$  | $P_{bh}$              | 12.3  | kW   | $T_{bw} = \text{bivalent temperature}$  |   | 2.3   | %    |
| $T_{ol} = \text{operation limit}$   |                       | 9.3   | kW   | $T_{ol} = \text{operation limit}$   |   | 1.6   | %    |
| For air-to-water heat pumps:<br>$T_j = -15\text{ °C}$ (if $T_{ol} < -20\text{ °C}$ )              |                       | -     | kW   | For water-to-air heat pumps:<br>$T_j = -15\text{ °C}$ (if $T_{ol} < -20\text{ °C}$ )  |   | -     | %    |
| Bivalent temperature  | $T_{bw}$              | -7    | °C   | For water-to-air heat pumps:<br>Operation limit temperature   | $T_{ol}$  | -15   | °C   |
| Degradation co-efficient heat pumps**   | $C_{dh}$              | 0.25  | -    |   |   |       |      |
| Power consumption in modes other than 'active mode'   |                       |       |      |   |   |       |      |
| Off mode  | $P_{off}$             | 0.020 | kW   | Supplementary heater  |   |       |      |
| Thermostat-off mode   | $P_{to}$              | 0.090 | kW   | back-up heating capacity*   | elbu  | 2.9   | kW   |
| Crankcase heater mode   | $P_{ck}$              | 0.000 | kW   | Type of energy input  |   |       |      |
|   |                       |       |      | Standby mode  | $P_{sb}$  | 0.020 | kW   |

| Other items                |  |   |    |   |                     |      |                                   |
|----------------------------|--|---|----|---|---------------------|------|-----------------------------------|
| Capacity control           | variable   | For air-to-air heat pumps: air flow rate, outdoor |    | 4238  | m <sup>3</sup> /h   |      |                                   |
| Sound power level, outdoor | $L_{WA}$   | 70.0  | dB | For water-/brine-to-air heat pumps: Rated brine or water flow rate, outdoor side heat exchanger |                     | -    | m <sup>3</sup> /h                 |
| Sound power level, indoor  | $L_{WA}$   | 60.0  | dB | Emissions of nitrogen oxides (if applicable)  | NO <sub>x</sub> *** | -    | mg/kWh fuel input GCV             |
|                            |  |   |    | GWP of the refrigerant  |                     | 2088 | kg CO <sub>2</sub> eq (100 years) |
| Contact details            | Panasonic Testing Centre, Panasonic Marketing Europe GmbH Winsberggring 15, 22525 Hamburg, Germany |   |    |   |                     |      |                                   |

\*\* If  $C_{dh}$  is not determined by measurement then the default degradation coefficient of heat pumps shall be 0.25.

\*\*\* from 26 September 2018.

Where information relates to multi-split heat pumps, the test result and performance data may be obtained on the basis of the performance of the outdoor unit, with a combination of indoor unit(s) recommended by the manufacturer or importer.

\*\*\*\* Refer to Information requirements for UnitList

## Information requirements for air-to-air air conditioners

|  |                             |                            |
|--|-----------------------------|----------------------------|
| Model(s):  | Outdoor Unit<br>Indoor Unit | U-125PEY1E8<br>S-125PN1E5A |
| Outdoor side heat exchanger of air conditioner:  | air                         |                            |
| Indoor side heat exchanger of air conditioner:   | air                         |                            |
| Type: compressor driven vapour compression or sorption process   | vapour compression          |                            |
| if applicable: driver of compressor: [electric motor or fuel driven, gaseous or liquid fuel, internal or external combustion engine] | electric motor              |                            |

## Information requirements for heat pumps

|  |                             |                            |
|--|-----------------------------|----------------------------|
| Model(s):  | Outdoor Unit<br>Indoor Unit | U-125PEY1E8<br>S-125PN1E5A |
| Outdoor side heat exchanger of heat pump:  | air                         |                            |
| Indoor side heat exchanger of heat pump:   | air                         |                            |
| Indication if the heater is equipped with a supplementary heater:  | no                          |                            |
| if applicable: driver of compressor: [electric motor or fuel driven, gaseous or liquid fuel, internal or external combustion engine] | electric motor              |                            |

Parameters shall be declared for the average heating season, parameters for the warmer and colder heating seasons are optional.

| Item   | Symbol                    | Value    | Unit | Item  | Symbol  | Value               | Unit              |
|--|---------------------------|----------|------|---|---|---------------------|-------------------|
| Rated cooling capacity   | $P_{rated,c}$             | 12.5     | kW   | Seasonal space cooling energy efficiency  | $\eta_{s,c}$  | 195.0               | %                 |
| Refrigeration load   | $P_{design,c}$            | 12.5     | kW   | Declared energy efficiency ratio or gas utilization efficiency / auxiliary energy factor for part load at given outdoor temperatures $T_j$ and indoor 27%/19°C (dry/wet bulb) |   |                     |                   |
| Declared cooling capacity for part load at given outdoor temperatures $T_j$ and indoor 27%/19°C (dry/wet bulb)     | $T_j = +35^\circ\text{C}$ | 12.5     | kW   | $T_j = +35^\circ\text{C}$   | EER <sub>d</sub> or GUE <sub>d,dbn</sub> / AEF <sub>c,dbn</sub> | 2.8                 | %                 |
|  | $T_j = +30^\circ\text{C}$ | 9.2      | kW   | $T_j = +30^\circ\text{C}$   |   | 4.2                 | %                 |
|  | $T_j = +25^\circ\text{C}$ | 5.9      | kW   | $T_j = +25^\circ\text{C}$   |   | 6.5                 | %                 |
|  | $T_j = +20^\circ\text{C}$ | 5.2      | kW   | $T_j = +20^\circ\text{C}$   |   | 8.8                 | %                 |
| Degradation co-efficient for air conditioners**  | $C_{de}$                  | 0.25     | -    | Power consumption in modes other than 'active mode'   |   |                     |                   |
| Off mode   |                           |          |      |   |   |                     |                   |
|  | $P_{off}$                 | 0.018    | kW   | Crankcase heater mode   | $P_{ck}$  | 0.000               | kW                |
| Thermostat-off mode  | $P_{to}$                  | 0.205    | kW   | Standby mode  | $P_{sb}$  | 0.018               | kW                |
| Other items  |                           |          |      |   |   |                     |                   |
| Capacity control   |                           | variable |      | For air-to-air conditioner: air flow rate, outdoor  |   | 2825                | m <sup>3</sup> /h |
| Sound power level, outdoor   | $L_{WA}$                  | 73.0     | dB   |   |   |                     |                   |
| Sound power level, indoor  | $L_{WA}$                  | 66.0     | dB   | if engine driven: Emissions of nitrogen oxides  |   | NO <sub>x</sub> *** | -                 |
|  |                           |          |      | GWP of the refrigerant  |   |                     | 2088              |
| Contact details Panasonic Testing Centre, Panasonic Marketing Europe GmbH Winsberggring 15, 22525 Hamburg, Germany |                           |          |      |   |   |                     |                   |

\*\* If  $C_{de}$  is not determined by measurement then the default degradation coefficient air conditioners shall be 0.25.

\*\*\* from 26 September 2018.

Where information relates to multi-split air conditioners, the test result and performance data may be obtained on the basis of the performance of the outdoor unit, with a combination of indoor unit(s) recommended by the manufacturer or importer.

\*\*\*\* Refer to Information requirements for UnitList

| Item   | Symbol                    | Value    | Unit | Item  | Symbol  | Value               | Unit              |
|--|---------------------------|----------|------|---|---|---------------------|-------------------|
| Rated heating capacity   | $P_{rated,h}$             | 12.5     | kW   | Seasonal space heating energy efficiency  | $\eta_{s,h}$  | 137.8               | %                 |
| Refrigeration load   | $P_{design,h}$            | 12.5     | kW   | Declared coefficient of performance or gas utilization efficiency / auxiliary energy factor for part load at given outdoor temperatures $T_j$ |   |                     |                   |
| Declared heating capacity for part load at indoor temperature 20 °C and outdoor temperature $T_j$                  | $T_j = -7^\circ\text{C}$  | 11.0     | kW   | $T_j = -7^\circ\text{C}$  | COP <sub>d</sub> or GUE <sub>d,dbn</sub> / AEF <sub>h,dbn</sub> | 2.4                 | %                 |
|  | $T_j = +2^\circ\text{C}$  | 6.7      | kW   | $T_j = +2^\circ\text{C}$  |   | 3.3                 | %                 |
|  | $T_j = +7^\circ\text{C}$  | 4.3      | kW   | $T_j = +7^\circ\text{C}$  |   | 5.0                 | %                 |
|  | $T_j = +12^\circ\text{C}$ | 4.4      | kW   | $T_j = +12^\circ\text{C}$   |   | 5.7                 | %                 |
| $T_{bw} =$ bivalent temperature  | $P_{bh}$                  | 11.0     | kW   | $T_{bw} =$ bivalent temperature   |   | 2.4                 | %                 |
| $T_{ol} =$ operation limit   |                           | 9.8      | kW   | $T_{ol} =$ operation limit  |   | 1.6                 | %                 |
| For air-to-water heat pumps: $T_j = -15^\circ\text{C}$ (if $T_{ol} < -20^\circ\text{C}$ )                          |                           | -        | kW   | For water-to-air heat pumps: $T_j = -15^\circ\text{C}$ (if $T_{ol} < -20^\circ\text{C}$ )   |   | -                   | %                 |
| Bivalent temperature   | $T_{bw}$                  | -7       | °C   | For water-to-air heat pumps: Operation limit temperature  | $T_{ol}$  | -15                 | °C                |
| Degradation co-efficient heat pumps**  | $C_{dh}$                  | 0.25     | -    | Power consumption in modes other than 'active mode'   |   |                     |                   |
| Off mode   |                           |          |      |   |   |                     |                   |
|  | $P_{off}$                 | 0.018    | kW   | back-up heating capacity*   | elbu  | 2.0                 | kW                |
| Thermostat-off mode  | $P_{to}$                  | 0.205    | kW   | Type of energy input  |   |                     |                   |
| Crankcase heater mode  | $P_{ck}$                  | 0.000    | kW   | Standby mode  | $P_{sb}$  | 0.018               | kW                |
| Other items  |                           |          |      |   |   |                     |                   |
| Capacity control   |                           | variable |      | For air-to-air heat pumps: air flow rate, outdoor   |   | 2578                | m <sup>3</sup> /h |
| Sound power level, outdoor   | $L_{WA}$                  | 73.0     | dB   | For water-/brine-to-air heat pumps: Rated brine or water flow rate, outdoor side heat exchanger   |   | -                   | m <sup>3</sup> /h |
| Sound power level, indoor  | $L_{WA}$                  | 66.0     | dB   | Emissions of nitrogen oxides (if applicable)  |   | NO <sub>x</sub> *** | -                 |
|  |                           |          |      | GWP of the refrigerant  |   |                     | 2088              |
| Contact details Panasonic Testing Centre, Panasonic Marketing Europe GmbH Winsberggring 15, 22525 Hamburg, Germany |                           |          |      |   |   |                     |                   |

\*\* If  $C_{dh}$  is not determined by measurement then the default degradation coefficient of heat pumps shall be 0.25.

\*\*\* from 26 September 2018.

Where information relates to multi-split heat pumps, the test result and performance data may be obtained on the basis of the performance of the outdoor unit, with a combination of indoor unit(s) recommended by the manufacturer or importer.

\*\*\*\* Refer to Information requirements for UnitList

## Information requirements for air-to-air air conditioners

|  |                             |                            |
|--|-----------------------------|----------------------------|
| Model(s):  | Outdoor Unit<br>Indoor Unit | U-140PEY1E8<br>S-140PN1E5A |
| Outdoor side heat exchanger of air conditioner:  | air                         |                            |
| Indoor side heat exchanger of air conditioner:   | air                         |                            |
| Type: compressor driven vapour compression or sorption process   | vapour compression          |                            |
| if applicable: driver of compressor: [electric motor or fuel driven, gaseous or liquid fuel, internal or external combustion engine] | electric motor              |                            |

## Information requirements for heat pumps

|  |                             |                            |
|--|-----------------------------|----------------------------|
| Model(s):  | Outdoor Unit<br>Indoor Unit | U-140PEY1E8<br>S-140PN1E5A |
| Outdoor side heat exchanger of heat pump:  | air                         |                            |
| Indoor side heat exchanger of heat pump:   | air                         |                            |
| Indication if the heater is equipped with a supplementary heater:  | no                          |                            |
| if applicable: driver of compressor: [electric motor or fuel driven, gaseous or liquid fuel, internal or external combustion engine] | electric motor              |                            |

Parameters shall be declared for the average heating season, parameters for the warmer and colder heating seasons are optional.

| Item   | Symbol   | Value    | Unit | Item  | Symbol  | Value | Unit                              |
|--|--|----------|------|---|---|-------|-----------------------------------|
| Rated cooling capacity   | $P_{med,c}$  | 14.0     | kW   | Seasonal space cooling energy efficiency  | $\eta_{s,c}$  | 204.3 | %                                 |
| Refrigeration load   | $P_{design,c}$   | 14.0     | kW   | Declared energy efficiency ratio or gas utilization efficiency / auxiliary energy factor for part load at given outdoor temperatures $T_j$ and indoor 27°/19°C (dry/wet bulb) |   |       |                                   |
| Declared cooling capacity for part load at given outdoor temperatures $T_j$ and indoor 27°/19°C (dry/wet bulb) | $T_j = +35\text{ °C}$  | 14.0     | kW   | $T_j = +35\text{ °C}$   |   | 2.9   | %                                 |
|  | $T_j = +30\text{ °C}$  | 10.3     | kW   | $T_j = +30\text{ °C}$   | EER <sub>i</sub> or GUE <sub>o,ho</sub> / AEF <sub>o,ho</sub> | 4.3   | %                                 |
|  | $T_j = +25\text{ °C}$  | 6.6      | kW   | $T_j = +25\text{ °C}$   |   | 6.8   | %                                 |
|  | $T_j = +20\text{ °C}$  | 5.3      | kW   | $T_j = +20\text{ °C}$   |   | 9.5   | %                                 |
| Degradation co-efficient for air conditioners**  | $C_{de}$   | 0.25     | -    | Declared heating capacity for part load at indoor temperature 20 °C and outdoor temperature $T_j$   |   |       |                                   |
| Declared heating capacity for part load at indoor temperature 20 °C and outdoor temperature $T_j$              | $T_j = -7\text{ °C}$   | 12.3     | kW   | $T_j = -7\text{ °C}$  |   | 2.3   | %                                 |
|  | $T_j = +2\text{ °C}$   | 7.5      | kW   | $T_j = +2\text{ °C}$  |   | 3.3   | %                                 |
|  | $T_j = +7\text{ °C}$   | 4.8      | kW   | $T_j = +7\text{ °C}$  |   | 5.1   | %                                 |
|  | $T_j = +12\text{ °C}$  | 4.7      | kW   | $T_j = +12\text{ °C}$   |   | 5.9   | %                                 |
| Degradation co-efficient for air conditioners**  | $T_{b,w} = \text{bivalent temperature}$  | 12.3     | kW   | $T_{b,w} = \text{bivalent temperature}$   | COP <sub>a</sub> or GUE <sub>o,ho</sub> / AEF <sub>o,ho</sub> | 2.3   | %                                 |
|  | $T_{o,l} = \text{operation limit}$   | 9.3      | kW   | $T_{o,l} = \text{operation limit}$  |   | 1.6   | %                                 |
| For air-to-water heat pumps: $T_j = -15\text{ °C}$ (if $T_{o,l} < -20\text{ °C}$ )                             | Bivalent temperature   | -7       | °C   | For water-to-air heat pumps: $T_j = -15\text{ °C}$ (if $T_{o,l} < -20\text{ °C}$ )  | Operation limit temperature                                   | -15   | °C                                |
|  |  |          |      |   |   |       |                                   |
| Power consumption in modes other than 'active mode'  |  |          |      |   |   |       |                                   |
| Off mode   | $P_{off}$  | 0.020    | kW   | Crankcase heater mode   | $P_{ck}$  | 0.000 | kW                                |
| Thermostat-off mode  | $P_{to}$   | 0.220    | kW   | Standby mode  | $P_{sb}$  | 0.020 | kW                                |
| Other items  |  |          |      |   |   |       |                                   |
| Capacity control   |  | variable |      | For air-to-air conditioner: air flow rate, outdoor  |   | 4767  | m³/h                              |
| Sound power level, outdoor   | $L_{WA}$   | 71.0     | dB   |   |   |       |                                   |
| Sound power level, indoor  | $L_{WA}$   | 67.0     | dB   | if engine driven: Emissions of nitrogen oxides  | NO <sub>x</sub> **  | -     | mg/kWh fuel input GCV             |
|  |  |          |      | GWP of the refrigerant  |   | 2088  | kg CO <sub>2</sub> eq (100 years) |
| Contact details  | Panasonic Testing Centre, Panasonic Marketing Europe GmbH Winsberggring 15, 22525 Hamburg, Germany |          |      |   |   |       |                                   |

\*\* If  $C_{de}$  is not determined by measurement then the default degradation coefficient air conditioners shall be 0.25.

\*\*\* from 26 September 2018.

Where information relates to multi-split air conditioners, the test result and performance data may be obtained on the basis of the performance of the outdoor unit, with a combination of indoor unit(s) recommended by the manufacturer or importer.

\*\*\*\* Refer to Information requirements for UnitList

| Item  | Symbol   | Value    | Unit | Item   | Symbol  | Value | Unit                              |
|---|--|----------|------|--|---|-------|-----------------------------------|
| Rated heating capacity  | $P_{med,h}$  | 14.0     | kW   | Seasonal space heating energy efficiency   | $\eta_{s,h}$  | 137.6 | %                                 |
| Refrigeration load  | $P_{design,h}$   | 14.0     | kW   | Declared coefficient of performance or gas utilization efficiency / auxiliary energy factor for part load at given outdoor temperatures °C and outdoor temperature $T_j$ |   |       |                                   |
| Declared heating capacity for part load at indoor temperature 20 °C and outdoor temperature $T_j$ | $T_j = -7\text{ °C}$   | 12.3     | kW   | $T_j = -7\text{ °C}$   |   | 2.3   | %                                 |
|   | $T_j = +2\text{ °C}$   | 7.5      | kW   | $T_j = +2\text{ °C}$   |   | 3.3   | %                                 |
|   | $T_j = +7\text{ °C}$   | 4.8      | kW   | $T_j = +7\text{ °C}$   |   | 5.1   | %                                 |
|   | $T_j = +12\text{ °C}$  | 4.7      | kW   | $T_j = +12\text{ °C}$  |   | 5.9   | %                                 |
| Degradation co-efficient for air conditioners**   | $T_{b,w} = \text{bivalent temperature}$  | 12.3     | kW   | $T_{b,w} = \text{bivalent temperature}$  | COP <sub>a</sub> or GUE <sub>o,ho</sub> / AEF <sub>o,ho</sub> | 2.3   | %                                 |
|   | $T_{o,l} = \text{operation limit}$   | 9.3      | kW   | $T_{o,l} = \text{operation limit}$   |   | 1.6   | %                                 |
| For air-to-water heat pumps: $T_j = -15\text{ °C}$ (if $T_{o,l} < -20\text{ °C}$ )                | Bivalent temperature   | -7       | °C   | For water-to-air heat pumps: $T_j = -15\text{ °C}$ (if $T_{o,l} < -20\text{ °C}$ )   | Operation limit temperature                                   | -15   | °C                                |
|   |  |          |      |  |   |       |                                   |
| Power consumption in modes other than 'active mode'   |  |          |      |  |   |       |                                   |
| Off mode  | $P_{off}$  | 0.020    | kW   | back-up heating capacity*  | elbu  | 2.9   | kW                                |
| Thermostat-off mode   | $P_{to}$   | 0.220    | kW   | Type of energy input   |   |       |                                   |
| Crankcase heater mode   | $P_{ck}$   | 0.000    | kW   | Standby mode   | $P_{sb}$  | 0.020 | kW                                |
| Other items   |  |          |      |  |   |       |                                   |
| Capacity control  |  | variable |      | For air-to-air heat pumps: air flow rate, outdoor  |   | 4238  | m³/h                              |
| Sound power level, outdoor  | $L_{WA}$   | 70.0     | dB   | For water-/brine-to-air heat pumps: Rated brine or water flow rate, outdoor side heat exchanger  |   | -     | m³/h                              |
| Sound power level, indoor   | $L_{WA}$   | 67.0     | dB   | Emissions of nitrogen oxides (if applicable)   | NO <sub>x</sub> **  | -     | mg/kWh fuel input GCV             |
|   |  |          |      | GWP of the refrigerant   |   | 2088  | kg CO <sub>2</sub> eq (100 years) |
| Contact details   | Panasonic Testing Centre, Panasonic Marketing Europe GmbH Winsberggring 15, 22525 Hamburg, Germany |          |      |  |   |       |                                   |

\*\* If  $C_{th}$  is not determined by measurement then the default degradation coefficient of heat pumps shall be 0.25.

\*\*\* from 26 September 2018.

Where information relates to multi-split heat pumps, the test result and performance data may be obtained on the basis of the performance of the outdoor unit, with a combination of indoor unit(s) recommended by the manufacturer or importer.

\*\*\*\* Refer to Information requirements for UnitList



## 2. TEST RUN

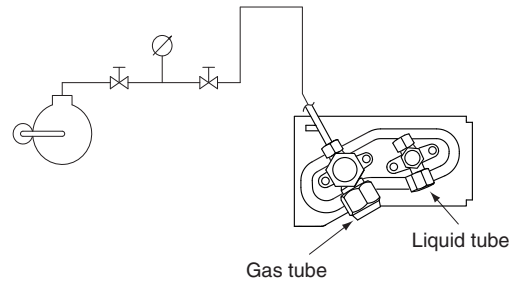
|   |      |
|---|------|
| ■ U-36PE2E5A, U-50PE2E5A, U-60PE2E5A<br>U-60PEY2E5, U-71PEY2E5  |      |
| 2-1. Preparing for Test Run .....   | 2-2  |
| 2-2. Caution .....  | 2-3  |
| 2-3. Test Run Procedure .....   | 2-3  |
| 2-4. Items to Check Before the Test Run .....   | 2-3  |
| 2-5. Test Run Using the Remote Controller.....  | 2-4  |
| 2-6. Precautions .....  | 2-5  |
| 2-7. Setting the outdoor unit system addresses.....   | 2-6  |
| 2-8. Auto address setting using the remote controller.....  | 2-7  |
| 2-9. Indicating (marking) the indoor and outdoor unit combination number.....   | 2-9  |
| 2-10. Table of Self-Diagnostic Functions and Corrections .....  | 2-10 |
| 2-11. Auto address setting from the outdoor unit .....  | 2-13 |
| 2-12. Test run using the indicator of the indoor unit (Type K1) .....   | 2-13 |
| 2-13. Caution for Pump Down .....   | 2-13 |
| ■ U-71PE1E5A, U-100PE1E5A, U-125PE1E5A, U-140PE1E5A<br>U-100PEY1E5, U-125PEY1E5<br>U-71PE1E8A, U-100PE1E8A, U-125PE1E8A, U-140PE1E8A<br>U-100PEY1E8, U-125PEY1E8, U-140PEY1E8 |      |
| 2-14. PRECAUTIONS REGARDING TEST RUN .....  | 2-14 |
| 2-15. CHECKS AFTER INSTALLATION HAVE COMPLETED .....  | 2-15 |
| 2-16. REGARDING DELIVERY TO THE CUSTOMER .....  | 2-15 |

■ U-36PE2E5A, U-50PE2E5A, U-60PE2E5A  
U-60PEY2E5, U71PEY2E5

2-1. Preparing for Test Run

● Before attempting to start the air conditioner, check the following:

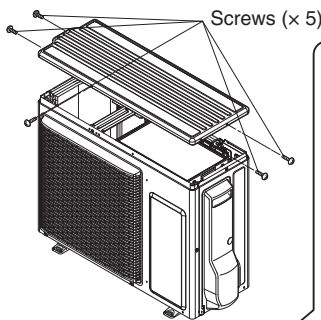
- (1) All loose matter is removed from the cabinet especially steel filings, bits of wire, and clips.
- (2) The control wiring is correctly connected and all electrical connections are tight.
- (3) The protective spacers for the compressor used for transportation have been removed. If not, remove them now.
- (4) The transportation pads for the indoor fan have been removed. If not, remove them now.
- (5) Both the gas and liquid tube service valves are open. If not, open them now.



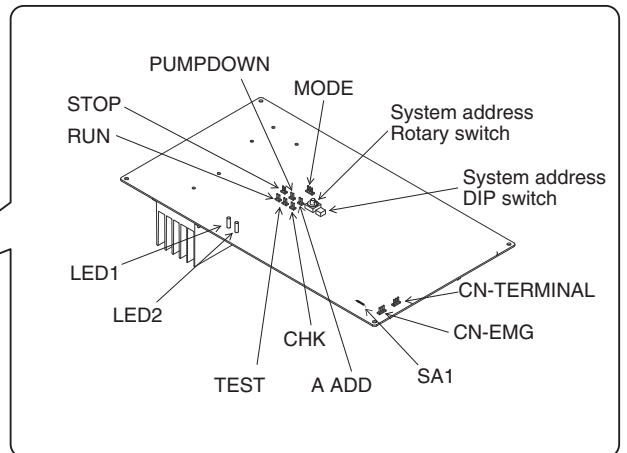
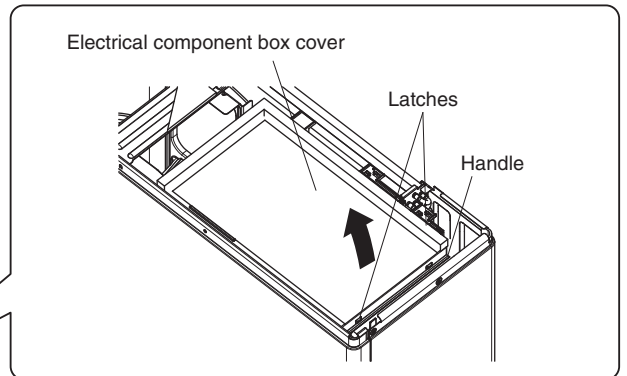
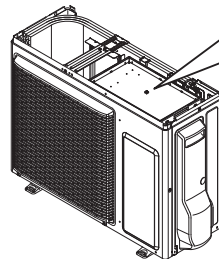
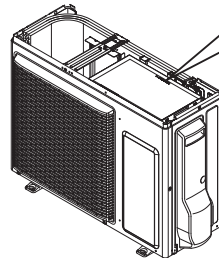
- (6) Request that the customer be present for the test run. Explain the contents of the instruction manual, and then have the customer actually operate the system.
- (7) Be sure to give the instruction manual and warranty certificate to the customer.

● If it is necessary to make settings such as system address when performing a test run, remove the top panel and electrical component box cover as illustrated below and check each switch on the control PC board.

- (1) Remove the top panel by unfastening five screws.



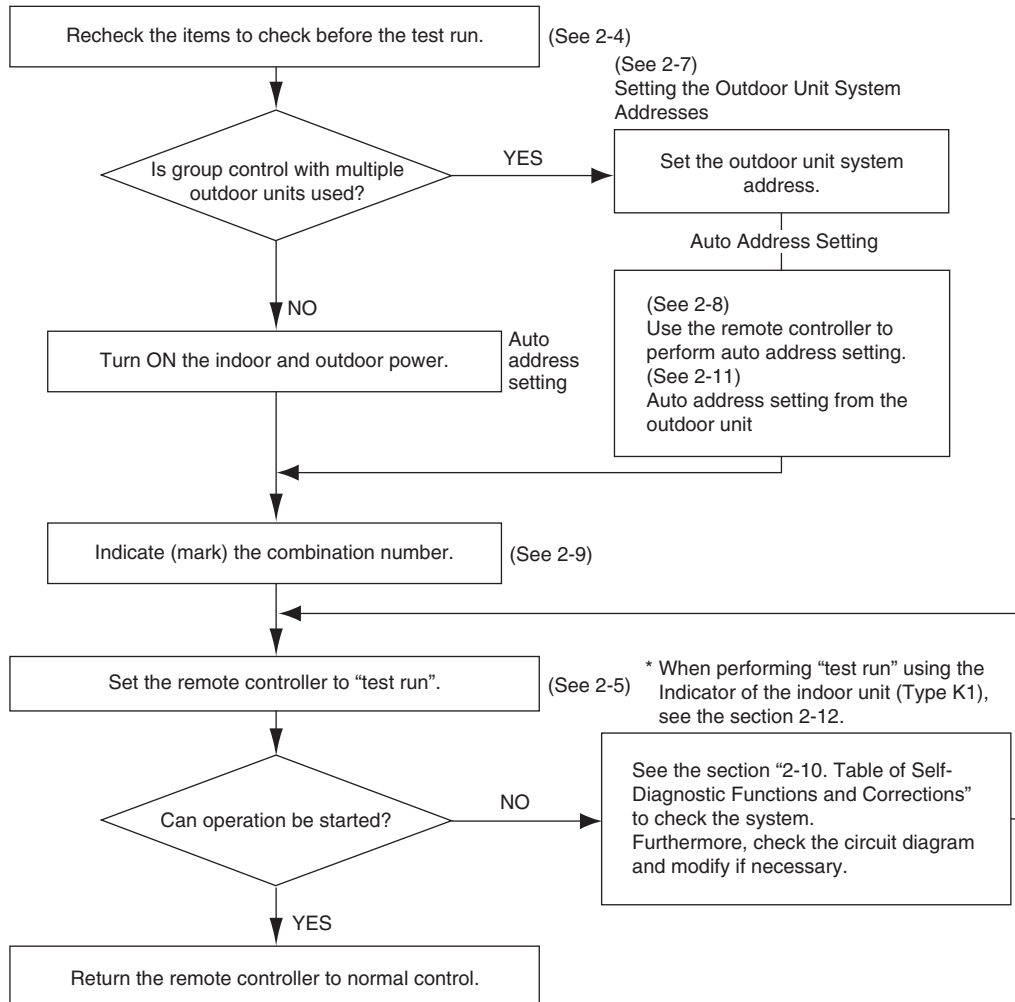
- (2) To remove the electrical component box cover, press the latches on the cover in the direction of the arrow while holding the handle with one hand.



**2-2. Caution**

- This unit may be used in a single-type refrigerant system where 1 outdoor unit is connected to 1 indoor unit.
- The indoor and outdoor unit control PCB utilizes a semiconductor memory element (EEPROM). The settings required for operation were made at the time of shipment. Only the correct combinations of indoor and outdoor units can be used.
- This test run section describes primarily the procedure when using the wired remote controller. Regarding the wireless remote controller, refer to the Installation Instructions attached to the wireless remote controller.

**2-3. Test Run Procedure**



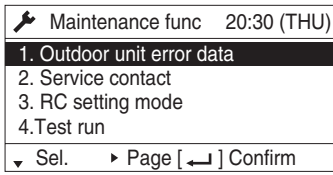
**2-4. Items to Check Before the Test Run**

Fully open the closed valves on the liquid-tube and gas-tube sides.

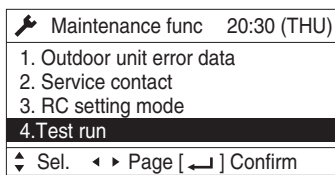
## 2-5. Test Run Using the Remote Controller

### High-spec Wired Remote Controller (CZ-RTC5A)

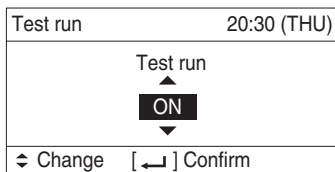
- Keep pressing the , and buttons simultaneously for 4 or more seconds. The "Maintenance func" screen appears on the LCD display.



- Press the or button to see each menu. If you wish to see the next screen instantly, press the or button. Select "4. Test run" on the LCD display and press the button.



Change the display from OFF to ON by pressing the or button. Then press the button.



### Timer remote controller (CZ-RTC4)

- Press the remote controller button for 4 seconds or longer. Then press the button.

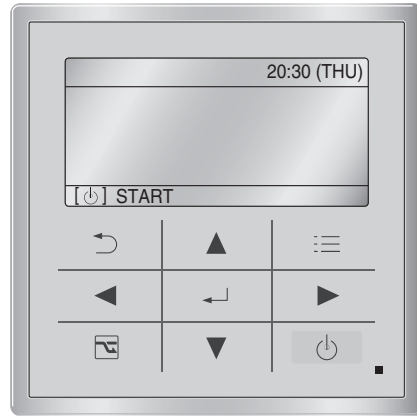
- "TEST" appears on the LCD display while the test run is in progress.
  - The temperature cannot be adjusted when in Test Run mode. (This mode places a heavy load on the machines. Therefore use it only when performing the test run.)
- The test run can be performed using the HEAT, COOL, or FAN operation modes.

**NOTE**

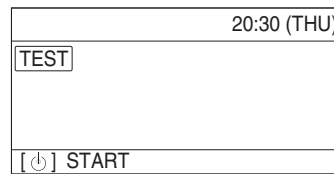
The outdoor units will not operate for approximately 3 minutes after the power is turned ON and after operation is stopped.

- If correct operation is not possible, a code is displayed on the remote controller LCD display. (See the section "2-10. Table of Self-Diagnostic Functions and Corrections" and correct the problem.)
- After the test run is completed, press the button again. Check that "TEST" disappears from the LCD display. (To prevent continuous test runs, this remote controller includes a timer function that cancels the test run after 60 minutes.)

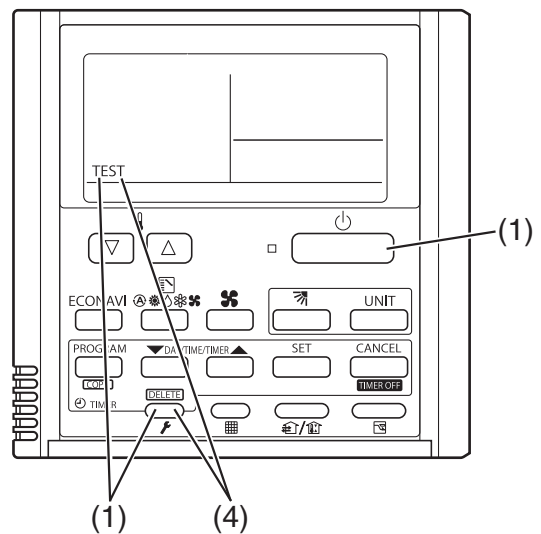
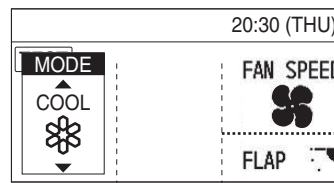
\* If the test run is performed using the wired remote controller, operation is possible even if the cassette-type ceiling panel has not been installed. ("P09" display does not occur.)



- Press the button. "TEST" will be displayed on the LCD display.



- Press the button. Test run will be started. Test run setting mode screen appears on the LCD display.

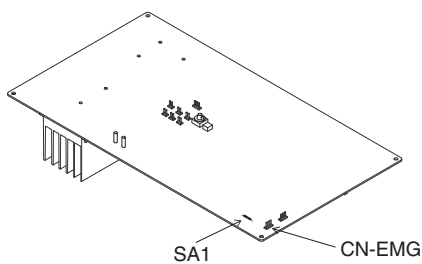


## 2-6. Precautions

- Request that the customer be present when the test run is performed. At this time, explain the operation manual and have the customer perform the actual steps.
- Be sure to pass the manuals and warranty certificate to the customer.
- Check that the 220 – 240 V AC power is not connected to the inter-unit control wiring connector terminal.

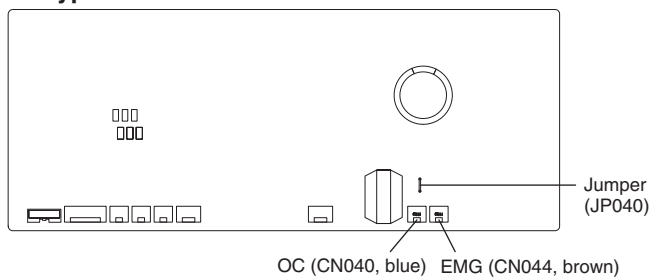
\* If 220 – 240 V AC is accidentally applied, the indoor or outdoor unit control PCB fuse will blow in order to protect the PCB. Correct the wiring connections. Remove the short connector connected to the OC side and reconnect to the EMG side on the outdoor control PCB. Cut the SA1 out of the outdoor unit control PCB. Then disconnect the 2P connectors (OC) that are connected to the indoor unit PCB, and replace them with 2P connectors (EMG). If operation is still not possible after changing the brown connectors, cut off the jumper (indoor unit) or the varistor (indoor unit) on the PCB. (Be sure to turn the power OFF before performing this work.)

Outdoor unit control PCB

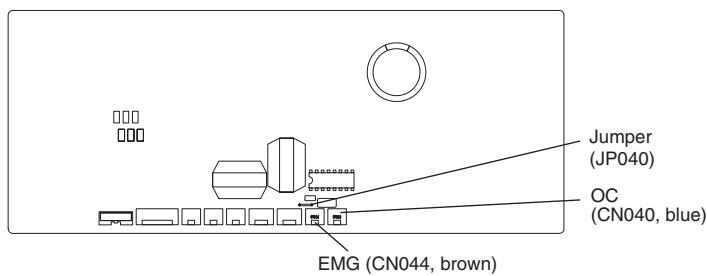


Indoor unit control PCB

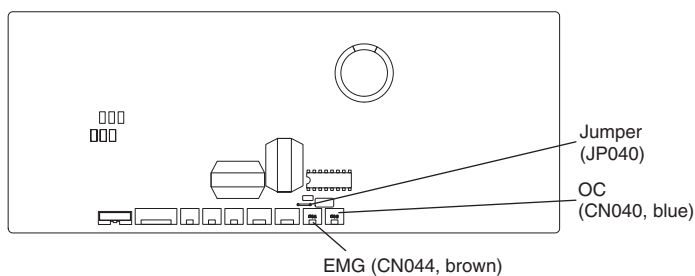
### ■ Type U2



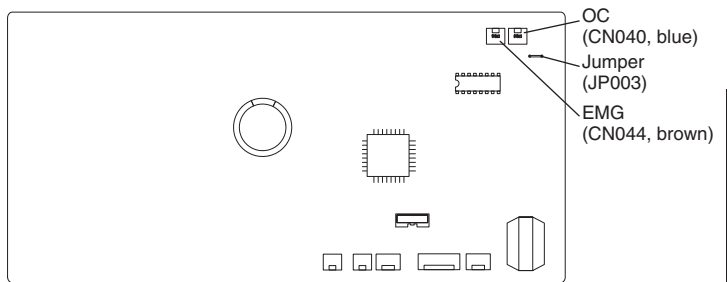
### ■ Type T2



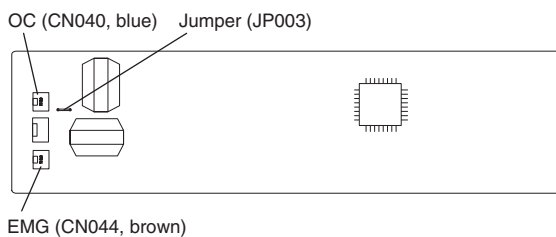
### ■ Type F1



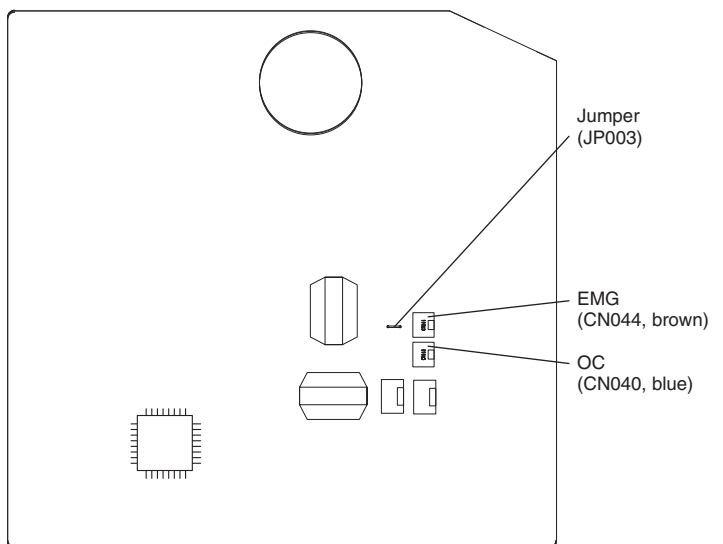
### ■ Type N1



### ■ Type Y2



### ■ Type K1

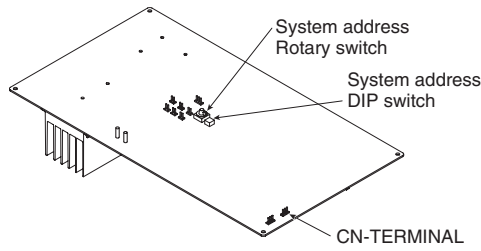
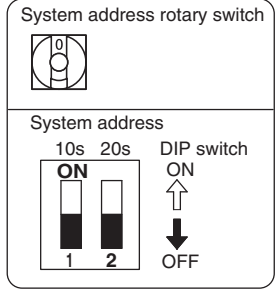


## 2-7. Setting the outdoor unit system addresses

For link wiring (Set the system addresses: 1, 2, 3...)

### Outdoor unit control PCB

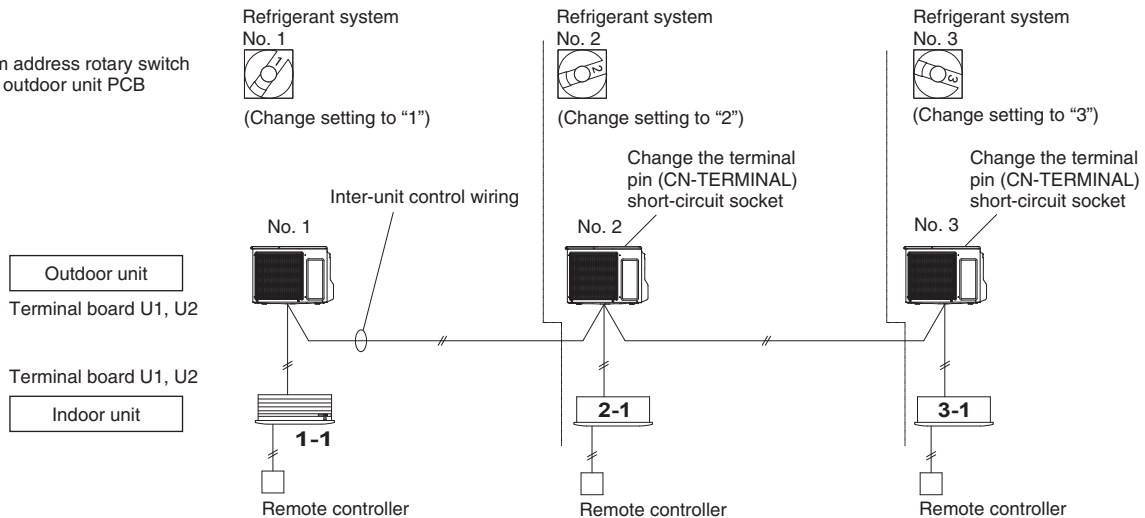
System address rotary switch  
(Set to "0" at time of shipment)



| System address No.                            | System address 10s digit (2P DIP switch) | System address 1s place (Rotary switch) |
|---|--|---|
| 0 Auto address<br>(Setting at shipment = "0") | Both OFF<br>                             | "0" setting<br>                         |
| 1 (If outdoor unit is No. 1)                  | Both OFF<br>                             | "1" setting<br>                         |
| 2 (If outdoor unit is No. 2)                  | Both OFF<br>                             | "2" setting<br>                         |
| 11 (If outdoor unit is No. 11)                | 10s digit ON<br>                         | "1" setting<br>                         |
| 21 (If outdoor unit is No. 21)                | 20s digit ON<br>                         | "1" setting<br>                         |
| 30 (If outdoor unit is No. 30)                | 10s digit and 20s digit ON<br>           | "0" setting<br>                         |

### Link wiring sample

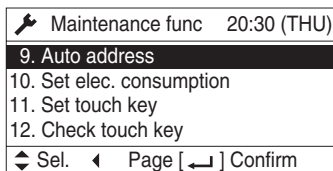
System address rotary switch on the outdoor unit PCB



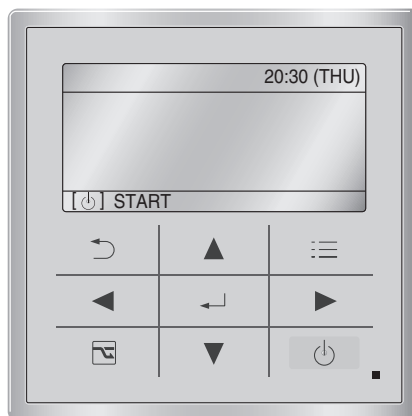
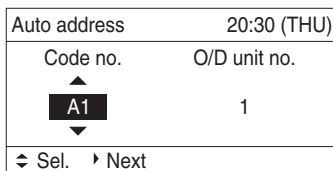
## 2-8. Auto address setting using the remote controller

### High-spec Wired Remote Controller (CZ-RTC5A)

- Keep pressing the , and buttons simultaneously for 4 or more seconds.  
The "Maintenance func" screen appears on the LCD display.
- Press the or button to see each menu.  
If you wish to see the next screen instantly, press the or button.  
Select "9. Auto address" on the LCD display and press the button.



- The "Auto address" screen appears on the LCD display.  
Change the "Code no." to "A1" by pressing the or button.



- Select the "O/D unit no." by pressing the or button.

Select one of the "O/D unit no." for auto address by pressing the or button.

Approximately about 10 minutes are required.  
When auto address setting is completed, the units return to normal stopped status.

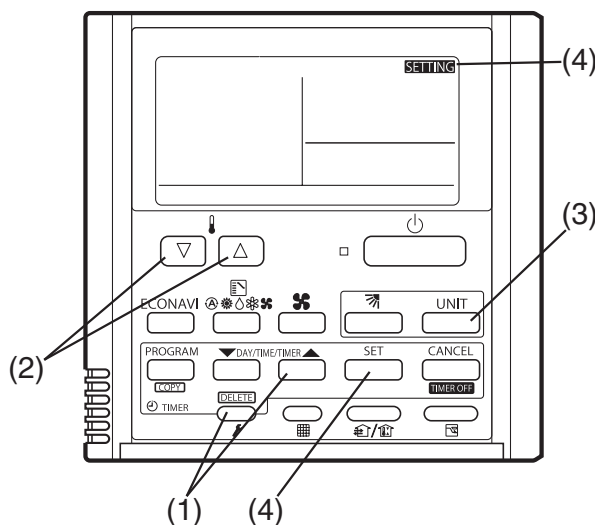
### Timer remote controller (CZ-RTC4)

Auto address setting in Cooling mode cannot be done from the remote controller.

#### NOTE

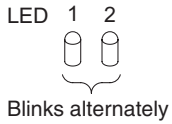
- Selecting each refrigerant system individually for auto address setting
- Auto address setting for each system  
: Item code "A1"

- Press the remote controller timer time button and button at the same time.  
(Press and hold for 4 seconds or longer.)
- Next, press either the temperature setting / button.  
(Check that the item code is "A1".)
- Use either the button to set the system No. to perform auto address setting.
- Then press the button.  
(Auto address setting for one refrigerant system begins.) (When auto address setting for one system is completed, the system returns to normal stopped status.)  
<Approximately 4 – 5 minutes is required.>  
(During auto address setting, "SETTING" is displayed on the remote controller.  
This message disappears when auto address setting is completed.)
- Repeat the same steps to perform auto address setting for each successive system.



## Display During Auto Address Setting

- On the surface of outdoor unit control P.C. board



- \* Do not short circuit the A ADD pin again during auto address setting. LEDs 1 and 2 go out and address setting is interrupted.
- \* When auto address setting is normally completed, both LEDs 1 and 2 go out. In other cases, correct settings referring to the following table and perform auto address setting again.

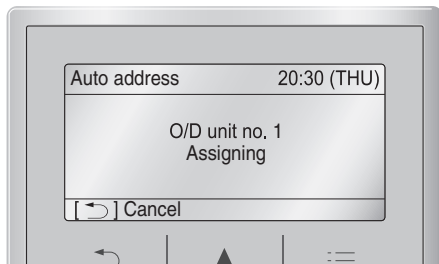
- Contents of LEDs 1 and 2 on outdoor unit control P.C. board

○ : ON    ⚙ : Blinking    ● : OFF

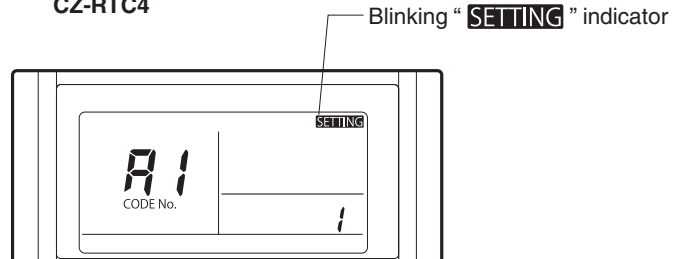
|  |  | LED1  | LED2 | Remark  |
|--|--|---|------|---|
| Normal operation                                     |  | ●   | ●    |   |
| Pre-trip (High pressure protection)                  |  | ⚙   | ●    | LED1 Blinking : 0.8sec-ON / 0.3sec-OFF            |
| Pre-trip (other)                                     |  | ⚙   | ●    | LED1 Blinking : 0.5sec-ON / 0.5sec-OFF            |
| Auto address setting                                 | Under auto address setting                                   | ⚙   | ⚙    | Blinking alternately                              |
|  | Auto address setting alarm                                   | ⚙   | ⚙    | Follow the blinking patterns of each alarm        |
| Alternate blinking of outdoor unit LED during alarms |  | LED1 blinks M times, and then LED2 blinks N times. The cycle then repeats.<br>M=2:P alarm, 3:H alarm, 4:E alarm, 5:F alarm, 6:L alarm, N=alarm No<br>Example: LED1 blinks 4 times, then LED2 blinks 6 times. The cycle then repeats. Alarm is "E06" |      |   |
| Power ON sequence                                    | No communication from indoor units in system                 | ○   | ○    | If it is not possible to advance to 3 repeats 1→2 |
|  | Communication received from 1 or more indoor units in system | ●   | ○    | At 3, advances to normal control                  |
|  | Regular communication OK (Capacity and unit quantity match)  | ●   | ●    |   |
| Refrigerant recovery mode                            |  | ⚙   | ○    |   |

- Display of remote controller

### CZ-RTC5A



### CZ-RTC4





### 2-9. Indicating (marking) the indoor and outdoor unit combination number

Indicate (mark) the number after auto address setting is completed.

- So that the combination of each indoor unit can be easily checked when multiple units are installed, ensure that the indoor and outdoor unit numbers correspond to the system address number on the outdoor unit control PCB, and use a magic marker or similar means which cannot be easily erased to indicate the numbers in an easily visible location on the indoor units (near the indoor unit nameplates).

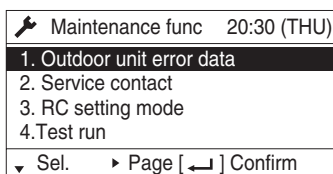
Example: (Outdoor) 1 - (Indoor) 1  
(Outdoor) 2 - (Indoor) 1

- These numbers will be needed for maintenance. Be sure to indicate them.

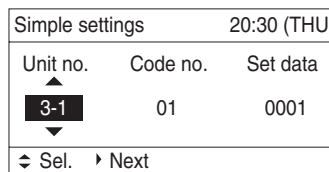
Use the remote controller to check the indoor unit address.

#### High-spec Wired Remote Controller (CZ-RTC5A)

- (1) Keep pressing the , and buttons simultaneously for 4 or more seconds. The "Maintenance func" screen appears on the LCD display.

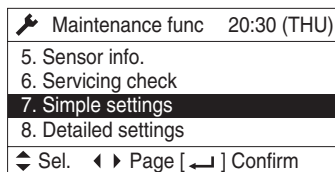
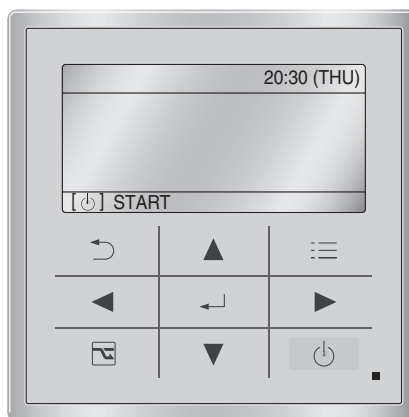


- (3) The "Simple settings" screen appears on the LCD display. Select the "Unit no." by pressing the or button for changes.



- (2) Press the or button to see each menu. If you wish to see the next screen instantly, press the or button. Select "7. Simple settings" on the LCD display and press the button.

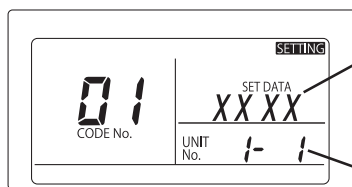
The indoor unit fan operates only at the selected indoor unit.



#### Timer remote controller (CZ-RTC4)

<If 1 indoor unit is connected to 1 remote controller>

- (1) Press and hold the button and button for 4 seconds or longer (simple settings mode).
- (2) The address is displayed for the indoor unit that is connected to the remote controller. (Only the address of the indoor unit that is connected to the remote controller can be checked.)
- (3) Press the button again to return to normal remote controller mode.



Number changes to indicate which indoor unit is currently selected.

Indoor unit address

## 2-10. Table of Self-Diagnostic Functions and Corrections

ON: ○ Blinking: ☼ OFF: ●

| Abnormal display                | Wireless remote controller receiver display                  |                                  |  | Alarm contents   | Error location  |
|---------------------------------|--|----------------------------------|--|--|---|
|                                 | Operation  | Timer                            | Standby  |  |   |
| Remote controller • Indoor Unit | E01  | Operating lamp blinking<br>☼ ● ● |  | • Faulty remote controller   | • Replace the remote controller   |
|                                 |  |                                  |  | • Disconnection / Contact failure of remote controller wiring  | • Correct the remote controller wiring  |
|                                 |  |                                  |  | • CHK (check) pins on the indoor unit control PCB are short circuited  | • Remove the short  |
|                                 | E02  |                                  |  | • In the case of non-group control : Power supply OFF of outdoor unit<br>Disconnection / Contact failure of inter-unit wiring  | • Execute automatic address setting   |
|                                 |  |                                  |  | • In the case of group control : Automatic address operation was not carried out   |   |
|                                 | E03  |                                  |  | • Faulty setting of EEPROM (IC010) on indoor unit  | • Replace the indoor unit EEPROM  |
|                                 |  |                                  |  | • Faulty remote controller<br>• Wrong wiring of remote controller  | • Replace the remote controller<br>• Correct the remote controller wiring   |
|                                 | E04  | Standby lamp blinking<br>● ● ☼   |  | • Disconnection / Contact failure of inter-unit wiring<br>• Faulty indoor unit control PCB<br>• Faulty outdoor unit control PCB<br>• Communication circuit fuse (F302) on indoor unit control PCB opened | • Check the electrical connection of inter-unit control wiring<br>• Replace the indoor unit control PCB<br>• Replace the outdoor unit control PCB<br>• Check the electrical connection of fuse (F302) on indoor unit control PCB  |
|                                 |  |                                  |  | • Fuse on outdoor unit control PCB opened<br>Since failure of an outdoor fan motor is considered as a cause, both outdoor unit control PCB and outdoor unit fan motor are exchanged simultaneously       | In the case of the fuse opened on an indoor unit control PCB, after correcting wiring connection, it substitutes an EMG plug for OC plug<br>• In the case of the fuse opened on an outdoor unit control PCB, replace both outdoor unit control PCB (CR/HIC) and outdoor unit fan motor simultaneously |
|                                 | E08  |                                  |  | • Duplication of indoor unit address setting   | • Indoor unit address re-setting  |
|                                 | E09  | Operating lamp blinking<br>☼ ● ● |  | • Error because of more than one remote controller setting to main   | • Correct the setting   |
|                                 | E18  | ☼ ● ●                            |  | • Disconnection of wiring between main unit and additional units<br>• Contact failure of wiring<br>• Faulty indoor unit control PCB (main or addition)   | • Correct the wiring connection<br>• Replace the wiring<br>• Replace the indoor unit control PCB  |
| F01                             | Operating and timer lamp blinking alternately<br>☼ ☼ ●       |                                  | • Indoor heat exchanger temperature sensor (E1) trouble  | • Check the indoor unit heat exchanger temperature sensor (E1)<br>• Check the indoor unit control PCB  |   |
| F02                             |  |                                  | • Indoor heat exchanger temperature sensor (E2) trouble  | • Check the indoor unit heat exchanger temperature sensor (E2)<br>• Check the indoor unit control PCB  |   |
| F10                             | ☼ ☼ ●  |                                  | • Indoor air temperature sensor (TA) trouble   | • Check the indoor unit air temperature sensor (TA)<br>• Check the indoor unit control PCB   |   |
| F29                             | Operating and timer lamp blinking simultaneously<br>☼ ☼ ●    |                                  | • Indoor unit EEPROM trouble   | • Check the indoor unit EEPROM<br>• Check the indoor unit control PCB  |   |
| L02                             | Operating and standby lamps blinking simultaneously<br>☼ ● ☼ |                                  | • Setting error, indoor / outdoor unit type / model mismatched   | • Address re-setting after correcting the combination of units   |   |
| L03                             |  |                                  | • Duplication of main indoor unit address in group control   | • Correct the group (main and addition)  |   |
| L07                             |  |                                  | • Group control wiring is connected to individual control indoor unit  | • Correct the indoor unit address  |   |
| L08                             |  |                                  | • Indoor unit address is not set   | • Correct the indoor unit address  |   |
| L09                             |  |                                  | • Indoor unit capacity is not set  | • Correct the capacity setting of indoor units   |   |
| P01                             |  |                                  | • Indoor unit fan motor locked<br>• Indoor unit fan motor layer short<br>• Contact failure in thermostat protector circuit | • Remove the cause<br>• Replace the fan motor<br>• Correct the wiring  |   |
| P09                             | Timer and standby lamp blinking alternately<br>● ☼ ☼         |                                  | • Faulty wiring connections of (ceiling) indoor unit panel   | • Correct the wiring connection  |   |
| P10                             |  |                                  | • Faulty drain pump<br>• Drainage failure<br>• Contact failure of float switch wiring                                      | • Repair / Replace<br>• Correct<br>• Correct the wiring  |   |
| P11                             | ● ☼ ☼  |                                  | • Faulty drain pump<br>• Drain pump locked   | • Repair / Replace<br>• Remove the cause   |   |
| P12                             |  |                                  | • Indoor unit fan motor locked<br>• Faulty wiring connections of indoor unit fan motor                                     | • Remove the cause<br>• Correct the wiring   |   |

ON: ○ Blinking: ☀ OFF: ●

| Abnormal display | Wireless remote controller receiver display |       |         | Alarm contents  | Error location   |
|------------------|---|-------|---------|---|--|
|                  | Operation                                   | Timer | Standby |   |  |
| E06              | ●   | ●     | ☀       | <ul style="list-style-type: none"> <li>Disconnection / Contact failure of inter-unit wiring</li> <li>Disconnection of inter-unit wiring</li> <li>Communication circuit fuse (F302) on indoor unit control PCB opened</li> <li>Indoor unit control PCB address settings error</li> </ul> | <ul style="list-style-type: none"> <li>Correct the inter-unit control wiring</li> <li>Check the electrical connection of fuse (F302) on indoor unit control PCB</li> <li>In the case of the fuse opened on an indoor unit control PCB, after correcting wiring connection, it substitutes an EMG plug for OC plug</li> <li>Indoor unit address re-setting</li> </ul> |
| E12              | ☀   | ●     | ●       | <ul style="list-style-type: none"> <li>Auto address setting start is prohibited</li> </ul>  | <ul style="list-style-type: none"> <li>Check the inter-unit control wiring</li> </ul>  |
| E14              | ☀   | ●     | ●       | <ul style="list-style-type: none"> <li>Duplication of main unit in group control</li> </ul>   | <ul style="list-style-type: none"> <li>Check the inter-unit control wiring</li> <li>Check the indoor unit combination</li> </ul>   |
| E15              |   |       |         | Automatic address alarm <ul style="list-style-type: none"> <li>The total capacity of indoor units are too low</li> <li>The total capacity of indoor units are too high</li> <li>The numbers of indoor units are two or more</li> <li>No indoor unit connected</li> </ul>                | <ul style="list-style-type: none"> <li>Check the inter-unit control wiring</li> <li>Check the indoor and outdoor unit control PCB</li> </ul>   |
| E16              | ●   | ●     | ☀       |   |  |
| E20              | ●   | ●     | ☀       | <ul style="list-style-type: none"> <li>Outdoor unit communication error</li> </ul>  | <ul style="list-style-type: none"> <li>Check the outdoor unit control PCB</li> </ul>   |
| E24              |   |       |         | <ul style="list-style-type: none"> <li>Outdoor unit communication error</li> </ul>  | <ul style="list-style-type: none"> <li>Check the outdoor unit control PCB</li> </ul>   |
| E29              |   |       |         | <ul style="list-style-type: none"> <li>Outdoor unit communication error</li> </ul>  | <ul style="list-style-type: none"> <li>Check the outdoor unit control PCB</li> </ul>   |
| F04              |   |       |         | <ul style="list-style-type: none"> <li>Compressor discharge temperature sensor (TD) trouble</li> </ul>  | <ul style="list-style-type: none"> <li>Check the compressor discharge temperature sensor (TD)</li> <li>Check the outdoor unit control PCB</li> </ul>   |
| F06              |   |       |         | <ul style="list-style-type: none"> <li>Outdoor heat exchanger temperature sensor (C1) trouble</li> </ul>  | <ul style="list-style-type: none"> <li>Check the outdoor unit heat exchanger temperature sensor (C1)</li> <li>Check the outdoor unit control PCB</li> </ul>  |
| F07              |   |       |         | <ul style="list-style-type: none"> <li>Outdoor heat exchanger temperature sensor (C2) trouble</li> </ul>  | <ul style="list-style-type: none"> <li>Check the outdoor unit heat exchanger temperature sensor (C2)</li> <li>Check the outdoor unit control PCB</li> </ul>  |
| F08              | ☀   | ☀     | ○       | <ul style="list-style-type: none"> <li>Outdoor air temperature sensor (TO) trouble</li> </ul>   | <ul style="list-style-type: none"> <li>Check the outdoor air temperature sensor (TO)</li> <li>Check the outdoor unit control PCB</li> </ul>  |
| F12              |   |       |         | <ul style="list-style-type: none"> <li>Compressor suction temperature sensor (TS) trouble</li> </ul>  | <ul style="list-style-type: none"> <li>Check the compressor suction temperature sensor (TS)</li> <li>Check the outdoor unit control PCB</li> </ul>   |
| F31              | ☀   | ☀     | ○       | <ul style="list-style-type: none"> <li>Outdoor unit EEPROM trouble</li> </ul>   | <ul style="list-style-type: none"> <li>Check the outdoor unit EEPROM</li> <li>Check the outdoor unit control PCB</li> </ul>  |
| H01              |   |       |         | <ul style="list-style-type: none"> <li>Primary (input) overcurrent detected</li> </ul>  | <ul style="list-style-type: none"> <li>Check the refrigerant cycle (abnormal overload operation)</li> <li>Check the outdoor unit control PCB</li> <li>Check the power supply</li> </ul>  |
| H02              |   |       |         | <ul style="list-style-type: none"> <li>PAM trouble</li> </ul>   | <ul style="list-style-type: none"> <li>Check the outdoor unit control PCB</li> <li>Compressor locked</li> <li>Check the power supply</li> </ul>  |
| H03              | ●   | ☀     | ●       | <ul style="list-style-type: none"> <li>Primary current CT sensor failure</li> </ul>   | <ul style="list-style-type: none"> <li>Check the outdoor unit control PCB</li> </ul>   |
| H31              |   |       |         | <ul style="list-style-type: none"> <li>HIC trouble</li> <li>DC voltage not detected</li> </ul>  | <ul style="list-style-type: none"> <li>Check the outdoor unit control PCB</li> <li>Check the HIC</li> <li>Compressor locked</li> <li>Valve blockage</li> </ul>   |
| L04              |   |       |         | <ul style="list-style-type: none"> <li>Duplication of outdoor unit address</li> </ul>   | <ul style="list-style-type: none"> <li>Check the inter-unit control wiring</li> </ul>  |
| L10              |   |       |         | <ul style="list-style-type: none"> <li>Outdoor unit capacity is not set or setting error</li> </ul>   | <ul style="list-style-type: none"> <li>Replace the outdoor unit EEPROM</li> <li>Capacity value re-setting</li> </ul>   |
| L13              |   |       |         | <ul style="list-style-type: none"> <li>Indoor unit type setting error</li> <li>Type of indoor/outdoor units is different</li> </ul>   | <ul style="list-style-type: none"> <li>Replace the indoor unit EEPROM</li> <li>Check the outdoor unit control PCB</li> <li>Check the type of IU and OU, and re-set address</li> </ul>  |
| L18              | ☀   | ○     | ☀       | <ul style="list-style-type: none"> <li>4-way valve locked trouble / operation failure</li> </ul>  | <ul style="list-style-type: none"> <li>Check the 4-way valve</li> <li>Check the 4-way valve wiring</li> <li>Check the outdoor unit control PCB</li> </ul>  |
| P03              |   |       |         | <ul style="list-style-type: none"> <li>Compressor discharge temperature trouble</li> </ul>  | <ul style="list-style-type: none"> <li>Check the refrigerant cycle (gas leak)</li> <li>Trouble with the electronic expansion valve</li> <li>Check the discharge temperature sensor (TD)</li> </ul>   |
| P04              |   |       |         | <ul style="list-style-type: none"> <li>Compressor discharge pressure trouble</li> </ul>   | <ul style="list-style-type: none"> <li>Check the refrigerant cycle</li> <li>Valve blockage</li> <li>Heat exchanger obstruction</li> </ul>  |
| P05              | ☀   | ●     | ☀       | <ul style="list-style-type: none"> <li>Open phase detected</li> <li>AC power supply trouble</li> </ul>  | <ul style="list-style-type: none"> <li>Check the power supply</li> <li>Check the reactor wiring</li> <li>Check the outdoor unit control PCB</li> <li>Check the compressor wiring</li> </ul>  |
| P13              |   |       |         | <ul style="list-style-type: none"> <li>Valve error</li> <li>Refrigerant circuit error.</li> <li>Wrong installation for refrigerant piping and wiring</li> </ul>   | <ul style="list-style-type: none"> <li>Valve blockage</li> <li>Check the refrigerant circuit</li> <li>Check the refrigerant piping and wiring installation</li> </ul>  |
| P14              | ●   | ☀     | ☀       | <ul style="list-style-type: none"> <li>O<sub>2</sub> sensor detected</li> </ul>   | <ul style="list-style-type: none"> <li>Input from the O<sub>2</sub> sensor</li> </ul>  |

ON: ○ Blinking: ☼ OFF: ●

| Abnormal display | Wireless remote controller receiver display |   |         | Alarm contents   | Error location   |
|------------------|---|---|---------|--|--|
|                  | Operation                                   | Timer   | Standby |  |  |
| Outdoor Unit     | P15   | Operating and standby lamp blinking alternately |         | • Insufficient gas level detected                              | • Check the refrigerant cycle (gas leak)<br>• Trouble with the electronic expansion valve<br>• Valve (or refrigerant circuit) blockage   |
|                  | P16   |   |         | • Compressor overcurrent trouble                               | • Layer short on the compressor<br>• Compressor locked<br>• Check the outdoor unit control PCB   |
|                  | P22   |   |         | • Outdoor unit fan motor trouble<br>• Outdoor unit fan trouble | • Check the outdoor unit fan motor<br>• Check the outdoor unit control PCB   |
|                  | P29   |   |         | • Inverter compressor trouble                                  | • Layer short on the compressor<br>• Check the outdoor unit control PCB<br>• Check the inverter compressor wiring (Open phase/Reverse phase)<br>• Compressor actuation failure (include lock)<br>• Valve (or refrigerant circuit) blockage |
|                  | P31   |   |         | • Indoor unit in group control trouble                         | • Repair indoor unit which blinking alarm  |

### Contents of LED Display on the Outdoor Unit Control PCB (CR)

|  |  | LED1  | LED2 | Remark   |
|--|--|---|------|--|
| Normal operation                                     |  |   |      |  |
| Pre-trip (High pressure protection)                  |  | ○   |      | LED1 Blinking : 0.8sec-ON / 0.3sec-OFF             |
| Pre-trip (other)                                     |  | ○   |      | LED1 Blinking : 0.5sec-ON / 0.5sec-OFF             |
| Automatic address setting                            | Under automatic address setting                              | ○   | ○    | Blinking alternately                               |
|  | Automatic address setting alarm                              | ○   | ○    | Follow the blinking patterns of each alarm         |
| Alternate blinking of outdoor unit LED during alarms |  | LED1 blinks M times, and then LED2 blinks N times. The cycle then repeats.<br>M=2:P alarm, 3:H alarm, 4:E alarm, 5:F alarm, 6:L alarm, N=alarm No<br>Example: LED1 blinks 4 times, then LED2 blinks 6 times. The cycle then repeats. Alarm is "E06" |      |  |
| Power ON sequence                                    | No communication from indoor units in system                 | ●   | ●    | If it is not possible to advance to 3 repeats 1 →2 |
|  | Communication received from 1 or more indoor units in system |   | ●    | At 3, advances to normal control                   |
|  | Regular communication OK (Capacity and unit quantity match)  |   |      |  |
| Refrigerant recovery mode                            |  | ○   | ●    |  |

○ : Blinking    ● : ON

Note : In the case that inter-unit wiring is 30m or longer, you cannot pump-down.  
(It may trigger the operation of the overload protection device.)  
In this case, perform pump-down with pump-down device.

### 2-11. Auto address setting from the outdoor unit

- If the power can be turned ON separately for the indoor and outdoor units in each system:  
The indoor unit addresses can be set without running the compressor.
- Be sure to use a jig for short-circuiting.

- (1) Turn on the indoor and outdoor unit power for refrigerant system 1.  
Short-circuit the A ADD pin.

↓  
Communication for auto address setting begins.

↓  
LED 1 and 2 on the outdoor unit control PCB blink alternately, and turn OFF when address setting is completed.  
<Approximately 4 – 5 minutes are required.>

- (2) Next, turn ON the power only at the indoor and outdoor units in a different system. Short-circuit the A ADD pin.

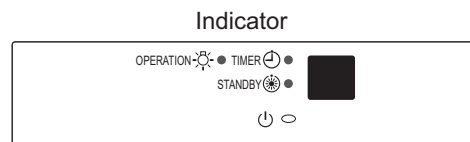
↓  
LED 1 and 2 on the outdoor unit control PCB blink alternately, and turn OFF when address setting is completed.

↓  
Repeat the same procedure for each system and complete auto address setting.

- (3) Operation using the remote controller is now possible.

### 2-12. Test run using the Indicator of the indoor unit (Type K1)

- (1) Press and hold [Emergency Operation] ⏻ button of the indoor unit for four seconds or more.
- (2) Then the lamps on the display will blink one after another.
- (3) Release the button and again press and hold [Emergency Operation] ⏻ button for four seconds or more.
- (4) All indicator lamps on the display blink while test run is in progress.
- (5) Temperature control is not possible during the test run.
- (6) If normal operation is not possible, the lamps on the display will indicate the problem. See the section 2-10.
- (7) After the test run is completed, press [Emergency Operation] ⏻ button and confirm that the indicator lamps stop blinking.  
(A 60-minute automatic OFF timer function is included in order to prevent continuous test run.)



### 2-13. Caution for Pump Down

Pump down means refrigerant gas in the system is returned to the outdoor unit. Pump down is used when the unit is to be moved, or before servicing the refrigerant circuit.

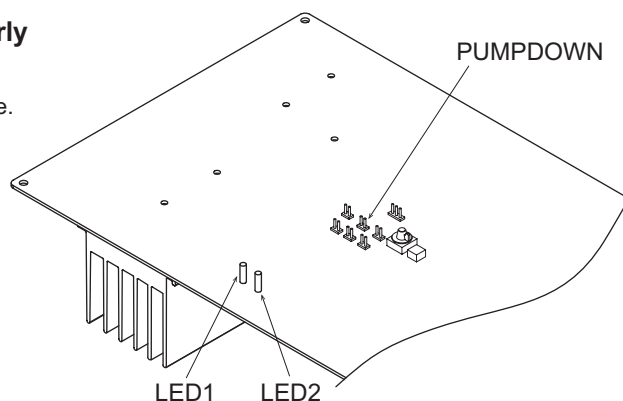


#### CAUTION

- This outdoor unit cannot collect more than the rated refrigerant amount as shown by the nameplate on the back.
- If the amount of refrigerant is more than that recommended, do not conduct a pump down. In this case use another refrigerant collecting system.
- Pay a special attention to the rotating of the fan while operating.

#### How to perform Pump-Down (Refrigerant recovery) properly

- (1) Stop operation of the unit (cooling, heating etc.).
- (2) Connect the pressure gauge to the service port of the gas wiring valve.
- (3) Short-circuit the "PUMPDOWN" pin on an outdoor unit control PCB (CR) for more than 1 second to release.
  - Pump-Down begins and the unit starts operating.
  - During Pump-Down, LED1 blinks and LED2 is lit on an outdoor unit control PCB (CR).
  - "CHK" blinks on the remote controller.
- (4) Fully close the liquid wiring valve 2-3 minutes later.  
The Pump-Down will begin.
- (5) When the pressure gauge drops to 0.1-0.2MPa, close the gas wiring valve tightly and short-circuit the "PUMPDOWN" pin for more than 1 second to release. That is the end of Pump-Down.
  - When running for more than 10 minutes, it stops even if the Pump-Down is not completed.  
Check the blocked state of the liquid side valve.
  - It also stops when the "PUMPDOWN" pin is short-circuited during the operation.



Pay a special attention to the rotating of the fan while operating.

\* For compressor protection, do not operate to the point where the unit wiring side reaches negative pressure.

- U-71PE1E5A, U-100PE1E5A, U-125PE1E5A, U-140PE1E5A  
U-100PEY1E5, U-125PEY1E5  
U-71PE1E8A, U-100PE1E8A, U-125PE1E8A, U-140PE1E8A  
U-100PEY1E8, U-125PEY1E8, U-140PEY1E8

## 2-14. PRECAUTIONS REGARDING TEST RUN

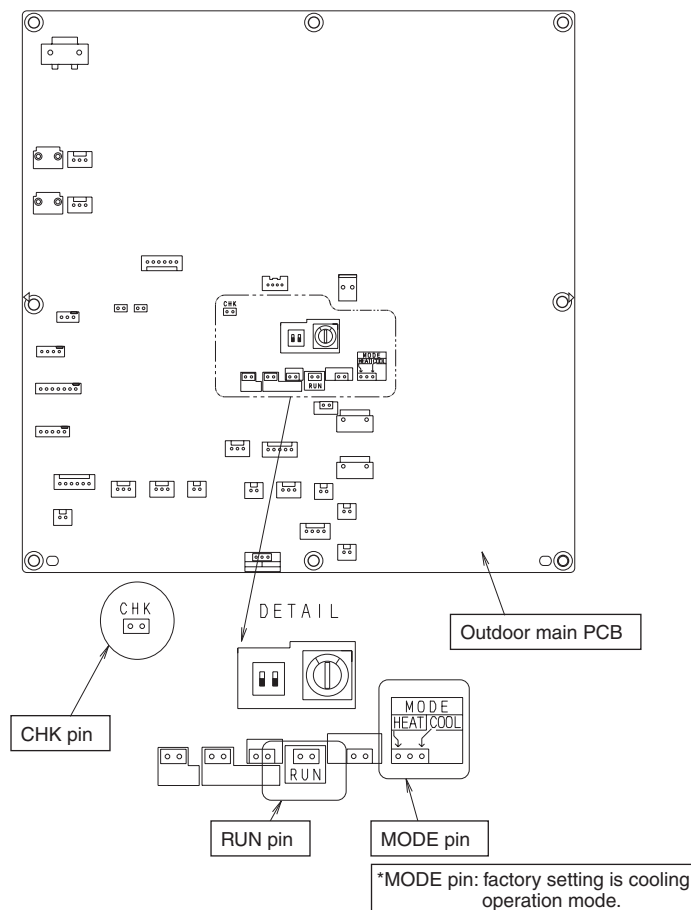
### Check Before Test Run

|  | Content check   |
|--|---|
| Power supply cable<br>Indoor/outdoor connection wire<br>Earth wire | <ul style="list-style-type: none"> <li>● Is the wire set up and connected as described in the instructions? Check for any phase sequence.</li> <li>● Are the wire connection's screws loose?</li> <li>● Is the open and close device / leakage breaker installed?</li> <li>● Is the power supply cable's thickness and length appropriately measured as described in the instructions?</li> <li>● Is it earthed (grounded)?</li> <li>● Check that the insulation resistant value is more than 1 MΩ.<br/>Use the 500 V mega-testers to measure the insulation.<br/>Do not use the mega-tester for any other circuit except for voltage of 220V to 240V or 380-415V.</li> <li>● Are the wire connections for the indoor/outdoor units connected as described in the instructions? Are there any looped wires?</li> <li>● Was the "N-phase" surely connected when connecting the power supply wire on the three-phase model?<br/>If N-phase is not connected, only the fan may repeat turning ON/OFF without the compressor operating. In that case, check if there is any problem with N-phase connection.</li> </ul> |
| Refrigerant pipe   | <ul style="list-style-type: none"> <li>● Is the piping installed as described in the instructions?</li> <li>● Are the pipes sizes appropriate?</li> <li>● Does the pipe's length adhere to the specifications?</li> <li>● Is the branch pipe slant being appropriately done as described in the instructions?</li> <li>● Was vacuum removal sufficiently carried out?</li> <li>● Was the leak tightness test carried out with nitrogen gas? Use the testing pressure of 4.15 MPa.</li> <li>● Is the piping insulation material appropriately installed?<br/>(Insulation material is necessary for both gas and liquid piping.)</li> <li>● Is the 3-way valve for the liquid side and gas side open?</li> </ul>  |

- Always be sure to use a properly insulated tool to operate the short-circuit pin on the circuit board. (Do not use your finger.)
- Never switch the power supply ON until the installation has completed.
- Supply electrical current through all indoor units and check the voltage.
- Supply electrical current through all the outdoor units and check each inter-phase voltage.
- Before the test run, ensure to check that the 3-way valve is open. Operating while the valve is closed causes the compressor to fail.

### Test Run Procedure

- If there are duplicated system addresses, or if the settings for the Nos. of the indoor units are not consistent, an alarm will occur and the system will not start.
- Switch the power supply ON both indoor and outdoor units.
- Short-circuit CHK pin on the outdoor main PCB.  
Do not remove CHK pin until test run is completed.  
Removing CHK pin stops test run.
- Short-circuit RUN pin on the outdoor main PCB for one second or longer.  
Factory setting is cooling operation mode and cooling operation test run starts.  
If heating operation starts, short-circuit both right side and centre of the MODE pin (centre and COOL) continuously.
- Ensure to conduct a test run. In addition, be sure to run the cooling operation test run for at least 20 minutes before starting the heating operation test run.
- To conduct heating operation test run, short-circuit left side and centre of the MODE pin (centre and HEAT) continuously.
- Removing CHK pin's and MODE pin's short-circuit stops test run.
- For the test run using remote control unit, please see installation manual included with the remote control unit.



## 2-15. CHECKS AFTER INSTALLATION HAVE COMPLETED

- Check the following items after completing installation.
  - Is there a short circuit with the intake air flow?
  - Is the insulation secure? (Refrigerant piping)
  - Are there any errors with the wiring?
  - Are the terminal screws loose? Tightening torque (Unit: N•m {kgf•m})  
M4... 1.57 - 1.96 {0.16 - 0.2}, M5... 1.96 - 2.45 {0.2 - 0.25}.
  - Is the drain water flowing smoothly?
  - Is the insulation material properly installed?
  - Is the earth wire securely connected?
  - Is the front panel and the indoor unit air conditioner firmly fixed and was the installation completed without any leakage from the refrigerant?
  - Are the indoor and outdoor units secured firmly installed with bolts at secured locations?

## 2-16. REGARDING DELIVERY TO THE CUSTOMER

- Request the customer to review the instruction manual and explain the operating method for the product.
- In addition, it is also recommended that regular inspection checks are agreed upon for maintenance.

|                              |   |  |
|------------------------------|---|--|
| User inspection places       | ┌ | • Filter and grill cleaning                                    |
|                              | └ | • Exterior cleaning  |
| Serviceman inspection places | ┌ | • Check the operating status                                   |
|                              | └ | • Clean the drain pan or things related to the water discharge |
|                              | └ | • Heat exchanger cleaning                                      |

**Refer to the installation instruction manual provided with the indoor unit for the specifications on the indoor unit installation.**

– MEMO –



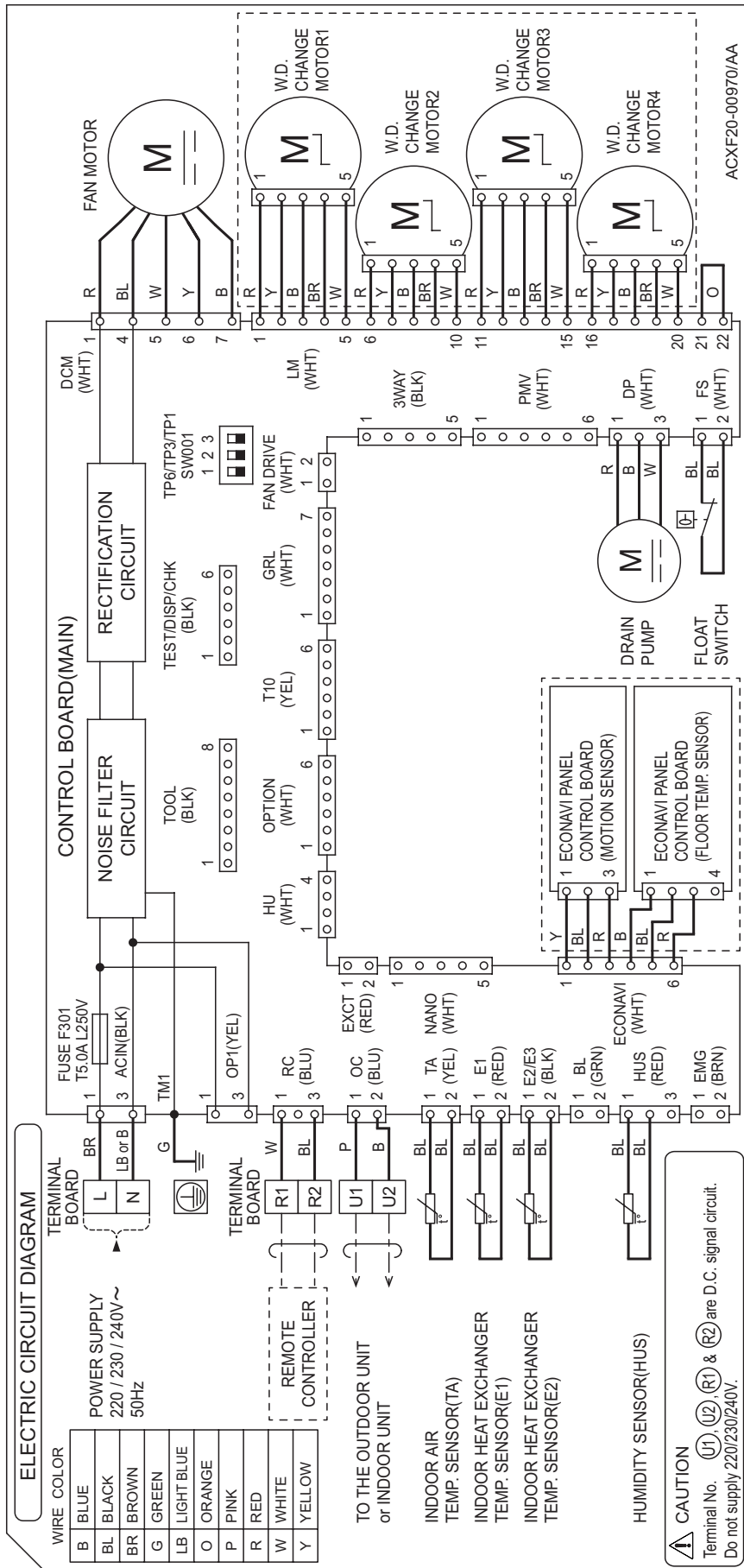
## 3. ELECTRICAL DATA

|   |            |
|---|------------|
| <b>3-1. Indoor Units (Electric Wiring Diagram) .....</b>  | <b>3-2</b> |
| 4-Way Cassette Type .....                                 | 3-2        |
| 4-Way Cassette 60 × 60 Type .....                         | 3-3        |
| Ceiling Type .....  | 3-4        |
| Wall Mounted Type.....                                    | 3-5        |
| Low Silhouette Ducted Type .....                          | 3-6        |
| Ducted Type .....   | 3-7        |
| <b>3-2. Outdoor Units (Electric Wiring Diagram) .....</b> | <b>3-9</b> |

### 3-1. Indoor Units

■ 4-Way Cassette Type S-36PU2E5A / S-45PU2E5A / S-50PU2E5A / S-60PU2E5A / S-71PU2E5A / S-100PU2E5A / S-125PU2E5A / S-140PU2E5A

#### Electric Wiring Diagram



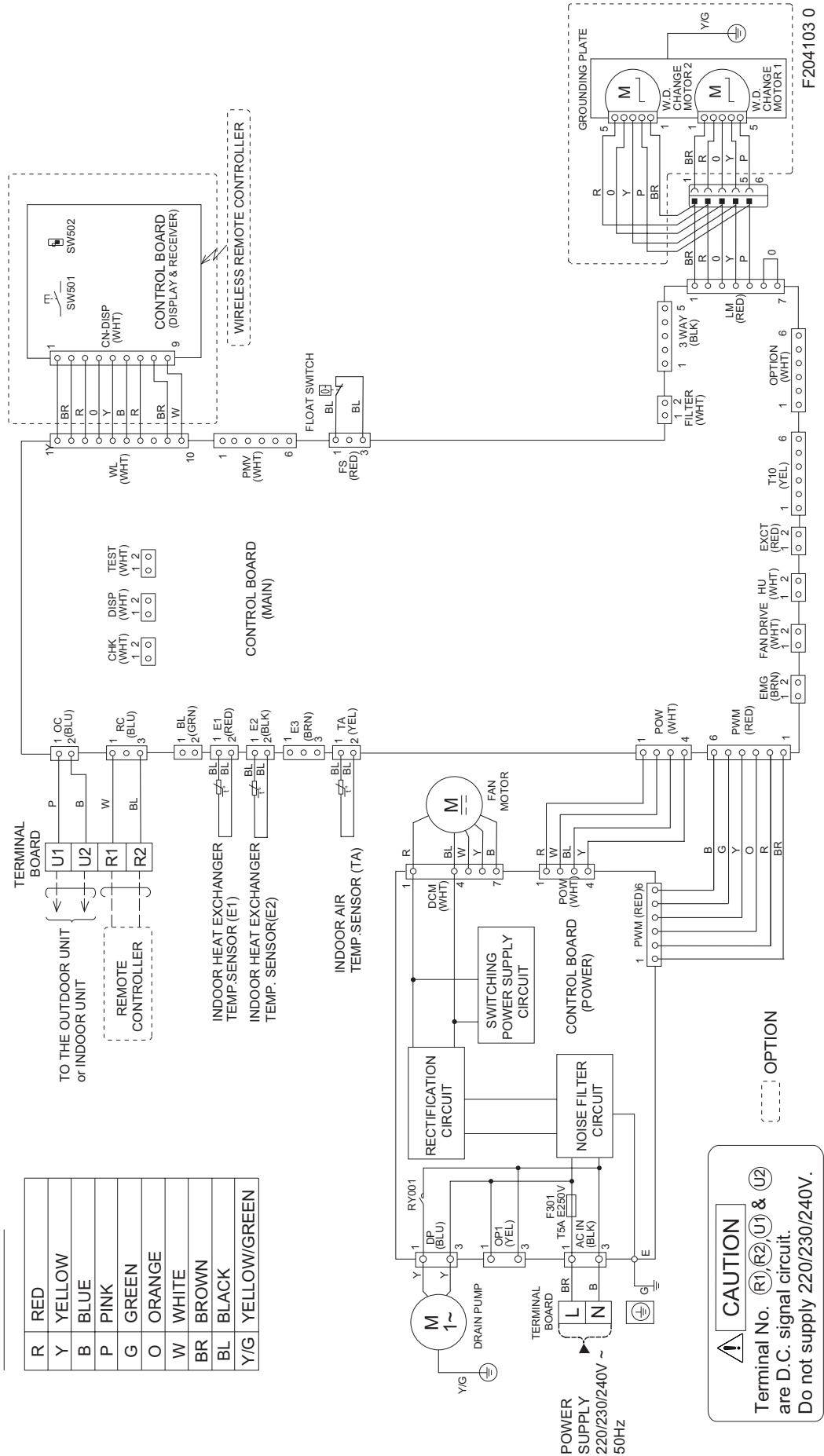
### 3-1. Indoor Units

#### 4-Way Cassette 60 × 60 Type S-36PY2E5A / S-45PY2E5A / S-50PY2E5A Electric Wiring Diagram

### ELECTRIC CIRCUIT DIAGRAM

#### WIRE COLOR

|     |              |
|-----|--------------|
| R   | RED          |
| Y   | YELLOW       |
| B   | BLUE         |
| P   | PINK         |
| G   | GREEN        |
| O   | ORANGE       |
| W   | WHITE        |
| BR  | BROWN        |
| BL  | BLACK        |
| Y/G | YELLOW/GREEN |

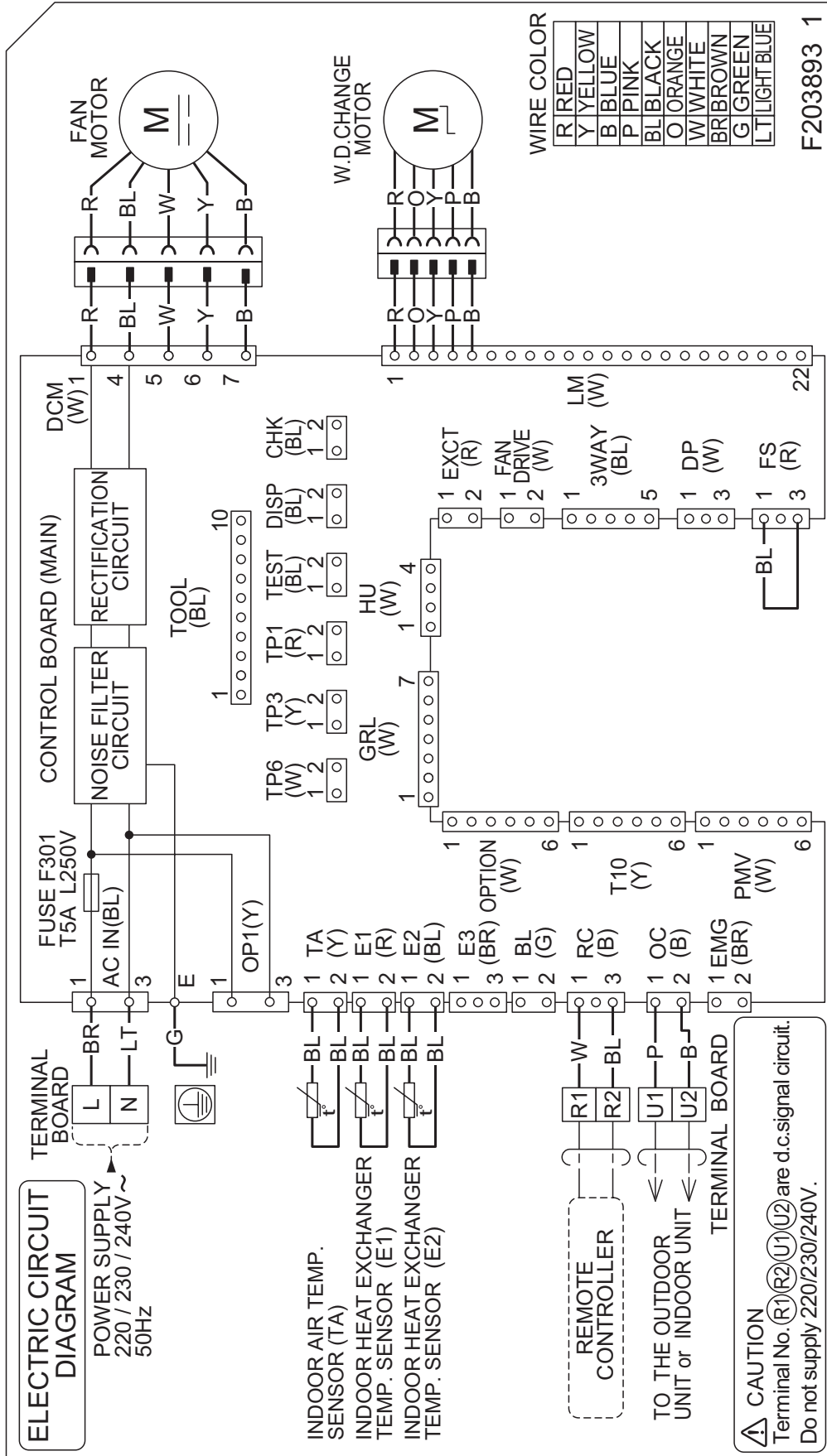


**CAUTION**  
Terminal No. (R1), (E2), (U1) & (U2) are D.C. signal circuit.  
Do not supply 220/230/240V.

### 3-1. Indoor Units

■ Ceiling Type S-36PT2E5A / S-45PT2E5A / S-50PT2E5A / S-60PT2E5A / S-71PT2E5A  
S-100PT2E5A / S-125PT2E5A / S-140PT2E5A

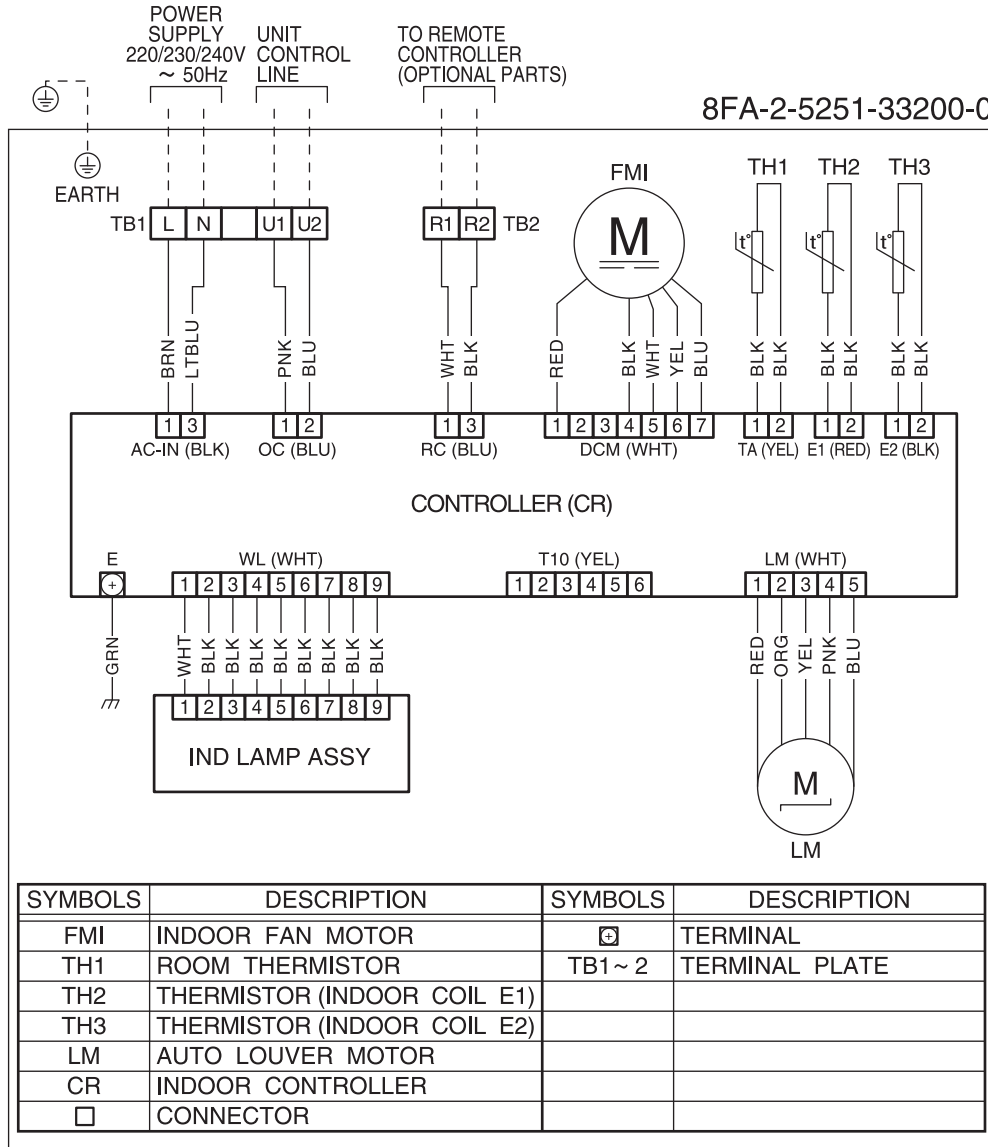
#### Electric Wiring Diagram



### 3-1. Indoor Units

■ Wall Mounted Type S-36PK1E5A / S-45PK1E5A / S-50PK1E5A / S-60PK1E5A / S-71PK1E5A / S-100PK1E5A  
Electric Wiring Diagram

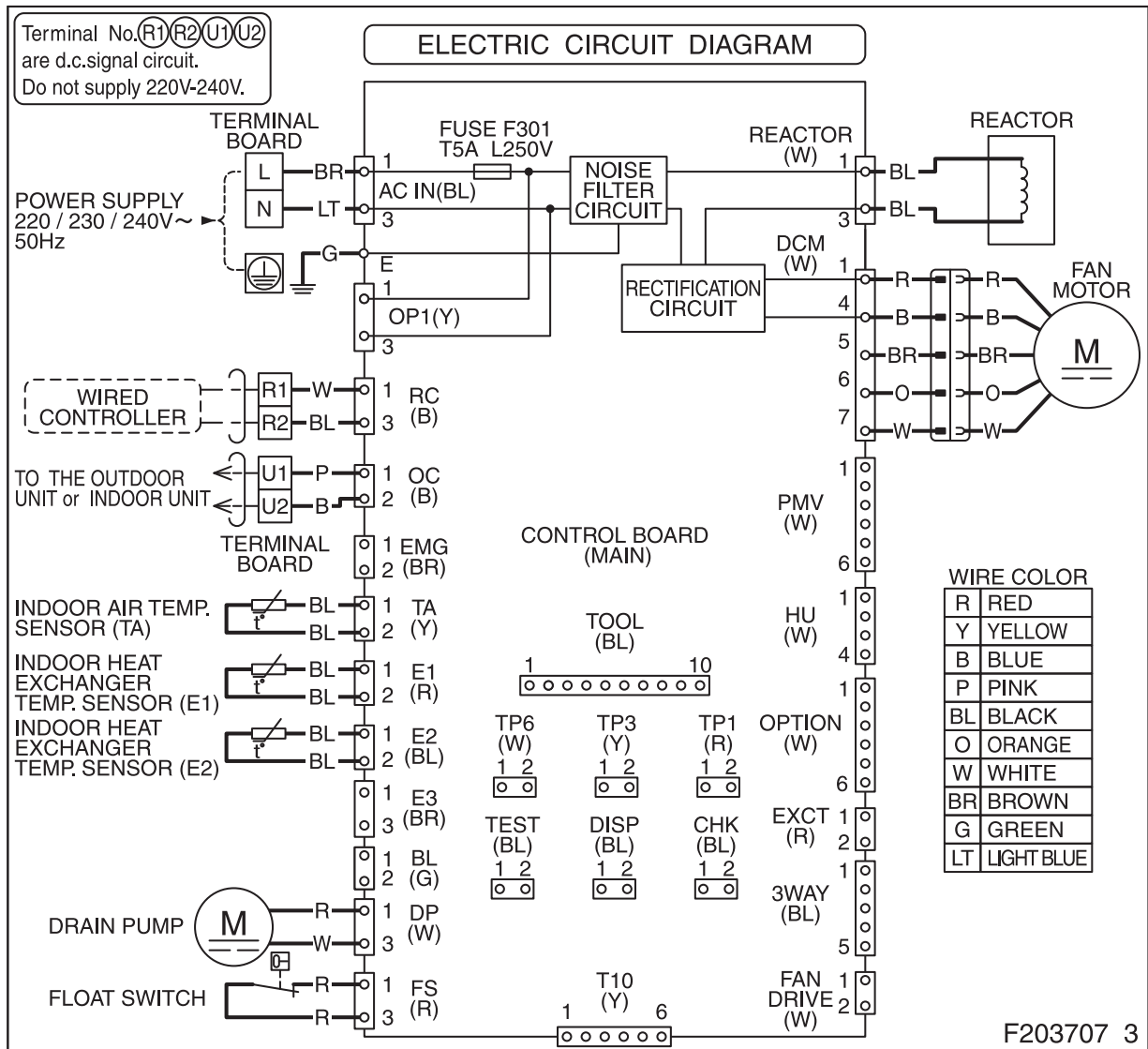
#### ELECTRIC WIRING DIAGRAM



### 3-1. Indoor Units

■ Low Silhouette Ducted Type S-36PF1E5A / S-45PF1E5A / S-50PF1E5A / S-60PF1E5A / S-71PF1E5A  
S-100PF1E5A / S-125PF1E5A / S-140PF1E5A

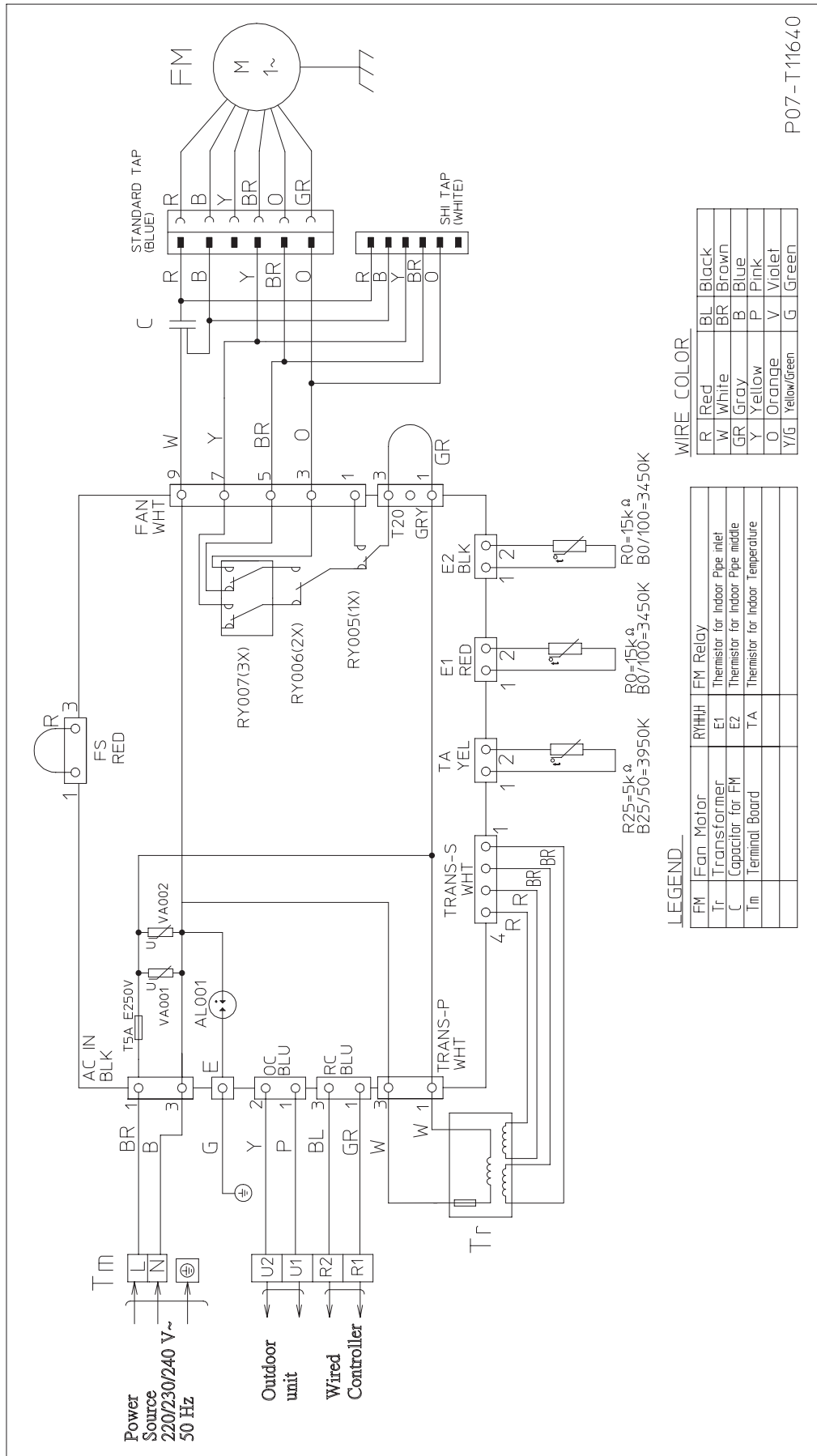
#### Electric Wiring Diagram



### 3-1. Indoor Units

#### ■ Ducted Type S-36PN1E5A / S-45PN1E5A / S-50PN1E5A

#### Electric Wiring Diagram



#### WIRE COLOR

|     |              |    |        |
|-----|--------------|----|--------|
| R   | Red          | BL | Black  |
| W   | White        | BR | Brown  |
| GR  | Gray         | B  | Blue   |
| Y   | Yellow       | P  | Pink   |
| O   | Orange       | V  | Violet |
| Y/G | Yellow/Green | G  | Green  |

#### LEGEND

|    |                  |       |                                   |
|----|------------------|-------|-----------------------------------|
| FM | Fan Motor        | RYHHH | FM Relay                          |
| Ti | Transformer      | E1    | Thermistor for Indoor Pipe inlet  |
| C  | Capacitor for FM | E2    | Thermistor for Indoor Pipe middle |
| Tm | Terminal Board   | TA    | Thermistor for Indoor Temperature |

P07-T11640

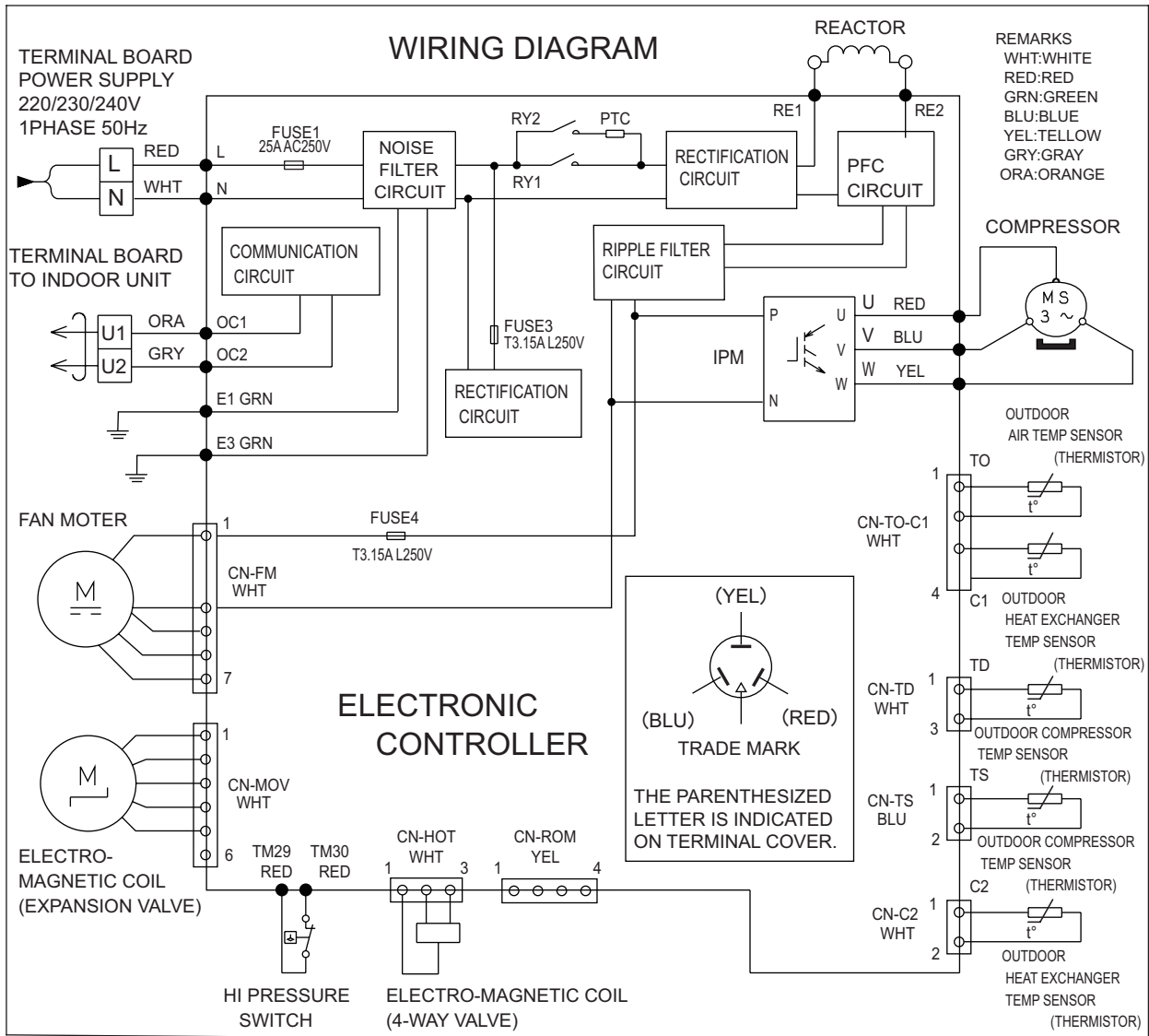




### 3-2. Outdoor Units

■ Single-phase U-36PE2E5A / U-50PE2E5A / U-60PE2E5A  
U-60PEY2E5 / U-71PEY2E5

#### Electric Wiring Diagram

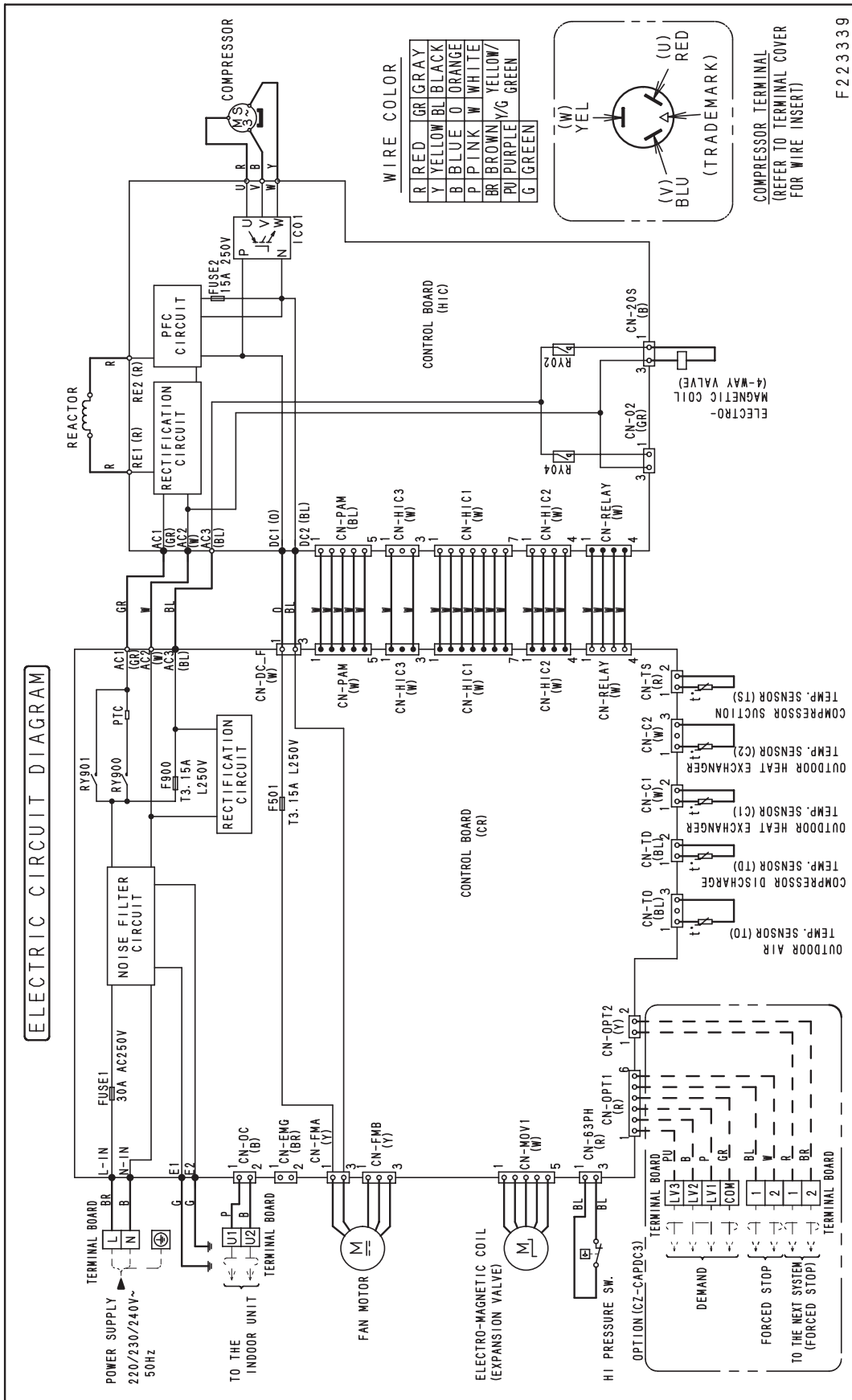


ACXF22-01200

### 3-2. Outdoor Units

#### Single-phase U-71PE1E5A

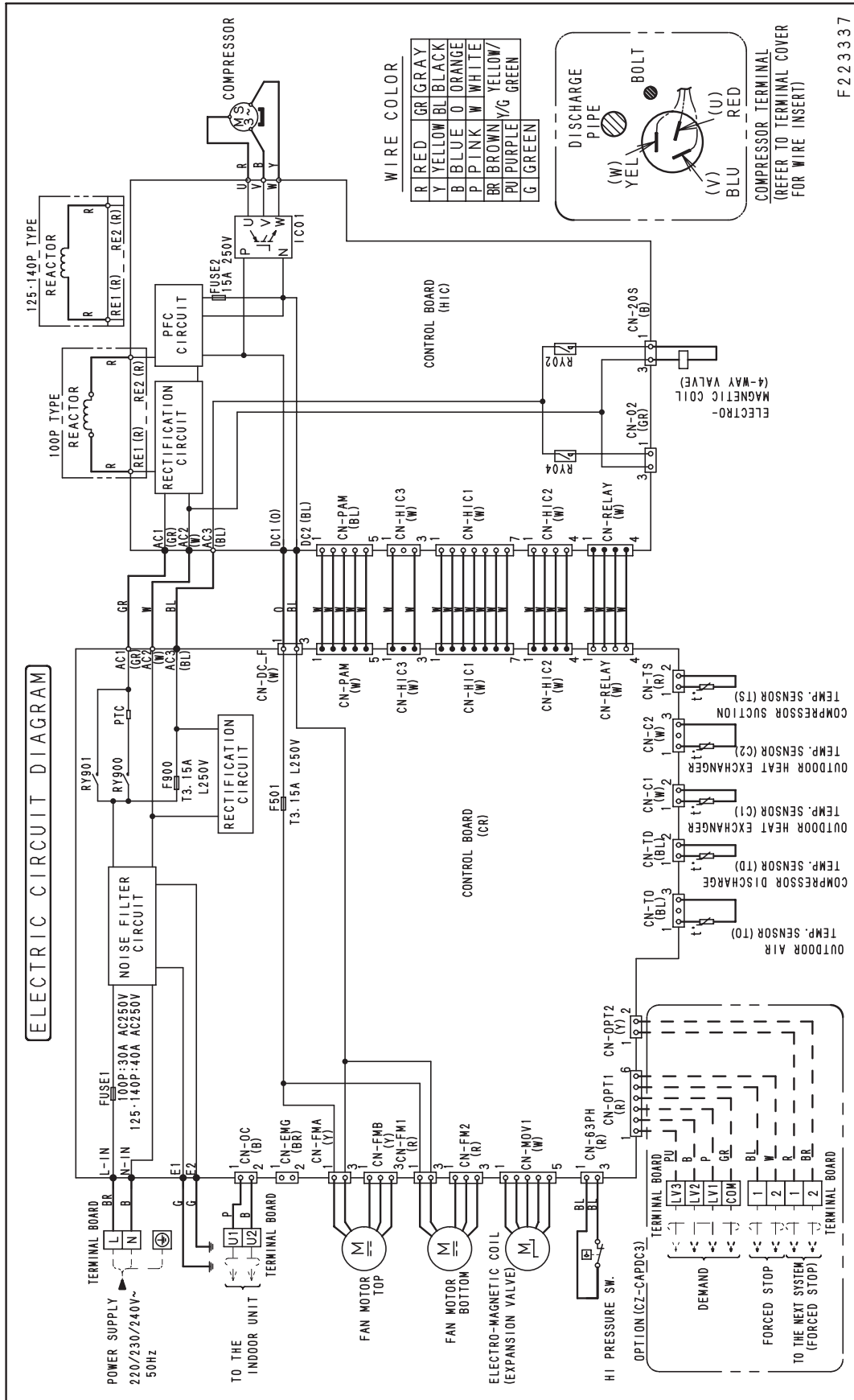
#### Electric Wiring Diagram



### 3-2. Outdoor Units

#### Single-phase U-100PE1E5A / U-125PE1E5A / U-140PE1E5A

#### Electric Wiring Diagram

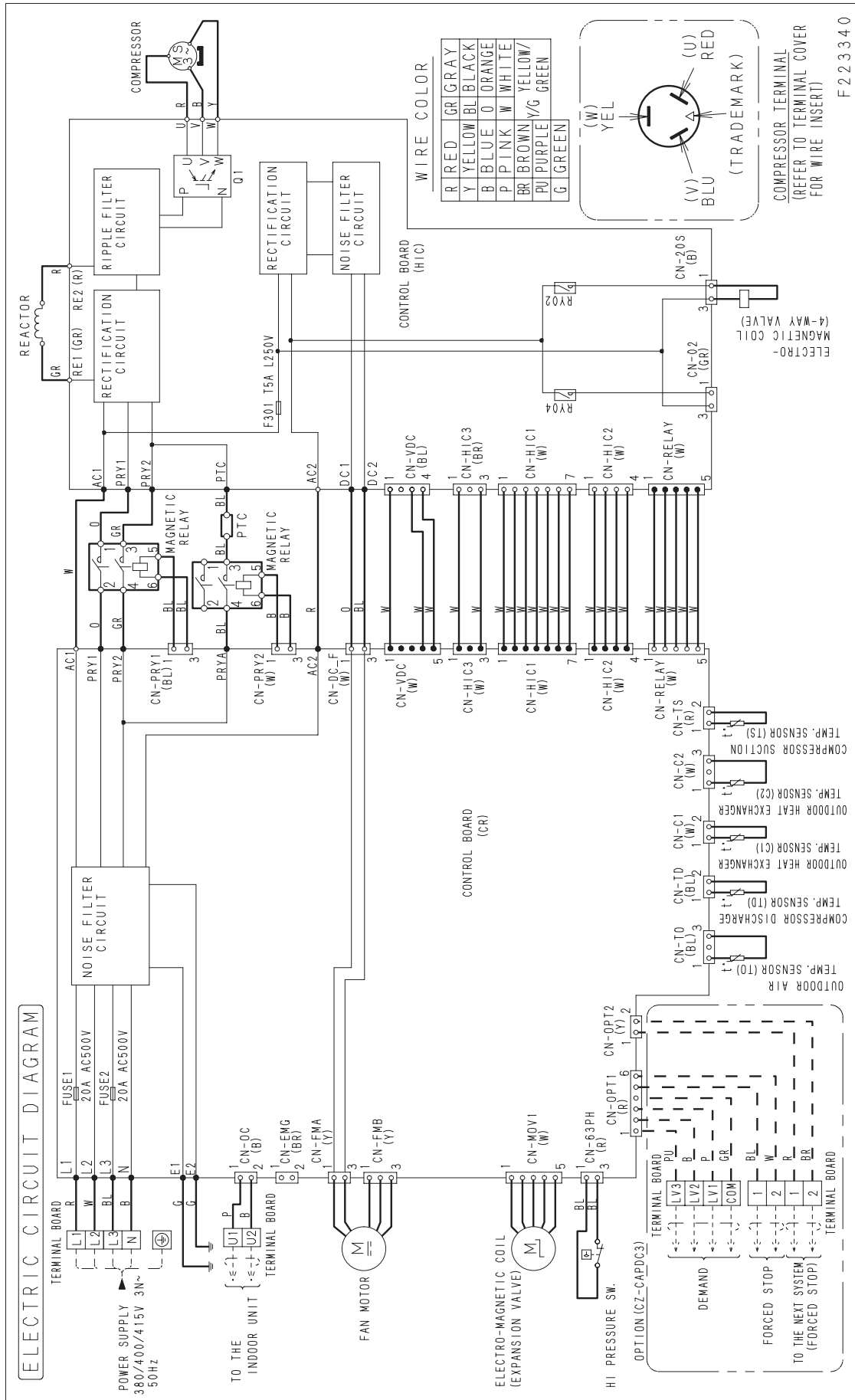




## 3-2. Outdoor Units

### 3-phase U-71PE1E8A

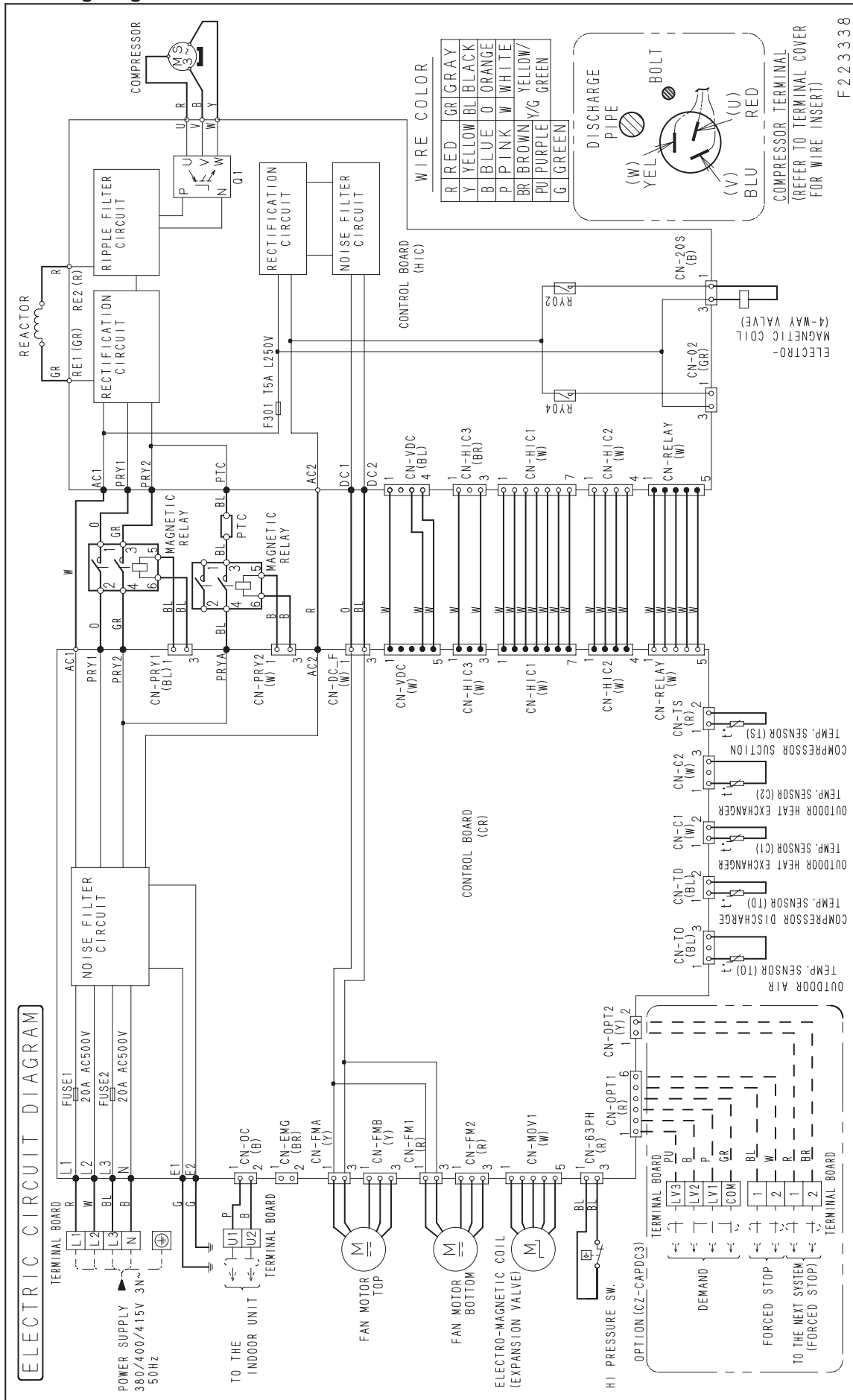
#### Electric Wiring Diagram





### 3-2. Outdoor Units

#### ■ 3-phase U-100PE1E8A / U-125PE1E8A / U-140PE1E8A / U-140PEY1E8 Electric Wiring Diagram



– MEMO –



## 4. CONTROL FUNCTIONS

|       |   |      |
|-------|---|------|
| 4-1.  | Room Temperature Control .....                    | 4-2  |
| 4-2.  | Heating Standby .....                             | 4-4  |
| 4-3.  | Automatic Fan Speed Control .....                 | 4-5  |
| 4-4.  | Drain Pump Control.....                           | 4-6  |
| 4-5.  | Automatic Heating/Cooling Control.....            | 4-7  |
| 4-6.  | Automatic Flap Control.....                       | 4-8  |
| 4-7.  | Filter Sign.....                                  | 4-8  |
| 4-8.  | Fan Control during Dry Mode.....                  | 4-9  |
| 4-9.  | Ventilation Fan Output .....                      | 4-9  |
| 4-10. | T10 Terminal .....                                | 4-9  |
| 4-11. | Parameter .....                                   | 4-10 |
| 4-12. | Control Functions.....                            | 4-11 |
| 4-13. | Outdoor Unit Control PCB                          |      |
|       | 1. [Single-phase Unit] .....                      | 4-23 |
|       | U-36PE2E5A, U-50PE2E5A, U-60PE2E5A                |      |
|       | U-60PEY2E5, U-71PEY2E5                            |      |
|       | 1-1. Functions of Outdoor Unit PCB .....          | 4-25 |
|       | 1-2. Self-Diagnostics Function Table.....         | 4-28 |
|       | 2. [Single-phase Unit] [3-phase Unit] .....       | 4-31 |
|       | U-71PE1E5A, U-100PE1E5A, U-125PE1E5A, U-140PE1E5A |      |
|       | U-100PEY1E5, U-125PEY1E5                          |      |
|       | U-71PE1E8A, U-100PE1E8A, U-125PE1E8A, U-140PE1E8A |      |
|       | U-100PEY1E8, U-125PEY1E8, U-140PEY1E8             |      |
|       | 2-1. Functions of Outdoor Unit PCB .....          | 4-45 |
|       | 2-2. Self-Diagnostics Function Table.....         | 4-48 |

#### 4-1. Room Temperature Control

- The body sensor or remote controller sensor detects temperature in the room. The detected temperature is called the room temperature. The body sensor is the one contained in the indoor unit.

|                          |   |  |
|--------------------------|---|--|
|                          | Body sensor is enabled                            | Remote controller sensor is enabled        |
| Set temp.                | Set temp. in remote controller                    | Set temp. in remote controller             |
| Detected temp. by sensor | Detected temp. by body sensor                     | Detected temp. by remote controller sensor |
| Room temp.               | Detected temp. by body sensor - *correction temp. | Detected temp. by remote controller sensor |

- The thermostat is turned ON or OFF according to the following  $\Delta T$ .

|                      |  |
|----------------------|--|
| $\Delta T$ (Cooling) | $\Delta T = \text{room temp.} - \text{set temp. (set temp. in remote controller)}$ |
| $\Delta T$ (Heating) | $\Delta T = \text{set temp.} - \text{room temp.}$                                  |

※ Correction temperature (only during heating)

If the indoor unit is installed on the ceiling, temperature near the ceiling is higher than near the floor. When the body sensor is enabled, lower temperature near the floor must be considered. To correct this difference in temperature, the correction temperature is used.

The factory setting for the correction temperature is different depending on the model. Refer to “4-11. Parameter”.

Example: Cooling temperature correction

4-Way Cassette (correction temperature: 0 degrees)

Body sensor is enabled

|  |                 |                 |                 |
|--|-----------------|-----------------|-----------------|
| Set temp. in remote controller             | 28°C            | 28°C            | 28°C            |
| Detected temp. by sensor                   | 30.0°C          | 27.5°C          | 27.0°C          |
| Detected temp. by body sensor              | 30.0°C          | 27.5°C          | 27.0°C          |
| Detected temp. by remote controller sensor | 30.0°C          | 27.5°C          | 27.0°C          |
| Room temp. = temp. detected by body sensor | 30.0°C<br>=30.0 | 27.5°C<br>=27.5 | 27.0°C<br>=27.0 |
| $\Delta T$                                 | +2.0deg         | -0.5deg         | -1.0deg         |
|  | Thermostat ON   | Thermostat ON   | Thermostat OFF  |

Example: Heating temperature correction

4-Way Cassette (correction temperature: 4 degrees)

Body sensor is enabled

|  |                       |                       |                       |
|--|-----------------------|-----------------------|-----------------------|
| Set temp. in remote controller                     | 20°C                  | 20°C                  | 20°C                  |
| Detected temp. by sensor                           | 17.0°C                | 22.0°C                | 25.0°C                |
| Detected temp. by body sensor                      | 17.0°C                | 22.0°C                | 25.0°C                |
| Detected temp. by remote controller sensor         | 13.0°C                | 18.0°C                | 21.0°C                |
| Room temp. = temp. detected by body sensor – 4 deg | 13.0°C<br>=17.0-4 deg | 18.0°C<br>=22.0-4 deg | 21.0°C<br>=25.0-4 deg |
| $\Delta T$   | +7.0deg               | +2.0deg               | -1.0deg               |
|  | Thermostat ON         | Thermostat ON         | Thermostat OFF        |

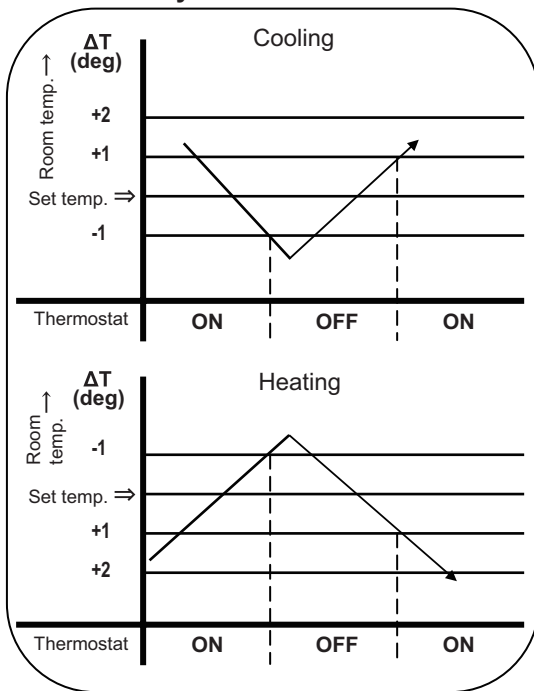
Remote controller sensor is enabled

|   |               |                |                |
|---|---------------|----------------|----------------|
| Set temp. in remote controller                          | 28°C          | 28°C           | 28°C           |
| Detected temp. by sensor                                | 30.0°C        | 27.5°C         | 27.0°C         |
| Detected temp. by body sensor                           | 30.0°C        | 27.5°C         | 27.0°C         |
| Detected temp. by remote controller sensor              | 30.0°C        | 27.5°C         | 27.0°C         |
| Room temp. = temp. detected by remote controller sensor | 30.0°C =30.0  | 27.5°C =27.5   | 27.0°C =27.0   |
| $\Delta T$  | +2.0deg       | -0.5deg        | -1.0deg        |
|   | Thermostat ON | Thermostat OFF | Thermostat OFF |

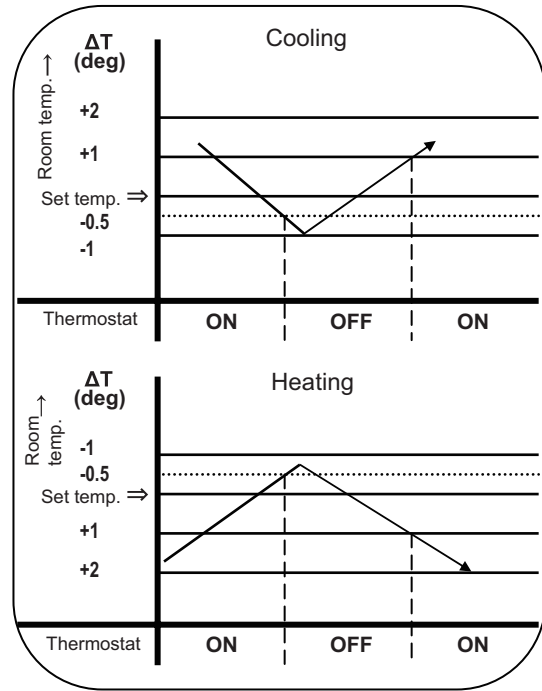
Remote controller sensor is enabled

|   |               |                |                |
|---|---------------|----------------|----------------|
| Set temp. in remote controller                          | 20°C          | 20°C           | 20°C           |
| Detected temp. by sensor                                | 17.0°C        | 20.5°C         | 21.0°C         |
| Detected temp. by body sensor                           | 21.0°C        | 24.5°C         | 25.0°C         |
| Detected temp. by remote controller sensor              | 17.0°C        | 20.5°C         | 21.0°C         |
| Room temp. = temp. detected by remote controller sensor | 17.0°C =17.0  | 20.5°C =20.5   | 21.0°C =21.0   |
| $\Delta T$  | +3.0deg       | -0.5deg        | -1.0deg        |
|   | Thermostat ON | Thermostat OFF | Thermostat OFF |

Body sensor is enabled



Remote controller sensor is enabled



- ① The thermostat does not turn OFF for 3 minutes after it turns ON.
- ② The thermostat does not turn ON 1 to 3 minutes after it turns OFF.
- ③ The thermostat does not turn OFF for 60 minutes during the test run mode. (Forced thermostat ON)  
\*However, the thermostat turns OFF if an alarm occurs.

**4-2. Heating Standby**

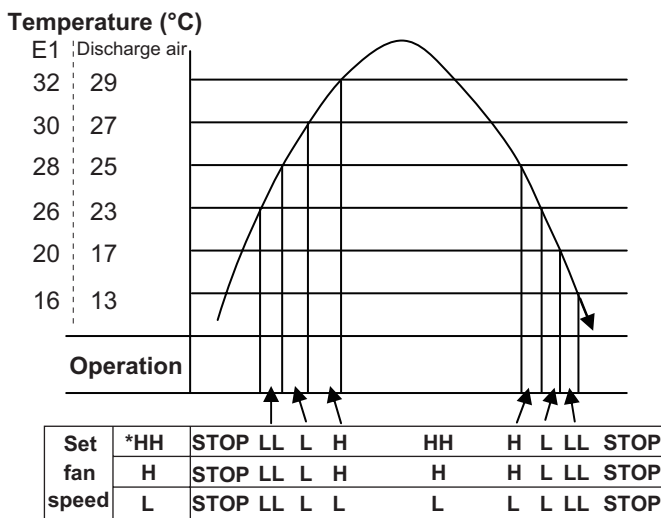
● In heating mode, the indoor fan speed decreases to prevent cold air discharge from the indoor unit. During this time, (heating standby) is displayed on the remote controller.

① This condition occurs in the following cases.

- Thermostat OFF
  - Defrosting operation
  - Indoor heat exchanger liquid temperature (E1) < 28°C and discharge air temperature < 25°C just after heating operation started
- The fan speed may sometimes increase when this condition continues for 6 minutes.

② The fan mode increases when the heat exchanger liquid temperature (E1) or discharge air temperature increases.

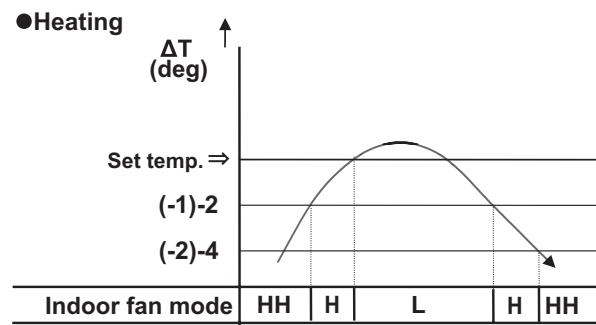
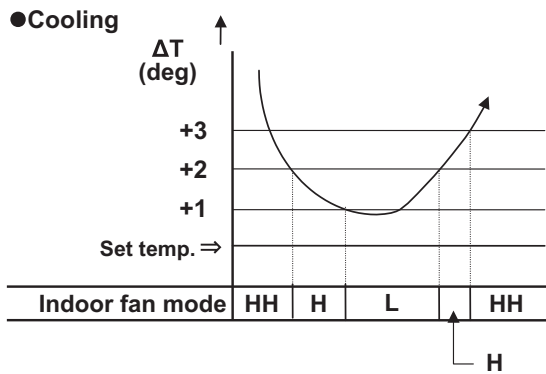
※ The fan mode is selected based on the discharge air temperature and E1 temperature as shown in the below figure. If the E1 temperature and discharge air temperature are different, the higher temperature is used.



※ The function of “HH” is identical to the automatic fan speed mode.

### 4-3. Automatic Fan Speed Control

- ① The indoor fan mode is controlled as shown below during the automatic fan mode.
- ② The fan mode does not change for 3 minutes during cooling operation and 1 minute during heating operation once it is changed.
- ③ The values in the parenthesis are when the remote controller sensor is enabled.



#### 4-4. Drain Pump Control

The drain pump operates in the following conditions.

- ① Cooling thermostat ON
- ② The float switch worked.
- ③ The drain pump may often operate for a while when the cooling thermostat turns OFF or the indoor unit is stopped.
- ④ The drain pump can be turned on when the cooling thermostat is OFF if the setting is made to prevent water collected in the drain pan for a long time. For details, refer to “7-3. Detailed Settings Function.”
- ⑤ The indoor unit heat exchanger liquid temperature (E1) is less than 0°C when the cooling thermostat is OFF or the indoor unit is stopped.

※ The drain pump operates for 20 minutes once it starts operating.

**4-5. Automatic Heating/Cooling Control**

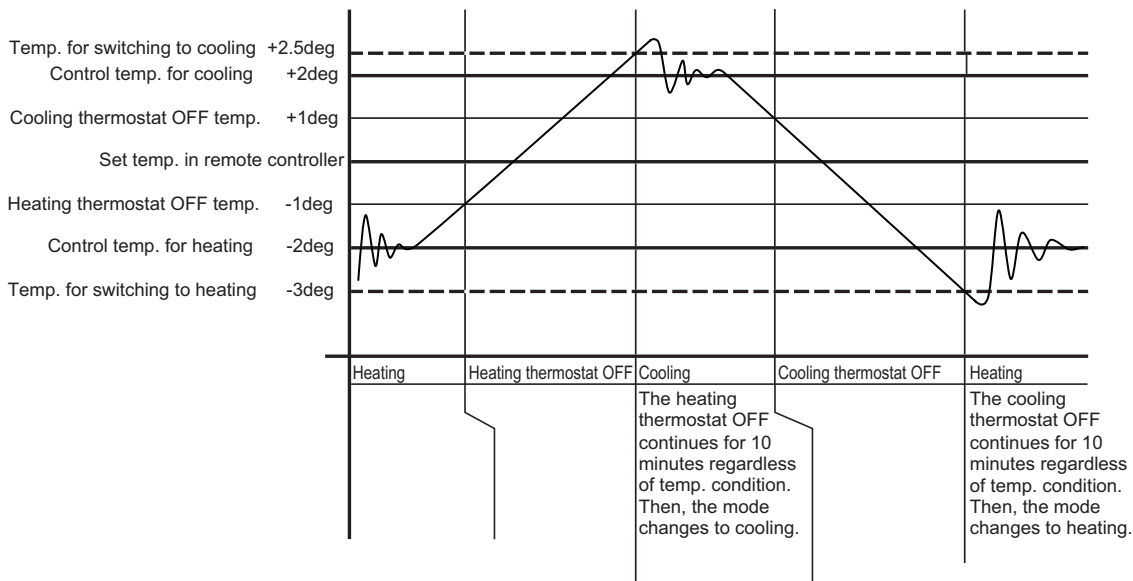
- ① The operating mode is selected according to the set temperature and room temperature when the operation is started.  
 Room temperature  $\geq$  set temperature in remote controller  $- 1^{\circ}\text{C} \rightarrow$  Cooling mode  
 Room temperature  $<$  set temperature in remote controller  $- 1^{\circ}\text{C} \rightarrow$  Heating mode
- ② The set temperature is corrected according to the operating mode. The correction temperature is +2 degrees in cooling mode and -2 degrees in heating mode at the time of factory shipment.  
 ※ The correction value is different depending on the model. Refer to “4-11. Parameter” for details.  
 Corrected cooling temperature – control temperature for cooling  
 Corrected heating temperature – control temperature for heating

When setting temperature in remote controller is  $20^{\circ}\text{C}$  in the cooling mode (at shipment) :

|                                |                      |
|--------------------------------|----------------------|
| Control temp. for cooling      | $22^{\circ}\text{C}$ |
| Set temp. in remote controller | $20^{\circ}\text{C}$ |
| Control temp. for heating      | $18^{\circ}\text{C}$ |

- ③ Condition for mode change  
 Heating  $\rightarrow$  Cooling: Room temperature  $\geq$  Control temperature for cooling  $+ 0.5$  degree  
 Cooling  $\rightarrow$  Heating: Room temperature  $\leq$  Control temperature for heating  $-1.0$  degree

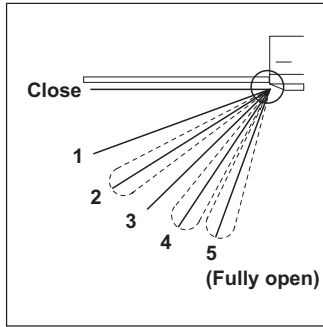
When setting temperature in remote controller is  $20^{\circ}\text{C}$  in the cooling mode :



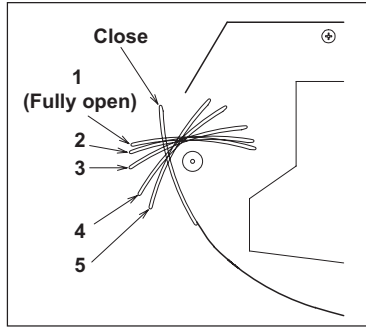
For settings at the time of factory shipment, refer to “4-11. Parameter”.

#### 4-6. Automatic Flap Control

- The flap position can be selected from 5 positions.



Except ceiling type (T2 type)



For ceiling type (T2 type)

| Operating mode | Flap position       |
|----------------|---------------------|
| Cooling/Dry    | 1 · 2 · 3 · 4* · 5* |
| Fan            | 1 · 2 · 3 · 4 · 5   |
| Heating        | 1 · 2 · 3 · 4 · 5   |

\* Only U2

- ① The flap will be closed automatically when the indoor unit is stopped.  
Close: Types K1, T2, U2, Y2
- ② The flap closes once and moves to the set position when the operating mode is changed.  
The flap for the ceiling type (T2), however, moves to the set position directly without closing when the operating mode is changed.

**NOTE**

Do not change the flap position manually.

- ※ Only the swing operation can be used.
- ※ The swing operation can be set for the flap.

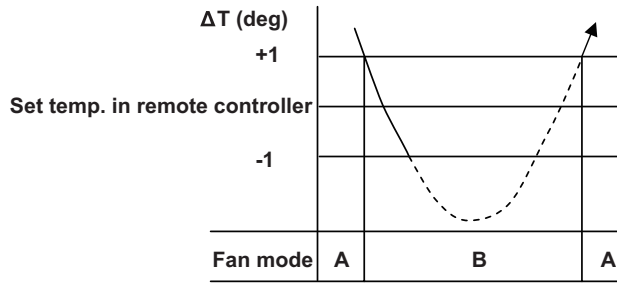
#### 4-7. Filter Sign

- ① When accumulated operating time of the indoor unit reaches the set time, the filter sign appears on the remote controller. Clean the filter.  
Refer to “7-2. List of Simple Setting Items, 7-5. Simple setting items and Filter sign ON times for each model”.
- ② After cleaning the filter, press the filter button on the remote controller once. The filter sign turns off.



#### 4-8. Fan Control during Dry Mode

The fan control during dry mode is as follows.



A: Fan mode set in the remote controller

B: Fan mode is L during thermostat ON, LL during thermostat OFF

※ For details on  $\Delta T$ , refer to “4-1. Room Temperature Control”.

#### 4-9. Ventilation Fan Output

- The output of ventilation turns ON when the indoor unit turns ON. Also, when the indoor unit turns OFF, the output of the ventilation turns OFF.
- The ventilation fan can also be turned ON and OFF using the ventilation button on the remote controller.

Refer to the operating instructions supplied with the remote controller.

To enable this function, set the indoor EEPROM DN31 to “0001” in advance.

#### 4-10. T10 Terminal

Using the T10 terminal, each indoor unit can be operated or stopped separately. Also, operating condition can be checked.

4-11. Parameter

| Type | Model                 | Correction temp. (heating)          | Heat/cool switching correction temp. (automatic heat/cool) |
|------|-----------------------|-------------------------------------|--|
|      |                       | Setting at time of factory shipment | Setting at time of factory shipment                        |
| U2   | 4-Way Cassette        | 4 deg                               | 2 deg  |
| Y2   | 4-Way Cassette 60x60  | 4 deg                               | 2 deg  |
| T2   | Ceiling               | 4 deg                               | 2 deg  |
| K1   | Wall Mounted          | 2 deg                               | 2 deg  |
| F1   | Low Silhouette Ducted | 4 deg                               | 2 deg  |
| N1   | Ducted                | 4 deg                               | 2 deg  |

**4-12. Control Functions**

- **PE** Single-phase : U-36PE2E5A, 50PE2E5A, 60PE2E5A
- **PEY** Single-phase : U-60PEY2E5, 71PEY2E5

**4-12-1. Indoor Air Temperature Control**

The thermostat is switched on and off in accordance with  $\Delta T$  shown below.

|  |  |
|--|--|
| $\Delta T = (\text{Indoor air temperature}) - (\text{Temperature set with the remote controller})$ |  |
| In the body thermostat mode (setting at factory shipment)  | Indoor air temperature = (Body sensor) - (Shift temperature *) |
| In the remote controller thermostat mode   | Indoor air temperature = (Remote controller sensor)            |

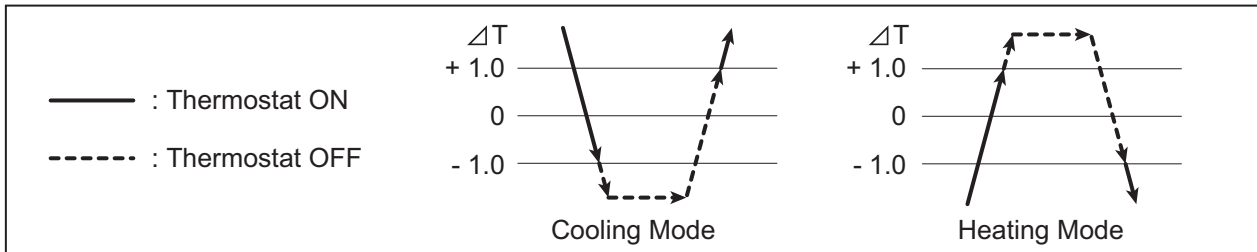
**\* Shift Temperature**

Only valid during heating operation. Set at 0 °C during cooling operation.

The settings at factory shipment during heating operation are as follows:

- Wall Mounted type : 2°C
- Floor Standing type : 0°C
- All other types (4-way types, Concealed types, etc.) : 4°C

This function acts as the coefficient for adjusting differences in temperature caused by the height of the living space from the floor to the ceiling (the temperature at ceiling height is higher) during heating operation. The setting can be modified between 0°C and 6°C with mode [06] (Simple Settings Function) on the remote controller.



- (1) Once the thermostat has been switched on, it cannot be switched off again by indoor air temperature control for a period of 10 minutes.
- (2) Once the thermostat has been switched off, it cannot be switched on again for a period of 3 minutes.
- (3) When in the test run operation mode, the thermostat will not be switched off by indoor air temperature control and the operation will continue.

**4-12-2. Compressor Frequency Control**

The frequency of the compressor's inverter is limited by either of the following controls depending on whether the cooling or heating mode is in operation.

**Cooling Mode :**

- Indoor air temperature control
- Maximum and minimum frequency control
- Current release control
- Cooling high-load prevention control
- Cooling freeze prevention control
- Discharge temperature control

**Heating Mode :**

- Indoor air temperature control
- Maximum and minimum frequency control
- Current release control
- Heating high-load prevention control
- Discharge temperature control

## 1) Indoor Air Temperature Control

By the control method, not only the thermostat is switched on and off, as explained section "4-12-1. Indoor Air Temperature Control", but also the frequency of the compressor's inverter is controlled in accordance with  $\Delta T$  and fluctuations in indoor air temperature. Inverter frequency is controlled as follows:

|  |   |
|--|---|
| When $\Delta T$ is high (not yet reached the temperature set with the remote controller).                                  | Controlled so that the inverter frequency is increased.         |
| When $\Delta T$ is low (approximately +1.0 or less in the cooling mode or approximately -1.0 or more in the heating mode). | Controlled so that the inverter frequency is decreased or kept. |
| When the indoor air temperature is rising in the cooling mode and dropping in the heating mode.                            | Controlled so that the inverter frequency is increased.         |
| When the indoor air temperature is dropping in the cooling mode and rising in the heating mode.                            | Controlled so that the inverter frequency is decreased.         |

\* The fluctuations of the compressor inverter frequency adjustments are calculated taking into account not only  $\Delta T$ , but also fluctuations in indoor air temperature.

## 2) Maximum and Minimum Frequency Control

The compressor's inverter frequency is controlled in accordance with the model and operation mode. The maximum and minimum frequencies for each model are shown in the table below.

\* There are cases in which frequency is limited with other control functions depending on operational conditions, so operations are not always carried out in accordance with the maximum frequencies listed below.

· Maximum and Minimum Frequency

|                        |         | PE       |          |          | PEY      |          |
|------------------------|---------|----------|----------|----------|----------|----------|
|                        |         | 36PE2E5A | 50PE2E5A | 60PE2E5A | 60PEY2E5 | 71PEY2E5 |
| Maximum Frequency (Hz) | Cooling | 75       | 80       | 90       | 90       | 98       |
|                        | Heating | 80       | 95       | 115      | 115      | 115      |
| Minimum Frequency (Hz) | Cooling | 14       | 14       | 14       | 14       | 14       |
|                        | Heating | 15       | 15       | 15       | 15       | 15       |

\* There is a case in which the frequency is set at 24.0Hz to protect the compressor in accordance with ambient temperature and indoor loads.

## 3) Current Release Control

The inverter frequency is controlled so that the current value for the inverter compressor is less than the figure listed in the table below in order to prevent abnormal increases in the inverter circuit located within the outdoor unit's electrical box.

Current release control with primary current : The limited values are modified in accordance with ambient temperature.

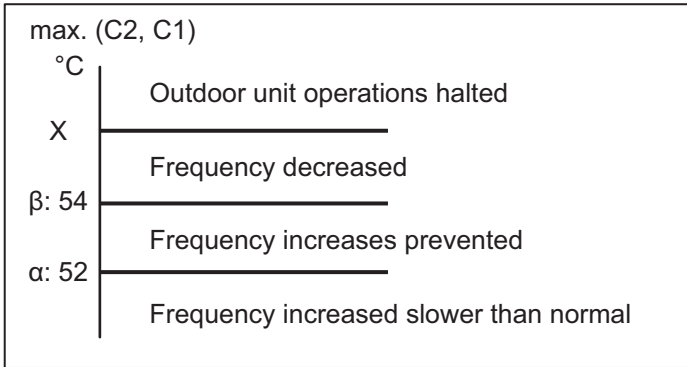
|        |         | PE       |          |          | PEY      |          |
|--------|---------|----------|----------|----------|----------|----------|
|        |         | 36PE2E5A | 50PE2E5A | 60PE2E5A | 60PEY2E5 | 71PEY2E5 |
| Is (A) | Cooling | 9.5      | 9.5      | 13.2     | 13.2     | 13.2     |
|        | Heating | 11       | 12       | 16.5     | 16.5     | 16.5     |

#### 4) Condensation Temperature Control (cooling)

This system control is performed to limit the inverter frequency in order to restrict high pressure's abnormal increase and high-load operating prevention in the cooling mode.

In accordance with the temperature of the outdoor heat exchanger temperature sensors (C1, C2), such controls are performed as to halting the operations of the indoor unit, decreasing the inverter frequency and restricting its increase, etc.

- (a) The threshold value is decreased in accordance with the compressor frequency or indoor load (differences of temperature).
- (b) When "X" values are lowered, the results basically become  $\beta=X-2$ ,  $\alpha=X-3$ .



Outdoor EEPROM : Amendment of X values can be made due to 4B.

EEPROM setting in outdoor unit  
CODE: 4B

| Setting No. | -2 | -1   | 0    | 1 *1 |
|-------------|----|------|------|------|
| X (°C)      | 52 | 56.5 | 58.5 | 60   |

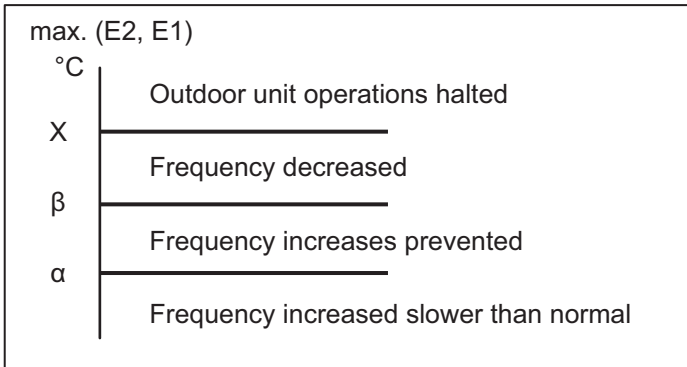
\*1 Setting at factory shipment

#### 5) Condensation Temperature Control (heating)

This system control is performed to limit the inverter frequency in order to restrict high pressure's abnormal increase and high-load operating prevention in the heating mode.

In accordance with the temperature of the indoor heat exchanger temperatures sensor (E1, E2), such controls are performed as to halting the operations of the indoor unit, decreasing the inverter frequency and restricting its increase, etc.

- (a) The threshold value is decreased in accordance with the compressor frequency or indoor load (differences of temperature).
- (b) When "X" values are lowered, the results basically become  $\beta=X-2$ ,  $\alpha=X-3$ .



Outdoor EEPROM : Amendment of X values can be made due to 4B.

EEPROM setting in outdoor unit  
CODE: 4B

| Setting No. | -2 | -1   | 0    | 1 *1 |
|-------------|----|------|------|------|
| X (°C)      | 52 | 56.5 | 58.5 | 60   |

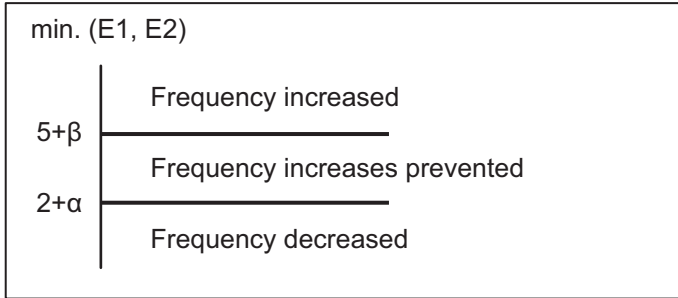
\*1 Setting at factory shipment

|          | U-36PE2E5A<br>U-50PE2E5A | U-60PE2E5A<br>U-60PEY2E5, U-71PEY2E5 |
|----------|--------------------------|--------------------------------------|
| $\beta$  | 51                       | 52                                   |
| $\alpha$ | 47                       | 48                                   |

## 6) Cooling Freeze Prevention Control

The following control is performed during cooling operations (including dry mode operation), in accordance with whichever of the indoor heat exchanger temperatures (E1 or E2) is lower. (See the chart below.)

- (a) Frequency will not be decreased less than 6 minutes after thermostat ON.
- (b) The threshold value is increased in accordance with the indoor load (differences of temperature).



Outdoor EEPROM : Amendment of  $\alpha$  and  $\beta$  values can be made due to 3F or 40.

EEPROM setting in outdoor unit

CODE: 3F (for  $\alpha$  setting)

|             |     |       |     |       |   |
|-------------|-----|-------|-----|-------|---|
| Setting No. | -15 | ..... | 0 * | ..... | 9 |
| $\alpha$    | -15 |       | 0   |       | 9 |

CODE: 40 (for  $\beta$  setting)

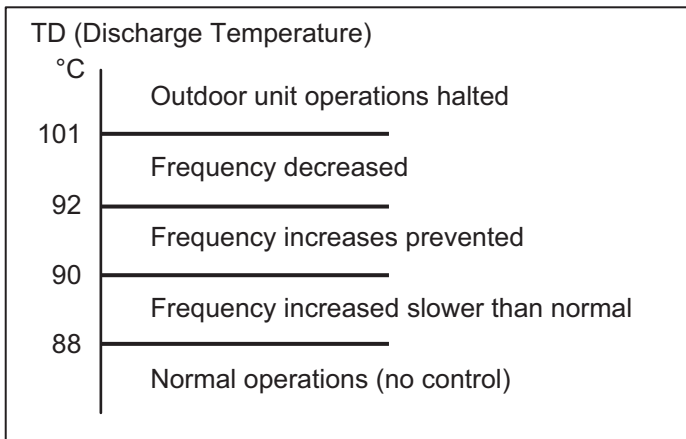
|             |     |       |     |       |   |
|-------------|-----|-------|-----|-------|---|
| Setting No. | -15 | ..... | 0 * | ..... | 9 |
| $\beta$     | -15 |       | 0   |       | 9 |

\* Setting at factory shipment

## 7) Discharge Temperature Control

The following control is performed to prevent the discharge temperature from rising abnormally in order to protect the inverter compressor.

In accordance with the temperature of the discharge sensor TD, such controls are performed as to limiting the increase of inverter frequency, decreasing it or halting operation of the compressor.



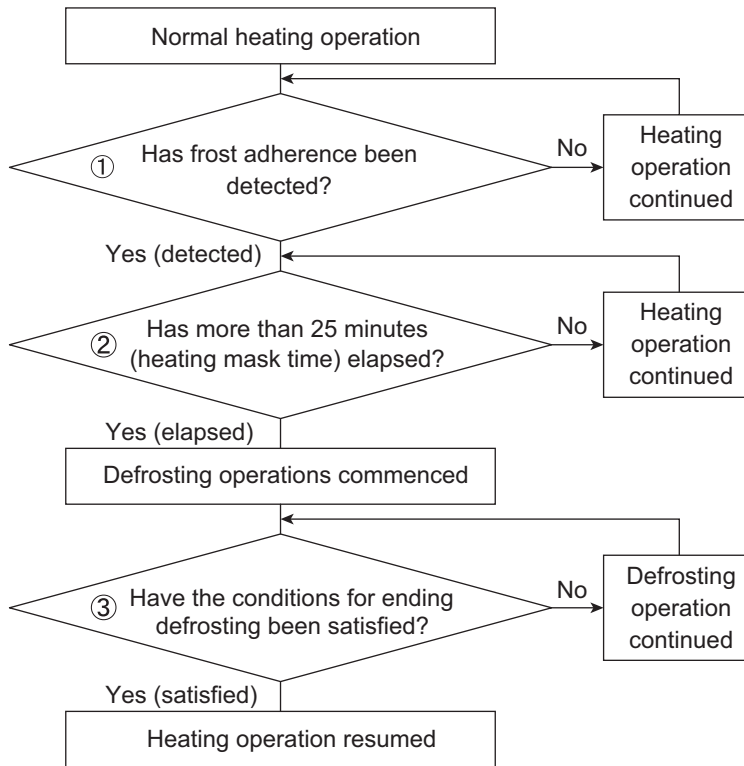
\* If the discharge temperature exceeds 101°C, operations of the compressor are halted and restarted after 3 minutes.

If this start/stop activity is repeated 5 times, the alarm "P03" (abnormal discharge temperature) occurs.

## 8) Defrosting Control

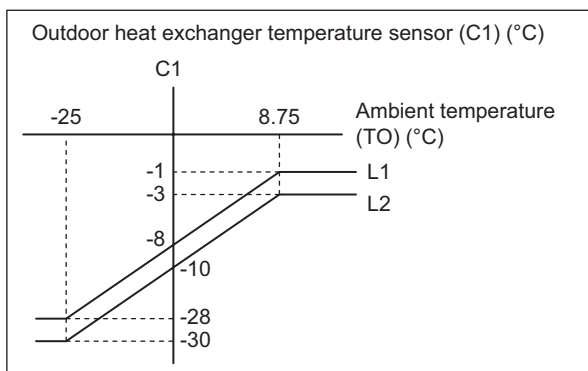
This control function removes frost that has adhered to the outdoor heat exchanger during the heating operation. The control is performed to prevent the deterioration of the heating capabilities attributed to the adherence of frost, and to prevent the crack or crush of pipes attributed to the accretion of ice. The following control is performed in accordance with the ambient temperature and the outdoor heat exchanger temperature sensor (C1).

### Overall Flow Chart of Defrosting Control



#### ① Frost adherence detection

- If the following conditions are satisfied during heating operations, it is regarded as "frost adherence is detected".
- Frost adherence detection is performed in accordance with the ambient temperature (TO) and the outdoor heat exchanger temperature sensor (C1).
- Frost adherence detection conditions
  - (a) Following satisfied condition is detected for accumulation of 60 minutes.  
Outdoor heat exchanger temperature sensor (C1)  $\leq$  L1
  - (b) Following satisfied condition is detected for consecutive 2 minutes or more, 2 times.  
Outdoor heat exchanger temperature sensor (C1)  $\leq$  L2



- (c) Following satisfied condition is detected for accumulation of over 90 minutes.  
Outdoor heat exchanger temperature sensor (C1)  $<$  -3 °C

#### ② Heating Mask Time

This refers to the shortest time that heating operations must be performed without defrosting operations being executed. The mask time for this model is 25 minutes.

- \* Defrosting operations will not be commenced until the defrosting mask time has elapsed, even if frost adherence has been detected.

### ③ Ending Defrosting

Defrosting operations are ended when the following conditions are satisfied.

- Ending defrosting conditions
  - (a) When the temperature of the outdoor heat exchanger temperature sensor (C1) is 8°C or higher.
  - (b) When the temperature of the outdoor heat exchanger temperature sensor (C1) is 6°C or higher for consecutive 60 seconds.
  - (c) When a maximum of 15 minutes defrosting time has elapsed.

### 9) Outdoor Unit Fan Control

The appropriate rotations per minute for the outdoor unit fan are determined in accordance with the ambient temperature and the frequency of the compressor inverter.

The outdoor unit fan step is controlled between a range of W1 (Step 1) and WF (Step 15).

### 10) Outdoor Unit's Electrical Expansion Valve Control

The electrical expansion valve controls the amount of refrigerant that is allowed to flow in accordance with the operation status.

The valve is adjusted in accordance with the discharge temperature (TD), the outdoor heat exchanger temperature sensor (C1 and C2), the suction temperature sensor (TS), and the indoor unit's heat exchanger temperature sensors (E1).

#### (1) Cooling Mode

Controlled so that the suction temperature (TS) - indoor heat exchanger temperature (E1) is between 0 degree and 2 degrees under normal conditions.

There are cases where the aperture opens wider than normal operation if the discharge temperature increases.

#### (2) Heating Mode

Controlled so that the suction temperature (TS) - outdoor heat exchanger temperature minimum (C1 and C2) is between 0 degree and 2 degrees under normal conditions.

There are cases where the aperture opens wider than normal operation if the discharge temperature increases.

### 11) Demand Control

#### U-36PE2E5A, U-50PE2E5A, U-60PE2E5A

Demand control can be operated by using a wired remote controller. (model CZ-RTC5A)

The setting of current control values during demand operation can be made in 5% increments between 40% and 100% rated current by using a wired remote controller. (model CZ-RTC5A)



- **PE** Single-phase : U-71PE1E5A, 100PE1E5A, 125PE1E5A, 140PE1E5A
- **PE** 3-phase : U-71PE1E8A, 100PE1E8A, 125PE1E8A, 140PE1E8A
- **PEY** Single-phase : U-100PEY1E5, 125PEY1E5
- **PEY** 3-phase : U-100PEY1E8, 125PEY1E8, 140PEY1E8

### 4-12-3. Indoor Air Temperature Control

The thermostat is switched on and off in accordance with  $\Delta T$  shown below.

|  |  |
|--|--|
| $\Delta T = (\text{Indoor air temperature}) - (\text{Temperature set with the remote controller})$ |  |
| In the body thermostat mode<br>(setting at factory shipment)                                       | Indoor air temperature = (Body sensor) - (Shift temperature *) |
| In the remote controller thermostat mode   | Indoor air temperature = (Remote controller sensor)            |

\* Shift Temperature

Only valid during heating operation. Set at 0 °C during cooling operation.

The settings at factory shipment during heating operation are as follows:

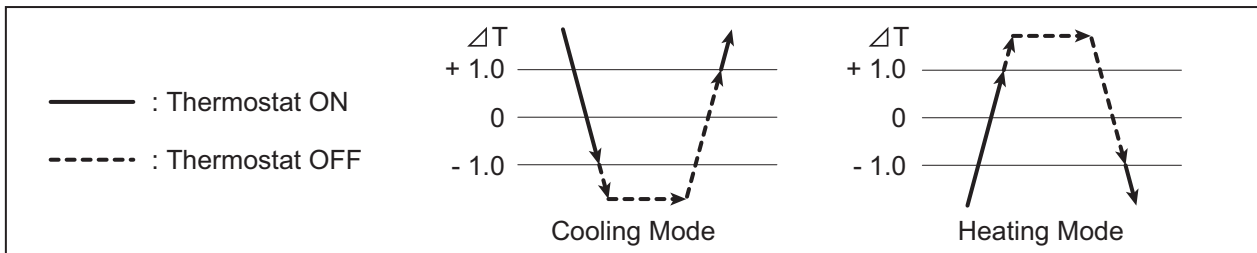
Wall Mounted type : 2°C

Floor Standing type : 0°C

All other types (4-way types, Concealed types, etc.) : 4°C

This function acts as the coefficient for adjusting differences in temperature caused by the height of the living space from the floor to the ceiling (the temperature at ceiling height is higher) during heating operation.

The setting can be modified between 0°C and 6°C with mode [06] (Simple Settings Function) on the remote controller.



- (1) Once the thermostat has been switched on, it cannot be switched off again by indoor air temperature control for a period of 10 minutes.
- (2) Once the thermostat has been switched off, it cannot be switched on again for a period of 3 minutes.
- (3) When in the test run operation mode, the thermostat will not be switched off by indoor air temperature control and the operation will continue.

### 4-12-4. Compressor Frequency Control

The frequency of the compressor's inverter is limited by either of the following controls depending on whether the cooling or heating mode is in operation.

**Cooling Mode :**

- Indoor air temperature control
- Maximum and minimum frequency control
- Current release control
- Cooling high-load prevention control
- Cooling freeze prevention control
- Discharge temperature control

**Heating Mode :**

- Indoor air temperature control
- Maximum and minimum frequency control
- Current release control
- Heating high-load prevention control
- Discharge temperature control

### 1) Indoor Air Temperature Control

By the control method, not only the thermostat is switched on and off, as explained section “4-12-3. Indoor Air Temperature Control”, but also the frequency of the compressor's inverter is controlled in accordance with  $\Delta T$  and fluctuations in indoor air temperature. Inverter frequency is controlled as follows:

|  |   |
|--|---|
| When $\Delta T$ is high (not yet reached the temperature set with the remote controller).                                  | Controlled so that the inverter frequency is increased.         |
| When $\Delta T$ is low (approximately +1.0 or less in the cooling mode or approximately -1.0 or more in the heating mode). | Controlled so that the inverter frequency is decreased or kept. |

### 2) Maximum and Minimum Frequency Control

The compressor's inverter frequency is controlled in accordance with the model and operation mode. The maximum and minimum frequencies for each model are shown in the table below.

\* There are cases in which frequency is limited with other control functions depending on operational conditions, so operations are not always carried out in accordance with the maximum frequencies listed below.

· Maximum and Minimum Frequency

|                        |         | PE                   |                        |                        |                        | PEY                    |                        |           |  |
|------------------------|---------|----------------------|------------------------|------------------------|------------------------|------------------------|------------------------|-----------|--|
|                        |         | 71PE1E5A<br>71PE1E8A | 100PE1E5A<br>100PE1E8A | 125PE1E5A<br>125PE1E8A | 140PE1E5A<br>140PE1E8A | 100PEY1E5<br>100PEY1E8 | 125PEY1E5<br>125PEY1E8 | 140PEY1E8 |  |
| Maximum Frequency (Hz) | Cooling | 70.0                 | 55.0                   | 65.0                   | 75.0                   | 85.0                   | 75.0                   | 75.0      |  |
|                        | Heating | 85.0                 | 93.0                   | 95.0                   | 99.0                   | 115.0                  | 95.0                   | 95.0      |  |
| Minimum Frequency (Hz) | Cooling | 15.0                 | 15.0                   | 15.0                   | 15.0                   | 15.0                   | 15.0                   | 15.0      |  |
|                        | Heating | 15.0                 | 15.0                   | 15.0                   | 15.0                   | 15.0                   | 15.0                   | 15.0      |  |

\* There is a case in which the frequency set at maximum and minimum may sometimes decrease in accordance with ambient temperature and indoor loads.

### 3) Current Release Control

The inverter frequency is controlled so that the current value for the inverter compressor is less than the figure listed in the table below in order to prevent abnormal increases in the inverter circuit located within the outdoor unit's electrical box.

Current release control with primary current : The limited values are modified in accordance with ambient temperature.

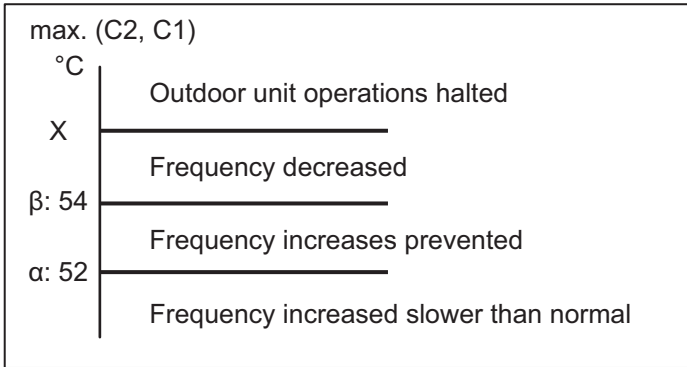
|        |         | PE       |           |           |           | PEY       |           |           |
|--------|---------|----------|-----------|-----------|-----------|-----------|-----------|-----------|
|        |         | 71PE1E5A | 100PE1E5A | 125PE1E5A | 140PE1E5A | 100PEY1E5 | 125PEY1E5 | —         |
| Is (A) | Cooling | 14.5     | 24.0      | 26.0      | 27.0      | 24.0      | 27.0      | —         |
|        | Heating | 18.0     | 24.0      | 26.0      | 28.0      | 24.0      | 27.0      | —         |
|        |         | 71PE1E8A | 100PE1E8A | 125PE1E8A | 140PE1E8A | 100PEY1E8 | 125PEY1E8 | 140PEY1E8 |
| Is (A) | Cooling | 6.0      | 8.0       | 8.6       | 9.0       | 8.0       | 9.0       | 9.0       |
|        | Heating | 7.0      | 8.5       | 9.5       | 10.5      | 8.5       | 9.5       | 9.5       |

#### 4) Condensation Temperature Control (cooling)

This system control is performed to limit the inverter frequency in order to restrict high pressure's abnormal increase and high-load operating prevention in the cooling mode.

In accordance with the temperature of the outdoor heat exchanger temperature sensors (C1, C2), such controls are performed as to halting the operations of the indoor unit, decreasing the inverter frequency and restricting its increase, etc.

- (a) The threshold value is decreased in accordance with the compressor frequency or indoor load (differences of temperature).
- (b) When "X" values are lowered, the results basically become  $\beta=X-2$ ,  $\alpha=X-3$ .



Outdoor EEPROM : Amendment of X values can be made due to 4B.

EEPROM setting in outdoor unit  
CODE: 4B

| Setting No. | -2 | -1   | 0    | 1 *1 |
|-------------|----|------|------|------|
| X (°C)      | 52 | 56.5 | 58.5 | 60   |

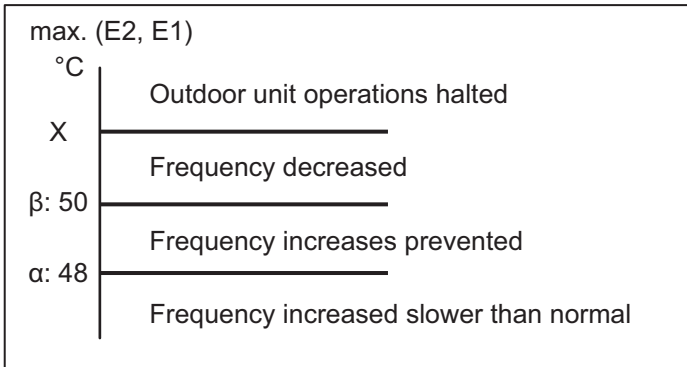
\*1 Setting at factory shipment

#### 5) Condensation Temperature Control (heating)

This system control is performed to limit the inverter frequency in order to restrict high pressure's abnormal increase and high-load operating prevention in the heating mode.

In accordance with the temperature of the indoor heat exchanger temperatures sensor (E1, E2), such controls are performed as to halting the operations of the indoor unit, decreasing the inverter frequency and restricting its increase, etc.

- (a) The threshold value is decreased in accordance with the compressor frequency or indoor load (differences of temperature).
- (b) When "X" values are lowered, the results basically become  $\beta=X-2$ ,  $\alpha=X-3$ .



Outdoor EEPROM : Amendment of X values can be made due to 4B.

EEPROM setting in outdoor unit  
CODE: 4B

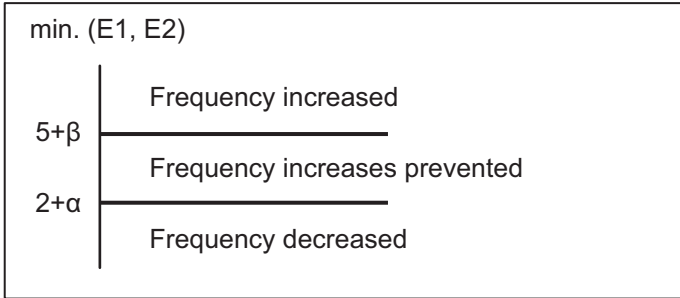
| Setting No. | -2 | -1   | 0    | 1 *1 |
|-------------|----|------|------|------|
| X (°C)      | 52 | 56.5 | 58.5 | 60   |

\*1 Setting at factory shipment

### 6) Cooling Freeze Prevention Control

The following control is performed during cooling operations (including dry mode operation), in accordance with whichever of the indoor heat exchanger temperatures (E1 or E2) is lower. (See the chart below.)

- (a) Frequency will not be decreased less than 6 minutes after thermostat ON.
- (b) The threshold value is increased in accordance with the indoor load (differences of temperature).



Outdoor EEPROM : Amendment of  $\alpha$  and  $\beta$  values can be made due to 3F or 40.

EEPROM setting in outdoor unit

CODE: 3F (for  $\alpha$  setting)

|             |     |       |     |       |   |
|-------------|-----|-------|-----|-------|---|
| Setting No. | -15 | ..... | 0 * | ..... | 9 |
| $\alpha$    | -15 |       | 0   |       | 9 |

CODE: 40 (for  $\beta$  setting)

|             |     |       |     |       |   |
|-------------|-----|-------|-----|-------|---|
| Setting No. | -15 | ..... | 0 * | ..... | 9 |
| $\beta$     | -15 |       | 0   |       | 9 |

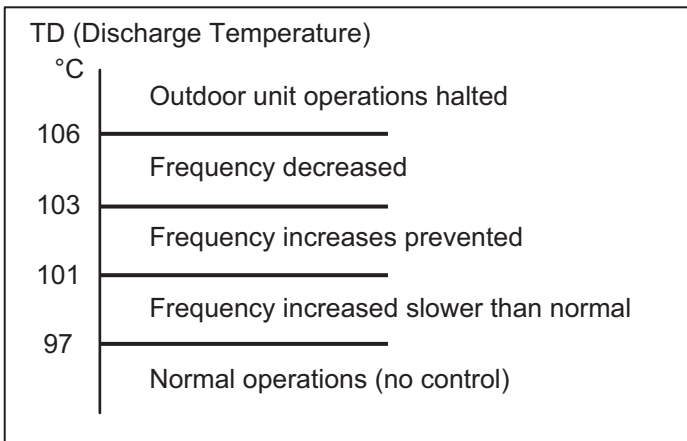
\* Setting at factory shipment

4

### 7) Discharge Temperature Control

The following control is performed to prevent the discharge temperature from rising abnormally in order to protect the inverter compressor.

In accordance with the temperature of the discharge sensor TD, such controls are performed as to limiting the increase of inverter frequency, decreasing it or halting operation of the compressor.



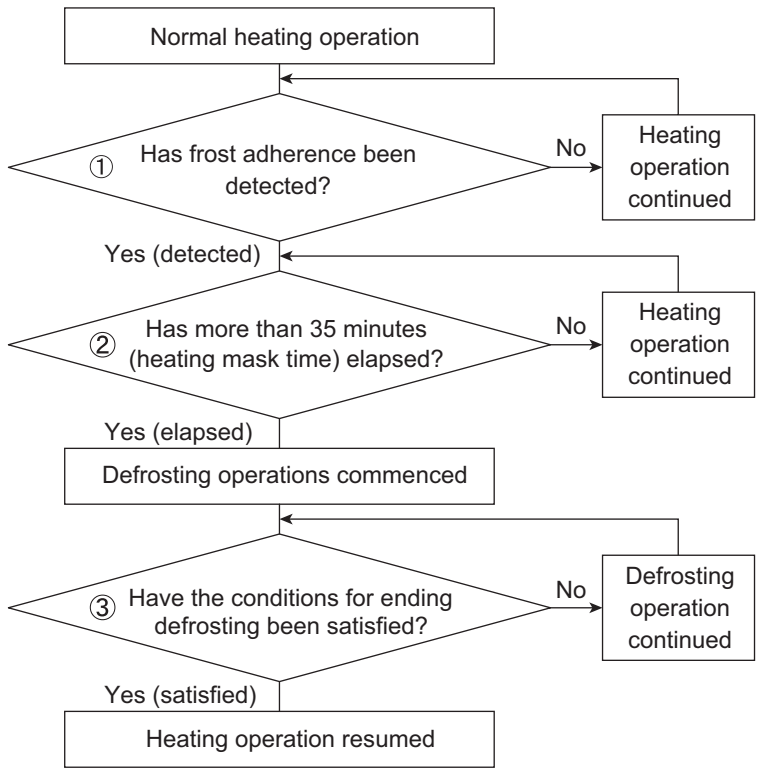
\* If the discharge temperature exceeds 106°C, operations of the compressor are halted and restarted after 3 minutes.

If this start/stop activity is repeated 5 times, the alarm "P03" (abnormal discharge temperature) occurs.

### 8) Defrosting Control

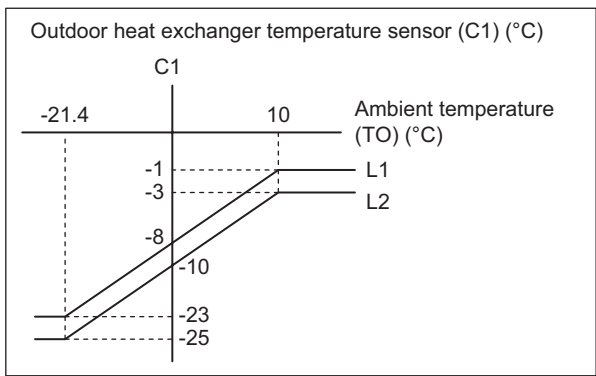
This control function removes frost that has adhered to the outdoor heat exchanger during the heating operation. The control is performed to prevent the deterioration of the heating capabilities attributed to the adherence of frost, and to prevent the crack or crush of pipes attributed to the accretion of ice. The following control is performed in accordance with the ambient temperature and the outdoor heat exchanger temperature sensor (C1).

#### Overall Flow Chart of Defrosting Control



① Frost adherence detection

- If the following conditions are satisfied during heating operations, it is regarded as "frost adherence is detected".
- Frost adherence detection is performed in accordance with the ambient temperature (TO) and the outdoor heat exchanger temperature sensor (C1).
- Frost adherence detection conditions
  - (a) Following satisfied condition is detected for accumulation of 60 minutes.  
Outdoor heat exchanger temperature sensor (C1) ≤ L1
  - (b) Following satisfied condition is detected for consecutive 4 minutes or more, 2 times.  
Outdoor heat exchanger temperature sensor (C1) ≤ L2



- (c) Following satisfied condition is detected for accumulation of over 90 minutes.  
Outdoor heat exchanger temperature sensor (C1) < -3 °C

② Heating Mask Time

This refers to the shortest time that heating operations must be performed without defrosting operations being executed. The mask time for this model is 35 minutes.

\* Defrosting operations will not be commenced until the defrosting mask time has elapsed, even if frost adherence has been detected.

### ③ Ending Defrosting

Defrosting operations are ended when the following conditions are satisfied.

- Ending defrosting conditions
  - (a) When the temperature of the outdoor heat exchanger temperature sensor (C1) is 12°C or higher.
  - (b) When the temperature of the outdoor heat exchanger temperature sensor (C1) is 10°C or higher for consecutive 60 seconds.
  - (c) When a maximum of 15 minutes defrosting time has elapsed.

## 9) Outdoor Unit Fan Control

The appropriate rotations per minute for the outdoor unit fan are determined in accordance with the ambient temperature and the frequency of the compressor inverter.

The outdoor unit fan step is controlled between a range of W1 (Step 1) and WF (Step 15).

## 10) Outdoor Unit's Electrical Expansion Valve Control

The electrical expansion valve controls the amount of refrigerant that is allowed to flow in accordance with the operation status.

The valve is adjusted in accordance with the discharge temperature (TD), the outdoor heat exchanger temperature sensor (C1), the suction temperature sensor (TS), and the indoor unit's heat exchanger temperature sensors (E1 and E2).

### (1) Cooling Mode

Controlled so that the suction temperature (TS) - indoor heat exchanger temperature minimum (E1 and E2) is between 0 degree and 2 degrees under normal conditions.

There are cases where the aperture opens wider than normal operation if the discharge temperature increases.

### (2) Heating Mode

Controlled so that the suction temperature (TS) - outdoor heat exchanger temperature (C1) is between 0 degree and 2 degrees under normal conditions.

There are cases where the aperture opens wider than normal operation if the discharge temperature increases.

## 11) Demand Control

There are two styles of demand operations available as methods of restraining power consumption.

There is a demand terminal as normal equipment in the outdoor unit.

Demand control can be selected as the following table.

Input current should be DC24V, 10mA

Connecting wiring must be used "shield wiring".

| Short-circuit |         |         | Control (range of operations)                                 |
|---------------|---------|---------|---|
| LV1-COM       | LV2-COM | LV3-COM |   |
| 0             | 0       | 0       | No restricted   |
| 1             | 0       | 0       | Rated current restricted to A% (A% = 75% at factory shipment) |
| 0             | 1       | 0       | Rated current restricted to B% (B% = 50% at factory shipment) |
| 0             | 0       | 1       | Control OFF   |

\* The operational current is restricted to either A% or B% as a general indicator during demand input.

- A% and B% can be amended in calibrations of 5% between 70% and 100% with the outdoor unit's maintenance remote controller.

For details on how to amend the parameters, see the chapter on the outdoor maintenance remote controller, (refer to the section "6-6. Settings Modes : Setting the Outdoor Unit EEPROM").

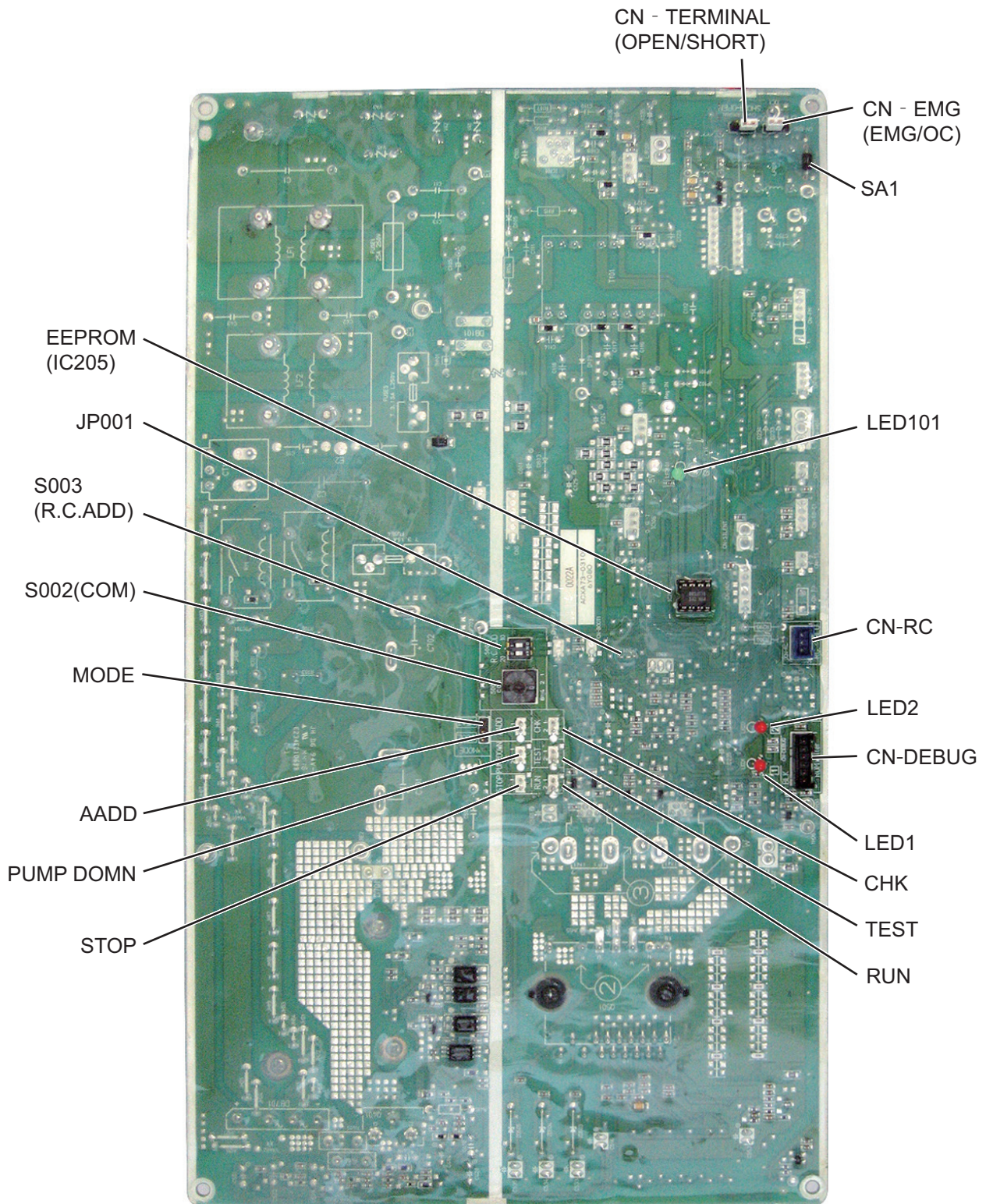
- A% value amendments: Parameters are amended with item code "1A" (demand 1).
- B% value amendments: Parameters are amended with item code "1B" (demand 2).

### 4-13. Outdoor Unit Control PCB

#### 1. [ Single-Phase Unit ]

##### ■ CR-PCB

ACXA73-03100 : Up side (U-36PE2E5A, U-50PE2E5A, U-60PE2E5A)  
(U-60PEY2E5, U-71PEY2E5)

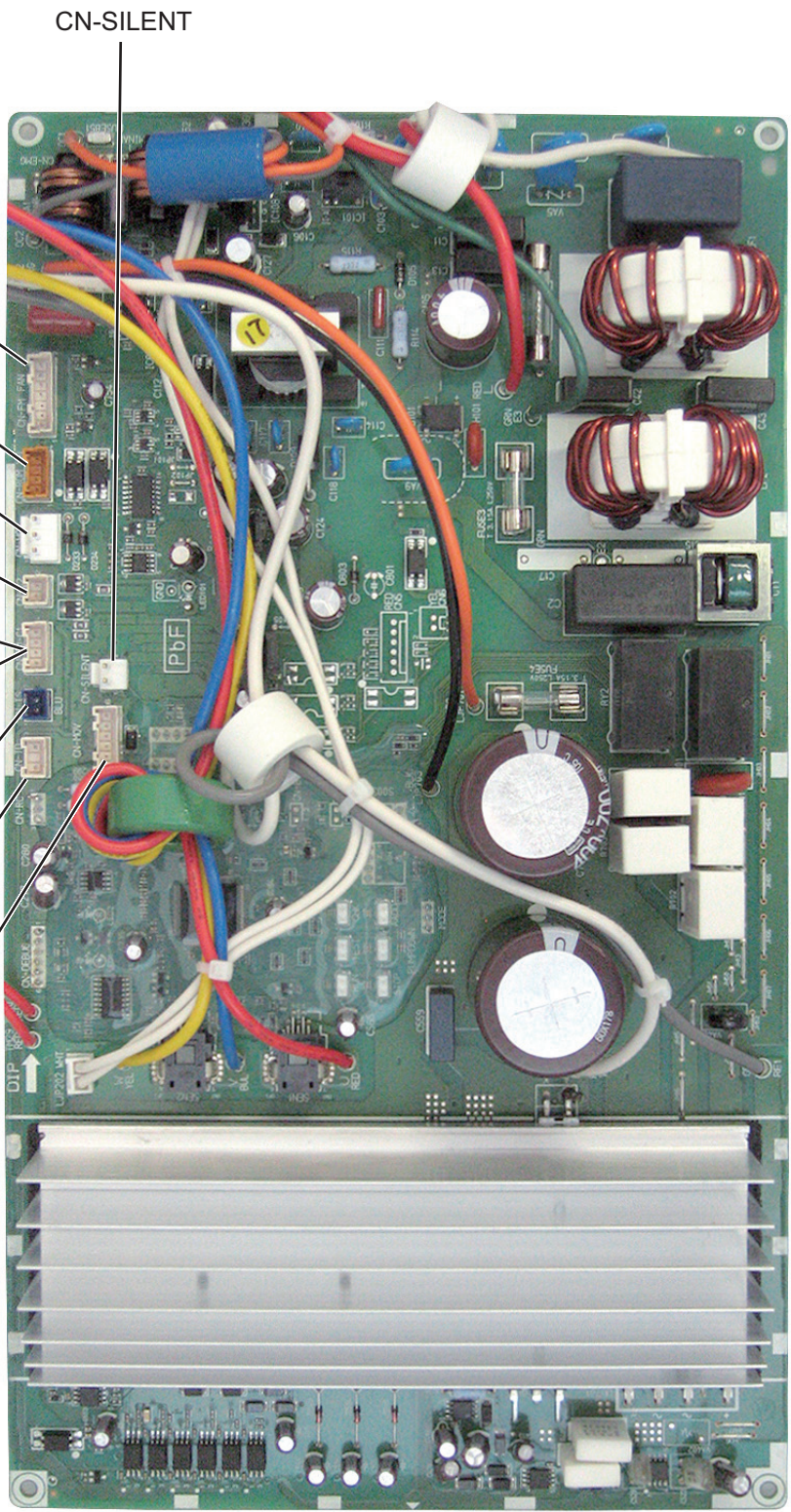


■ CR-PCB

ACXA73-03100 : Bottom side (U-36PE2E5A, U-50PE2E5A, U-60PE2E5A)  
(U-60PEY2E5, U-71PEY2E5)

4

- CN-SILENT
- CN-FM
- CN-ROM
- CN-HOT
- OUTDOOR HEAT EXCHANGER TEMP. SENSOR (CN-C2)
- OUTDOOR AIR TEMP. SENSOR (TO) (CN-TO-C1, 4P pin 1-2)
- OUTDOOR HEAT EXCHANGER TEMP. SENSOR (C1) (CN-TO-C1, 4P pin 3-4)
- COMPRESSOR SUCTION TEMP. SENSOR (CN-TS)
- COMPRESSOR DISCHARGE TEMP. SENSOR (CN-TD)
- ELECTRO-MAGNETIC COIL(EXPAND VALVE) (CN-MOV)





## 1-1. Functions of Outdoor Unit PCB

|             |  |
|-------------|--|
| A.ADD       | <p>2P plug : Automatic address setting pin</p> <ul style="list-style-type: none"> <li>• Short-circuit this pin for 1 second or longer to automatically set the addresses at the indoor units that are connected to that outdoor unit and are within the same system.</li> <li>• The system address is “1” at the time of shipment. Automatic address setting is necessary even for communications lines in a single system where the inter-unit control wiring does not cross to any other systems.</li> <li>• While automatic address setting is in progress, the 2 LEDs (LED1, 2: red) on the outdoor unit control PCB blink alternately. (Short-circuiting this pin while automatic address setting is in progress will stop the automatic address setting operation.)</li> </ul>   |
| S002        | <p>Rotary switch (10 positions, black): Outdoor system address setting switch</p> <ul style="list-style-type: none"> <li>• The setting is “1” at the time of shipment. It is not necessary to change the setting if wiring is connected only to an outdoor unit and indoor units in a single system and the inter-unit control wiring does not cross multiple systems.</li> <li>• If wiring links the inter-unit control wiring for multiple systems to the same communications lines, then a different address must be set for each refrigerant tubing system.</li> <li>• If wiring links multiple systems, a maximum of 30 systems (up to 64 indoor units) can be connected. This setting can be set up to “39,” however control will be for 30 systems even if the setting is set to higher than 30. An alarm will be displayed if system addresses are duplicated. (For details, refer to Table 1.)</li> </ul> |
| S003        | <p>DIP switch (2P): Switches for setting system address 10s digit and 20s digit</p> <ul style="list-style-type: none"> <li>• If 10 systems or more are set, the setting is made by a combination of this DIP switch and S002.</li> <li>• If 10 – 19 systems are set, set switch 1 (10s digit) to ON.</li> <li>• If 20 – 29 systems are set, set switch 2 (20s digit) to ON, and set switch 1 (10s digit) to OFF.</li> <li>• If 30 systems are set, set both switch 1 (10s digit) and switch 2 (20s digit) to ON.</li> </ul> <p>(For details concerning S002 and S003, refer to Table 1.)</p>   |
| JP001       | <p>Jumper wire</p>   |
| CN-TERMINAL | <p>3P plug : For communications circuit impedance matching</p> <ul style="list-style-type: none"> <li>• A connecting socket (3P, black) is attached to the terminal plug at the time of shipment from the factory.</li> <li>• In the case of link wiring which combines the inter-unit control wiring for multiple systems into a single communications circuit, leave the connecting socket in place at only one of the outdoor units, and move the socket from the “SHORT” side to the “OPEN” side at all other outdoor units. If multiple connecting sockets are left in place, communications trouble will occur.</li> </ul>   |

|                         |  |
|-------------------------|--|
| LED 1<br>LED 2          | LED (red × 2) <ul style="list-style-type: none"> <li>• LED 1 and 2 blink alternately while automatic address setting is in progress.</li> <li>• Display the alarm contents for alarms that are detected by the outdoor unit.</li> </ul>  |
| Power LED<br>(LED101)   | LED (green): Power indicator<br>Indicates the DC 5V power on the outdoor unit control PCB.   |
| RUN<br>(RUN)            | 2P plug : Start pin<br>Short-circuit this pin and apply a pulse signal to start all indoor units in that refrigerant system.   |
| Stop<br>(STOP)          | 2P plug : Stop pin<br>Short-circuit this pin and apply a pulse signal to stop all indoor units in that refrigerant system.   |
| PUMP DOWN<br>(PUMPDOWN) | 2P plug : Refrigerant recovery Pin <ul style="list-style-type: none"> <li>• Short circuit this pin to perform refrigerant recovery control using cooling operation. The indoor unit fan will operate at HIGH and 55 Hz for a maximum of 10 minutes. When refrigerant recovery is completed, close the valves and open circuit this pin to stop the operation.</li> </ul>   |
| Mode change<br>(MODE)   | 3P plug (black): Indoor unit Heating/Cooling mode change pin <ul style="list-style-type: none"> <li>• When operating the compressors to perform automatic address setting, operation in Heating mode can be normally used. However, short-circuiting this pin performs operation in Cooling mode. (Static signal)</li> <li>• Short-circuiting this pin during ordinary operation changes the mode from Cooling to Heating (if the current mode is Cooling) or from Heating to Cooling (if the current mode is Heating).</li> </ul> |
| Test<br>(TEST)          | 2P plug <ul style="list-style-type: none"> <li>• This pin is used to test the PCB at the factory.</li> <li>• When the power is turned ON after this pin has been short-circuited, all output signals will be output in sequence. (Sequential output does not occur if this pin is short-circuited when the power is already ON.) Releasing this pin returns the unit to normal control.</li> </ul>   |
| CHK<br>(CHK)            | 2P plug<br>Short-circuit during the test run operation.<br>Open the circuit after the test run.  |

**Table 1. Setting the System Address [S002: Rotary switch (black), S003: 2P DIP (black)]**

|                                  | Outdoor system address No. | S002 setting (system address switch) | S003 setting   |                |
|----------------------------------|----------------------------|--------------------------------------|----------------|----------------|
|                                  |                            |                                      | 1P (10s digit) | 2P (20s digit) |
| <b>1 refrigerant system only</b> | 1                          | 0                                    | OFF            | OFF            |
| <b>Link wiring</b>               | 1                          | 1                                    | OFF            | OFF            |
|                                  | 2                          | 2                                    | OFF            | OFF            |
|                                  | 3                          | 3                                    | OFF            | OFF            |
|                                  | 4                          | 4                                    | OFF            | OFF            |
|                                  | 5                          | 5                                    | OFF            | OFF            |
|                                  | 6                          | 6                                    | OFF            | OFF            |
|                                  | 7                          | 7                                    | OFF            | OFF            |
|                                  | 8                          | 8                                    | OFF            | OFF            |
|                                  | 9                          | 9                                    | OFF            | OFF            |
|                                  | 10                         | 0                                    | ON             | OFF            |
|                                  | 11                         | 1                                    | ON             | OFF            |
|                                  | 12                         | 2                                    | ON             | OFF            |
|                                  | 13                         | 3                                    | ON             | OFF            |
|                                  | 14                         | 4                                    | ON             | OFF            |
|                                  | 15                         | 5                                    | ON             | OFF            |
|                                  | 16                         | 6                                    | ON             | OFF            |
|                                  | 17                         | 7                                    | ON             | OFF            |
|                                  | 18                         | 8                                    | ON             | OFF            |
|                                  | 19                         | 9                                    | ON             | OFF            |
|                                  | 20                         | 0                                    | OFF            | ON             |
|                                  | 21                         | 1                                    | OFF            | ON             |
|                                  | 22                         | 2                                    | OFF            | ON             |
|                                  | 23                         | 3                                    | OFF            | ON             |
|                                  | 24                         | 4                                    | OFF            | ON             |
|                                  | 25                         | 5                                    | OFF            | ON             |
|                                  | 26                         | 6                                    | OFF            | ON             |
|                                  | 27                         | 7                                    | OFF            | ON             |
|                                  | 28                         | 8                                    | OFF            | ON             |
|                                  | 29                         | 9                                    | OFF            | ON             |
|                                  | 30                         | 0                                    | ON             | ON             |

## 1-2. Self-Diagnostics Function Table

- Causes and corrections in instances when automatic address setting cannot be started.

| Trouble  | Cause and correction  |
|--|---|
| The power LED on the outdoor unit control PCB does not turn ON.  | Check for any errors in the power wiring to the outdoor unit, and check for a missing phase.  |
| LED 1 and 2 on the outdoor unit control PCB do not turn OFF when the outdoor unit power is turned ON, and automatic address setting cannot be started. | Check the "Alarm Displays" table and correct the problem.   |
| An alarm appears immediately when automatic address setting is started from the remote controller.   |   |
| Nothing happens when the operator attempts to start automatic address setting from the remote controller.  | Check that the remote controller wiring and the inter-unit control wiring are connected correctly.<br>Check that the indoor unit power is ON. |

- Causes and corrections in instances when automatic address setting starts, but cannot be completed successfully.

| Trouble  | Cause and correction   |
|--|--|
| An alarm appears on the remote controller sometime from several seconds to several minutes after automatic address setting is started.   | Check the "Alarm Displays" table and correct the problem.  |
| LED 1 and 2 on the outdoor unit control PCB indicate that automatic address setting is in progress (the LEDs blink alternately) for several minutes after automatic address setting is started (the compressors may also start and stop several times), however LED 1 and 2 never indicate that automatic address setting is completed (turn OFF). | Check the alarm details on the "Outdoor Unit Control PCB LED 1 and 2 Alarms" table, then check the "Alarm Displays" table and correct the problem. |

- If alarm E15, E16, or E20 appears after automatic address setting is started, check the following items.

| Alarm display | Alarm description  |
|---------------|--|
| E15           | The total capacity of indoor units is too lower than that of outdoor unit.   |
| E16           | The total capacity of indoor units is too higher than that of outdoor unit.<br>The number of indoor unit is two or more.     |
| E20           | The outdoor unit received no serial signals from indoor units within 90 seconds after automatic address setting was started. |

| Check items  | E15 | E16 | E20 |
|--|-----|-----|-----|
| Check that the indoor unit power is turned ON.   | ○   |     | ○   |
| Check that the inter-unit control wiring is connected correctly. (Check that there are no open circuits, short circuits, terminal plugs, incorrect wiring to the remote controller terminals, or similar problems.)                          | ○   | ○   | ○   |
| Check that the remote controller wiring is connected correctly. (Check that there are no open circuits, short circuits, incorrect wiring to the inter-unit control wiring terminals, control wiring for group control, or similar problems.) | ○   |     | ○   |
| Check that there are no indoor units where the system address was already incorrectly set by manual or automatic address setting.  |     | ○   |     |

- When automatic address setting is started from the outdoor unit control PCB or from the remote controller, **SETTING** (SETTING) appears on the remote controller at units where the inter-unit control wiring and remote controller wiring are connected correctly. LED 1 and 2 on the outdoor unit control PCB blink alternately.
- In the case of indoor unit group control, if there is a mistake in the remote controller inter-unit control wiring for group control, addresses may not be set even if **SETTING** (SETTING) appears.
- Even if alarm E15 or E16 appears, addresses are set at those indoor units which could be verified. The set addresses can be checked using the remote controller.
- If one of the below alarms appears when the remote controller is operated after automatic address setting was completed (LED 1 and 2 on the outdoor unit control PCB are turned OFF), follow the instructions in the table below and correct the problem location.

| Remote controller display | Cause   |
|---------------------------|---|
| Nothing is displayed.     | The remote controller is not connected correctly (power trouble).<br>The indoor unit power was cut off after automatic address setting was completed.   |
| E01                       | The remote controller is not connected correctly (remote controller receiving trouble).<br>The remote controller of an indoor unit where the indoor unit address is not set is inadvertently operated. (Communications with the outdoor unit are not possible.) |
| E02                       | The remote controller is not connected correctly (trouble with sending of the signal from the remote controller to the indoor unit).  |
| E09                       | The indoor unit ceiling panel connector is not connected correctly.   |

- The outdoor unit maintenance remote controller can be used to check the alarm display. The number of times that LED 1 and 2 blink on the outdoor unit control PCB can be used to check the alarm display. (Refer to "Checking the LED 1 and 2 Alarm Display on the Outdoor Unit Control PCB.")

4

| Alarm Code | Alarm Meaning  |
|------------|--|
| E01        | Remote Controller Reception Error  |
| E02        | Remote Controller Transmission Error   |
| E03        | Error in Indoor Unit Receiving Signal from Remote Controller (central)   |
| E04        | Error in Indoor Unit Receiving Signal from the Outdoor Unit  |
| E06        | Outdoor Unit Failed to Receive Serial Communication Signals from Indoor Unit   |
| E08        | Duplicate Indoor Unit Address Settings Error   |
| E09        | More Than One Remote Controller Set to Main Error  |
| E12        | Automatic Address Setting Start is Prohibited while Auto-address Setting in Progress.                                  |
| E14        | Main Unit duplication in Simultaneous-operation Multi Control (detected outdoor unit)                                  |
| E15        | Automatic Address Alarm (The total capacity of indoor units is too low.)   |
| E16        | Automatic Address Alarm (The total capacity of indoor units is too high or the number of indoor units is two or more.) |
| E18        | Faulty Communication in Group Control Wiring   |
| E20        | Connection Problem of Indoor/Outdoor Units.  |

|     |  |
|-----|--|
| F04 | Compressor Discharge Temperature Sensor (TD) Trouble           |
| F06 | Inlet Temperature Sensor (C1) in Heat Exchanger Trouble        |
| F07 | Intermediate Temperature Sensor (C2) in Heat Exchanger Trouble |
| F08 | Outdoor Air Temperature Sensor (TO) Trouble                    |
| F12 | Compressor Inlet Suction Temperature Sensor (TS) Trouble       |
| F31 | Outdoor Unit Nonvolatile Memory (EEPROM) Trouble               |

|     |  |
|-----|--|
| H01 | Primary (input) Overcurrent Detected               |
| H02 | PAM Trouble  |
| H03 | Primary Current CT Sensor (current sensor) Failure |
| H31 | HIC Trouble  |

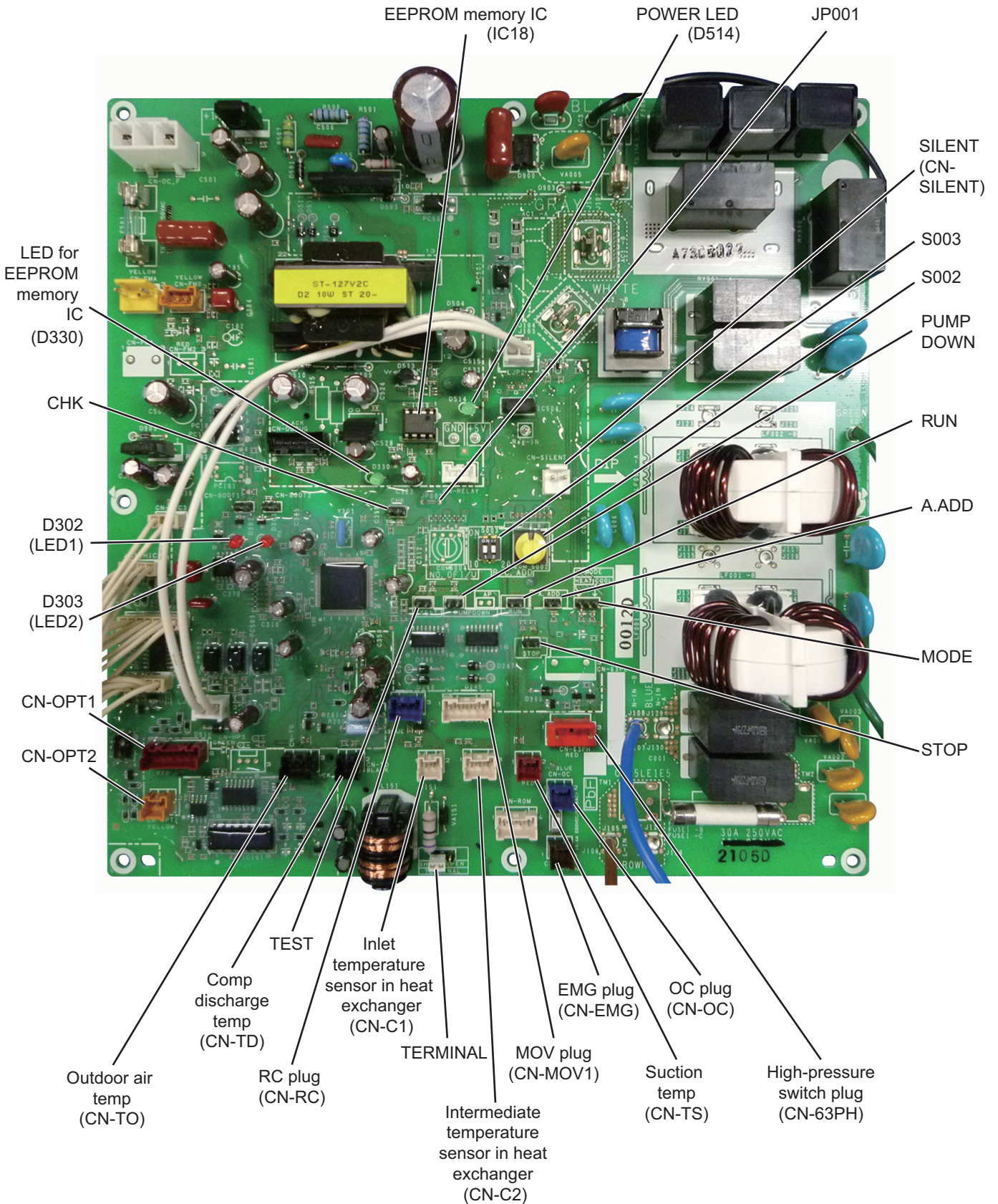
|     |  |
|-----|--|
| L04 | Outdoor Unit Address Duplication         |
| L10 | Outdoor Unit Capacity not Set or Invalid |
| L13 | Indoor Unit Type Setting Error           |
| L18 | 4-way Valve Operation Failure            |

|     |  |
|-----|--|
| P03 | Compressor Discharge Temperature Trouble   |
| P04 | High Pressure Trouble  |
| P05 | AC Power Supply Trouble  |
| P13 | Alarm Valve Open   |
| P14 | O2 Sensor Detect   |
| P15 | Insufficient Gas Level Detected  |
| P16 | Compressor Overcurrent Trouble   |
| P22 | Outdoor Unit Fan Motor Trouble   |
| P29 | Lack of INV compressor wiring, INV compressor actuation failure (including locked), DCCT failure |
| P31 | Group Control Error  |

2. [Single-Phase Unit] [3-Phase Unit]

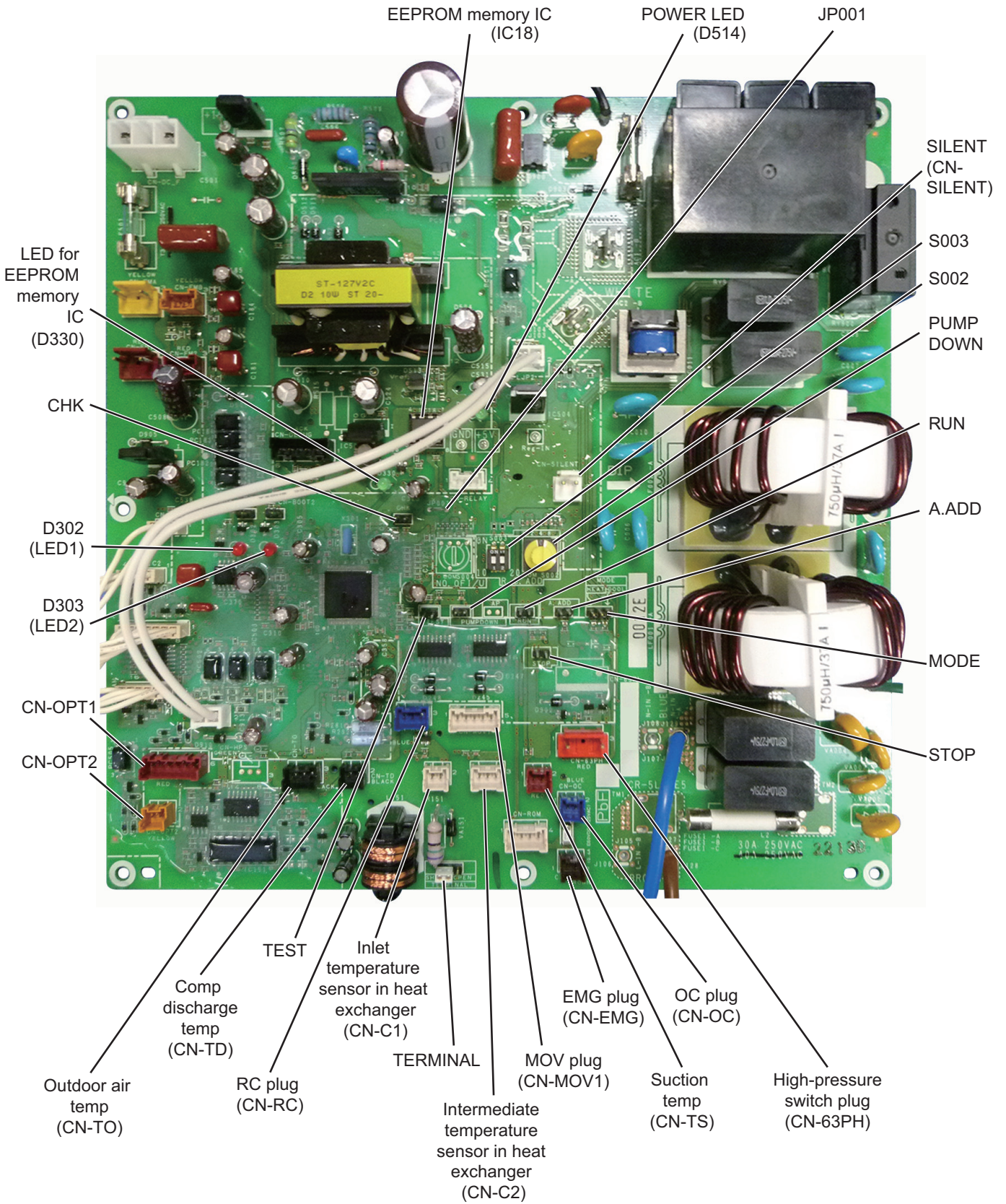
■ CR-PCB

A747898 (U-71PE1E5A)



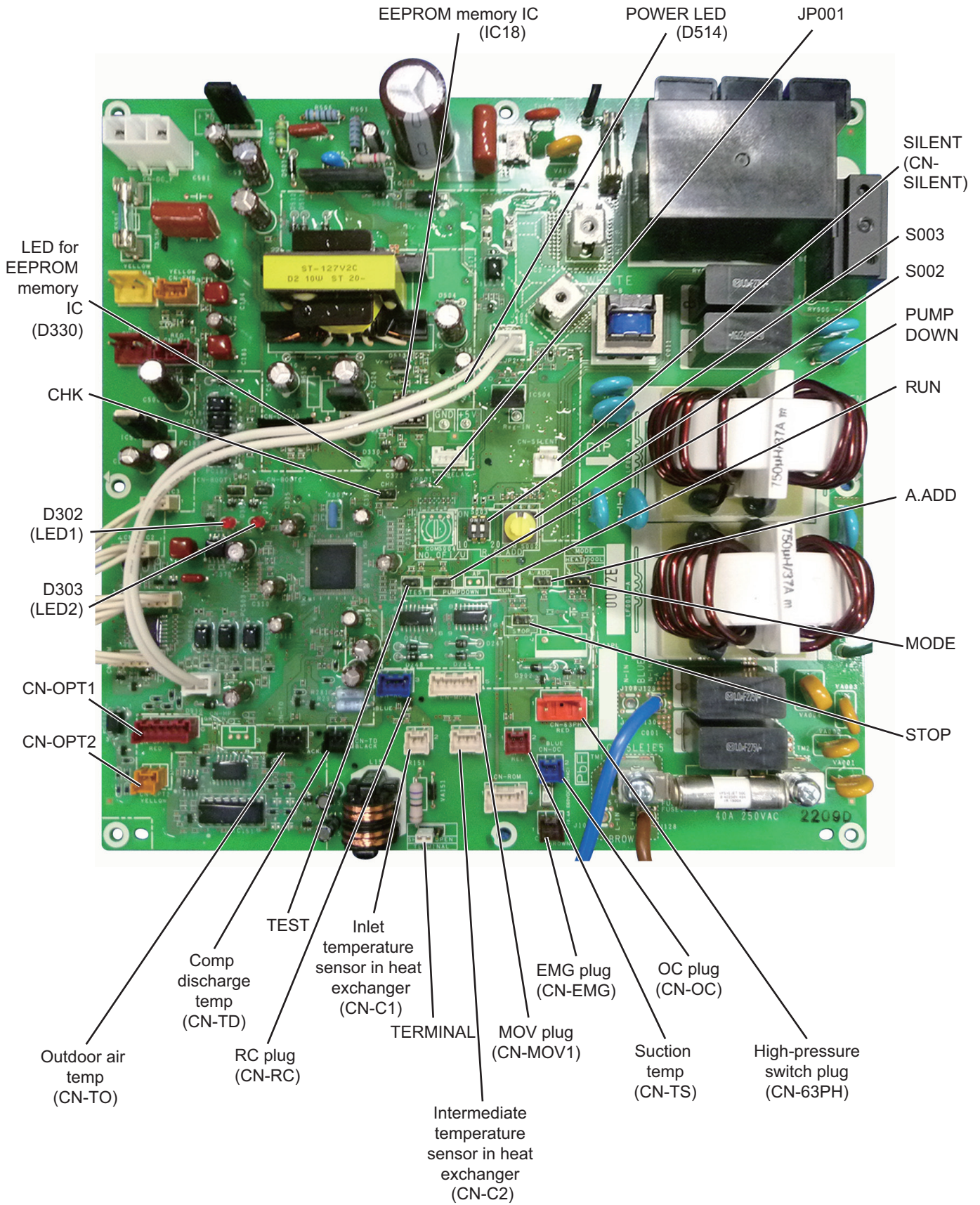
■ CR-PCB  
A747895 (U-100PE1E5A)

4



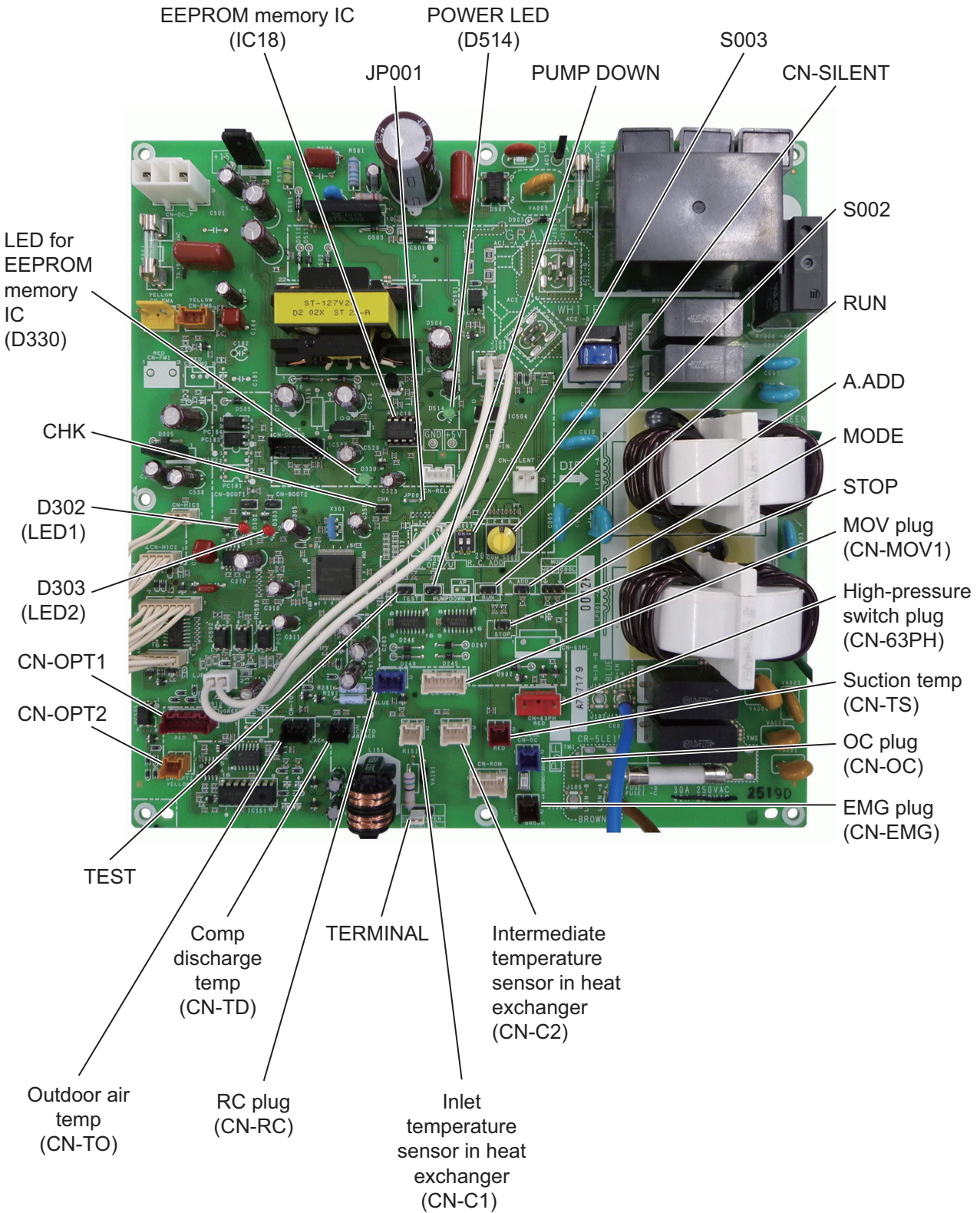


■ CR-PCB  
A747896 (U-125PE1E5A, U-140PE1E5A)

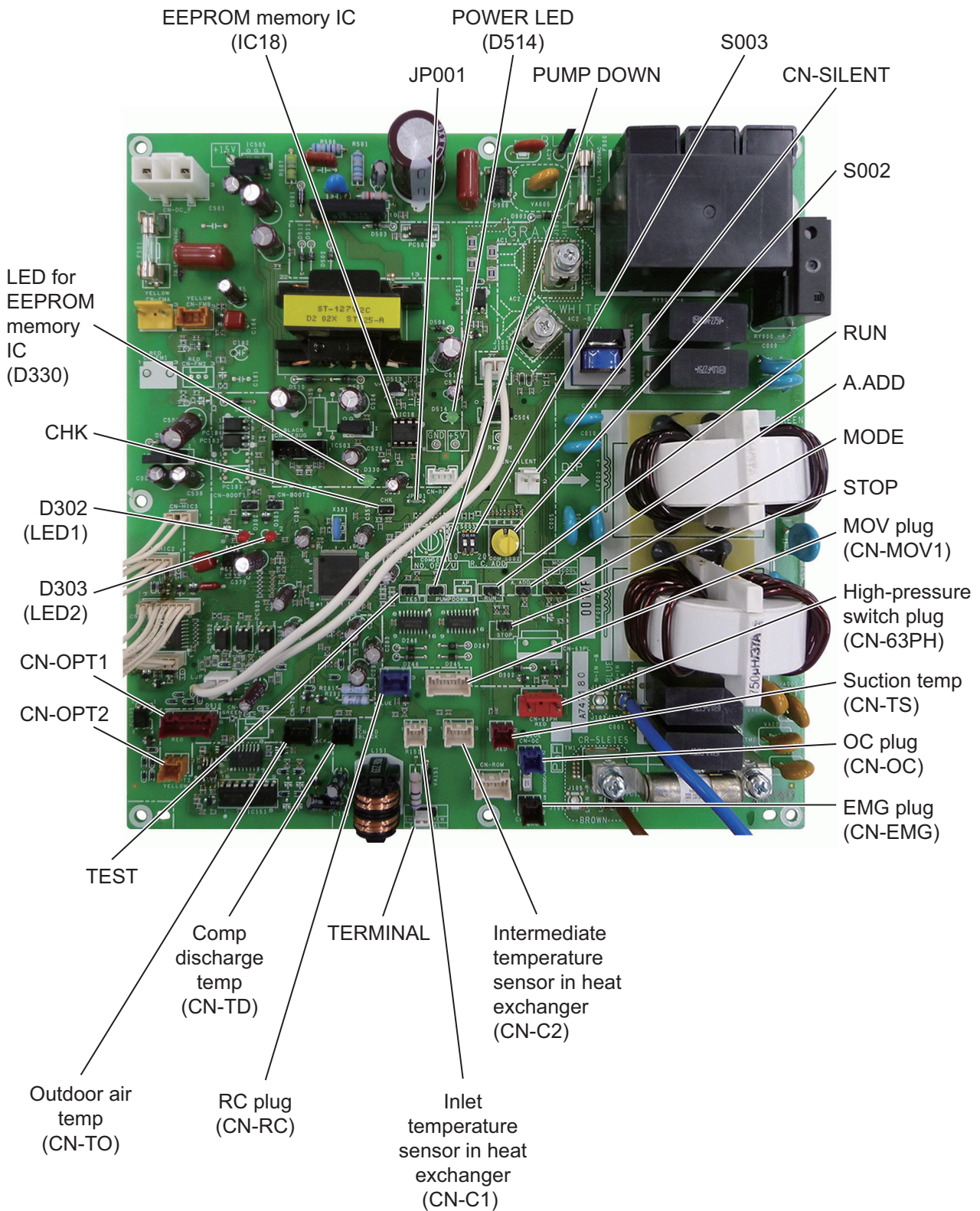


■ CR-PCB  
A747179 (U-100PEY1E5)

4

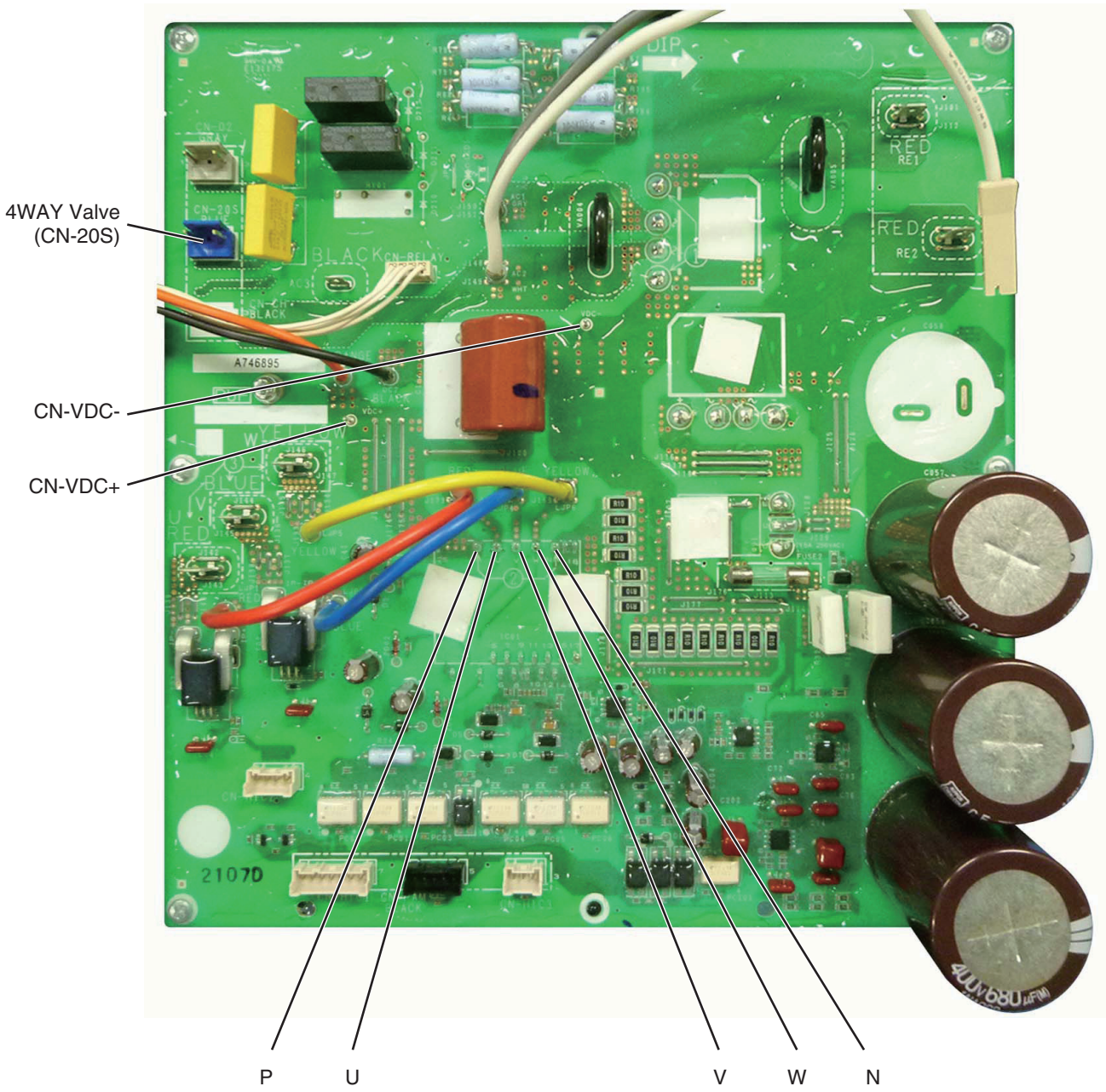


■ CR-PCB  
A747180 (U-125PEY1E5)

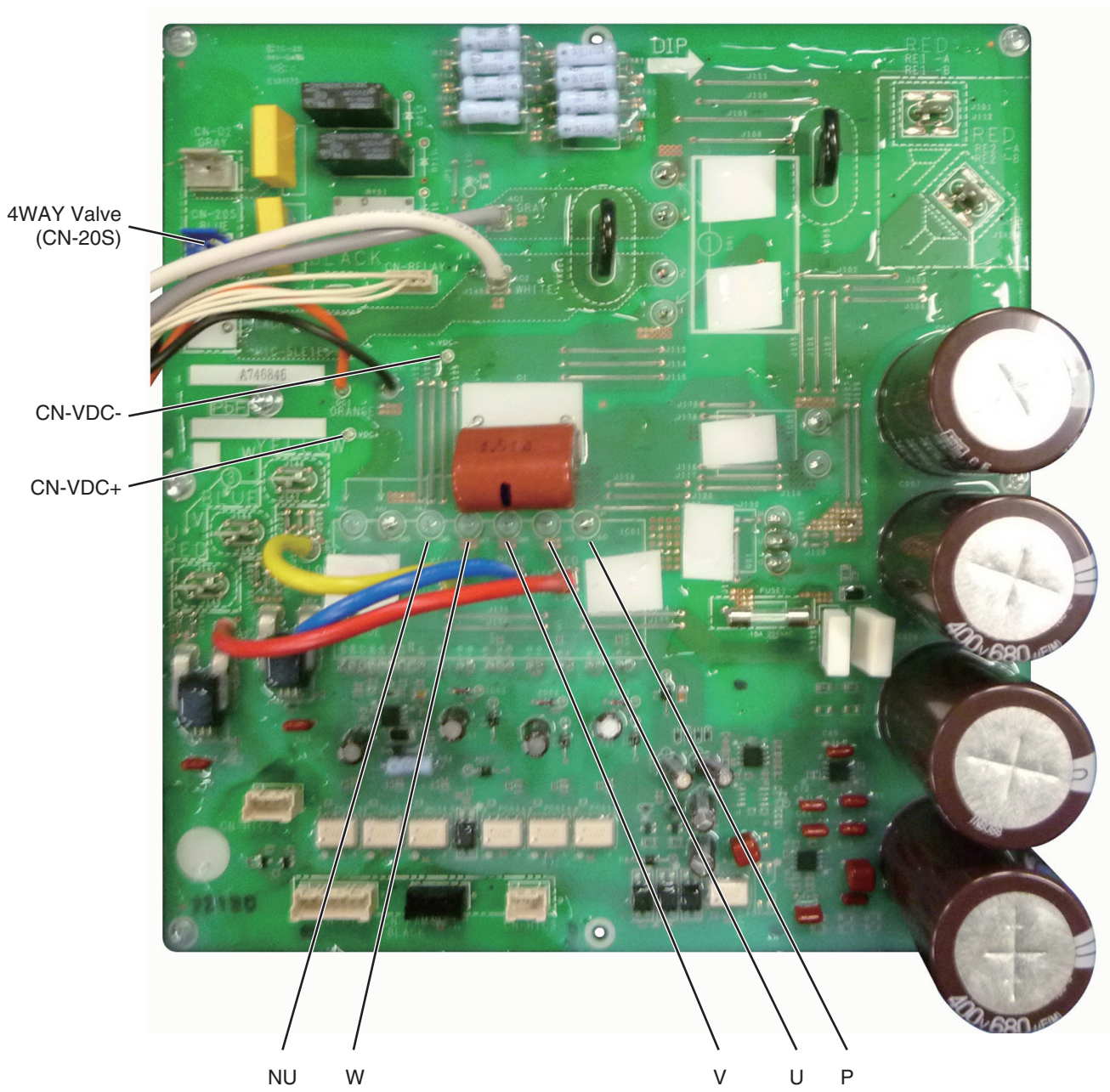


■ HIC-PCB  
A746895 (U-71PE1E5A)

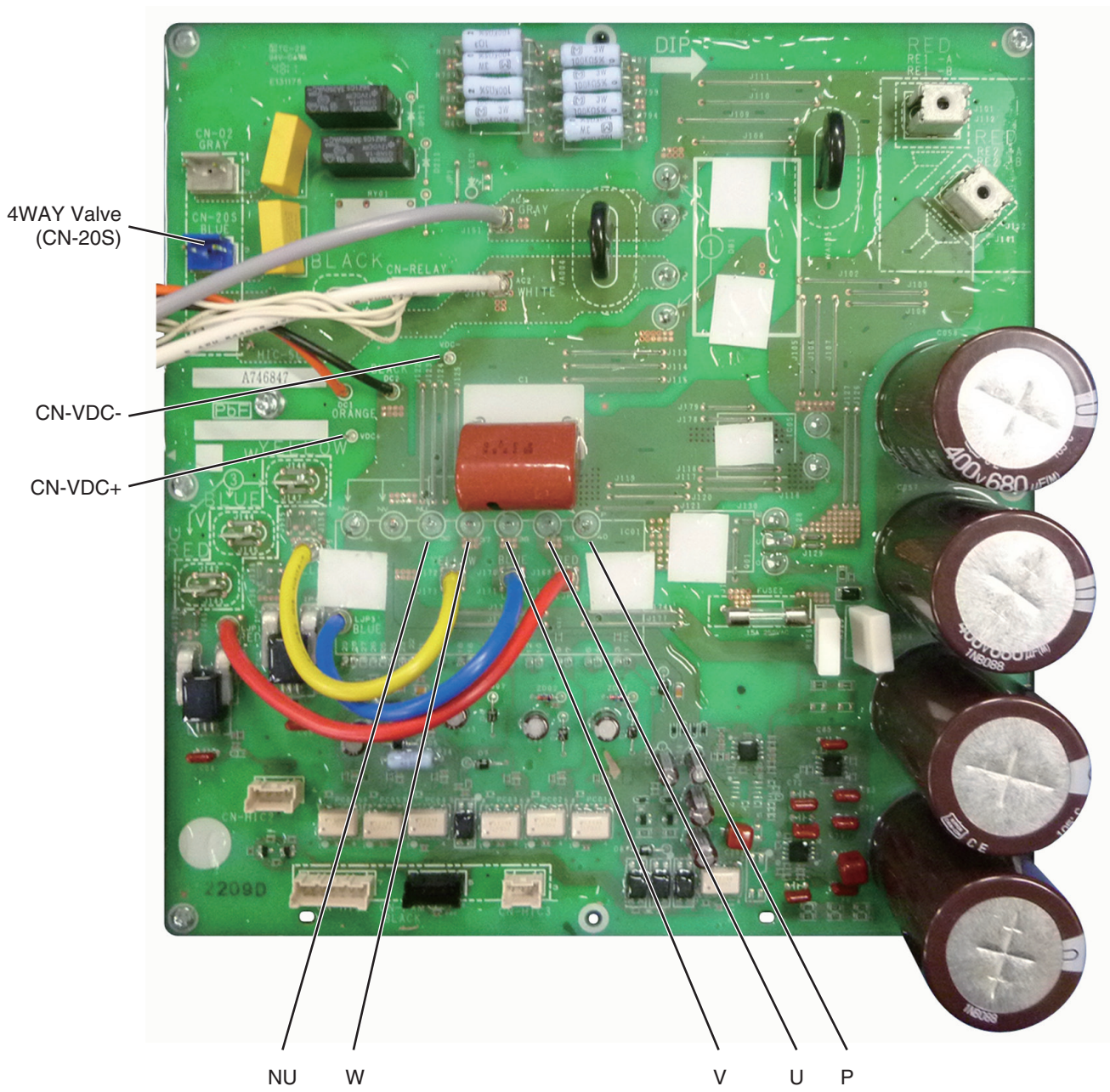
4



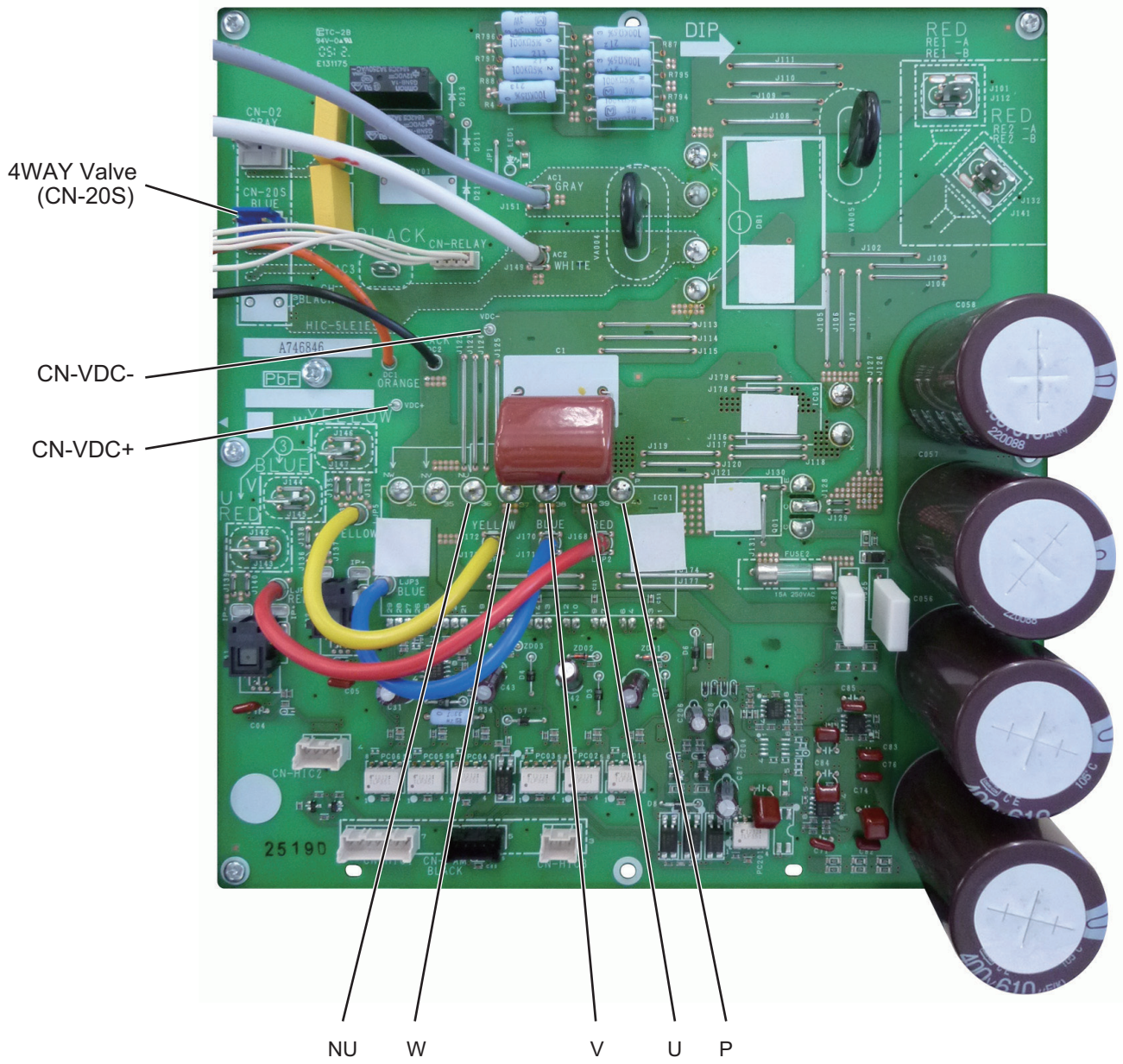
■ HIC-PCB (continued)  
A746846 (U-100PE1E5A)



■ HIC-PCB (continued)  
A746847 (U-125PE1E5A, U-140PE1E5A)

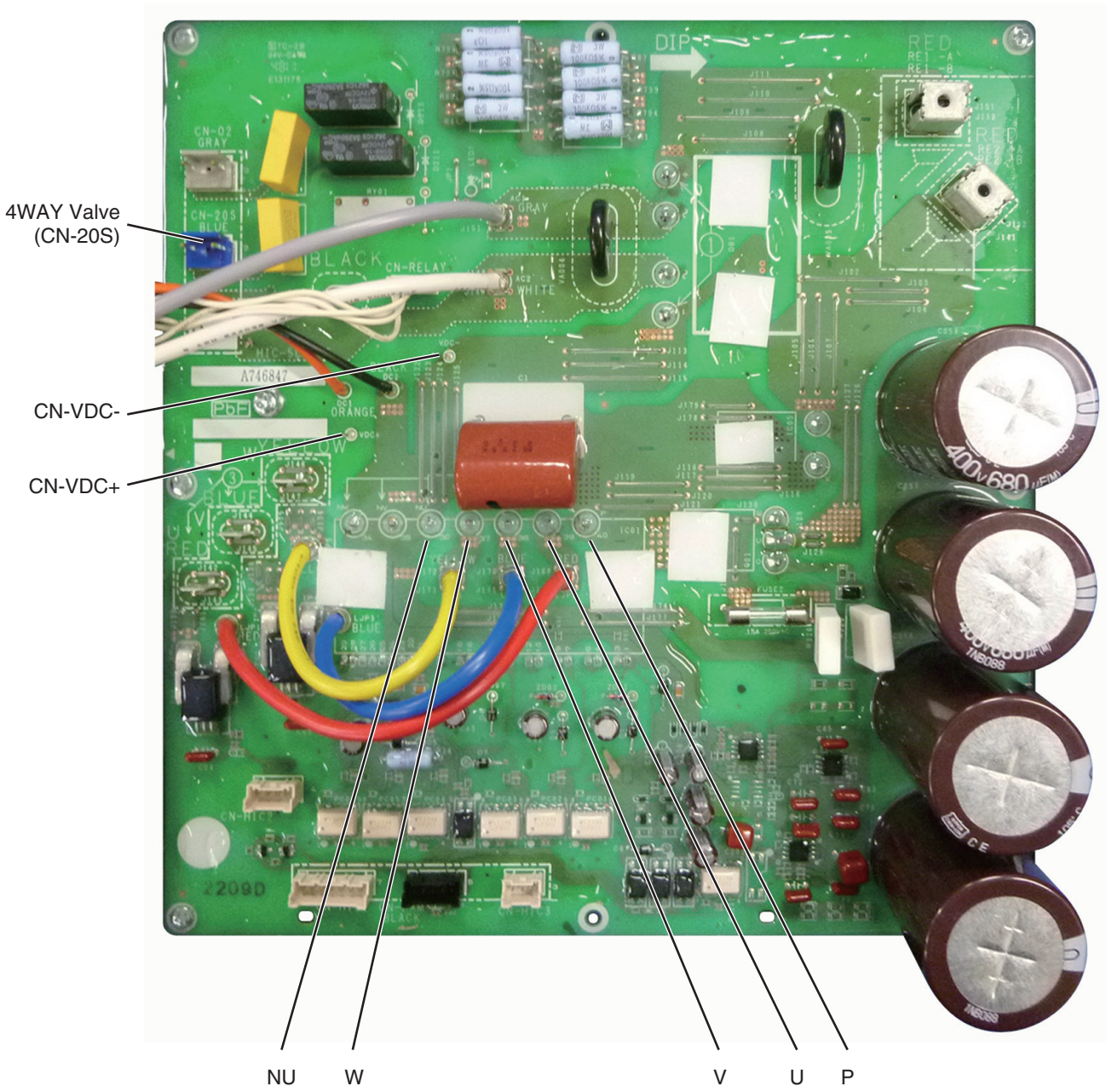


■ HIC-PCB  
A746846 (U-100PEY1E5)



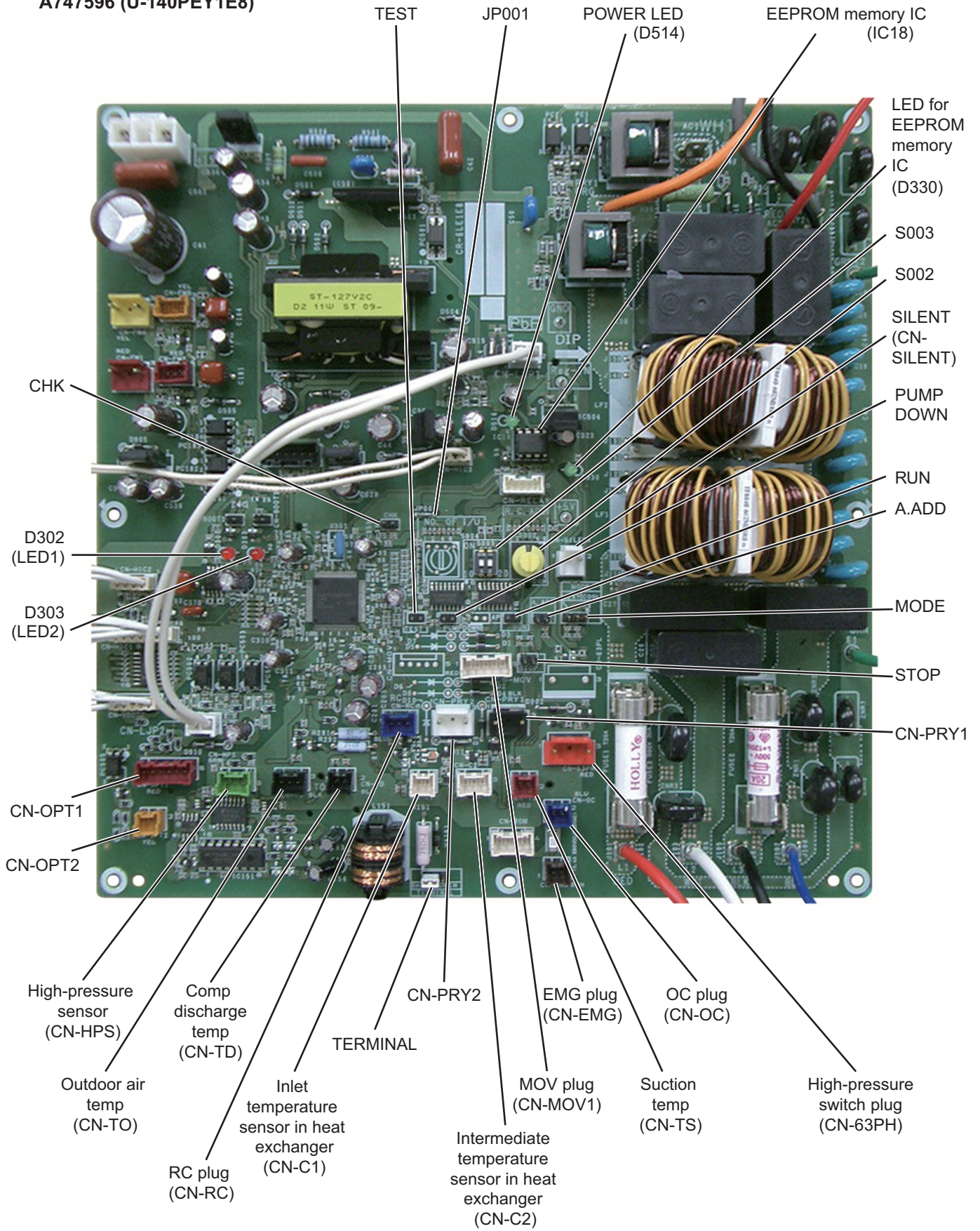
■ HIC-PCB (continued)  
A746847 (U-125PEY1E5)

4



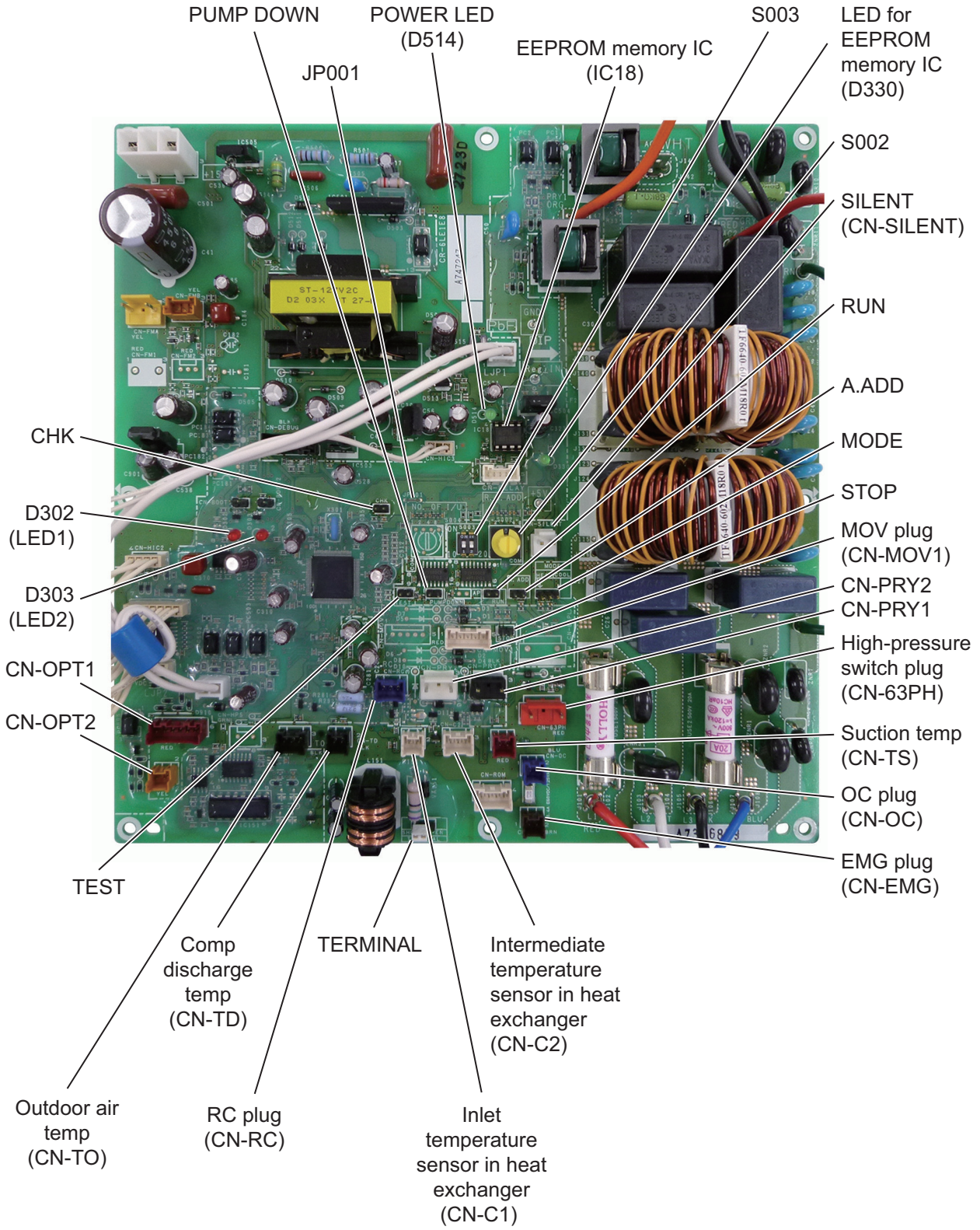


**CR-PCB**  
**A747899 (U-71PE1E8A)**  
**A747897 (U-100PE1E8A, U-125PE1E8A, U-140PE1E8A)**  
**A747596 (U-140PEY1E8)**

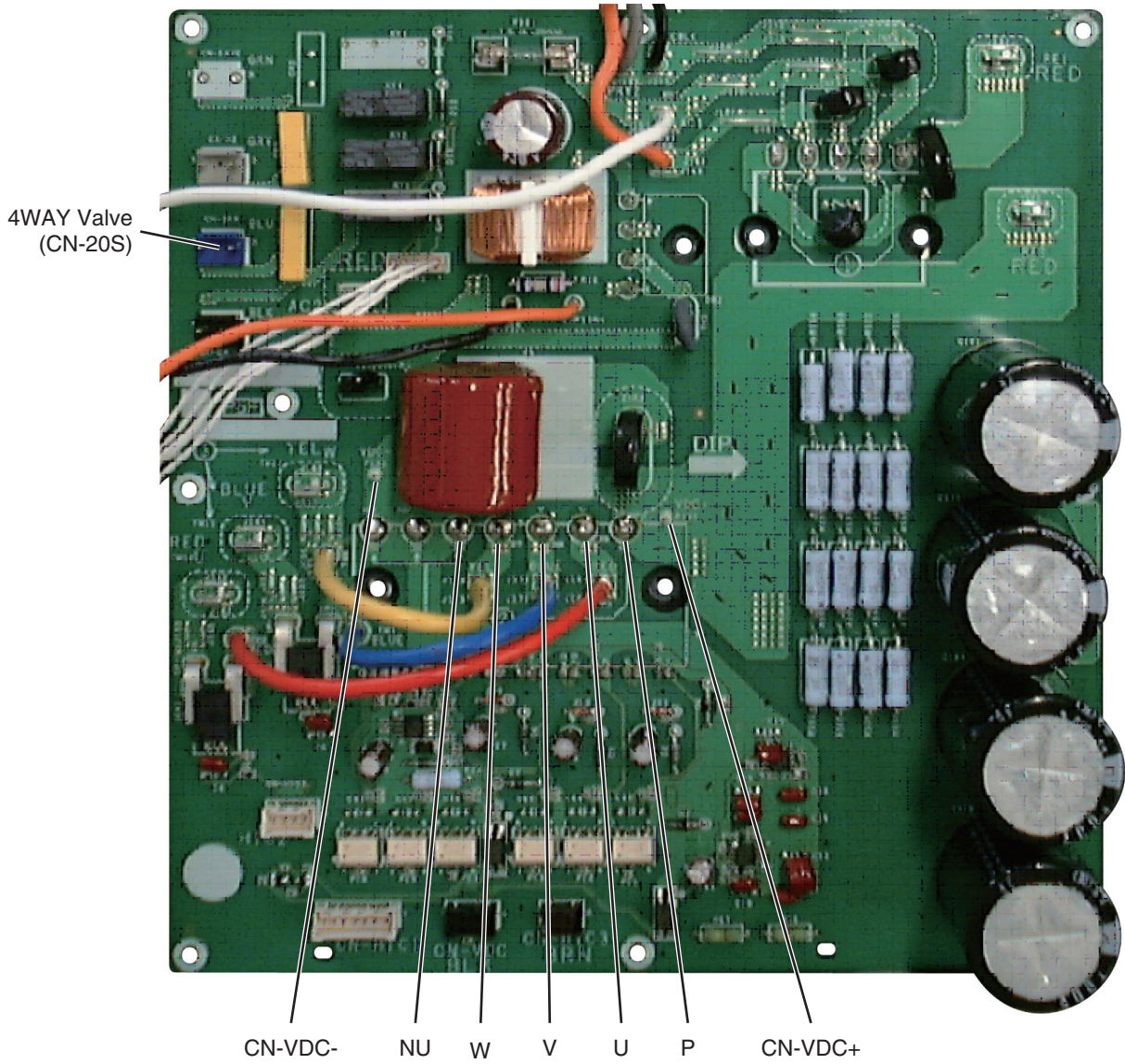


■ CR-PCB  
A747247 (U-100PEY1E8, U-125PEY1E8)

4



■ HIC-PCB  
A746970 (U-71PE1E8A)  
A746969 (U-100PE1E8A, U-125PE1E8A, U-140PE1E8A, U-140PEY1E8)



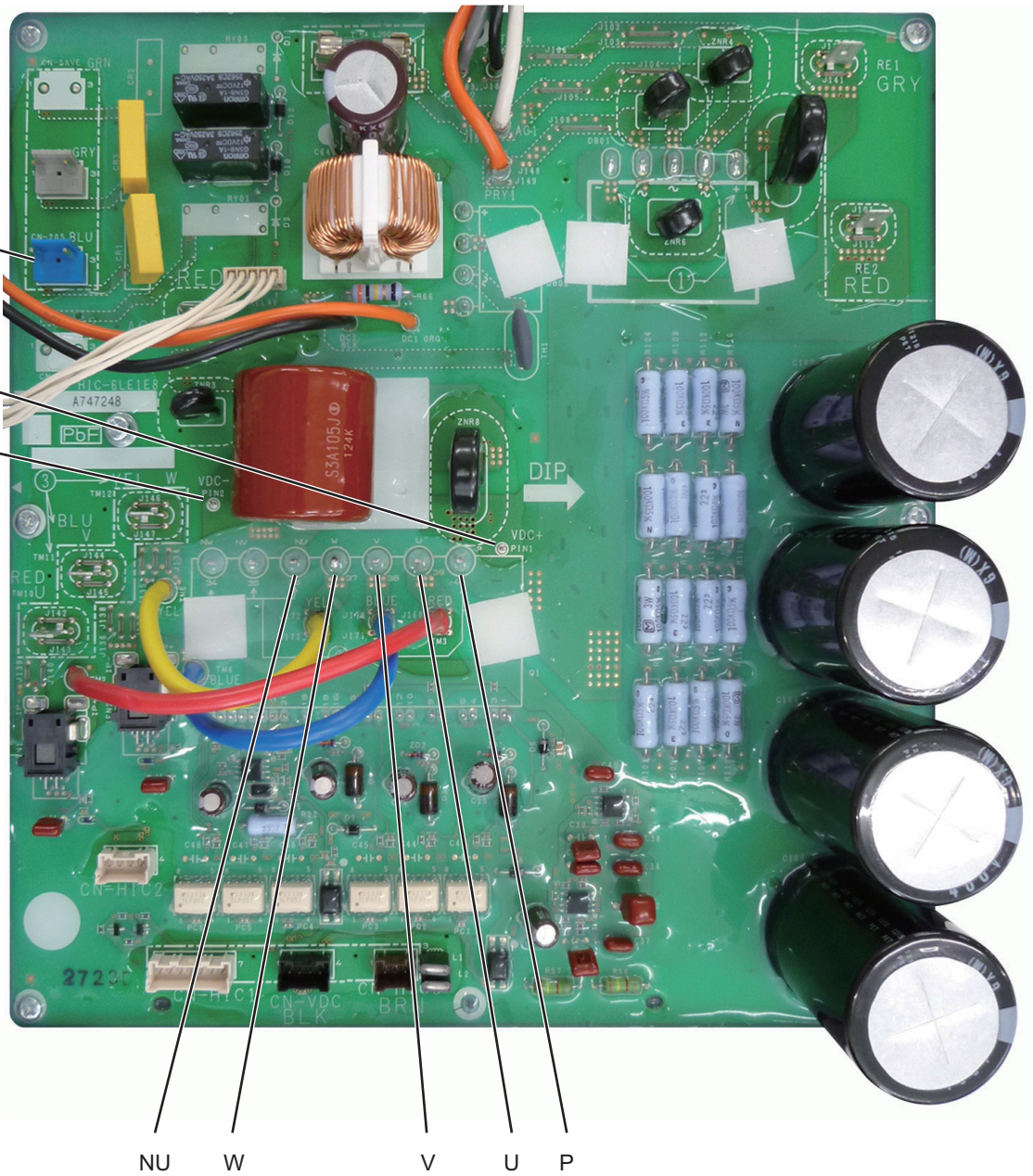
■ HIC-PCB  
A747248 (U-100PEY1E8, U-125PEY1E8)

4WAY Valve  
(CN-20S)

CN-VDC+

CN-VDC-

4



NU

W

V

U

P

## 2-1. Functions of Outdoor Unit PCB

|          |   |
|----------|---|
| CN-A.ADD | <p>2P plug : Automatic address setting pin</p> <ul style="list-style-type: none"> <li>• Short-circuit this pin for 1 second or longer to automatically set the addresses at the indoor units that are connected to that outdoor unit and are within the same system.</li> <li>• The system address is “1” at the time of shipment. Automatic address setting is necessary even for communications lines in a single system where the inter-unit control wiring does not cross to any other systems.</li> <li>• While automatic address setting is in progress, the 2 LEDs (LED1, 2: red) on the outdoor unit control PCB blink alternately. (Short-circuiting this pin while automatic address setting is in progress will stop the automatic address setting operation.)</li> </ul>  |
| S002     | <p>Rotary switch (10 positions, yellow): Outdoor system address setting switch</p> <ul style="list-style-type: none"> <li>• The setting is “1” at the time of shipment. It is not necessary to change the setting if wiring is connected only to an outdoor unit and indoor units in a single system and the inter-unit control wiring does not cross multiple systems.</li> <li>• If wiring links the inter-unit control wiring for multiple systems to the same communications lines, then a different address must be set for each refrigerant tubing system.</li> <li>• If wiring links multiple systems, a maximum of 30 systems (up to 64 indoor units) can be connected. This setting can be set up to “39,” however control will be for 30 systems even if the setting is set to higher than 30. An alarm will be displayed if system addresses are duplicated. (For details, refer to Table 1.)</li> </ul> |
| S003     | <p>DIP switch (2P): Switches for setting system address 10s digit and 20s digit</p> <ul style="list-style-type: none"> <li>• If 10 systems or more are set, the setting is made by a combination of this DIP switch and S002.</li> <li>• If 10 – 19 systems are set, set switch 1 (10s digit) to ON.</li> <li>• If 20 – 29 systems are set, set switch 2 (20s digit) to ON, and set switch 1 (10s digit) to OFF.</li> <li>• If 30 systems are set, set both switch 1 (10s digit) and switch 2 (20s digit) to ON.</li> </ul> <p>(For details concerning S002 and S003, refer to Table 1.)</p>  |
| JP001    | <p>Jumper wire</p>  |
| TERMINAL | <p>3P plug : For communications circuit impedance matching</p> <ul style="list-style-type: none"> <li>• A connecting socket (3P, black) is attached to the terminal plug at the time of shipment from the factory.</li> <li>• In the case of link wiring which combines the inter-unit control wiring for multiple systems into a single communications circuit, leave the connecting socket in place at only one of the outdoor units, and move the socket from the “SHORT” side to the “OPEN” side at all other outdoor units. If multiple connecting sockets are left in place, communications trouble will occur.</li> </ul>  |

|                              |  |
|------------------------------|--|
| LED 1 (D302)<br>LED 2 (D303) | LED (red × 2) <ul style="list-style-type: none"> <li>• LED 1 and 2 blink alternately while automatic address setting is in progress.</li> <li>• Display the alarm contents for alarms that are detected by the outdoor unit.</li> </ul>  |
| Power LED<br>(D330)          | LED (green): Power indicator<br>Indicates the DC 5V power on the outdoor unit control PCB.   |
| RUN<br>(CN-RUN)              | 2P plug (black) : Start pin<br>Short-circuit this pin and apply a pulse signal to start all indoor units in that refrigerant system.   |
| Stop<br>(CN-STOP)            | 2P plug (black): Stop pin<br>Short-circuit this pin and apply a pulse signal to stop all indoor units in that refrigerant system.  |
| PUMP DOWN<br>(CN-PUMPDOWN)   | 2P plug (black): Refrigerant recovery Pin <ul style="list-style-type: none"> <li>• Short circuit this pin to perform refrigerant recovery control using cooling operation. The indoor unit fan will operate at HIGH and 55 Hz for a maximum of 10 minutes. When refrigerant recovery is completed, close the valves and open circuit this pin to stop the operation.</li> </ul>  |
| Mode change<br>(CN-MODE)     | 3P plug (black): Indoor unit Heating/Cooling mode change pin <ul style="list-style-type: none"> <li>• When operating the compressors to perform automatic address setting, operation in Heating mode can be normally used. However, short-circuiting this pin performs operation in Cooling mode. (Static signal)</li> <li>• Short-circuiting this pin during ordinary operation changes the mode from Cooling to Heating (if the current mode is Cooling) or from Heating to Cooling (if the current mode is Heating).</li> </ul> |
| Test<br>(CN-TEST)            | 2P plug (black) <ul style="list-style-type: none"> <li>• This pin is used to test the PCB at the factory.</li> <li>• When the power is turned ON after this pin has been short-circuited, all output signals will be output in sequence. (Sequential output does not occur if this pin is short-circuited when the power is already ON.) Releasing this pin returns the unit to normal control.</li> </ul>   |
| CHK<br>(CN-CHK)              | 2P plug (black)<br>Short-circuit during the test run operation.<br>Open the circuit after the test run.  |

**Table 1. Setting the System Address [S002: Rotary switch (yellow), S003: 2P DIP (black)]**

|                                  | Outdoor system address No. | S002 setting (system address switch) | S003 setting   |                |
|----------------------------------|----------------------------|--------------------------------------|----------------|----------------|
|                                  |                            |                                      | 1P (10s digit) | 2P (20s digit) |
| <b>1 refrigerant system only</b> | 1                          | 0                                    | OFF            | OFF            |
| <b>Link wiring</b>               | 1                          | 1                                    | OFF            | OFF            |
|                                  | 2                          | 2                                    | OFF            | OFF            |
|                                  | 3                          | 3                                    | OFF            | OFF            |
|                                  | 4                          | 4                                    | OFF            | OFF            |
|                                  | 5                          | 5                                    | OFF            | OFF            |
|                                  | 6                          | 6                                    | OFF            | OFF            |
|                                  | 7                          | 7                                    | OFF            | OFF            |
|                                  | 8                          | 8                                    | OFF            | OFF            |
|                                  | 9                          | 9                                    | OFF            | OFF            |
|                                  | 10                         | 0                                    | ON             | OFF            |
|                                  | 11                         | 1                                    | ON             | OFF            |
|                                  | 12                         | 2                                    | ON             | OFF            |
|                                  | 13                         | 3                                    | ON             | OFF            |
|                                  | 14                         | 4                                    | ON             | OFF            |
|                                  | 15                         | 5                                    | ON             | OFF            |
|                                  | 16                         | 6                                    | ON             | OFF            |
|                                  | 17                         | 7                                    | ON             | OFF            |
|                                  | 18                         | 8                                    | ON             | OFF            |
|                                  | 19                         | 9                                    | ON             | OFF            |
|                                  | 20                         | 0                                    | OFF            | ON             |
|                                  | 21                         | 1                                    | OFF            | ON             |
|                                  | 22                         | 2                                    | OFF            | ON             |
|                                  | 23                         | 3                                    | OFF            | ON             |
|                                  | 24                         | 4                                    | OFF            | ON             |
|                                  | 25                         | 5                                    | OFF            | ON             |
|                                  | 26                         | 6                                    | OFF            | ON             |
|                                  | 27                         | 7                                    | OFF            | ON             |
|                                  | 28                         | 8                                    | OFF            | ON             |
|                                  | 29                         | 9                                    | OFF            | ON             |
|                                  | 30                         | 0                                    | ON             | ON             |

## 2-2. Self-Diagnostics Function Table

- Causes and corrections in instances when automatic address setting cannot be started.

| Trouble  | Cause and correction  |
|--|---|
| The power LED on the outdoor unit control PCB does not turn ON.  | Check for any errors in the power wiring to the outdoor unit, and check for a missing phase.  |
| LED 1 and 2 on the outdoor unit control PCB do not turn OFF when the outdoor unit power is turned ON, and automatic address setting cannot be started. | Check the "Alarm Displays" table and correct the problem.   |
| An alarm appears immediately when automatic address setting is started from the remote controller.   |   |
| Nothing happens when the operator attempts to start automatic address setting from the remote controller.  | Check that the remote controller wiring and the inter-unit control wiring are connected correctly.<br>Check that the indoor unit power is ON. |

- Causes and corrections in instances when automatic address setting starts, but cannot be completed successfully.

| Trouble  | Cause and correction   |
|--|--|
| An alarm appears on the remote controller sometime from several seconds to several minutes after automatic address setting is started.   | Check the "Alarm Displays" table and correct the problem.  |
| LED 1 and 2 on the outdoor unit control PCB indicate that automatic address setting is in progress (the LEDs blink alternately) for several minutes after automatic address setting is started (the compressors may also start and stop several times), however LED 1 and 2 never indicate that automatic address setting is completed (turn OFF). | Check the alarm details on the "Outdoor Unit Control PCB LED 1 and 2 Alarms" table, then check the "Alarm Displays" table and correct the problem. |

- If alarm E15, E16, or E20 appears after automatic address setting is started, check the following items.

| Alarm display | Alarm description  |
|---------------|--|
| E15           | The total capacity of indoor units is too lower than that of outdoor unit.   |
| E16           | The total capacity of indoor units is too higher than that of outdoor unit.  |
| E20           | The outdoor unit received no serial signals from indoor units within 90 seconds after automatic address setting was started. |



| Check items  | E15 | E16 | E20 |
|--|-----|-----|-----|
| Check that the indoor unit power is turned ON.   | ○   |     | ○   |
| Check that the inter-unit control wiring is connected correctly. (Check that there are no open circuits, short circuits, terminal plugs, incorrect wiring to the remote controller terminals, or similar problems.)                          | ○   | ○   | ○   |
| Check that the remote controller wiring is connected correctly. (Check that there are no open circuits, short circuits, incorrect wiring to the inter-unit control wiring terminals, control wiring for group control, or similar problems.) | ○   |     | ○   |
| Check that there are no indoor units where the system address was already incorrectly set by manual or automatic address setting.  |     | ○   |     |

- When automatic address setting is started from the outdoor unit control PCB or from the remote controller, **SETTING** (SETTING) appears on the remote controller at units where the inter-unit control wiring and remote controller wiring are connected correctly. LED 1 and 2 on the outdoor unit control PCB blink alternately.
- In the case of indoor unit group control, if there is a mistake in the remote controller inter-unit control wiring for group control, addresses may not be set even if **SETTING** (SETTING) appears.
- Even if alarm E15 or E16 appears, addresses are set at those indoor units which could be verified. The set addresses can be checked using the remote controller.
- If one of the below alarms appears when the remote controller is operated after automatic address setting was completed (LED 1 and 2 on the outdoor unit control PCB are turned OFF), follow the instructions in the table below and correct the problem location.

| Remote controller display | Cause   |
|---------------------------|---|
| Nothing is displayed.     | The remote controller is not connected correctly (power trouble).<br>The indoor unit power was cut off after automatic address setting was completed.   |
| E01                       | The remote controller is not connected correctly (remote controller receiving trouble).<br>The remote controller of an indoor unit where the indoor unit address is not set is inadvertently operated. (Communications with the outdoor unit are not possible.) |
| E02                       | The remote controller is not connected correctly (trouble with sending of the signal from the remote controller to the indoor unit).  |
| E09                       | The indoor unit ceiling panel connector is not connected correctly.   |

- The outdoor unit maintenance remote controller can be used to check the alarm display.  
The number of times that LED 1 and 2 blink on the outdoor unit control PCB can be used to check the alarm display.  
(Refer to "Checking the LED 1 and 2 Alarm Display on the Outdoor Unit Control PCB.")

| Alarm Code | Alarm Meaning   |
|------------|---|
| E01        | Remote Controller Reception Error   |
| E02        | Remote Controller Transmission Error  |
| E03        | Error in Indoor Unit Receiving Signal from Remote Controller (central)  |
| E04        | Error in Indoor Unit Receiving Signal from the Outdoor Unit   |
| E05        | Error in Indoor Unit Transmitting Signal to the Outdoor Unit  |
| E06        | Outdoor Unit Failed to Receive Serial Communication Signals from Indoor Unit  |
| E08        | Duplicate Indoor Unit Address Settings Error  |
| E09        | More Than One Remote Controller Set to Main Error   |
| E12        | Automatic Address Setting Start is Prohibited while Auto-address Setting in Progress.                                     |
| E14        | Main Unit duplication in Simultaneous-operation Multi Control (detected outdoor unit)                                     |
| E15        | Automatic Address Alarm (The total capacity of indoor units is too low.)  |
| E16        | Automatic Address Alarm (The total capacity of indoor units is too high or the total number of indoor units is too many.) |
| E18        | Faulty Communication in Group Control Wiring  |
| E20        | Connection Problem of Indoor/Outdoor Units.   |

|     |  |
|-----|--|
| F04 | Compressor Discharge Temperature Sensor (TD) Trouble           |
| F06 | Inlet Temperature Sensor (C1) in Heat Exchanger Trouble        |
| F07 | Intermediate Temperature Sensor (C2) in Heat Exchanger Trouble |
| F08 | Outdoor Air Temperature Sensor (TO) Trouble                    |
| F12 | Compressor Inlet Suction Temperature Sensor (TS) Trouble       |
| F31 | Outdoor Unit Nonvolatile Memory (EEPROM) Trouble               |

|     |  |
|-----|--|
| H01 | Primary (input) Overcurrent Detected               |
| H02 | PAM Trouble  |
| H03 | Primary Current CT Sensor (current sensor) Failure |
| H31 | HIC Trouble  |

|     |  |
|-----|--|
| L04 | Outdoor Unit Address Duplication         |
| L10 | Outdoor Unit Capacity not Set or Invalid |
| L13 | Indoor Unit Type Setting Error           |
| L18 | 4-way Valve Operation Failure            |

|     |  |
|-----|--|
| P03 | Compressor Discharge Temperature Trouble   |
| P04 | High Pressure Trouble  |
| P05 | AC Power Supply Trouble  |
| P13 | Alarm Valve Open   |
| P14 | O <sub>2</sub> Sensor Detect   |
| P15 | Insufficient Gas Level Detected  |
| P16 | Compressor Overcurrent Trouble   |
| P22 | Outdoor Unit Fan Motor Trouble   |
| P26 | Inverter Protector Circuit was Activated   |
| P29 | Lack of INV compressor wiring, INV compressor actuation failure (including locked), DCCT failure |
| P31 | Group Control Error  |

## 5. TROUBLE DIAGNOSIS

|      |  |      |
|------|--|------|
| 5-1. | Contents of Remote Controller Switch Alarm Display .....                     | 5-2  |
| 5-2. | Outdoor Unit Control Panel LED Display .....                                 | 5-6  |
| 5-3. | PAC System Alarm Codes .....   | 5-7  |
| 5-4. | Inspection of Parts (Outdoor Unit) .....                                     | 5-78 |
| 5-5. | Symptom: Thermostat in OFF continues or cycles OFF & ON too frequently ..... | 5-79 |
| 5-6. | How to Clean Heat Exchanger .....  | 5-80 |
| 5-7. | How to Replace Fan Motor .....   | 5-81 |

## 5-1. Contents of Remote Controller Switch Alarm Display

U-36PE2E5A, U-50PE2E5A, U-60PE2E5A  
U-60PEY2E5, U-71PEY2E5

ON: ○ Blinking: ☀ OFF: ●

| Possible cause of malfunction                                       |  |   | Wired remote control display   | Wireless remote controller receiver display                  |                                  |         |  |
|---|--|---|--|--|----------------------------------|---------|--|
|   |  |   |  | Operation  | Timer                            | Standby |  |
| Serial communication errors<br>Missetting                           | Failure in receiving serial signal from remote controller's indoor unit  | Faulty remote controller  | E01  | Operating lamp blinking<br>☀ ● ●                             |                                  |         |  |
|   |  | Disconnection/Contact failure of remote controller wiring   |  |  |                                  |         |  |
|   |  | CHK(check) pins on the indoor unit control PCB are short circuited  |  |  |                                  |         |  |
|   | Settings of system address, indoor unit address and group control are not made   | In the case of non-group control:<br>• Power supply OFF of outdoor unit<br>• Disconnection / Contact failure of inter-unit wiring   | E02  |  |                                  |         |  |
|   |  | In the case of group control:<br>Automatic address operation was not carried out.   |  |  |                                  |         |  |
|   | Setting failure of nonvolatile memory IC   | Faulty setting of EEPROM (IC10) on indoor unit  | E03  |  |                                  |         |  |
|   | Failure in indoor unit serial signal from remote controller  | Faulty remote controller  | E04  |  |                                  |         |  |
|   |  | Wrong wiring of remote controller   |  |  |                                  |         |  |
|   | Error in indoor unit receiving signal from remote controller (central)   |   |  | E05  |                                  |         |  |
|   | Failure in indoor unit receiving serial signal from outdoor unit   | Disconnection / Contact failure of inter-unit wiring  | E06  | Standby lamp blinking<br>● ● ☀                               |                                  |         |  |
|   |  | • Faulty indoor unit control PCB<br>• Faulty outdoor unit control PCB<br>• Communication circuit fuse (F302) on indoor unit control PCB opened<br>• Fuse on outdoor unit control PCB opened<br>Since failure of an outdoor fan motor is considered as a cause, both outdoor unit control PCB and outdoor unit fan motor are exchanged simultaneously. |  |  |                                  |         |  |
|   | Failure in outdoor unit receiving serial signal from indoor unit   | • Disconnection / Contact failure of inter-unit wiring  | E07  |  |                                  |         |  |
|   |  | • Disconnection of inter-unit wiring<br>• Communication circuit fuse (F302) on indoor unit control PCB opened   |  |  |                                  |         |  |
|   |  | Indoor unit control PCB address setting error   |  |  |                                  |         |  |
|   | Duplication of indoor unit address   | Duplication of indoor unit address setting  | E08  |  |                                  |         |  |
|   | Duplication of main remote controller setting  | Error because of more than one remote controller setting to main  | E09  |  |                                  |         |  |
|   |  | Improper setting  | Automatic address setting start is prohibited                            | E12  | Operating lamp blinking<br>☀ ● ● |         |  |
|   |  | Duplication of main unit in group control   | E14  |  |                                  |         |  |
|   | Communication error between main and sub indoor units  | • Disconnection of wiring between main unit and additional units<br>• Contact failure of wiring<br>• Faulty indoor unit control PCB (Main or Addition)  | E18  |  |                                  |         |  |
|   |  | Automatic address settings failure  | Automatic Address Alarm<br>The total capacity of indoor units is too low | E15  | Standby lamp blinking<br>● ● ☀   |         |  |
|   | Automatic Address Alarm<br>The total capacity of indoor units is too high<br>The number of indoor units is two or more | E16   |  |  |                                  |         |  |
|   | Automatic Address Alarm<br>No indoor unit connected  | E20   |  |  |                                  |         |  |
| Outdoor unit Communication error                                    |  |   | E24  |  |                                  |         |  |
| Outdoor unit Communication error                                    |  |   | E29  |  |                                  |         |  |
| Indoor & outdoor unit type miss-matched                             | Setting error, indoor/outdoor unit type/model miss-matched   | L02   |  |  |                                  |         |  |
| Duplication of group control's main indoor unit                     | Duplication of main indoor unit address in group control   | L03   | Operating and standby lamps blinking simultaneously<br>☀ ● ☀             |  |                                  |         |  |
| Group control wiring is connected to individual control indoor unit | Group control wiring is connected to individual control indoor unit  | L07   |  |  |                                  |         |  |
| Indoor unit address is not set                                      |  |   | L08  |  |                                  |         |  |
| Indoor unit capacity is not set                                     |  |   | L09  |  |                                  |         |  |
| Duplication of outdoor unit address                                 |  |   | L04  | Operating and standby lamps blinking simultaneously<br>☀ ○ ☀ |                                  |         |  |
| Outdoor unit capacity is not set or setting error                   |  |   | L10  |  |                                  |         |  |
| Indoor unit type setting error                                      |  |   | L13  |  |                                  |         |  |
| 4-way valve locked trouble / operation failure                      |  |   | L18  |  |                                  |         |  |

Continued

ON: ○ Blinking: ☀ OFF: ●

| Possible cause of malfunction  |   |  | Wired remote control display                     | Wireless remote controller receiver display     |       |         |   |
|--|---|--|--|---|-------|---------|---|
|  |   |  |  | Operation                                       | Timer | Standby |   |
| Activation of protective device  | Indoor unit fan motor trouble   | Indoor unit fan motor locked                               | P01  |   |       |         |   |
|  |   | Indoor unit fan motor layer short                          |  |   |       |         |   |
|  |   | Contact failure in thermostat protector circuit            |  |   |       |         |   |
|  | Faulty wiring connections of (ceiling) indoor unit panel                |  | P09  |   |       |         |   |
|  | Activation of float switch wiring                                       | Faulty drain pump  | P10  | Timer and standby lamp blinking alternately     |       |         |   |
|  |   | Drainage failure   |  |   |       |         |   |
|  |   | Contact failure of float switch wiring                     |  |   |       |         |   |
|  | Faulty drain pump   | Faulty drain pump  | P11  | ●   | ☀     | ☀       |   |
|  |   | Drain pump locked  |  |   |       |         |   |
|  | Indoor unit fan motor trouble   | Indoor unit fan motor locked                               | P12  |   |       |         |   |
|  | Valve error   | Valve error  | P13  |   |       |         |   |
|  | O <sub>2</sub> sensor error   | O <sub>2</sub> sensor detected                             | P14  |   |       |         |   |
|  | Discharge temperature protective alarm                                  | Compressor discharge temperature trouble                   | P03  |   |       |         |   |
|  | Activation of high pressure switch                                      | Compressor discharge pressure trouble                      | P04  |   |       |         |   |
|  | Power supply failure  | Open phase detected<br>AC power supply trouble             | P05  |   |       |         |   |
|  | Insufficient gas  | Insufficient gas level detected                            | P15  | Operating and standby lamp blinking alternately |       |         |   |
|  | Compressor overcurrent trouble  |  | P16  |   |       |         |   |
|  | Fan motor locked/reversed airflow detected                              | Outdoor unit fan motor trouble<br>Outdoor unit fan trouble | P22  | ☀   | ●     | ☀       |   |
|  | Inverter compressor trouble<br>Refrigerant circuit blockage<br>Gas leak |  | P29  |   |       |         |   |
|  | Group control trouble   | Indoor unit in group control trouble                       | P31  |   |       |         |   |
| Activation of current control compressor's protective device                         | Primary (input) overcurrent detected                                    | H01  |  |   |       |         |   |
| PAM trouble (overcurrent/over-voltage), Activation of compressor's protective device | PAM trouble   | H02  | Timer lamp blinking                              |   |       |         |   |
| Primary current control, Activation of compressor's protective device                | Primary current CT sensor failure                                       | H03  | ●  | ☀   | ●     |         |   |
| HIC trouble  | HIC trouble<br>DC voltage not detected                                  | H31  |  |   |       |         |   |
| Thermistor fault   | Indoor unit thermistor open/short                                       | Indoor heat exchanger temperature sensor (E1) trouble      | F01  | Operating and timer lamp blinking alternately   |       |         |   |
|  |   | Indoor heat exchanger temperature sensor (E2) trouble      |  |   |       |         |   |
|  |   | Indoor air temperature sensor (TA) trouble                 |  |   | ☀     | ☀       | ● |
|  | Outdoor unit thermistor open/short                                      | Compressor discharge temperature sensor (TD) trouble       | F04  | Operating and timer lamp blinking alternately   |       |         |   |
|  |   | Outdoor heat exchanger temperature sensor (C1) trouble     | F06  |   |       |         |   |
|  |   | Outdoor heat exchanger temperature sensor (C2) trouble     | F07  |   | ☀     | ☀       | ○ |
|  |   | Outdoor air temperature sensor (TO) trouble                | F08  |   |       |         |   |
| Compressor suction temperature sensor (TS) trouble                                   | F12   |  |  |   |       |         |   |
| Nonvolatile memory failure   | Indoor unit EEPROM trouble  | F29  | Operating and timer lamp blinking simultaneously | ☀   | ☀     | ●       |   |
|  | Outdoor unit EEPROM trouble   | F31  | Operating and timer lamp blinking simultaneously | ☀   | ☀     | ○       |   |

U-71PE1E5A ~ U-140PE1E5A / U-71PE1E8A / U-140PE1E8A  
 U-100PEY1E5, U-125PEY1E5 / U-100PEY1E8 ~ U140PEY1E8

ON: ○ Blinking: ☀ OFF: ●

| Possible cause of malfunction   |  | Wired remote control display   | Wireless remote controller receiver display         |                         |         |   |
|---|--|--|---|-------------------------|---------|---|
|   |  |  | Operation   | Timer                   | Standby |   |
| Serial communication errors<br>Missetting                                 | Failure in receiving serial signal from remote controller's indoor unit        | Faulty remote controller   |   |                         |         |   |
|   |  | Disconnection/Contact failure of remote controller wiring  |   |                         |         |   |
|   |  | CHK(check) pins on the indoor unit control PCB are short circuited   |   |                         |         |   |
|   | Settings of system address, indoor unit address and group control are not made | In the case of non-group control:  | E01   | Operating lamp blinking | ●       | ● |
|   |  | <ul style="list-style-type: none"> <li>Power supply OFF of outdoor unit</li> <li>Disconnection / Contact failure of inter-unit wiring</li> </ul> In the case of group control:<br>Automatic address operation was not carried out.   |   |                         |         |   |
|   | Setting failure of nonvolatile memory IC                                       | Faulty setting of EEPROM (IC1010) on indoor unit   |   |                         |         |   |
|   | Failure in indoor unit serial signal from remote controller                    | Faulty remote controller   | E02   |                         |         |   |
|   |  | Wrong wiring of remote controller  |   |                         |         |   |
|   | Error in indoor unit receiving signal from remote controller (central)         |  | E03   |                         |         |   |
|   | Failure in indoor unit receiving serial signal from outdoor unit               | Disconnection / Contact failure of inter-unit wiring   | E04   | Standby lamp blinking   | ●       | ● |
|   |  | <ul style="list-style-type: none"> <li>Faulty indoor unit control PCB</li> <li>Faulty outdoor unit control PCB</li> <li>Communication circuit fuse (F302) on indoor unit control PCB opened</li> <li>Fuse on outdoor unit control PCB opened</li> </ul> Since failure of an outdoor fan motor is considered as a cause, both outdoor unit control PCB and outdoor unit fan motor are exchanged simultaneously. |   |                         |         |   |
|   | Failure in outdoor unit receiving serial signal from indoor unit               | Disconnection / Contact failure of inter-unit wiring   | E06   | ●                       | ●       | ☀ |
|   |  | <ul style="list-style-type: none"> <li>Disconnection of inter-unit wiring</li> <li>Communication circuit fuse (F302) on indoor unit control PCB opened</li> </ul>  |   |                         |         |   |
|   |  | Indoor unit control PCB address setting error  |   |                         |         |   |
|   | Duplication of indoor unit address   | Duplication of indoor unit address setting   | E08   |                         |         |   |
|   | Duplication of main remote controller setting                                  | Error because of more than one remote controller setting to main   | E09   |                         |         |   |
|   | Improper setting   | Automatic address setting start is prohibited  | E12   | Operating lamp blinking | ●       | ● |
|   |  | Duplication of main unit in group control  | E14   |                         |         |   |
|   | Communication error between main and sub indoor units                          | <ul style="list-style-type: none"> <li>Disconnection of wiring between main unit and additional units</li> <li>Contact failure of wiring</li> <li>Faulty indoor unit control PCB (Main or Addition)</li> </ul>   | E18   | ☀                       | ●       | ● |
|   | Automatic address settings failure   | Automatic Address Alarm<br>The total capacity of indoor units is too low   | E15   | Standby lamp blinking   | ●       | ● |
| Automatic Address Alarm<br>The total capacity of indoor units is too high |  | E16  |   |                         |         |   |
| Automatic Address Alarm<br>No indoor unit connected                       |  | E20  |   |                         |         |   |
| Outdoor unit Communication error  |  | E24  |   |                         |         |   |
| Outdoor unit Communication error  |  | E29  |   |                         |         |   |
| Indoor & outdoor unit type miss-matched                                   | Setting error, indoor/outdoor unit type/model miss-matched                     | L02  |   |                         |         |   |
| Duplication of group control's main indoor unit                           | Duplication of main indoor unit address in group control                       | L03  | Operating and standby lamps blinking simultaneously | ☀                       | ●       |   |
| Group control wiring is connected to individual control indoor unit       | Group control wiring is connected to individual control indoor unit            | L07  |   |                         |         |   |
| Indoor unit address is not set  |  | L08  | ☀   | ●                       | ☀       |   |
| Indoor unit capacity is not set   |  | L09  |   |                         |         |   |
| Duplication of outdoor unit address                                       |  | L04  | Operating and standby lamps blinking simultaneously | ☀                       | ○       |   |
| Outdoor unit capacity is not set or setting error                         |  | L10  |   |                         |         |   |
| Indoor unit type setting error  |  | L13  |   |                         |         |   |
| 4-way valve locked trouble / operation failure                            |  | L18  | ☀   | ○                       | ☀       |   |

Continued

ON: ○ Blinking: ☀ OFF: ●

| Possible cause of malfunction  |  |  | Wired remote control display                     | Wireless remote controller receiver display     |       |         |
|--|--|--|--|---|-------|---------|
|  |  |  |  | Operation                                       | Timer | Standby |
| Activation of protective device  | Indoor unit fan motor trouble                            | Indoor unit fan motor locked   | P01  |   |       |         |
|  |  | Indoor unit fan motor layer short  |  |   |       |         |
|  |  | Contact failure in thermostat protector circuit                                    |  |   |       |         |
|  | Faulty wiring connections of (ceiling) indoor unit panel |  | P09  |   |       |         |
|  | Activation of float switch wiring                        | Faulty drain pump  | P10  | Timer and standby lamp blinking alternately     |       |         |
|  |  | Drainage failure   |  |   |       |         |
|  |  | Contact failure of float switch wiring   |  |   |       |         |
|  | Faulty drain pump  | Faulty drain pump  | P11  | ●   | ☀     | ☀       |
|  |  | Drain pump locked  |  |   |       |         |
|  | Indoor unit fan motor trouble                            | Indoor unit fan motor locked<br>Faulty wiring connections of indoor unit fan motor | P12  |   |       |         |
|  | Valve error  | Valve error  | P13  |   |       |         |
|  | O <sub>2</sub> sensor error                              | O <sub>2</sub> sensor detected   | P14  |   |       |         |
|  | Discharge temperature protective alarm                   | Compressor discharge temperature trouble   | P03  |   |       |         |
|  | Activation of high pressure switch                       | Compressor discharge pressure trouble  | P04  |   |       |         |
|  | Power supply failure                                     | Open phase detected<br>AC power supply trouble                                     | P05  | Operating and standby lamp blinking alternately |       |         |
|  | Insufficient gas   | Insufficient gas level detected  | P15  |   |       |         |
|  | Compressor overcurrent trouble                           |  | P16  | ☀   | ●     | ☀       |
|  | Fan motor locked/reversed airflow detected               | Outdoor unit fan motor trouble   | P22  |   |       |         |
|  |  | Outdoor unit fan trouble   |  |   |       |         |
|  | Inverter compressor trouble                              |  | P29  |   |       |         |
| Group control trouble  | Indoor unit in group control trouble                     | P31  |  |   |       |         |
| Activation of current control compressor's protective device                         | Primary (input) overcurrent detected                     | H01  |  |   |       |         |
| PAM trouble (overcurrent/over-voltage), Activation of compressor's protective device | PAM trouble  | H02  | Timer lamp blinking                              |   |       |         |
| Primary current control, Activation of compressor's protective device                | Primary current CT sensor failure                        | H03  | ●  | ☀   | ●     |         |
| HIC trouble  | HIC trouble<br>DC voltage not detected                   | H31  |  |   |       |         |
| Thermistor fault   | Indoor unit thermistor open/short                        | Indoor heat exchanger temperature sensor (E1) trouble                              | F01  | Operating and timer lamp blinking alternately   |       |         |
|  |  | Indoor heat exchanger temperature sensor (E2) trouble                              | F02  |   |       |         |
|  |  | Indoor air temperature sensor (TA) trouble   | F10  | ☀   | ☀     | ●       |
|  | Outdoor unit thermistor open/short                       | Compressor discharge temperature sensor (TD) trouble                               | F04  | Operating and timer lamp blinking alternately   |       |         |
|  |  | Outdoor heat exchanger temperature sensor (C1) trouble                             | F06  |   |       |         |
|  |  | Outdoor heat exchanger temperature sensor (C2) trouble                             | F07  |   |       |         |
|  |  | Outdoor air temperature sensor (TO) trouble  | F08  | ☀   | ☀     | ○       |
| Compressor suction temperature sensor (TS) trouble                                   | F12  |  |  |   |       |         |
| Nonvolatile memory failure   | Indoor unit EEPROM trouble                               | F29  | Operating and timer lamp blinking simultaneously |   |       |         |
|  | Outdoor unit EEPROM trouble                              | F31  | Operating and timer lamp blinking simultaneously |   |       |         |

## 5-2. Outdoor Unit Control Panel LED Display

( ○ : ON    ☀ : Blinking    ● : OFF )

| LED1                            | LED2 | Display meaning   |
|---------------------------------|------|---|
| ○                               | ○    | After the power is turned ON (and automatic address setting is not in progress), no communication with the indoor units in that system is possible.   |
| (Both ON)                       |      |   |
| ●                               | ○    | After power is turned ON (and automatic address setting is not in progress), 1 or more indoor units are confirmed in that system; however, the number of indoor units does not match the number that was set.   |
| (OFF)                           | (ON) |   |
| ●                               | ●    | Automatic address setting was completed successfully. (After the power is turned ON, the number of detected indoor units connected to that system matches the number that was set, and regular communications are occurring.)   |
| (Both OFF)                      |      |   |
| ☀                               | ☀    | Automatic address setting is in progress.   |
| (Blinking alternately)          |      |   |
| ☀                               | ☀    | Alarm display<br>LED 1 blinks M times, then LED 2 blinks N times. The cycle then repeats.<br>M = 2: P alarm 3: H alarm 4: E alarm 5: F alarm 6: L alarm<br>N = Alarm No.<br>Example: LED 1 blinks 2 times, then LED 2 blinks 16 times. The cycle then repeats.<br>Alarm is "P16." |
| (Blinking alternately)          |      |   |
| ☀                               | ○    | PUMP DOWN is in progress.   |
| LED 1 : Blinking<br>LED 2 : ON  |      |   |
| ☀<br>(0.8 / 0.3) *              | ●    | P04 (High pressure trouble) Pre-trip display  |
| LED 1 : Blinking<br>LED 2 : OFF |      |   |
| ☀<br>(0.5 / 0.5)                | ●    | Other Pre-trip display  |
| LED 1 : Blinking<br>LED 2 : OFF |      |   |

\* Blinking (0.8 / 0.3) indicates that the lamp illuminates for 0.8 seconds, and then is OFF 0.3 seconds.



### 5-3. PAC System Alarm Codes

U-36PE2E5A, U-50PE2E5A, U-60PE2E5A  
U-60PEY2E5, U-71PEY2E5

#### Alarms for outdoor units

| Alarm Code | Alarm Meaning  |
|------------|--|
| E01        | Remote Controller Reception Error  |
| E02        | Remote Controller Transmission Error   |
| E03        | Error in Indoor Unit Receiving Signal from Remote Controller (central)   |
| E04        | Error in Indoor Unit Receiving Signal from the Outdoor Unit  |
| E05        | Error in Indoor Unit Transmitting Signal to the Outdoor Unit   |
| E06        | Outdoor Unit Failed to Receive Serial Communication Signals from Indoor Unit   |
| E08        | Duplicate Indoor Unit Address Settings Error   |
| E09        | More Than One Remote Controller Set to Main Error  |
| E12        | Automatic Address Setting Start is Prohibited while Auto-address Setting in Progress.                                  |
| E14        | Main Unit duplication in Simultaneous-operation Multi Control (detected outdoor unit)                                  |
| E15        | Automatic Address Alarm (The total capacity of indoor units is too low.)   |
| E16        | Automatic Address Alarm (The total capacity of indoor units is too high or the number of indoor units is two or more.) |
| E18        | Faulty Communication in Group Control Wiring   |
| E20        | Connection Problem of Indoor/Outdoor Units.  |
|            |  |
| F04        | Compressor Discharge Temperature Sensor (TD) Trouble   |
| F06        | Inlet Temperature Sensor (C1) in Heat Exchanger Trouble  |
| F07        | Intermediate Temperature Sensor (C2) in Heat Exchanger Trouble   |
| F08        | Outdoor Air Temperature Sensor (TO) Trouble  |
| F12        | Compressor Inlet Suction Temperature Sensor (TS) Trouble   |
| F31        | Outdoor Unit Nonvolatile Memory (EEPROM) Trouble   |
|            |  |
| H01        | Primary (input) Overcurrent Detected   |
| H02        | PAM Trouble  |
| H03        | Primary Current CT Sensor (current sensor) Failure   |
| H31        | HIC Trouble  |
|            |  |
| L04        | Outdoor Unit Address Duplication   |
| L10        | Outdoor Unit Capacity not Set or Invalid   |
| L13        | Indoor Unit Type Setting Error   |
| L18        | 4-way Valve Operation Failure  |
|            |  |
| P03        | Compressor Discharge Temperature Trouble   |
| P04        | High Pressure Trouble  |
| P05        | AC Power Supply Trouble  |
| P13        | Alarm Valve Open   |
| P14        | O <sub>2</sub> Sensor Detect   |
| P15        | Insufficient Gas Level Detected  |
| P16        | Compressor Overcurrent Trouble   |
| P22        | Outdoor Unit Fan Motor Trouble   |
| P29        | Lack of INV compressor wiring, INV compressor actuation failure (including locked), DCCT failure                       |
| P31        | Group Control Error  |

Symptoms and Parts to Inspect

| Remote controller alarm display | Alarm contents   | Judgement conditions   | Eliminating condition of alarm | Judgement and correction  |
|---------------------------------|--|--|--------------------------------|---|
| P03                             | Abnormal discharge temperature error<br>• Discharge temp. detected at or above the specified value                             | Stops when temp. exceeds 101 °C.<br>Alarm output on 5 pre-trips  | Recovery at restart            | 1. Check refrigerant cycle (gas leak).<br>2. Trouble with electronic expansion valve<br>3. Check discharge temperature sensor (TD).   |
| P05                             | CT disconnected or AC power supply error   | The current value transmitted from the microcomputer on the outdoor unit control substrate is low.<br>When no AC power input for more than 30 seconds to 5 minutes : Single alarm                              | Recovery at restart            | 1. Check outdoor unit control PCB.<br>2. Lack of reactor wire   |
| P15                             | Insufficient gas level detected.   | • Discharge temperature is 95 °C or higher.<br>• Electronic expansion valve is at Step 480.<br>When the above has continued for 1 minute. Indoor air sucking due to body thermostat max (E1 or E2) - TA ≤ 4 °C | Recovery at restart            | 1. Check refrigerant cycle (gas leak).<br>2. Trouble with electronic expansion valve<br>3. Check outdoor unit valve opening.  |
| L18                             | 4-way valve operation failure<br>• Judged after heating operating for 5 minutes consecutively.                                 | The indoor unit heat exchanger temperature drops even though the compressor is switched on during the heating mode:<br>To +20 °C ≤ C1<br>Pre-trip 1 time   | Recovery at restart            | 1. Check 4-way valve.<br>2. Check 4-way valve wiring.<br>3. Check outdoor unit control PCB.   |
| P04                             | High-pressure protection error   | High pressure switched ON → OFF<br>(Alarm is output when switch opened.) Pre-trip 4 times.   | Recovery at restart            | Overload operation of refrigerant cycle   |
| P22                             | Outdoor unit fan motor trouble<br>• Inverter protection circuit was activated, or lock was detected at outdoor unit fan motor. | Inverter stops after alarm is detected. Pre-trip 10 times  | Recovery at restart            | 1. Position detection trouble.<br>2. Outdoor unit fan motor over-current Protection circuit is activated.<br>• Check outdoor unit control PCB.<br>• Refer to outdoor unit fan judgement methods.  |
| P29                             | Lack of INV compressor wiring, INV compressor actuation failure, DCCT failure  | Inverter stops after alarm is detected. Alarm is output when inverter stops (pre-trip) consecutively 10 times.   | Recovery at restart            | 1. Overload operation of refrigerant cycle<br>2. Layer short on the compressor<br>3. Check the outdoor unit control PCB.<br>4. Check the inverter compressor wiring. (Open phase/Reverse phase)<br>5. Compressor locked<br>6. Valve (or refrigerant circuit) blockage<br>7. Check the refrigerant cycle (gas leak). |
| H31                             | HIC trouble  | Pre-trip consecutively 10 times  | Temperature dropped            | Heat sink and PCB (HIC)<br>• Contact trouble  |

5

**U-71PE1E5A ~ U-140PE1E5A / U-71PE1E8A ~ U-140PE1E8A  
 U-100PEY1E5, U-125PEY1E5 / U-100PEY1E8 ~ U-140PEY1E8**

**Alarms for outdoor units**

| <b>Alarm Code</b> | <b>Alarm Meaning</b>  |
|-------------------|---|
| E01               | Remote Controller Reception Error   |
| E02               | Remote Controller Transmission Error  |
| E03               | Error in Indoor Unit Receiving Signal from Remote Controller (central)  |
| E04               | Error in Indoor Unit Receiving Signal from the Outdoor Unit   |
| E05               | Error in Indoor Unit Transmitting Signal to the Outdoor Unit  |
| E06               | Outdoor Unit Failed to Receive Serial Communication Signals from Indoor Unit  |
| E08               | Duplicate Indoor Unit Address Settings Error  |
| E09               | More Than One Remote Controller Set to Main Error   |
| E12               | Automatic Address Setting Start is Prohibited while Auto-address Setting in Progress.                                     |
| E14               | Main Unit duplication in Simultaneous-operation Multi Control (detected outdoor unit)                                     |
| E15               | Automatic Address Alarm (The total capacity of indoor units is too low.)  |
| E16               | Automatic Address Alarm (The total capacity of indoor units is too high or the total number of indoor units is too many.) |
| E18               | Faulty Communication in Group Control Wiring  |
| E20               | Connection Problem of Indoor/Outdoor Units.   |
|                   |   |
| F04               | Compressor Discharge Temperature Sensor (TD) Trouble  |
| F06               | Inlet Temperature Sensor (C1) in Heat Exchanger Trouble   |
| F07               | Intermediate Temperature Sensor (C2) in Heat Exchanger Trouble  |
| F08               | Outdoor Air Temperature Sensor (TO) Trouble   |
| F12               | Compressor Inlet Suction Temperature Sensor (TS) Trouble  |
| F31               | Outdoor Unit Nonvolatile Memory (EEPROM) Trouble  |
|                   |   |
| H01               | Primary (input) Overcurrent Detected  |
| H02               | PAM Trouble   |
| H03               | Primary Current CT Sensor (current sensor) Failure  |
| H31               | HIC Trouble   |
|                   |   |
| L04               | Outdoor Unit Address Duplication  |
| L10               | Outdoor Unit Capacity not Set or Invalid  |
| L13               | Indoor Unit Type Setting Error  |
| L18               | 4-way Valve Operation Failure   |
|                   |   |
| P03               | Compressor Discharge Temperature Trouble  |
| P04               | High Pressure Trouble   |
| P05               | AC Power Supply Trouble   |
| P13               | Alarm Valve Open  |
| P14               | O <sub>2</sub> Sensor Detect  |
| P15               | Insufficient Gas Level Detected   |
| P16               | Compressor Overcurrent Trouble  |
| P22               | Outdoor Unit Fan Motor Trouble  |
| P29               | Lack of INV compressor wiring, INV compressor actuation failure (including locked), DCCT failure                          |
| P31               | Group Control Error   |

## Symptoms and Parts to Inspect

| Remote controller alarm display | Alarm contents   | Judgement conditions   | Eliminating condition of alarm | Judgement and correction   |
|---------------------------------|--|--|--------------------------------|--|
| P03                             | Abnormal discharge temperature error<br>• Discharge temp. detected at or above the specified value                             | Stops when temp. exceeds 106 °C.<br>Alarm output on 5 pre-trips  | Recovery at restart            | 1. Check refrigerant cycle (gas leak).<br>2. Trouble with electronic expansion valve<br>3. Check discharge temperature sensor (TD).  |
| P05                             | CT disconnected or AC power supply error   | The current value transmitted from the microcomputer on the outdoor unit control substrate is low.<br>When no AC power input for more than 30 seconds to 5 minutes : Single alarm                              | Recovery at restart            | 1. Check outdoor unit control PCB.<br>2. Lack of reactor wire  |
| P15                             | Insufficient gas level detected.   | • Discharge temperature is 95 °C or higher.<br>• Electronic expansion valve is at Step 480.<br>When the above has continued for 1 minute. Indoor air sucking due to body thermostat max (E1 or E2) - TA ≤ 4 °C | Recovery at restart            | 1. Check refrigerant cycle (gas leak).<br>2. Trouble with electronic expansion valve<br>3. Check outdoor unit valve opening.   |
| L18                             | 4-way valve operation failure<br>• Judged after heating operating for 5 minutes consecutively.                                 | The indoor unit heat exchanger temperature drops even though the compressor is switched on during the heating mode:<br>To +20 °C ≤ C1<br>Pre-trip 1 time   | Recovery at restart            | 1. Check 4-way valve.<br>2. Check 4-way valve wiring.<br>3. Check outdoor unit control PCB.  |
| P04                             | High-pressure protection error   | High pressure switched ON → OFF<br>(Alarm is output when switch opened.) Pre-trip 4 times.   | Recovery at restart            | Overload operation of refrigerant cycle  |
| P22                             | Outdoor unit fan motor trouble<br>• Inverter protection circuit was activated, or lock was detected at outdoor unit fan motor. | Inverter stops after alarm is detected. Pre-trip 10 times  | Recovery at restart            | 1. Position detection trouble.<br>2. Outdoor unit fan motor over-current Protection circuit is activated.<br>• Check outdoor unit control PCB.<br>• Refer to outdoor unit fan judgement methods. |
| P29                             | Lack of INV compressor wiring, INV compressor actuation failure, DCCT failure  | Inverter stops after alarm is detected. Alarm is output when inverter stops (pre-trip) consecutively 10 times.   | Recovery at restart            | 1. Stops immediately even when operations restarted.<br>• Layer short on the compressor<br>2. Check HIC circuit.<br>• Wiring trouble   |
| H31                             | HIC trouble  | Pre-trip consecutively 10 times  | Temperature dropped            | Heat sink and PCB (HIC)<br>• Contact trouble   |

## Check Prior to Auto Address Setting

\* If an outdoor unit displays an alarm, conduct this process after diagnosing the problem.

|   |  |   |     |                        |
|---|--|---|-----|------------------------|
| 1 Auto Address                          | 1-1  | Is the power of the indoor unit(s) and outdoor unit(s) on?  | Yes | 2-1                    |
|   |  |   | No  | Power on               |
| 2 Indoor/<br>outdoor<br>control line    | 2-1  | Has the wiring of the indoor/outdoor control line been completed?<br>Is it all connected?   | Yes | 2-2                    |
|   |  |   | No  | Connect the wiring     |
|   | 2-2  | Has high voltage (over AC200V) been applied to the control line circuit? Has the fuse on the control PC board blown?<br>(Check each board of the indoor unit(s) and outdoor unit(s).) | Yes | 2-3                    |
|   |  |   | No  | 3-1                    |
| 2-3                                     | The power line and indoor/outdoor control line are miswired. Turn off the power, check & correct the miswiring and then make connections of the indoor/outdoor control lines to the emergency side of all the control PC boards and controllers. |   |     |                        |
| 3 Installation<br>or setting<br>related | 3-1  | Be sure that the indoor and outdoor units are connected with correct combination written in catalog.  | Yes | 3-2                    |
|   |  |   | No  | Correct the connection |
|   | 3-2  | Is the indoor/outdoor control line connected to more than one outdoor unit? (Network wired?)  | Yes | 3-3                    |
|   |  |   | No  | 3-6                    |
|   | 3-3  | Is the Terminal resistor select switch on the outdoor control PC board set to just one unit?  | Yes | 3-4                    |
|   |  |   | No  | Correct the setting    |
|   | 3-4  | Are other outdoor units using a duplicate setting?  | Yes | 3-5                    |
|   |  |   | No  | 3-6                    |
| 3-5                                     | When units are networked, first set the system address for each outdoor unit in the order 1-2-3 and then run auto address setting.   |   |     |                        |
| 3-6                                     | Run the auto address setting.  |   |     |                        |

## E01 Remote Controller Reception Error

(When indoor unit(s) are connected)

### 1. Error Detection Method

It is judged an error if no self-addressed communication is sent to the remote controller in a 3-minute period.

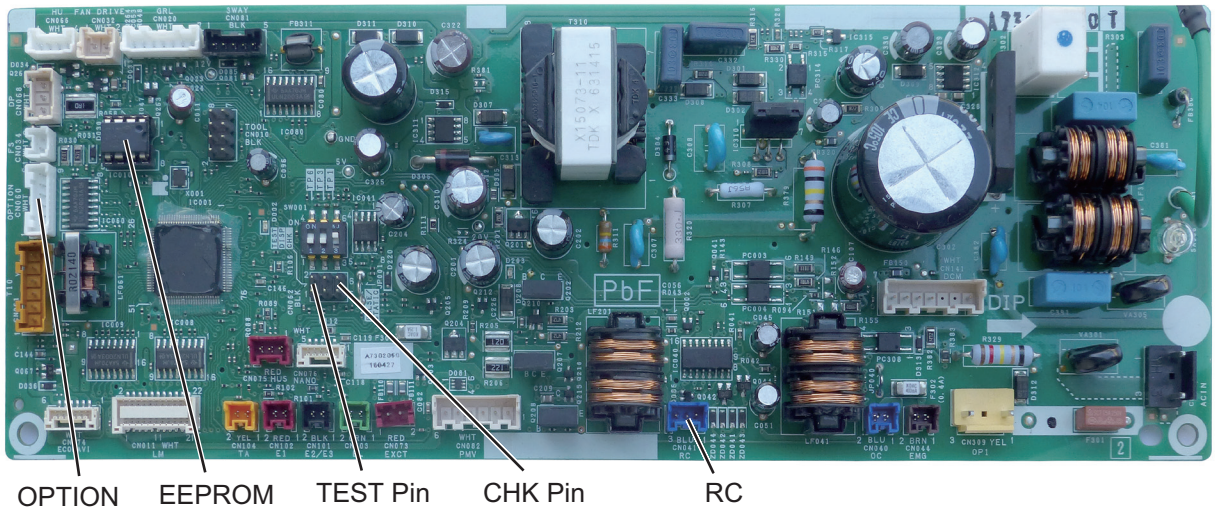
- When a remote controller is set to sub remote controller.
- When there are nine or more indoor units in a remote control group's wiring.
- When the CHK (check pin) and/or TEST (test pin) on the indoor unit control PC board are short circuited.
- The nonvolatile memory (EEPROM) is not installed or faulty when turning on the power.
- Indoor unit control PC board error
- Remote controller check mode
- Malfunctions of the remote controller itself (reception circuit error)

### 2. Error Diagnosis

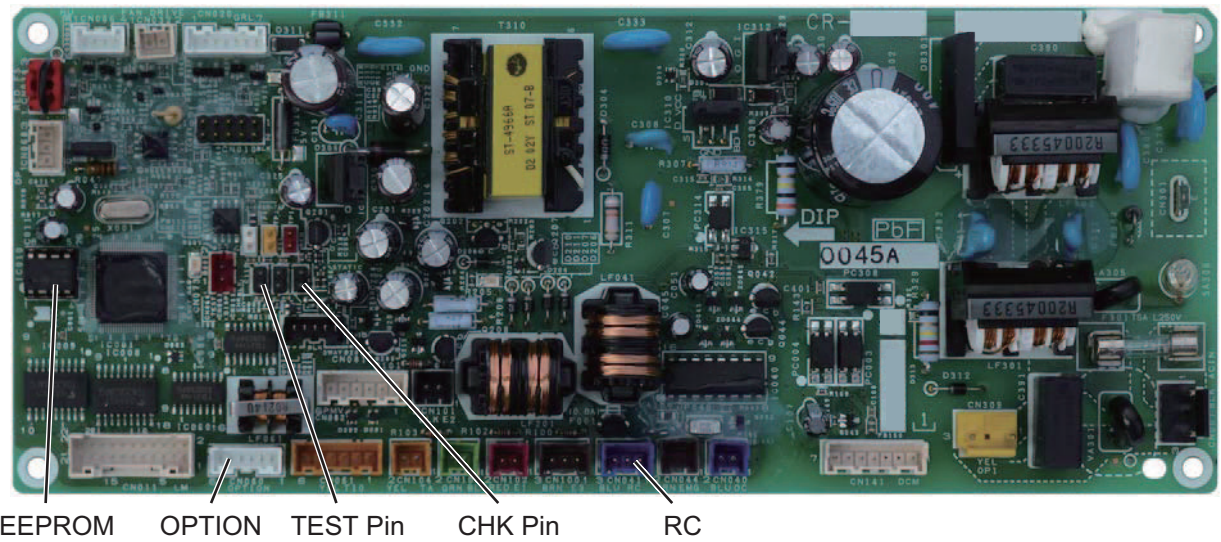
|                                   |   |  |  |                    |
|-----------------------------------|---|--|--|--------------------|
| 1 Auto Address                    | 1-1   | Is auto address setting complete?  | Yes                                      | 1-2                |
|                                   |   |  | No                                       | 1-3                |
|                                   | 1-2   | Is there an auto address setting error (Is the outdoor unit showing an alarm)?   | Yes                                      | 1-3                |
|                                   |   |  | No                                       | 2-1                |
| 1-3                               | Conduct checks prior to auto address setting.   |  |  |                    |
| 2 Group Control Wiring            | 2-1   | Is that indoor unit under group control?   | Yes                                      | 2-2                |
|                                   |   |  | No                                       | 3-1                |
|                                   | 2-2   | Are there any indoor units with their power off in the remote control group's wiring?  | Yes                                      | Power on           |
|                                   |   |  | No                                       | 2-3                |
|                                   | 2-3   | Are nine or more indoor units connected in one remote control group's wiring?  | Yes                                      | Correct the wiring |
|                                   |   |  | No                                       | 2-4                |
| 2-4                               | Was the remote control group's wiring changed after auto address setting was complete? Alternatively, were group settings changed in the remote control detailed settings mode?   | Yes  | 2-5                                      |                    |
|                                   |   | No   | 3-1                                      |                    |
| 2-5                               | No main unit in the remote control group's wiring? Re-execute auto address setting.   |  |  |                    |
| 3 Installation or setting related | 3-1   | Are the CHK pin and TEST pin on the indoor unit control board short-circuited?   | Yes                                      | Remove the short   |
|                                   |   |  | No                                       | 3-2                |
|                                   | 3-2   | Is the wireless remote controller connected to on the indoor unit's control PC board?  | Yes                                      | 3-3                |
|                                   |   |  | No                                       | 3-5                |
|                                   | 3-3   | Disconnect the connector mentioned above on the PC board of the indoor unit control PC board, and see whether the E01 goes off after several minutes. (When doing so, if two remote controllers are being used and the wireless remote controller is the main remote controller, set the other remote controller as the main.) | Yes                                      | 3-4                |
|                                   |   |  | No                                       | 3-5                |
|                                   | 3-4   | Replace wireless remote control parts including wiring.  |  |                    |
|                                   | 3-5   | Is the LED blinking on the indoor unit's control PC board?   | Yes                                      | 3-6                |
| No                                |   |  | 3-7                                      |                    |
| 3-6                               | The nonvolatile memory (EEPROM) on the indoor unit's control PC board is either not installed, improperly installed or the nonvolatile memory is faulty. Correct this or after replacing the nonvolatile memory, write model data to it in the remote control detailed settings mode. |  |  |                    |
| 3-7                               | Is there a short, miswiring, disconnection, wrong contact or grounding in the remote control's wiring?  | Yes  | Correct the wiring                       |                    |
|                                   |   | No   | Replace the indoor unit's control board. |                    |

- Regarding the remote controller check, refer to the Reference Materials.
- For information on the procedures for replacing the nonvolatile memory (EEPROM) of the indoor unit and/or replacing the indoor unit's control board, refer to the manual that is packaged with the indoor unit service board.

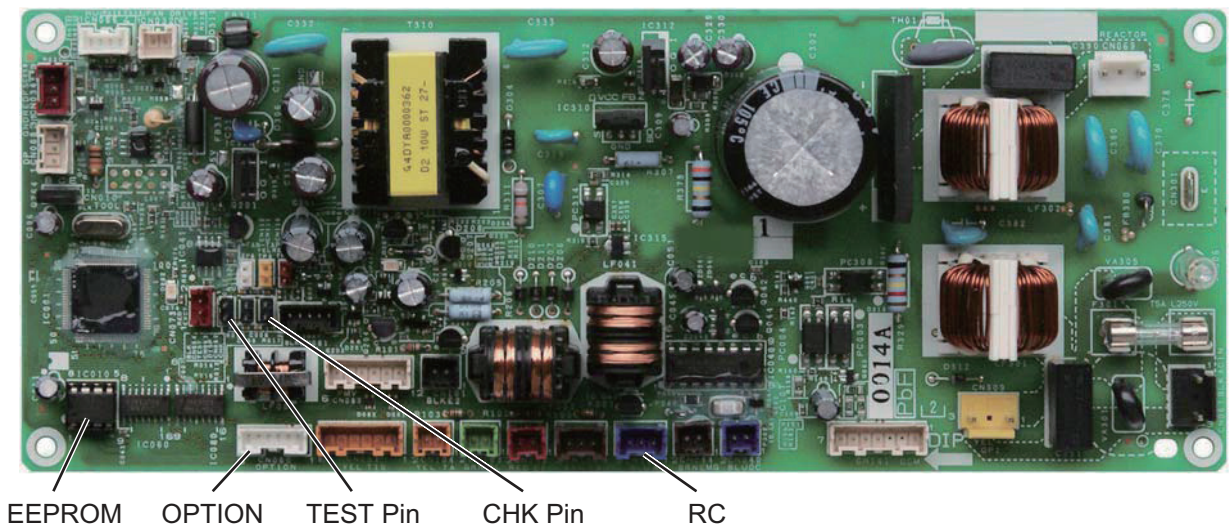
**A7302060** : 4-Way Cassette Type (Type U2) Indoor Unit Control Board



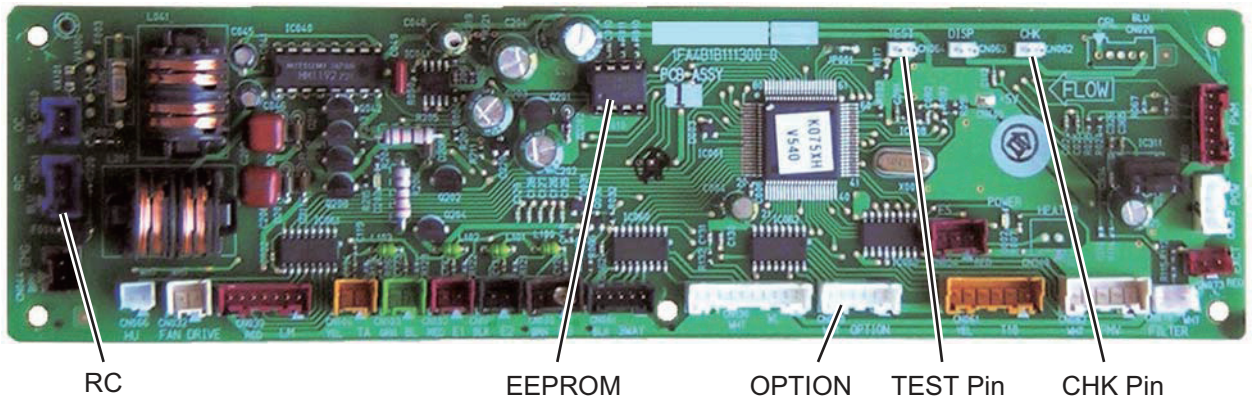
**A747931** : Ceiling Type (Type T2) Indoor Unit Control Board



**A747938** : Duct Type Indoor Unit Control Board



**A747336 : 4-Way Cassette 60 x 60 Type Indoor Unit Control Board**





## E02 Remote Controller Transmission Error

### 1. Error Detection Method

When the remote controller itself cannot transmit. Or when it cannot receive the signal it transmitted itself, or when they are different and judged an error.

- Malfunction of the remote controller itself (transmit circuit error)

### 2. Error Diagnosis

|                               |   |   |  |                    |
|-------------------------------|---|---|--|--------------------|
| 1 Remote Control Group Wiring | 1-1   | Is the indoor unit under group control?   | Yes  | 1-2                |
|                               |   |   | No   | 2-1                |
|                               | 1-2   | Are the wires 1 (white) & 2 (black) to the remote control group shorted or opened?  | Yes  | Correct the wiring |
|                               |   |   | No   | 2-1                |
| 2 Group Control Wiring        | 2-1   | Is the wireless remote controller connected to on the indoor unit's control PC board?   | Yes  | 2-2                |
|                               |   |   | No   | 2-4                |
|                               | 2-2   | Disconnect the connector mentioned above on the board of the indoor unit control PC board, and see whether the E02 goes off after several minutes. (When doing so, if two remote controllers are being used and the wireless remote controller is the main remote controller, set the other remote controller as the main.) | Yes  | 2-3                |
|                               |   |   | No   | 2-4                |
|                               | 2-3   | Replace wireless remote control parts including wiring.   |  |                    |
| 2-4                           | Is there a short, miswiring, open, wrong contact or grounding in the remote control's wiring? | Yes   | Correct the wiring                         |                    |
|                               |   | No  | Replace the indoor unit's control PC board |                    |

- Regarding the remote controller check, refer to the Reference Materials.
- For information on the procedures for replacing the nonvolatile memory (EEPROM) of the indoor unit and/or replacing the indoor unit's control board, refer to the manual that is packaged with the indoor unit service board.

## E03 Error in Indoor Unit Receiving Signal from Remote Controller (central)

(When indoor unit(s) are connected)

### 1. Error Detection Method

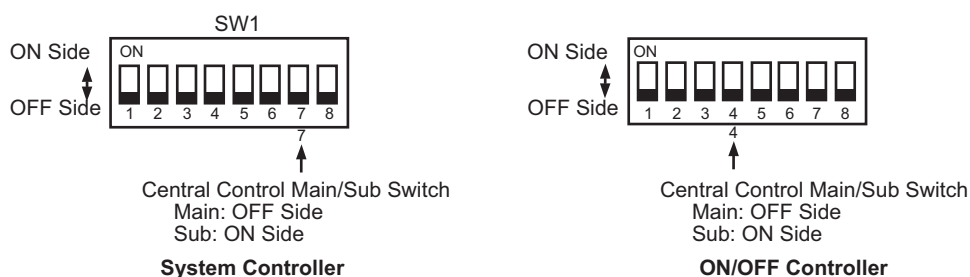
It is judged an error when there is no communication from any remote controller (collectively) in a 3-minute period or if there is no communication from the central device in a 15-minute period.

- When there was once communication, but during use the remote control wiring is opened or miswired.
- The line to the central control unit for indoor/outdoor operations is opened.
- Settings are made only for sub remote controller.
- The power to the central control unit is not on and remote controllers are not being used (or the indoor/outdoor operations line to the central control unit is opened).
- When remote controller are not being used, only the sub remote controller is set up.

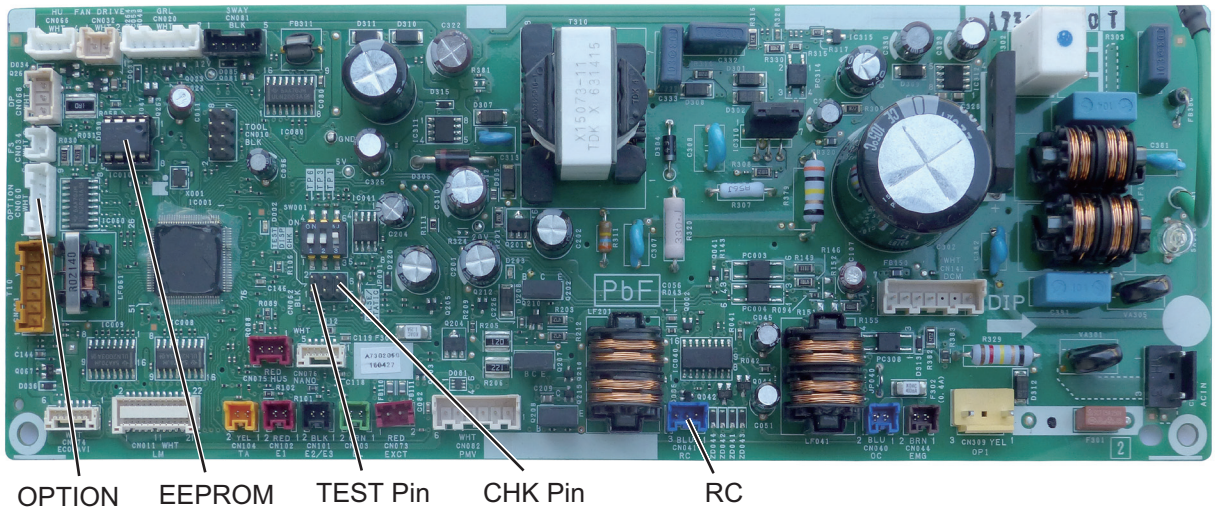
### 2. Error Diagnosis

|                                |  |  |                                       |          |
|--------------------------------|--|--|---------------------------------------|----------|
| 1 Central control unit         | 1-1  | Is the central control unit connected?   | Yes                                   | 1-2      |
|                                |  |  | No                                    | 2-1      |
|                                | 1-2  | Is the central control unit's powered off?   | Yes                                   | Power on |
|                                |  |  | No                                    | 1-3      |
|                                | 1-3  | Are all the Main/Sub switches on the connected central control unit set to Sub?  | Yes                                   | 1-4      |
| No                             |  |  | 1-5                                   |          |
| 1-4                            | Of the central control units that are connected, set only the uppermost central control unit to Main and the others to Sub. The order from top to bottom is communication adaptor → system controller → ON/OFF controller. |  |                                       |          |
| 1-5                            | Is the indoor/outdoor operations line connected to the central control unit opened?  | Yes  | Correct the setting                   |          |
|                                |  | No   | 2-1                                   |          |
| 2 Remote controller            | 2-1  | Is the indoor unit under group control?  | Yes                                   | 2-2      |
|                                |  |  | No                                    | 3-1      |
| 2-2                            | Are the wires 1 (white) & 2 (black) to the remote control group opened, have wrong contact or grounded?  | Yes  | Correct the setting                   |          |
|                                |  | No   | 3-1                                   |          |
| 3 Indoor unit control PC board | 3-1  | Is the wireless remote controller connected to on the indoor unit's control PC board?  | Yes                                   | 3-2      |
|                                |  |  | No                                    | 3-4      |
|                                | 3-2  | Disconnect the connector mentioned above on the control PC board of the indoor unit control PC board, and see whether the E03 goes off after several minutes. (When doing so, if two remote controllers are being used and the wireless remote controller is the main remote controller, set the other remote controller as the main.) | Yes                                   | 3-3      |
|                                |  |  | No                                    | 3-4      |
| 3-3                            | Replace wireless remote control parts including wiring.  |  |                                       |          |
| 3-4                            | Is there a short, miswiring, open, wrong contact or grounding in the remote control's wiring?  | Yes  | Correct the wiring                    |          |
|                                |  | No   | Replace the indoor unit control board |          |

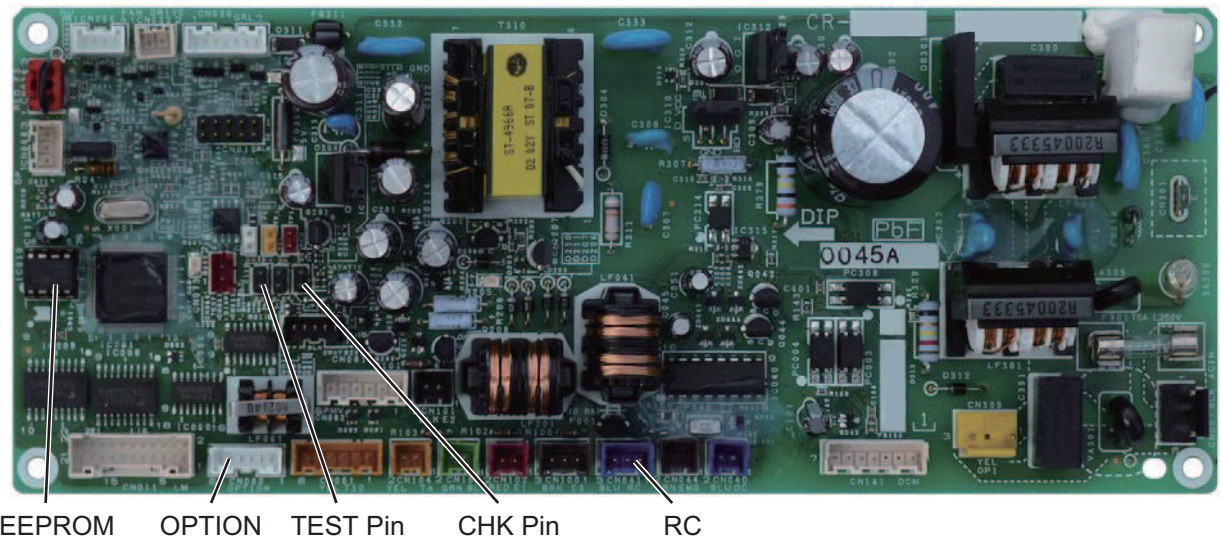
- Regarding the remote controller check, refer to the Reference Materials.
- For information on the procedures for replacing the nonvolatile memory (EEPROM) of the indoor unit and/or replacing the indoor unit's control board, refer to the manual that is packaged with the indoor unit service board.



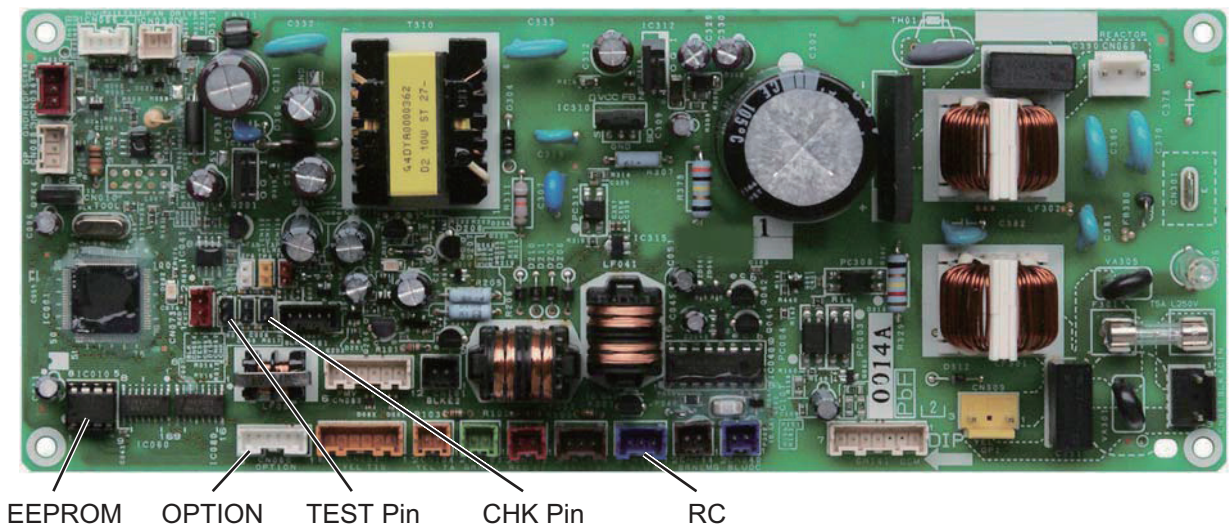
**A7302060** : 4-Way Cassette Type (Type U2) Indoor Unit Control Board



**A747931** : Ceiling Type (Type T2) Indoor Unit Control Board



**A747938** : Duct Type Indoor Unit Control Board





## E04 Error in Indoor Unit Receiving Signal from the Outdoor unit

### 1. Error Detection Method

When there is no communication within a 3-minute period from the outdoor unit. Or, judged an error when no reply comes from the outdoor unit.

- The outdoor unit is not turned on.
- When the network of indoor/outdoor operation line was wired, the (SHORT) setting of the terminal resistor switch on the outdoor control PC board was set on multiple units (four or more).
- When the power was turned on after auto address setting was completed, the number of indoor units had been changed.
- Forgot to turn on the indoor unit.
- The CHK pin and/or TEST pin on the indoor unit's control PC board are shorted.
- Forgot to install the nonvolatile memory (EEPROM) when replacing the indoor unit control PC board.
- Mistakenly set the indoor unit address to Not Set in the remote control's detailed settings mode.
- When indoor unit addresses are duplicated.
- There is a short, open, wrong contact or grounding of the indoor/outdoor operation line.
- There is an error in the receiving circuit on the signal output PC board (optional control PC board).
- Malfunctions of the outdoor unit
- High voltage was applied (over AC200V) in the indoor/outdoor operations line circuit.
- The thermistor inside the indoor unit is grounded.

### 2. Error Diagnosis

|                                |   |  |  |  |
|--------------------------------|---|--|--|--|
| 1 Power Source                 | 1-1   | Is/was the power to the outdoor unit cut off?  | Yes                                    | After turning the power on, wait three minutes |
|                                |   |  | No                                     | 1-2  |
|                                | 1-2   | Is the indoor unit powered off?  | Yes                                    | Power on                                       |
|                                |   |  | No                                     | 2-1  |
| 2 Indoor/outdoor control line  | 2-1   | Is the indoor/outdoor operation line shorted, opened, grounded or has a wrong contact?   | Yes                                    | Correct the wiring                             |
|                                |   |  | No                                     | 2-2  |
|                                | 2-2   | When the network of indoor/outdoor operation line was wired, was the (SHORT) setting of the terminal resistor switch on the outdoor control PC board set on multiple units (four or more)?   | Yes                                    | Normally the (SHORT) setting is just one unit. |
|                                |   |  | No                                     | 2-3  |
| 2-3                            | Was a high voltage (over AC200V) applied in the indoor/outdoor operations line circuit?   | Yes  | 3-2                                    |  |
|                                |   | No   | 3-1                                    |  |
| 3 No. of Indoor Units          | 3-1   | Was the number of indoor units increased or decreased after auto address setting was complete?   | Yes                                    | 3-2  |
|                                |   |  | No                                     | 3-3  |
|                                | 3-2   | Conduct checks prior to auto address setting.  |  |  |
| 3-3                            | Check the indoor unit addresses from the remote control's detailed settings mode. Is it Not Set (99), or is the indoor unit's address duplicated?   | Yes  | 3-2                                    |  |
|                                |   | No   | 4-1                                    |  |
| 4 Indoor unit control PC board | 4-1   | Are the CHK pin and/or TEST pin on the indoor unit control PC board short-circuited?   | Yes                                    | Remove the short                               |
|                                |   |  | No                                     | 4-2  |
|                                | 4-2   | Is the wireless remote controller connected to on the indoor unit's control PC board?  | Yes                                    | 4-3  |
|                                |   |  | No                                     | 4-5  |
|                                | 4-3   | Disconnect the connector mentioned above on the control PC board of the indoor unit control PC board, and see whether the E04 goes off after several minutes. (When doing so, if two remote controllers are being used and the wireless remote controller is the main remote controller, set the other remote controller as the main.) | Yes                                    | 4-4  |
|                                |   |  | No                                     | 4-5  |
|                                | 4-4   | Replace wireless remote control parts including wiring.  |  |  |
| 4-5                            | Is the LED on the indoor unit control PC board blinking?  | Yes  | 4-6                                    |  |
|                                |   | No   | 4-7                                    |  |
| 4-6                            | The nonvolatile memory (EEPROM) on the indoor unit's control PC board is either not installed, improperly installed or the nonvolatile memory is faulty. Correct this or after replacing the nonvolatile memory, write model data to it in the remote control detailed settings mode. |  |  |  |
| 4-7                            | Are all the remote controllers of the other indoor units connected to that outdoor unit displaying E04?   | Yes  | Replace the outdoor unit control board |  |
|                                |   | No   | Replace the indoor unit control board  |  |

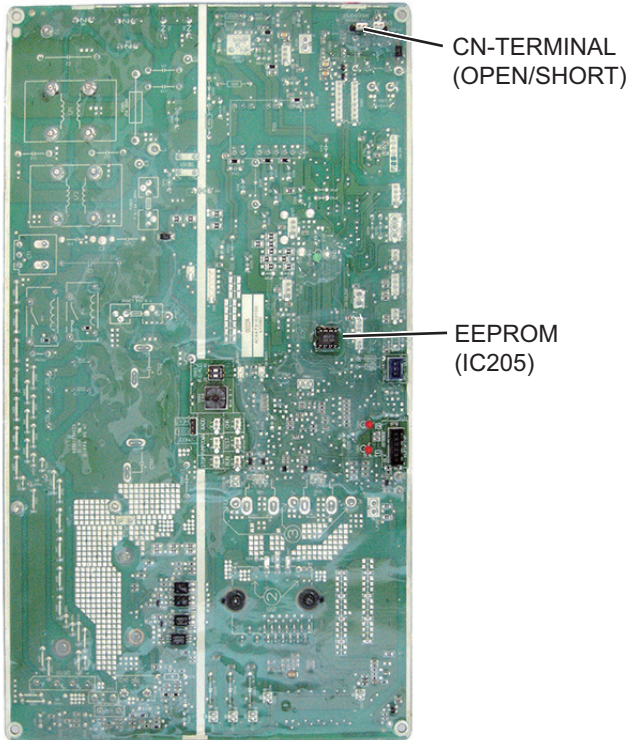
- Regarding the remote controller check, refer to the Reference Materials.
- For information on the procedures for replacing the nonvolatile memory (EEPROM) of the indoor unit and/or replacing the indoor unit's control board, refer to the manual that is packaged with the indoor unit service board.

■ Outdoor Unit Control PCB

ACXA73-03100 : Up side

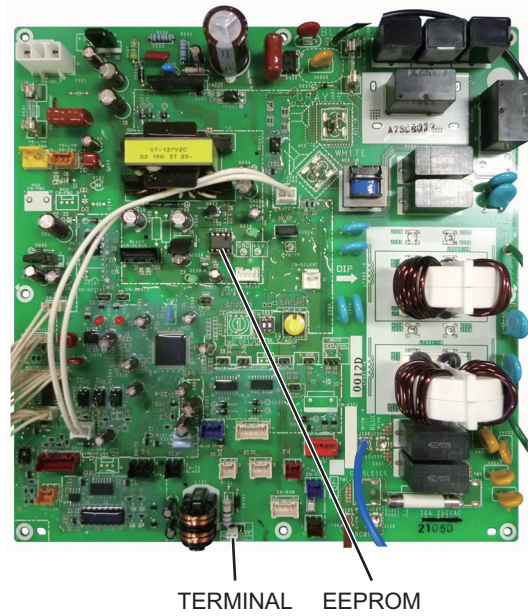
(U-36PE2E5A, U-50PE2E5A, U-60PE2E5A)  
(U-60PEY2E5, U-71PEY2E5)

(for single-phase outdoor unit PCB)



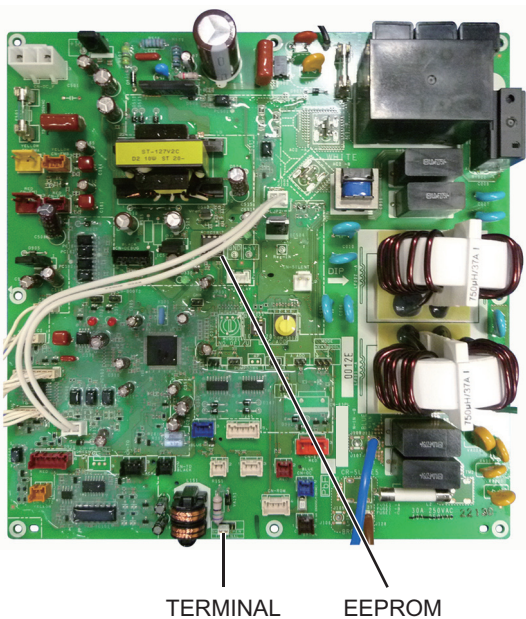
A747898 : (U-71PE1E5A)

(for single-phase outdoor unit PCB)



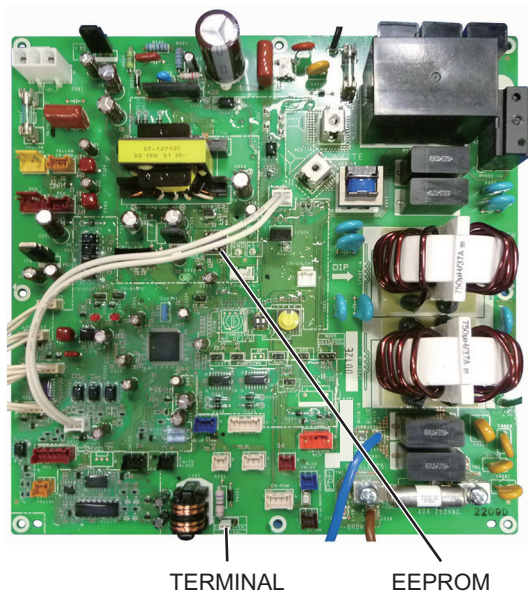
A747895 : (U-100PE1E5A)

(for single-phase outdoor unit PCB)

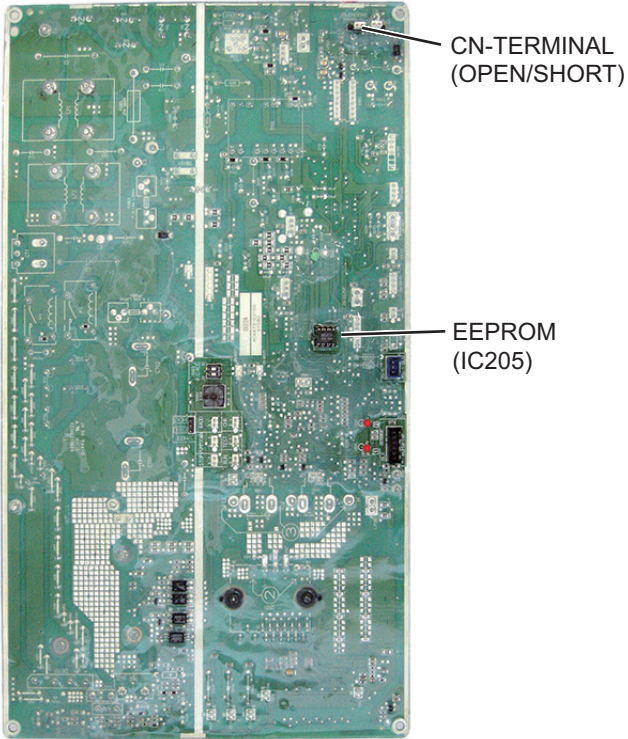


A747896 : (U-125PE1E5A, U-140PE1E5A)

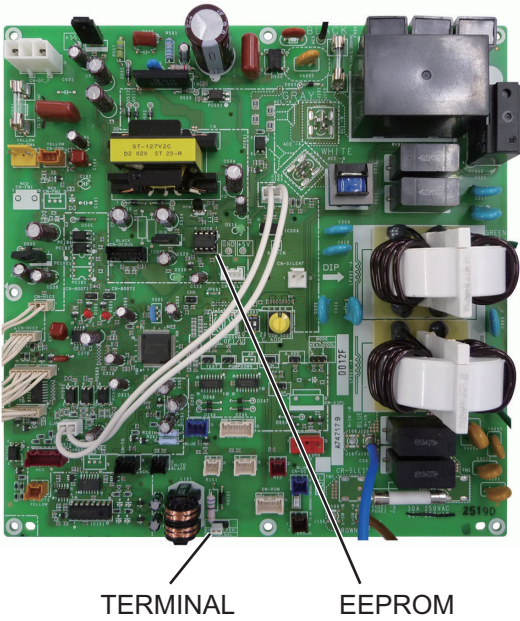
(for single-phase outdoor unit PCB)



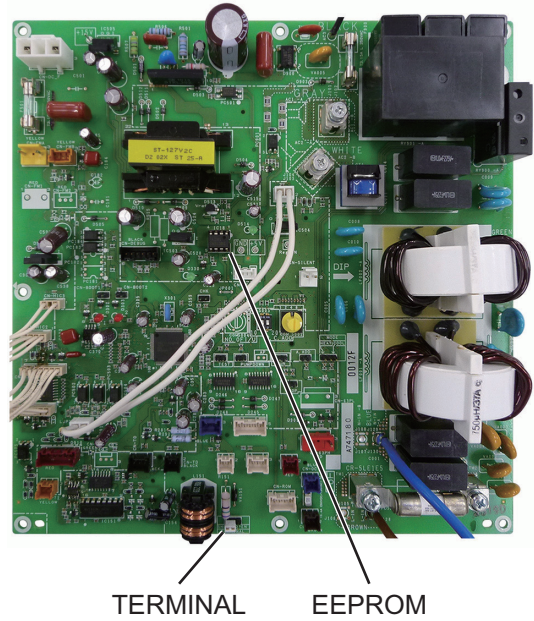
**ACXA73-03100 : Up side**  
**(U-36PE2E5A, U-50PE2E5A, U-60PE2E5A)**  
**(U-60PEY2E5, U-71PEY2E5)**  
**(for single-phase outdoor unit PCB)**



**A747179 : (U-100PEY1E5)**  
**(for single-phase outdoor unit PCB)**

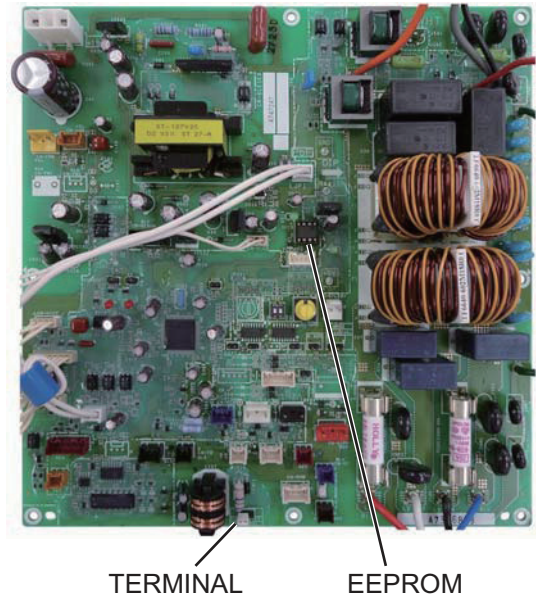
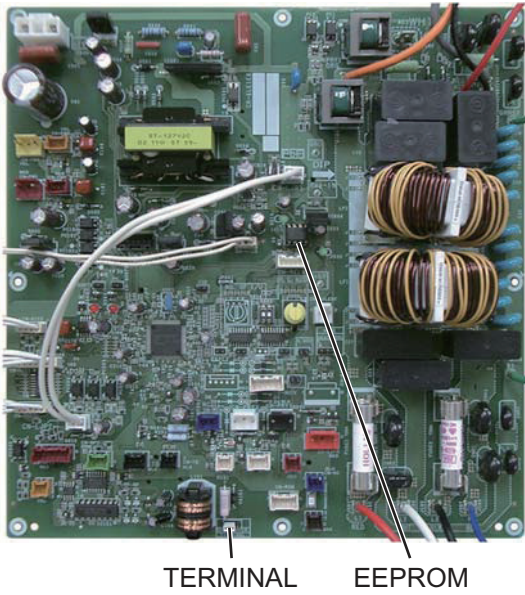


**A747180 : (U-125PEY1E5)**  
**(for single-phase outdoor unit PCB)**



A747899 : (U-71PE1E8A)  
 A747897 : (U-100PE1E8A, U-125PE1E8A, U-140PE1E8A)  
 A747596 : (U-140PEY1E8)  
 (for 3-phase outdoor unit PCB)

A747247 : (U-100PEY1E8, U-125PEY1E8)  
 (for 3-phase outdoor unit PCB)

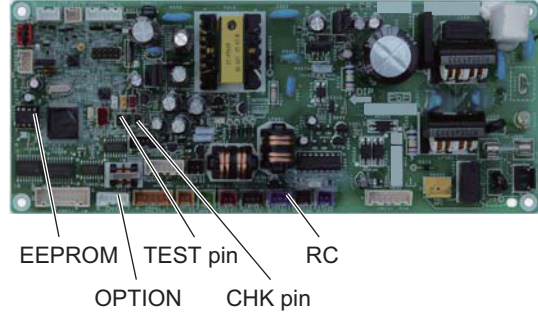
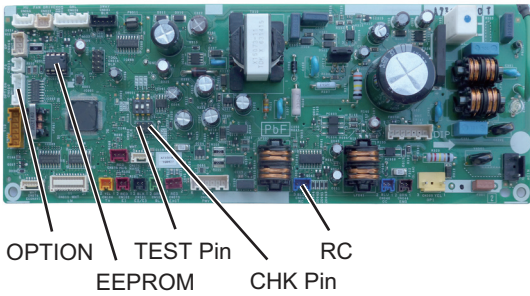


5

Indoor Unit Control PCB

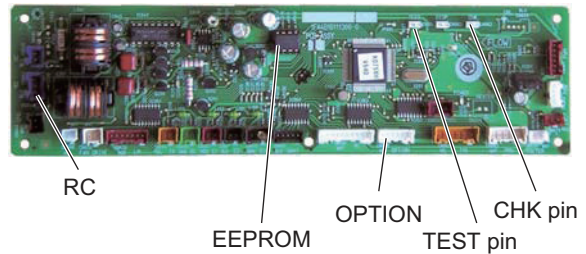
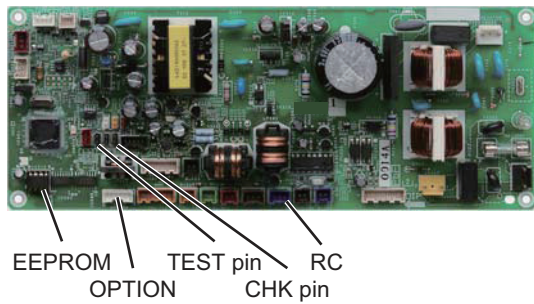
A7302060 : 4-Way Cassette Type (Type U2)

A747931 : Ceiling Type (Type T2)



A747938 : Duct Type

A747336 : 4-Way Cassette 60 x 60 Type





## E05 Error in Indoor Unit Transmitting Signal to the Outdoor Unit

### 1. Error Detection Method

It is judged an error when a unit itself cannot receive a signal that it has sent.

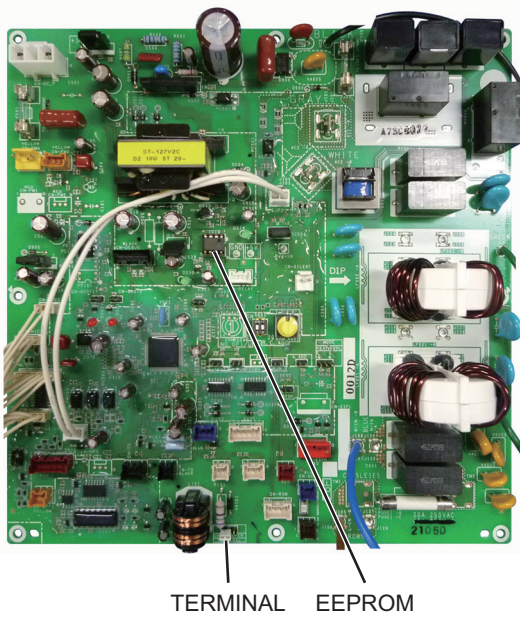
- Indoor unit control PC board error
- The setting of the terminal resistor select switch on the outdoor unit main PC board is set incorrectly.

### 2. Error Diagnosis

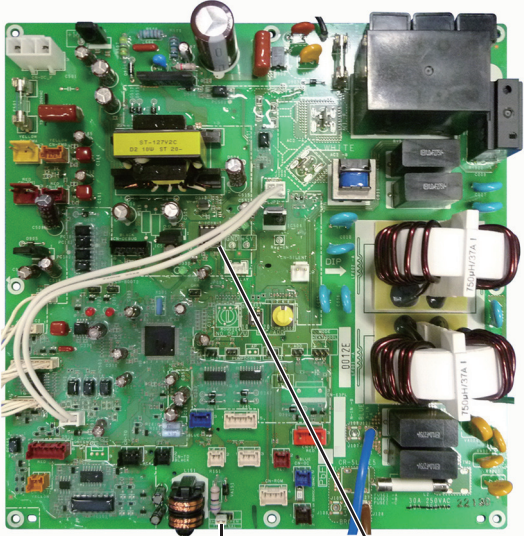
|                                |   |  |                    |                                |
|--------------------------------|---|--|--------------------|--------------------------------|
| 1 Indoor unit control PC board | 1-1   | Is the indoor/outdoor operation line connected to more than one outdoor unit? (Network wired?)                             | Yes                | 1-2                            |
|                                |   |  | No                 | 1-3                            |
|                                | 1-2   | Is the SHORT on the terminal resistor select switch on the outdoor main PC board set to one unit, and the others are OPEN? | Yes                | 1-4                            |
|                                |   |  | No                 | Set the SHORT to one unit only |
|                                | 1-3   | Is the terminal resistor select switch on the outdoor main PC board set to OPEN?   | Yes                | Make the SHORT setting         |
| No                             |   |  | 1-4                |                                |
| 1-4                            | Is the indoor/outdoor operation line opened or shorted? | Yes  | Correct the wiring |                                |
|                                |   | No   | 1-5                |                                |
|                                | 1-5   | Replace the indoor unit control PC board.  |                    |                                |

- For information on the procedures for replacing the indoor unit's control PC board, refer to the manual that is packaged with the indoor unit service board.

### A747898 : (U-71PE1E5A) (for single-phase outdoor unit PCB)

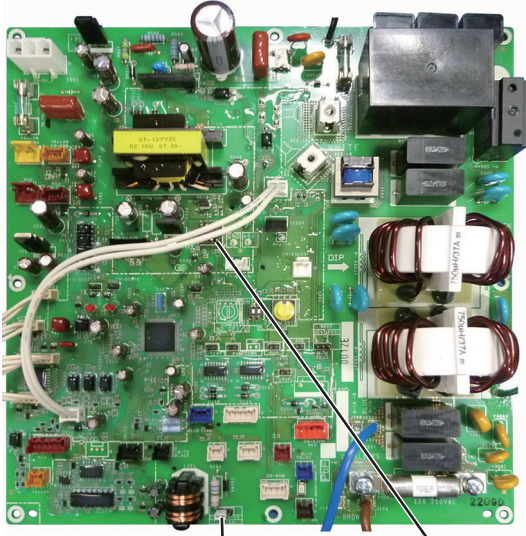


**A747895 : (U-100PE1E5A)**  
**(for single-phase outdoor unit PCB)**



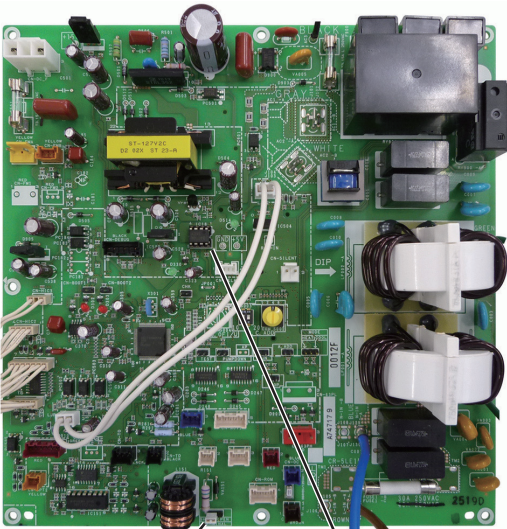
TERMINAL      EEPROM

**A747896 : (U-125PE1E5A, U-140PE1E5A)**  
**(for single-phase outdoor unit PCB)**



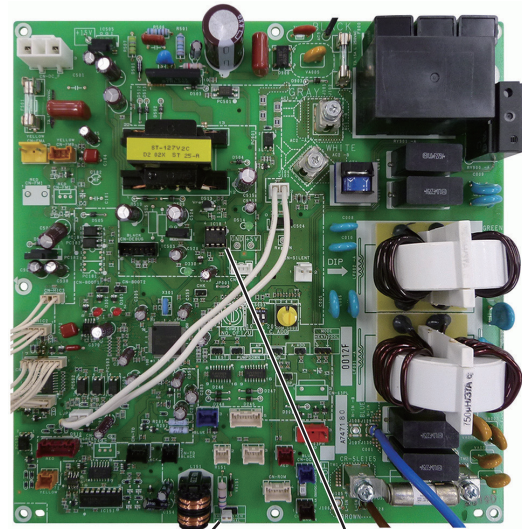
TERMINAL      EEPROM

**A747179 : (U-100PEY1E5)**  
**(for single-phase outdoor unit PCB)**



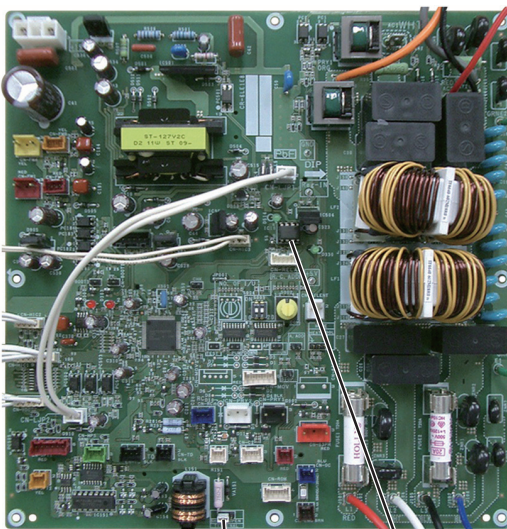
TERMINAL      EEPROM

**A747180 : (U-125PEY1E5)**  
**(for single-phase outdoor unit PCB)**



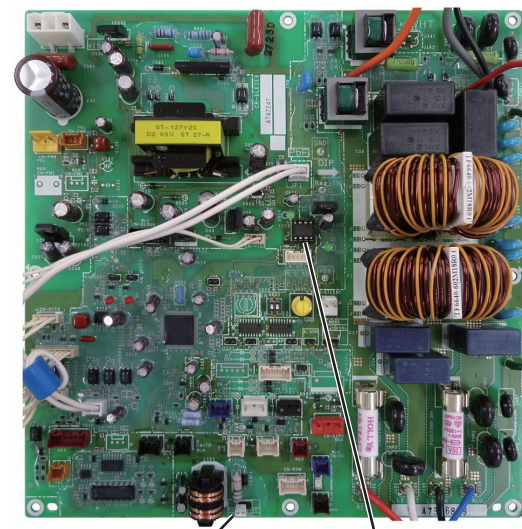
TERMINAL      EEPROM

**A747899 : (U-71PE1E8A)**  
**A747897 : (U-100PE1E8A, U-125PE1E8A,**  
**U-140PE1E8A)**  
**A747596 : (U-140PEY1E8)**  
**(for 3-phase outdoor unit PCB)**



TERMINAL      EEPROM

**A747247 : (U-100PEY1E8, U-125PEY1E8)**  
**(for 3-phase outdoor unit PCB)**



TERMINAL      EEPROM

## E06 Outdoor Unit Failed to Receive Serial Communication Signals from Indoor Unit

(When indoor unit(s) are connected)

### 1. Error Detection Method

It is judged an error when there is no transmission (reply) from the indoor unit to the outdoor unit for a period of three minutes.

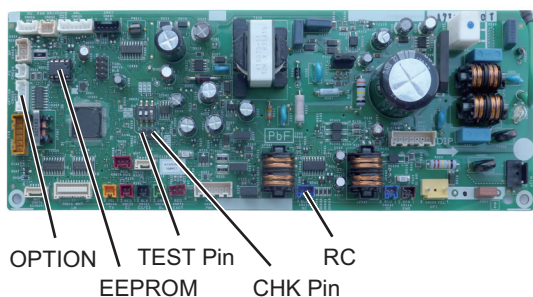
- The indoor unit is not turned on.
- The DISP pin of the indoor unit is shorted.
- There is a short, open, wrong contact or grounding of the indoor/outdoor operation line.
- The signal output control PC board (optional control PC board) inside the indoor unit has failed.
- The thermistor inside the indoor unit is grounded.

### 2. Error Diagnosis

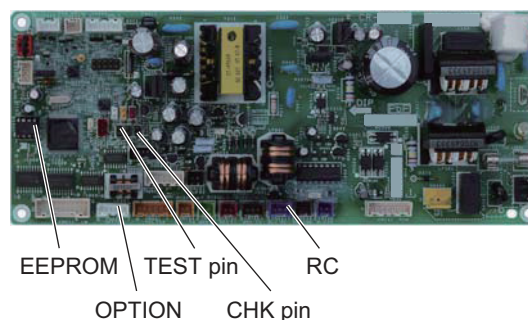
|                                 |   |  |     |                    |
|---------------------------------|---|--|-----|--------------------|
| 1 Indoor unit power             | 1-1   | Is the indoor unit powered off?  | Yes | Power on           |
|                                 |   |  | No  | 2-1                |
| 2 Indoor/outdoor operation line | 2-1   | Is the indoor/outdoor operation line shorted, opened, grounded or has a wrong contact?   | Yes | Correct the wiring |
|                                 |   |  | No  | 3-1                |
| 3 Indoor units control PC board | 3-1   | Are the DISP pin and CHK pin on the indoor unit control PC board short-circuited?  | Yes | Remove the short   |
|                                 |   |  | No  | 3-2                |
|                                 | 3-2   | Is the wireless remote controller connected to on the indoor unit's control PC board?  | Yes | 3-3                |
|                                 |   |  | No  | 3-5                |
|                                 | 3-3   | Disconnect the connector mentioned above on the control PC board of the indoor unit control PC board, and see whether the E06 goes off after several minutes. (When doing so, if two remote controllers are being used and the wireless remote controller is the main remote controller, set the other remote controller as the main.) | Yes | 3-4                |
|                                 |   |  | No  | 3-5                |
| 3-4                             | Replace wireless remote control parts including wiring. |  |     |                    |
| 3-5                             | Indoor unit control PC board failure → Replace board.   |  |     |                    |

- For information on the procedures for replacing the indoor unit's control board, refer to the manual that is packaged with the indoor unit control PCB.

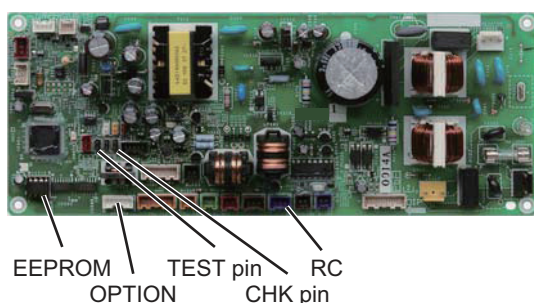
**A7302060 : 4-Way Cassette Type (Type U2)**



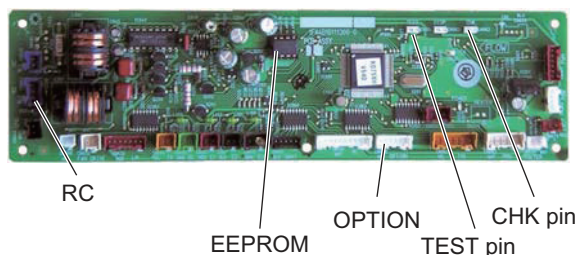
**A747931 : Ceiling Type (Type T2)**



**A747938 : Duct Type**



**A747336 : 4-Way Cassette 60 x 60 Type**



## E08 Duplicate Indoor Unit Address Settings Error

### 1. Error Detection Method

It is judged an error if the addresses of indoor units are duplicated.

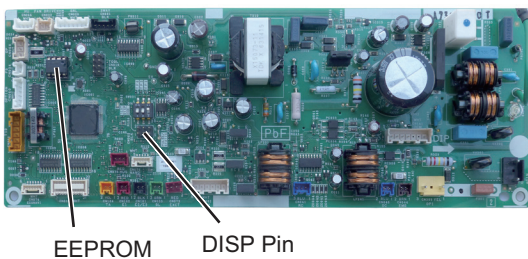
- The indoor unit address settings are duplicated in the remote control detailed settings mode.
- The multiple unit DISP pin is shorted across the indoor unit whose address is Not Set.

### 2. Error Diagnosis

|                                |     |   |     |                  |
|--------------------------------|-----|---|-----|------------------|
| 1 Indoor unit control PC board | 1-1 | Is the DISP pin on the indoor unit control PC board shorted?  | Yes | Remove the short |
|                                |     |   | No  | 1-2              |
|                                | 1-2 | Conduct checks prior to auto address setting.<br>Does E08 fail to go off even after running auto address setting again?                                   | Yes | 1-3              |
|                                |     |   | No  | 1-4              |
|                                | 1-3 | The nonvolatile memory (EEPROM) on the indoor unit board has failed.<br>↓<br>Replace the EEPROM.  |     |                  |
|                                | 1-4 | Do not make changes to indoor unit addresses with the detailed settings of the remote controller.<br>Make them in the remote control address change mode. |     |                  |

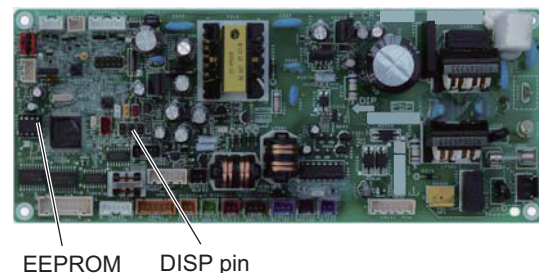
- For information on the procedures for replacing the nonvolatile memory (EEPROM) of the indoor unit, refer to the manual that is packaged with the indoor unit service board.

**A7302060 : 4-Way Cassette Type (Type U2)**



EEPROM      DISP Pin

**A747931 : Ceiling Type (Type T2)**



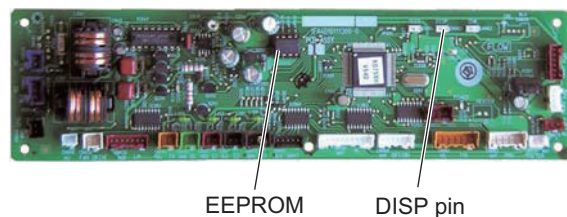
EEPROM      DISP pin

**A747938 : Duct Type**



EEPROM      DISP pin

**A747336 : 4-Way Cassette 60 x 60 Type**



EEPROM      DISP pin

## E09 More Than One Remote Controller Set to Main Error

### 1. Error Detection Method

It is judged an error when more than one remote controller in a remote control group is set as the main remote controller.

- Forgot to set one remote controller to sub in a 2-remote control group.
- When using one wireless and one wired remote controller in a control group, forgot to set one of them to sub.

### 2. Error Diagnosis

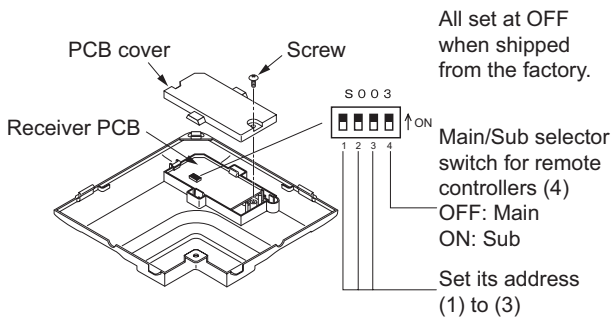
|                     |     |   |
|---------------------|-----|---|
| 1 Remote controller | 1-1 | Set one of the 2 remote controllers to sub. |
|---------------------|-----|---|

- Method for setting a remote controller to sub (CZ-RTC2)

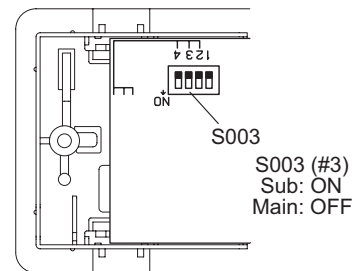
1. Press and hold both + buttons for 4 seconds or longer.
2. This will display **SETTING**, the item "01" and the setting data "0001" or the like on the remote controller's display.
3. Press Timer / buttons to switch the setting data to "0000". (0000:SUB 0001:Main)
4. Press button (Once the display changes from flashing to steady, the setting is complete).
5. Once you press button, the remote controller returns to its normal display.

Wireless remote controller

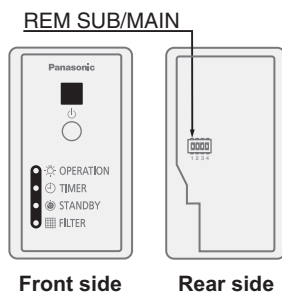
#### CZ-RWSU3



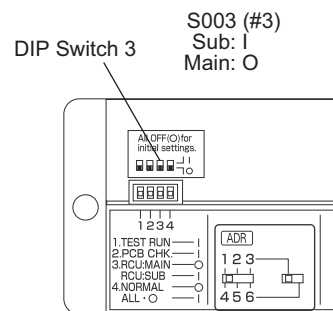
#### CZ-RWST2 • CZ-RWST3



#### CZ-RWSC3



#### CZ-RWSL2



## **E12 Automatic Address Setting Start is Prohibited while Auto-address Setting in Progress.**

### **1. Error Detection Method**

It is judged an error if a command to start auto address setting comes from another controller during auto address setting.

- This occurs in a system that has more than one outdoor unit and operating lines among the indoor/outdoor units (networked wiring), when an instruction to start auto address setting is given from another controller during the auto address setting process.

### **2. Error Diagnosis**

|                |     |   |
|----------------|-----|---|
| 1 Auto Address | 1-1 | When one controller in a networked system is running auto address setting, it is not possible to start auto address setting from another controller.<br>Wait until the auto address setting in progress finishes. |
|----------------|-----|---|

## E14 Main Unit duplication in Simultaneous-operation Multi Control (detected outdoor unit)

### 1. Error Detection Method

It is judged an error that the main units are duplicated in the indoor unit group.

- Main unit setting was made in the indoor unit group control setting of the remote control detailed settings mode.

### 2. Failure Diagnosis

|                          |     |  |     |     |
|--------------------------|-----|--|-----|-----|
| 1 Group Control Address  | 1-1 | Are multiple indoor units set up as the main unit?                                   | Yes | 2-1 |
|                          |     |  | No  | 2-2 |
| 2 Installation & Setting | 2-1 | Set up only one indoor unit as the main unit and other indoor units to the sub-unit. |     |     |
|                          | 2-2 | Carry out the auto address setting.  |     |     |



## E15 Automatic Address Alarm (The total capacity of indoor units is too low.)

### 1. Error Detection Method

Connecting indoor unit

It is judged an error the total capacity of indoor units replied by communication is lower than that of outdoor unit.

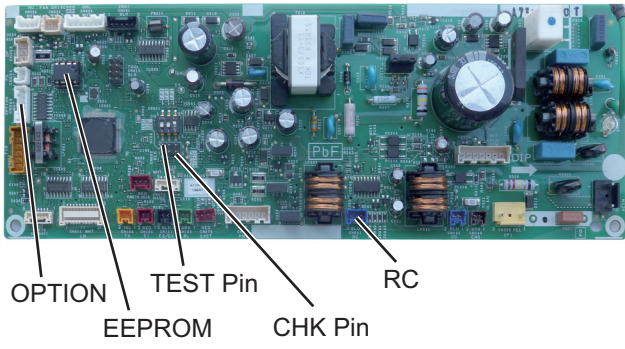
- The total capacity of indoor units is lower than that of outdoor unit.
- Some indoor unit(s) are connected but power is not turned on.
- The CHK pin (CN062/CN071) and/or TEST pin (CN064) of the indoor unit is shorted when its power is turned on.
- High voltage was applied (over AC200V) in the indoor/outdoor operations line circuit.

### 2. Error Diagnosis

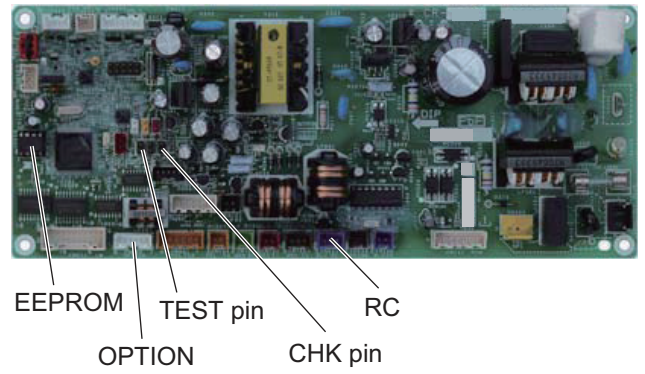
|                                 |  |   |     |                    |
|---------------------------------|--|---|-----|--------------------|
| 1 Power Source                  | 1-1  | Is the indoor unit powered off?   | Yes | Power on           |
|                                 |  |   | No  | 2-1                |
| 2 Indoor/outdoor control line   | 2-1  | Is the indoor/outdoor control line opened or shorted?   | Yes | Correct the wiring |
|                                 |  |   | No  | 2-2                |
|                                 | 2-2  | Was a high voltage (over AC200V) applied in the indoor/outdoor operations line circuit?   | Yes | 3-2                |
|                                 |  |   | No  | 3-1                |
| 3 No. of Indoor Units           | 3-1  | Was the number of indoor units changed after auto address setting finished?   | Yes | 3-2                |
|                                 |  |   | No  | 4-1                |
|                                 | 3-2  | Conduct checks prior to auto address setting.   |     |                    |
| 4 Indoor unit control PC board  | 4-1  | Are the CHK pin and TEST pin on the indoor unit control board short-circuited?  | Yes | Remove the short   |
|                                 |  |   | No  | 4-2                |
|                                 | 4-2  | Is the wireless remote controller connected to on the indoor unit's control PC board?   | Yes | 4-3                |
|                                 |  |   | No  | 4-5                |
|                                 | 4-3  | Disconnect the connector mentioned above on the control PC board of the indoor unit control PC board and see whether the E15 goes off after several minutes. (When doing so, if two remote controllers are being used and the wireless remote controller is the main remote controller, set the other remote controller as the main.) | Yes | 4-4                |
|                                 |  |   | No  | 4-5                |
|                                 | 4-4  | Replace wireless remote control parts including wiring.   |     |                    |
| 4-5                             | Is the LED blinking on the indoor unit's control PC board?   | Yes   | 4-6 |                    |
|                                 |  | No  | 5-1 |                    |
| 4-6                             | The nonvolatile memory (EEPROM) on the indoor unit's control board is either not installed, improperly installed or the nonvolatile memory is faulty. Correct this or after replacing the nonvolatile memory, write model data to it in the remote control detailed settings mode. |   |     |                    |
| 5 Outdoor unit control PC board | 5-1  | Check all items under the section "Check Prior to Auto Address Setting".  |     |                    |

- For information on the procedures for replacing the nonvolatile memory (EEPROM) of the indoor unit, refer to the manual that is packaged with the indoor unit service board.
- For information on the remote control's detailed settings, refer to the Reference Materials.

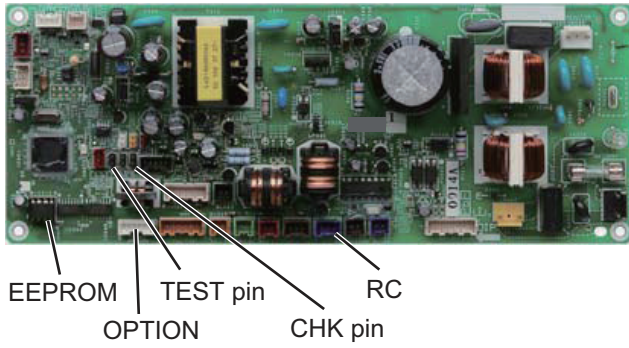
**A7302060 : 4-Way Cassette Type (Type U2)**



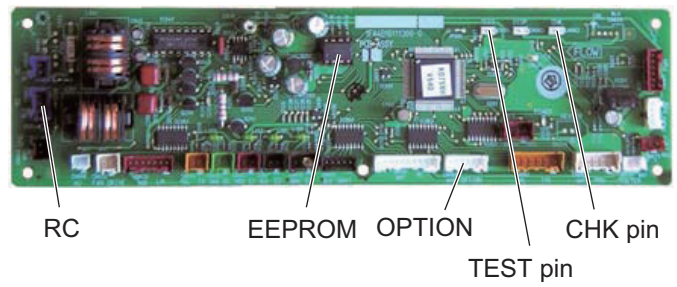
**A747931 : Ceiling Type (Type T2)**



**A747938 : Duct Type**



**A747336 : 4-Way Cassette 60 x 60 Type**



5

## E16 Automatic Address Alarm (The total capacity of indoor units is too high.)

### 1. Error Detection Method

It is judged an error the total capacity of indoor units is too high or the total number of indoor units is too many.

- The total capacity of indoor units is too high.
- The total number of indoor units is too many.

### 2. Error Diagnosis

|                |     |  |
|----------------|-----|--|
| 1 Auto Address | 1-1 | Check all items under the section "Check Prior to Auto Address Setting". |
|----------------|-----|--|

## E18 Faulty Communication in Group Control Wiring

### 1. Error Detection Method

When the main remote controller cannot communicate with a sub remote controller in the remote control group.

It is judged an error if a sub remote controller in a remote control group fails to communicate with the main remote controller for a period of three minutes.

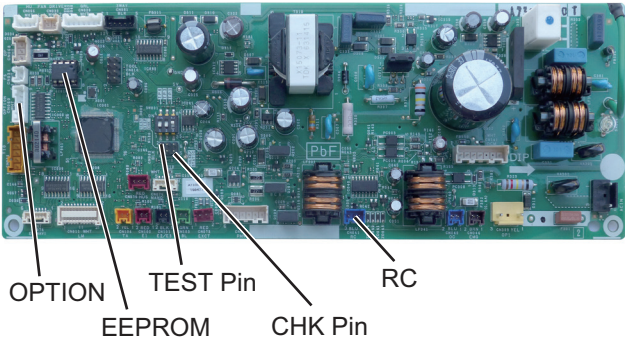
- An indoor unit within the control group does not have its power on.
- The CHK pin and TEXT pin on the indoor unit in the control group are shorted.
- The DISP pin of an indoor unit sub remote controller in the control group is shorted.
- Remote control group wiring is opened.
- More than one indoor unit in the control group is set to Main.
- An indoor unit in the control group is set to Separate.

### 2. Error Diagnosis

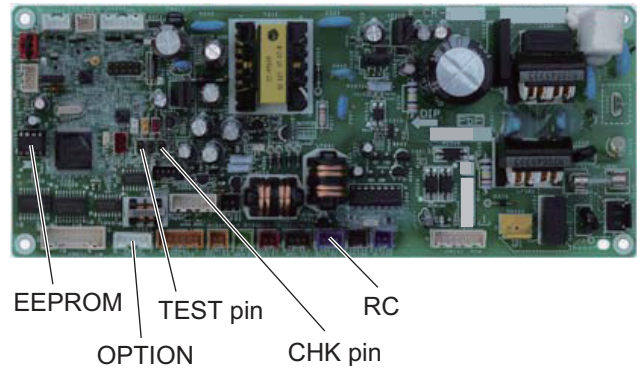
|                                    |   |  |     |                    |
|------------------------------------|---|--|-----|--------------------|
| 1 Indoor Unit                      | 1-1   | Is the indoor unit powered off?  | Yes | Power on           |
|                                    |   |  | No  | 1-2                |
|                                    | 1-2   | Are the CHK pin, TEST pin and DISP pin on the indoor unit control PC board short-circuited?  | Yes | Remove the short   |
|                                    |   |  | No  | 2-1                |
| 2 Substitute Sub Remote Controller | 2-1   | Is the remote control group's wiring opened?   | Yes | Correct the wiring |
|                                    |   |  | No  | 2-2                |
|                                    | 2-2   | Check the group settings (Item Code 14) from the remote control's detailed settings mode. Is the main remote controller (1) set to more than one remote controller or to separate (0)?   | Yes | 2-3                |
|                                    |   |  | No  | 3-1                |
|                                    | 2-3   | Is the wiring of the remote control group wired according to the wiring diagram?   | Yes | 2-4                |
|                                    |   |  | No  | 2-5                |
| 2-4                                | Run the auto address setting again.   |  |     |                    |
| 2-5                                | Run the auto address setting again after correcting the wiring of the remote control group. |  |     |                    |
| 3 Indoor unit control PCB          | 3-1   | Is the wireless remote controller connected to on the indoor unit's control PC board?  | Yes | 3-2                |
|                                    |   |  | No  | 3-4                |
|                                    | 3-2   | Disconnect the connector mentioned above on the control PC board of the indoor unit control PC board, and see whether the E18 goes off after several minutes. (When doing so, if two remote controllers are being used and the wireless remote controller is the main remote controller, set the other remote controller as the main.) | Yes | 3-3                |
|                                    |   |  | No  | 3-4                |
|                                    | 3-3   | Replace wireless remote control parts including wiring.  |     |                    |
| 3-4                                | Replace the indoor unit control PC board.   |  |     |                    |

- For information on the remote control's detailed settings, refer to the Reference Materials.
- For information on the procedures for replacing the Indoor unit control PCB, refer to the manual that is packaged with the indoor unit service board.

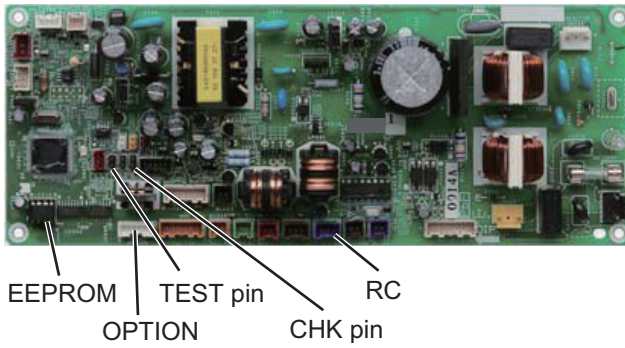
**A7302060 : 4-Way Cassette Type (Type U2)**



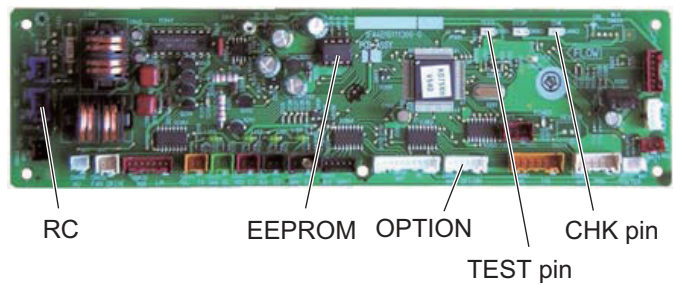
**A747931 : Ceiling Type (Type T2)**



**A747938 : Duct Type**



**A747336 : 4-Way Cassette 60 x 60 Type**



## E20 Connection Problem of Indoor/Outdoor Units

### 1. Error Detection Method

The outdoor unit detects an error at following cases during auto address setting.

- Indoor unit is not turned On.
- Indoor/outdoor control line is disconnected and also detects an error in the following cases when the outdoor unit is turned On.
- Address(es) of indoor unit(s) are not assigned correctly.
- Capacity of indoor/outdoor units is mismatched.
- Total number of indoor units is too many.

### 2. Error Diagnosis

|               |     |  |     |                        |
|---------------|-----|--|-----|------------------------|
| 1 Indoor Unit | 1-1 | Are the address(es) of indoor unit(s) assigned correctly?  | Yes | 1-2                    |
|               |     |  | No  | Set its address        |
|               | 1-2 | Are the indoor units turned on?  | Yes | 1-3                    |
|               |     |  | No  | Power on               |
|               | 1-3 | Be sure that the indoor and outdoor units are connected with correct combination written in catalog.   | Yes | 1-4                    |
|               |     |  | No  | Correct the connection |
|               | 1-4 | The indoor/outdoor control line may be disconnected somewhere between the indoor unit(s) and the outdoor unit. Make sure the indoor/outdoor control line is connected. |     |                        |

## F04 Compressor Discharge Temperature Sensor (TD) Trouble

### 1. Error Detection Method

It is judged an error based on the criteria listed below.

- Open circuit or Short circuit

### 2. Error Diagnosis

|                    |     |  |     |                                      |
|--------------------|-----|--|-----|--------------------------------------|
| 1 Sensor           | 1-1 | Sensor connector is connected to PC board properly.                | Yes | 1-2                                  |
|                    |     |  | No  | Reconnect and check                  |
|                    | 1-2 | Sensor is correctly installed at holder side.                      | Yes | Replace sensor                       |
|                    |     |  | No  | Correct and see what happens.<br>1-3 |
|                    | 1-3 | Abnormal temperature exists even after replacing sensor.           | Yes | 2-1                                  |
|                    |     |  | No  | See what happens.                    |
| 2 PC board         | 2-1 | Resistance between connector pins on PC board is less than 1 k ohm | Yes | Replace PC board                     |
|                    |     |  | No  | 2-2                                  |
|                    | 2-2 | Abnormal temperature exists even after replacing PC board.         | Yes | 3-1                                  |
|                    |     |  | No  | See what happens.                    |
| 3 Operating status | 3-1 | Peripheral temperature of outdoor unit is over 46°C.               | Yes | Correct                              |
|                    |     |  | No  | 3-2                                  |
|                    | 3-2 | Tends to have insufficient refrigerant charge in the system.       | Yes | Adjust the amount of refrigerant     |
|                    |     |  | No  | 3-3                                  |
|                    | 3-3 | Check noise.   |     |                                      |

## F06 Inlet Temperature Sensor (C1) in Heat Exchanger Trouble

### 1. Error Detection Method

- In case of open or short

### 2. Error Diagnosis

|                       |     |   |     |                   |
|-----------------------|-----|---|-----|-------------------|
| 1 Sensor Trouble      | 1-1 | Is the connector properly connected to PCB?                     | Yes | 1-2               |
|                       |     |   | No  | Reconnect & check |
|                       | 1-2 | Is the resistor between the sockets infinity or 0Ω?             | Yes | Replace sensor.   |
|                       |     |   | No  | 2-1               |
| 2 Control PCB Failure | 2-1 | Outdoor unit control PCB failure<br>Replace PCB with a new one. |     |                   |



## F07 Intermediate Temperature Sensor (C2) in Heat Exchanger Trouble

### 1. Error Detection Method

It is judged an error when open circuit or short circuit.

### 2. Error Diagnosis

|            |     |   |     |                     |
|------------|-----|---|-----|---------------------|
| 1 Sensor   | 1-1 | Sensor connector is connected to PC board properly.           | Yes | 1-2                 |
|            |     |   | No  | Reconnect and check |
|            | 1-2 | Resistance between sockets is infinity or 0 ohm.              | Yes | Replace sensor      |
|            |     |   | No  | 2-1                 |
| 2 PC board | 2-1 | Replace PC board because of outdoor control PC board failure. |     |                     |

## F08 Outdoor Air Temperature Sensor (TO) Trouble

### 1. Error Detection Method

It is judged an error when open circuit or short circuit.

### 2. Error Diagnosis

|            |     |   |     |                     |
|------------|-----|---|-----|---------------------|
| 1 Sensor   | 1-1 | Sensor connector is connected to PC board properly.           | Yes | 1-2                 |
|            |     |   | No  | Reconnect and check |
|            | 1-2 | Resistance between sockets is infinity or 0 ohm.              | Yes | Replace sensor      |
|            |     |   | No  | 2-1                 |
| 2 PC board | 2-1 | Replace PC board because of outdoor control PC board failure. |     |                     |

## F12 Compressor inlet Suction Temperature Sensor (TS) Trouble

### 1. Error Detection Method

It is judged an error when open circuit or short circuit.

### 2. Error Diagnosis

|                            |     |   |     |                     |
|----------------------------|-----|---|-----|---------------------|
| 1 Sensor                   | 1-1 | Sensor connector is connected to PC board properly.           | Yes | 1-2                 |
|                            |     |   | No  | Reconnect and check |
|                            | 1-2 | Resistance between sockets is infinity or 0 ohm.              | Yes | Replace sensor      |
|                            |     |   | No  | 2-1                 |
| 2 Outdoor control PC board | 2-1 | Replace PC board because of outdoor control PC board failure. |     |                     |

## F31 Outdoor Unit Nonvolatile Memory (EEPROM) Trouble

### 1. Error Detection Method

It is judged an error based on the criteria listed below.

- When power initially turned ON for the first time, nonvolatile memory (EEPROM) is not installed.
- Read values after writing onto nonvolatile memory (EEPROM) is inconsistent.

### 2. Error Diagnosis

|            |  |   |     |                |
|------------|--|---|-----|----------------|
| 1 PC board | 1-1  | Does EEPROM exist on the control PC board?  | Yes | 1-2            |
|            |  |   | No  | Install EEPROM |
|            | 1-2  | Is EEPROM installed properly?<br>(Check: Bent IC pin or incorrect installation, etc.) | Yes | 1-3            |
|            |  |   | No  | Correct        |
| 1-3        | Incorrect EEPROM<br>Replace with correct EEPROM. |   |     |                |

## H01 Primary (input) Overcurrent Detected

### 1. Error Detection Method

- Primary current effective value detected overcurrent (trip current value).

#### (Deluxe Model)

hp = horse power

| Single-phase model |            | 1.5hp | 2.3hp | 2.5hp | 3hp  | 4hp  | 5hp  | 6hp  |
|--------------------|------------|-------|-------|-------|------|------|------|------|
| Trip current value | Heating(A) | 13.0  | 14.0  | 18.5  | 20.0 | 27.0 | 29.0 | 30.0 |
|                    | Cooling(A) | 11.5  | 11.5  | 15.2  | 18.5 | 27.0 | 29.0 | 30.0 |

| 3-phase model      |         | 3hp | 4hp  | 5hp  | 6hp  |
|--------------------|---------|-----|------|------|------|
| Trip current value | Heating | 9.5 | 12.5 | 13.5 | 14.5 |
|                    | Cooling | 8.0 | 12.0 | 12.6 | 13.0 |

#### (Standard Model)

| Single-phase model |         | 2.5hp | 3hp  | 4hp  | 5hp  |
|--------------------|---------|-------|------|------|------|
| Trip current value | Heating | 18.5  | 18.5 | 27.0 | 30.0 |
|                    | Cooling | 15.2  | 15.2 | 27.0 | 30.0 |

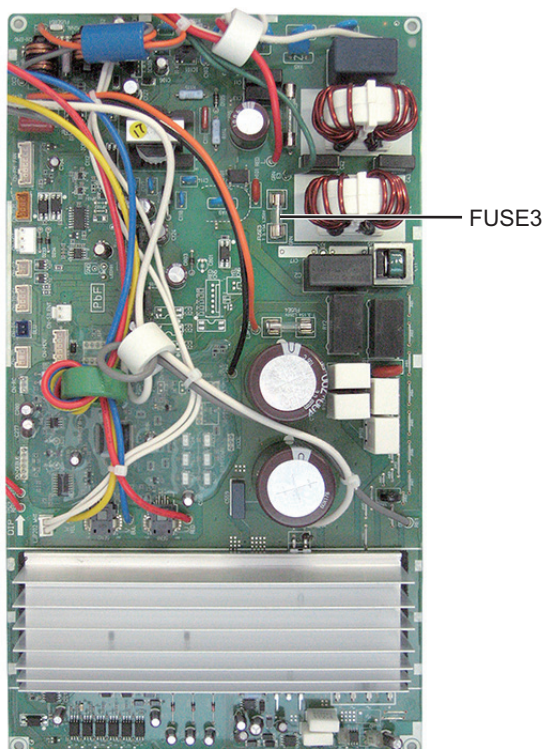
| 3-phase model      |         | 4hp  | 5hp  | 6hp  |
|--------------------|---------|------|------|------|
| Trip current value | Heating | 12.5 | 13.5 | 13.5 |
|                    | Cooling | 12.0 | 13.0 | 13.0 |

### 2. Error Diagnosis

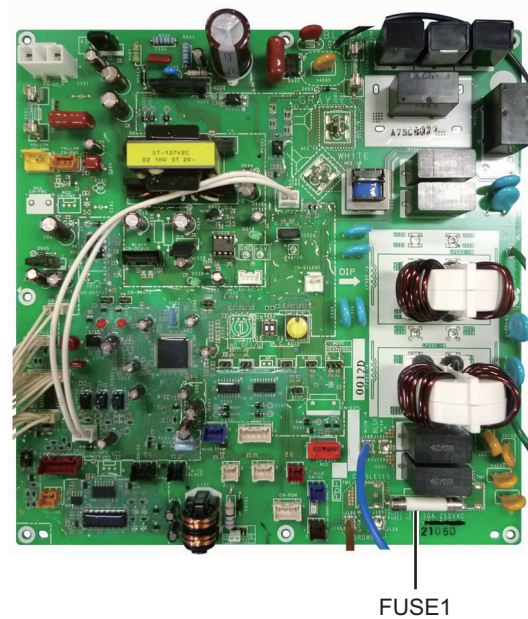
|                   |   |  |                    |                    |
|-------------------|---|--|--------------------|--------------------|
| 1 Power supply*   | 1-1   | Not satisfied with $\pm 10\%$ rated supply voltage                       | Yes                | Check power supply |
|                   |   |  | No                 | 1-2                |
|                   | 1-2   | Extreme voltage fluctuations   | Yes                | Check power supply |
|                   |   |  | No                 | 1-3                |
| 1-3               | Extreme distortion of voltage waveform      | Yes  | Check power supply |                    |
|                   |   | No   | 1-4                |                    |
| 1-4               | Instantaneous blackout may sometimes occur. | Yes  | Check power supply |                    |
|                   |   | No   | 2-1                |                    |
| 2 PC board wiring | 2-1   | Has FUSE 1/FUSE 2 blown?<br>Check the electrical conduction with tester. | Yes                | 2-3                |
|                   |   |  | No                 | 2-2                |
|                   | 2-2   | Loose electrical wire connection   | Yes                | Correct wiring     |
|                   |   |  | No                 | 2-3                |
| 2-3               | Replace CR board.                           |  |                    |                    |

\* Check not only in the outdoor unit stop mode but in the drive mode.

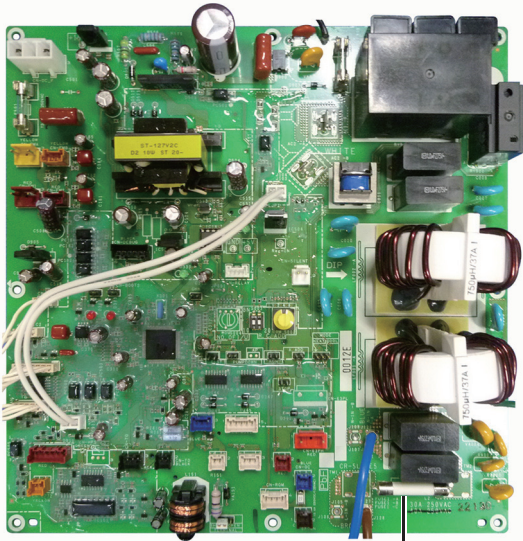
**ACXA73-03100 : Bottom side**  
**(U-36PE2E5A, U-50PE2E5A, U-60PE2E5A)**  
**(U-60PEY2E5, U-71PEY2E5)**  
**(for single-phase outdoor unit PCB)**



**A747898 : (U-71PE1E5A)**  
**(for single-phase outdoor unit PCB)**

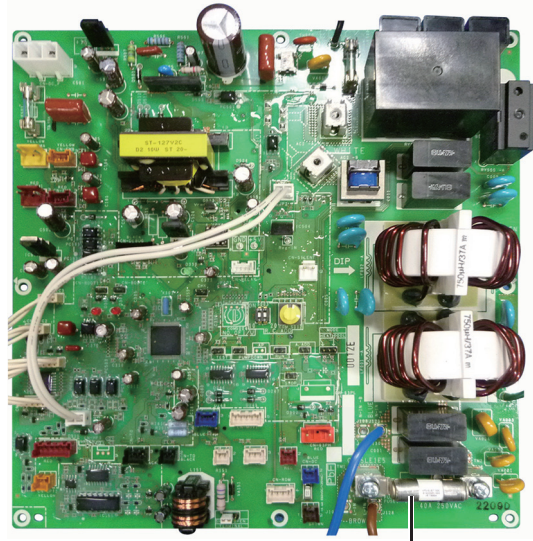


**A747895 : (U-100PE1E5A)**  
**(for single-phase outdoor unit PCB)**



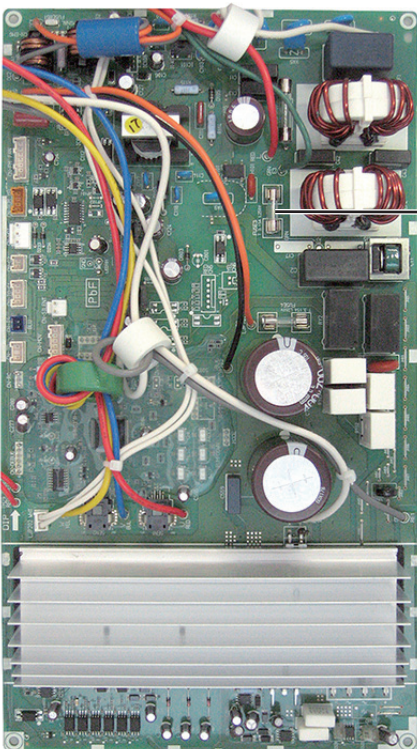
FUSE1

**A747896 : (U-125PE1E5A, U-140PE1E5A)**  
**(for single-phase outdoor unit PCB)**



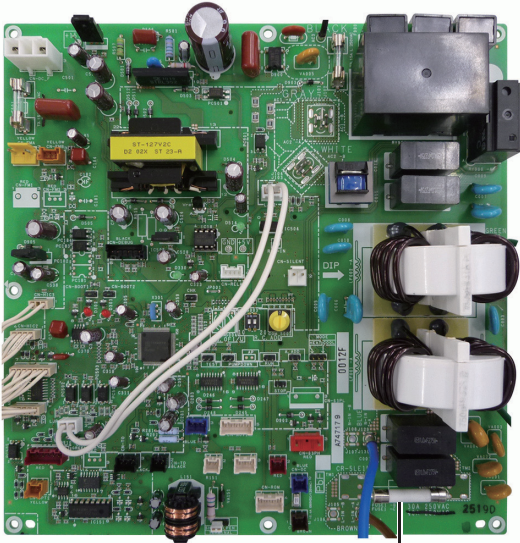
FUSE1

**ACXA73-03100 : Bottom side**  
**(U-36PE2E5A, U-50PE2E5A, U-60PE2E5A)**  
**(U-60PEY2E5, U-71PEY2E5)**  
**(for single-phase outdoor unit PCB)**



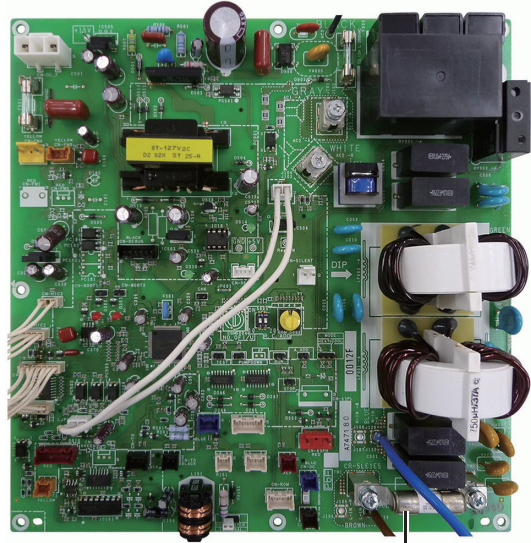
FUSE3

**A747179 : (U-100PEY1E5)**  
**(for single-phase outdoor unit PCB)**



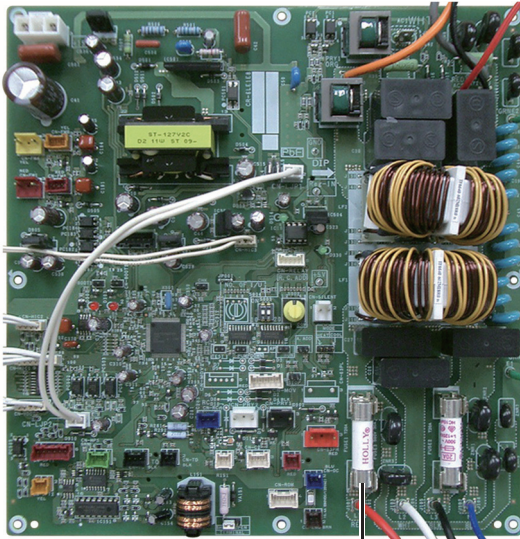
FUSE1

**A747180 : (U-125PEY1E5)**  
**(for single-phase outdoor unit PCB)**



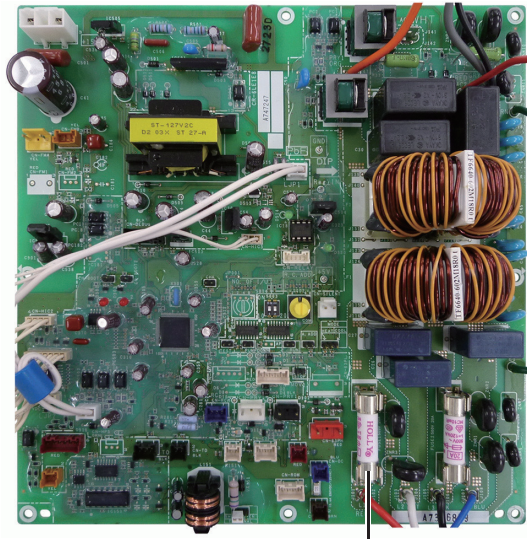
FUSE1

**A747899 : (U-71PE1E8A)**  
**A747897 : (U-100PE1E8A, U-125PE1E8A,**  
**U-140PE1E8A)**  
**A747596 : (U-140PEY1E8)**  
**(for 3-phase outdoor unit PCB)**



FUSE1

**A747247 : (U-100PEY1E8, U-125PEY1E8)**  
**(for 3-phase outdoor unit PCB)**



FUSE1

## H02 PAM Trouble (Single-phase only)

### 1. Error Detection Method

- Error is detected by over-voltage and overcurrent of DC side.

### 2. Error Diagnosis

|                   |     |  |     |                              |
|-------------------|-----|--|-----|------------------------------|
| 1 Power supply*   | 1-1 | Not satisfied with $\pm 10\%$ rated supply voltage                       | Yes | Check power supply           |
|                   |     |  | No  | 1-2                          |
|                   | 1-2 | Extreme voltage fluctuations   | Yes | Check power supply           |
|                   |     |  | No  | 1-3                          |
|                   | 1-3 | Extreme distortion of voltage waveform                                   | Yes | Check power supply           |
|                   |     |  | No  | 2-1                          |
| 2 PC board wiring | 2-1 | Loose electrical wire connection   | Yes | Correct connection           |
|                   |     |  | No  | 2-2                          |
|                   | 2-2 | Is HIC PC board connector (CN-PAM) poorly connected or opened with wire? | Yes | Correct connection or wiring |
|                   |     |  | No  | 2-3                          |
|                   | 2-3 | Replace HIC PC board.  |     |                              |

\* Check not only in the outdoor unit stop mode but in the drive mode.



## H03 Primary Current CT Sensor (current sensor) Failure

### 1. Error Detection Method

It is judged an error based on the criteria listed below.

- If 18A or greater is detected when the compressor is stopped (alarm triggered even if the connector is unplugged).
- If no current is detected even though a compressor is running.

### 2. Error Diagnosis

|                              |     |   |     |                   |
|------------------------------|-----|---|-----|-------------------|
| 1 Check the control PC board | 1-1 | Turn the power on again and run the outdoor unit.<br>Is alarm occurred after operation? | Yes | Replace CR board. |
|                              |     |   | No  | See what happens. |

## H05 Sensor Failure, Compressor Discharge Temperature Sensor (TD) Disconnected

### 1. Error Detection Method

- (In case of outdoor temperature over 5°C) For 10 minutes since started, variation of discharge temperature is always detected within 2°C comparing with the temperature just before starting.
- (In case of outdoor temperature less than 5°C) For 30 minutes since started, variation of discharge temperature is always detected within 2°C comparing with the temperature just before starting.

|                  |     |  |     |                      |
|------------------|-----|--|-----|----------------------|
| 1 Sensor Trouble | 1-1 | Is the sensor properly installed at the holder side? | Yes | 1-2                  |
|                  |     |  | No  | Reinstall correctly. |
|                  | 1-2 | Replace the sensor with a new one.                   |     |                      |

## H31 HIC Trouble

### 1. Error Detection Method

It is judged an error if the computer detects an error signal from the HIC.

An error signal is issued by the HIC if abnormal heat occurs inside the HIC or if there is an overcurrent.

However, it is judged an error in the same way if the signal line from the HIC is not connected properly or opened.

- HIC overcurrent due to HIC fault
- HIC abnormal heat caused by defective HIC or HIC radiation error
- Signal line is not connected properly or opened between the HIC and the outdoor CR board.

### 2. Error Diagnosis

|   |     |  |     |   |
|---|-----|--|-----|---|
| 1 Wiring between HIC & outdoor control PC board | 1-1 | The wiring (power cord and signal line) between the HIC and the outdoor CR board is connected properly.  | Yes | 1-2   |
|   |     |  | No  | Correct wiring (connector)                      |
|   | 1-2 | Everything is normal in the wiring (power cord & signal line) between the HIC and the outdoor CR board. Check the wiring one by one with a tester if there is opened and grounding.  | Yes | 3-1 : Single-phase model<br>2-1 : 3-phase model |
|   |     |  | No  | Replace wiring                                  |
| 2 Check the outdoor unit CR PC board            | 2-1 | The connector CN-PRY1 on the CR PC board is connected properly (locked). (3-phase only)  | Yes | 3-1   |
|   |     |  | No  | Correct wiring (connector)                      |
| 3 HIC poor radiation                            | 3-1 | The heat dissipating surface on the back of the HIC is in good contact with the heat sink (heat dissipating fins) of the electrical box. Check for looseness in the fastening screws and the condition of the heat-conducting putty. | Yes | 3-2   |
|   |     |  | No  | Tighten screw(s), add putty                     |
|   | 3-2 | A good flow of cooling air passes through the heat sink (heat dissipating fins) of the electrical box. Check for debris blocking the fins.   | Yes | 4-1   |
|   |     |  | No  | Remove foreign matter                           |
| 4 HIC overcurrent (Compressor failure)          | 4-1 | The results of the pass/fail tests for the following HIC board IPM show it to be outside the range of the resistance of a conforming part.   | Yes | Replace the HIC PC board                        |
|   |     |  | No  | 4-2   |
|   | 4-2 | H31 occurs within 30 seconds when the inverter compressor started.   | Yes | See the alarm code P29.                         |
|   |     |  | No  | See the alarm code P16.                         |

#### • HIC board IPM Pass/Fail Tests

- Measure with an analog tester. (Set to the k ohm range)
- Measure the board by itself. (Remove wires connected from other parts.)
- Measure using IPM terminals.

The resistance values are shown in the table below.

(U-36PE2E5A, U-50PE2E5A, U-60PE2E5A)

(U-60PEY2E5, U-71PEY2E5)

|                        |           |           |           |           |           |           |           |          |
|------------------------|-----------|-----------|-----------|-----------|-----------|-----------|-----------|----------|
| Tester terminals       |           |           |           |           |           |           |           |          |
| +                      | P         |           |           |           | N         |           |           |          |
| -                      | U         | V         | W         | N         | U         | V         | W         | P        |
| Resistance value (ohm) | 1k to 10k | 1k to 10k | 1k to 10k | 5k to 20k | 10k to ∞  | 10k to ∞  | 10k to ∞  | 10k to ∞ |
| Tester terminals       |           |           |           |           |           |           |           |          |
| -                      | P         |           |           |           | N         |           |           |          |
| +                      | U         | V         | W         |           | U         | V         | W         |          |
| Resistance value (ohm) | 10k to ∞  | 10k to ∞  | 10k to ∞  |           | 1k to 10k | 1k to 10k | 1k to 10k |          |

- Excepting the parts of "10 k to ∞", it is acceptable if a small resistance value appears as a reference value unless the value is "0 = short-circuit".

|                        |             |             |             |             |           |           |           |           |
|------------------------|-------------|-------------|-------------|-------------|-----------|-----------|-----------|-----------|
| Tester terminals       |             |             |             |             |           |           |           |           |
| +                      | HIC+        |             |             |             | HIC-      |           |           |           |
| -                      | U           | V           | W           | HIC-        | U         | V         | W         | HIC+      |
| Resistance value (ohm) | 1 k to 10 k | 1 k to 10 k | 1 k to 10 k | 5 k to 20 k | 20 k to ∞ | 20 k to ∞ | 20 k to ∞ | 20 k to ∞ |

|                        |           |           |           |  |             |             |             |  |
|------------------------|-----------|-----------|-----------|--|-------------|-------------|-------------|--|
| Tester terminals       |           |           |           |  |             |             |             |  |
| -                      | HIC+      |           |           |  | HIC-        |             |             |  |
| +                      | U         | V         | W         |  | U           | V           | W           |  |
| Resistance value (ohm) | 20 k to ∞ | 20 k to ∞ | 20 k to ∞ |  | 1 k to 10 k | 1 k to 10 k | 1 k to 10 k |  |

- Excepting the parts of “20 k to ∞”, it is acceptable if a small resistance value appears as a reference value unless the value is “0 = short-circuit”.

**(U-71PE1E5A ~ U-140PE1E5A / U-71PE1E8A ~ U-140PE1E8A)**  
**(U-100PEY1E5, U-125PEY1E5 / U-100PEY1E8 ~ U-140PEY1E8)**

|                        |            |            |            |             |            |            |            |            |
|------------------------|------------|------------|------------|-------------|------------|------------|------------|------------|
| Tester terminals       |            |            |            |             |            |            |            |            |
| +                      | P          |            |            |             | NU         |            |            |            |
| -                      | U          | V          | W          | NU          | U          | V          | W          | P          |
| Resistance value (ohm) | 1 k to 5 k | 1 k to 5 k | 1 k to 5 k | 5 k to 10 k | 100 k to ∞ | 100 k to ∞ | 100 k to ∞ | 100 k to ∞ |

|                        |            |            |            |  |            |            |            |  |
|------------------------|------------|------------|------------|--|------------|------------|------------|--|
| Tester terminals       |            |            |            |  |            |            |            |  |
| -                      | P          |            |            |  | NU         |            |            |  |
| +                      | U          | V          | W          |  | U          | V          | W          |  |
| Resistance value (ohm) | 100 k to ∞ | 100 k to ∞ | 100 k to ∞ |  | 1 k to 5 k | 1 k to 5 k | 1 k to 5 k |  |

- Excepting the parts of “100 k to ∞”, it is acceptable if a small resistance value appears as a reference value unless the value is “0 = short-circuit”.

|                        |             |             |             |             |           |           |           |           |
|------------------------|-------------|-------------|-------------|-------------|-----------|-----------|-----------|-----------|
| Tester terminals       |             |             |             |             |           |           |           |           |
| +                      | HIC+        |             |             |             | HIC-      |           |           |           |
| -                      | U           | V           | W           | HIC-        | U         | V         | W         | HIC+      |
| Resistance value (ohm) | 1 k to 10 k | 1 k to 10 k | 1 k to 10 k | 5 k to 20 k | 20 k to ∞ | 20 k to ∞ | 20 k to ∞ | 20 k to ∞ |

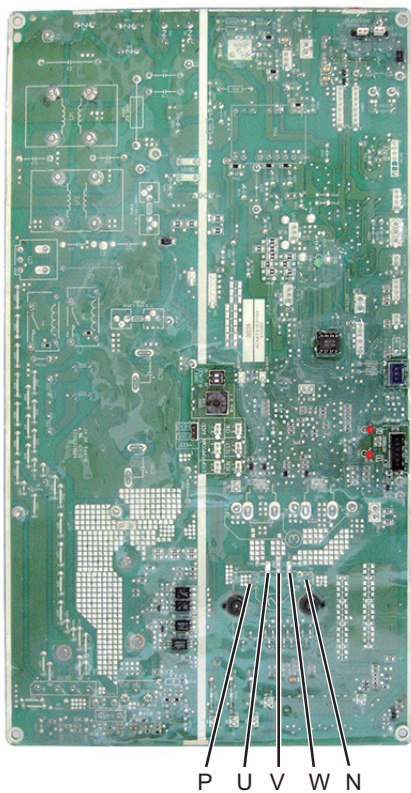
|                        |           |           |           |  |             |             |             |  |
|------------------------|-----------|-----------|-----------|--|-------------|-------------|-------------|--|
| Tester terminals       |           |           |           |  |             |             |             |  |
| -                      | HIC+      |           |           |  | HIC-        |             |             |  |
| +                      | U         | V         | W         |  | U           | V           | W           |  |
| Resistance value (ohm) | 20 k to ∞ | 20 k to ∞ | 20 k to ∞ |  | 1 k to 10 k | 1 k to 10 k | 1 k to 10 k |  |

- Excepting the parts of “20 k to ∞”, it is acceptable if a small resistance value appears as a reference value unless the value is “0 = short-circuit”.

5

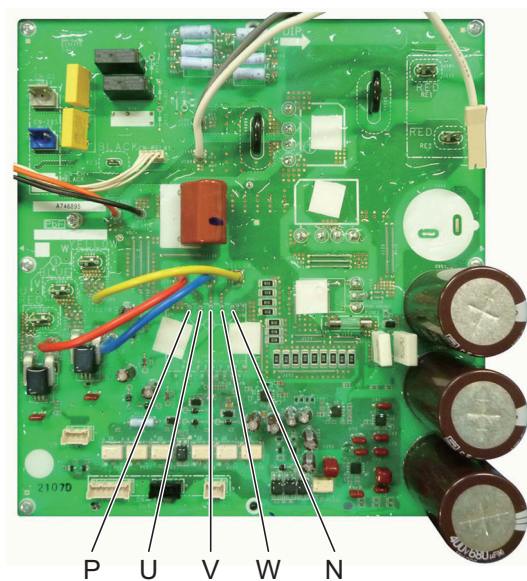
■ Outdoor Unit Control PCB

ACXA73-03100 : Bottom side  
(U-36PE2E5A, U-50PE2E5A, U-60PE2E5A)  
(U-60PEY2E5, U-71PEY2E5)  
(for single-phase outdoor unit PCB)

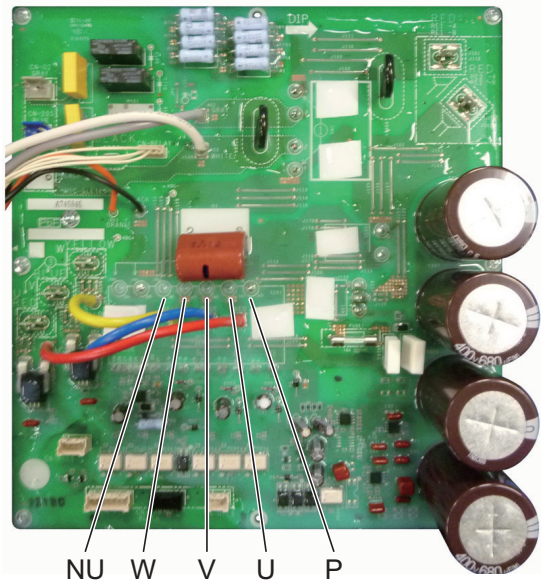


■ Outdoor Unit Control HIC PCB

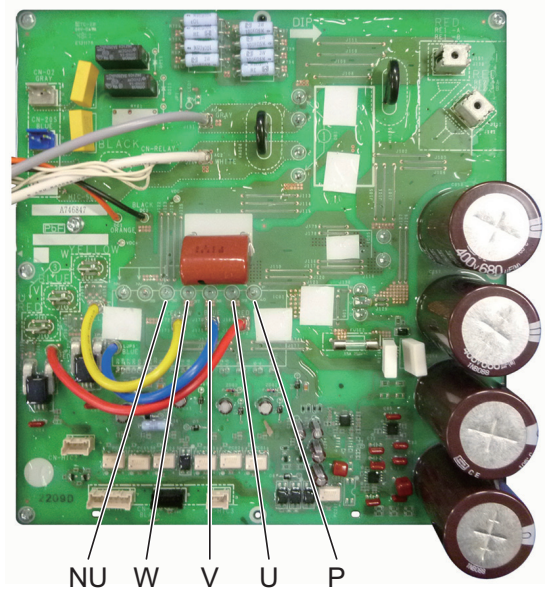
A746895 : (U-71PE1E5A)  
(for single-phase outdoor unit HIC PCB)



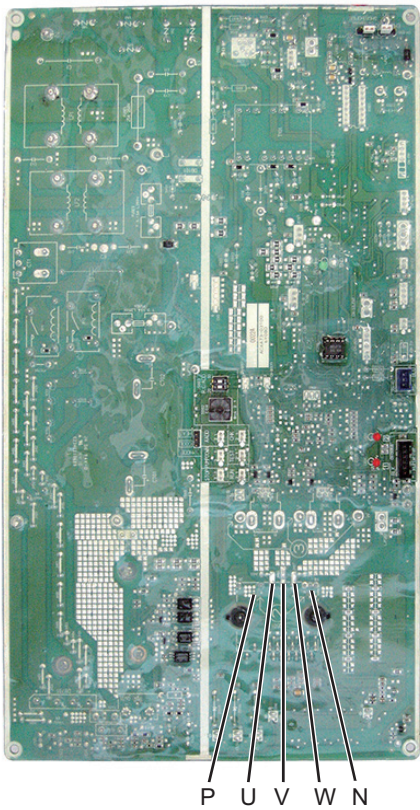
■ Outdoor Unit Control HIC PCB  
 A746846 : (U-100PE1E5A)  
 (for single-phase outdoor unit HIC PCB)



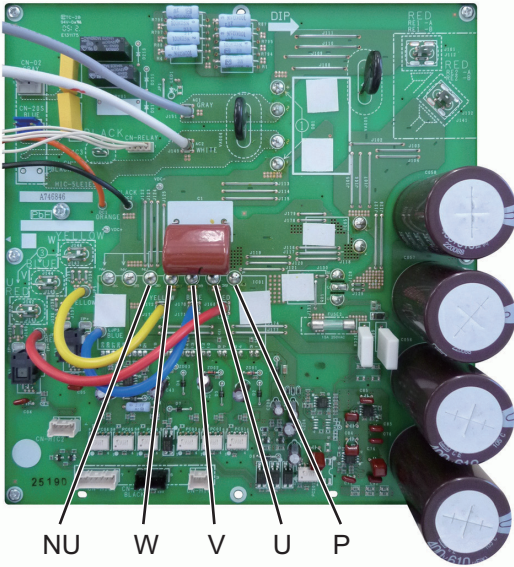
A746847 : (U-125PE1E5A, U-140PE1E5A)  
 (for single-phase outdoor unit HIC PCB)



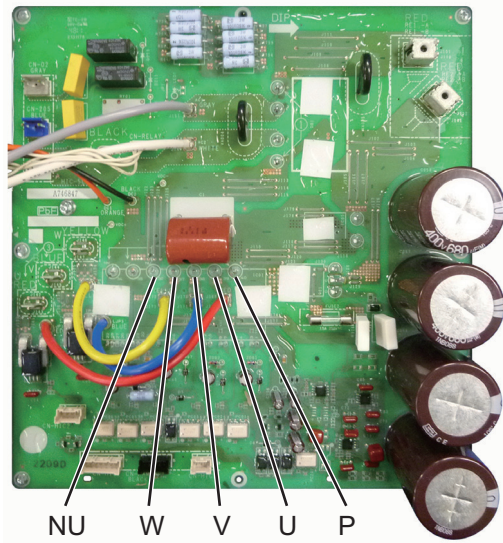
■ Outdoor Unit Control PCB  
 ACXA73-03100 : Bottom side  
 (U-36PE2E5A, U-50PE2E5A, U-60PE2E5A)  
 (U-60PEY2E5, U-71PEY2E5)  
 (for single-phase outdoor unit PCB)



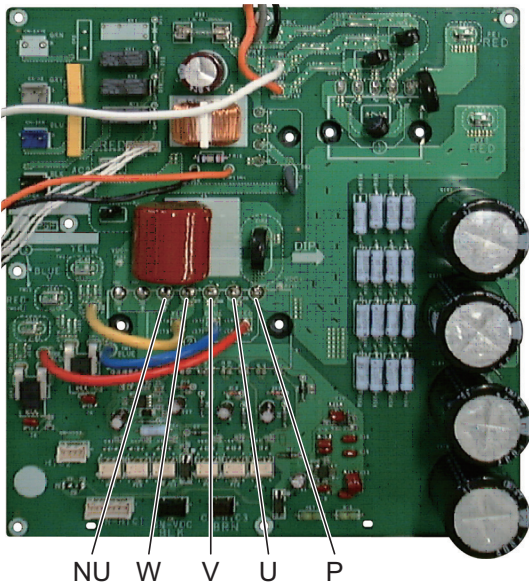
**A746846 : (U-100PEY1E5)**  
**(for single-phase outdoor unit HIC PCB)**



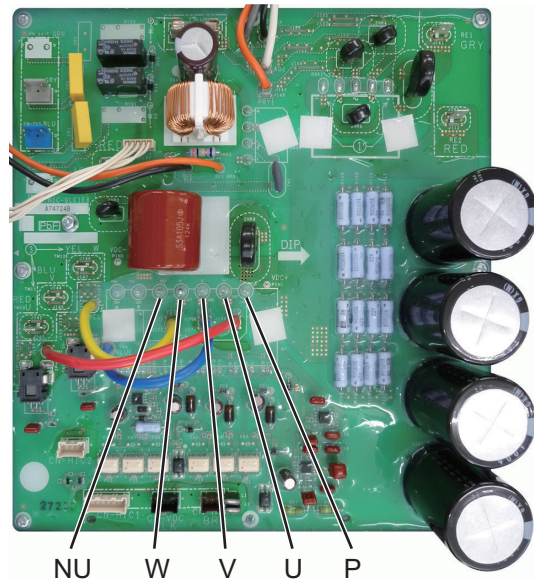
**A746847 : (U-125PEY1E5)**  
**(for single-phase outdoor unit HIC PCB)**



**A746970 : (U-71PE1E8A)**  
**A746969 : (U-100PE1E8A, U-125PE1E8A,**  
**U-140PE1E8A, U-140PEY1E8)**  
**(for 3-phase outdoor unit HIC PCB)**

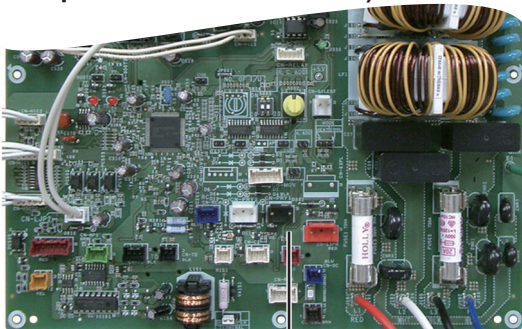


**A747248 : (U-100PEY1E8, U-125PEY1E8)**  
**(for 3-phase outdoor unit HIC PCB)**



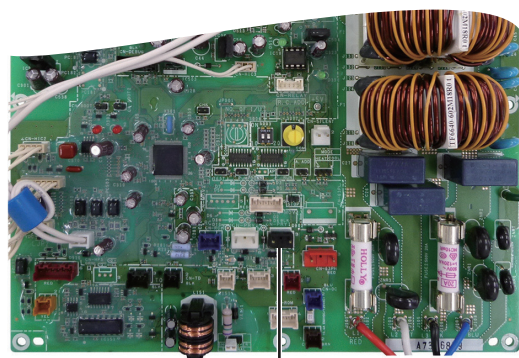
■ **Outdoor Unit Control PCB**

**A747899 : (U-71PE1E8A)**  
**A747897 : (U-100PE1E8A, U-125PE1E8A,**  
**U-140PE1E8A)**  
**A747596 : (U-140PEY1E8)**  
**(for 3-phase outdoor unit PCB)**



CN-PRY1

**A747247 : (U-100PEY1E8, U-125PEY1E8)**  
**(for 3-phase outdoor unit PCB)**



CN-PRY1

## L04 Outdoor Unit Address Duplication

### 1. Error Detection Method

It is judged an error when the identical self-address communication on the indoor and outdoor wirings is received over 5 times within 3 minutes.

### 2. Error Diagnosis

|                                   |     |  |     |     |
|-----------------------------------|-----|--|-----|-----|
| 1 System address                  | 1-1 | Are other outdoor units using a duplicate setting?   | Yes | 2-1 |
|                                   |     |  | No  | 2-2 |
| 2 Installation or setting related | 2-1 | When units are networked, first set the system address for each outdoor unit in the order 1-2-3 and then run auto address setting. |     |     |
|                                   | 2-2 | Run the auto address setting.  |     |     |



## L10 Outdoor Unit Capacity not Set or Invalid

### 1. Error Detection Method

It is judged an error when outdoor unit capacity not yet setup or systematically unauthorized setting.

### 2. Error Diagnosis

|                                   |     |  |     |                |
|-----------------------------------|-----|--|-----|----------------|
| 1 Check the control PC board      | 1-1 | Was EEPROM replaced when PC board was replaced?  | Yes | 2-1            |
|                                   |     |  | No  | Replace EEPROM |
| 2 Installation or setting related | 2-1 | Set an applicable capacity value on the item code 81 display of maintenance remote controller. |     |                |

- Check : Connect the outdoor maintenance remote controller and check whether item code 81 outdoor capacity value shows "0" or unauthorized capacity is set on the detailed settings mode display of the outdoor EEPROM.  
If the capacity value of the item code 81 with the outdoor maintenance remote controller is incorrect, recorrect and set it again.

\* After setting the capacity value, be sure to reset the power supply switches of both indoor and outdoor units.

## L13 Indoor Unit Type Setting Error

### 1. Error Detection method

- Discordance model(s) between outdoor and indoor units are detected.

|  |     |  |     |                       |
|--|-----|--|-----|-----------------------|
| 1 Discordance Unit                           | 1-1 | Are models for outdoor and indoor units matched respectively?<br>(Ex: Are multiple indoor units connected to commercial outdoor units?)                                | Yes | 2-1                   |
|  |     |  | No  | Replace indoor units. |
| 2 Installation Failure                       | 2-1 | Check the indoor unit's motor valve with the remote control detailed settings mode (2C code) and commercial indoor unit is set to "2" and multiple indoor unit is "0". | Yes | 3-1                   |
|  |     |  | No  | Change installation.  |
| 3 Operating Wires for Indoor & Outdoor Units | 3-1 | Check whether or not indoor and outdoor unit operating wires are short circuit, disconnection, loose connection or earth fault.  |     |                       |

## L18 4-way Valve Operation Failure

### 1. Error Detection Method

It is judged an error when during heating operation (Comp. ON), the highest detected temperature at an outdoor unit heat exchanger (C1) was 20°C or more above the outdoor air temperature (Air Temp.) continuously for 5 minutes or longer.

### 2. Error Diagnosis

|                   |   |  |     |                      |
|-------------------|---|--|-----|----------------------|
| 1 PC board wiring | 1-1   | Is the connector wired from the 4-way valve plugged in the CN-20S connector on the HIC PC board properly?  | Yes | 1-2                  |
|                   |   |  | No  | Correct connector    |
|                   | 1-2   | Has the 4-way valve wiring become opened?  | Yes | Correct wiring       |
|                   |   |  | No  | 1-3                  |
|                   | 1-3   | Is the wire from the coil for controlling the 4-way valve firmly connected to the 4-way valve?   | Yes | 2-1                  |
|                   |   |  | No  | Correct connector    |
| 2 4-way valve     | 2-1   | During heating mode (Comp. ON), insert and remove the connector wired from the 4-way valve into or from CN-20S connector on the HIC PC board. At the same time, does the ON & OFF sounds occur from the 4-way valve? | Yes | 2-2                  |
|                   |   |  | No  | Replace HIC PC board |
|                   | 2-2   | During heating mode (Comp. ON), does the alarm code L18 reproduce for 5 minutes or longer after insertion and removal of CN-20S connector wired from the 4-way valve connector on the HIC PC board?                  | Yes | 2-3                  |
|                   |   |  | No  | See what happens     |
| 2-3               | The parts inside the 4-way valve might have fixed at the cooling side.<br>Replace the 4-way valve |  |     |                      |

## P03 Compressor Discharge Temperature Trouble

### 1. Error Detection Method

- When the discharge temperature is over 106°C.

### 2. Error Diagnosis

|                                    |     |  |     |                                      |
|------------------------------------|-----|--|-----|--------------------------------------|
| 1 Adjustment to refrigerant charge | 1-1 | Not additional refrigerant charged   | Yes | Additional refrigerant charge        |
|                                    |     |  | No  | 2-2                                  |
|                                    | 1-2 | Tends to have insufficient refrigerant charge in the system.   | Yes | Adjust the refrigerant amount        |
|                                    |     |  | No  | Replace CR board                     |
| 2 Blockage in refrigerant circuit  | 2-1 | Service valve inside the outdoor unit closed   | Yes | Open service valve                   |
|                                    |     |  | No  | 2-2                                  |
|                                    | 2-2 | Are the tubes clogged?   | Yes | Avoid clogging                       |
|                                    |     |  | No  | 2-3                                  |
|                                    | 2-3 | Is the outdoor unit's electronic control valve operating correctly?<br>(Check for debris clogging the electronic control valve, a problem with the electrical coil and/or the control PC board.) | Yes | 2-4                                  |
|                                    |     |  | No  | Replace the electronic control valve |
|                                    | 2-4 | Is it observable difference in status of the dew or frost between the strainer's primary and secondary sides?  | Yes | Replace the strainer                 |
|                                    |     |  | No  | Replace CR board                     |

## P04 High Pressure Trouble

### 1. Error Detection Method

It is judged an error if the internal circuit of the high pressure switch is dead.  
 The electronic circuitry of the high pressure switch is cut off if the pressure at the pressure sensor port of the high pressure switch reaches 3.80 MPa. Once it is cut off, it remains cut off until the pressure drops to 3.15 MPa.

- The high pressure switch is malfunctioning.
- Service valve inside the outdoor unit closed
- There is a short air circuit through the outdoor unit's heat exchanger. (when cooling)
- The outdoor unit's fan is broken. (when cooling)
- The outdoor unit's heat exchanger is clogged. (when cooling)
- There is a short air circuit at the indoor unit. (when heating)
- The filter of the indoor unit is clogged. (when heating)
- The fan of the indoor unit is broken or the fan motor is malfunctioning. (when heating)
- The refrigerant circuit is closed and the high pressure is increasing abnormally high. (solenoid valve or expansion valve not activated, a stuck check valve, etc.)
- Refrigerant overcharged.
- Nitrogen or air contaminated in the refrigerant system

### 2. Error Diagnosis

|                                     |   |   |  |   |
|-------------------------------------|---|---|--|---|
| 1 High pressure switch              | 1-1   | The socket of the high pressure switch is securely inserted in the PC board. The wiring is not opened.  | Yes  | 1-2                                       |
|                                     |   |   | No   | Correct connection and/or wiring          |
|                                     | 1-2   | Even if parts near the high pressure switch are shaken quite a lot, the high pressure cutoff will be activated. Even if the covering is in good condition, in several cases vibration has caused wiring inside to open. | Yes  | Replace the high pressure switch (wiring) |
|                                     |   |   | No   | 2-1                                       |
| 2 Service valve                     | 2-1   | Service valve inside the outdoor unit closed  | Yes  | Open the service valve                    |
|                                     |   |   | No   | 2-2                                       |
|                                     | 2-2   | There is an extreme difference in temperature in/out of the service valve.  | Yes  | 2-3                                       |
|                                     |   |   | No   | 3-1                                       |
| 2-3                                 | Check the flare connection, someone may have forgotten to remove the bonnet. If there is a problem within the service valve, replace the valve. |   |  |   |
| 3 Problem around the heat exchanger | 3-1   | While cooling is operating an alarm is occurred.  | Yes  | 3-2                                       |
|                                     |   |   | No   | 3-5                                       |
|                                     | 3-2   | The intake temperature (ambient temperature) of the outdoor unit's heat exchanger is above 46°C.  | Yes  | Prevent air short circuit                 |
|                                     |   |   | No   | 3-3                                       |
|                                     | 3-3   | The outdoor unit's heat exchanger is clogged.   | Yes  | Clean the heat exchanger                  |
|                                     |   |   | No   | 3-4                                       |
|                                     | 3-4   | Check whether the outdoor unit fan is normal or if the sockets are firmly pressed onto the plugs on the outdoor PC board, as well as if any wiring is opened. Are these checking finished without fail?                 | Yes  | 4-1                                       |
| No                                  |   |   | Replace the outdoor unit fan. Correct connection and/or wiring |   |
| 3-5                                 | While heating is operating an alarm is occurred.  | Yes   | 3-6  |   |
|                                     |   | No  | 4-1  |   |

|                                       |   |  |     |   |
|---------------------------------------|---|--|-----|---|
| 3 Problem around the heat exchanger   | 3-6   | The intake temperature (ambient temperature) of the indoor unit is above 36°C.   | Yes | Prevent air short circuit                                   |
|                                       |   |  | No  | 3-7   |
|                                       | 3-7   | The filter of the indoor unit is clogged.  | Yes | Clean the filter  |
|                                       |   |  | No  | 3-8   |
|                                       | 3-8   | The fan of the indoor unit is broken or the fan motor is faulty.   | Yes | Replace the indoor fan (motor)                              |
|                                       |   |  | No  | 4-1   |
| 4 Blockage in the refrigerant circuit | 4-1   | Is the outdoor unit's electronic control valve operating correctly? (Check for debris clogging the electronic control valve, a problem with the electrical coil and/or the control PC board.)  | Yes | 4-3   |
|                                       |   |  | No  | Repair the electronic control valve of the outdoor unit     |
|                                       | 4-2   | The indoor unit's expansion valve is operating correctly. (check for debris clogging the valve, a problem with the electrical coil and/or the control PC board)  | Yes | 4-3   |
|                                       |   |  | No  | Repair the expansion valve of the indoor unit               |
|                                       | 4-3   | If an alarm is occurred with the high pressure below 3.80 MPa, with the pressure measured as displayed by the manifold gauge, check the check valve in the compressor discharge line. Are these checking finished without fail?  | Yes | 4-4   |
|                                       |   |  | No  | Replace the check valve in the compressor discharge line    |
|                                       | 4-4   | The electronic control valve is faulty. In systems where the solenoid valve kits and the ice thermal storage tank are connected, check these solenoid valves.  | Yes | Replace the electronic control valve and/or solenoid valve. |
|                                       |   |  | No  | 5-1   |
| 5 Overcharging                        | 5-1   | Error occurs when the system is operating in cooling mode.   | Yes | 5-3   |
|                                       |   |  | No  | 5-2   |
|                                       | 5-2   | Error occurs when the system is operating in heating mode.   | Yes | 5-4   |
|                                       |   |  | No  | 5-5   |
|                                       | 5-3   | An alarm is occurred with the high pressure at 3.80 MPa, with the pressure measured either as displayed by the monitoring software or with a manifold gauge, at which time the temperature of liquid in the outdoor unit's heat exchanger is detected to be at the temperature of the outside air. | Yes | 5-5   |
|                                       |   |  | No  | Contact the service representative                          |
|                                       | 5-4   | An alarm is occurred with the high pressure at 3.80 MPa, with the pressure measured either as displayed by the monitoring software or with a manifold gauge, at which time the temperature of liquid in the indoor heat exchanger is detected to be at room temperature (intake temperature).      | Yes | 5-5   |
|                                       |   |  | No  | Contact the service representative                          |
| 5-5                                   | The system may be overcharged. Check how much refrigerant was added during installation. When a system is inspected for airtightness, it is seldom that enough nitrogen has been expelled, so some remains in the circuit. In this case, it is necessary to collect the refrigerant and then recharge the system. |  |     |   |

## P05 AC Power Supply Trouble

### 1. Error Detection Method

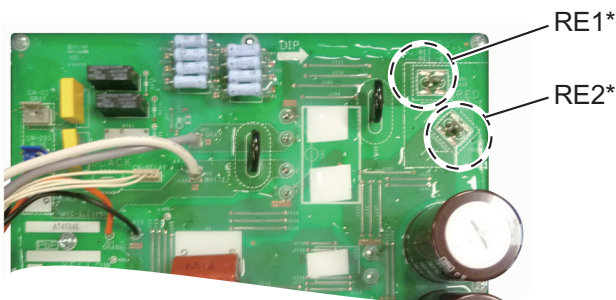
- Instantaneous blackout
- Zero-cross (waveform input of power supply) error
- DC voltage charge failure

### 2. Error Diagnosis

Note : The work involved in diagnosing each of the items is extremely dangerous, so turn the power off at the breaker before performing the tests.

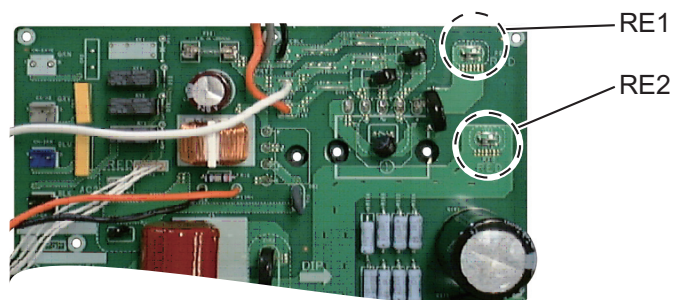
|                                       |   |   |   |   |
|---------------------------------------|---|---|---|---|
| 1 Check the power supply & the wiring | 1-1   | Is the voltage on each of the terminal boards within $\pm 10\%$ of the rated voltage?           | Yes   | 1-4 : Single-phase model<br>1-2 : 3-phase model   |
|                                       |   |   | No  | Check for open circuit and the voltage at the breaker. if a problem is found, fix it and check again. |
|                                       | 1-2   | Power wiring N-phase is connected.  | Yes   | Correct wiring  |
|                                       |   |   | No  | 1-3   |
| 1-3                                   | Power wiring L2 and N are reverse connected. (3-phase only)           | Yes   | Correct wiring                                  |   |
|                                       |   | No  | 1-4   |   |
| 1-4                                   | Turn the power back on and check again. Is the alarm triggered again? | Yes   | 3-1 : Single-phase model<br>2-1 : 3-phase model |   |
|                                       |   | No  | 4-1   |   |
| 2 Check the outdoor unit CR PC board  | 2-1   | The connector CN-PRY2 on the outdoor CR PC board is connected properly (locked). (3-phase only) | Yes   | 3-1   |
|                                       |   |   | No  | Correct wiring (connector)  |
| 3 Check the outdoor unit HIC PC board | 3-1   | Are the wires (RE1, RE2) from the reactor firmly installed?                                     | Yes   | 3-2   |
|                                       |   |   | No  | Correct wiring  |
|                                       | 3-2   | Turn the power back on and check again. Is the alarm triggered again?                           | Yes   | Replace the outdoor unit HIC PC board.  |
|                                       |   |   | No  | 4-1   |
| 4 Final check                         | 4-1   | There may be a instantaneous blackout failure. If there is nothing abnormal, see what happens.  |   |   |

Single-phase outdoor unit HIC PC board

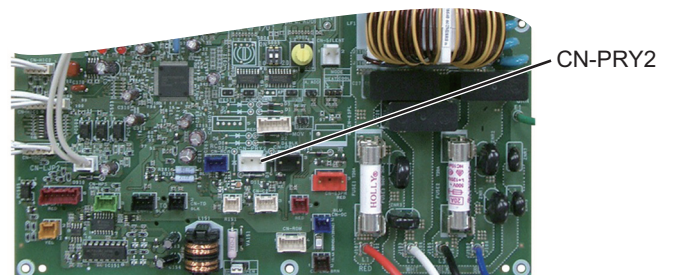


\* Common in RE1 and RE2  
4hp : Plug-in type  
5hp, 6hp : Fastening screw type

3-phase outdoor unit HIC PC board



(for 3-phase outdoor unit CR PC board)



## P13 Alarm Valve Open

### 1. Error Detection Method

Detection is performed only in the test run. When once detected or the test run finished without any error, the second detection will not be done.

In case of forgetting to open a valve, P04 (high-pressure switch operational alarm) is occasionally preceded due to the following conditions.

- The status of small temperature change of the operating indoor unit continues for the first 7 minutes since the cooling test run has started.

### 2. Error Diagnosis

|                                    |   |  |     |                                      |
|------------------------------------|---|--|-----|--------------------------------------|
| 1 Service valve                    | 1-1   | Service valve inside the outdoor unit closed   | Yes | Open the service valve               |
|                                    |   |  | No  | 2-1                                  |
| 2 Adjustment to refrigerant change | 2-1   | Not additional refrigerant charged   | Yes | Additional refrigerant charge        |
|                                    |   |  | No  | 3-1                                  |
| 3 Blockage in refrigerant circuit  | 3-1   | Are the tubes clogged?   | Yes | Avoid clogging                       |
|                                    |   |  | No  | 3-2                                  |
|                                    | 3-2   | Is the outdoor unit's electronic control valve operating correctly?<br>(Check for debris clogging the electronic control valve, a problem with the electrical coil and/or the control PC board.) | Yes | 3-3                                  |
|                                    |   |  | No  | Replace the electronic control valve |
| 3-3                                | As the second detection is not done, restart and see what happens if there is no error. |  |     |                                      |



## P14 O<sub>2</sub> Sensor Detect

### 1. Error Detection Method

- It is judged an error whenever the outdoor unit receives the signal "O<sub>2</sub> Alarm Occurred" from the indoor unit.
- With the indoor unit's EEPROM setting (item code 0B) set to 0001, the EXCT input was shorted.

### 2. Error Diagnosis

|                                  |     |  |     |                                   |
|----------------------------------|-----|--|-----|-----------------------------------|
| 1 System configuration           | 1-1 | Is an O <sub>2</sub> sensor being used?  | Yes | 3-1                               |
|                                  |     |  | No  | 2-1                               |
| 2 Indoor unit's EEPROM setting   | 2-1 | Is the indoor EEPROM setting, item code 0B, on the indoor unit's control PC board set to 0001?   | Yes | After correcting the setting, 3-1 |
|                                  |     |  | No  | 4-1                               |
| 3 Indoor EXCT wiring             | 3-1 | Is the indoor EXCT socket (wire) shorted?  | Yes | Correct wiring                    |
|                                  |     |  | No  | 4-1                               |
| 4 Indoor unit's control PC board | 4-1 | Is the alarm triggered if the indoor EXCT socket (wire) is disconnected, and the power is reset? | Yes | 4-3                               |
|                                  |     |  | No  | 4-2                               |
|                                  | 4-2 | Since there is no error, see what happens.   |     |                                   |
|                                  | 4-3 | Indoor unit control PC board error → replace PC board.   |     |                                   |

## P15 Insufficient Gas Level Detected

### 1. Abnormal Detection Method

Alarm occurs in the following cases:

- Compressor's current value shows lower than a certain value.
- Compressor's discharge temperature exceeds 95°C.
- Electronic expansion valve is fully opened.
- The difference between indoor unit heat exchanger temperature and intake temperature is less than 4K.

### 2. Error Diagnosis

|                                    |     |  |     |                                       |
|------------------------------------|-----|--|-----|---------------------------------------|
| 1 Adjustment of refrigerant amount | 1-1 | Insufficient gas level<br>(Check whether or not pressure level is normal.) | Yes | Recharge with additional refrigerant. |
|                                    |     |  | No  | 1-2                                   |
|                                    | 1-2 | Check leakage of refrigeration (leak test)                                 | Yes | Replace leaking part with a new one.  |
|                                    |     |  | No  | See what happens.                     |

## P16 Compressor Overcurrent Trouble

### 1. Meaning of Alarm

#### Secondary current effective value detected the overcurrent (trip current value)

##### (Deluxe Model)

Single phase model(1.5hp-2.5hp):Trip current=12.0A

Single phase model(3hp):Trip current=23.0A

Single phase model(4hp-6hp):Trip current=27.0A

3 phase model(3hp):Trip current=12.0A

3 phase model(4hp-6hp):Trip current=17.0A

##### (Standard Model)

Single phase model(2.5hp-3hp):Trip current=12.0A

Single phase model(4hp):Trip current=20.0A

Single phase model(5hp):Trip current=27.0A

3 phase model(4hp):Trip current=12.0A

3 phase model(5hp-6hp):Trip current=17.0A

#### Secondary current instantly value detected the overcurrent (trip current value)

##### (Deluxe Model)

Single phase model(1.5hp-2.5hp):Trip current=18.9Apeak

Single phase model(3hp):Trip current=28.0Apeak

Single phase model(4hp-6hp):Trip current=45.0Apeak

3 phase model(3hp):Trip current=24.0Apeak

3 phase model(4hp-6hp):Trip current=27.0Apeak

##### (Standard Model)

Single phase model(2.5hp-3hp):Trip current=18.9Apeak

Single phase model(4hp):Trip current=28.0Apeak

Single phase model(5hp):Trip current=45.0Apeak

3 phase model(4hp):Trip current=17.0Apeak

3 phase model(5hp-6hp):Trip current=27.0Apeak

### 2. Check of content

|                    |     |   |     |   |
|--------------------|-----|---|-----|---|
| 0 Multiple factors | 0-1 | Replaced the compressor (added oil, if it was necessary) but it occurred again immediately.   | Yes | 7-1   |
|                    |     |   | No  | -   |
|                    | 0-2 | Replaced the board, but it occurred again immediately.  | Yes | Replace compressor along with adding oil, then recheck from 1-1 |
|                    |     |   | No  | -   |
| 1 Power Source     | 1-1 | Power cord connections are loose.   | Yes | Correct the wiring  |
|                    |     |   | No  | 1-2   |
|                    | 1-2 | Rated power voltage is not within $\pm 10\%$ .  | Yes | Test the power supply   |
|                    |     |   | No  | 1-3   |
|                    | 1-3 | Extreme fluctuations in voltage.  | Yes | Test the power supply   |
|                    |     |   | No  | 1-4   |
|                    | 1-4 | An open phase state is observed.  | Yes | Test the power supply   |
|                    |     |   | No  | 2-1   |
| 2 Board wiring     | 2-1 | Disconnected parts, miswiring and/or poor connections (loose) are observed in the connections on the CR board and/or in the connections of components that are connected by wiring from the CR board. | Yes | Correct   |
|                    |     |   | No  | 2-2   |
|                    | 2-2 | Disconnected parts, miswiring and/or poor connections (loose) are observed in the connections of outdoor board(s) that are connected by wiring from the CR board.                                     | Yes | Correct   |
|                    |     |   | No  | 2-3   |
|                    | 2-3 | Disconnected parts, miswiring and/or poor connections (loose) are observed in the connections of outdoor board(s) that are connected by wiring from the HIC board.                                    | Yes | Correct   |
|                    |     |   | No  | 2-4   |
|                    | 2-4 | Disconnected parts, miswiring and/or poor connections (loose) are observed in the connections of HIC boards connected by wiring from the CR board.  | Yes | Correct   |
|                    |     |   | No  | 2-5   |
|                    | 2-5 | Disconnected parts, miswiring and/or poor connections (loose) are observed in the connections of HIC board(s) that are connected by wiring from the outdoor board.                                    | Yes | Correct   |
|                    |     |   | No  | 2-6   |

|                        |  |   |                                  |  |
|------------------------|--|---|----------------------------------|--|
|                        | 2-6  | Disconnected parts, miswiring and/or poor connections (loose) are observed in the connections of HIC board(s) that are connected by wiring to a compressor. | Yes                              | Correct  |
|                        |  |   | No                               | 3-1  |
| 3 Compressor wiring    | 3-1  | Disconnections and/or miswiring are observed in the connecting location of the compressor terminals.  | Yes                              | Correct  |
|                        |  |   | No                               | 3-2  |
|                        | 3-2  | Conditions such as burned terminal covers and/or discolored terminals are observed in the connecting location of the compressor terminals.                  | Yes                              | Eliminate looseness by changing the terminals, or crimping the terminals again.              |
|                        |  |   | No                               | 4-1  |
| 4 Check the situation  | 4-1  | Outdoor air intake temperature is high.   | Yes                              | Take measures  |
|                        |  |   | No                               | 4-2  |
|                        | 4-2  | May be caused by poor outdoor unit air flow (dirty or clogged heat exchanger, blocked discharge port, etc.)   | Yes                              | Correct  |
|                        |  |   | No                               | 4-3  |
|                        | 4-3  | Air short circuit has occurred. This is a phenomenon when discharged air (exhaust heat) from the outdoor unit is drawn back into the suction vent.          | Yes                              | Prevent air short circuit  |
|                        |  |   | No                               | 4-4  |
|                        | 4-4  | Indoor air intake temperature is high.  | Yes                              | Take measures  |
|                        |  |   | No                               | 4-5  |
| 4-5                    | The filter of the indoor unit is clogged.  | Yes   | Clean the filter                 |  |
|                        |  | No  | 4-6                              |  |
| 4-6                    | Air short circuit has occurred. This is a phenomenon when discharged air (exhaust heat) from the indoor unit is drawn back into the suction vent.                              | Yes   | Prevent air short circuit        |  |
|                        |  | No  | 5-1                              |  |
| 5 Check operation      | 5-1  | Possible to operate.  | Yes                              | 5-2  |
|                        |  |   | No                               | 6-1  |
|                        | 5-2  | Operating pressure is affected by pressure overload.  | Yes                              | 5-3  |
|                        |  |   | No                               | 5-4  |
|                        | 5-3  | Tends to have an overcharge of refrigerant in the system.   | Yes                              | Adjust the amount of refrigerant   |
|                        |  |   | No                               | 5-4  |
|                        | 5-4  | Tends to operate for a long time turning gas back into liquid.  | Yes                              | Check the operation of functional parts  |
|                        |  |   | No                               | 5-5  |
| 5-5                    | Tends to have insufficient refrigerant charge in the system.   | Yes   | Adjust the amount of refrigerant |  |
|                        |  | No  | 5-6                              |  |
| 5-6                    | Even though the high pressure saturation temperature is 43°C or less, the secondary current of the inverter is high. (The frequency (Hz) ends up dropping due to the current.) | Yes   | Replace the compressor           |  |
|                        |  | No  | See what happens.                |  |
| 6 Check history        | 6-1  | Dividing the outdoor EEPROM INV operation time by the number of times oil was supplied to the system yields 3 hours or less.                                | Yes                              | 6-2  |
|                        |  |   | No                               | 6-2  |
|                        | 6-2  | There is a history of H31 in the pre-trip counter of the outdoor EEPROM alarm history.  | Yes                              | Replace the compressor and add oil. However if 6-1 was "no," it is not necessary to add oil. |
|                        |  | No  | 7-1                              |  |
| 7 Check the HIC boards | 7-1  | The results of HIC board IPM Pass/Fail Tests show the outside the range of the resistance of a conforming part listed in the next page.                     | Yes                              | Replace HIC board  |
|                        |  |   | No                               | 8-1  |

|   |        |   |                    |                        |       |       |       |     |     |     |     |                                    |        |       |  |       |  |       |  |  |        |       |  |       |  |       |  |  |        |       |  |       |  |       |  |  |               |  |     |     |     |     |                                    |        |       |       |  |  |        |       |       |  |  |        |       |       |  |  |                    |  |       |     |     |     |                                    |        |       |       |  |       |        |       |       |  |       |        |       |       |  |       |               |  |     |     |     |                                    |        |       |       |  |        |       |       |  |        |       |       |  |     |                        |
|---|--------|---|--------------------|------------------------|-------|-------|-------|-----|-----|-----|-----|------------------------------------|--------|-------|--|-------|--|-------|--|--|--------|-------|--|-------|--|-------|--|--|--------|-------|--|-------|--|-------|--|--|---------------|--|-----|-----|-----|-----|------------------------------------|--------|-------|-------|--|--|--------|-------|-------|--|--|--------|-------|-------|--|--|--------------------|--|-------|-----|-----|-----|------------------------------------|--------|-------|-------|--|-------|--------|-------|-------|--|-------|--------|-------|-------|--|-------|---------------|--|-----|-----|-----|------------------------------------|--------|-------|-------|--|--------|-------|-------|--|--------|-------|-------|--|-----|------------------------|
| 8 Check the compressor                  | 8-1    | The compressor is causing a failure in the insulation.  | Yes                | Replace the compressor |       |       |       |     |     |     |     |                                    |        |       |  |       |  |       |  |  |        |       |  |       |  |       |  |  |        |       |  |       |  |       |  |  |               |  |     |     |     |     |                                    |        |       |       |  |  |        |       |       |  |  |        |       |       |  |  |                    |  |       |     |     |     |                                    |        |       |       |  |       |        |       |       |  |       |        |       |       |  |       |               |  |     |     |     |                                    |        |       |       |  |        |       |       |  |        |       |       |  |     |                        |
|   |        |   | No                 | 8-2                    |       |       |       |     |     |     |     |                                    |        |       |  |       |  |       |  |  |        |       |  |       |  |       |  |  |        |       |  |       |  |       |  |  |               |  |     |     |     |     |                                    |        |       |       |  |  |        |       |       |  |  |        |       |       |  |  |                    |  |       |     |     |     |                                    |        |       |       |  |       |        |       |       |  |       |        |       |       |  |       |               |  |     |     |     |                                    |        |       |       |  |        |       |       |  |        |       |       |  |     |                        |
| 8-2                                     |        | The winding resistance of the compressor is abnormal.<br><b>(Deluxe Model)</b><br><table border="1"> <tr> <td>Single-phase model</td> <td></td> <td>1.5hp</td> <td>2.3hp</td> <td>2.5hp</td> <td>3hp</td> <td>4hp</td> <td>5hp</td> <td>6hp</td> </tr> <tr> <td rowspan="3">Standard winding of the compressor</td> <td>U-V(Ω)</td> <td colspan="2">1.886</td> <td colspan="2">0.720</td> <td colspan="3">0.490</td> </tr> <tr> <td>U-W(Ω)</td> <td colspan="2">1.880</td> <td colspan="2">0.726</td> <td colspan="3">0.495</td> </tr> <tr> <td>V-W(Ω)</td> <td colspan="2">1.866</td> <td colspan="2">0.708</td> <td colspan="3">0.483</td> </tr> </table><br><table border="1"> <tr> <td>3-phase model</td> <td></td> <td>3hp</td> <td>4hp</td> <td>5hp</td> <td>6hp</td> </tr> <tr> <td rowspan="3">Standard winding of the compressor</td> <td>U-V(Ω)</td> <td>1.843</td> <td colspan="2">1.061</td> <td></td> </tr> <tr> <td>U-W(Ω)</td> <td>1.893</td> <td colspan="2">1.079</td> <td></td> </tr> <tr> <td>V-W(Ω)</td> <td>1.812</td> <td colspan="2">1.050</td> <td></td> </tr> </table><br><b>(Standard Model)</b><br><table border="1"> <tr> <td>Single-phase model</td> <td></td> <td>2.5hp</td> <td>3hp</td> <td>4hp</td> <td>5hp</td> </tr> <tr> <td rowspan="3">Standard winding of the compressor</td> <td>U-V(Ω)</td> <td>1.886</td> <td colspan="2">0.843</td> <td>0.490</td> </tr> <tr> <td>U-W(Ω)</td> <td>1.880</td> <td colspan="2">0.844</td> <td>0.495</td> </tr> <tr> <td>V-W(Ω)</td> <td>1.866</td> <td colspan="2">0.868</td> <td>0.483</td> </tr> </table><br><table border="1"> <tr> <td>3-phase model</td> <td></td> <td>4hp</td> <td>5hp</td> <td>6hp</td> </tr> <tr> <td rowspan="3">Standard winding of the compressor</td> <td>U-V(Ω)</td> <td>1.948</td> <td colspan="2">1.061</td> </tr> <tr> <td>U-W(Ω)</td> <td>2.018</td> <td colspan="2">1.079</td> </tr> <tr> <td>V-W(Ω)</td> <td>1.945</td> <td colspan="2">1.050</td> </tr> </table> | Single-phase model |                        | 1.5hp | 2.3hp | 2.5hp | 3hp | 4hp | 5hp | 6hp | Standard winding of the compressor | U-V(Ω) | 1.886 |  | 0.720 |  | 0.490 |  |  | U-W(Ω) | 1.880 |  | 0.726 |  | 0.495 |  |  | V-W(Ω) | 1.866 |  | 0.708 |  | 0.483 |  |  | 3-phase model |  | 3hp | 4hp | 5hp | 6hp | Standard winding of the compressor | U-V(Ω) | 1.843 | 1.061 |  |  | U-W(Ω) | 1.893 | 1.079 |  |  | V-W(Ω) | 1.812 | 1.050 |  |  | Single-phase model |  | 2.5hp | 3hp | 4hp | 5hp | Standard winding of the compressor | U-V(Ω) | 1.886 | 0.843 |  | 0.490 | U-W(Ω) | 1.880 | 0.844 |  | 0.495 | V-W(Ω) | 1.866 | 0.868 |  | 0.483 | 3-phase model |  | 4hp | 5hp | 6hp | Standard winding of the compressor | U-V(Ω) | 1.948 | 1.061 |  | U-W(Ω) | 2.018 | 1.079 |  | V-W(Ω) | 1.945 | 1.050 |  | Yes | Replace the compressor |
|   |        |   | Single-phase model |                        | 1.5hp | 2.3hp | 2.5hp | 3hp | 4hp | 5hp | 6hp |                                    |        |       |  |       |  |       |  |  |        |       |  |       |  |       |  |  |        |       |  |       |  |       |  |  |               |  |     |     |     |     |                                    |        |       |       |  |  |        |       |       |  |  |        |       |       |  |  |                    |  |       |     |     |     |                                    |        |       |       |  |       |        |       |       |  |       |        |       |       |  |       |               |  |     |     |     |                                    |        |       |       |  |        |       |       |  |        |       |       |  |     |                        |
| Standard winding of the compressor      | U-V(Ω) | 1.886   |                    | 0.720                  |       | 0.490 |       |     |     |     |     |                                    |        |       |  |       |  |       |  |  |        |       |  |       |  |       |  |  |        |       |  |       |  |       |  |  |               |  |     |     |     |     |                                    |        |       |       |  |  |        |       |       |  |  |        |       |       |  |  |                    |  |       |     |     |     |                                    |        |       |       |  |       |        |       |       |  |       |        |       |       |  |       |               |  |     |     |     |                                    |        |       |       |  |        |       |       |  |        |       |       |  |     |                        |
|   | U-W(Ω) | 1.880   |                    | 0.726                  |       | 0.495 |       |     |     |     |     |                                    |        |       |  |       |  |       |  |  |        |       |  |       |  |       |  |  |        |       |  |       |  |       |  |  |               |  |     |     |     |     |                                    |        |       |       |  |  |        |       |       |  |  |        |       |       |  |  |                    |  |       |     |     |     |                                    |        |       |       |  |       |        |       |       |  |       |        |       |       |  |       |               |  |     |     |     |                                    |        |       |       |  |        |       |       |  |        |       |       |  |     |                        |
|   | V-W(Ω) | 1.866   |                    | 0.708                  |       | 0.483 |       |     |     |     |     |                                    |        |       |  |       |  |       |  |  |        |       |  |       |  |       |  |  |        |       |  |       |  |       |  |  |               |  |     |     |     |     |                                    |        |       |       |  |  |        |       |       |  |  |        |       |       |  |  |                    |  |       |     |     |     |                                    |        |       |       |  |       |        |       |       |  |       |        |       |       |  |       |               |  |     |     |     |                                    |        |       |       |  |        |       |       |  |        |       |       |  |     |                        |
| 3-phase model                           |        | 3hp   | 4hp                | 5hp                    | 6hp   |       |       |     |     |     |     |                                    |        |       |  |       |  |       |  |  |        |       |  |       |  |       |  |  |        |       |  |       |  |       |  |  |               |  |     |     |     |     |                                    |        |       |       |  |  |        |       |       |  |  |        |       |       |  |  |                    |  |       |     |     |     |                                    |        |       |       |  |       |        |       |       |  |       |        |       |       |  |       |               |  |     |     |     |                                    |        |       |       |  |        |       |       |  |        |       |       |  |     |                        |
| Standard winding of the compressor      | U-V(Ω) | 1.843   | 1.061              |                        |       |       |       |     |     |     |     |                                    |        |       |  |       |  |       |  |  |        |       |  |       |  |       |  |  |        |       |  |       |  |       |  |  |               |  |     |     |     |     |                                    |        |       |       |  |  |        |       |       |  |  |        |       |       |  |  |                    |  |       |     |     |     |                                    |        |       |       |  |       |        |       |       |  |       |        |       |       |  |       |               |  |     |     |     |                                    |        |       |       |  |        |       |       |  |        |       |       |  |     |                        |
|   | U-W(Ω) | 1.893   | 1.079              |                        |       |       |       |     |     |     |     |                                    |        |       |  |       |  |       |  |  |        |       |  |       |  |       |  |  |        |       |  |       |  |       |  |  |               |  |     |     |     |     |                                    |        |       |       |  |  |        |       |       |  |  |        |       |       |  |  |                    |  |       |     |     |     |                                    |        |       |       |  |       |        |       |       |  |       |        |       |       |  |       |               |  |     |     |     |                                    |        |       |       |  |        |       |       |  |        |       |       |  |     |                        |
|   | V-W(Ω) | 1.812   | 1.050              |                        |       |       |       |     |     |     |     |                                    |        |       |  |       |  |       |  |  |        |       |  |       |  |       |  |  |        |       |  |       |  |       |  |  |               |  |     |     |     |     |                                    |        |       |       |  |  |        |       |       |  |  |        |       |       |  |  |                    |  |       |     |     |     |                                    |        |       |       |  |       |        |       |       |  |       |        |       |       |  |       |               |  |     |     |     |                                    |        |       |       |  |        |       |       |  |        |       |       |  |     |                        |
| Single-phase model                      |        | 2.5hp   | 3hp                | 4hp                    | 5hp   |       |       |     |     |     |     |                                    |        |       |  |       |  |       |  |  |        |       |  |       |  |       |  |  |        |       |  |       |  |       |  |  |               |  |     |     |     |     |                                    |        |       |       |  |  |        |       |       |  |  |        |       |       |  |  |                    |  |       |     |     |     |                                    |        |       |       |  |       |        |       |       |  |       |        |       |       |  |       |               |  |     |     |     |                                    |        |       |       |  |        |       |       |  |        |       |       |  |     |                        |
| Standard winding of the compressor      | U-V(Ω) | 1.886   | 0.843              |                        | 0.490 |       |       |     |     |     |     |                                    |        |       |  |       |  |       |  |  |        |       |  |       |  |       |  |  |        |       |  |       |  |       |  |  |               |  |     |     |     |     |                                    |        |       |       |  |  |        |       |       |  |  |        |       |       |  |  |                    |  |       |     |     |     |                                    |        |       |       |  |       |        |       |       |  |       |        |       |       |  |       |               |  |     |     |     |                                    |        |       |       |  |        |       |       |  |        |       |       |  |     |                        |
|   | U-W(Ω) | 1.880   | 0.844              |                        | 0.495 |       |       |     |     |     |     |                                    |        |       |  |       |  |       |  |  |        |       |  |       |  |       |  |  |        |       |  |       |  |       |  |  |               |  |     |     |     |     |                                    |        |       |       |  |  |        |       |       |  |  |        |       |       |  |  |                    |  |       |     |     |     |                                    |        |       |       |  |       |        |       |       |  |       |        |       |       |  |       |               |  |     |     |     |                                    |        |       |       |  |        |       |       |  |        |       |       |  |     |                        |
|   | V-W(Ω) | 1.866   | 0.868              |                        | 0.483 |       |       |     |     |     |     |                                    |        |       |  |       |  |       |  |  |        |       |  |       |  |       |  |  |        |       |  |       |  |       |  |  |               |  |     |     |     |     |                                    |        |       |       |  |  |        |       |       |  |  |        |       |       |  |  |                    |  |       |     |     |     |                                    |        |       |       |  |       |        |       |       |  |       |        |       |       |  |       |               |  |     |     |     |                                    |        |       |       |  |        |       |       |  |        |       |       |  |     |                        |
| 3-phase model                           |        | 4hp   | 5hp                | 6hp                    |       |       |       |     |     |     |     |                                    |        |       |  |       |  |       |  |  |        |       |  |       |  |       |  |  |        |       |  |       |  |       |  |  |               |  |     |     |     |     |                                    |        |       |       |  |  |        |       |       |  |  |        |       |       |  |  |                    |  |       |     |     |     |                                    |        |       |       |  |       |        |       |       |  |       |        |       |       |  |       |               |  |     |     |     |                                    |        |       |       |  |        |       |       |  |        |       |       |  |     |                        |
| Standard winding of the compressor      | U-V(Ω) | 1.948   | 1.061              |                        |       |       |       |     |     |     |     |                                    |        |       |  |       |  |       |  |  |        |       |  |       |  |       |  |  |        |       |  |       |  |       |  |  |               |  |     |     |     |     |                                    |        |       |       |  |  |        |       |       |  |  |        |       |       |  |  |                    |  |       |     |     |     |                                    |        |       |       |  |       |        |       |       |  |       |        |       |       |  |       |               |  |     |     |     |                                    |        |       |       |  |        |       |       |  |        |       |       |  |     |                        |
|   | U-W(Ω) | 2.018   | 1.079              |                        |       |       |       |     |     |     |     |                                    |        |       |  |       |  |       |  |  |        |       |  |       |  |       |  |  |        |       |  |       |  |       |  |  |               |  |     |     |     |     |                                    |        |       |       |  |  |        |       |       |  |  |        |       |       |  |  |                    |  |       |     |     |     |                                    |        |       |       |  |       |        |       |       |  |       |        |       |       |  |       |               |  |     |     |     |                                    |        |       |       |  |        |       |       |  |        |       |       |  |     |                        |
|   | V-W(Ω) | 1.945   | 1.050              |                        |       |       |       |     |     |     |     |                                    |        |       |  |       |  |       |  |  |        |       |  |       |  |       |  |  |        |       |  |       |  |       |  |  |               |  |     |     |     |     |                                    |        |       |       |  |  |        |       |       |  |  |        |       |       |  |  |                    |  |       |     |     |     |                                    |        |       |       |  |       |        |       |       |  |       |        |       |       |  |       |               |  |     |     |     |                                    |        |       |       |  |        |       |       |  |        |       |       |  |     |                        |
|   |        |   | No                 | 9-1                    |       |       |       |     |     |     |     |                                    |        |       |  |       |  |       |  |  |        |       |  |       |  |       |  |  |        |       |  |       |  |       |  |  |               |  |     |     |     |     |                                    |        |       |       |  |  |        |       |       |  |  |        |       |       |  |  |                    |  |       |     |     |     |                                    |        |       |       |  |       |        |       |       |  |       |        |       |       |  |       |               |  |     |     |     |                                    |        |       |       |  |        |       |       |  |        |       |       |  |     |                        |
| 9 Check the HIC PC boards               | 9-1    | Replace the HIC PC board and operate the unit. (Apply putty and screws must not be loose) Does it operate normally?   | Yes                | See what happens.      |       |       |       |     |     |     |     |                                    |        |       |  |       |  |       |  |  |        |       |  |       |  |       |  |  |        |       |  |       |  |       |  |  |               |  |     |     |     |     |                                    |        |       |       |  |  |        |       |       |  |  |        |       |       |  |  |                    |  |       |     |     |     |                                    |        |       |       |  |       |        |       |       |  |       |        |       |       |  |       |               |  |     |     |     |                                    |        |       |       |  |        |       |       |  |        |       |       |  |     |                        |
|   |        |   | No                 | 10-1                   |       |       |       |     |     |     |     |                                    |        |       |  |       |  |       |  |  |        |       |  |       |  |       |  |  |        |       |  |       |  |       |  |  |               |  |     |     |     |     |                                    |        |       |       |  |  |        |       |       |  |  |        |       |       |  |  |                    |  |       |     |     |     |                                    |        |       |       |  |       |        |       |       |  |       |        |       |       |  |       |               |  |     |     |     |                                    |        |       |       |  |        |       |       |  |        |       |       |  |     |                        |
| 10 Check the outdoor unit main PC board | 10-1   | Replace the control PC board and operate the unit.  | See what happens.  |                        |       |       |       |     |     |     |     |                                    |        |       |  |       |  |       |  |  |        |       |  |       |  |       |  |  |        |       |  |       |  |       |  |  |               |  |     |     |     |     |                                    |        |       |       |  |  |        |       |       |  |  |        |       |       |  |  |                    |  |       |     |     |     |                                    |        |       |       |  |       |        |       |       |  |       |        |       |       |  |       |               |  |     |     |     |                                    |        |       |       |  |        |       |       |  |        |       |       |  |     |                        |

- (Check content of 7) The test check of the HIC board is only a check on the output level, so the input stage may not be working.
- With the filter board broken, alarm P16 may not be triggered.

• **HIC board IPM Pass/Fail Tests**

- Measure with an analog tester. (Set to the k ohm range.)
- Measure the board by itself. (Remove wires connected from other parts.)
- Measure using IPM terminals.

★ **Conforming part resistance value (measure with an analog tester)**

|                        |            |            |            |             |            |            |            |            |
|------------------------|------------|------------|------------|-------------|------------|------------|------------|------------|
| Tester terminals       |            |            |            |             |            |            |            |            |
| +                      | P          |            |            |             | NU         |            |            |            |
| -                      | U          | V          | W          | NU          | U          | V          | W          | P          |
| Resistance value (ohm) | 1 k to 5 k | 1 k to 5 k | 1 k to 5 k | 5 k to 10 k | 100 k to ∞ | 100 k to ∞ | 100 k to ∞ | 100 k to ∞ |

|                        |            |            |            |  |            |            |            |  |
|------------------------|------------|------------|------------|--|------------|------------|------------|--|
| Tester terminals       |            |            |            |  |            |            |            |  |
| -                      | P          |            |            |  | NU         |            |            |  |
| +                      | U          | V          | W          |  | U          | V          | W          |  |
| Resistance value (ohm) | 100 k to ∞ | 100 k to ∞ | 100 k to ∞ |  | 1 k to 5 k | 1 k to 5 k | 1 k to 5 k |  |

- Excepting the parts of "100 k to ∞", it is acceptable if a small resistance value appears as a reference value unless the value is "0 = short-circuit".

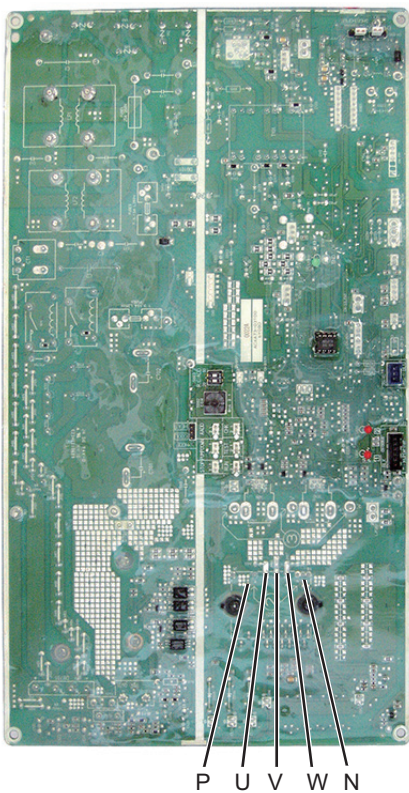
|                        |             |             |             |             |           |           |           |           |
|------------------------|-------------|-------------|-------------|-------------|-----------|-----------|-----------|-----------|
| Tester terminals       |             |             |             |             |           |           |           |           |
| +                      | HIC+        |             |             |             | HIC-      |           |           |           |
| -                      | U           | V           | W           | HIC-        | U         | V         | W         | HIC+      |
| Resistance value (ohm) | 1 k to 10 k | 1 k to 10 k | 1 k to 10 k | 5 k to 20 k | 20 k to ∞ | 20 k to ∞ | 20 k to ∞ | 20 k to ∞ |

|                        |           |           |           |  |             |             |             |  |
|------------------------|-----------|-----------|-----------|--|-------------|-------------|-------------|--|
| Tester terminals       |           |           |           |  |             |             |             |  |
| -                      | HIC+      |           |           |  | HIC-        |             |             |  |
| +                      | U         | V         | W         |  | U           | V           | W           |  |
| Resistance value (ohm) | 20 k to ∞ | 20 k to ∞ | 20 k to ∞ |  | 1 k to 10 k | 1 k to 10 k | 1 k to 10 k |  |

- Excepting the parts of "20 k to ∞", it is acceptable if a small resistance value appears as a reference value unless the value is "0 = short-circuit".

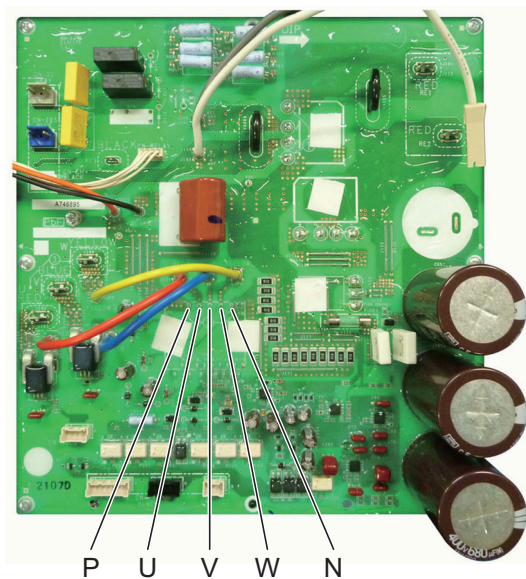
■ Outdoor Unit Control PCB

ACXA73-03100 : Bottom side  
(U-36PE2E5A, U-50PE2E5A, U-60PE2E5A)  
(U-60PEY2E5, U-71PEY2E5)  
(for single-phase outdoor unit PCB)



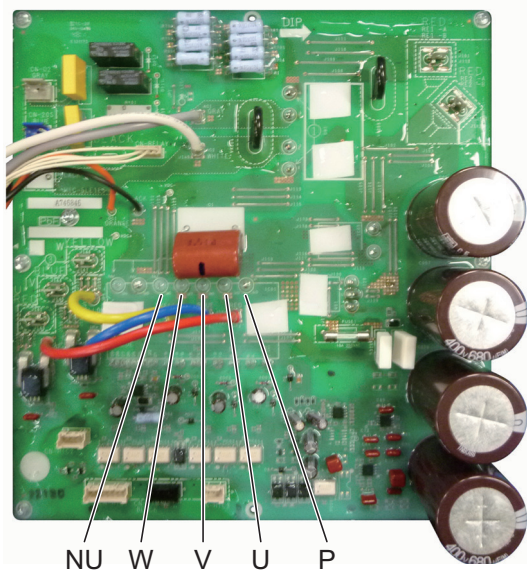
■ Outdoor Unit Control HIC PCB

A746895 : (U-71PE1E5A)  
(for single-phase outdoor unit HIC PCB)

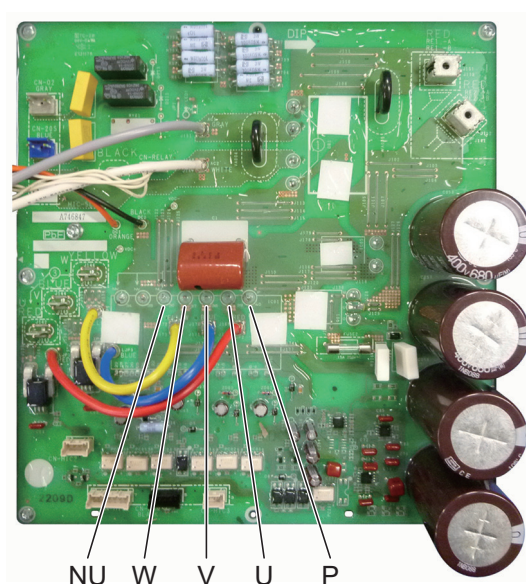


■ Outdoor Unit Control HIC PCB

A746846 : (U-100PE1E5A)  
(for single-phase outdoor unit HIC PCB)

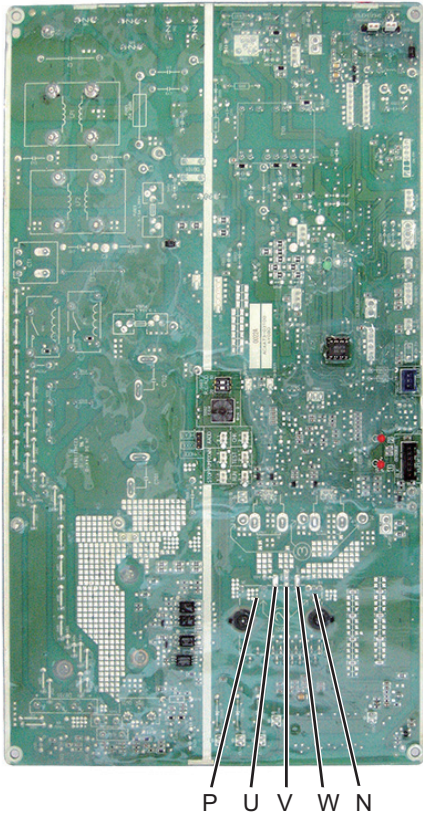


A746847 : (U-125PE1E5A, U-140PE1E5A)  
(for single-phase outdoor unit HIC PCB)



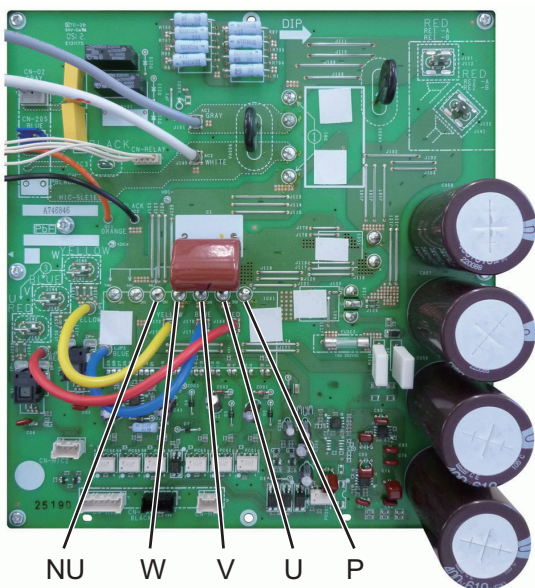
■ Outdoor Unit Control PCB

ACXA73-03100 : Bottom side  
(U-36PE2E5A, U-50PE2E5A, U-60PE2E5A)  
(U-60PEY2E5, U-71PEY2E5)  
(for single-phase outdoor unit PCB)

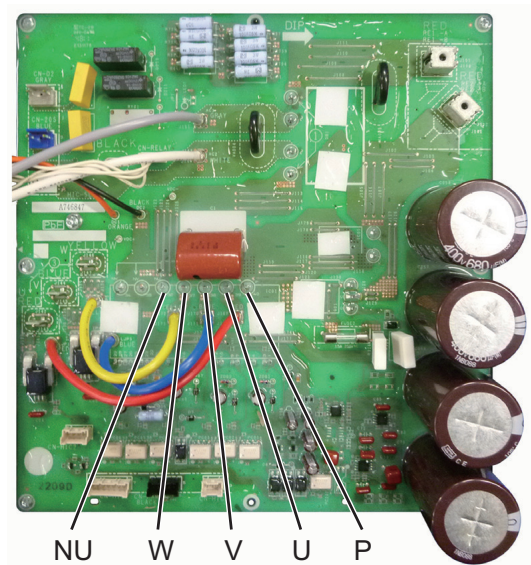


■ Outdoor Unit Control HIC PCB

A746846 : (U-100PEY1E5)  
(for single-phase outdoor unit HIC PCB)



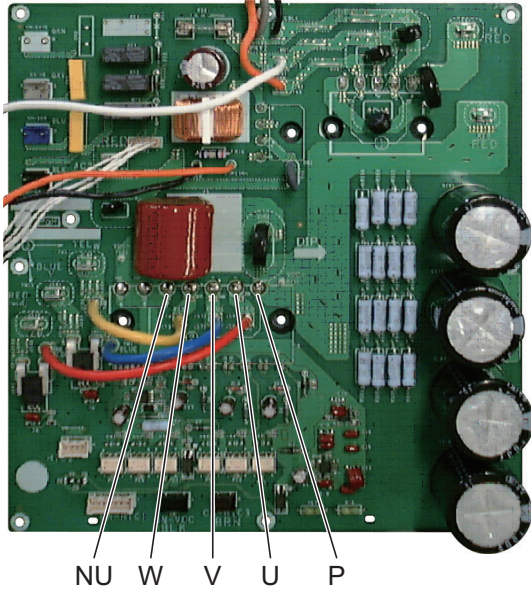
A746847 : (U-125PEY1E5)  
(for single-phase outdoor unit HIC PCB)



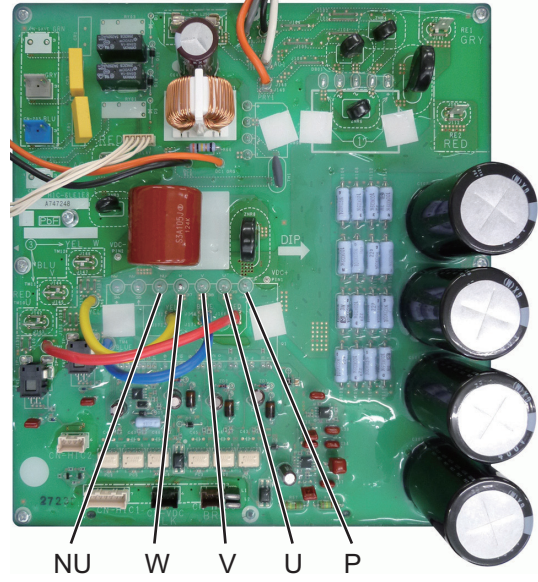
■ Outdoor Unit Control HIC PCB

A746970 : (U-71PE1E8A)

A746969 : (U-100PE1E8A, U-125PE1E8A,  
U-140PE1E8A, U-140PEY1E8)  
(for 3-phase outdoor unit HIC PCB)



A747248 : (U-100PEY1E8, U-125PEY1E8)  
(for 3-phase outdoor unit HIC PCB)





## P22 Outdoor Unit Fan Motor Trouble

### 1. Error Detection Method

- It is judged an error when the outdoor fan motor's rotating signal cannot be detected normally.

### 2. Error Diagnosis

|                            |     |   |     |                                   |
|----------------------------|-----|---|-----|-----------------------------------|
| 1 Wiring                   | 1-1 | Are the connectors "CN-FMA", "CN-FMB", "CN-FM1", and "CN-FM2", "CN-FM" firmly connected to the outdoor control PC board (lock engaged)?   | Yes | 2-1                               |
|                            |     |   | No  | Correct the connector connections |
| 2 Outdoor fan motor        | 2-1 | Disconnect the connectors "CN-FMA", "CN-FMB", "CN-FM1", and "CN-FM2", "CN-FM" from the outdoor control PC board and the outdoor fan by hand; does it rotate freely? rotate (Check the outdoor fan motor lock) | Yes | 3-1                               |
|                            |     |   | No  | Replace the outdoor fan motor     |
| 3 Outdoor control PC board | 3-1 | Turn the power on and run the unit again; is P22 triggered again? Or can you see or hear anything that is obviously wrong in its rotation?  | Yes | 3-2                               |
|                            |     |   | No  | 3-3                               |
|                            | 3-2 | Replace the outdoor control PC board. (If it fails to operate normally even after replacing the outdoor control PC board, replace the outdoor fan motor.)   |     |                                   |
|                            | 3-3 | If there is nothing particularly out of the ordinary, see what happens.   |     |                                   |

**P29 Lack of INV compressor wiring, INV compressor actuation failure (including locked), DCCT failure**

**U-36PE2E5A, U-50PE2E5A, U-60PE2E5A  
U-60PEY2E5, U71PEY2E5**

**1. Error Detection Method**

- Abnormal current is detected at DCCT before start-up.
- Start-up failed during overcurrent and/or step-out detected.
- Open-wire of compressor and/or backspin detected.
- Secondary current is not detected during INV compressor is running.

**2. Error Diagnosis**

|                               |     |  |                                |  |
|-------------------------------|-----|--|--------------------------------|--|
| 1<br>Compressor wiring        | 1-1 | Disconnections and/or miswiring is observed in the connections of the compressor terminals. *1                                       | Yes                            | Correct  |
|                               |     |  | No                             | 1-2  |
|                               | 1-2 | Conditions such as burned terminal covers and/or discolored terminals are observed at the connectors of the compressor terminals. *1 | Yes                            | Eliminate looseness by changing terminals or crimping terminals. |
|                               |     |  | No                             | 2-1  |
| 2<br>Refrigerant circuit      | 2-1 | Overload operation under operating pressure  | Yes                            | 2-2 or reduce overload.  |
|                               |     |  | No                             | 2-3  |
|                               | 2-2 | Overfilled refrigerant (Tubing length of indoor and outdoor units is extremely shorter than the standards.)                          | Yes                            | Adjust refrigerant amount and tubing length.                     |
|                               |     | No   | 2-3                            |  |
|                               | 2-3 | Small amount of refrigerant (Out of gas)   | Yes                            | Adjust refrigerant amount.                                       |
|                               |     |  | No                             | 3-1  |
| 3<br>Compressor               | 3-1 | Insulation failure of compressor<br>Check earth fault of compressor.   | Yes                            | Replace compressor.  |
|                               |     |  | No                             | 3-2  |
|                               | 3-2 | Winding resistance of compressor is abnormal.  | Yes                            | Replace compressor.  |
|                               |     |  | No                             | 4-1  |
| 4<br>Outdoor control PC board | 4-1 | Determination result of pass / fail for the outdoor control PC board IPM is outside range of the conforming part resistance value.   | Yes                            | Replace electrical component box                                 |
|                               |     |  | No                             | 4-2  |
|                               | 4-2 | Replace the electrical component box and operate the unit. (No looseness of screw)   | Watch the situation carefully. |  |

\*1 Checking for looseness of compressor terminals by wiggling them has the adverse effect of loosening them. Don't try it. Evaluate them by discoloration of wire insulation near the terminal.

**• Determination of pass / fail for outdoor control PC board IPM**

- Measure with an analog tester. (Set to k ohm range.)
- Measure the board by itself. (Remove wires connected from other parts.)
- Measure using IPM terminals.

**★ Conforming part resistance value (Measure with an analog tester.)**

|                        |             |             |             |             |           |           |           |           |
|------------------------|-------------|-------------|-------------|-------------|-----------|-----------|-----------|-----------|
| Tester terminals       | P           |             |             |             | N         |           |           |           |
| +                      |             |             |             |             |           |           |           |           |
| -                      | U           | V           | W           | N           | U         | V         | W         | P         |
| Resistance value (ohm) | 1 k to 10 k | 1 k to 10 k | 1 k to 10 k | 5 k to 20 k | 10 k to ∞ | 10 k to ∞ | 10 k to ∞ | 10 k to ∞ |

|                        |           |           |           |  |             |             |             |  |
|------------------------|-----------|-----------|-----------|--|-------------|-------------|-------------|--|
| Tester terminals       | P         |           |           |  | N           |             |             |  |
| -                      |           |           |           |  |             |             |             |  |
| +                      | U         | V         | W         |  | U           | V           | W           |  |
| Resistance value (ohm) | 10 k to ∞ | 10 k to ∞ | 10 k to ∞ |  | 1 k to 10 k | 1 k to 10 k | 1 k to 10 k |  |

• Excepting the parts of "10 k to ∞", it is acceptable if a small resistance value appears as a reference value unless the value is "0 = short-circuit".

|                        |             |             |             |             |           |           |           |           |
|------------------------|-------------|-------------|-------------|-------------|-----------|-----------|-----------|-----------|
| Tester terminals       | HIC+        |             |             |             | HIC-      |           |           |           |
| +                      |             |             |             |             |           |           |           |           |
| -                      | U           | V           | W           | HIC-        | U         | V         | W         | HIC+      |
| Resistance value (ohm) | 1 k to 10 k | 1 k to 10 k | 1 k to 10 k | 5 k to 20 k | 20 k to ∞ | 20 k to ∞ | 20 k to ∞ | 20 k to ∞ |

|                        |           |           |           |  |             |             |             |  |
|------------------------|-----------|-----------|-----------|--|-------------|-------------|-------------|--|
| Tester terminals       | HIC+      |           |           |  | HIC-        |             |             |  |
| -                      |           |           |           |  |             |             |             |  |
| +                      | U         | V         | W         |  | U           | V           | W           |  |
| Resistance value (ohm) | 20 k to ∞ | 20 k to ∞ | 20 k to ∞ |  | 1 k to 10 k | 1 k to 10 k | 1 k to 10 k |  |

• Excepting the parts of "20 k to ∞", it is acceptable if a small resistance value appears as a reference value unless the value is "0 = short-circuit".

**U-71PE1E5A ~ U-140PE1E5A / U-71PE1E8A ~ U-140PE1E8A  
U-100PEY1E5, U-125PEY1E5 / U-100PEY1E8 ~ U-140PEY1E8**

**1. Error Detection Method**

- Abnormal current is detected at DCCT before start-up.
- Start-up failed during overcurrent and/or step-out detected.
- Open-wire of compressor and/or backspin detected.
- Secondary current is not detected during INV compressor is running.

**2. Error Diagnosis**

|                                      |     |  |                   |   |
|--------------------------------------|-----|--|-------------------|---|
| 1 Wiring                             | 1-1 | Disconnected parts, miswiring and/or poor connections (loose) are observed in the connections of HIC PC board(s) that are connected by wiring to a compressor. *1        | Yes               | Correct wiring connections  |
|                                      |     |  | No                | 1-2   |
|                                      | 1-2 | Disconnected parts, miswiring and/or poor connections (loose) are observed in the connections of outdoor board(s) that are connected by wiring from the HIC PC board. *1 | Yes               | Correct wiring connections  |
|                                      |     |  | No                | 2-1   |
| 2 Compressor wiring                  | 2-1 | Disconnections and/or miswiring is observed in the connections of the compressor terminals. *1   | Yes               | Correct   |
|                                      |     |  | No                | 2-2   |
|                                      | 2-2 | Conditions such as burned terminal covers and/or discolored terminals are observed at the connectors of the compressor terminals. *1                                     | Yes               | Eliminate looseness by changing the terminals, or crimping the terminals again. |
|                                      |     |  | No                | 3-1   |
| 3 Check the HIC PC boards            | 3-1 | The results of the pass/fail tests for the following HIC PC board IPM show it to be outside the range of the resistance of a conforming part.                            | Yes               | Replace the HIC board   |
|                                      |     |  | No                | 3-2   |
|                                      | 3-2 | Replace the HIC PC board and operate the unit. (Apply putty and screws must not be loose) Does it operate normally?  | Yes               | See what happens.   |
|                                      |     |  | No                | 4-1   |
| 4 Check the outdoor control PC board | 4-1 | Replace the control PC board and operate the unit.   | See what happens. |   |

\*1 Checking for looseness of compressor terminals by wiggling them has the adverse effect of loosening them, so do not do it. Evaluate them by discoloration of wire insulation near the terminal.

**• HIC board IPM Pass/Fail Tests**

- Measure with an analog tester. (Set to the k ohm range)
- Measure the board by itself. (Remove wires connected from other parts.)
- Measure using IPM terminals.

**★ Conforming part resistance value (measure with an analog tester)**

|                        |            |            |            |             |            |            |            |            |
|------------------------|------------|------------|------------|-------------|------------|------------|------------|------------|
| Tester terminals       | P          |            |            |             | NU         |            |            |            |
| +                      | P          |            |            |             | NU         |            |            |            |
| -                      | U          | V          | W          | NU          | U          | V          | W          | P          |
| Resistance value (ohm) | 1 k to 5 k | 1 k to 5 k | 1 k to 5 k | 5 k to 10 k | 100 k to ∞ | 100 k to ∞ | 100 k to ∞ | 100 k to ∞ |

|                        |            |            |            |  |            |            |            |  |
|------------------------|------------|------------|------------|--|------------|------------|------------|--|
| Tester terminals       | P          |            |            |  | NU         |            |            |  |
| -                      | P          |            |            |  | NU         |            |            |  |
| +                      | U          | V          | W          |  | U          | V          | W          |  |
| Resistance value (ohm) | 100 k to ∞ | 100 k to ∞ | 100 k to ∞ |  | 1 k to 5 k | 1 k to 5 k | 1 k to 5 k |  |

• Excepting the parts of "100 k to ∞", it is acceptable if a small resistance value appears as a reference value unless the value is "0 = short-circuit".

|                        |             |             |             |             |           |           |           |           |
|------------------------|-------------|-------------|-------------|-------------|-----------|-----------|-----------|-----------|
| Tester terminals       | HIC+        |             |             |             | HIC-      |           |           |           |
| +                      | HIC+        |             |             |             | HIC-      |           |           |           |
| -                      | U           | V           | W           | HIC-        | U         | V         | W         | HIC+      |
| Resistance value (ohm) | 1 k to 10 k | 1 k to 10 k | 1 k to 10 k | 5 k to 20 k | 20 k to ∞ | 20 k to ∞ | 20 k to ∞ | 20 k to ∞ |

|                        |           |           |           |  |             |             |             |  |
|------------------------|-----------|-----------|-----------|--|-------------|-------------|-------------|--|
| Tester terminals       | HIC+      |           |           |  | HIC-        |             |             |  |
| -                      | HIC+      |           |           |  | HIC-        |             |             |  |
| +                      | U         | V         | W         |  | U           | V           | W           |  |
| Resistance value (ohm) | 20 k to ∞ | 20 k to ∞ | 20 k to ∞ |  | 1 k to 10 k | 1 k to 10 k | 1 k to 10 k |  |

• Excepting the parts of "20 k to ∞", it is acceptable if a small resistance value appears as a reference value unless the value is "0 = short-circuit".

## P31 Group Control Error

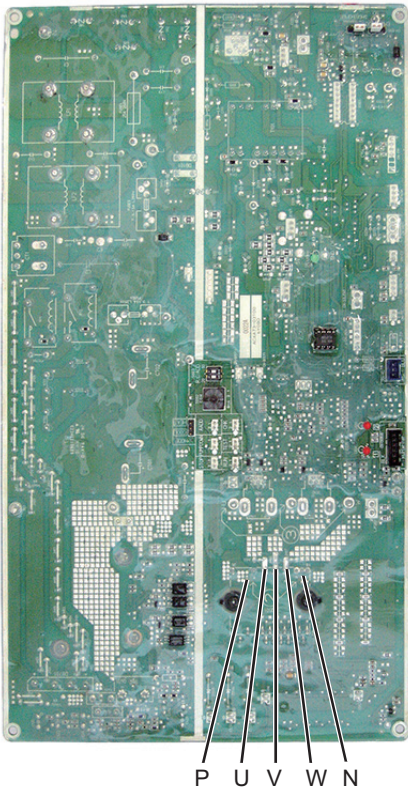
### 1. Error Detection Method

- Other indoor unit alarms within the group.

|                     |     |   |
|---------------------|-----|---|
| 1 Other indoor unit | 1-1 | Survey the indoor unit that alarms other than "P31" in the indoor unit group and specify the causes of failure. |
|---------------------|-----|---|

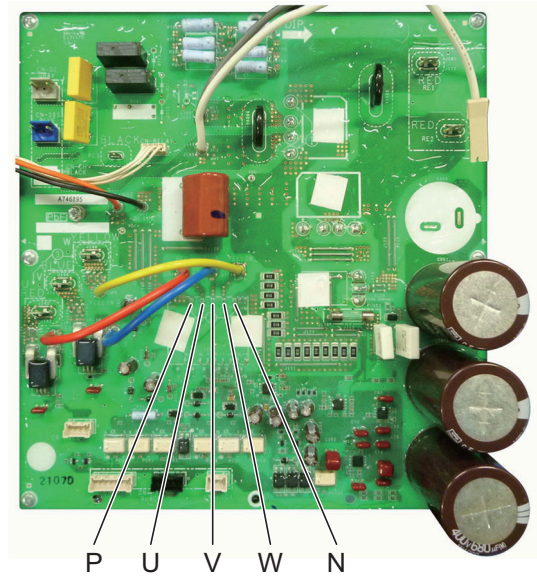
■ Outdoor Unit Control PCB

ACXA73-03100 : Bottom side  
 (U-36PE2E5A, U-50PE2E5A, U-60PE2E5A)  
 (U-60PEY2E5, U-71PEY2E5)  
 (for single-phase outdoor unit PCB)



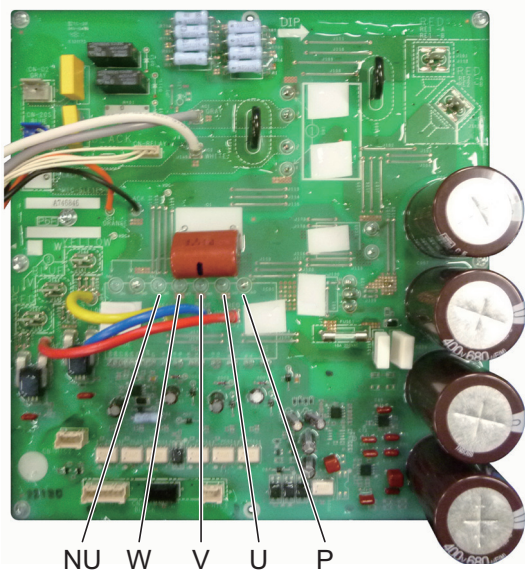
■ Outdoor Unit Control HIC PCB

A746895 : (U-71PE1E5A)  
 (for single-phase outdoor unit HIC PCB)

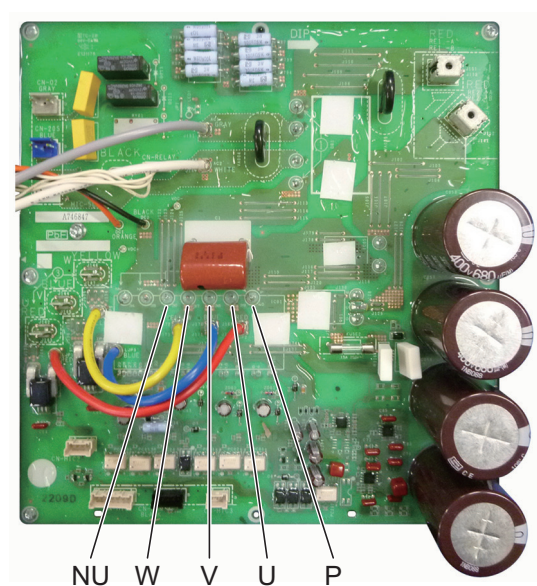


■ Outdoor Unit Control HIC PCB

A746846 : (U-100PE1E5A)  
 (for single-phase outdoor unit HIC PCB)

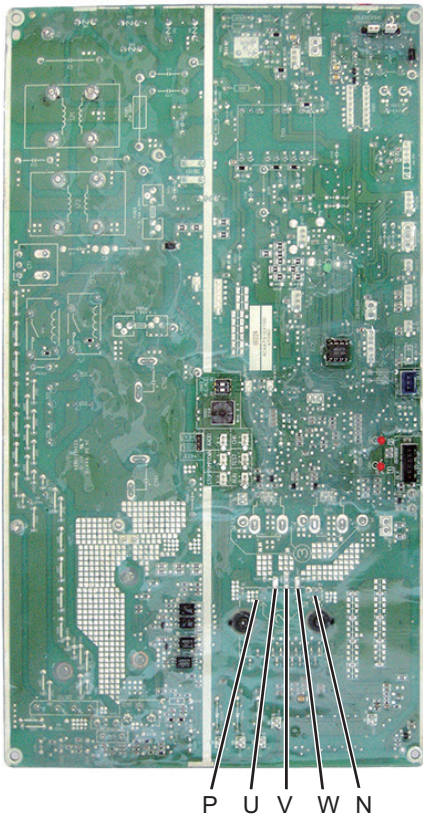


A746847 : (U-125PE1E5A, U-140PE1E5A)  
 (for single-phase outdoor unit HIC PCB)



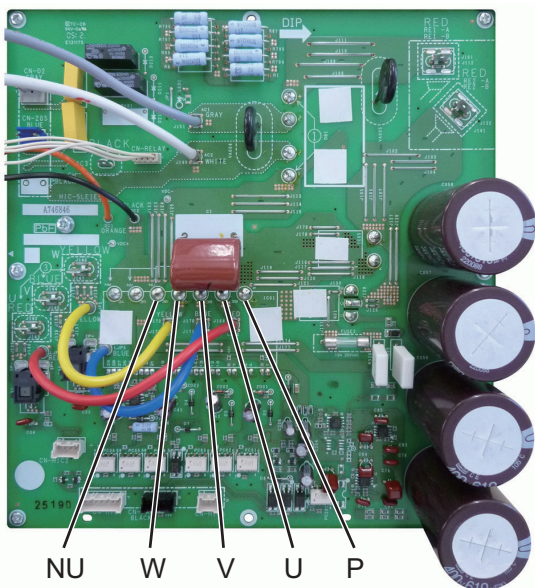
■ Outdoor Unit Control PCB

ACXA73-03100 : Bottom side  
 (U-36PE2E5A, U-50PE2E5A, U-60PE2E5A)  
 (U-60PEY2E5, U-71PEY2E5)  
 (for single-phase outdoor unit PCB)

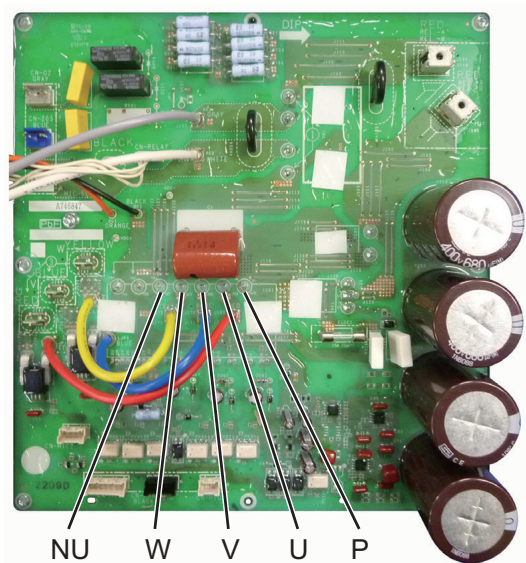


■ Outdoor Unit Control VHC PCB

A746846 : (U-100PEY1E5)  
 (for single-phase outdoor unit VHC PCB)



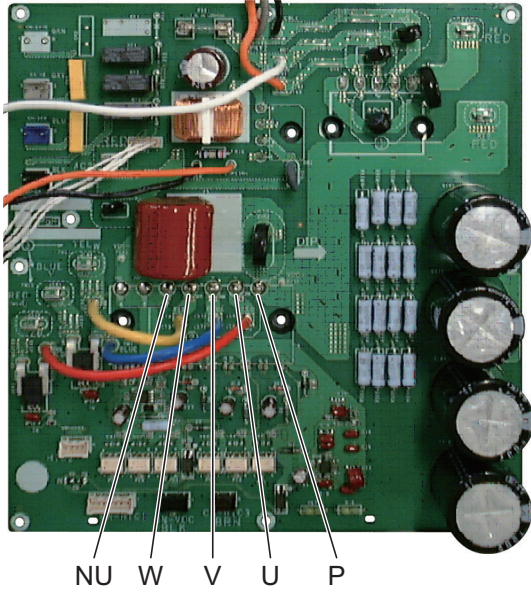
A746847 : (U-125PEY1E5)  
 (for single-phase outdoor unit VHC PCB)



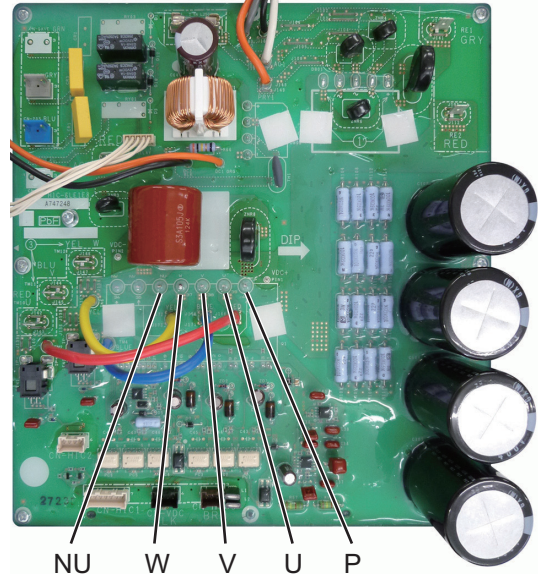
■ Outdoor Unit Control HIC PCB

A746970 : (U-71PE1E8A)

A746969 : (U-100PE1E8A, U-125PE1E8A,  
U-140PE1E8A, U-140PEY1E8)  
(for 3-phase outdoor unit HIC PCB)



A747248 : (U-100PEY1E8, U-125PEY1E8)  
(for 3-phase outdoor unit HIC PCB)



## 5-4. Inspection of Parts (Outdoor Unit)

### (1) Electronic control valve (MOV1)

- MOV1: Measure the voltage between plug pin 5 and pins 1 through 4 at the CN-MOV1 connector (5P, white) on the outdoor unit control PCB. (Because of the pulse output, a simplified measurement method is used. Set the tester to the 12 V range; if the value displayed is approximately 4 V, then the voltage is normal.)  
If the voltage is normal, measure the resistance between connector pin 5 and pins 1 through 4.  
Resistance between pin 5 and pins 1 through 4 should be approximately  $46\ \Omega$  for all. (If the result is  $0\ \Omega$  or,  $\infty$  then replace the coil.)



## 5-5. Symptom: Thermostat in OFF continues or cycles OFF & ON too frequently

### 1. How to detect abnormality

- Abnormality does not occur. Protective function can be checked when the outdoor maintenance remote controller is connected.

### 2. Error Diagnosis

|                            |                    |   |                |  |
|----------------------------|--------------------|---|----------------|--|
| 1 Indoor control PC board  | 1-1                | Setting temperature reaches the level set ON thermostat. Setting temperature is too low in heating mode and too high in cooling and dry mode.   | Yes            | Adjust setting temperature                 |
|                            |                    |   | No             | 1-2  |
|                            | 1-2                | Check if the sensors are connected correctly. Are all connection made properly? Room temp. (TA) in yellow, heat exchanger (E1) in red, heat exchanger (E2) in black, heat exchanger (E3) in brown, air outlet (BL) in green | Yes            | Connect correctly                          |
|                            |                    |   | No             | 1-3  |
|                            | 1-3                | DISP (display mode) is applied.   | Yes            | Turn OFF(OPEN)                             |
|                            |                    |   | No             | 1-4  |
|                            | 1-4                | With a thermostat OFF in heating mode, wind speed (item code 05) is out of range 0 - 6. (Use Simple Setting Function on standard timer remote controller.)  | Yes            | Choose one of 0 to 6                       |
|                            |                    |   | No             | 1-5  |
|                            | 1-5                | DEMAND is applied.  | Yes            | Turn OFF(OPEN)                             |
|                            |                    |   | No             | 2-1  |
| 2 Outdoor control PC board | 2-1                | Outdoor unit and protective function of a system are operating. (Connect outdoor maintenance remote controller to RC socket on outdoor unit main control PC board and check alarm messages.)                                | Yes            | See operational status                     |
|                            |                    |   | No             | 2-2  |
|                            | 2-2                | Discharge temperature is over 80°C in stop mode and does not decrease. (Connect outdoor maintenance remote controller to RC socket on outdoor unit main control PC board and check alarm messages.)                         | Yes            | Replace discharge temperature sensor       |
|                            |                    |   | No             | 2-3  |
|                            | 2-3                | Demand value always stays low. (The value is lower than 70. Excluding -1 (unlimited))(Connect outdoor maintenance remote controller to RC socket on outdoor unit main control PC board and check alarm messages.)           | Yes            | Increase values (over 70)                  |
|                            |                    |   | No             | 2-4  |
| 2-4                        | DEMAND is applied. | Yes   | Turn OFF(OPEN) |  |
| 3 Control equipment        | 3-1                | Demand setting is made by control units (P-AIMS, Seri-Para I/O unit for outdoor unit, Seri-Para I/O each indoor unit.)  | Yes            | Turn OFF                                   |
|                            |                    |   | No             | 4-1  |
| 4 System                   | 4-1                | When operating in cooling (including auto cooling & heating) and dry mode, lowest temp. of indoor E1, E2 and E3 sensor is less than 2°C (under anti-freeze control).  | Yes            | Wait until more than 2°C reaches           |
|                            |                    |   | No             | 4-2  |
|                            | 4-2                | During defrosting operation   | Yes            | Wait for a few minutes to 10 minutes or so |
|                            |                    |   | No             | 4-3  |
|                            | 4-3                | Outdoor unit PC board failure → Replacement   |                |  |

- According to a type of model, the indoor sensors will not be supplied in some cases.
- According to a type of model, the outdoor DEMAND will not be supplied in some cases.
- When LINE Checker is used, the temperature sensors can be observed (display, record) simultaneously.
- According to some areas, some of the models are unreleased.

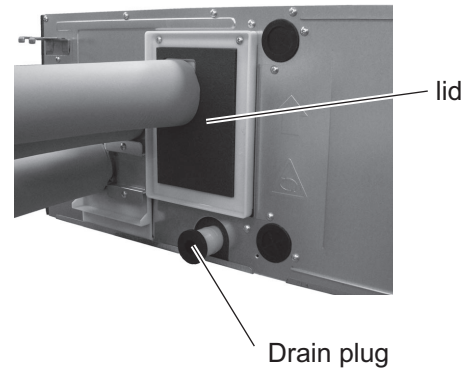
## 5-6. How to Clean Heat Exchanger

1. Turn off the power supply.

### WARNING

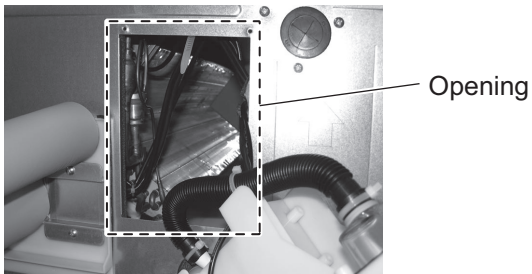


**ELECTRICAL SHOCK CAN CAUSE SEVERE PERSONAL INJURY OR DEATH.**

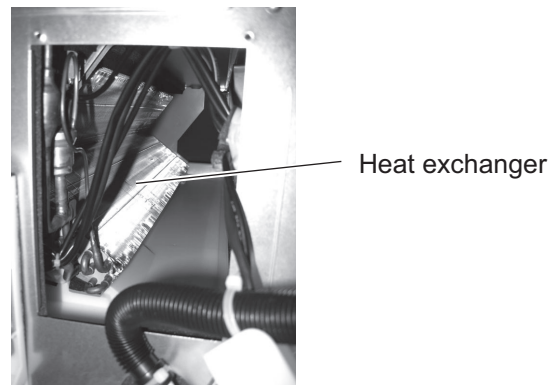


**Fig. 5-1**

2. Remove the lid (drain pump). (Fig. 5-1)
3. Remove the drain plug and drain the water from the drain pan. (Fig. 5-1)
4. Insert a high pressure cleaner from the opening (Fig. 5-2a) and clean the heat exchanger. (Fig. 5-2b)



**Fig. 5-2a**



**Fig. 5-2b**

5. When finished cleaning, install the drain plug and lid (drain pump).

## 5-7. How to Replace Fan Motor

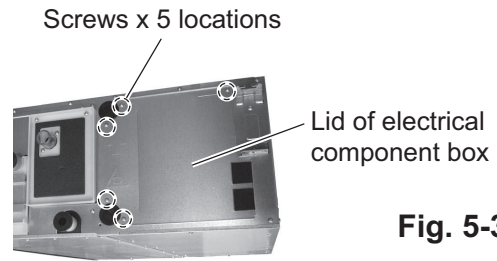
### Removing Fan Motor

1. Turn off the power supply.

**WARNING**

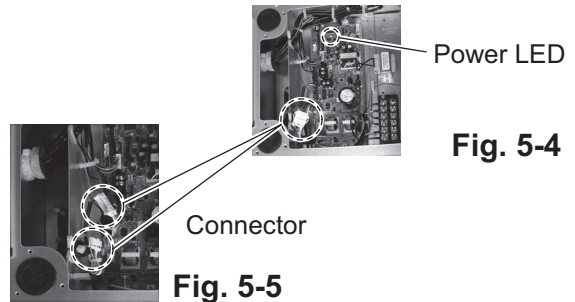


**ELECTRICAL SHOCK CAN CAUSE SEVERE PERSONAL INJURY OR DEATH.**



**Fig. 5-3**

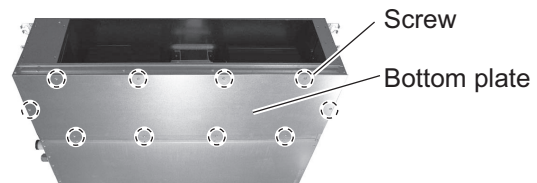
2. Remove the lid of the electrical component box. (Screws x 5 locations: Fig. 5-3)  
Make sure the PC board should not be electrified. Power supply LED should be lit off on PC board. (Fig. 5-4)



**Fig. 5-4**

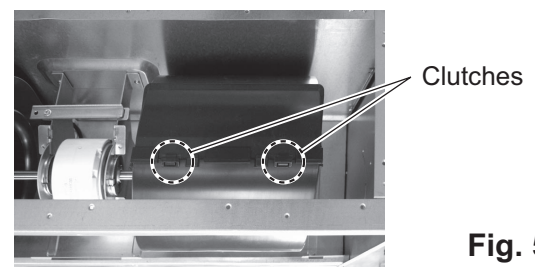
3. Disconnect the interconnector in the middle of the wiring to the fan motor. (Fig. 5-5)

4. Remove the bottom plate. (Fig. 5-6)

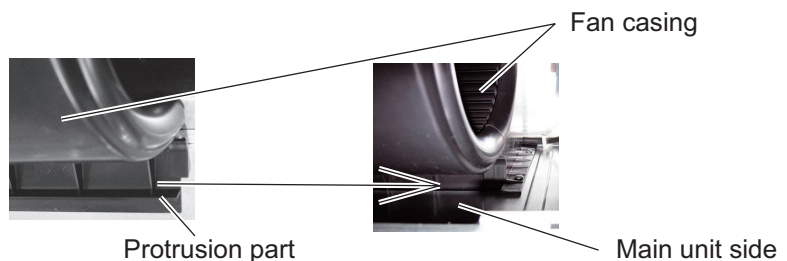


**Fig. 5-6**

5. Disconnect two (2) clutches (Fig. 5-7a) fixing the lower side of the fan casing and pull out the protrusion part (Fig. 5-7c) placed onto the side of the main unit (Fig. 5-7b). Then remove the fan casing.



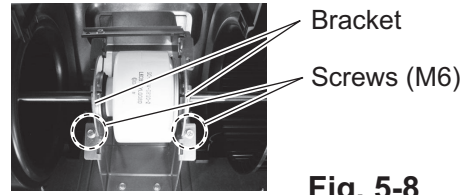
**Fig. 5-7a**



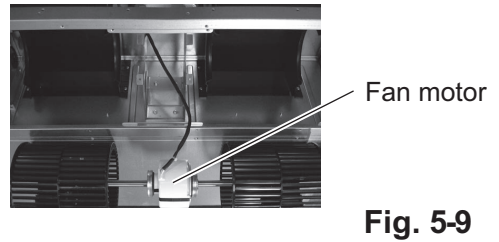
**Fig. 5-7c**

**Fig. 5-7b**

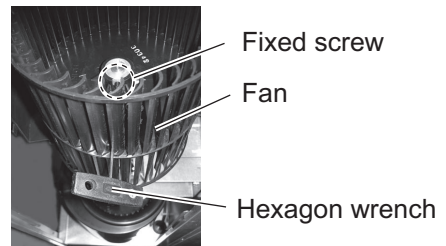
6. Remove the screws (M6 x2 locations: Fig. 5-8) fixing the fan motor. It is recommended that a nutdriver (8mm) be used.



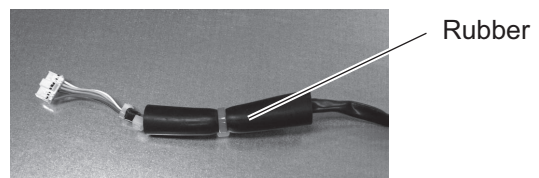
7. Remove the bracket (Fig. 5-8) and then remove the fan and fan motor (Fig. 5-9).



8. Loosen the fixed screw with a hexagon wrench (3mm, over 100mm in length) and remove the fan.



9. Remove the rubber attached to the wiring of the fan motor (Fig. 5-11).



### Installing Fan Motor

1. For installation, reverse the procedure above.
2. Fine tune so that the fan can be positioned in the center of the fan casing.

## 6. OUTDOOR UNIT MAINTENANCE REMOTE CONTROLLER

|      |   |      |
|------|---|------|
| 6-1. | Overview .....  | 6-2  |
| 6-2. | Functions.....  | 6-2  |
| 6-3. | Normal Display Operations and Functions .....   | 6-3  |
| 6-4. | Monitoring Operations: Display of Indoor Unit and Outdoor Unit Sensor<br>Temperatures ..... | 6-8  |
| 6-5. | Monitoring the Outdoor Unit Alarm History: Display of Outdoor Unit<br>Alarm History .....   | 6-10 |
| 6-6. | Settings Modes: Setting the Outdoor Unit EEPROM.....  | 6-11 |

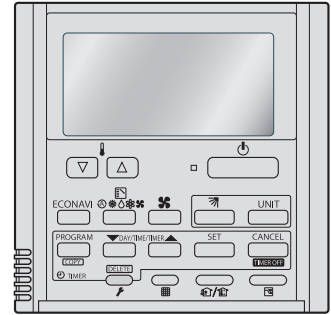
## 6-1. Overview

### What is the outdoor unit maintenance remote controller?

Beginning with the DC-INV series of outdoor units, nonvolatile memory (EEPROM) is used in the outdoor unit PCB. In this way, the setting switches that were located on earlier PCBs have been converted to EEPROM data. This remote controller is an outdoor unit maintenance tool that is used to make and change the EEPROM settings.

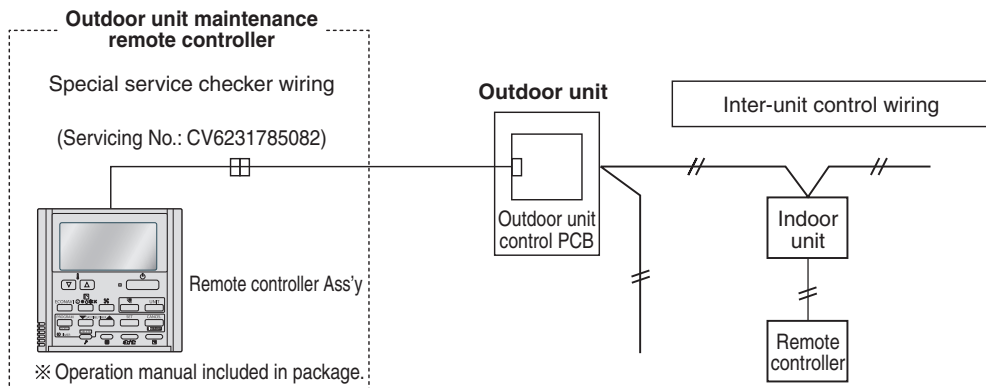
This remote controller can be used for checking the outdoor unit EEPROM settings and contents, and also can be used to monitor the outdoor unit alarm history and indoor/outdoor unit temperatures, and to check the status of the indoor unit connections (No. of units, operating status, etc.).

**Note:** Because this tool does not function as a remote controller, it is used only during test runs and servicing.



CZ-RTC4

### System diagram



- \* The special service checker wiring is required in order to connect the outdoor unit maintenance remote controller to the outdoor unit PCB.
- \* Even when the outdoor unit maintenance remote controller is connected, a separate remote controller or other control device must be connected to the indoor unit.

## 6-2. Functions

### ■ Normal display functions

(1) Functions: Button operations can be used to perform the following functions.

- Start/stop of all indoor units
- Switching between cooling and heating
- Test run of all indoor units
- High-speed operation of indoor units (Do not use with actual units. This may damage the devices.)

(2) Display: The following can be displayed.

- Alarm details display
- No. of indoor/outdoor units
- Unit Nos. of connected indoor/outdoor units
- Indoor/outdoor unit operating status (blinks when an alarm occurs)
- Indoor unit thermostat ON
- Individual display of outdoor unit alarms
- Outdoor unit compressor total operating time
- Outdoor unit total power ON time
- Outdoor unit microcomputer version
- Other

### ■ Temperature monitor

- Displays the indoor/outdoor unit sensor temperatures.

### ■ Outdoor unit alarm history monitor

- Displays the outdoor unit alarm history.

### ■ Setting modes

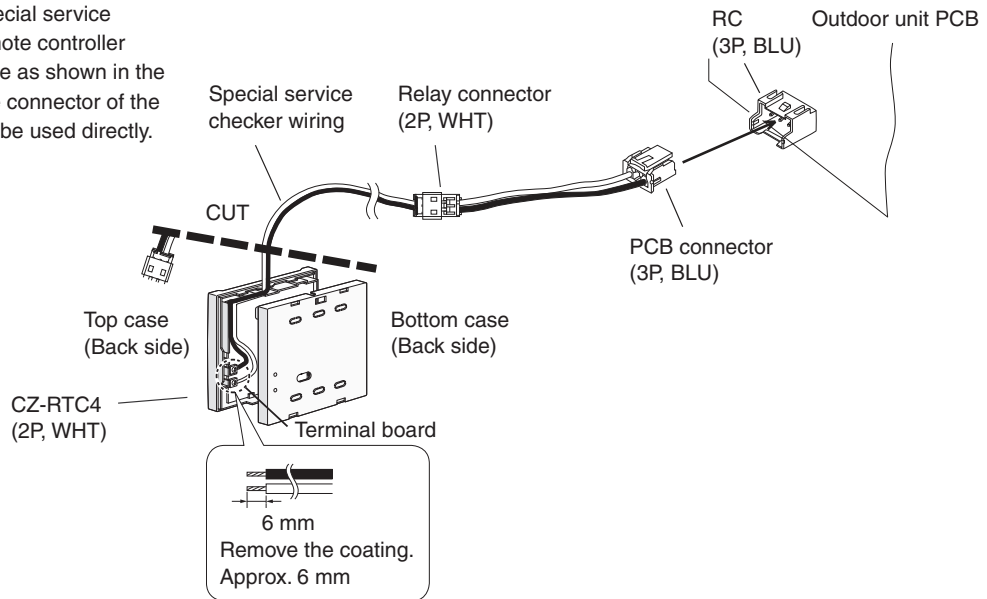
- Setting mode 1 and setting mode 2 are used to make the outdoor EEPROM setting.

## 6-3. Normal Display Operations and Functions

### ■ Normal display functions

- Connect the special service checker wiring to the outdoor unit PCB. The connection is shown in the figure below.


When connecting the special service checker wiring to the remote controller CZ-RTC4, cut out the wire as shown in the figure below because the connector of the remote controller cannot be used directly.



- \* It is not necessary to disconnect the communications line in the inter-unit control wiring if it has already been connected at this time.
- \* Setting modes 1 and 2 can be used even when the outdoor unit is independent (when 1 maintenance remote controller is connected to 1 outdoor unit and automatic address setting for the indoor units has not been completed).
- \* Displays the overall system status for that refrigerant system.

- **All units start/stop (Fig. 6-1)**

<Operation>

The  (Start/Stop operation) button can be used to start and stop all the indoor units.


- The LED illuminates if any indoor units is operating.
- The LED blinks if an alarm at any of the operating indoor units occurs.

- **Cooling/heating change (Fig. 6-1)**

### NOTE

Cooling and heating mode changes are only available when all indoor units are stopped.


<Operation>

The  (Mode) button can be used to change between heating and cooling operation.

- The display indicates the operating mode of the indoor unit with the lowest unit No.

- **All units test run (Fig. 6-2)**

<Operation>


The  (Check) button can be used to start and stop a test run for all indoor units.


- Press and hold for 4 seconds to turn ON.  
During the test run “TEST” is displayed.
- The status of test runs performed from the indoor unit remote controller is not displayed on the outdoor unit maintenance remote controller.

- **Double-speed (Fig. 6-3)**

- Do not use for actual operation.  
(Doing so may damage the devices.)

<Operation>

The timer button  can be used to change between double-speed and normal operation.

- During double-speed operation, the Sleeping Mode  mark is displayed.

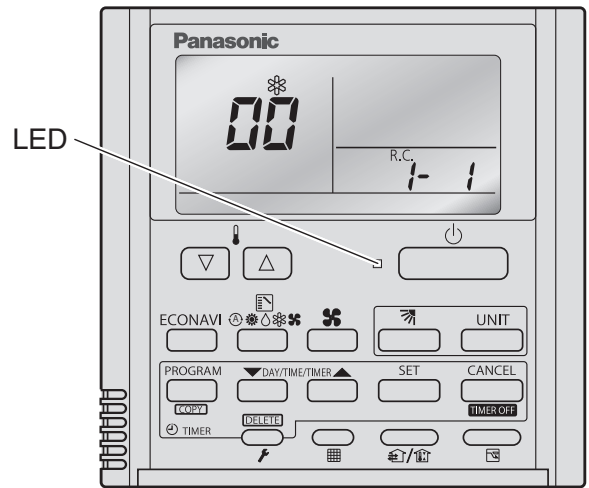


Fig. 6-1

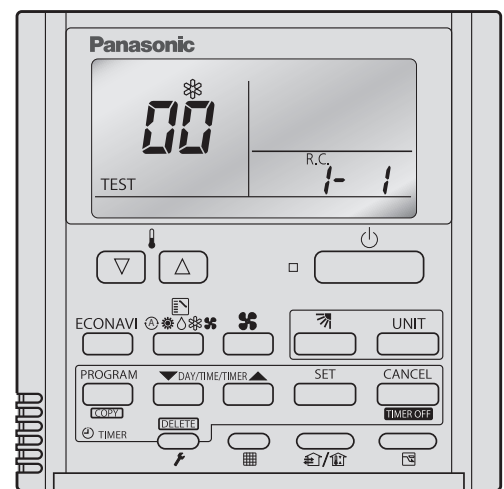


Fig. 6-2

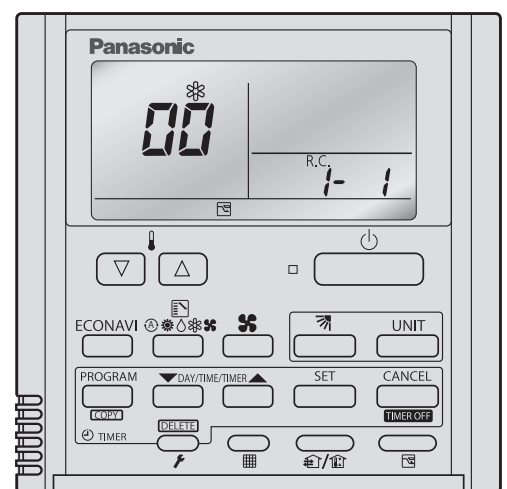


Fig. 6-3



■ **Display (functions)**

- Use the temperature setting  and  buttons to change the item code.

| Item code | Display contents  | Remarks                   |
|-----------|---|---------------------------|
| 00(1)     | Outdoor unit contents (code) : OFF when normal<br>Blinking 8 - alarm code display at pre-trip,LED (2) | At initial status         |
| 01        | No. of indoor units connected in that refrigerant system  |                           |
| 02        | Unit Nos. of connected indoor units in that refrigerant system  |                           |
| 03        | Operating status of indoor units in that refrigerant system (blinks when alarms occur)                |                           |
| 04        | Unit Nos. of indoor units in that refrigerant system where the thermostats are ON                     |                           |
| 05        | No. of outdoor units connected in that refrigerant system   | No. of connected units :1 |
| 06        | Unit Nos. of connected outdoor units in that refrigerant system                                       |                           |
| 07        | Operating status of outdoor units in that refrigerant system (blinks when alarms occur)               |                           |
| 08        |   |                           |
| 09        |   |                           |
| 0A        |   |                           |
| 0b        |   |                           |
| 0C        |   |                           |
| 0d        |   |                           |
| 0E        |   |                           |
| 0F        |   |                           |
| 10        | Total compressor operating time (in 1-h. units)   |                           |
| 11        |   |                           |
| 12        |   |                           |
| 13        |   |                           |
| 14        |   |                           |
| 15        |   |                           |
| 16        | Total power ON time of outdoor unit (in 1-h. units)   |                           |
| 17        | Compressor start count  |                           |
| 18        |   |                           |
| 19        |   |                           |
| FE        | Outdoor unit microcomputer firmware version   |                           |
| FF        | Outdoor unit microcomputer software version   |                           |

(1) and (2) correspond to Fig. 6-4 on the next page.

(3) XX-YY R.C.

Displays the outdoor unit sub-bus address which is currently selected.

XX = Outdoor system address on main bus line (1 – 30)

YY = Outdoor unit sub-bus address (1 – 8)

“1” appears when there is only 1 outdoor unit.

Locations where (1), (2), and (3) are displayed as shown in Fig. 6-4.

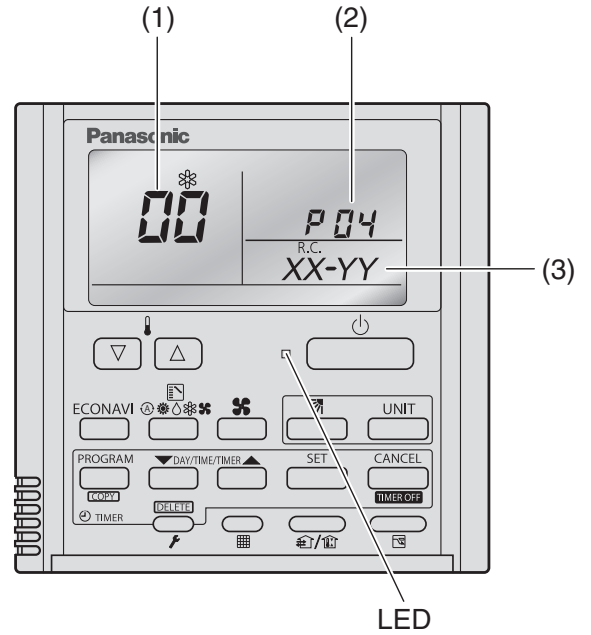
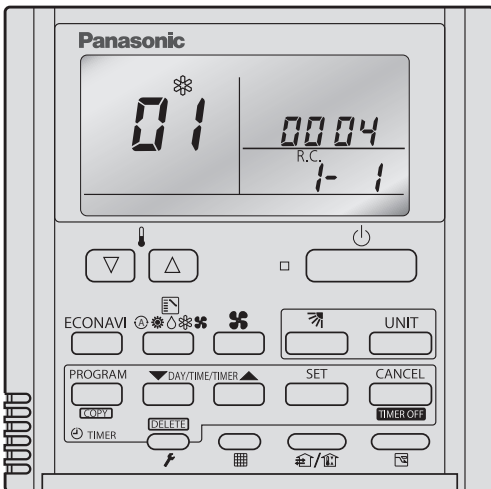


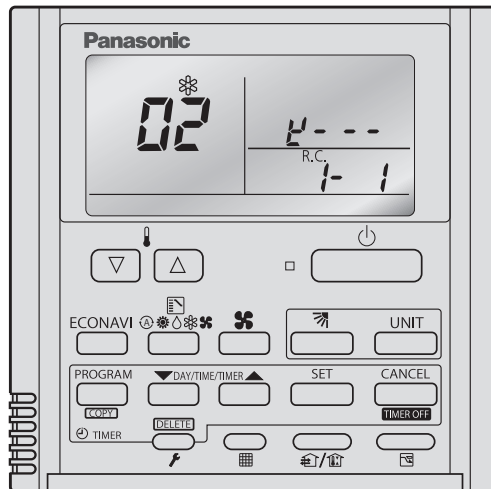
Fig. 6-4

<Sample displays>



01: <No. of connected indoor units>  
4 units connected

Fig. 6-5



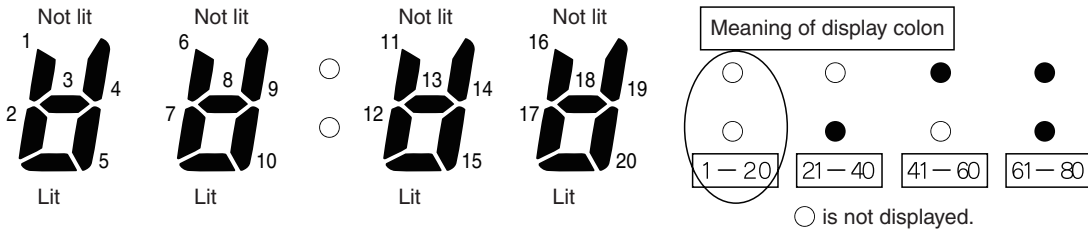
02: <Unit Nos. 1, 2, 3, and 4 are connected>

Fig. 6-6

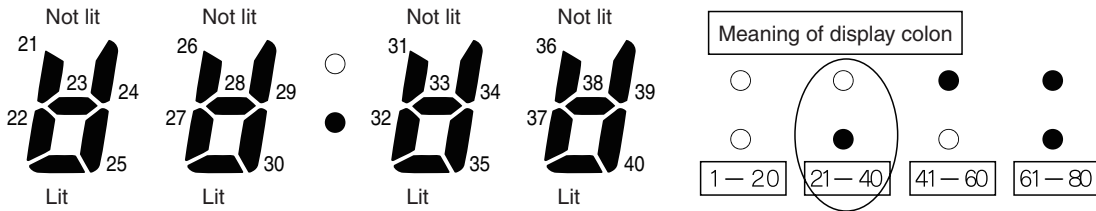
■ 7-segment, 4-digit display for remote controller timer display

The connected unit Nos. are displayed as shown below, using the 7-segment 4-digit (00:00) display and the colon.

● Display for unit Nos. 1 – 20

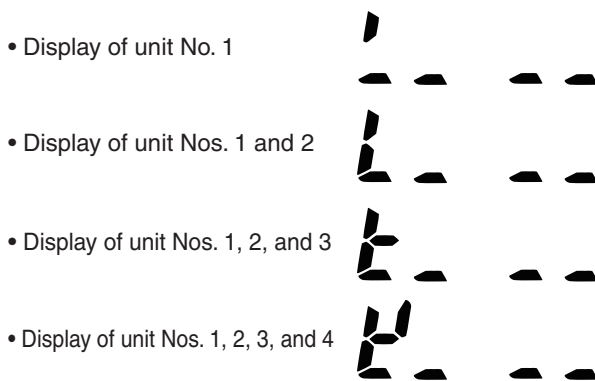


● Display for unit Nos. 21 – 40



● The meaning of the colon display changes in the same way, allowing unit Nos. up to 80 to be displayed.

● Sample displays of the unit Nos. of connected indoor units

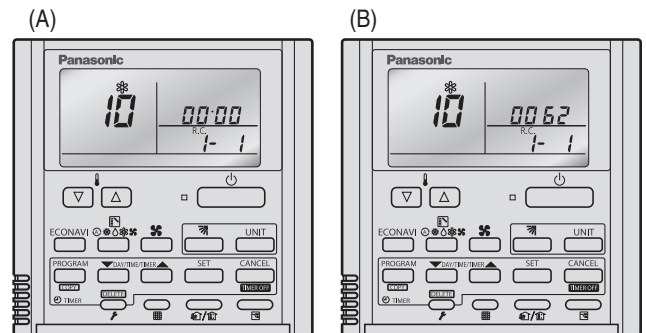


**NOTE**

The change of the colon display (between unit Nos. 1-20 to unit Nos. 21-40) occurs automatically every 10 seconds. (However the display does not change if there are no higher-number units connected.) To change the display to the higher-number units before 10 seconds have passed, press the (Flap) button.

■ The total compressor operating time is displayed (in 1-hour units) using 8 digits.

- When the first 4 digits are displayed, the top dot of the colon is illuminated. (Figure (A))
- When the last 4 digits are displayed, the colon dot is OFF. (Figure (B))
- The display of the first 4 digits and last 4 digits changes automatically after 10 seconds. The display can also be changed by pressing the (Flap) button.





10: <Compressor's total operating time>  
(A) and (B) are displayed alternately.  
(The example here (0000, 0062) indicates 62 hours.)

**NOTE**

With the outdoor unit maintenance remote controller (when connected to the outdoor unit), the unit remote controller check functions will not operate.


## 6-4. Monitoring Operations: Display of Indoor Unit and Outdoor Unit Sensor Temperatures



<Operating procedure>

- (1) Press and hold the  (Check) button and  buttons simultaneously for 4 seconds or longer to engage temperature monitor mode.


During temperature monitoring,  is illuminated.

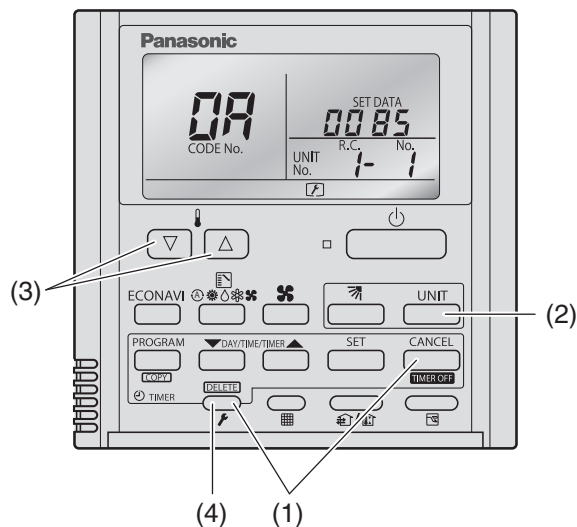
(The display and operations are the same as for monitor mode using the indoor unit remote controller.)

- (2) Press the  button and select the indoor unit to monitor.

- (3) Press the temperature setting  and  buttons and select the item code of the temperature to monitor.

The unit No. of the selected indoor unit, and the temperature data, are displayed.

- (4) To end monitoring, press the  (Check) button.  
The display returns to the normal display.



**NOTE** The display does not blink.

■ Display of unit No. 1 (main unit)

|                  | Item code         | Meaning of Code                        |
|------------------|-------------------|--|
| Indoor unit data | 02                | Indoor unit intake temp.               |
|                  | 03                | Indoor unit heat exchanger temp. (E1)  |
|                  | 04                | Indoor unit heat exchanger temp. (E2)  |
|                  | 05                | —                                      |
|                  | 06                | —                                      |
|                  | 07                | —                                      |
|                  | 08                | —                                      |
|                  | 09                | —                                      |
|                  | Outdoor unit data | 0A                                     |
| 0b               |                   | —                                      |
| 0C               |                   | —                                      |
| 0d               |                   | Intake temp. (TS)                      |
| 0E               |                   | Outdoor unit heat exchanger temp. (C1) |
| 0F               |                   | Outdoor unit heat exchanger temp. (C2) |
| 10               |                   | —                                      |
| 11               |                   | Outdoor air temp. (TO)                 |
| 12               |                   | —                                      |
| 13               |                   | Inverter primary current               |
| 14               |                   | —                                      |
| 15               |                   | Outdoor MV value                       |
| 16               |                   | —                                      |
| 19               | Frequency         |  |



\* Depending on the model, some items may not be displayed.

## 6-5. Monitoring the Outdoor Unit Alarm History: Display of Outdoor Unit Alarm History

\* Displays outdoor unit alarms only. Does not display indoor unit alarms.




\* Check the indoor unit alarm histories separately using the indoor unit remote controllers or other control device.

### <Operating procedure>

- (1) Press and hold the  (Check) button and  button simultaneously for 4 seconds or longer to engage outdoor unit alarm history mode.

During temperature monitoring,  illuminates.

The display and operations are the same as for the alarm history monitor performed from the indoor unit remote controller. However the "UNIT No." display shows the outdoor unit address.

- (2) Press the  button and select the outdoor unit for which to monitor the alarm history.
- (3) Press the temperature setting  and  buttons and select the item code for the alarm history.

The select outdoor unit address, the item code, and the alarm history (alarm data) are displayed.

The outdoor unit address is displayed as R.C. XX-YY.



System XX = Outdoor unit system address

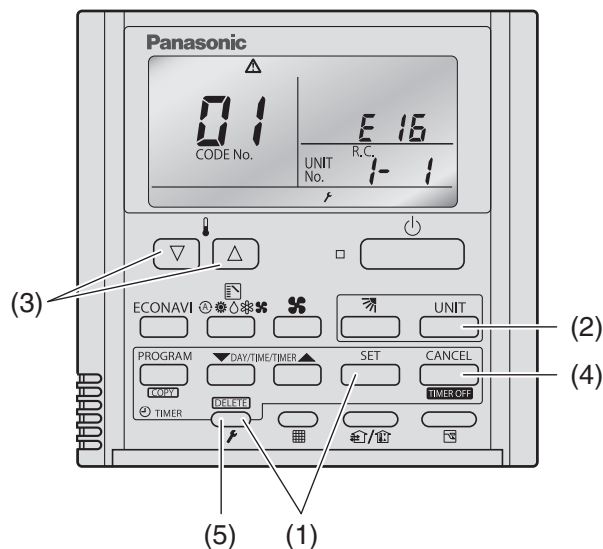
R.C. XX = Outdoor unit system address

YY = Outdoor unit sub-bus address

Item codes 01-08 are displayed. 01 indicates the most recent alarm.

The alarm history displays the alarm code. (If no alarm are present, then -- -- is displayed.)







- (4) To clear the alarm history, press the  button. (The outdoor unit alarm history will be cleared.)
- (5) To exit, press the  (Check) button. The display returns to the normal display.




## 6-6. Settings Modes: Setting the Outdoor Unit EEPROM

### ● Setting mode 1

<Operating procedure>

- (1) Press and hold the  (Check) button and  (Ventilation) button simultaneously for 4 seconds or longer.
- (2) Press the temperature setting  and  buttons to change the item code. The item codes and setting data are shown in the table below.
- (3) Press the timer time  and  buttons to change the setting data.


To confirm the changed setting data, press the  button.

(At this time, “SETTING” display stops blinking and remains lit.)

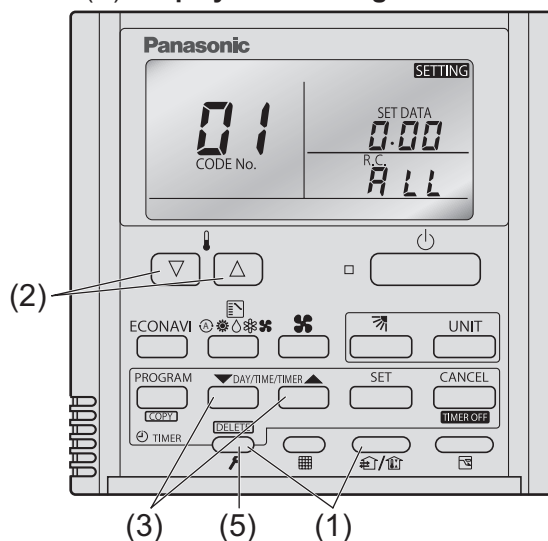
- (4) During this mode, “SETTING” is displayed, blinking. The outdoor unit address display section displays “ALL,” the item code and number (DN value in the table), and the setting data (6 digits).

(The setting data is displayed in 6 digits. The display changes between the first 3 digits (Fig. (C)). and the last 3 digits (Fig. (D)).

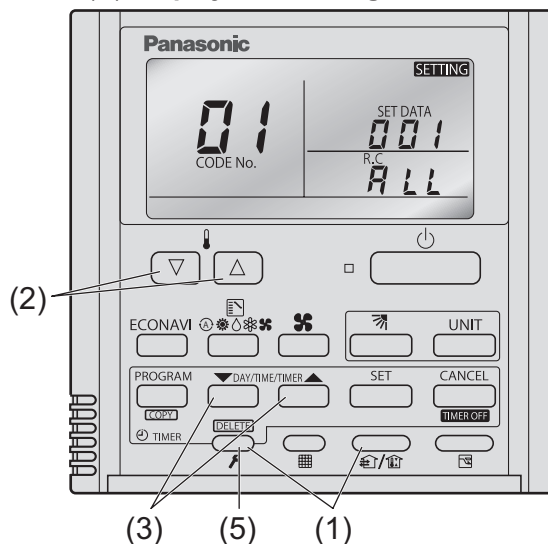
(When the first 3 digits are displayed, the bottom dot of the colon is illuminated.)

- (5) To exit the setting mode, press the  (Check) button.

(C) Display of first 3 digits



(D) Display of last 3 digits



(C) and (D) are displayed alternately.  
(Example shows display of 000 001.)

**List of Item Codes (Some item codes cannot be set due to the type of models.)**

| Item code | Parameter  |  |
|-----------|--|--|
| 05        | Silent level   | 1=Silent level1 2=Silent level2 3=Silent level3  |
| 07        | Ignore capacity  | 0 = Disabled 1 = Ignores capacity ratio  |
| 0C        | Forced operation of indoor unit drain pump   | 0 = Disable<br>1 = 2 hours stopped + 20 minutes operating (regardless of whether the unit is running or stopped)<br>2 = 20 minutes stopped + 20 minutes operating (regardless of whether the unit is running or stopped)<br>3 = Always operating (regardless of whether the unit is running or stopped)<br>4 = XX minutes (Setting of Item code "2B") operating when the unit change to thermo off or stop from thermo on.<br>5 = XX minutes (Setting of Item code "2B") operating when the unit change to stop (regardless of whether the unit was thermo on or thermo off).<br>6 = Doing the action 4 and 5.<br>7 = During cooling only, Doing the action 6. |
| 0E        | Cooling only   | 0=Heat pump 1=Cooling only   |
| 12        | Silent mode  | 0=Disable(at shipment) 1=At any times 2=Capacity priority 3=Timer setting 4=2+3  |
| 13        | Silent mode starting time (hour)   | 22 = 22 o'clock (at shipment)  |
| 14        | Silent mode starting time (minutes)  | 00 = 00 minute (at shipment)   |
| 15        | Silent mode finishing time (hour)  | 28 = 28 o'clock (at shipment)  |
| 16        | Silent mode finishing time (minutes)   | 00 = 00 minute (at shipment)   |
| 1A        | Demand 1 Current   | 40% ~ 130%, -1(no control)   |
| 1B        | Demand 1 Current   | 40% ~ 130%, -1(no control)   |
| 1D        | Current control level  | 40% ~ 130%, -1(no control)   |
| 2B        | Operating time of indoor unit drain pump   | 0=20minutes 1=30minutes 2=40minutes<br>3=50minutes 4=60minutes   |
| 80        | Refrigerant Type   | 410 = R410A(P), 22 = R22, 407 = R407C, 32 = R32  |
| 81        | Outdoor unit capacity<br>(Setting when the data is not stored in the EEPROM. Do not change under normal conditions.) | 0 = Invalid, 40 = type 36, 56 = type 50, 71 = type 60, 80 = type 71, 112 = type 100, 140 = type 125, 160 = type 140  |

\* Figures in parentheses indicate the data at the time of shipment from the factory.



## 7. REMOTE CONTROLLER FUNCTIONS SECTION










|      |  |      |
|------|--|------|
| 7-1. | Simple Settings Function .....             | 7-2  |
| 7-2. | List of Simple Setting Items .....         | 7-5  |
| 7-3. | Detailed Settings Function .....           | 7-6  |
| 7-4. | List of Detailed Setting Items .....       | 7-9  |
| 7-5. | Simple Setting Items .....                 | 7-13 |
| 7-6. | Detailed Setting Items .....               | 7-15 |
| 7-7. | Remote Controller Servicing Functions..... | 7-19 |
| 7-8. | Test Run Function .....                    | 7-22 |

## 7-1. Simple Settings Function

- This allows the filter lifetime, operating mode priority change, central control address, and other settings to be made for an individual or group-control indoor unit to which the remote controller used for simple settings is connected.

When simple settings mode is engaged, operation stops at the individual or group-control indoor unit to which the remote controller for simple settings is connected.

### <Procedure of CZ-RTC2>

- Press and hold the  and  buttons simultaneously for 4 seconds or longer.
- "**SETTING**", unit No. "**1-1**" (or "**ALL**" in the case of group control), item code "**01**," and settings data "**00XX**" are displayed blinking on the remote controller LCD display (Fig. 7-1). At this time, the indoor unit fan (or all indoor unit fans in the case of group control) begins operating.
- If group control is in effect, press the  button and select the address (unit No.) of the indoor unit to set. At this time, the fan at the indoor unit begins operating.  
\* If unit No. "**ALL**" is displayed, the same setting will be made for all indoor units.
- Press the temperature setting  /  buttons to select the item code to change.
- Press the timer time  /  buttons to select the desired setting data.  
\* For item codes and setting data, see page 7-5.
- Press the  button. (The display stops blinking and remains lit, and setting is completed.)
- Press the  button to return to normal remote controller display.

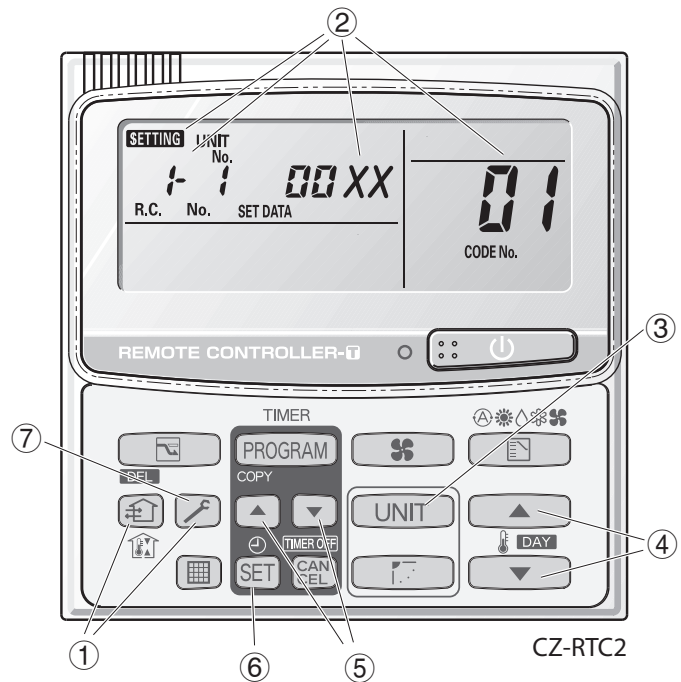


Fig. 7-1

<Procedure of CZ-RTC3 / CZ-RTC5A>



CZ-RTC3 / CZ-RTC5A

Fig. 7-2

- ① Keep pressing the , and buttons simultaneously for 4 or more seconds. The “Maintenance func” screen appears on the LCD display.

|                            |                   |
|----------------------------|-------------------|
| Maintenance func           | 20:30 (THU)       |
| 1. Outdoor unit error data |                   |
| 2. Service contact         |                   |
| 3. RC setting mode         |                   |
| 4. Test run                |                   |
| ▼ Sel.                     | ▶ Page [] Confirm |

- ② Press the or button to see each menu. If you wish to see the next screen instantly, press the or button. Select “7. Simple settings” on the LCD display and press the button.

|                      |                     |
|----------------------|---------------------|
| Maintenance func     | 20:30 (THU)         |
| 5. Sensor info.      |                     |
| 6. Servicing check   |                     |
| 7. Simple settings   |                     |
| 8. Detailed settings |                     |
| ◆ Sel.               | ◀ ▶ Page [] Confirm |

The “Simple settings” screen appears on the LCD display. Select the “Unit no.” by pressing the or button for changes.

|                 |          |             |
|-----------------|----------|-------------|
| Simple settings |          | 20:30 (THU) |
| Unit no.        | Code no. | Set data    |
| 3-1             | 01       | 0001        |
| ◆ Sel.          | ▶ Next   |             |

- ③ Select the “Code no.” by pressing the or button. Change the “Code no.” by pressing the or button.

|                 |          |             |
|-----------------|----------|-------------|
| Simple settings |          | 20:30 (THU) |
| Unit no.        | Code no. | Set data    |
| 3-1             | 01       | 0001        |
| ◆ Sel.          | ▶ Next   |             |










- ④ Select the “Set data” by pressing the or button. Select one of the “Set data” by pressing the or button. Then press the button.

|                   |            |             |
|-------------------|------------|-------------|
| Detailed settings |            | 20:30 (THU) |
| Unit no.          | Code no.   | Set data    |
| 3-1               | 10         | 0001        |
| ◆ Sel.            | [] Confirm |             |

- ⑤ Select the “Unit no.” by pressing the or button and press the button. The “Exit simple settings and restart?” (Simple setting-end) screen appears on the LCD display. Select “YES” and press the button.

|                                   |        |             |
|-----------------------------------|--------|-------------|
| Exit simple settings and restart? |        | 20:30 (THU) |
| YES                               | ▶ NO   |             |
| ◆ Sel.                            | ▶ Next |             |

### <Procedure of CZ-RTC4>

- ① Press and hold the  and  buttons simultaneously for 4 seconds or longer.
- ② "SETTING", unit No. "1-1" (or "ALL" in the case of group control), item code "01" and settings data "00XX" are displayed blinking on the remote controller LCD display (Fig. 7-3). At this time, the indoor unit fan (or all indoor unit fans in the case of group control) begins operating.
- ③ If group control is in effect, press the  button and select the address (unit No.) of the indoor unit to set. At this time, the fan at the indoor unit begins operating.  
\*If unit No. "ALL" is displayed, the same setting will be made for all indoor units.
- ④ Press the temperature setting  /  buttons to select the item code to change.
- ⑤ Press the timer time  /  buttons to select the desired setting data.  
\*For item codes and setting data, refer to the following page.
- ⑥ Press the  button. (The display stops blinking and remains lit, and setting is completed.)
- ⑦ Press the  button to return to normal remote controller display.

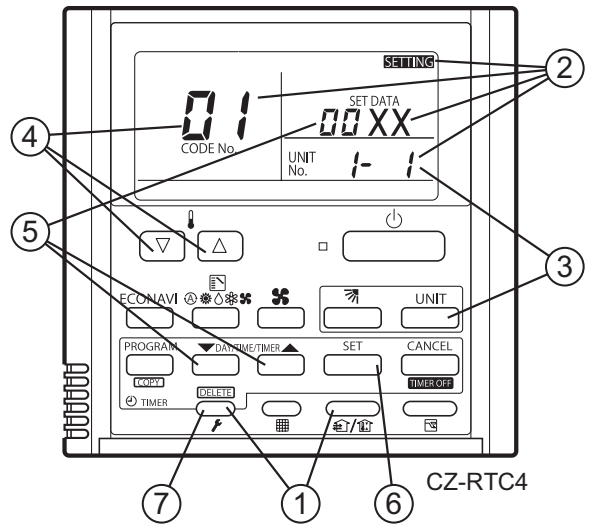


Fig. 7-3

## 7-2. List of Simple Setting Items

| Item code | Item  | Setting data |   |                |
|-----------|---|--------------|---|----------------|
|           |   | No.          | Description   |                |
| 01        | Filter sign ON time<br>(filter life time)       | 0000         | Not displayed   |                |
|           |   | 0001         | 150 hours   |                |
|           |   | 0002         | 2,500 hours   |                |
|           |   | 0003         | 5,000 hours   |                |
|           |   | 0004         | 10,000 hours  |                |
|           |   | 0005         | Use the filter clogging sensor.   |                |
| 02        | Degree of filter fouling                        | 0000         | Standard (setting at time of shipping)                                      |                |
|           |   | 0001         | Highly fouled<br>(Filter sign ON time is reduced to one-half the set time.) |                |
| 03        | Central control<br>address                      | 0001         | Central control address 1   |                |
|           |   | 0002         | Central control address 2   |                |
|           |   | 0003         | Central control address 3   |                |
|           |   | }            | }   |                |
|           |   | 0064         | Central control address 64  |                |
|           |   | 0099         | No central control address set (setting at time of shipping)                |                |
| 04        | Operating mode<br>priority change               | 0000         | Normal ( setting at time of shipping)                                       |                |
|           |   | 0001         | Priority  |                |
| 05        | Fan speed when<br>heating thermostat is<br>OFF  |              | Compressor ON   | Compressor OFF |
|           |   | 0000         | Lo 1 min., LL 3 min.  | LL             |
|           |   | 0001         | Lo  | LL             |
|           |   | 0002         | LL  | LL             |
|           |   | 0004         | Lo 1 min., LL 3 min. Lo   | Lo             |
|           |   | 0005         | Lo  | Lo             |
|           |   | 0006         | LL  | Lo             |
| 06        | Heating intake<br>temperature shift             | 0000         | No shift  |                |
|           |   | 0001         | Shifts intake temperature 1 °C down.  |                |
|           |   | 0002         | Shifts intake temperature 2 °C down.  |                |
|           |   | 0003         | Shifts intake temperature 3 °C down.  |                |
|           |   | 0004         | Shifts intake temperature 4 °C down.  |                |
|           |   | 0005         | Shifts intake temperature 5 °C down.  |                |
|           |   | 0006         | Shifts intake temperature 6 °C down.  |                |
| 07        | Electric heater<br>installation                 | 0000         | No heater   |                |
|           |   | 0001         | Heater installed  |                |
| 08        | Humidifying when<br>heater thermostat is<br>OFF | 0000         | No (setting at time of shipping)  |                |
|           |   | 0001         | Yes   |                |
| 0d        | Permit/prohibit<br>automatic<br>heating/cooling | 0000         | Permit  |                |
|           |   | 0001         | Prohibit  |                |
| 0F        | Cool-only                                       | 0000         | Normal  |                |
|           |   | 0001         | Cool only (Set "1" for item code OD.)                                       |                |

### NOTE






- In order to avoid water leakage and damage to the fan, do not set for humidifying when the thermostat is OFF unless a vaporizing humidifier is used.
- Consider the device purpose and type when changing the settings. Incorrect settings may result in malfunction.
- Do not change any setting data that does not appear in this list.

### 7-3. Detailed Settings Function


- This allows the system address, indoor unit address, and other settings to be made for the individual or group-control indoor unit to which the remote controller used for detailed settings is connected.

When detailed settings mode is engaged, operation stops at the individual or group-control indoor unit where the remote controller used for detailed settings is connected. Simple settings items can also be set at this time.

#### <Procedure of CZ-RTC2>

- Press and hold the , **SET** and **CAN CEL** buttons simultaneously for 4 seconds or longer.
- "**SETTING**", unit No. "**1-1**" (or "**ALL**" in the case of group control), item code "**10**," and settings data "**00XX**" are displayed blinking on the remote controller LCD display (Fig. 7-4).  
At this time, the indoor unit fan (or all indoor unit fans in the case of group control) begins operating.
- If group control is in effect, press the **UNIT** button and select the address (unit No.) of the indoor unit to set. At this time, the fan at the indoor unit begins operating.
- Press the temperature setting  /  buttons to select the item code to change.
- Press the timer time  /  buttons to select the desired setting data.

\*For item codes and setting data, see page 7-9.

- Press the **SET** button. (The display stops blinking and remains lit, and setting is completed.)
- Press the  button to return to normal remote controller display.

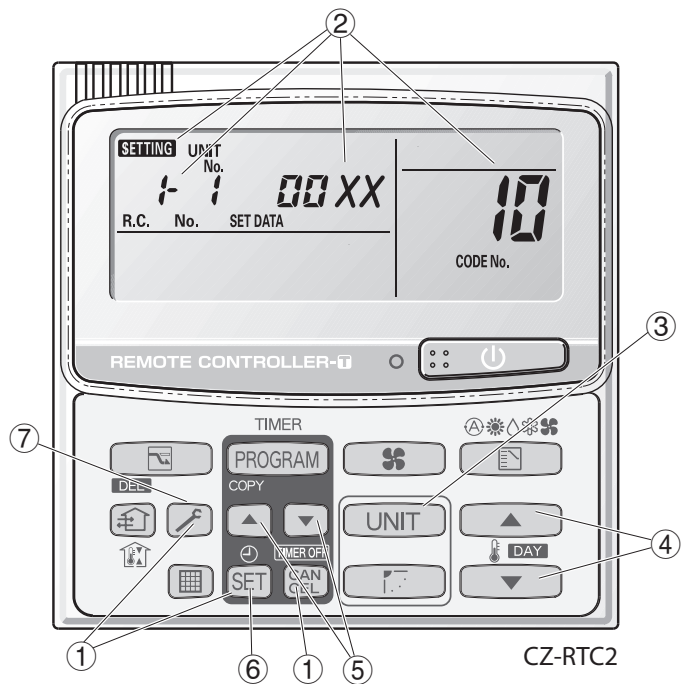


Fig. 7-4

<Procedure of CZ-RTC3 / CZ-RTC5A>



CZ-RTC3 / CZ-RTC5A

Fig. 7-5

- ① Keep pressing the , and buttons simultaneously for 4 or more seconds. The “Maintenance func” screen appears on the LCD display.

|                            |                   |
|----------------------------|-------------------|
| Maintenance func           | 20:30 (THU)       |
| 1. Outdoor unit error data |                   |
| 2. Service contact         |                   |
| 3. RC setting mode         |                   |
| 4. Test run                |                   |
| ▼ Sel.                     | ▶ Page [] Confirm |

- ② Press the or button to see each menu. If you wish to see the next screen instantly, press the or button. Select “8. Detailed settings” on the LCD display and press the button.

|                      |                     |
|----------------------|---------------------|
| Maintenance func     | 20:30 (THU)         |
| 5. Sensor info.      |                     |
| 6. Servicing check   |                     |
| 7. Simple settings   |                     |
| 8. Detailed settings |                     |
| ◆ Sel.               | ◀ ▶ Page [] Confirm |

The “Detailed settings” screen appears on the LCD display.

Select the “Unit no.” by pressing the or button for changes.

|                   |          |             |
|-------------------|----------|-------------|
| Detailed settings |          | 20:30 (THU) |
| Unit no.          | Code no. | Set data    |
| 3-1               | 10       | 0001        |
| ◆ Sel.            | ▶ Next   |             |

- ③ Select the “Code no.” by pressing the or button. Change the “Code no.” by pressing the or button (or keeping it pressed).

|                   |          |             |
|-------------------|----------|-------------|
| Detailed settings |          | 20:30 (THU) |
| Unit no.          | Code no. | Set data    |
| 3-1               | 10       | 0001        |
| ◆ Sel.            | ▶ Next   |             |











- ④ Select the “Set data” by pressing the or button. Select one of the “Set data” by pressing the or button. Then press the button.

|                   |            |             |
|-------------------|------------|-------------|
| Detailed settings |            | 20:30 (THU) |
| Unit no.          | Code no.   | Set data    |
| 3-1               | 10         | 0001        |
| ◆ Sel.            | [] Confirm |             |

- ⑤ Select the “Unit no.” by pressing the or button and press the button. The “Exit detailed settings and restart?” (Detailed setting-end) screen appears on the LCD display. Select “YES” and press the button.

|                                     |        |             |
|-------------------------------------|--------|-------------|
| Detailed settings                   |        | 20:30 (THU) |
| Exit detailed settings and restart? |        |             |
| YES ▶ NO                            |        |             |
| ◆ Sel.                              | ▶ Next |             |

## <Procedure of CZ-RTC4>

- ① Press and hold the ,  and  buttons simultaneously for 4 seconds or longer.
  - ② "SETTING", unit No. "1-1" (or "ALL" in the case of group control), item code "10", and settings data "00XX" are displayed blinking on the remote controller LCD display (Fig. 7-6). At this time, the indoor unit fan (or all indoor unit fans in the case of group control) begins operating.
  - ③ If group control is in effect, press the  button and select the address (unit No.) of the indoor unit to set. At this time, the fan at the indoor unit begins operating.
  - ④ Press the temperature setting  /  buttons to select the item code to change.
  - ⑤ Press the timer time  /  buttons to select the desired setting data.
- \*For item codes and setting data, refer to the following page.
- ⑥ Press the  button. (The display stops blinking and remains lit, and setting is completed.)
  - ⑦ Press the  button to return to normal remote controller display.

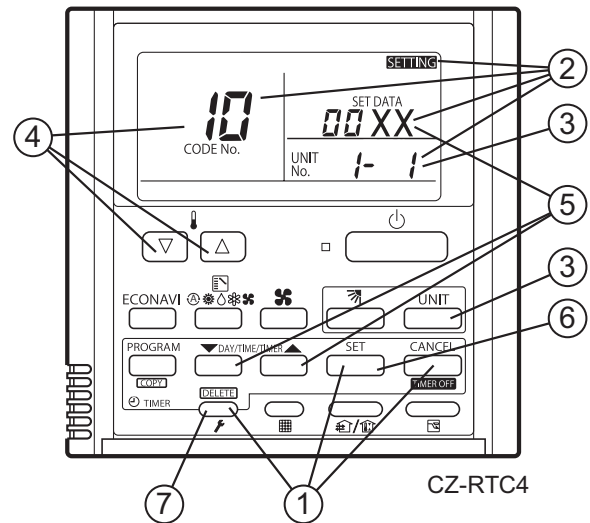


Fig. 7-6



#### 7-4. List of Detailed Setting Items

| Item code | Item   | Setting data |  |      |   |
|-----------|--|--------------|--|------|---|
|           |  | No.          | Description  | No.  | Description                               |
| 10        | Type   | 0001         | 4-Way Cassette (U2)<br>4-Way Cassette 60 x 60 (Y2)             | 0005 | Low Silhouette Ducted (F1)<br>Ducted (N1) |
|           |  | 0007         | Ceiling (T2)   | 0008 | Wall mounted (K1)                         |
| 11        | Indoor unit capacity   | 0005         | 36 (Type 36)   | 0007 | 45 (Type 45)                              |
|           |  | 0009         | 56 (Type 50)   | 0011 | 71 (Type 60)                              |
|           |  | 0012         | 80 (Type 71)   | 0015 | 112 (Type 100)                            |
|           |  | 0017         | 140 (Type 125)   | 0018 | 160 (Type 140)                            |
| 12        | System address   | 0001         | Unit No. 1   |      |   |
|           |  | 0002         | Unit No. 2   |      |   |
|           |  | 0003         | Unit No. 3   |      |   |
|           |  | }            | }  |      |   |
|           |  | 0030         | Unit No. 30  |      |   |
|           |  | 0099         | Not set  |      |   |
| 13        | Indoor unit address  | 0001         | Unit No. 1   |      |   |
|           |  | 0002         | Unit No. 2   |      |   |
|           |  | 0003         | Unit No. 3   |      |   |
|           |  | }            | }  |      |   |
|           |  | 0064         | Unit No. 64  |      |   |
|           |  | 0099         | Not set  |      |   |
| 14        | Group control address  | 0000         | Individual (1:1 = Indoor unit with no group wiring)            |      |   |
|           |  | 0001         | Main unit (One of the group-control indoor units)              |      |   |
|           |  | 0002         | Sub unit (All group-control indoor units except for main unit) |      |   |
|           |  | 0099         | Not set  |      |   |
| 17        | Cooling intake temperature shift   | -010         | Shifts intake temperature 10°C down.                           |      |   |
|           |  | -009         | Shifts intake temperature 9°C down.                            |      |   |
|           |  | }            | }  |      |   |
|           |  | -001         | Shifts intake temperature 1°C down.                            |      |   |
|           |  | 0000         | No intake temperature shift                                    |      |   |
|           |  | 0001         | Shifts intake temperature 1°C up.                              |      |   |
|           |  | }            | }  |      |   |
|           |  | 0009         | Shifts intake temperature 9°C up.                              |      |   |
| 0010      | Shifts intake temperature 10°C up.   |              |  |      |   |
| 18        | Automatic stop time after operation start<br><br>* Can be set in 5-minute units. | 0000         | Function disabled  |      |   |
|           |  | 0001         | Stops automatically 5 minutes after operation starts.          |      |   |
|           |  | 0002         | Stops automatically 10 minutes after operation starts.         |      |   |
|           |  | }            | }  |      |   |
|           |  | 0123         | Stops automatically 615 minutes after operation starts.        |      |   |
|           |  | 0124         | Stops automatically 620 minutes after operation starts.        |      |   |
|           |  | 0125         | Stops automatically 625 minutes after operation starts.        |      |   |

| Item code  | Item  | Setting data |   |                                |
|--|---|--------------|---|--------------------------------|
|  |   | No.          | Description   |                                |
| <b>1b</b> (1B)   | Forced thermostat ON time   | 0000         | 5 minutes   |                                |
|  |   | 0001         | 4 minutes   |                                |
| <b>1E</b>  | Temperature shift for cooling/heating change in auto heat/cool mode | 0001         | ± 1°C   |                                |
|  |   | 0002         | ± 2°C   |                                |
|  |   | 0003         | ± 3°C   |                                |
|  |   | {            | }   |                                |
|  |   | 0007         | ± 7°C   |                                |
| <b>1F</b><br>(Upper limit)<br><b>20</b><br>(Lower limit) | Change to remote control temperature setting range                  | Cooling      | 0018  | 18°C (Lower limit at shipment) |
|  |   |              | 0019  | 19°C                           |
|  |   |              | }   | }                              |
|  |   |              | 0029  | 29°C                           |
| <b>21</b><br>(Upper limit)<br><b>22</b><br>(Lower limit) |   | Heating      | 0016  | 16°C (Lower limit at shipment) |
|  |   |              | 0017  | 17°C                           |
|  |   |              | }   | }                              |
|  |   |              | 0029  | 29°C                           |
| <b>23</b><br>(Upper limit)<br><b>24</b><br>(Lower limit) |   | Drying       | 0030  | 30°C (Upper limit at shipment) |
|  |   |              | 0018  | 18°C (Lower limit at shipment) |
|  |   |              | 0019  | 19°C                           |
|  |   |              | }   | }                              |
| <b>25</b><br>(Upper limit)<br><b>26</b><br>(Lower limit) | Auto heat/cool  | 0029         | 29°C  |                                |
|  |   | 0030         | 30°C (Upper limit at shipment)  |                                |
|  |   | 0017         | 17°C (Lower limit at shipment)  |                                |
|  |   | 0018         | 18°C  |                                |
|  |   | }            | }   |                                |
| <b>29</b>  | Humidifier operation  | 0026         | 26°C  |                                |
|  |   | 0027         | 27°C (Upper limit at shipment)  |                                |
| <b>2A</b>  | Filter (CN70) input switching                                       | 0000         | Normal  |                                |
|  |   | 0001         | Ignore heat exchanger temperature conditions.                             |                                |
|  |   | 0002         | Humidifier input (Operates linked with drain pump when humidifier is ON.) |                                |
| <b>2C</b>  | Indoor unit electronic control valve                                | 0000         | Filter input (differential pressure switch input)                         |                                |
|  |   | 0001         | Alarm input (for trouble input about air cleaner or similar device)       |                                |
| <b>2E</b>  | T10 terminal switching  | 0002         | Humidifier input (Operates linked with drain pump when humidifier is ON.) |                                |
|  |   | 0000         | Present (Setting at shipment)   |                                |
|  |   | 0002         | None  |                                |
| <b>2E</b>  | T10 terminal switching  | 0000         | Normal (Used as optional relay PCB or JEMA standard HA terminal.)         |                                |
|  |   | 0001         | Used for OFF reminder   |                                |
|  |   | 0002         | Fire prevention input   |                                |

| Item code | Item   | Setting data |   |
|-----------|--|--------------|---|
|           |  | No.          | Description   |
| 2F        | Automatic drain pump operation   | 0000         | No forced operation   |
|           |  | 0001         | Forced operation for 1 minute   |
|           |  | }            | }   |
|           |  | 0060         | Continuous operation  |
| 31        | Ventilation fan operation  | 0000         | None  |
|           |  | 0001         | Ventilation fan operated by remote controller.  |
| 32        | Wired remote controller sensor   | 0000         | Not used. (Body sensor is used.)  |
|           |  | 0001         | Remote control sensor is used.  |
| 34        | "Operation change control in progress" display   | 0000         | Normal (displayed)  |
|           |  | 0001         | Not displayed   |
| 35        | OFF reminder function for when weekly timer is used  | 0000         | None  |
|           |  | 0001         | Only stop time setting is enabled.  |
| 3E        | Heat exchanger temperature for cold air discharge (Heat exchanger control point for control to prevent cold air) | 0013         | Control temperature 13°C  |
|           |  | 0014         | Control temperature 14°C  |
|           |  | }            | }   |
|           |  | 0025         | Control temperature 25°C  |
| 3d        | Fan output switching   | 0000         | Output linked with fan. (ON when indoor unit fan is operating.)   |
|           |  | 0001         | Fan mode operation output   |
| 3E        | Drain pump delayed stop time   | 0000         | No delayed stop   |
|           |  | 0001         | 1 minute delayed stop   |
|           |  | 0002         | 2 minutes delayed stop  |
|           |  | }            | }   |
|           |  | 0058         | 58 minutes delayed stop   |
|           |  | 0059         | 59 minutes delayed stop   |
|           |  | 0060         | 60 minutes delayed stop   |
| 40        | Humidifier setting   | 0000         | Humidifier output OFF. Drain pump stopped.  |
|           |  | 0001         | Humidifier output ON. Drain pump operates.  |
|           |  | 0002         | Humidifier output ON. Drain pump operates for 1 minute when total humidifier operating time reaches 60 minutes. |
|           |  | 0003         | Humidifier output ON. Drain pump stopped.   |
| 45        | Flap operation mode  | 0000         | Standard setting  |
|           |  | 0001         | Draft reduction mode (Flap lower-limit position is shifted upwards.)  |
| 46        | Flap swing mode  | 0000         | Smudging reduction mode (Flap swing upper-limit position is shifted downwards.)                                 |
|           |  | 0001         | Normal mode   |
|           |  | 0002         | Draft reduction mode (Flap swing lower-limit position is shifted upwards.)                                      |

| Item code | Item  | Setting data |   |
|-----------|---|--------------|---|
|           |   | No.          | Description   |
| 5d        | Fan tap setting<br>(Fan tap change in order to prevent drop in air discharge caused by filter installation) |              | Purpose   |
|           |   | 0000         | Standard (factory setting)                            |
|           |   | 0001         | High ceiling setting 1 (with standard, ECONAVI panel) |
|           |   |              | Air-flow blocking kit (when a duct is connected.)     |
|           |   |              | Air-flow blocking kit (for 3-way air flow)            |
|           |   | 0003         | High ceiling setting 2 (with standard, ECONAVI panel) |
| 0006      | Air-flow blocking kit (for 2-way air flow)  |              |   |
| 5E        | Humidifier ON time<br>(ON time per 60 seconds)  | 0000         | No humidifier output                                  |
|           |   | 0001         | 1 second  |
|           |   | 0002         | 2 seconds   |
|           |   | {            | }   |
|           |   | 0058         | 58 seconds  |
|           |   | 0059         | 59 seconds  |
|           |   | 0060         | Continuously ON                                       |
| 60        | Timer function change prohibit  | 0000         | Function disabled                                     |
|           |   | 0001         | Function enabled                                      |
| 62        | Smudging control  | 0000         | No smudging control                                   |

## 7-5. Simple Setting Items

| Item code | Item  | Description   |
|-----------|---|---|
| 01        | Filter sign ON time setting (filter lifetime) | Changes the indoor unit filter lifetime when a high-performance filter or other optional product is installed.  |
| 02        | Degree of filter fouling                      | Reduces the filter sign ON time to 1/2 of the standard time (setting at the time of shipping) for cases when filter fouling is more severe than normal. |

### Filter sign ON times for each model

| Model data | Model  | Filter sign ON time |              |           |              |
|------------|--|---------------------|--------------|-----------|--------------|
|            |  | Standard            |              | Long-life |              |
|            |  | Standard            | High fouling | Standard  | High fouling |
| 0001       | 4-Way Cassette (U2)<br>4-Way Cassette 60 x 60 (Y2) | x                   | x            | 2500      | 1250         |
| 0005       | Low Silhouette<br>Ducted (F1)                      | x                   | x            | x         | x            |
| 0007       | Ceiling (T2)                                       | x                   | x            | 1500      | 750          |
| 0008       | Wall Mounted (K1)                                  | 150                 | 75           | x         | x            |
| 0036       | Ducted (N1)  | x                   | x            | x         | x            |

#### NOTE

- x indicates that there is no corresponding filter.
- **150** indicates the filter sign ON time that is set at shipment.
- High fouling: Set when **0001** is selected for the degree of filter fouling (item code **02**).

| Item code | Item                           | Description  |
|-----------|--------------------------------|--|
| 03        | Central control address        | Set when using a central control device.<br>Used when setting the central control address manually from the remote controller. |
| 04        | Operating mode priority change | Note (1)   |

#### NOTE

There are other methods to avoid control in which the mode selected first takes priority.

Methods of remotely controlling the operating mode

- (1) Use the central functions of a central control device.
- (2) Use a remote control relay PCB at the outdoor unit.

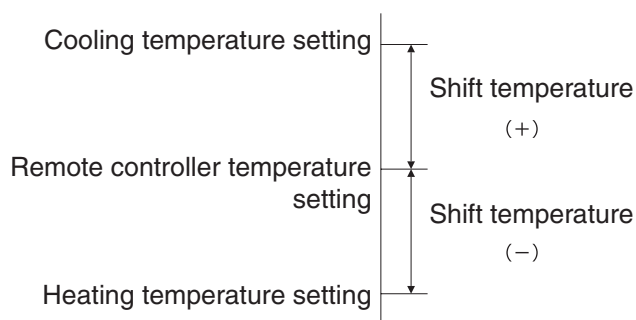
When the operating mode at the priority remote controller is changed, the operating modes of other remote controllers change as shown below.

| Mode change at priority remote controller |          | Operating modes at other remote controllers |                       |
|---|----------|---|-----------------------|
| Current mode                              | New mode | Current mode                                | New mode              |
| Cooling or dry                            | Heating  | Cooling or dry                              | Heating               |
|   |          | Fan   | Fan (not changed)     |
| Heating                                   | Cooling  | Heating                                     | Cooling               |
|   |          | Fan   | Fan (not changed)     |
| Cooling                                   | Dry      | Cooling                                     | Cooling (not changed) |
|   |          | Dry   | Dry (not changed)     |
| Heating                                   | Dry      | Heating                                     | Cooling               |
|   |          | Fan   | Fan (not changed)     |
| Cooling or dry                            | Fan      | Cooling                                     | Cooling (not changed) |
|   |          | Dry   | Dry (not changed)     |
|   |          | Fan   | Fan (not changed)     |
| Heating                                   | Fan      | Heating                                     | Heating (not changed) |
|   |          | Fan   | Fan (not changed)     |

| Item code | Item   | Description  |
|-----------|--|--|
| 05        | Fan speed setting when heating thermostat is OFF | Changes the fan speed setting when the heating thermostat is OFF.  |
| 06        | Heating intake temperature shift                 | Shifts the intake temperature during heating.<br>Can be set when the body thermostat is used.  |
| 07        | Electric heater installation                     | Set when cost distribution is performed using an AMY central control system or similar system, and when an optional electric heater is installed. (This is unrelated to control of the electric heater.)   |
| 08        | Humidifying when heater thermostat is OFF        | Normally humidifying does not occur when the thermostat is OFF during heating operation. However, this setting can be changed in order to increase the amount of humidifying.<br>Caution: In order to avoid water leakage and damage to the fan, do not use this setting unless a vaporizing humidifier is used. |
| 0D        | Permit/prohibit automatic heating/cooling        | This setting can be used to prevent the automatic heating/cooling display on the remote control if the unit configuration permits automatic heating/cooling operation.   |
| 0F        | Cooling-only                                     | This setting allows a heat pump indoor unit to be operated as a cooling-only unit.   |

## 7-6. Detailed Setting Items

| Item code | Item  | Description  |
|-----------|---|--|
| 10        | Unit type   | Set when the indoor unit EEPROM memory is replaced during servicing.   |
| 11        | Indoor unit capacity  |  |
| 12        | System (outdoor unit) address   | These are not set at the time of shipping from the factory. These must be set after installation if automatic address setting is not performed.  |
| 13        | Indoor unit address   |  |
| 14        | Group address   |  |
| 17        | Cooling intake temperature shift                                      | Shifts the intake temperature during cooling and dry operation. (Enabled only when the body thermostat is used.) Increase this value when it is difficult to turn the thermostat ON.   |
| 18        | Automatic stop time after operation start                             | The time at which an indoor unit is automatically stopped after operation starts can be set in increments of 5 minutes   |
| 1b        | Forced thermostat ON time   | Use this setting to change the time for forced operation at installation or servicing from 5 minutes to 4 minutes. (Enabled only with PAC models.)   |
| 1E        | Temperature shift for cooling/heating change in "auto heat/cool" mode | "Auto heat/cool" selects the operating mode automatically based on the difference between the room temperature and the temperature set on the remote controller. This setting establishes a shift temperature for the heating/cooling temperature setting relative to the remote controller temperature setting. |



| Item code                            | Item  | Description   |                |
|--------------------------------------|---|---|----------------|
| 1F (Upper limit)<br>20 (Lower limit) | Change to the remote control temperature setting range            | This setting changes the temperature range (upper limit and lower limit) which is set from the remote controller or central control device. The set upper limit must be greater than or equal to the lower limit. If the temperature setting is to be a single point, set the upper limit and lower limit to the same temperature.  |                |
| 21 (Upper limit)<br>22 (Lower limit) |   |   | Cooling        |
| 23 (Upper limit)<br>24 (Lower limit) |   |   | Heating        |
| 25 (Upper limit)<br>26 (Lower limit) |   |   | Drying         |
|                                      |   |   | Auto heat/cool |
|                                      |   |   |                |
| 29                                   | Humidifier operation which ignores the heat exchanger temperature | During heating operation, the humidifier operates when the heat exchanger temperature is suitable for humidifying. This setting is used to ignore this condition for humidifier operation and operate the humidifier more.  |                |
| 2A                                   | Filter input switching  | This setting switches the filter input according to the purpose of use.   |                |
| 2C                                   | Indoor unit electronic control valve                              | This setting indicates whether or not an indoor unit electronic control valve is present.<br>At the time of shipping, this setting is set according to the conditions of the indoor unit.   |                |
| 2E                                   | T10 terminal input switching                                      | Ordinarily, the T10 terminal is used as the HA terminal at the time of shipping. However, this setting is used when the T10 terminal is used for OFF reminder or for fire prevention input.   |                |
| 31                                   | Ventilation fan operation from remote controller                  | It is possible to install a total heat exchanger and ventilation fan in the system, which can be started and stopped by the wired remote controller. The ventilation fan can operate linked with the start and stop of the indoor unit, or can be operated even when the indoor unit is stopped.<br>Use a ventilation fan that can accept the no-voltage A contact as the external input signal.<br>In the case of group control, the fans are operated together. They cannot be operated individually. |                |
| 32                                   | Switching to remote controller sensor                             | This setting is used to switch from the body sensor to the remote controller sensor.<br>Check that "remote controller sensor" is displayed.<br>Do not use this setting with models that do not include a remote controller sensor.<br>Do not use this setting if both the body sensor and remote sensor are used.   |                |
| 34                                   | ON/OFF of "Operation change control in progress" display          | In a MULTI system with multiple remote controllers, switching between heating and cooling is restricted, and "Operation change control in progress" is displayed.<br>This setting is used to prevent this display from appearing.<br>Refer to the item concerned with operating mode priorities.  |                |
| 35                                   | OFF reminder function for weekly timer                            | This setting switches the operation when the weekly timer is connected to the remote controller.<br>This can be used to prevent cases in which the unit is accidentally left ON. There is no change when this setting is ON, however it is necessary to set the weekly timer ON time.   |                |

(Continued)



(Continued from previous page)

| <b>Item code</b> | <b>Item</b>   | <b>Description</b>  |
|------------------|---|---|
| <b>3C</b>        | Heat exchanger temperature for cold air discharge     | The heat exchanger temperature control point for prevention of cold air discharge during heating operation can be changed.  |
| <b>3d</b>        | Fan output switching                                  | The indoor unit PCB optional output for the fan can be switched according to the purpose of use.  |
| <b>3E</b>        | Drain pump delayed stop time                          | The drain pump stops after the set time delay after cooling operation stops.  |
| <b>40</b>        | Humidifier drain pump setting                         | This specifies the humidifier and drain pump setting.   |
| <b>45</b>        | DC flap operation mode                                | Changes flap operation to draft reduction mode.   |
| <b>46</b>        | DC flap swing mode                                    | Selects the swing operation mode for the flap.  |
| <b>5d</b>        | DC fan tap setting                                    | Sets the DC fan tap according to the purpose of use.<br>Change the settings data at the same time.  |
| <b>5E</b>        | Humidifier ON time                                    | Sets the humidifier output ON time for when the humidifier is operating.<br>ON/OFF control is performed during humidifier operation.<br>This setting therefore sets the ON time per 60-second interval. |
| <b>5F</b>        | Stop at time set for OFF timer after operation starts | This setting enables a function that stops operation when the amount of time set for the OFF timer has passed after remote controller operation was started.  |
| <b>60</b>        | Timer function change prohibit                        | This function prohibits changes from being made to the remote controller time setting.  |
| <b>62</b>        | Smudging control                                      | Smudging control is disabled when 0000 is set.  |

## ■ DC Fan Tap Change Procedure (Example of Type U2)

### <Procedure>

It is necessary to set the fan speed in accordance with the intended application and the optional parts to be used if any such part is used. (Table 1)

If this speed is not changed, a reduction in the air flow may result, causing the air outlet temperature to drop and condensation to form during cooling.

There are two ways to set the fan speed: either (1) change the positions of the DIP switches on the indoor unit control PCB or (2) set the speed using the wired remote controller. Select one of these ways.

\* Priority is given to setting the fan speed by changing the positions of the DIP switches.

(Table. 1) DC fan motor tap setting table

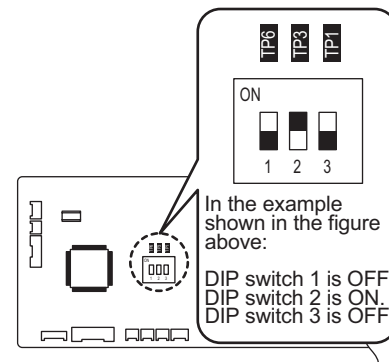
| Setting No | Item code 5D/5d setting data | Intended application / name of optional parts         | Setting No | Item code 5D/5d setting data | Intended application / name of optional parts         |
|------------|------------------------------|---|------------|------------------------------|---|
|            | 0000                         | Standard (factory setting)                            | (1)        | 0001                         | Air-flow blocking kit (for 3-way air flow)            |
| (1)        | 0001                         | High-ceiling setting 1 (with standard, ECONAVI panel) | (3)        | 0003                         | High-ceiling setting 2 (with standard, ECONAVI panel) |
|            |                              | Air-flow blocking kit (when a duct is connected.)     | (6)        | 0006                         | Air-flow blocking kit (for 2-way air flow)            |

### (1) When setting the fan speed by changing the positions of the DIP switches on the indoor unit control PCB

<Procedure> Be absolutely sure to turn off the power (earth-leakage circuit breaker).

- <1> On Table 1, check out the "Setting No." that corresponds to the intended application and the optional parts to be used.
- <2> Open the cover of the electrical parts box, and check the indoor unit control PCB. (Fig. 7-7)
- <3> Select the Setting No. which was checked out on Table 1, and change the positions of the DIP switches on the indoor unit control PCB.

| Setting No. | DIP switch   |
|-------------|--|
| (1)         | <p>DIP switch "ON" position<br/>"OFF" position</p> |
| (3)         | <p>DIP switch "ON" position<br/>"OFF" position</p> |
| (6)         | <p>DIP switch "ON" position<br/>"OFF" position</p> |



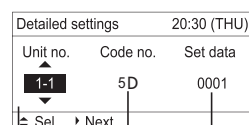
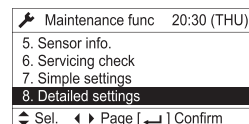
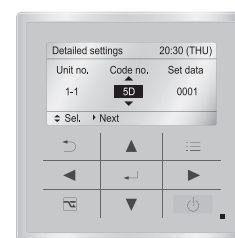
(Fig. 7-7) Indoor unit control PCB

### (2) When setting the fan speed using a wired remote controller (optional parts: CZ-RTC5A)

On Table 1, check out the "Item code 5D setting data" that corresponds to the intended application and the optional parts to be used.

<Procedure> Ensure that the unit has stopped operating before changing the fan speed.

- <1> Hold down the + + buttons together for at least 4 seconds. The maintenance function screen is displayed.
- <2> Use the / buttons to select the display and the / buttons to select the page. Select "8. Detailed settings" and press the button. The [Detailed settings screen] appears. Using the / buttons, select the unit No.
- <3> Using the / buttons, select the item code. Using the / buttons, change the item code to "5D."
- <4> Using the / buttons, select the setting data. Using the / buttons, change the setting data to the value checked out on Table 1, and press the button.
- <5> After selecting the unit No. using the / buttons, press the button. The [Detailed settings completion screen] appears. Select "Yes", and press the button.



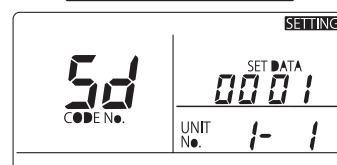
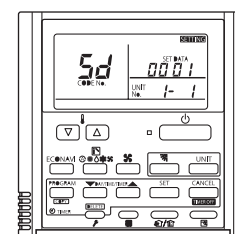
Unit No. | Setting data  
Item code

### (3) When setting the fan speed using a wired remote controller (optional parts: CZ-RTC4)

On Table 1, check out the "Item code 5d setting data" that corresponds to the intended application and the optional parts to be used.

<Procedure> Ensure that the units have stopped operating before changing the fan speed.

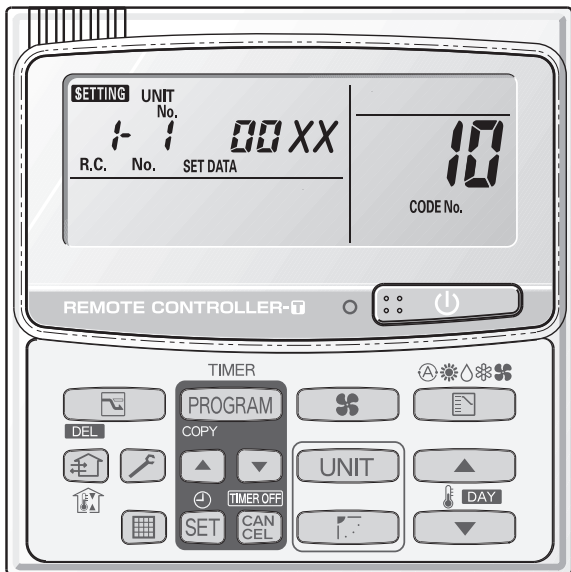
- <1> Hold down the + + buttons together for at least 4 seconds.
- <2> Each time the button is pressed, the numbers of the indoor units under group control are displayed in sequence. The fan motor of only the indoor unit that has been selected will run.
- <3> Specify item code "5d" using the temperature setting ( / ) buttons.
- <4> Change the setting data using the hour buttons. The setting data details are as given on Table 1.
- <5> Press the button. (OK if the display changes from flashing to lighted.)
- <6> Press the button. The normal stop status is established. Go to step <2> to change the selected indoor unit.
- <7> Press the button. The normal stop status is established.



## 7-7. Remote Controller Servicing Functions

- The remote controller includes a number of servicing functions. Use these as needed for test runs and inspections.

















### ■ Timer Remote Controller CZ-RTC2



CZ-RTC2








Fig. 7-8

### List of Servicing Functions

| Functions                  | Description   | Button operation  | Reset operation   | Unit status   |
|----------------------------|---|---|---|---|
| Test run                   | Operation with forced thermostat ON   | Press and hold the  button for 4 seconds or longer.  | Press the  button. | Current operation is maintained.  |
| Sensor temperature display | Temperature display from each sensor  | Press and hold the  and  buttons for 4 seconds or longer.   |   |   |
| Servicing check display    | Alarm history display   | Press and hold the  and  buttons for 4 seconds or longer.   |   |   |
| Simple settings            | Filter lifetime, operating mode priority, central control address, and other settings | Press and hold the  and  buttons for 4 seconds or longer.   | Automatic reset   | When settings are made from a remote controller, the indoor unit where that remote controller is connected stops. |
| Detailed settings          | System address, indoor unit address, central control address, and other settings      | Press and hold the  ,  and  buttons for 4 seconds or longer. |   |   |
| Automatic address          | Automatic address setting based on command from the wired remote controller           | Press and hold the  and the timer operation  buttons for 4 seconds or longer.   | Press the  button. | Entire system stops.  |
| Address change             | Change of indoor unit address   | Press and hold the  and the timer operation  buttons for 4 seconds or longer.   |   |   |

## ■ High-spec Wired Remote Controller CZ-RTC3 / CZ-RTC5A

Display of "maintenance function" screen

- ① Keep pressing the ,  and  buttons simultaneously for 4 or more seconds. The "Maintenance func" screen appears on the LCD display.
- ② Press the  or  button to see each menu. If you wish to see the next screen instantly, press the  or  button.

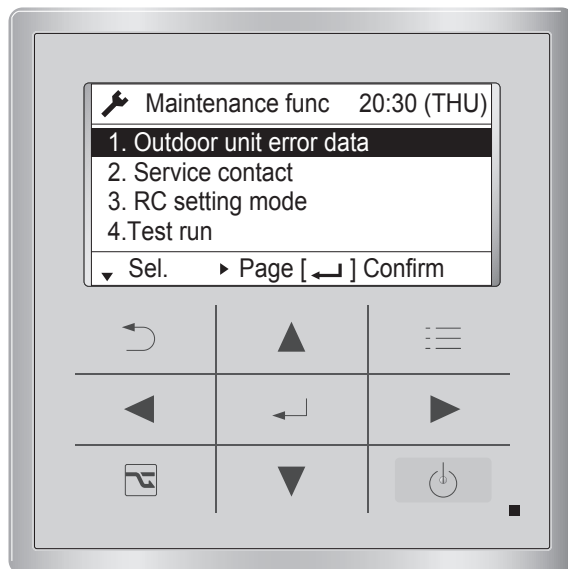


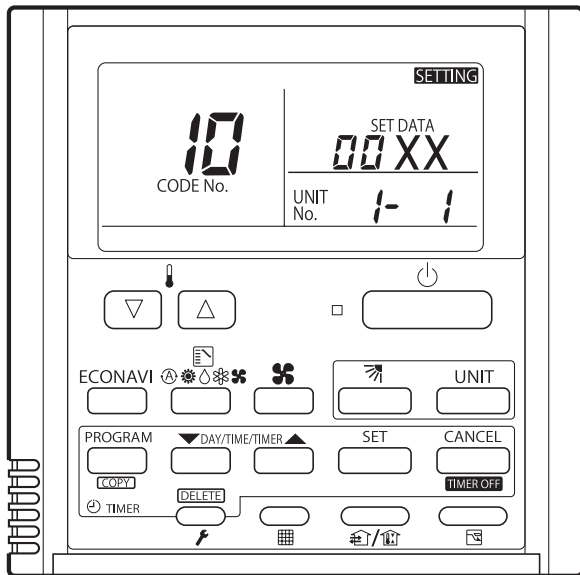


Fig. 7-9

### List of Servicing Functions

| Functions                  | Description   | Menu selection       | Reset operation   | Unit status   |
|----------------------------|---|----------------------|---|---|
| Test run                   | Operation with forced thermostat ON   | 4. Test run          |   |   |
| Sensor temperature display | Temperature display from each sensor  | 5. Sensor info.      | Press the  button.             |   |
| Servicing check display    | Alarm history display   | 6. Servicing check   |   |   |
| Simple settings            | Filter lifetime, operating mode priority, central control address, and other settings | 7. Simple settings   | Press the  button. (Restart) | When settings are made from a remote controller, the indoor unit where that remote controller is connected stops. |
| Detailed settings          | System address, indoor unit address, central control address, and other settings      | 8. Detailed settings |   |   |
| Automatic address          | Automatic address setting based on command from the wired remote controller           | 9. Auto address      | Automatic reset   | Entire system stops.  |

## ■ Timer Remote Controller CZ-RTC4



CZ-RTC4

Fig. 7-10




### List of Servicing Functions

| Functions                  | Description   | Button operation  | Reset operation    | Unit status   |
|----------------------------|---|---|--------------------|---|
| Test run                   | Operation with forced thermostat ON   | Press and hold the  button for 4 seconds or longer.                           | Press the  button. | Current operation is maintained.  |
| Sensor temperature display | Temperature display from each sensor  | Press and hold the  and  buttons for 4 seconds or longer.                     |                    |   |
| Servicing check display    | Alarm history display   | Press and hold the  and  buttons for 4 seconds or longer.                     |                    |   |
| Simple settings            | Filter lifetime, operating mode priority, central control address, and other settings | Press and hold the  and  buttons for 4 seconds or longer.                     | Automatic reset    | When settings are made from a remote controller, the indoor unit where that remote controller is connected stops. |
| Detailed settings          | System address, indoor unit address, central control address, and other settings      | Press and hold the ,  and  buttons for 4 seconds or longer.                   |                    |   |
| Automatic address          | Automatic address setting based on command from the wired remote controller           | Press and hold the  and the timer operation  buttons for 4 seconds or longer. | Press the  button. | Entire system stops.  |
| Address change             | Change of indoor unit address   | Press and hold the  and the timer operation  buttons for 4 seconds or longer. |                    |   |

## 7-8. Test Run Function

Operates the unit with the thermostat forced ON.

### <Procedure of CZ-RTC2>

- ① Press and hold the  button for 4 seconds or longer.
- ② "TEST" appears on the remote controller LCD display (Fig. 7-11).
- ③ Press the  button to start the test run.
- ④ Press the  button to return to normal remote controller display.

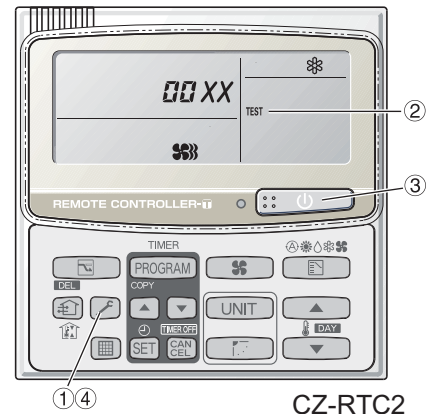



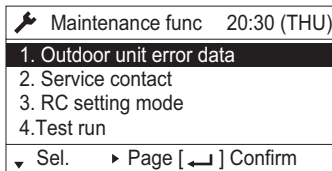







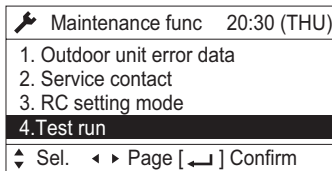
Fig. 7-11 CZ-RTC2




### <Procedure of CZ-RTC3 / CZ-RTC5A>

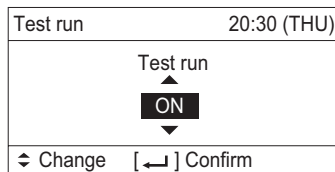
- ① Keep pressing the , , and  buttons simultaneously for 4 or more seconds. The "Maintenance func" screen appears on the LCD display.






- ② Press the  or  button to see each menu. If you wish to see the next screen instantly, press the  or  button. Select "4. Test run" on the LCD display and press the  button.



Change the display from OFF to ON by pressing the  or  button. Then press the  button.



### <Procedure of CZ-RTC4>

- ① Press and hold the  button for 4 seconds or longer.
- ② "TEST" appears on the remote controller LCD display (Fig. 7-13).
- ③ Press the  button to start the test run.
- ④ Press the  button to return to normal remote controller display.

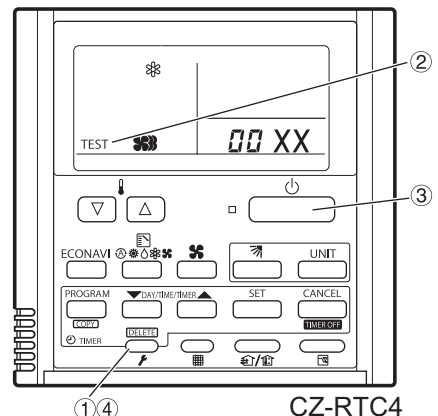
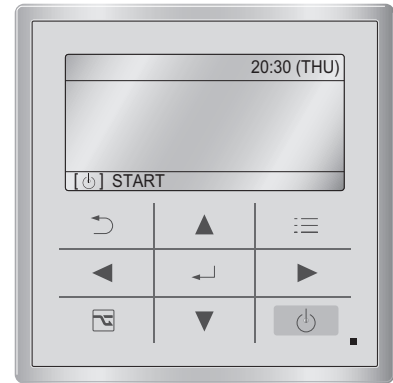

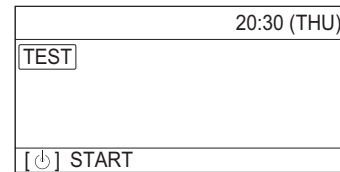



Fig. 7-13 CZ-RTC4

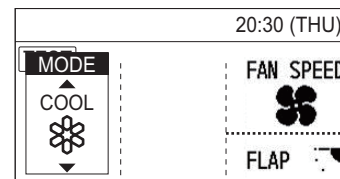


CZ-RTC3 / CZ-RTC5A  
Fig. 7-12

- ③ Press the  button. "TEST" will be displayed on the LCD display.









- ④ Press the  button. Test run will be started. Test run setting mode screen appears on the LCD display.



## ■ Sensor Temperature Display Function (displayed regardless of whether unit is operating or stopped)

The procedure below displays the sensor temperatures from the remote controller, indoor unit, and outdoor unit on the remote controller.

### <Procedure of CZ-RTC2>

- ① Press and hold the  and  buttons simultaneously for 4 seconds or longer.
- ② The unit No. "X-X" (main unit No.), item code "XX" (sensor address), and servicing monitor "00XX" (sensor temperature) are displayed on the remote controller LCD display. (See Fig. 7-14 at right.)
- ③ Press the temperature setting   buttons and select the item code to the address of the sensor to monitor.  
(For the relationships between the sensor addresses and sensor types, refer to the table of temperature sensors and addresses at below.)
- ④ If group control is in effect, press the  button to select the unit to monitor.  
Press the temperature setting buttons to select the item code to change.
- ⑤ Press the  button to return to normal remote controller display.

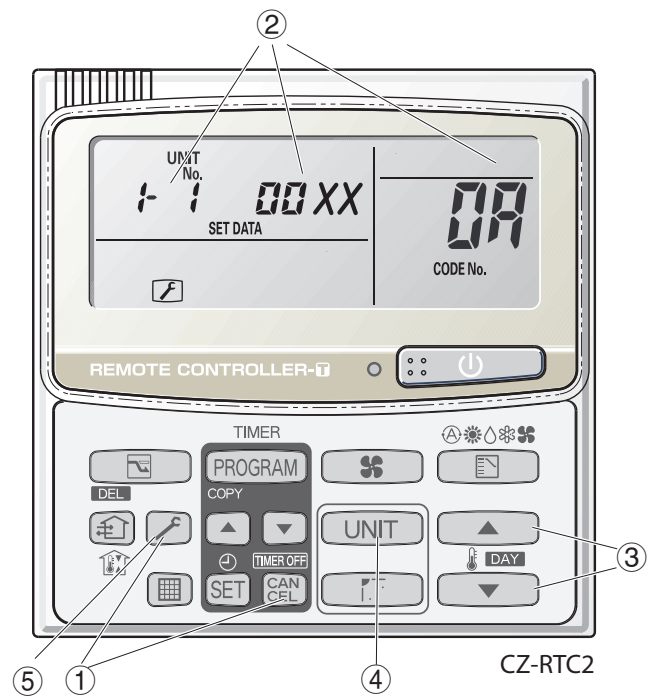


Fig. 7-14

### Note:




The temperature display appears as "- - -" for units that are not connected.

- \* If monitor mode is engaged while normal operation is in progress, only the parts of the LCD display shown in the figure will change. Other parts continue to display the same information as during normal operation.






|                  | Item code         | Meaning of Code                        |
|------------------|-------------------|--|
| Indoor unit data | 02                | Indoor unit intake temp.               |
|                  | 03                | Indoor unit heat exchanger temp. (E1)  |
|                  | 04                | Indoor unit heat exchanger temp. (E2)  |
|                  | 05                | -                                      |
|                  | 06                | -                                      |
|                  | 07                | -                                      |
|                  | 08                | -                                      |
|                  | 09                | -                                      |
|                  | Outdoor unit data | 0A                                     |
| 0b               |                   | -                                      |
| 0C               |                   | Outdoor unit heat exchanger temp. (C2) |
| 0d               |                   | Intake temp. (TS)                      |
| 0E               |                   | Outdoor unit heat exchanger temp. (C1) |
| 0F               |                   | -                                      |
| 10               |                   | -                                      |
| 11               |                   | Outdoor air temp. (TO)                 |
| 12               |                   | -                                      |
| 13               |                   | -                                      |
| 14               |                   | Current value                          |
| 15               |                   | Outdoor MV value                       |
| 16               |                   | -                                      |
| 19               | Frequency         |  |

\* Depending on the model, some items may not be displayed.



**<Procedure of CZ-RTC3 / CZ-RTC5A>**

- ① Keep pressing the ,  and  buttons simultaneously for 4 or more seconds. The "Maintenance func" screen appears on the LCD display.

|                            |            |             |
|----------------------------|------------|-------------|
| Maintenance func           |            | 20:30 (THU) |
| 1. Outdoor unit error data |            |             |
| 2. Service contact         |            |             |
| 3. RC setting mode         |            |             |
| 4. Test run                |            |             |
| ▼ Sel.                     | ▶ Page [←] | Confirm     |

- ② Press the  or  button to see each menu. If you wish to see the next screen instantly, press the  or  button. Select "5. Sensor info." on the LCD display and press the  button.



|                      |             |             |
|----------------------|-------------|-------------|
| Maintenance func     |             | 20:30 (THU) |
| 5. Sensor info.      |             |             |
| 6. Servicing check   |             |             |
| 7. Simple settings   |             |             |
| 8. Detailed settings |             |             |
| ↕ Sel.               | ◀▶ Page [←] | Confirm     |

Select the "Unit no." by pressing the  or  button for changes.

|              |          |             |
|--------------|----------|-------------|
| Sensor info. |          | 20:30 (THU) |
| Unit no.     | Code no. | Data        |
| ▲            | 00       | 0026        |
| 1-1          | 01       | 0028        |
| ▼            | 02       | 0026        |
| ↕ Sel.       | ▶ Next   |             |

Then press the  button. Display sensor information of the unit.

|              |          |             |
|--------------|----------|-------------|
| Sensor info. |          | 20:30 (THU) |
| Unit no.     | Code no. | Data        |
| 1-1          | 00       | 0026        |
|              | 01       | 0028        |
|              | 02       | 0026        |
| ↕ Scroll     |          |             |

Refer the information by pressing the  or  button.









CZ-RTC3 / CZ-RTC5A

Fig. 7-15



<Procedure of CZ-RTC4>

- ① Press and hold the  and  buttons simultaneously for 4 seconds or longer.
- ② The unit No. "X-X" (main unit No.), item code "XX" (sensor address), and servicing monitor "00 YY" (sensor temperature) are displayed on the remote controller LCD display. (See Fig. 7-16 at right.)
- ③ Press the temperature setting  /  buttons and select the item code to the address of the sensor to monitor.
- ④ If group control is in effect, press the  button to select the unit to monitor.  
Press the temperature setting buttons to select the item code to change.
- ⑤ Press the  button to return to normal remote controller display.

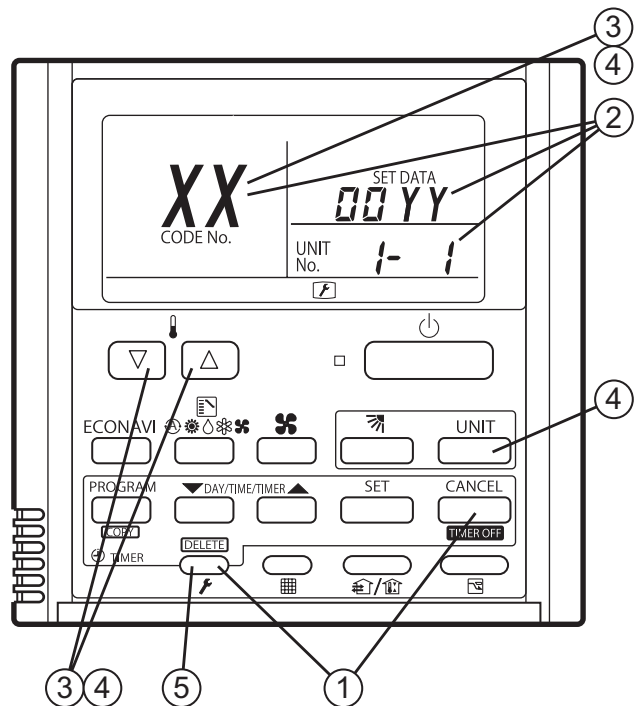














Fig. 7-16

## Automatic address setting






### <Procedure of CZ-RTC3 / CZ-RTC5A>

- Keep pressing the ,  and  buttons simultaneously for 4 or more seconds. The "Maintenance func" screen appears on the LCD display.
- Press the  or  button to see each menu. If you wish to see the next screen instantly, press the  or  button. Select "9. Auto address" on the LCD display and press the  button.

|   |             |
|---|-------------|
|  Maintenance func          | 20:30 (THU) |
| <b>9. Auto address</b>  |             |
| 10. Set elec. consumption   |             |
| 11. Set touch key   |             |
| 12. Check touch key   |             |
| ↕ Sel. ◀ Page [  ] Confirm |             |

- The "Auto address" screen appears on the LCD display. Change the "Code no." to "A1" by pressing the  or  button.

|               |              |
|---------------|--------------|
| Auto address  | 20:30 (THU)  |
| Code no.      | O/D unit no. |
| <b>A1</b>     | 1            |
| ↕ Sel. ▶ Next |              |




- Select the "O/D unit no." by pressing the  or  button. Select one of the "O/D unit no." for automatic address by pressing the  or  button. Then press the  button. Approximately about 10 minutes are required. When automatic address setting is completed, the units return to normal stopped status.










CZ-RTC3 / CZ-RTC5A



Fig. 7-17

## Checking indoor unit addresses



- Keep pressing the ,  and  buttons simultaneously for 4 or more seconds. The "Maintenance func" screen appears on the LCD display.

|   |             |
|---|-------------|
|  Maintenance func           | 20:30 (THU) |
| <b>1. Outdoor unit error data</b>   |             |
| 2. Service contact  |             |
| 3. RC setting mode  |             |
| 4. Test run   |             |
| ▼ Sel. ▶ Page [  ] Confirm |             |

- Press the  or  button to see each menu. If you wish to see the next screen instantly, press the  or  button. Select "7. Simple settings" on the LCD display and press the  button.

|   |             |
|---|-------------|
|  Maintenance func             | 20:30 (THU) |
| 5. Sensor info.   |             |
| 6. Servicing check  |             |
| <b>7. Simple settings</b>   |             |
| 8. Detailed settings  |             |
| ↕ Sel. ◀ ▶ Page [  ] Confirm |             |

The "Simple settings" screen appears on the LCD display.

Select the "Unit no." by pressing the  or  button for changes.

|                 |             |          |
|-----------------|-------------|----------|
| Simple settings | 20:30 (THU) |          |
| Unit no.        | Code no.    | Set data |
| <b>3-1</b>      | 01          | 0001     |
| ↕ Sel. ▶ Next   |             |          |

The indoor unit fan operates only at the selected indoor unit.

## 8. HOW TO INSTALL THE WIRELESS REMOTE CONTROLLER RECEIVER

|   |      |
|---|------|
| ■ Important Safety Instructions .....   | 8-2  |
| ■ Optional Controller (Remote Controller) .....                               | 8-3  |
| 8-1. Names and Functions .....  | 8-3  |
| 8-2. Installing Batteries .....   | 8-5  |
| 8-3. Setting the Current Time .....   | 8-5  |
| 8-4. Operation .....  | 8-6  |
| 8-5. Timer Operation .....  | 8-7  |
| 8-6. Adjusting the Wind Direction .....                                       | 8-8  |
| 8-7. Operating Multiple In/Outdoor Units Simultaneously (Group Control) ..... | 8-8  |
| 8-8. Using the Remote Controller .....  | 8-9  |
| 8-9. For Best Results .....   | 8-9  |
| 8-10. Addresses .....   | 8-9  |
| 8-11. Emergency Operation .....   | 8-11 |
| 8-12. Miscellaneous Settings .....  | 8-12 |
| 8-13. Before Requesting Service .....   | 8-13 |
| ■ How to Install the Wireless Remote Controller Receiver .....                | 8-14 |
| 8-14. Common to All Models.....   | 8-14 |
| 8-15. CZ-RWSU3 .....  | 8-16 |
| 8-16. CZ-RWSC3 .....  | 8-18 |
| 8-17. CZ-RWST3N .....   | 8-22 |
| 8-18. Common to All Models.....   | 8-24 |

## ■ Important Safety Instructions

### WARNING

#### Installation Precautions

- Do not install yourself  
Installation should always be performed by your dealer or a professional service provider.  
Electric shock or fire may result if an inexperienced person performs any installation or wiring procedures incorrectly.
- Use only specified air conditioners  
Always use only air conditions specified by the dealer.

#### Precautions for Use

- Do not touch switches with wet hands  
Electric shock and damage to the system can result.
- Protect the remote controller from water  
Damage to the system can result.
- Stop the system and turn the power off if you sense unusual smells or other irregularities  
Continuing operation when the system is out of order can result in electric shock, fire, and damage to the system.  
Contact your dealer.
- Do not swallow the battery.

#### Moving and Repair Precautions

- Do not repair  
Never repair the system by yourself.
- Contact your dealer before moving the system  
Contact your dealer or a professional service provider about moving and reinstalling the system.  
Electric shock or fire may result if an inexperienced person performs any installation procedures incorrectly.





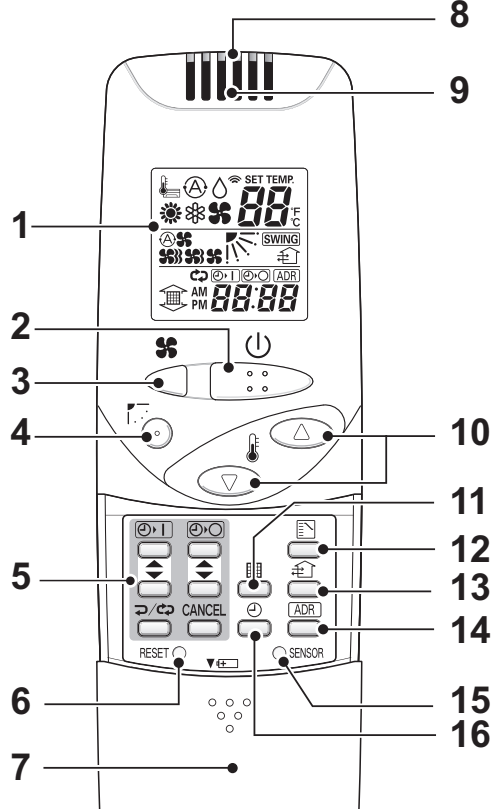










## ■ Optional Controller (Remote Controller)


Wireless Remote Controller CZ-RWSU3 / CZ-RWSC3 / CZ-RWSK2 / CZ-RWST3N

One remote controller can control a group of up to eight indoor units.

### 8-1. Names and Functions

#### REMOTE CONTROLLER

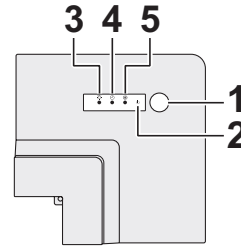
|  |  |   |   |
|--|--|---|---|
| <b>1. Operation Display</b>  | Displays the operation status.<br>(The figure shows all the statuses.) <ul style="list-style-type: none"> <li>The auto-flap display may be different, depending on the installed unit.</li> </ul>  | <b>15. Sensor button</b>  | Use this button to activate the temperature sensor on the remote controller instead of the one on the indoor unit. The temperature sensor on the indoor unit is selected before shipment. At this time  is shown on the display. |
| <b>2. Start/Stop button</b>   | Pressing this button once starts and pressing again stops the operation.   | <b>16. Clock button</b>  | Use this button to set the clock.   |
| <b>3. Fan speed button</b>    |  |                          |   |
| <b>4. Swing/Wind Direction button</b>   |  |   |   |
| <b>5. Timer setting button</b>   | Use for operating with a timer.  |   |   |
| <b>6. Reset button</b>   | Use this button after changing the batteries.  |   |   |
| <b>7. Cover</b>  | Press at the top center and then slide down.   |   |   |
| <b>8. Transmitter</b>  |  |   |   |
| <b>9. Remote controller sensor</b>   | Detects the temperature at the remote controller when detection has been switched to the remote controller by the sensor button.   |   |   |
| <b>10. Temperature setting buttons</b>   |  raises the temperature setting 1 °C at a time.<br> lowers the temperature setting 1 °C at a time.   |   |   |
| <b>11. Filter button</b>    | <b>CZ-RWSC3</b><br>Press to turn off the filter lamp on the receiver.  |   |   |
| <b>12. Mode Select button</b>   | Press to switch the operation mode.  |   |   |
| <b>13. Ventilation button</b>   | Use this button when connected to an aftermarket fan. Pressing this button starts and stops the fan. When the air conditioner is started or stopped, the fan starts or stops at the same time. (  appears on the display of the remote controller when the fan is operating.) |   |   |
| <b>14. Address button</b>   |  |   |   |

From this page on the names of remote controller's buttons will be indicated with the above illustrations.  
 E.g.: Start/Stop button → 

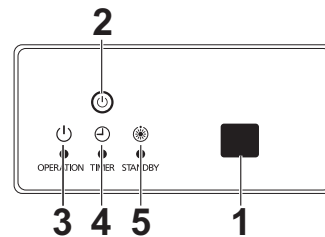
## RECEIVER

|                                      |  |
|--------------------------------------|--|
| <b>1. Receiver</b>                   | Receives the signal sent from the remote controller.   |
| <b>2. Emergency operation button</b> | <b>Display lamps</b><br>When an error occurs, one of the lamps flashes. When a display lamp is blinking, refer to " Before Requesting Service ".   |
| <b>3. Operating lamp</b>             | This lamp is lit when the unit is operating.   |
| <b>4. Timer lamp</b>                 | This lamp is lit when the timer is set.  |
| <b>5. Standby lamp</b>               | <ul style="list-style-type: none"> <li>When the heater is working, the lamp lights at the following times.<br/>When the thermostat has operated during defrosting at the time of the startup.</li> <li>The lamp flashes when an error occurs.</li> </ul> |
| <b>6. Filter lamp</b>                | This lamp is for notifying you when the filter needs to be cleaned.  |

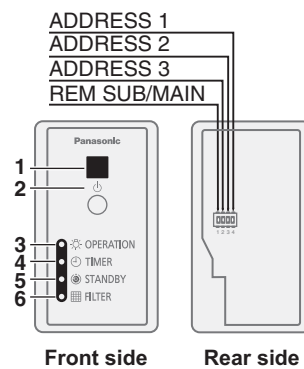
### CZ-RWSU3



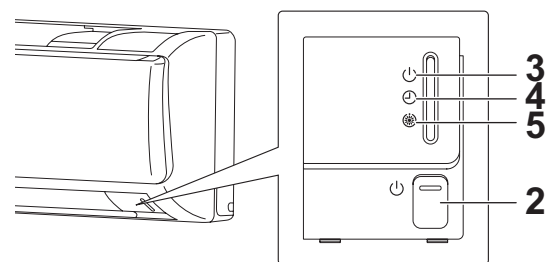
### CZ-RWST3N



### CZ-RWSC3



### Indoor Unit (CZ-RWSK2)



## NOTE

- If a heat pump model is being used, it will beep twice and the operating lamp will light up on the display; if the timer and standby lamps blink alternately, a conflict between the heating and cooling exists, so the unit cannot operate in the desired mode. (On models that do not have an Auto function, even if Auto is selected, it works in the same way.)
- When the local operation is disabled by such as the centralized control, and if the Start, Stop, Mode or Temperature setting buttons are pressed, the unit will beep five times and the change will not be made.

## 8-2. Installing Batteries

1. Remove the cover.

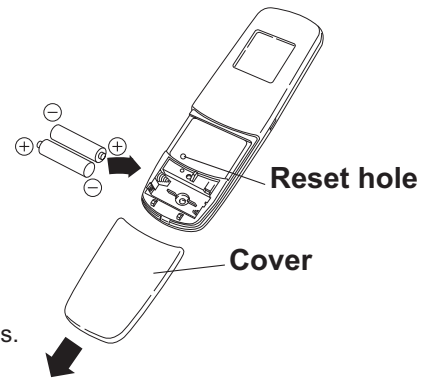
2. Insert two LR03 size batteries.

Put the batteries in with the polarity [+/-] as shown in the figure.

3. Gently insert one end of an unfolded paper clip (or a similar object that can fit) into the Reset hole and press the Reset button inside the hole, then put the cover back on.

### NOTE

- Change the batteries when the display of the remote controller gets weak or if it will not work unless close to the receiver.  
(Alkaline batteries generally last about one year.)
- When changing batteries, always use two fresh batteries of the same make.
- If the remote controller will not be used for a long period of time, remove the batteries.
- Please dispose of batteries appropriately.
- After changing the batteries, follow the procedures on the next page to reset the current time.



## How to remove batteries

1. Remove the cover.

2. Press the battery toward the negative end and lift it out by its positive end.  
(As shown at right)

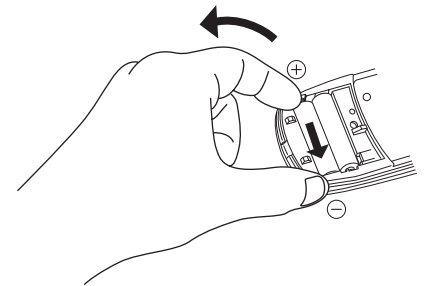
3. Remove the other battery in the same way.

### NOTE

- Dispose of the used batteries at the designated location in compliance with the applicable local ordinances.

### WARNING

- Do not swallow the battery.
- After removing the battery from remote controller, keep it away from the reach of children.  
The battery can cause death by suffocation if swallowed.
- When inserting the battery, make sure the polarities (+ and -) are correct.



## 8-3. Setting the Current Time

After changing the batteries and pressing reset, be sure to reset the current time.

(When reset is pressed, the current time reverts to [0:00])

1. Press  $\ominus$  for two seconds or more.

Once the clock displays starts blinking, the clock can be set.

2. Set the hour with  $\blacktriangle$  /  $\blacktriangledown$  of the  $\odot 1$ .

If you press and hold the button, the time changes quickly.

3. Set the minutes with  $\blacktriangle$  /  $\blacktriangledown$  of the  $\odot 0$ .

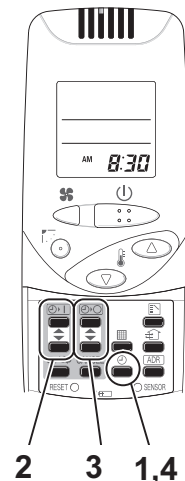
If you press and hold the button, the time changes quickly.

4. Pressing  $\ominus$  completes the time setting.

- While you are setting the current time, the time display flashes but the colon does not.
- If the buttons are not pressed for three minutes while setting the current time, it is set to the displayed time.

### NOTE

When reset is pressed, the timer settings are deleted.















## 8-4. Operation





**Auto** , **Heat** , **Dry** , **Cool** , **Fan** 

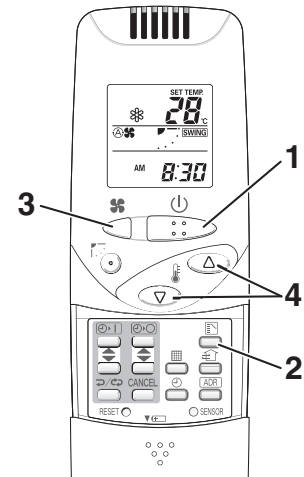
Models that only provide the cooling function cannot operate in the auto or heating modes.

**Power:** Turn on the power of the indoor unit at least 14 hours before operation.

1. Press .
2. Press  and select from among Auto , Heat , Dry , Cool  and Fan .
3. Press  and select the desired speed.  
If set to Auto  , the fan speed switches automatically.  
(Auto does not work when in the Fan mode.)
4. Press one of the   buttons and set the desired temperature.

Temperature settings cannot be made when in the Fan mode.

|     | Auto  | Heat  | Dry  / Cool  |
|-----|--|--|--|
| MAX | 27   | 30   | 30   |
| MIN | 17   | 16   | 18   |



**Stop:** Press .

When the unit is stopped with the remote controller, the fan on the outdoor unit may continue to run for a while, even though the compressor of the outdoor unit stops.

**If the unit is not heating very effectively with a Low fan speed , switch the fan speed to High  or  Medium.**

Depending on the indoor unit being used, it may indicate a function that it does not have. (The fan speed is set.)


**If you cannot turn the air conditioner off in the normal way.**

Disconnect the power to the indoor unit and contact the dealer where the product was purchased.

### <Auto Operation>

Only when identical refrigerant system inside all the indoor units or cooling/heating free-type are under control as one group. It heats or cools automatically via the differences between the set temperature and the room temperature.

### <Dry Operation>



- Depending on the indoor unit used, the remote controller may have a [Dry]  indicator on its display even though the unit does not have the Dry function. (Same as cooler operation)
- When the room temperature approaches the temperature setting, the unit continues to start up or stop automatically.
- When the drying mode stops operating, the indoor unit's fan blows a gentle breeze in order to keep the moisture from returning to the room at a minimum.
- Depending on the indoor unit used, and/or the temperature in the room, the fan speed may not be adjustable.
- Depending on the unit used, when the outside air temperature is 15 °C or less, the dry function will not operate.



## 8-5. Timer Operation

- When setting the timer, make sure the current time on the remote controller is accurate.
- The timer's clock can only be set when the display of the remote controller is ON.
- After setting the timer, put the remote controller in a place where its signal will reach the receiver of the indoor unit. (When the time set for the timer is reached, a signal is sent from the remote controller to Start/Stop the unit.)

### Using the Timer

1. Press either ▲ / ▼ of the  or , and while the time is being displayed, if you press ▲ / ▼ again, a scheduled time can be set.


The time last set on the timer is displayed.

“--:--” indicates time to change the batteries.

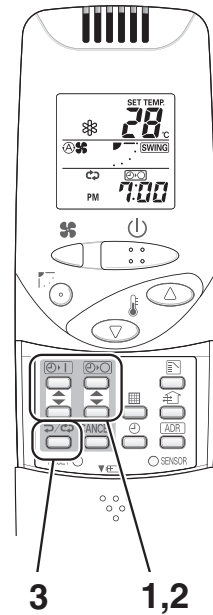
2. Press either ▲ / ▼ of the  or  and set the timer to the desired time.

Every time you press ▲ / ▼, the time changes in 10 minute increments.

If you press and hold the button, the time changes quickly.

3. After setting the timer, if you press , the time you set changes to a steady display, indicating settings are complete.



After the timer setting is displayed for three seconds, the display reverts to the current time.




### Combining ON and OFF Timers

- Setting the ON and OFF timers, respectively.

### Checking the timer setting

- If you press either ▲ / ▼ for the  or the , the scheduled time is displayed for four seconds.
- When no timer setting has been made, it displays --:--. (Initial Setting)





### Changing a timer setting

- Press ▲ / ▼ for the  or the , and then when the timer setting is displayed, press ▲ / ▼ for the timer again.

### Canceling a timer setting

- If you press [CANCEL], the timer setting is canceled.
- If you wish to cancel the setting for either the  or the  timer, press ▲ / ▼, and long-press [CANCEL] while scheduled time is displayed.

### Using the same timer setting every day

- If you press  for 2 or more seconds, “” is displayed and the **ON timer** or the **OFF timer** will operate the unit at the same time every day.
- If you press  again for two seconds or more, “” goes off and the timer operates only one time.


## 8-6. Adjusting the Wind Direction

- Never try to manually move the flap (up-down wind direction plate) that is operated by the remote controller.
- When the unit stops, the flap (up-down wind direction plate) automatically faces downwards.
- When the unit is in heating standby, the flap (up-down wind direction plate) faces upward.



Also, bear in mind that the flap starts swinging after the heating standby mode is released, but the display on the remote controller indicates Auto Flap during standby heating as well.

### CZ-RWSU3 / Indoor Unit (CZ-RWSK2) / CZ-RWST3N



#### Setting the Wind Direction

While the unit is operating, every time you press , the direction the flap faces changes.

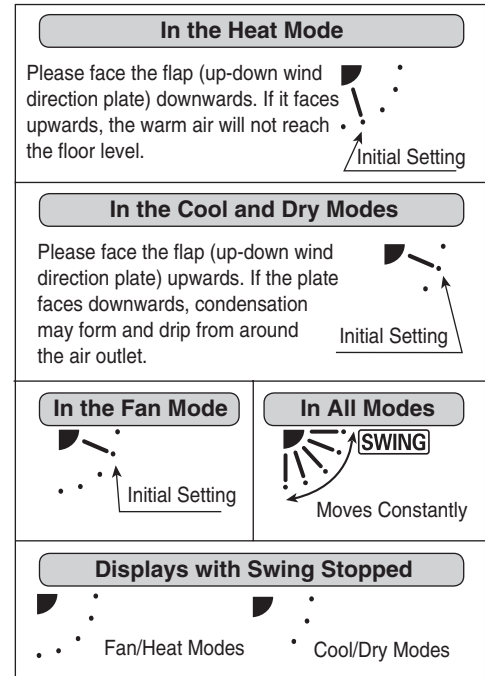
#### Setting Flap to Swing

If you press  to set the flap (up-down wind direction plate) in its most downward facing position, and then press  again, **SWING** is displayed and the flap swings automatically up and down.

#### Stopping Flap Swing

If you press  again while the flap is swinging, you can stop the flap from swinging and set it in place as desired. Thereafter, if you press , you can set the wind direction starting from the most upward position.

- When the unit is in the Cool or Dry modes, the flap cannot stop facing downwards. If you try to stop the flap from swinging while it is facing downwards, it will continue moving until it is in the third position from the top.



### CZ-RWSC2

The available functions differ depending on the indoor unit being used.

The wind direction cannot be set via remote controller for any models other than those noted below.

For more information, please refer to the users' manual that came with your indoor unit.

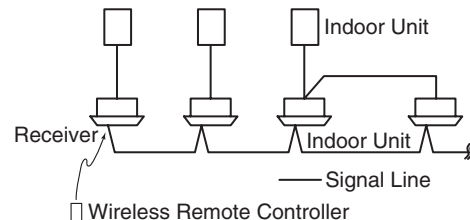
**Four-direction Ceiling Cassette Models, Bi-directional Ceiling Cassette Models, Unidirectional Cassette Models for High Ceilings, Ceiling Suspended Models, Wall-Mounted Models**

Please refer to *Setting the Wind Direction and Stopping Flap Swing*.

## 8-7. Operating Multiple In/Outdoor Units Simultaneously (Group Control)

**Group control works well for providing air conditioning to one, large room with more than one air conditioning units.**


- One remote controller can operate up to eight indoor units.
- All the indoor units have identical settings.
- Set temperature sensing to the indoor unit (Main Sensor). (See page 8-3.)



## 8-8. Using the Remote Controller

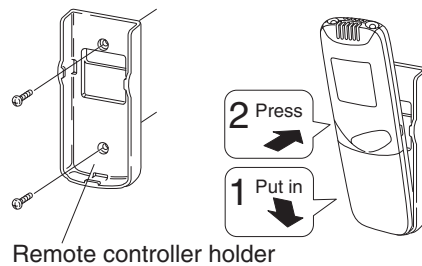
- Point the transmitter of the remote controller at the receiver. When the signal is received correctly it will beep once. (It beeps twice only when the unit starts operating.)
- The signal can be received at a distance of about 6 meters. This distance should be used only as a guide. It depends on battery strength.
- Make sure nothing is between the remote controller and the receiver that could block the signal.
- Do not leave the remote controller in direct sunlight, where the wind from the air conditioner can blow directly on it, or near any other heat source.
- Take care not to drop, throw or wash the remote controller with water.
- The signal from the remote controller may not be received in rooms with rapid start fluorescent lighting, inverter lights, plasma displays, LCD televisions (monitor), etc. For more information, please contact the dealer where the product was purchased.

### Wall Mount Use

- Press  from the location you wish to mount the remote controller and make sure the signal is received properly.
- Pull the remote controller forward to remove it.

Fasten the remote controller holder with screws.

Fitting the remote controller in the holder.



## 8-9. For Best Results

### Don't get the remote controller too far away from the receiver.

This may cause a malfunction. Be sure to keep the remote controller in the same room as the receiver.

### Point the remote controller at the receiver.

When the signal is received properly, it will beep one time.

### Avoid locating the remote controller where it is covered, such as behind a curtain.

Keep it out in the open.

## 8-10. Addresses


**In both multi and single unit installations**, when more than one indoor units are installed in the same room with a compatible wireless remote controller, addresses can be set up to avoid crosstalk. By setting the address switches on the receivers and matching them with the number of addresses on the remote controller, up to six indoor units can be controlled separately with the remote controller. (When using units in a flexible combination or operating multiple units simultaneously, they cannot be controlled individually as they are operated at the same time.) There are separate address settings, receiver addresses for the receivers and transmitter addresses for the remote controller.

For more information, please contact the distributor where the product was purchased.

- The setting procedure is different for Indoor Unit (CZ-RWSK2). (See Setting Addresses in the next page.)
- These settings are saved in nonvolatile memory in the remote controller, so even when its batteries are changed, the settings do not have to be made again.

\* 1 CZ-RWST3N is of receivers (Inside the indoor unit)

### Checking Addresses

When you press  on the remote controller, its current address appears on the display. If this address corresponds to the address of a receiver, the buzzer sounds. (If it is on ALL, the buzzer will always sound.)

If it is on ALL, it can be operated regardless of receiver addresses. Point the remote controller at the receiver you wish to operate and transmit.

## Matching up Addresses

### Setting Remote Controller Addresses

1. If you press **[ADR]** and **↶/↷** at the same time, "SET" will blink.
2. While holding **[ADR]** down, every time you press **↶/↷**, it cycles from ALL → 1 → 2 → 3... 6 → ALL.  
Set it to the receiver address switch of the indoor unit you wish to operate.
3. When you release **[ADR]**, the address that was displayed is set.  
When you do this, if it corresponds to the receiver's address setting, the buzzer sounds.

|  |  |  |  |  |  |  |  |
|--|--|--|--|--|--|--|--|
| Address Display on the Remote Controller                   |  |  |  |  |  |  |  |
| <b>CZ-RWSU3</b>  |  |  |  |  |  |  |  |
| Position of receiver's (inside indoor unit) address switch | The position of the receiver's address switch does not matter. |  |  |  |  |  | For 1, 2 and 3, set the switch on the right and for 4, 5 and 6, to the left.<br> |
| <b>CZ-RWST3N</b>   |  |  |  |  |  |  |  |
| Position of receiver's (inside indoor unit) address switch | The position of the receiver's address switch does not matter. |  |  |  |  |  | For 1, 2 and 3, set the switch on the left and for 4, 5 and 6, to the right.<br> |
| <b>CZ-RWSC3</b>  |  |  |  |  |  |  |  |
| Position of the Receiver's Address Switch                  | The position of the receiver's address switch does not matter. |  |  |  |  |  | For 1, 2 and 3, set the switch on the left and for 4, 5 and 6, to the right.<br> |

### Setting Addresses (CZ-RWSK2)

#### (Setting the address of the indoor unit)

1. First of all, set the address for the remote controller with Setting Remote Controller Address (See the previous page).
2. Press **[Emergency Operation]** **⏻** of the indoor unit for four seconds or more.  
When you do this, the lamps of the display will blink one after another.
3. Press **[ADR]** on the remote controller.
4. The buzzer will sound and the address of the indoor unit will change to the address displayed on the remote controller.
5. If you press **[Emergency Operation]** **⏻** of the indoor unit once, the lamps on the indoor unit's display will turn off.

#### NOTE

- Please do not hold the **[Emergency Operation]** **⏻** button of the indoor unit down while the indoor unit's display lamps are blinking one after another.
- Make sure to operate while the indoor unit is stopped.
- The address of indoor unit is set to "ALL" at the time of the shipment.

## 8-11. Emergency Operation

Use [Emergency Operation]  in the following situations when there is an urgent need.

- When the remote controller's batteries have failed.
- When the remote controller is broken.
- When the remote controller is lost.

\*1 Figures: CZ-RWSU3 and CZ-RWST3N are of receivers (inside indoor unit), and Indoor Unit (CZ-RWSK2) is of its front panel.

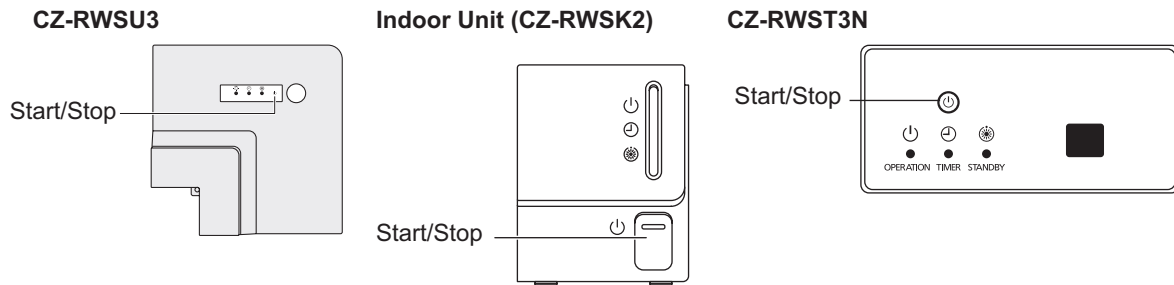
### CZ-RWSU3 / Indoor Unit (CZ-RWSK2) / CZ-RWST3N

**Start :** press [Emergency Operation]  of the receiver.

If the indoor temperature is 24 °C or greater when the unit starts running, it will act as a cooling mode.

If the indoor temperature is less than 24 °C when the unit starts running, it will act as a heating mode.

**Stop :** press [Emergency Operation]  of the receiver again.



### NOTE

- The Test Run/On and Test/On switches are for use when the unit is installed and test run. It is not for normal use.
- If the [Normal/Stop ALL] switch is on **Stop ALL**, the unit cannot receive signals from the remote controller .

### CZ-RWSC3

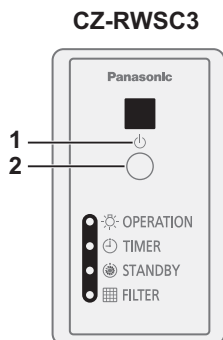
**1. Press [Emergency Operation]  of the receiver.**

If the indoor temperature is 24 °C or greater when the unit starts running, it will act as a cooling mode.

If the indoor temperature is less than 24 °C when the unit starts running, it will act as a heating mode.

**2. If you press , the wind direction automatically oscillates up and down.**

**Stop :** press [Emergency Operation]  of the receiver again.





## 8-12. Miscellaneous Settings













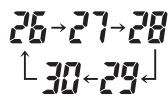
A variety of changes can be made to settings, depending on the indoor unit being used.

### Operation mode indicator, time display (24 hour, AM/PM), Heat Max Temp

- (These settings are saved in nonvolatile memory in the remote controller, so even when its batteries are changed, the settings do not have to be made again.)
- First check the display of the remote controller when the unit is stopped and then make any desired settings.


### How to Operate

- While holding down the buttons below, every time  is pressed the remote controller's display changes.
- Whatever is being displayed when you release  is set.

| Setting Item   | Operation Button   | Setting Content                                    | Remote Controller Display  |
|--|--|--|--|
| Remote controller operation mode display setting when  is pressed | Press  while pressing    | Heat Pump (with Auto)                              |   |
|  |  | Heat Pump (without Auto)                           |   |
|  |  | Dedicated air conditioner                          |   |
| Clock display setting  | Press  while pressing    | 24-hour  |   |
|  |  | AM/PM  |   |
| Max possible temperature setting in the Heat mode  | Press  while pressing  | Maximum heating temperature range is 26 °C – 30 °C |  |

## 8-13. Before Requesting Service

Before requesting service, please check the followings.

| Problem  | Cause  | Solution   |
|--|--|--|
| The unit doesn't work even when  is pressed on the remote controller. | The power to the indoor unit is not ON.  | Make sure the power to the indoor unit is ON.  |
|  | Are the remote controller's batteries dead?  | Change the batteries.  |
|  | Is there a mismatch between the display lamp and cooling/heating or is it set to something other than Auto? (The operating lamp stays lit, while the timer lamp and the standby lamp blink alternately.) | Change the operating mode.   |
|  | Do the addresses match one another?  | Check the addresses of the receiver and the remote controller.                       |
| The air conditioner starts and stops on its own.   | Has the timer been set to repeat?  | Check the timer settings.  |
| "EP" is displayed on the remote controller when the unit is stopped.   | An error has occurred in the non-volatile memory.  | Please contact your sales outlet.  |
| Although the unit is for air conditioning only, either Auto or Heat is indicated in the display.   |  | Make settings to the remote controller's operation mode display.                     |
| After putting the batteries in the remote controller, even when it is operated, the display does not change.   |  | Press the Reset button on the remote controller.                                     |
| The timer cannot be set.   |  | Make the settings when the remote controller is in Operation Display. (See page 8-7) |

If the problem persists even after you check the foregoing items, stop the unit, disconnect the power to the indoor unit and contact the dealer where the product was purchased with the model number and problem you are having.

As it is dangerous, under no circumstances should you undertake repairs yourself.

Further, when the receiver's lamps are blinking; please contact your retailer with that information.

## ■ Specifications

### CZ-RWSU3/CZ-RWSC3/CZ-RWSK2 /CZ-RWST3N

Wireless Remote Controller

|                |                                      |
|----------------|--------------------------------------|
| Dimensions     | 182 mm (H) X 61 mm (W) X 18.5 mm (D) |
| Power source   | Two AAA alkaline batteries           |
| Clock Accuracy | ±30 seconds per month (at 25 °C)     |

### CZ-RWSU3/CZ-RWSC3/CZ-RWST3N

Receiver

|              |   |   |
|--------------|---|---|
| Dimensions   | CZ-RWSU3  | 29.7 mm (H) X 211.8 mm (W) X 211.8 mm (D) |
|              | CZ-RWSC3  | 120 mm (H) X 70 mm (W) X 20 mm (D)        |
|              | CZ-RWST3N   | 65 mm (H) X 141 mm (W) X 22.5 mm (D)      |
| Power source | 16 V DC (Supplied from the terminal strip of the indoor unit's remote controller) |   |

## ■ How to Install the Wireless Remote Controller Receiver

### 8-14. Common to All Models

#### 1. Warnings about Installation of Receivers

The wireless remote controller uses a very weak infrared light for its signal, which can result in the signal not being received because of the following influences, so take care in where the unit is installed.

- Inverter or rapid-start type fluorescent lights. (Models without glow lamps)
- Plasma display or LCD televisions.
- Direct sunlight or other sources of bright light.

#### 2. Warnings about Installing Remote Controllers

- (1) If a remote controller is to be operated from a remote controller holder that is hung on a wall, turn on the lights in the room as well as any electrical appliances and then check to make sure the air conditioner works with the remote controller in the location where it will be installed. If it works, continue with installation.
- (2) If the air conditioner is to be switched from the main sensor to a remote controller sensor, pay attention to the following when installing.
  - Locate where no warm or cold drafts will affect it.
  - Locate in a place free from direct sunlight.
  - Locate where it will not be affected by any other heat/cold source.

#### 3. Things to remember when wired and wireless remote controllers are installed at the same time

Two remote controllers can be used to controller the unit if the wireless remote controller kit is installed at the same time as the wired remote controller.

(Up to 2 remote controllers [a wireless remote controller kit and the wired remote controller] can be installed.)

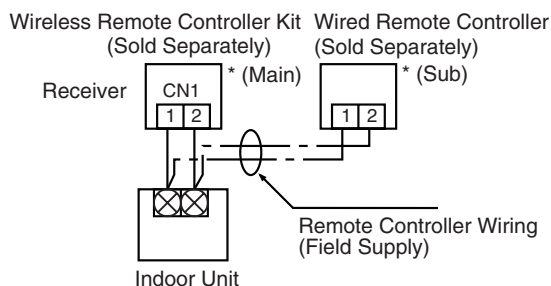
When using 2 remote controllers, one or more units can be operated by the remote controllers.

#### NOTE

1. When wiring remote controllers, be sure to double-check the terminal numbers of the indoor unit before connecting them so there are no mistakes in the wiring. (Damage will occur if high voltage [e.g. supply voltage] is applied)
  2. It is not possible to use more than one wireless remote controller kit with one indoor unit.  
(A receiver located separately can be used at the same time)
  3. If both a wireless and a wired remote controller are to be installed and used at the same time, one of them must be set up as the sub remote controller.
- If the wired remote controller is to be the sub remote controller, change the wired remote controller to the sub remote controller.
  - If the wireless remote controller is to be the secondary, turn the #3 switch on the wireless receiver (operation panel) from OFF to ON. (see next page)

#### When 1 indoor unit is operated by 2 remote controllers:

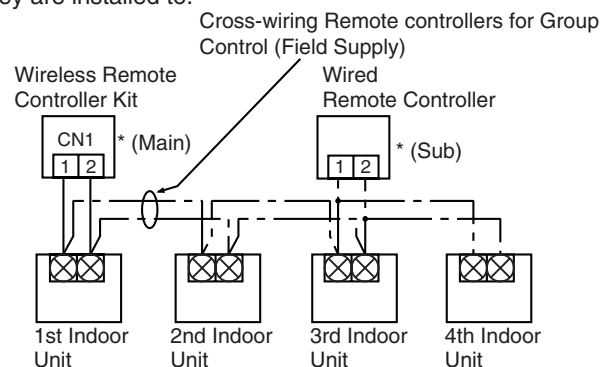
\* Either of the remote controllers can be set to main/sub.



- Use wiring of 0.5 mm<sup>2</sup> to 2 mm<sup>2</sup> for field supply.
- Use a total wire length of no more than 400 m.

#### If a group of units are to be controlled by 2 remote controllers:

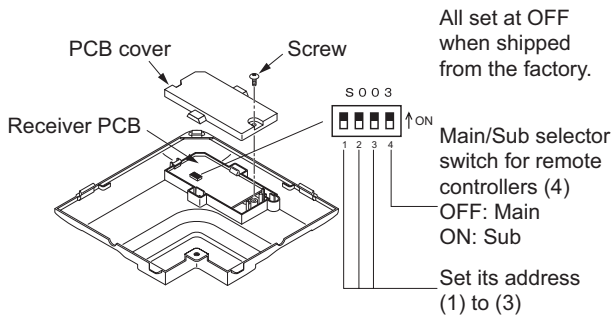
\* Main/sub remote controllers will work regardless of which indoor unit they are installed to.



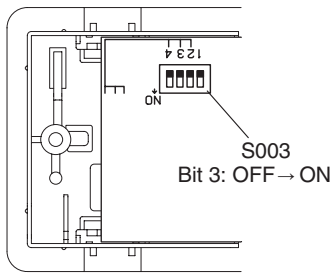
- Use wiring of 0.5 mm<sup>2</sup> to 2 mm<sup>2</sup> for field supply.
- Make the total wire length when cross-wiring a group no more than 200 m.



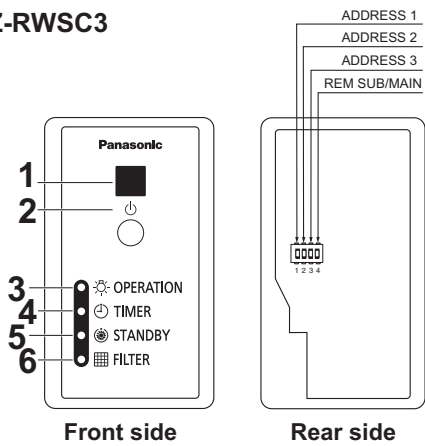
### CZ-RWSU3



### CZ-RWST3N

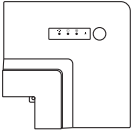


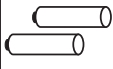






### CZ-RWSC3



## 8-15. CZ-RWSU3

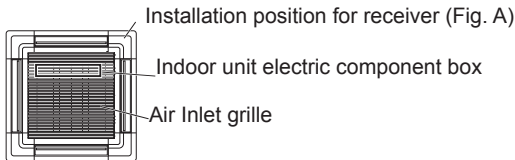
### 1. Accessories

| Supplied accessories  |   |   |   |   |  |   |   |
|---|---|---|---|---|--|---|---|
| Receiver<br>(1)   | Wireless Remote Controller<br>(1)   | Remote Controller Holder<br>(1)   | LR03 Size Battery<br>(2)  | Operating Instructions<br>(1)   | Quick Reference<br>(1)   | Wood Screw M4 × 16<br>(2)   | Clamper<br>(1)  |
|  |  |  |  |  |  |  |  |

### 2. Installing the Receiver

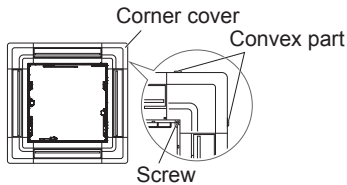
- The receiver can be installed only on the corner shown in Fig. A. Consider the direction where the panel is attached to the indoor unit.

#### 1 Remove the air inlet grille Indoor unit electric component box

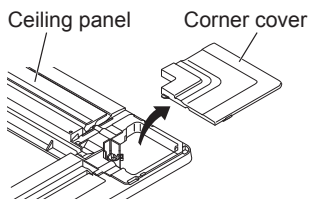


#### 2 Remove the corner cover.

- Remove the screw fixing the corner cover.

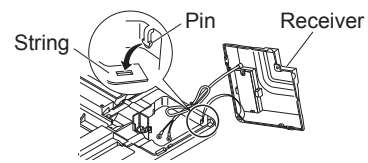


- Place a hand on both the right and left convex parts of the corner cover to remove it.



#### 3 Wire the receiver.

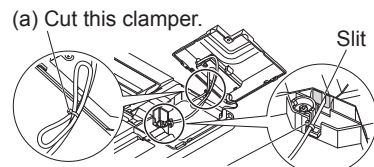
- Hang the string of the receiver on the pin of the ceiling panel.



- Pass the wiring from the wireless receiver section into the slit. (See "Wiring for the Receiver")

- Fix the wiring with the clamper (supplied) while leaving enough length of wiring to remove the receiver.

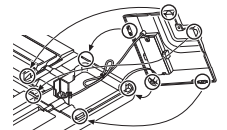
- When attaching the filter chamber, cut the clamper (a), and attach the receiver.



#### 4 Fix the receiver.

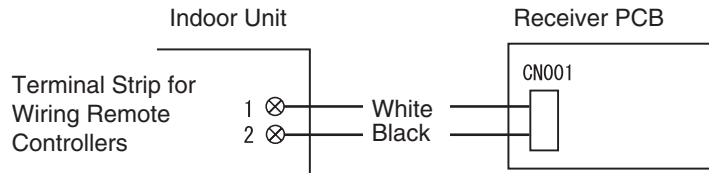
- Fit the receiver to the ceiling panel so the 5 claws are properly set, and fix it with the removed screw.

- Make sure the wire is not caught.
- Refer to the installation instructions supplied with the panel.



### 3. Wiring the Receiver

#### • Wiring Diagram



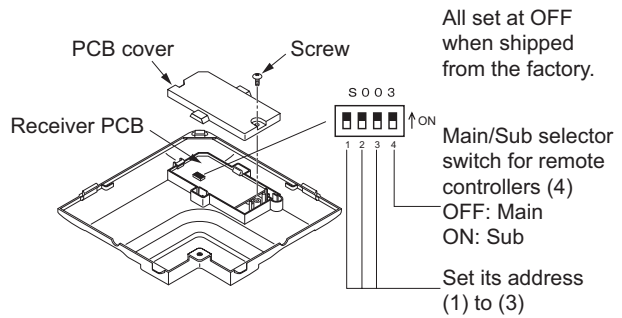
#### • Connections

Connect the wires from the receiver to the remote controller terminal strip on the indoor unit. (Polarity does not matter)

### 4. Setting for Receiver

- Check the settings of the [S003] DIP switch on the receiver's PCB.

\* Remove the cover from the receiver when performing the PCB settings.



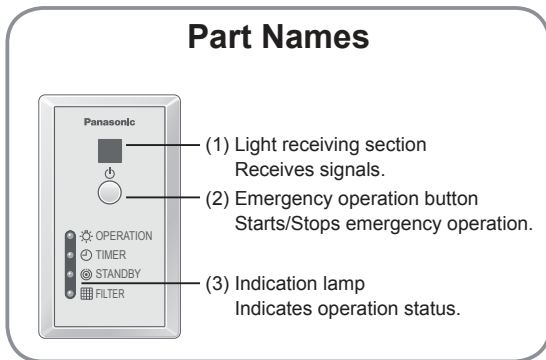
### 5. Setting Address Switches

- When more than 1 receiver is installed in the same room, setting addresses prevents interference.
- For how to change addresses of wireless remote controllers, see the operating instructions of wireless remote controllers.
- To change the receiver's address, remove the cover from the receiver's PCB and set No.1 to No.3 of the [003] DIP switch on PCB.

| Remote Controller Address Display         | Address ALL   | Address 1 | Address 2 | Address 3 | Address 4 | Address 5 | Address 6 | ON/OFF States |
|---|---|-----------|-----------|-----------|-----------|-----------|-----------|---------------|
| Position of the receiver's address switch | Receipt is possible at all of the address positions |           |           |           |           |           |           |               |

## 8-16. CZ-RWSC3

### Installation Instructions Wireless Receiver for ALL



## Safety Precautions

### Read before installation

- Read the Installation Instructions carefully to install the unit correctly and safely.  
Be sure to read the Safety Precautions in particular before installation.
- After the installation is complete, perform test operation to confirm that no abnormality is present.

#### **WARNING**

This symbol refers to a hazard or unsafe practice which can result in severe personal injury or death.

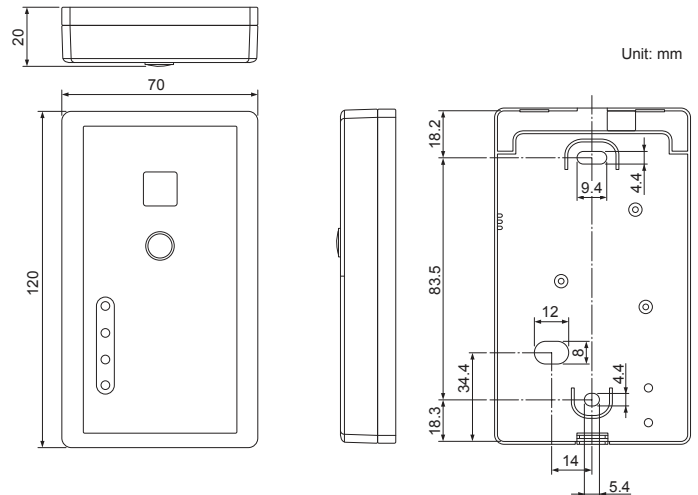
#### **WARNING**

- Turn off the circuit breaker of the units before installation.
- Ask your dealer or professionals for installation and electric work.
- This receiver shall be installed in accordance with National Wiring Regulations.
- Securely connect and fix the specified cables for wiring.
- Do not allow the connection to be exposed to the external force of the cables.
- Choose an installation location that sufficiently supports the weight of the receiver.

### 1. Accessories

| Supplied accessories               |                    |
|------------------------------------|--------------------|
| Wood screw<br>M4 × 15.5<br>(2)<br> | Clamper<br>(1)<br> |

## Dimensions



- We assume no responsibility for accidents or damages resulting from methods other than those described in the installation instructions or methods without using specified parts. Malfunctions that occurred due to the unauthorised installation methods are not covered by the product warranty.
- Read the installation instructions supplied with indoor units as well.

#### **CAUTION**

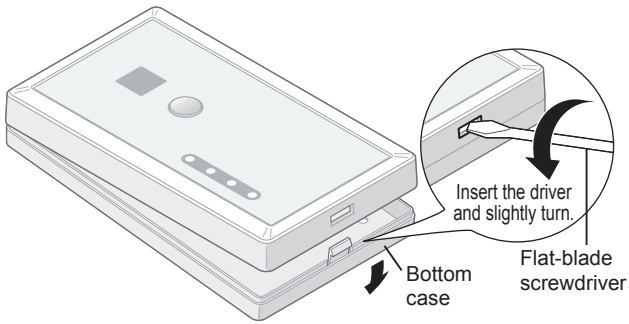
This symbol refers to a hazard or unsafe practice which can result in personal injury or product or property damage.

#### **CAUTION**

- Do not use at the following locations.
  - Location where condensation occurs
  - Location where flammable gases, etc. may leak
  - Location where corrosive gases, etc. may leak
  - Location with lots of water or oil droplets (including machine oil)
  - Location where voltage fluctuation frequently occurs
  - Location where there is a machine producing electromagnetic radiation
  - Location where droplets of organic solvents spread  
Location where acidic or alkaline solutions or special sprays are frequently used
- Do not operate with wet hands.
- **Do not wash with water.**

## 2. Installing the Receiver

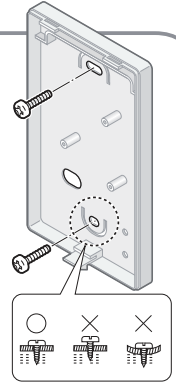
### 1 Remove the bottom case.



### Attention

#### Mounting the bottom case

- Tighten the screws securely until the screw heads touch the bottom case. (Otherwise, loose screw heads may hit the PCB and cause malfunction when mounting the top case.)
- Do not over-tighten the screws. (The bottom case may be deformed, resulting in fall of the unit.)



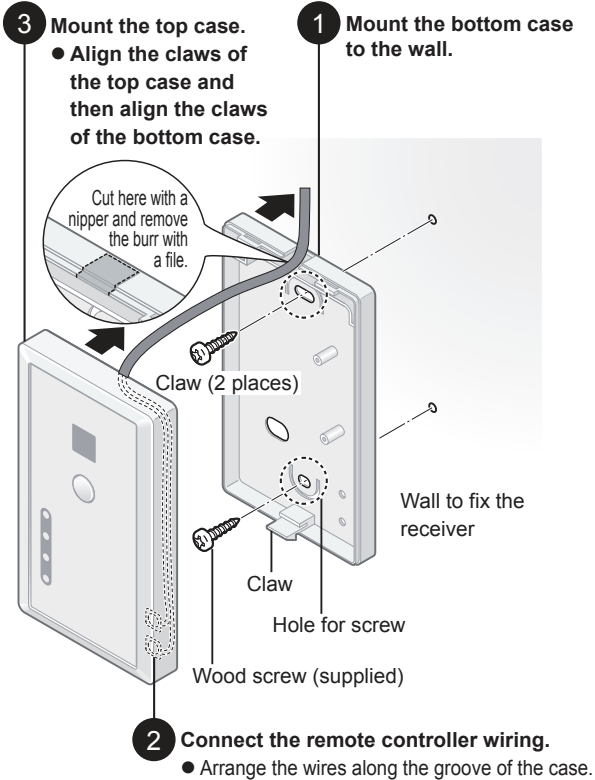
#### Connecting the remote controller wiring

- Arrange the wires as shown in the illustration for ② in step 2, avoiding unnecessary wires being stored in the case. (Caught wires may destroy the PCB.)
- Avoid wires touching parts on the PCB. (Caught wires may destroy the PCB.)

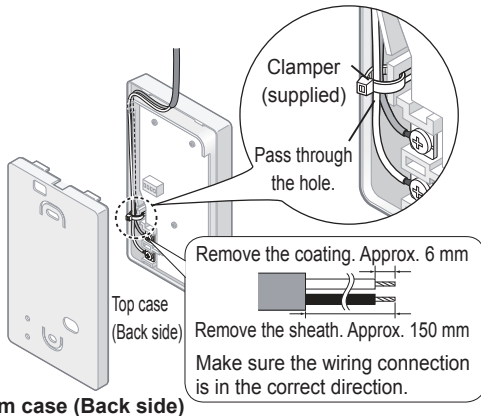
### 2 Mount to the wall.

#### Exposed type

Preparation: Make 2 holes for screws using a driver.



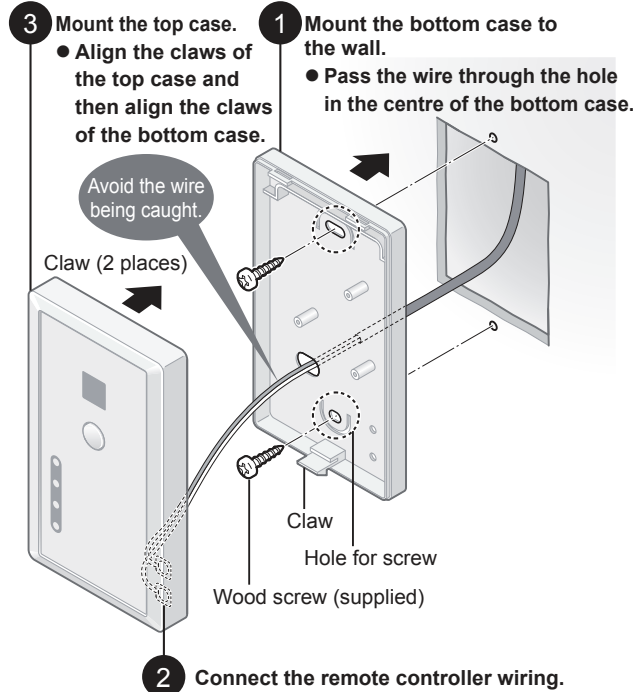
- 2 Connect the remote controller wiring.**
- Arrange the wires along the groove of the case.



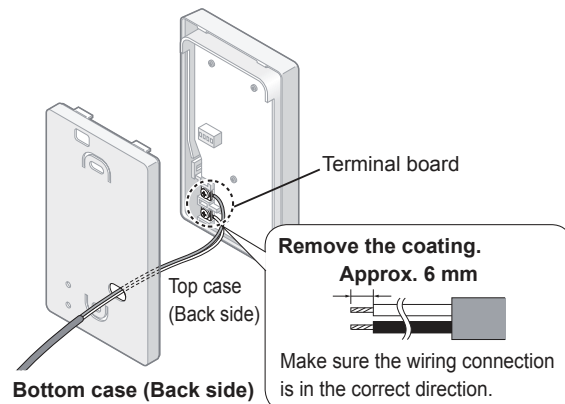
Remove the coating. Approx. 6 mm  
Remove the sheath. Approx. 150 mm  
Make sure the wiring connection is in the correct direction.

#### Embedded type

Preparation: Make 2 holes for screws using a driver.



- 2 Connect the remote controller wiring.**



Remove the coating. Approx. 6 mm

Make sure the wiring connection is in the correct direction.

### 3. Wiring the Receiver

## Wiring for the receiver

■ **Wiring diagram**

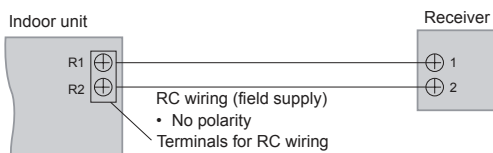
■ **Type of wiring**

Use cables of 0.5 to 1.25 mm<sup>2</sup>.

■ **Total wire length:** 400 m or less  
(The wire length between indoor units should be 200 m or less.)

■ **Number of connectable units**

Remote controller and receiver: Max. 2, Indoor unit: Max. 8

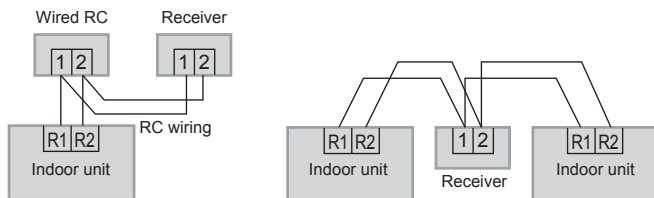


### Attention

- Be careful not to connect cables to other terminals of indoor units (e.g. power source wiring terminal). Malfunction may occur.
- Do not bundle together with the power source wiring or store in the same metal tube. Operation error may occur.
- If noise is induced to the unit power supply, attach a noise filter.

- For the RC wiring of field supply, please use insulated wires with sheath. The insulation thickness should be at least 1 mm.
- Regulations on wire diameters differ from locality to locality. For field wiring rules, please refer to your LOCAL ELECTRICAL CODES before beginning.
- You must ensure that installation complies with all relevant rules and regulations.

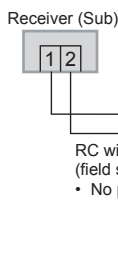
\*Wiring as shown below is prohibited.



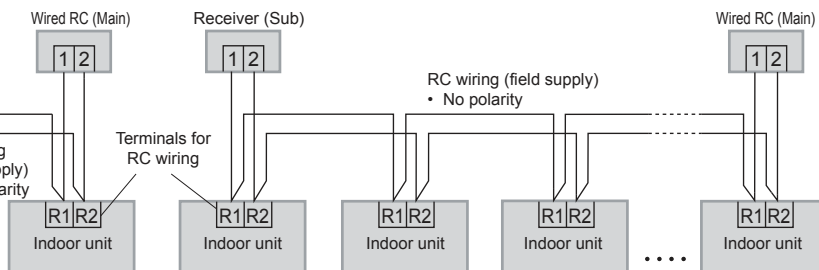
### Installation when setting Main/Sub for the remote controller and the receiver

■ **Using 1 indoor unit**

Installation example



■ **Using more than 1 indoor unit**



After installation, according to the "Main/Sub setting" in the "Setting" section, set one to [Main] and the other to [Sub].  
Setting the wired remote controller to [Main] is recommended.

### Note

The remote controller and the receiver can be connected to any indoor unit for operation.

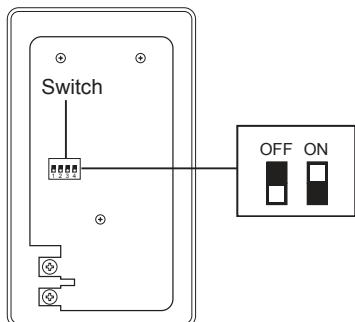
## Specifications

|                            |   |
|----------------------------|---|
| Model No.                  | CZ-RWSC3  |
| Dimensions                 | (H) 120 mm × (W) 70 mm × (D) 20 mm                                  |
| Weight                     | 75 g  |
| Temperature/Humidity range | 0 °C to 40 °C / 20 % to 80 % (No condensation)<br>*Indoor use only. |
| Power Source               | DC16 V (supplied from indoor unit)                                  |

## 4. Setting Address Switches

- Main/Sub setting
- Address setting

Remove the top case of the receiver for setting.



### Main/Sub setting

- Use this to set Main/Sub for the remote controller and the receiver.
- Set one to [Main] and the other to [Sub].
- Factory default: [Main]
- It is recommended to set the wired remote controller to [Main].

| Main/Sub                 | MAIN    | SUB     |
|--------------------------|---------|---------|
| Main/Sub switch position |         |         |
|                          | 1 2 3 4 | 1 2 3 4 |

### Address setting

- When more than 1 receiver is installed in the same room, setting addresses prevents interference.
- For how to change addresses of wireless remote controllers, see operating instructions of wireless remote controllers.

| Wireless remote controller address display | Address ALL                                     | Address 1 | Address 2 | Address 3 | Address 4 | Address 5 | Address 6 |
|--|---|-----------|-----------|-----------|-----------|-----------|-----------|
| Address switch position                    | Receiving is possible at all address positions. |           |           |           |           |           |           |
|  |   | 1 2 3 4   | 1 2 3 4   | 1 2 3 4   | 1 2 3 4   | 1 2 3 4   | 1 2 3 4   |

## 5. Test operation

Preparation : Turn on the circuit breaker of units and then turn the power on. After the power is turned on, remote controller operation is ignored for approx. 1 minute because setting is being made. This is not malfunction. (Contents received while setting are disabled.)

1. To start test operation, press and hold the emergency operation button for 10 seconds.
2. The indication lamps (OPERATION, TIMER, STANDBY) blink during test operation.
3. To finish test operation, press and hold the emergency operation button for 10 seconds.

### Attention

- Do not use this mode for purposes other than the test operation. (To prevent overload of the units)
- Read the installation instructions supplied with the units.
- Any of the Heat, Cool and Fan operations can only be performed.
- Temperature cannot be changed.
- The test operation mode is automatically turned off in 60 minutes. (To prevent continuous test operation)
- Outdoor units do not operate for approx. 3 minutes after the power is turned on or operation is stopped.

### Self-diagnostics table and detected contents

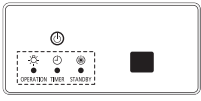

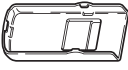
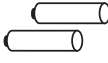




- The "Alarm Display" as shown in the table below expresses the alarm contents displayed when the wired remote controller is connected. For how to handle the alarms, see installation instructions of indoor units or technical guide.

| Detected contents   | Alarm Display              | Indication lamp on the receiver |       |         |                |
|---|----------------------------|---------------------------------|-------|---------|----------------|
|   |                            | OPERATION                       | TIMER | STANDBY | Blinking       |
| Communication error in the remote controller circuit  | E01-E03, E08-E14, E17, E18 | □                               | ●     | ●       |                |
| Communication error either in the in/outdoor operation line or the sub-bus of the outdoor unit    | E04-E07, E15, E16, E19-E31 | ●                               | ●     | □       |                |
| Operation of indoor protection device   | P01, P09-P14               | ●                               | □     | □       | Alternately    |
| Operation of outdoor protection device  | P02-P08, P15-P31           | □                               | ●     | □       | Alternately    |
| Error in the indoor thermistor  | F01-F03, F10-F11           | □                               | □     | ●       | Alternately    |
| Error in the outdoor thermistor   | F04-F09, F12-F28           | □                               | □     | ○       | Alternately    |
| Error in the indoor EEPROM  | F29                        | □                               | □     | ●       | Simultaneously |
| Error in the outdoor EEPROM   | F30, F31                   | □                               | □     | ○       | Simultaneously |
| Error related to the compressor   | H01-H31                    | ●                               | □     | ●       |                |
| Error in indoor settings  | L01-L03, L05-L09           | □                               | ●     | □       | Simultaneously |
| Error in outdoor settings   | L04, L10-L31               | □                               | ○     | □       | Simultaneously |
| Inconsistency in Air/Heat (Including an auto-temp setting for a model without auto-temp settings) |                            | ○                               | □     | □       | Alternately    |
| Oil Alarm (Same as operation of outdoor protection device)  |                            | □                               | ●     | □       | Alternately    |
| Test operation  |                            | □                               | □     | □       | Simultaneously |

●: OFF ○: ON (Illuminated) □: Blinking (0.5 seconds interval)

## 8-17. CZ-RWST3N

### 1. Accessories

| Supplied accessories  |   |   |   |  |   |   |   |
|---|---|---|---|--|---|---|---|
| Receiver<br>(1)   | Wireless Remote Controller<br>(1)   | Remote Controller Holder<br>(1)   | LR03 Size Battery<br>(2)  | Operating Instructions<br>(1)  | Quick Reference<br>(1)  | Wood Screw M4 × 16<br>(2)   | Clamper<br>(1)  |
|  |  |  |  |  |  |  |  |

### 2. Installing the Receiver

#### ● Ceiling Suspended Model

- (1) Remove the screw, and slide the latch to open the air-intake grille. (Fig. 8-1)
- (2) Insert a flat-head screwdriver from the side, and remove the cover while pressing down on the two cover tabs. (Fig. 8-2)
- (3) Route the remote controller wiring through the panel, and mount the receiver into the panel holes. (Fig. 8-3)
- (4) Route the remote controller wiring through the adjustable clamper, and draw in the wire from the remote controller wiring inlet to the inside of the indoor unit. (Fig. 8-3) (See Fig. 8-4 for how to loosen the adjustable clamper.)
- (5) Route the remote controller wiring through the three saddles, and draw the wire into the electrical box. (Fig. 8-4)
  - \* Draw in the power wire and remote controller wiring separately.
- (6) Connect the remote controller wiring to the terminal board, route through the cable tie (accessory) to the holding clamp, and secure the remote controller wiring. (Fig. 8-5)
- (7) Mount the side cover, and close the air-intake grille.

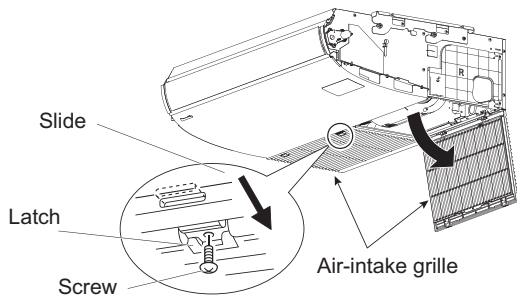


Fig. 8-1

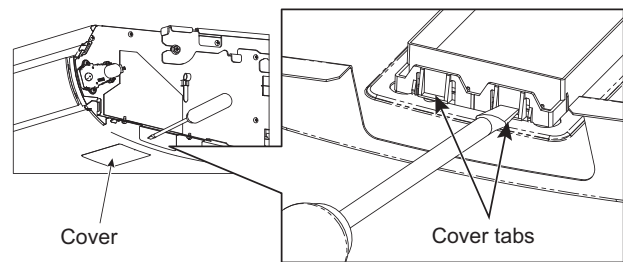


Fig. 8-2

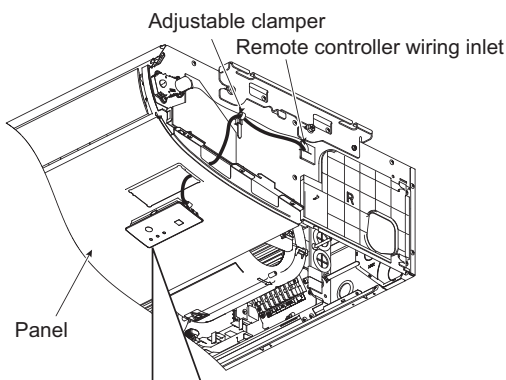


Fig. 8-3

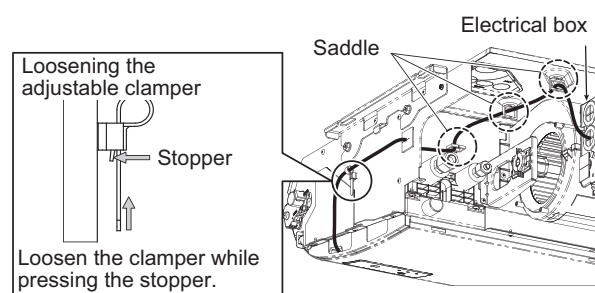


Fig. 8-4

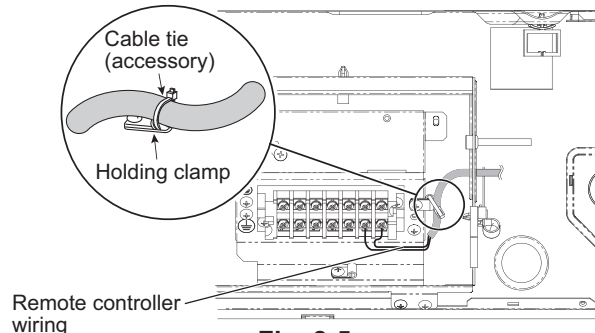
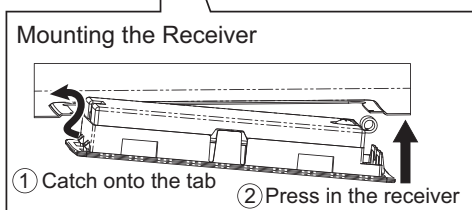


Fig. 8-5



## ● Removing and Mounting the Side Cover

### Removing the side cover

Remove the side cover mounting screw, and slide the side cover to the front side (direction of arrow in Fig. 8-6) to remove.

### Mounting the side cover

Slide in the side cover from the indoor unit front side, mount to the latch tabs, and secure using the side cover mounting screw.

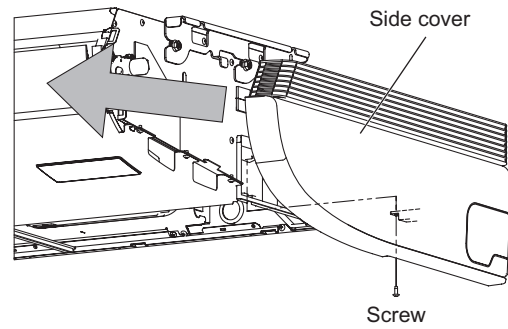
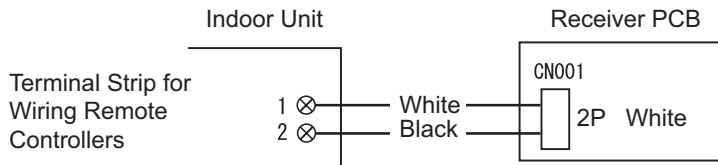


Fig. 8-6

## 3. Wiring the Receiver

### Wiring Diagram



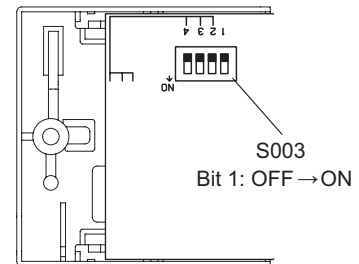
### Connections

Connect the wires from the receiver to the remote controller terminal strip on the indoor unit. (Polarity does not matter)

## 4. Test Operation

### Implementing a Test Run

1. Turn the #1 DIP switch [S003] on the receiver's PCB from OFF to ON and operate the wireless remote controller with its Start/Stop button.
2. During a test run, all display lamps on the display will light up.
3. During a test run, it is not possible to adjust the temperature.
4. After completing a test run, be absolutely sure to turn the #1 DIP switch from ON to OFF and make sure none of the display lamps are blinking. Also, replace the PCB cover back as it was and fasten it; while holding the wiring with the cable clamp, tighten its screw.



### NOTE

1. This is hard on the device, so only use this for the test run.
2. After turning on the power, the unit will not receive any commands from the remote controller for about 1 minute. This is not an error. (In fact it does receive signals, but they are cancelled.)

## 5. Setting Address Switches

- When more than one receiver and remote controller are installed in the same room, setting up addresses allows them to avoid interfering with each other.
- Refer to the Users Manual for information on how to change the addresses of the remote controllers.
- Changing the address of a receiver can be done after removing the screw to the receiver's PCB cover. Once the change is complete, put the cover back in place; while holding the wiring with the cable clamp, tighten its screw.

|   |   |          |          |       |          |
|---|---|----------|----------|-------|----------|
| Address Display on the Remote Controller  | <b>AL L</b>   | <b>1</b> | <b>2</b> | ..... | <b>6</b> |
| Position of the Receiver's Address Switch | It doesn't matter where the receiver's address switch is. |          |          | ..... |          |

## 8-18. Common to All Models

### 1. The Self-Diagnosis Function Display and What is Detected

Alarm Display in the table below indicates the content of alarms that are displayed when a wired remote controller is connected. For information on how to deal with the alarms, refer to the Mounting Instructions for the indoor unit or to Test Run or servicing materials.

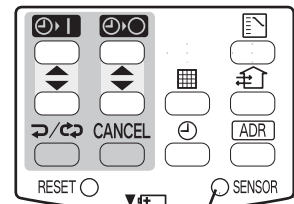
| Error Detected  | Alarm Display              | WL Remote Controller LED Display |       |         |                |
|---|----------------------------|----------------------------------|-------|---------|----------------|
|   |                            | Run                              | Timer | Standby | Blinking       |
| Communication error in the remote controller circuit  | E01–E03, E08–E14, E17, E18 | ☉                                | ●     | ●       |                |
| Communication error either in the in/outdoor operation line or the sub-bus of the outdoor unit    | E04–E07, E15, E16, E19–E31 | ●                                | ●     | ☉       |                |
| Operation of indoor protection device   | P01, P09–P14               | ●                                | ☉     | ☉       | Alternately    |
| Operation of outdoor protection device  | P02–P08, P15–P31           | ☉                                | ●     | ☉       | Alternately    |
| Error in the indoor thermistor  | F01–F03, F10–F11           | ☉                                | ☉     | ●       | Alternately    |
| Error in the outdoor thermistor   | F04–F09, F12–F28           | ☉                                | ☉     | ○       | Alternately    |
| Error in the indoor EEPROM  | F29                        | ☉                                | ☉     | ●       | Simultaneously |
| Error in the outdoor EEPROM   | F30, F31                   | ☉                                | ☉     | ○       | Simultaneously |
| Error related to the compressor   | H01–H31                    | ●                                | ☉     | ●       |                |
| Error in indoor settings  | L01–L03 L05–L09            | ☉                                | ●     | ☉       | Simultaneously |
| Error in outdoor settings   | L04, L10–L31               | ☉                                | ○     | ☉       | Simultaneously |
| Inconsistency in Air/Heat (Including an auto-temp setting for a model without auto-temp settings) |                            | ○                                | ☉     | ☉       | Alternately    |
| Oil Alarm (Same as operation of outdoor protection device)  |                            | ☉                                | ●     | ☉       | Alternately    |
| Test Run  |                            | ☉                                | ☉     | ☉       | Simultaneously |

● : Off / ○ : On / ☉ : Blinking (0.5 sec. intervals)

### 2. Room Temperature Sensor Settings

#### Common to All Models

- The indoor unit and the wireless remote controller are equipped with indoor temperature sensors. The sensing of indoor temperature works via one of them.
- When the unit is shipped, it is set to the indoor unit, but to switch to the remote controller, press the sensor button (diagram at right) inside the remote controller's cover and then check to make sure that Main Sensor on the LCD screen goes off.



Sensor Button

Fig. 8-7

#### NOTE

Even when the Sensor switch has been set to the remote controller, if the unit does not receive any room temperature data from the remote controller for ten minutes, it automatically switches back to the indoor unit sensor, so be sure to install the remote controller facing the receiver.



