



**BLN-006TB1/BLN-010TB1/BLN-014TB1/BLN-018TB1
BLN-010TB3/BLN-014TB3/BLN-018TB3/BLN-024TB3**

Air Source Heat Pump

Heat Pump for Heating & Cooling & DHW

Please read this manual carefully before using it and keep it in a safe place

Note

1. Please read the instruction manual carefully before installation or operation.
2. The heat pump must be installed by a professional installer.
3. Please follow the instruction manual strictly when installing the heat pump
4. If any update on the product, this instruction manual is subject to change without notice
5. If the heat pump is installed where is vulnerable to lightning strikes, it is necessary to take lightning protection measures; if the heat pump is turned off in the winter, please be sure to drain the water in the system to prevent cold water from swelling and causing system damage.

Content

User Instruction -----	1
Operation Instructions -----	8
Dimension -----	15
Installation -----	17
Commissioning and Maintenance -----	28
Trouble Analysis -----	30
Specification -----	34
After-sale Service -----	36
Controller Supplement -----	37

User Instructions

1. Please use an electrical leakage switch, otherwise, there may be electric shock, fire, etc.

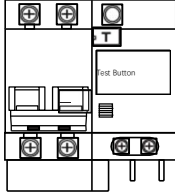

2. Make sure that the leakage protection switch is securely connected. If the wiring is not secure, it may cause electric shock, heat, or fire.

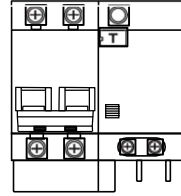

3. Do not operate with a wet hand, otherwise, there may cause electric shock.

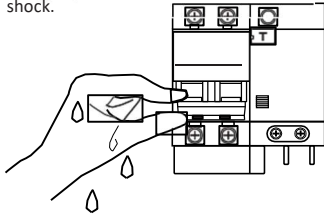

4. Do not insert your fingers or any stick into the inside of the ventilation area, otherwise, harm will be caused.

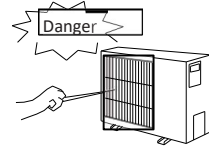

1. Precautions

Please make sure that you have read this manual before using our air source heat pump. In the “User Information” chapter, “User Information” provides essential safety information. Please be sure to follow the instruction strictly.



Warning

Wrong operations are likely to cause serious consequences such as death, serious injury, or major accidents



Note

Improper operation may result in a safety accident, damage to the machine, or affect the function of the machine.

Please read the labels on the machine carefully. If abnormal conditions such as abnormal noise, odor, smoke, temperature rise, electric leakage, fire, etc. are found during use, please cut off the power immediately and contact our local customer service center or dealer in time to repair it. Contact the local fire and emergency department immediately if necessary.



Warning

- 1) This Machine is not allowed to be installed by the user. A professional installer must install it, Otherwise cause safety accidents or affects the machine's performance.
- 2) Without professional guidance, non-professionals are not allowed to disassemble the machine. Otherwise, accidents or damage may be caused to the device.
- 3) Do not use or store flammable materials such as hair spray, paint, gasoline, alcohol, etc., around the machine. Otherwise, fire may be caused.
- 4) The machine's main power switch should be placed where that child cannot reach to prevent children from playing with the power switch.
- 5) Do not spray water or other liquids on the machine. Otherwise, danger may occur.
- 6) Do not touch the machine with wet hands. Otherwise, it may cause an electric shock.
- 7) In thunderstorms, please disconnect the main power switch off the machine. Otherwise, lightning may cause danger or damage to the device.
- 8) The machine needs to use a separate power switch to avoid sharing the same circuit with other electrical appliances, supply the power to the machine vice the specified power cable, and use the proper breaker with the electric leakage protection required.
- 9) The machine must be installed with a specified grounding wire. Do not connect the grounding wire to the gas pipe, water pipe, lightning conductor, or telephone, and the machine must be grounded reliably to avoid any electric shock.
- 10) Do not disconnect the power supply when the machine is running.
- 11) When the machine is not used for a long time, please disconnect the main power switch to avoid accidents.
- 12) If the ambient temperature is below 0 °C, it is forbidden to cut off the power supply. If the power is turned off unexpectedly under these conditions, drain the water inside the pipeline.



Note

- 1) Do not put your hands or other objects into the air outlet of the machine. Otherwise, the fan running at high speed may cause harm.
- 2) Do not remove the fan cover. Otherwise, the fan running at high speed may cause injury to you or others.
- 3) Lightning and other sources of electromagnetic radiation may have a remarkable effect on the machine. Turn off the power and then restart the device if it does affect it.
- 4) Make sure the water supply is frequent. Otherwise, the machine may be damaged.
- 5) Do not restart the machine frequently. Otherwise, the device may be damaged.
- 6) The operating parameters of the machine and the set value of the protection device have been selected by the manufacturer. Users should not change the set value arbitrarily and do not short the wire of the protection device. Otherwise, the machine may be damaged due to improper protection.
- 7) To avoid the freezing of the water system pipeline when the machine is deactivated in an environment below 0 °C, please keep the machine standby state. If the device is out of service

for a long time, it is recommended that the user drain the water out of the water system and disconnect the power supply.

- 8) Please perform regular maintenance on the machine as required by the instructions to ensure the device is in good operating condition.

2. Refrigerant Precaution

- 1) Do not use means to accelerate the defrosting process or to clean, other than those recommended by the manufacturer.
- 2) The appliance shall be stored in a room without continuously operating ignition sources (for example open flames, an operating gas appliance, or an operating electric heater)
- 3) Do not pierce or burn.
- 4) Be aware that refrigerants may not contain an odor.
- 5) Appliance shall be installed, operated, and stored in a room with a floor area larger than X m²
- 6) The installation of pipe-work shall be kept to a minimum of X m²
- 7) Spaces where refrigerant pipes shall be in compliance with national gas regulations.
- 8) Servicing shall be performed only as recommended by the manufacturer.
- 9) The appliance shall be stored in a well-ventilated area where the room size corresponds to the room area as specified for operation.
- 10) All working procedures that affect safety means shall only be carried out by competent persons.

3. Requirement of Flammable Refrigerant

- 1) Transport of equipment containing flammable refrigerants: Compliance with the transport regulations
- 2) Marking of equipment using signs: Compliance with local regulations
- 3) Disposal of equipment using flammable refrigerants: Compliance with national regulations
- 4) Storage of equipment/appliances: The storage of equipment should be in accordance with the manufacturer's instructions.
- 5) Storage of packed (unsold) equipment: Storage package protection should be constructed such that mechanical damage to the equipment inside the package will not cause a leak of the refrigerant charge. The maximum number of pieces of equipment permitted to be stored together will be determined by local regulations.
- 6) Information on servicing:
 - i. Checks to the area
Prior to beginning work on systems containing flammable refrigerants, safety checks are necessary to ensure that the risk of ignition is minimized. For repair to the refrigerating system, the following precautions shall be complied with prior to conducting work on the system.
 - ii. Work Procedure
Work shall be undertaken under a controlled procedure so as to minimize the risk of flammable gas or vapor being present while the work is being performed.
 - iii. General Work Area
All maintenance staff and others working in the local area shall be instructed on the nature of the work being carried out. Work in confined spaces shall be avoided. The area around the workspace shall be sectioned off. Ensure that the conditions within the area have been made safe by control of flammable material.
 - iv. Checking for the presence of refrigerant
The area shall be checked with an appropriate refrigerant detector prior to and during work, to

ensure the technician is aware of potentially flammable atmospheres. Ensure that the leak detection equipment being used is suitable for use with flammable refrigerants, i.e. non-sparking, adequately sealed or intrinsically safe.

v. Presence of fire extinguisher

If any hot work is to be conducted on the refrigeration equipment or any associated parts, appropriate fire extinguishing equipment shall be available to hand. Have a dry powder or CO₂ fire extinguisher adjacent to the charging area.

vi. No ignition sources

No person carrying out work in relation to a refrigeration system that involves exposing any pipework that contains or has contained flammable refrigerant shall use any sources of ignition in such a manner that it may lead to the risk of fire or explosion. All possible ignition sources, including cigarette smoking, should be kept sufficiently far away from the site of installation, repairing, removal, and disposal, during which flammable refrigerant can possibly be released to the surrounding space. Prior to work taking place, the area around the equipment is to be surveyed to make sure that there are no flammable hazards or ignition risks. "No Smoking" signs shall be displayed.

vii. Ventilated area

Ensure that the area is in the open or that it is adequately ventilated before breaking into the system or conducting any hot work. A degree of ventilation shall continue during the period that the work is carried out. The ventilation should safely disperse any released refrigerant and preferably expel it externally into the atmosphere.

viii. Checks to the refrigeration equipment

Where electrical components are being changed, they shall be fit for the purpose and to the correct specification. At all times the manufacturer's maintenance and service guidelines shall be followed. If in doubt consult the manufacturer's technical department for assistance. The following checks shall be applied to installations using flammable refrigerants:

--The charge size is in accordance with the room size within which the refrigerant containing parts are installed;

--The ventilation machinery and outlets are operating adequately and are not obstructed;

--If an indirect refrigerating circuit is being used, the secondary circuit shall be checked for the presence of refrigerant;

--Marking of the equipment continues to be visible and legible. Markings and signs that are illegible shall be corrected;

--Refrigeration pipes or components are installed in a position where they are unlikely to be exposed to any substance which may corrode refrigerant-containing components unless the components are constructed of materials that are inherently resistant to being corroded or are suitably protected against being so corroded.

ix. Checks to electrical devices

Repair and maintenance to electrical components shall include initial safety checks and component inspection procedures. If a fault exists that could compromise safety, then no electrical supply shall be connected to the circuit until it is satisfactorily dealt with. If the fault cannot be corrected immediately but it is necessary to continue operation, an adequate temporary solution shall be used. This shall be reported to the owner of the equipment so all parties are advised.

Initial safety checks shall include:

- That capacitor is discharged: this shall be done in a safe manner to avoid the possibility of sparking;
- That there no live electrical components and wiring are exposed while charging, recovering, or purging the system;
- That there is continuity of earth bonding.

-
- 7) Repairs sealed components:
- a) During repairs to sealed components, all electrical supplies shall be disconnected from the equipment being worked upon prior to any removal of sealed covers, etc. If it is absolutely necessary to have an electrical supply to equipment during servicing, then a permanently operating form of leak detection shall be located at the most critical point to warn of a potentially hazardous situation.
 - b) Particular attention shall be paid to the following to ensure that by working on electrical components, the casing is not altered in such a way that the level of protection is affected. This shall include damage to cables, an excessive number of connections, terminals not made to original specification, damage to seals, incorrect fitting of glands, etc. Ensure that apparatus is mounted securely. Ensure that seals or sealing materials have not degraded such that they no longer serve the purpose of preventing the ingress of flammable atmospheres. Replacement parts shall be in accordance with the manufacturer's specifications.
NOTE: The use of silicone sealant may inhibit the effectiveness of some types of the leak.
- 8) Repair to intrinsically safe components
Do not apply any permanent inductive or capacitance loads to the circuit without ensuring that this will not exceed the permissible voltage and currently permitted for the equipment in use. Intrinsically safe components are the only types that can be worked on while living in the presence of a flammable atmosphere. The test apparatus shall be at the correct rating. Replace components only with parts specified by the manufacturer. Other parts may result in the ignition of refrigerant in the atmosphere from a leak.
- 9) Cabling
Check that cabling will not be subject to wear, corrosion, excessive pressure, vibration, sharp edges or any other adverse environmental effects. The check shall also take into account the effects of aging or continual vibration from sources such as compressors or fans.
- 10) Detection of flammable refrigerants
Under no circumstances shall potential sources of ignition be used in the searching for or detection of refrigerant leaks. A halide torch (or any other detector using a naked flame) shall not be used.
- 11) Leak detection methods
The following leak detection methods are deemed acceptable for systems containing flammable refrigerants.
Electronic leak detectors shall be used to detect flammable refrigerants, but the sensitivity may not be adequate or may need re-calibration. (Detection equipment shall be calibrated in a refrigerant-free area.) Ensure that the detector is not a potential source of ignition and is suitable for the refrigerant used. Leak detection equipment shall be set at a percentage of the LFL of the refrigerant and shall be calibrated to the refrigerant employed and the appropriate percentage of gas (25 % maximum) is confirmed.
Leak detection fluids are suitable for use with most refrigerants but the use of detergents containing chlorine shall be avoided as the chlorine may react with the refrigerant and corrode the copper pipe-work.
- 12) Removal and evacuation
When breaking into the refrigerant circuit to make repairs – or for any other purpose – conventional procedures shall be used. However, it is important that best practice is followed since flammability is a consideration. The following procedure shall be adhered to:
- Remove refrigerant;
 - Purge the circuit with inert gas;
 - Evacuate;
 - Purge again with inert gas;
 - Open the circuit by cutting or brazing.

The refrigerant charge shall be recovered into the correct recovery cylinders. The system shall be “flushed” with OFN to render the unit safe. This process may need to be repeated several times. Compressed air or oxygen shall not be used for this task.

Flushing shall be achieved by breaking the vacuum in the system with OFN and continuing to fill until the working pressure is achieved, then venting to the atmosphere, and finally pulling down to a vacuum. This process shall be repeated until no refrigerant is within the system. When the final OFN charge is used, the system shall be vented down to atmospheric pressure to enable work to take place. This operation is absolutely vital if brazing operations on the pipe-work are to take place.

Ensure that the outlet for the vacuum pump is not close to any ignition sources and there is ventilation available.

13) Charging procedures

In addition to conventional charging procedures, the following requirements shall be followed.

--Ensure that contamination of different refrigerants does not occur when using charging equipment. Hoses or lines shall be as short as possible to minimize the amount of refrigerant contained in them.

--Cylinders shall be kept upright.

--Ensure that the refrigeration system is earthed prior to charging the system with refrigerant.

--Label the system when charging is complete (if not already).

--Extreme care shall be taken not to overfill the refrigeration system.

--Prior to recharging the system, it shall be pressure tested with OFN. The system shall be leak tested on completion of charging prior to commissioning. A follow-up leak test shall be carried out prior to leaving the site.

14) Decommissioning

Before carrying out this procedure, it is essential that the technician is completely familiar with the equipment and all its detail. It is recommended good practice that all refrigerants are recovered safely. Prior to the task being carried out, an oil and refrigerant sample shall be taken in case analysis is required prior to re-use of reclaimed refrigerant. It is essential that electrical power is available before the task is commenced.

a) Become familiar with the equipment and its operation.

b) Isolate system electrically.

c) Before attempting the procedure ensure that:

- Mechanical handling equipment is available, if required, for handling refrigerant cylinders;
- All personal protective equipment is available and being used correctly;
- The recovery process is supervised at all times by a competent person;
- Recovery equipment and cylinders conform to the appropriate standards.

d) Pump down refrigerant system, if possible.

e) If a vacuum is not possible, make a manifold so that refrigerant can be removed from various parts of the system.

f) Make sure that cylinder is situated on the scales before recovery takes place.

g) Start the recovery machine and operate in accordance with manufacturer's instructions.

h) Do not overfill cylinders. (No more than 80 % volume liquid charge).

i) Do not exceed the maximum working pressure of the cylinder, even temporarily.

j) When the cylinders have been filled correctly and the process completed, make sure that the cylinders and the equipment are removed from the site promptly and all isolation valves on the equipment are closed off.

k) Recovered refrigerant shall not be charged into another refrigeration system unless it has been cleaned and checked.

15) Labelling

Equipment shall be labeled stating that it has been decommissioned and emptied of refrigerant.

The label shall be dated and signed. Ensure that there are labels on the equipment stating the equipment contains flammable refrigerant.

16) Recovery

When removing refrigerants from a system, either for servicing or decommissioning, it is recommended good practice that all refrigerants are removed safely. When transferring refrigerant into cylinders, ensure that only appropriate refrigerant recovery cylinders are employed. Ensure that the correct number of cylinders for holding the total system charge is available. All cylinders to be used are designated for the recovered refrigerant and labeled for that refrigerant (i.e. special cylinders for the recovery of refrigerant). Cylinders shall be complete with a pressure relief valve and associated shut-off valves in good working order. Empty recovery cylinders are evacuated and, if possible, cooled before recovery occurs. The recovery equipment shall be in good working order with a set of instructions concerning the equipment that is at hand and shall be suitable for the recovery of flammable refrigerants. In addition, a set of calibrated weighing scales shall be available and in good working order. Hoses shall be complete with leak-free disconnect couplings and in good condition. Before using the recovery machine, check that it is in satisfactory working order, has been properly maintained, and that any associated electrical components are sealed to prevent ignition in the event of a refrigerant release. Consulting manufacturer if in doubt.

The recovered refrigerant shall be returned to the refrigerant supplier in the correct recovery cylinder, and the relevant Waste Transfer Note arranged. Do not mix refrigerants in recovery units and especially not in cylinders. If compressors or compressor oils are to be removed, ensure that they have been evacuated to an acceptable level to make certain that flammable refrigerant does not remain within the lubricant. The evacuation process shall be carried out prior to returning the compressor to the suppliers. Only electric heating to the compressor body shall be employed to accelerate this process. When oil is drained from a system, it shall be carried out safely.

4. Other Safety

Thank you for choosing a heat pump. This is a heat pump capable of providing the ideal comfort for your home, always with a suitable hydraulic installation. The unit is an air source heat pump for space heating/cooling and a sanitary water heater for houses, apartment blocks, and small industrial premises. Outdoor air is used as a heat source creating free energy to heat your home.

This manual forms an essential part of the product and it must be given to the user. Read the warnings and recommendations in the manual carefully, as they contain important information on the safety, use, and maintenance of the installation.

This heat pump must be installed by qualified personnel only, in accordance with the legislation in force and following the manufacturer's instructions.

The start-up of this heat pump and any maintenance operations must be carried out only by qualified personnel only.

Incorrect installation of this heat pump could result in damage to people, animals or property, and the manufacturer will not be held liable in such cases.

The following safety precautions should always be taken into account:

- 1) Be sure to read the following WARNING before installing the unit.
- 2) Be sure to observe the cautions specified here as they include important items related to safety.
- 3) After reading these instructions, be sure to keep them in a handy place for future reference.
- 4) Equipment shall contain the following identification:

Inflammable “  ” Read Carefully “  ” Professional Recycling “  ”

Operation Instruction

1. Control Panel

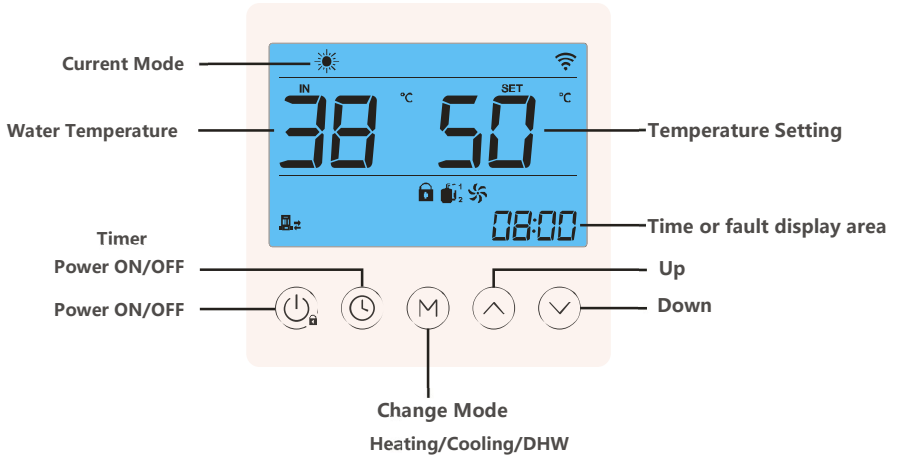

2. Operation Instruction

Power On/Off

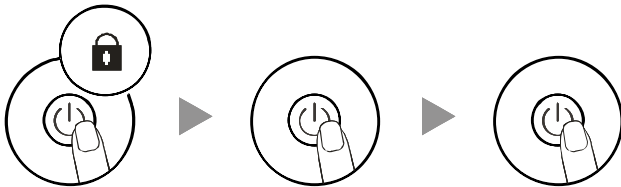

When the lock symbol is displayed, press and hold 5s to unlock the screen

Long press 2s to turn off the heat pump

Long press 2s to turn on the heat pump

Mode Setting

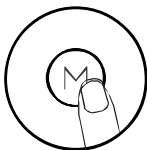

Press M to switch mode Cooling/Heating/DHW

Temperature Setting

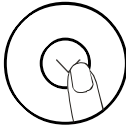

Press the up button
to raise the temperature

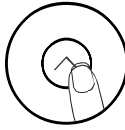

Press the down button
to lower the temperature

If there is no operation or press the on/off button within 5 seconds, the setting temperature will be saved automatically and return to the homepage

Time Setting



Press the clock button for
1s to enter the current clock
setting



Press the clock key again,
the hour area flashes

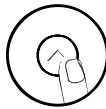

Press the up and down
keys to adjust the value



Press the clock button again to
enter the minute clock setting



Press the clock button
again, the minute
area flashes

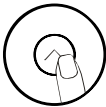

Press the up and down
keys to adjust the value

If there is no operation or press the on/off button within 5 seconds, the setting temperature will be saved automatically and return to the homepage

Scheduled Power On

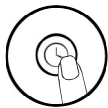

Press and hold the clock
key for 5s to enter the
timer boot time setting



Press the clock key again,
the hour area flashes

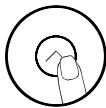

Press the up and down
keys to adjust the value



Press the clock button again to
enter the minute clock setting



Press the clock button
again, the minute
area flashes

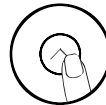

Press the up and down
keys to adjust the value

If there is no operation or press the on/off button within 5 seconds, the setting temperature will be saved automatically and return to the homepage.
Three timings can be set.

Status Search

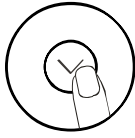

Long press the down button for 5 s to enter the status search page



Enter the status search page

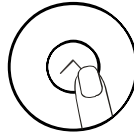

Adjust the status parameter serial number in combination with the up and down keys

ECO Mode

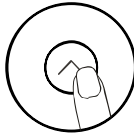
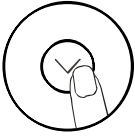

Unlock the case while holding down the up button + down button to enter ECO energy-saving mode

ECO symbol lit

Pump forced evacuation mode

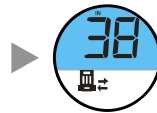
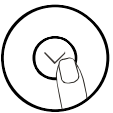
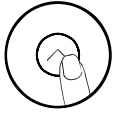

Press and hold the on/off button + up button at the same time in the unlocked state to enter the intelligent distribution mode

When the water pump symbol flashes enter forced emptying mode

3. Temperature and Climate Curve Setting

Setting Climate Temperature Curve



Press the key for 1s to enter the temperature setting interface



Set temperature flashing



Press and hold the M button again for 5s



Enter the temperature curve setting status to enable or disable the curve



Press the upper key again for 1s

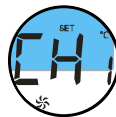

Curve set successfully

When the climate temperature curve function is enabled, the user can select one of the eight curves in the main interface; curve 4 is the default curve, and curve 6 is the ECO energy-saving curve.

4. Wi-Fi Setting

4.1 Software Download and Account Registration

4.1.1 Search for  Smart Life in the app store on the mobile phone, and download and install it.

4.1.2 Users who do not have an account can apply by clicking the "Create New User" function on the login page.

4.1.3 Create a new account → Enter your cell phone number or email address, → get the verification code → to enter the verification code → set the password → complete, in the following order.

4.1.4 After registration is complete, you need to create a family: create a family, → set the family name → set the location → to add a room → ultimately, in the following order.

4.1.5 Click on the device name to enter the main interface of the device

- 1) Family name, which allows access to family management.
- 2) Adding devices.
- 3) Added room; click on it to view the devices added to that room.
- 4) Room management.

4.2 Connection (Intelligent Mode)

Manual Intelligent Distribution Network

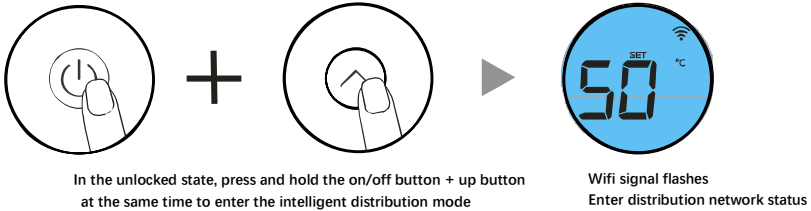

Step 1

Open the "Smart Life" APP, login to the main interface, click the "lift" icon in the upper right corner to add devices or "Add Device" in the interface, enter the device type selection, and select "Smart Heat Pump (Wi-Fi)" in the "Main Appliance" device, enter the add device interface.

Step 2

Select Smart Heat Pump (Wi-Fi) and enter into the Wi-Fi connection interface, enter the Wi-Fi password that the phone has been connected to (must be the same as the Wi-Fi connection to the phone), click Next, and confirm that the line controller has selected the intelligent distribution mode, "📶" icon is fast-flashing, click "Confirm that the indicator is flashing, then start adding devices directly, click the "lift" icon to add devices.

Note: The icon flashes slowly when the Wi-Fi module is connected to the Wi-Fi hotspot.

Step 3

The system prompts "Add Device Successfully" and then the network is successfully distributed. Click on the icon in this interface to change the device name, select the device installation location (living room, main bedroom), and click Finish to enter the main interface of device operation.

4.3 Connection (AP Mode)

Manual AP Distribution Network

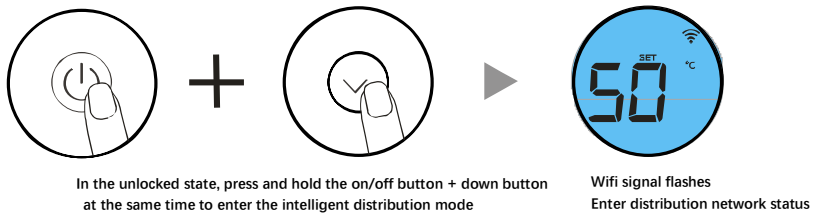

Step 1 and Step 2: Be consistent with the Intelligent Mode

Step 3

Select innovative heat pump (Wi-Fi) after entering into the Wi-Fi connection interface, enter the phone has been connected to the (Wi-Fi) password (must be consistent with the Wi-Fi connection



to the phone), click next, confirm that the line controller has selected AP distribution mode, an icon in the slow flashing state “ ”, click "Confirm that the indicator is in slow flashing," then connect the phone Wi-Fi to the device hotspot (as shown below), confirm that the connection hotspot is correct to continue to the next step then directly begin to connect the device interface, find the device → registers to the cloud → device initialization is complete.

Note: When the wire Wi-Fi module is connected to the Wi-Fi hotspot, the icon “” slows flashing.

Step 4 The same as the Intelligent Mode

Note: If the connection fails, manually enter the AP network configuration mode again and repeat the preceding steps to connect again.

4.4 Software Function Operation

4.4.1 A device is automatically bound to a virtual gateway. The "My Home Heat Pump" (device name, which can be changed) operation page is displayed.

Buy a ticket to enter the device operation page of "My Home Heat Pump" by clicking on "My Home Heat Pump" in the "All Devices" screen of smart Life.

4.4.2 Modify device name and modify device location information Click "Name" to rename the device name and "Location" to alter the device location.

4.5 Device Sharing

Share bound devices in the following sequence:

- 1) After successful sharing, the list is added to display the shared person.
- 2) To delete the shared user, long-press the selected user, and the deletion interface will pop up, click "Delete"
- 3) User interface operations are as follows:
- 4) Enter the account of the shared user and click "Finish" to display the newly shared history in the list of successful sharing
- 5) The interface of the shared person is as follows. The shared device received is displayed. Click in to operate and control the device.

Operation Parameter Query

Query Code	Description	Range
1	Compressor Running Frequency	0 ~ 150 Hz
2	Fan Motor Running Frequency	0 ~ 999 Hz
3	Electronic expansion valve steps	0 ~ 480 P
4	EVI valve steps	0 ~ 480 P
5	AC Input Voltage	0 ~ 500 V
6	AC Input Current	0 ~ 50 A
7	Compressor Phase Current	0 ~ 50 A
8	IPM temperature of the compressor	-40 ~ 140 °C
9	High-pressure saturation temperature	-50 ~ 200 °C
10	Low-pressure saturation temperature	-50 ~ 200 °C
11	External ambient temperature T1	-40 ~ 140 °C
12	Outer coil (fin) T2	-40 ~ 140 °C
13	Internal coil (plate heat exchanger) T3	-40 ~ 140 °C
14	Gas Suction Temperature T4	-40 ~ 140 °C
15	Gas Exhaust Temperature T5	0 ~ 150 °C
16	Water Inlet Temperature T6	-40 ~ 140 °C
17	Water Outlet Temperature T7	-40 ~ 140 °C
18	Economizer Inlet Temperature T8	-40 ~ 140 °C
19	Economizer Outlet Temperature T9	-40 ~ 140 °C
20	Machine Tooling No.	0 ~ 120
21	Water tank temperature	-40 ~ 140 °C
22	Fluorine plate heat exchanger out temperature	-40 ~ 140 °C
23	Driver manufacturers	0 ~ 10
24	Water pump speed PWM	0 ~ 100%
25	Water flow	3 ~ 100 L/min
26	Return water temperature	-40 ~ 140 °C
27	Unit input voltage	0 ~ 500 V
28	Unit input current	0A ~ 99.99A
29	Unit input power	0 ~ 99.99KW
30	Total electricity consumption of the unit	0 ~ 9999 Kw.h

Display Fault: When the machine has a fault, the fault is flashing in the timing area and the fault code is displayed cyclically; when the fault is eliminated, the standard display is restored.

Dimension

1. Dimension

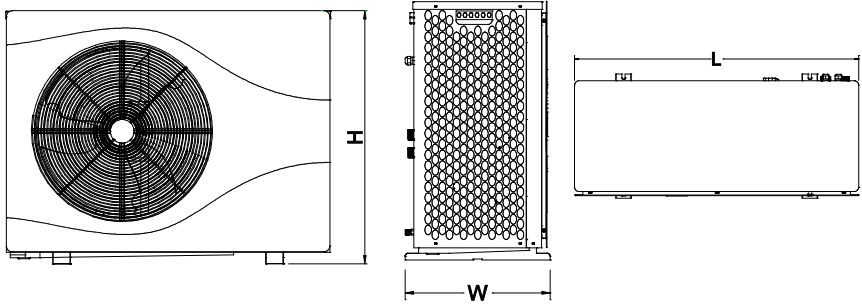

Model	Dimensions L×W×H(mm)
BLN-006TB1	1100×445×850
BLN-010TB1	1100×445×850
BLN-010TB3	1100×445×850
BLN-014TB1	1110×480×850
BLN-014TB3	1110×480×850

Model	Dimensions L1×W1×H1(mm)
BLN-018TB1	1110×445×1450
BLN-018TB3	1110×445×1450
BLN-024TB1	1110×445×1450

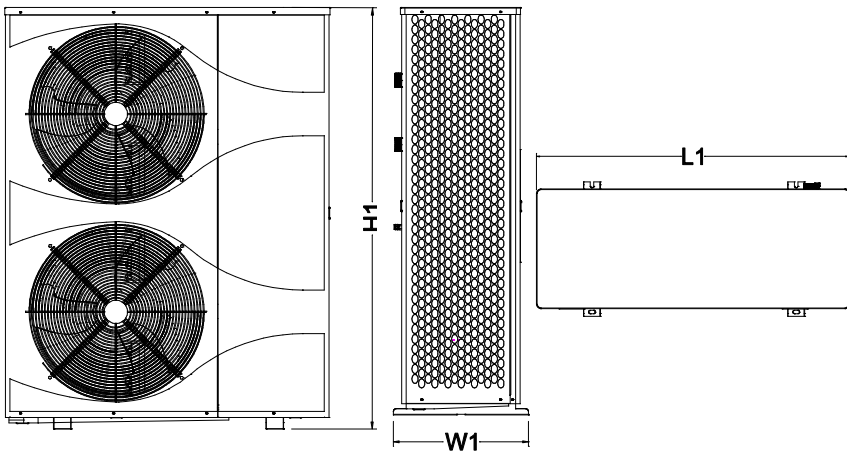

2. Explosive Diagram

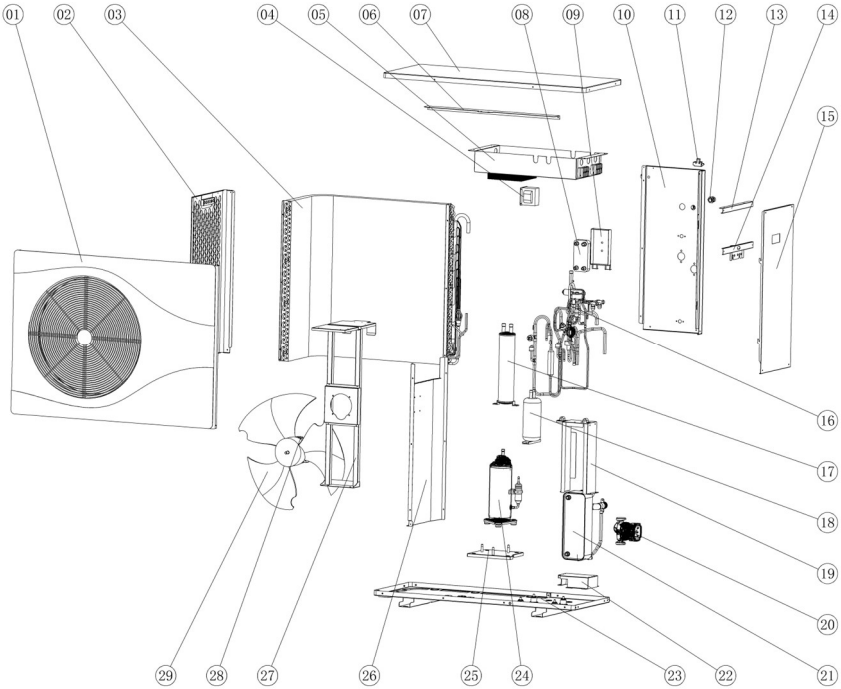

Number	Description	Number	Description
1	Front Panel Components	16	Piping Components
2	Left-side Plate	17	Gas-liquid Separator
3	Evaporator Assembly	18	Accumulator
4	Electric Reactor	19	Condenser Plate
5	Electrical Components	20	Inverter Circulating Water Pump
6	Junction Plate 1	21	Condenser
7	Top Cover	22	Mounting Plate 2
8	Intermediate Heat Exchanger	23	Unit Base Plate
9	Mounting Plate 1	24	Compressor
10	Right-back Plate	25	Mounting Plate 3
11	Probe Clamp	26	Medium Septum
12	Plastic Waterproof Joint	27	The Motor Bracket
13	Junction Plate 2	28	The Motor
14	Junction Plate 3	29	Fan Blade
15	Right-side Plate		

Installation

1. Installation Preparation

1.1 Install The Required Tools (Self-Provided)

Number	Tool	Number	Tool
1	Level	10	Saw
2	Electric Hammer	11	Flat Blade Screwdriver
3	Adjustable Wrench	12	Cross Screwdriver
4	Needle-nose Plier	13	Copper Tube Knife
5	Impulse Drill	14	PP-R Tube Knife
6	Ruler	15	PP-R Tube Heat Melting Device
7	Torque Wrench	16	Compound Gauge
8	Hexagonal Wrench	17	Vacuum Pump
9	Hammer	18	Electronic Balance

1.2 Connecting Wires, Insulation Materials, PP-R Pipe, And Connector

- The material and thickness of the insulation pipe meet the specified requirements. Otherwise, heat loss and condensation will be caused.
- Please refer to this manual's "Electrical Installation" description section for wire size selection.

Model	The water inlet/outlet size
BLN-006TB1	DN25 (1")
BLN-010TB1	DN25 (1")
BLN-010TB3	DN25 (1")
BLN-014TB1	DN32 (1-1/4")
BLN-018TB1	DN40 (1.5")
BLN-014TB3	DN32 (1-1/4")
BLN-018TB3	DN40 (1.5")
BLN-024TB3	DN40 (1.5")

1.3 Other Installation Materials

- Fix the pipe bracket and pipe clamp of the connecting pipe
- Wire threading pipe and pipe clamp
- Insulating tape, raw tape
- Expansion bolt
- Mounting bracket

2. Heat Pump Installation

- 2.1 The machine installation space meets the following schematic requirements to ensure regular air circulation and maintenance;
- 2.2 The location of the machine should be kept away from heat, steam, or flammable gases;
- 2.3 Do not install the machine in places with strong wind or dust;
- 2.4 Do not install the machine where it is often passed through the air suction side and air exhaust side;
- 2.5 The installation position of the machine should be adequately drained to the nearby sewer.

Heat Pump Installation Space Diagram

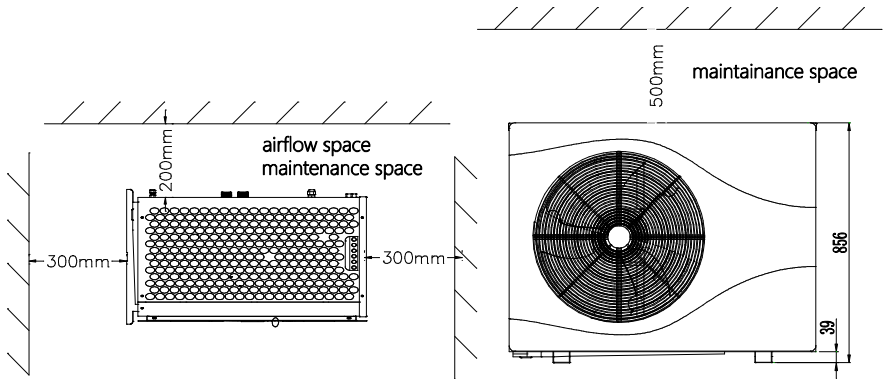

Note

Installation In The Following Locations May Cause The Machine To Malfunction:

1. A place with more oil;
2. Wet place
3. Seaside saline-alkali area;
4. Special environmental conditions;
5. High-frequency facilities such as wireless equipment, welding machines, and medical equipment.

3. Outdoor Unit Specific Installation Steps

- 3.1 Install the unit on a solid surface such as concrete, and the load-bearing cover or mounting bracket must meet the strength requirements;
- 3.2 Fasten the outdoor unit to the mounting bracket with bolts and nuts and keep it level;

-
- 3.3 If installed on a wall or a roof, the bracket must be firmly fixed to prevent damage caused by an earthquake or strong wind;
 - 3.4 The positioning dimension of the outdoor unit installation base is 810*394mm. It is required to install four-position foot bolts with a diameter of 10mm—at the bottom of the installation of the outdoor unit. The inch recommendation is 1200*450mm.



Installation Precautions

1. The unit should be installed so that the inclination of any vertical surface does not exceed 5 degrees;
2. Do not install the outdoor unit directly on the ground;
3. The strength of the ordinary air-conditioning bracket may not apply to the unit. Please design or select the frame according to the weight of the team;
4. If the mainframe is installed and fixed on the open balcony and the roof, it is necessary to lift the unit. Pay attention to the following points when lifting:
 - 4.1 Please use four or more soft slings to lift the handling unit;
 - 4.2 To avoid scratching and deformation of the surface of the unit, please install the guard plate on the surface of the team during lifting and loading;
 - 4.3 Before final installation, it is necessary to check whether the foundation is correct or not, in case it is wrong with the actual object.

4. User Water System Installation

- 4.1 The Installation Of The Water System Must Meet The Following Principles:
 - 4.1.1 Pipe length is as short as possible;
 - 4.1.2 Pipe diameter must meet the requirements of the unit;
 - 4.1.3 The elbows on the waterway are as few as possible, and the elbow radius is as large as possible;
 - 4.1.4 The thickness of the water pipe insulation layer meets the specified requirements;
 - 4.1.5 Dust and debris should not enter the pipeline system as much as possible;
 - 4.1.6 The unit must be fixed before the piping system can be installed.



Remark

1. Hydraulic calculation must be carried out after the primary water pipe selection is completed. If the waterside pipeline resistance is more excellent than the selected pump lift, the larger water pump must be re-selected, or the water pipe must be increased in size;
2. When multiple units are connected in parallel, the primary and circulating water pumps must be selected as appropriate according to the hydraulic calculation requirements.



Remark

1. The same piping design is allowed to distribute the water evenly.
 2. The system must be equipped with an automatic water supply valve, and the highest point of the water system must be equipped with an automatic pressure relief valve;
 3. The drain valve shall be installed at the bottom of the pipeline to facilitate drainage;
 4. The pressure relief valve is installed at the highest point of the system pipeline, and the terminal of the water pipe must have an expansion diameter;
 5. Normal working water capacity can ensure normal defrosting in winter (ensure that the water capacity per kW exceeds 10L);
 6. The machine has been equipped with a water flow switch; users do not need to install one more;
 7. To facilitate the maintenance of the machine, a pressure gauge is required to be installed for the outlet pipe of the device;
 8. If the compartment controls the floor heating, and the number of the manifolds in the smallest area is less than or equal to 2, please install the differential pressure bypass valve according to the schematic diagram;
- 4.2 Water Quality Requirements By The Machine
- 4.2.1 When water quality is not good, it will produce some scale and sediment such as sand. Therefore, the water used must be filtered and softened with soft water equipment before it flows into the heat pump water system;
 - 4.2.2 Please analyze the water quality before using the machine, such as PH value, conductivity, chloride ion concentration, sulfur ion concentration, etc.

PH	Water Hardness	Conductivity	S	Cl	Nh4
7~8.5	<50ppm	<200v/cm(25°C)	N/A	<500ppm	N/A
So4	Si	Iron content	Na	Ca<	
<50ppm	<30ppm	<0.3ppm	N/A	<50ppm	

- 4.3 Water Pipeline Installation Instructions
- 4.3.1 Install all water pipelines;
 - 4.3.2 Check if any water leaks in the pressurized pipelines;
 - 4.3.3 Clean the water pipelines.
- 4.4 Water Pipeline Feed-Water And Pipeline Emptying Steps:
- 4.4.1 Open the pressure relief valve on the water distributor and all valves;
 - 4.4.2 Feed the water at the pipe filling port;
 - 4.4.3 During the feed-water process, it is necessary to observe if the pressure relief valve or the drain valve has water overflow, and if there is water overflow, it means that the water in the system has been filled;
 - 4.4.4 Close the pressure relief valve, and then look at the water pressure gauge. If the pressure value is more than 0.15Mpa, please close the feed-water valve and complete the water drain.

5. Selection and Installation of Water System Accessories

5.1 Selection Of Circulating Pump

- 5.1.1 The machine must be installed with a circulating pump to be used. The heat pump provides the power port of the circulating pump (single-phase power supply). Please refer to the circuit diagram for wiring. The maximum power of the circulating pump is not allowed to exceed 1.5 kW.
- 5.1.2 Please select the circulating pump according to the actual lift required, and the flow must be guaranteed to meet the requirements of the machine nameplate.

5.2 Selection Of Auxiliary Electric Heater

- 5.2.1 The user can select the auxiliary electric heater if needed; however, the machine only provides the port connected with a signal wire to control the auxiliary electric heater.
 - 5.2.2 Professionals must install the installation of an auxiliary electric heater.
- 5.3 Selection Of Water Flow Switch: The machine has a built-in flow switch, so it does not require one more water flow switch.

5.4 Other Optional Accessories Recommended

Accessories	Description	Remark
Buffer Tank	60L or bigger	
Expansion Tank	5 L	Only Pressurized System
Pressure Gauge	1.5 Mpa	
Safety Valve	0.3 Mpa	Only Pressurized System

6. Electrical Installation

All wiring and grounding must comply with local electrical codes.



Note

1. The specification label should be carefully checked to ensure that the wiring meets the specified requirements and is correctly wired according to the wiring diagram;
2. The auxiliary electric heater must be equipped with an independent current circuit breaker and leakage protector;
3. The power supply must meet the requirements of the machine and must be reliably and effectively wired;
4. Wires should not be in contact with copper pipes, compressors, motors, or other operating components;
5. Do not change the internal wiring of the machine without permission. Otherwise, the seller will not commit any responsibility;
6. Do not change the internal wiring of the machine without permission. Otherwise, the seller will not commit any responsibility;
7. Do not send power before the wiring is completed to avoid personal injury;
8. The supply voltage should vary within $\pm 10\%$ of the standard value.
9. Electrical specifications:

Model	BLN-006 TB1	BLN-010 TB1	BLN-014 TB1	BLN-018 TB1
Power Supply	220~240 V/ 1/ 50 Hz			
Max Input Current (A)	12	17	27.50	35.50
Fuse Rated Current(A)	12	17	28	36
Air Switch (mA)	25	25	40	50
Power Cable (mm ²)	4.00	4.00	6.00	6.00

Model	BLN-010 TB3	BLN-014 TB3	BLN-018 TB3	BLN-024 TB3
Power Supply	380~415 V/ 3/ 50 Hz			
Max Input Current (A)	6.5	10.5	13.2	17.30
Fuse Rated Current(A)	12	17	17	28
Air Switch (mA)	25	25	25	40
Power Cable (mm ²)	4.00	4.00	4.00	6.00

Power Cable And Signal Wire Connection Instruction

1. Remove the machine's front cover and connect the wire to the corresponding terminal block according to the electrical wiring diagram to confirm that the connection is secure.
2. Secure the cable with the wire clamp and install the service plate.
3. Do not connect the wrong line. Otherwise, it will cause electrical failure or even damage the machine.
4. The type and rating of the fuse are based on the specifications of the corresponding controller or fuse cover.
5. The power cable must be selected and installed by a professional installer. When the installer chooses the power cable, the power cable should not be lighter than the neoprene armoured cord (line 57 of IEC 60245). For specific power cable specifications, see the electrical specifications.
6. If the user's power distribution capacity is insufficient or the power cord (copper core wire) is not configured as required, the machine cannot be started or operated normally. The seller will not take any responsibility.

Mainboard Output Definitions

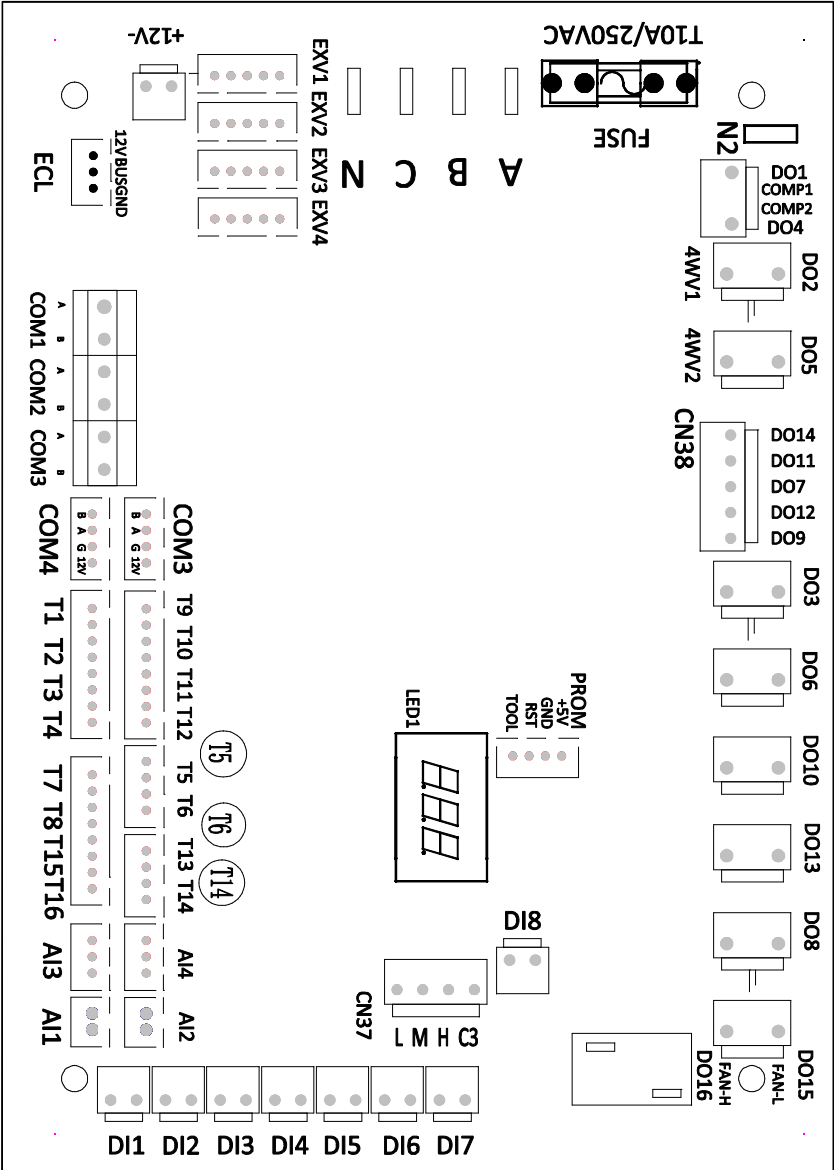

Seq.	Port	Description	Seq.	Port	Description
1	D01	Hot Water Electric Heating	35	A13	Low-Pressure Sensors
2	D02	Four-Way Valve	36	T1	Outer Coil Temperature
3	D03	Liquid Injection Valve	37	T2	Return Air Temperature
4	D04	Reservation	38	T3	Exhaust Temperature
5	D05	Reservation	39	T4	Inner Coil Temperature
6	D06	Water Return Valve	40	T5	Economizer Inlet Temperature
7	D07	Crankshaft Heating	41	T6	Economizer Outlet Temperature
8	D08	Chassis Heating	42	T7	Outdoor Ambient Temperature
9	D09	Auxiliary Electric Heating	43	T8	Water Inlet Temperature
10	D010	Expansion Tank Heating	44	T9	Master Outlet Temperature
11	D011	Heat Source Hot Water Pump	45	T10	Heating Water Tank Temperature
12	D012	Heat Source Air Conditioning Pumps	46	T11	Heating Side Heat Source Temperature
13	D013	Plate Heat Exchanger Heating	47	T12	Hot Water Side Heat Source Temperature
14	D014	Enthalpy Valve 1	48	T13	Return Water Temperature
15	D015	Low wind (AC) /heat dissipation fan	49	T14	Freeze Protection Temperature
16	D016	High Wind (AC)	50	T15	Water Outler Temperature
17	D017	Hot Water Auxiliary Pumps	51	T16	Domestic Water Tank Temperature (Hot Water)
18	C2	Public Side1	52	COM3	Inverter
19	C1	Public Side2	53	COM4	Controller
20	D18	Medium Voltage Switch 1	54	COM3	GPRS Module
21	D17	Reservation	55	COM2	Building Monitoring
22	D16	Linkage Switch	56	COM1	Module Cascade
23	D15	Reservation	57	ECL	Extension Modules
24	D14	Reservation	58	12V	DC 12V Power Supply
25	D13	Water Flow Switch	59	EXV1	EEV Main Valve 1
26	D12	Low-Pressure(gas) Switch	60	EXV2	EEV Auxiliary Valves 1
27	D11	High-Pressure(gas) Switch	61	EXV3	Main Valve 2
28	C3	Reservation	62	EXV4	Auxiliary Valves 2
29	H	Reservation	63	N	Power Input Zero Line
30	M	Reservation	64	C	Power Input T-Phase
31	L	Reservation	65	B	Power Input S-Phase
32	A12	Reservation	66	A	Power Input R-Phase
33	A11	Reservation	67	LED1	8-Bit Dialing Code
34	A14	High-Pressure Sensors			

Expansion Board Output Definition

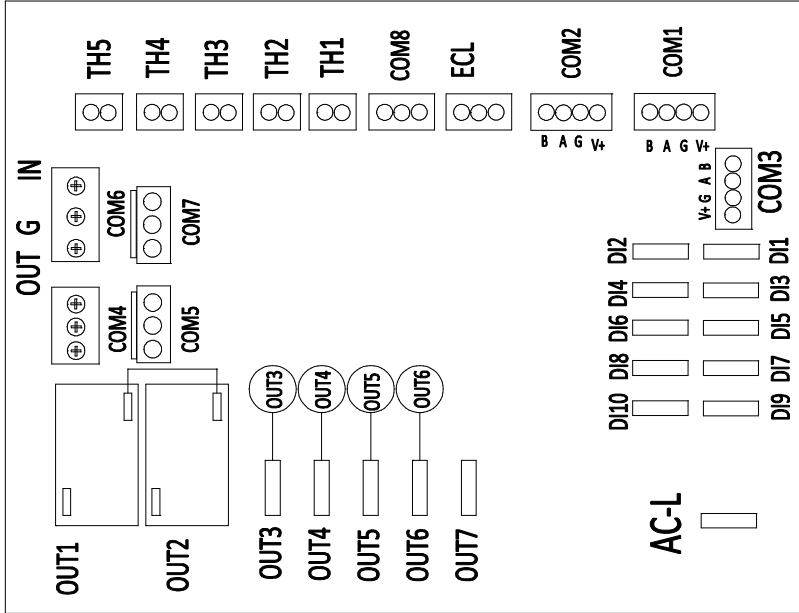

Seq	Port	Description	Seq	Port	Description
1	OUT1	Circulating Pump	18	COM1	RS485 Communication 2
2	OUT2	Indoor Circulation Pump	19	COM2	RS485 Communication 1
3	OUT3	Air-Conditioning Valve Off	20	COM3	RS485 Communication 3
4	OUT4	Air-Conditioning Valve On	21	COM4	Indoor Circulation Pump
5	OUT5	Hot Water Valve On	22	COM5	Reservation
6	OUT6	Hot Water Valve Off	23	COM6	Heat Pump Circulation Pump
7	OUT7	Hot Water Electric Heating	24	COM7	Reservation
8	DI1	Reservation	25	COM8	Water Flowmeter
9	DI2	Heat Source Hot Water Side Linkage Wwitch	26	TH1	Reservation
10	DI3	Reservation	27	TH2	Reservation
11	DI4	Heat Source Heating Side Linkage Switch	28	TH3	Reservation
12	DI5	Reservation	29	TH4	Reservation
13	DI6	Indoor Circulation Pump Linkage Switch	30	TH5	Reservation
14	DI7	Reservation	31		
15	DI8	Reservation	32		
16	DI9	Reservation	33		
17	DI10	Reservation	34		

Wire Diagram

Terminal TB1 3 Phase

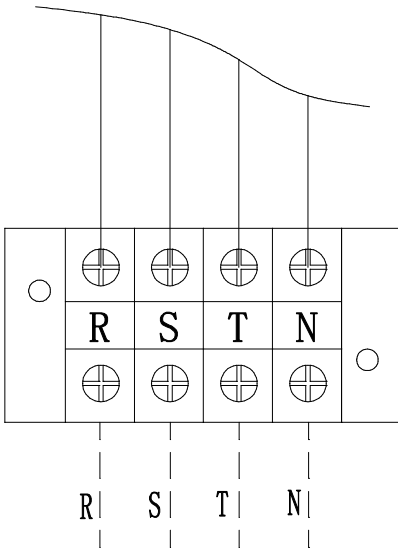

Power supply specification:
380~415V/50Hz

Neutral, live wire copper
wire: wire diameter is not
less than 6mm²

Terminal TB1 1 Phase

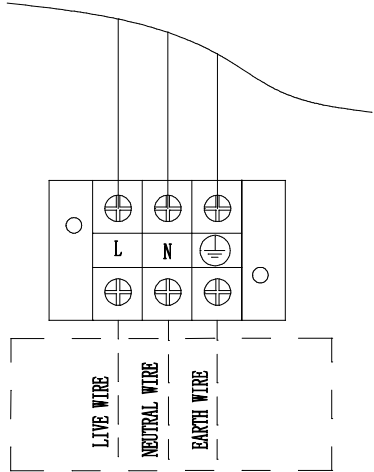

Power Supply: 230V/50Hz

The neutral and live wires are copper:
the wire diameter is not less than 6
mm², and the earth wire is a special
yellow/green earth wire with a wire
diameter of not less than 2.5mm²

TERMINAL 2

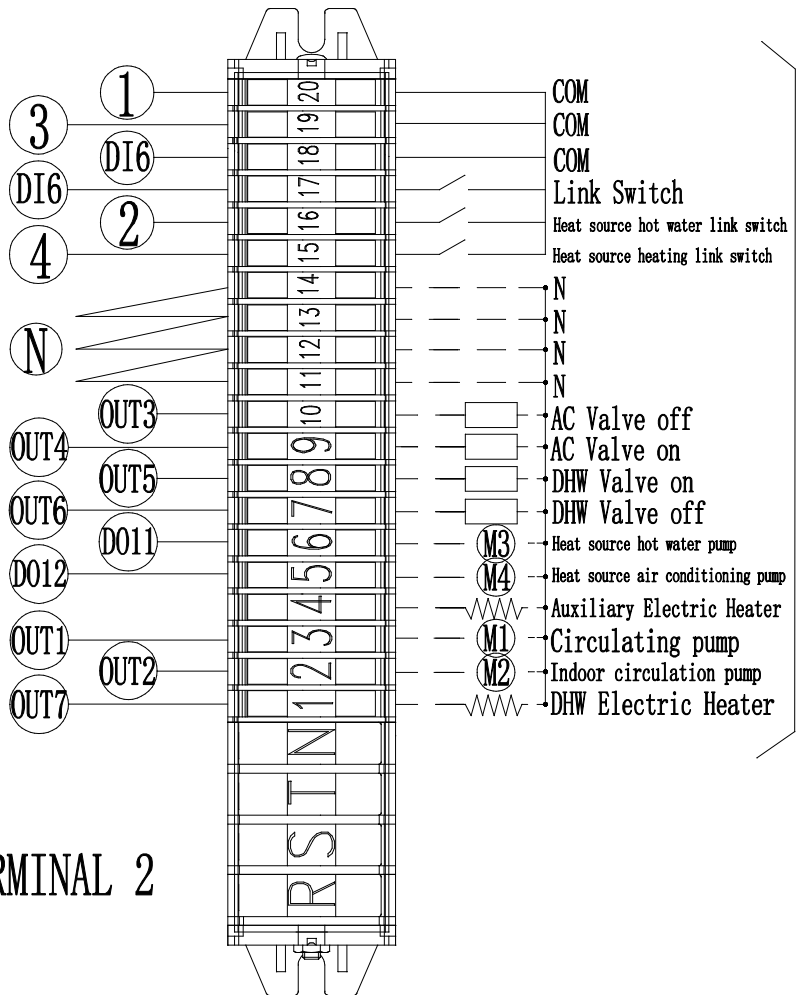

Commissioning and Maintenance

1. Precautions Before Commissioning

- 1.1 Is the machine adequately installed?
- 1.2 Is the wiring and pipe correct?
- 1.3 Whether the water pipelines are empty or not?
- 1.4 Whether the heat insulation has been perfected?
- 1.5 Is the ground wire connected reliably?
- 1.6 Whether the power supply voltage matches the rated voltage of the machine?
- 1.7 Is there any obstacle in the air inlet and outlet of the machine?
- 1.8 Is the safety valve installed correctly?
- 1.9 Whether the leakage protector can operate effectively?
- 1.10 The system water pressure is not less than 0.15 MPa, and the maximum pressure cannot exceed 0.5 MPa;
- 1.11 In winter, the machine needs to be energized at least 24 hours before the operation, as the compressor needs to be preheated.

2. Commissioning

Use the controller to control the machine and check the following items according to the instruction manual: (If there is any fault, please find out the faults and reasons described in the manual and eliminate them)

- 2.1 Is the controller regular?
- 2.2 Is the function key of the controller regular?
- 2.3 Is the drainage normal?
- 2.4 Test whether the heating mode and cooling mode are working correctly;
- 2.5 Is the outlet water temperature average?
- 2.6 Whether there is vibration and abnormal sound during operation?
- 2.7 Does the generated wind, noise, and condensation affect neighbors?
- 2.8 Is there a refrigerant leakage?

3. Operation and Debugging

- 3.1 About 3mins of protection
Due to the self-protection of the compressor, the machine cannot be restarted again within 3 mins.
- 3.2 Feature of heating operation
If the ambient temperature is too high during operation, the outdoor motor may run low or stop.
- 3.3 In the case of heating operation, when the unit has frost formation, the defrosting procedure (about 2-8 minutes) is automatically performed to improve the heating effect. The outdoor motor stops running during the “defrost” operation.

3.4 Power Outage

If there is a power outage during operation, the machine will stop running. Before the power outage, the controller automatically memories the ON/OFF status of the device. After re-powering, the controller will send an ON/OFF signal to the device according to the state of memory before the power outage to ensure that the device recovers from the previous status from abnormal power failure.

3.5 Heating Capacity

Because the heat pump absorbs heat from the outside, the heating capacity will be reduced once the outdoor temperature is lowered.

3.6 Electric Leakage Protector

After the unit has been running for some time (usually one month), the leakage protector needs to press the test button under the closed energized state to check whether the performance of the leakage protector is regular and reliable (the leakage protector should be disconnected once every time the test button is pressed). If the accident is not found, the test can be sent once. If it is not working, the cause should be found, and if necessary, the action characteristic test should be carried out. After checking, it is confirmed that the leakage protector itself has failed. It should be replaced or repaired in time.

3.7 Working Temperature Range

To use the machine correctly, please operate under the following conditions, outdoor temperature: -30 °C ~ 45 °C for heating mode, 16 °C ~ 45 °C for cooling mode.

3.8 Antifreeze in the winter

When the ambient temperature is below 0 °C, it is strictly forbidden to cut off the power. If there is an unexpected power failure under this condition, please drain the water from the heat.

4. Maintenance

1. Please check whether the grounding wire is connected reliably before use. If there is any abnormality, please replace it in time.
2. Please check the air inlet and outlet of the outdoor unit regularly for blockage.
3. Professionals must clean the outdoor unit heat exchanger, casing, and water circulation piping. It is recommended to clean the filter of the waterside filter regularly (cleaning is usually done once a year, depending on the actual situation).
4. Regularly check that the safety valve is working correctly, and ensure that the drain can be drained normally by manually turning the red knob (usually once every three months, depending on the actual situation).
5. Regularly (usually once a year, but depending on the actual situation) check whether the water pipe joint and the refrigerant connection pipe are leaking or leaking refrigerant (there are oil leakage marks). If there is any leak, please contact the seller.
6. The machine can only be serviced by a professional. The device must be cut off before contacting the wiring part.
7. Once the machine will not be used for a long time, please cut off the power, drain the water in the pipeline, and close each valve.

Trouble Analysis

Error code	Fault Description	Failure Causes
E01	Wrong-Phase Protection	Power supply phase sequence error
E02	Power Supply Lack Of Phase	The power supply is out of phase
E03	Outside Water Flow Switch Fault	<ol style="list-style-type: none"> 1. Circulating pump failed, or water system blocked 2. Water flow switch failed, or opposite installed direction 3. The lift of the circulating pump is not enough 4. Circulating pump has opposite installed direction
E04	Abnormal Communication Between The Main Control Board And Remote Module	Check the communication connection
E05	High-Pressure Switch One Fault	<ol style="list-style-type: none"> 1. High-voltage switch failed 2. Excessive refrigerant 3. Fan doesn't work typically, or water circulated abnormally 4. Air or other objects mixed into the refrigeration system 5. Too much scale in the water heat exchanger
E06	Low-Pressure Switch One Fault	<ol style="list-style-type: none"> 1. Low-voltage switch fault 2. Lack of refrigerant 3. Fan doesn't work normally 4. Block exists in refrigeration system
E07	High-Pressure Switch Two Fault	Same as E05
E08	Low-Pressure Switch Two Fault	Same as E06
E09	Communication Failure	The controller is not connected
E10	Indoor Side Water Flow Failure	Same as E03
E11	Limited Time Protection	Enter the power-on password
E12	Exhaust Gas Temperature One Too High Fault	Lack of refrigerant in the fluorine circuit system or sensor damage
E13	Exhaust Gas Temperature Two Too High Fault	Lack of refrigerant in the fluorine circuit system or sensor damage
E14	Hot Water Tank Temperature Failure	Damaged motherboard or sensor
E15	Water Inlet Temperature Sensor Failure	Damaged motherboard or sensor
E16	Coil Sensor One Failure	Damaged motherboard or sensor
E17	Coil Sensor Two Failure	Damaged motherboard or sensor
E18	Exhaust Gas Sensor One Fault	Damaged motherboard or sensor
E19	Exhaust Gas Sensor Two Fault	Damaged motherboard or sensor
E20	Indoor Temperature Sensor Failure	Damaged motherboard or sensor
E21	Environmental Sensor Failure	Damaged motherboard or sensor
E22	User Return Water Sensor Failure	Damaged motherboard or sensor

E23	Cooling Subcooling Protection	Normal anti-freeze protection
E24	Board Change Out Temperature Fault	Damaged motherboard or sensor
E25	Water Level Switch Malfunction	Damage to the mainboard or water level sensor
E26	Anti-Freeze Sensor Malfunction	Damaged motherboard or sensor
E27	Water Outlet Sensor Failure	Damaged motherboard or sensor
E28	Reservation	Reservation
E29	Return Air Sensor One Fault	Damage to the mainboard or water level sensor
E30	Return Air Sensor Two Fault	Damage to the mainboard or water level sensor
E31	Water Pressure Switch Failure	Water pressure switch failure
E32	Excessive Water Temperature Protection	Insufficient water flow or a damaged sensor
E33	High Pressure One Sensor Fault	Damaged motherboard or sensor
E34	Low Pressure One Sensor Fault	Damaged motherboard or sensor
E35	Reservation	Reservation
E36	Reservation	Reservation
E37	The Excessive Temperature Difference Between Inlet And Outlet Water Protection	Insufficient water flow
E38	DC Fan One Failure	Fan drive board or motor damage
E39	DC Fan Two Failure	Fan drive board or motor damage
E40	DC Fan Three Failure	Fan drive board or motor damage
E41	DC Fan Four Failure	Fan drive board or motor damage
E42	Cooling Coil Sensor One Fault	Damaged motherboard or sensor
E43	Cooling Coil Sensor Two Fault	Damaged motherboard or sensor
E44	Low Ambient Temperature Protection	It is a standard protection
E45	High Pressure Two Sensor Failure	Damaged motherboard or sensor
E46	Low Pressure Two Sensor Failure	Damaged motherboard or sensor
E47	Economizer Inlet Sensor One Failure	Damaged motherboard or sensor
E48	Economizer Inlet Sensor Two Failure	Damaged motherboard or sensor
E49	Economizer Outlet Sensor One Failure	Damaged motherboard or sensor
E50	Economizer Outlet Sensor Two Failure	Damaged motherboard or sensor
E51	High Pressure One Overvoltage Protection	Same as E05
E52	Low-Pressure One Undervoltage Protection	Same as E06
E53	High-Pressure Two Overvoltage Protection	Same as E05
E54	High Pressure Two Undervoltage Protection	Same as E06
E55	Expansion Board Communication Exception	Poor or broken signal cable contact
E80	Power Supply Error	Single-phase power unit detects a three-phase electrical signal.
E88	Inverter Module 1 Protection	Compressor or compressor driver board damaged
E89	Inverter Module 2 Protection	Compressor or compressor driver

		board damaged
E94	Water Pump Feedback Failure	Damaged DC pump or poor signal line contact
E96	Abnormal Communication between Compressor One Driver and Main Control Board	Poor or broken signal cable contact
E97	Abnormal Communication between Compressor Two Driver and Main Control Board	Poor or broken signal cable contact
E98	Abnormal Communication between Fan Motor One Driver and Main Control Board	Poor or broken signal cable contact
E99	Abnormal Communication between Fan Motor Two Driver and Main Control Board	Poor or broken signal cable contact

E88/E89	P1	Bit0: IPM overcurrent/IPM module protection
	P2	Bit1: Compressor drive failure/software control abnormality/compressor out of step
	P3	Bit2: Compressor overcurrent
	P4	Bit3: Input voltage is out of phase (single phase is invalid)
	P5	Bit4: IPM current sampling fault
	P6	Bit5: Overheating shutdown of power components
	P7	Bit6: Pre-charge failure
	P8	Bit7: DC bus over-voltage
	P9	Bit8: DC bus undervoltage
	P10	Bit9: AC input undervoltage
	P11	Bit10: AC input overcurrent
	P12	Bit11: Input voltage sampling fault
	P13	Bit12: DSP and PFC communication failure
	P14	Bit13: Radiator temperature sensor failure
	P15	Bit14: DSP and communication board communication failure
	P16	Bit15: Abnormal communication with main control board
	P17	Bit0: Compressor overcurrent alarm
	P18	Bit1: Compressor weak magnetic protection alarm
	P19	Bit2: PIM overheat alarm
	P20	Bit3: PFC overheat alarm
	P21	Bit4: AC input overcurrent alarm
	P22	Bit5: EEPROM failure alarm
	P23	Bit6:NA
	P24	Bit7: EEPROM flush complete (can only be removed after reboot).
	P25	Bit8: Temperature sensing fault limit frequency.
	P26	Bit9:AC under-voltage frequency limit protection alarm.
	P27	Bit10~Bit15:NA
	P28	Bit0: IPM module overheating shutdown
	P29	Bit1: Compressor is out of phase
	P30	Bit2: Compressor overload
	P31	Bit3: Input current sampling fault

P32	Bit4: PIM supply voltage failure
P33	Bit5: Pre-charge circuit voltage failure
P34	Bit6: EEPROM failure (for EE models with system parameters stored)
P35	Bit7: AC input overvoltage fault
P36	Bit8: Microelectronic Failure
P37	Bit9: Compressor type code failure
P38	Bit10: Current sampling signal overcurrent (hardware overcurrent) Bit11~Bit15: NA
P39	Bit0: IPM overcurrent/IPM module protection
P40	Bit1: Compressor drive failure/software control abnormality/compressor out of step
P41	Bit2: Compressor overcurrent
P42	Bit3: Input voltage is out of phase (single phase is invalid)

Fault Protection Instructions

1. The machine stops running when a fault is detected;
2. When the fault is removed, the compressor is shut down for three minutes before the machine can be put back into operation;
3. If there are three consecutive low-pressure faults, high-pressure faults, over the current spot, and gas exhaust temperature too high within 30 minutes, the machine will immediately stop running. After the fault is rectified, turn the power on again, start the controller, and the device can be put into operation.
4. If the machine stops running due to the inlet water temperature sensor or the coil temperature sensor fault due to compressor protection, the device will have to be back into operation 3mins later after the spot is removed. If the ambient temperature sensor fails, the machine continues to run.

Maintenance Instructions

1. The machine is equipped with an inspection needle valve on the suction and exhaust pipes. The maintenance personnel can connect the pressure gauge to check the high and low-pressure conditions of the system.
2. If the machine is filled with refrigerant under operating conditions, the refrigerant must be served at the needle valve of the low-pressure side. Suppose the refrigerant is added to the suction side. In that case, the refrigerant opening must be small so that the refrigerant in the refrigerant bottle slowly enters the system to prevent liquid slamming.
3. Refrigerant leakage detection
Check if there is any leakage at the joints with soapy water or a refrigerant leak detector. When a refrigerant leak occurs, the leak point must be found, and the leak point must be repaired. Please ensure no refrigerant or other pressures are left in the system when improving the leak point. Otherwise, it will easily cause copper pipe explosive during welding. The tube is blasted by refrigerant pressure or additional pressure, causing accidental injury to the operator.
Note: When refrigerant leakage occurs in a small space, open all vents or forced ventilation to discharge the refrigerant before performing related operations to prevent people from suffocating accidents.

Specification

Model	BLN-006 TB1	BLN-010 TB1	BLN-014 TB1	BLN-018 TB1
Power supply	220-240 V~/50 Hz	220-240 V~/50 Hz	220-240 V~/50 Hz	220-240 V~/50 Hz
Heating: Performance Condition: Outdoor air 7°C / 6°C, Inlet / Outlet water 30°C / 35°C				
Heating capacity (kW)	6.46(2.50~8.30)	10.58(4.20~12.20)	14.45(5.30~16.50)	18.77(6.20~20.50)
Rated Power Input (kW)	0.57-1.92	0.86-2.88	1.15-4.15	1.36-5.28
Input Current	2.53-8.52	3.82-12.77	5.10-18.41	6.10-23.67
Heating: Performance Condition: Outdoor air 7°C / 6°C, Inlet / Outlet water 47°C / 55°C				
Heating capacity (kW)	2.30-7.62	3.85-11.20	4.90-15.10	6.30-19.90
Rated Power Input (kW)	0.75-2.61	1.13-3.75	1.65-5.25	1.65-6.82
Input Current	3.32-11.58	5.01-16.6	7.32-23.30	7.40-30.56
Cooling: Performance Condition: Outdoor air 35°C / 24°C, Inlet / Outlet water 12°C / 7°C				
Cooling capacity (kW)	1.80-7.10	2.60-10.30	4.50-13.50	5.50-17.50
Rated Power Input (kW)	0.61-2.43	0.91-3.65	1.45-4.85	1.65-6.25
Input Current	2.71-10.78	4.03-16.19	6.43-21.52	7.40-28.02
General data				
ERP Level (Outlet water temp. at 35°C)/SCOP	A+++/4.92	A+++/4.55	A+++/4.58	A+++/4.61
ERP Level (Outlet water temp. at 55°C)/SCOP	A++/3.37	A++/3.41	A++/3.39	A++/3.41
Rated Input Power(kW)	2.71	3.83	6.20	7.24
Rated Input Current(A)	12.00	17	27.50	35.50
Refrigerant/Weight	R32/1.25kg	R32/1.8kg	R32/2.8kg	R32/3.5kg
Rated Water Flow(m ³ /h)	1.1	1.75	2.52	3.2
Fan Motor Type	DC inverter			
Compressor	Panasonic/DC Inverter/Rotary/EVI			
Circulation Pump	Inverter Type/Built-in			
IP Class	IPX4			
Noise Level(dB(A))	50	51	55	56
Max Outlet Water Temperature(°C)	60	60	60	60
Water Piping Connections	DN 25 (1")	DN 25 (1")	DN 32 (1-1/4")	DN 40 (1.5")
Pressure Drop at Rating Water Flow(kPa)	25	27	30	30
Operating Temperature Range (Heating Mode) (°C)	-25~45			
Operating Temperature Range (Cooling Mode) (°C)	16~45			
Net Dimensions (L*D*H)(mm)	1100*445*850	1110*445*850	1110*480*850	1110*480*1450
Net Weight (kg)	102	109	125	151

Model	BLN-010 TB3	BLN-014 TB3	BLN-018 TB3	BLN-024 TB3
Power supply	380~415 V/3/50 Hz	380~415 V/3/50 Hz	380~415 V/3/50 Hz	380~415 V/3/50 Hz
Heating: Performance Condition: Outdoor air 7°C / 6°C, Inlet / Outlet water 30°C / 35°C				
Heating capacity (kW)	10.58(4.20~12.20)	14.45(5.30~16.50)	18.77(6.20~20.50)	24.33(6.50~26.10)
Rated Power Input (kW)	0.86-2.88	1.15-4.15	1.36-5.28	1.78-6.45
Input Current	1.22-4.09	1.63-5.90	2.31-8.96	2.87-10.35
Heating: Performance Condition: Outdoor air 7°C / 6°C, Inlet / Outlet water 47°C / 55°C				
Heating capacity (kW)	3.85-11.20	4.90-15.10	6.30-19.90	6.90-26.10
Rated Power Input (kW)	1.13-3.75	1.65-5.25	1.65-6.82	1.95-8.55
Input Current	1.61-5.32	2.35-7.47	2.80-11.58	3.15-13.80
Cooling: Performance Condition: Outdoor air 35°C / 24°C, Inlet / Outlet water 12°C / 7°C				
Cooling capacity (kW)	2.60-10.30	4.50-13.50	5.50-17.50	5.20-20.30
Rated Power Input (kW)	0.91-3.65	1.45-4.85	1.65-6.25	1.95-8.20
Input Current	1.29-5.19	2.06-6.89	2.8-10.61	3.15-13.23
General data				
ERP Level (Outlet water temp. at 35°C)	A+++/4.55	A+++/4.58	A+++/4.64	A+++/4.58
ERP Level (Outlet water temp. at 55°C)	A++/3.41	A++/3.39	A++/3.42	A++/3.42
Rated Input Power(kW)	3.83	5.97	7.24	9.38
Rated Input Current(A)	6.5	10.50	13.20	17.30
Refrigerant/Weight	R32/1.8kg	R32/2.8kg	R32/3.5kg	R32/3.5kg
Rated Water Flow(m³/h)	1.75	2.52	3.2	4.12
Fan Motor Type	DC inverter			
Compressor	Panasonic/DC Inverter/Rotary/EVI			
Circulation Pump	Inverter Type/Built-in			
IP Class	IPX4			
Sound Pressure at 1m Distance(dB(A))	51	52	54	58
Max Outlet Water Temperature(°C)	60	60	60	60
Water Piping Connections	DN 25 (1")	DN 32 (1-1/4")	DN 40 (1.5")	DN 40 (1.5")
Pressure Drop at Rating Water Flow(kPa)	27	30	32	32
Operating Temperature Range (Heating Mode) (°C)	-30~45			
Operating Temperature Range (Cooling Mode) (°C)	16~45			
Net Dimensions (L*D*H)(mm)	1100*445*850	1110*475*850	1110*445*1450	1110*445*1450
Net Weight (kg)	102	124	151	160

Note: We reserve the right to discontinue or change at any time, specifications or designs without notices and without incurring obligations.

After-sale Service

Relevant state regulations carry out the after-sales service of our products. Within the scope of the warranty period, if the machine is not working correctly under reasonable use, please contact the seller. The user must designate a person to manage and use the unit reasonably and correctly by our company's "Instructions for Use." Accidents caused by improper use are not covered by our company's warranty, and the repair costs and repair costs beyond the warranty period must be taken care of by the user.

1. After-sale Service

The seller or the specified professional installer should perform maintenance and repair. Improper maintenance or repair may result in water leakage, electric shock, and fire.

- 1.1 Please contact the seller when the machine has to be moved or reinstalled. Improper installation may result in water leakage, electric shock, and fire.
- 1.2 When you need after-sales service, please contact the seller and provide the following details:
 - 1) Model No.
 - 2) Serial Number and Manufacture Date
 - 3) Detailed Description of the fault
 - 4) Your name, Address, and Contact Number

If the warranty period is expired or the malfunction is caused by improper use, the company will charge a certain service fee if you need after-sales service.

2. Maintenance

















After a period of use, the heat pump's performance will be reduced due to the accumulation of dust inside the machine, so maintenance is required.

- 1) You should regularly check the water supply system to avoid the air entering the water system and the occurrence of low water flow, which would reduce the performance and reliability of the heat pump.
- 2) Clean your filtration system regularly to avoid unit damage because of a dirty or clogged filter.
- 3) Discharge the water from the bottom of the water pump if the heat pump will stop running for a long time (especially in winter)
- 4) At any other moment, check the water flow to confirm enough water before the unit starts to run again.
- 5) After the unit is conditioned in winter, it is preferred to cover the team with a unique winter heat pump cover.





Controller Supplement



1. Controller Icon

Icon	Status	Functions or meanings	Remark
	Lights out	Currently in off or non-hot water mode	Display on/off status
	Constant flashing	Currently in hot water mode on	Display on/off status
	Lights out	Currently in off or non-heating mode	Display on/off status
	Constant flashing	Currently in heating mode	Display on/off status
	Lights out	Currently in off or non-cooling mode	Display on/off status
	Constant flashing	Currently in cooling mode	Display on/off status
	Lights out	Currently in off or non-floor heating mode	Display on/off status
	Constant flashing	Currently in floor heating mode	Display on/off status
	Constant flashing	Silent mode / Night mode	Power on display
	Constant flashing	Powerful mode	Power on display
	Constant flashing	Intelligent Mode	Power on display
	Constant flashing	Electric auxiliary heating work (AC, hot water electric heating)	Power on display
	1s flashing	Electric auxiliary heat quick heat mode is enabled	Power on display
	2s flashing	Electric auxiliary heat sterilization mode is enabled	Power on display
	Flashing	WiFi Allocation	
	Constant flashing	WiFi connection successful	
IN	Constant flashing	Represents water intake	
OUT	Constant flashing	Represents water discharge	
RT	Constant flashing	Represents actual temperature/room temperature	
SET	Constant flashing	Representative Settings	
°C	Constant flashing	Display Celsius temperature	
°F	Constant flashing	Display Fahrenheit temperature	
%	Constant flashing	Show percentage	
88.8	Constant flashing	Display of actual values, set values and fault codes	
	Flashing	Circulating water pump: freeze-proof operation	
	Constant flashing	Circulating water pump: normal operation	
	Constant flashing	Hydration valve open	
	Constant flashing	Return water valve open	
	1Hz flashing	Activate timed water return feature	
	2Hz flashing	Activate manual water return function	

	Constant flashing	High, medium and low water levels are displayed	
	Constant flashing	The water supply valve	
	Constant flashing	Photovoltaic mode/solar heating	
	1 Hz flashing	Start PV timing	
	Flashing	Currently in shutdown and refrigerant recovery state	
	Constant flashing	Currently on and defrosting	
	Constant flashing	Enter maintenance status	
	Constant flashing	Alarm is currently occurring	
	Constant flashing	Current button is locked	
	Constant flashing	Compressor operation	
	Constant flashing	High wind operation of the fan	
	Constant flashing	Fan low wind operation	
	1 second flash	Ventilation mode: high speed wind	
	2 second flash	Ventilation mode: low speed wind	
	Constant flashing	Online networking	
	Constant flashing	Display the current network unit number	
88.8	Display	Display real-time time	
	Always bright	Enable timed work mode	
ON	Display	Currently in the power-on timer period	
ON	Flashing	Current set working period start time	
OFF	Display	Currently in power-on timed non-working hours	
OFF	Flashing	Current set working period end time	
123	Flashing / Light out	Timed working hours 1, 2, 3, always on when set or when the clock enters this period, off in the rest of the case	
W8	Display	Show current week 1, 2, 3, 4, 5, 6, 7	





2. Controller Manual

2.1 **On/off button** “” : when the power is off and unlocked, press and hold the key “” for 1S, the unit will start; when the power is on and unlocked, press and hold the “” key, the unit will stop running; if the line controller is in the "lock key If the line controller is in the locked state, press and hold the “” key for more than 3 seconds to release the lock.

2.2 **Mode key** “” : When the line controller is on and unlocked, press the “” key to select the operation mode of the unit (different modes can be selected according to different models: floor heating, cooling, heating, hot water etc.).

2.3 Temperature Setting

2.3.1 For Heating/Cooling/DHW

- 2.3.1.1 (When there is no curve setting) when the line controller is on and unlocked, press "△" or "▽" key, then press "△" or "▽" "△" or "▽" key to adjust the current mode set temperature; press and hold the "△" or "▽" key for more than 0.5 seconds to quickly increase or decrease, stop operation after 5S or press the on/off key to return to normal display; combination mode (for example: heating + Hot water), press the "M" key to switch the temperature setting of another mode, the icon of the corresponding mode flashes at 1Hz when the temperature is set.
- 2.3.1.2 (When there is curve setting) when the line controller is on and unlocked, press "△" or "▽" key to display the current set temperature curve, then the curve setting value flashes, then press "△" or "▽" key can switch different curve control, combination mode (for example: heating + hot water), press "M" key to switch the curve display and setting of another mode. After stopping the operation 5S or press the "⏸" key to return to normal display.
- 2.3.1.3 **Curve control setting:** Press "△" or "▽" to enter temperature setting in the state without curve setting, press "M" for 5S to enter curve setting, the display shows OFF to cancel curve control, press "△" or "▽" to select the corresponding curve control at this time: press "△" or "▽" to enter curve selection in the state with curve control, the curve control can be canceled by setting the curve to OFF.
- 2.3.1.4
- Refrigeration curve representation: CH1, 2, 3, 4, 5, 6, 7,8, represents the cooling high temperature curve 1, 2, 3, 4, 5, 6, 7,8
- Refrigeration curve representation: CL1, 2, 3, 4, 5, 6, 7,8, represents refrigeration low temperature curve 1, 2, 3, 4, 5, 6, 7,8,
- The heating curve is represented by: HH1, 2, 3, 4, 5, 6, 7,8, represents the heating high temperature curve 1, 2, 3, 4, 5, 6, 7,8,
- Heating curve: HL1, 2, 3, 4, 5, 6, 7,8, The heating curve represents the low temperature curve 1, 2, 3, 4, 5, 6, 7,8,
- Floor heating curve: GH1, 2, 3, 4, 5, 6, 7,8, The floor heating curve represents the high temperature curve 1, 2, 3, 4, 5, 6, 7,8,
- Floor heating curve: GL1, 2, 3, 4, 5, 6, 7,8, representing the floor heating low temperature curve 1, 2, 3, 4, 5, 6, 7,8,
- Hot water curve: H1, 2, 3, 4, 5, 6, 7,8, on behalf of the hot water curve 1, 2, 3, 4, 5, 6, 7,8.
- 2.4 **Quick heat function:** When the power is on, in non-cooling mode, press and hold "M" + "△" for 3s to enter/exit the quick heat function.
LCD display: when the electric heating is on, the  symbol lights up, when the electric heating is not on  1Hz blinks to show the execution of the switch operation to turn off the quick heat function.
- 2.5 **Forced defrost function:** In the power-on state, in non-cooling mode, long press "M" + "▽" for 5s to enter the forced frosting. LCD display: the frosting icon  lights up.
- 2.6 **IPLV test mode:**
 For experimental test of inverter:
 At power on, press and hold "On/Off" + "Timer" + "M" for 5s to enter; press "⏸" to exit.
 LCD display: IPLU is displayed in the timing area.
- 2.7 **Refrigerant recovery function:**
 In the off state, within 5min of power on, long press "M" + "▽" for 10s to enter the refrigerant recovery; press the "⏸" key to exit.
 LCD display: frosting icon  1Hz flashing.
 Inverter two-tier and three-tier temperature zone flashing to show the low pressure temperature value.
- 2.8 **Water line evacuation mode/forced on pump:**
 In the off state, long press "⏸" + "△" + "▽" for 5s to enter; press again or directly press "⏸"

key to exit.

LCD display: pump icon "  " flashing

2.9 Operation parameters query:

2.9.1 Enter to view: long press "▽" 3S under the regular interface to enter the operating parameters query, enter the parameter query state, the temperature display area shows the parameter serial number, the timing area shows the parameter content. Forced operation parameters table differs according to the model, refer to the attached table or motherboard function manual.

3.9.2 Check operation and exit: After entering parameter query, press "△" or "▽" key to scroll through the "operating parameters"; press "⏸" key or 60 seconds without key operation automatically exit to view the status of parameters.

2.10 Parameter Setting

2.10.1 When the main interface is displayed, press and hold "M" for 5S to enter the parameter query, in the query state, the parameter serial number flashes; press "M" to enter the parameter setting state, the parameter value starts to flash, at this time, press "△" or "▽" key to modify the parameters, press "M" to determine the value of the parameter modification. Press the "⏸" key or 60 seconds without key operation to exit the parameter state automatically, without saving the modified parameter value.

2.10.2 There are two levels of parameters that can be set for two or three inverters, press and hold "M" for 5S to switch the parameter query.

2.10.3 Parameter table varies depending on the model, refer to the attached table or motherboard function manual

2.11 Display faults:

2.11.1 When there is a fault in the unit, the fault is displayed in the timing area and the fault code is displayed cyclically while "⚠" flashes, and the normal display is restored when the fault is eliminated. The description of the fault code is shown in "Trouble Analysis".

2.12 Clock Settings:

2.12.1 Enter the clock setting: the line controller unlocked state, press the "⌚" key, the clock area flashing display, such as the start of the week function "  " will flash together, indicating that enter the clock setting state;

2.12.2 Clock setting operation: Enter the clock setting state, press the "⌚" key to switch to set the week, hour and minute settings, the set value flashes at this time, press the "△" or "▽" key to modify the corresponding value, after setting After setting the minute value, press the "Timer" key or "⏸" key again or 5 seconds without key operation to save the current setting and exit automatically.

In the clock setting state, press and hold the "⌚" key for 3 seconds to turn on/off the weekly function; when the weekly timer is enabled, enter the clock setting first, then press the "⌚" key to enter the hour setting after setting, and skip the weekly setting directly when the weekly function is turned off.

2.13 Set on/off timer control

2.13.1 Timer control has 3 groups of timer, 1~3 groups, each group can be set as "timer start" and "timer stop"; default is "invalid" state, i.e. the timer start and timer stop are the same time.

2.13.2 To access the timing settings:

2.13.2.1: Long press the "⌚" key for 3 seconds under the main interface to enable or disable the timer working mode.

2.13.2.2: When the day starts timing, all timing of the day is cancelled; when the day does not start stopping, the timing setting is entered.

2.13.2.3: When the week function is activated, after entering the timing setting, first enter the week selection, then "  "flash, press the "△" or "▽" key to select the week that needs to set the timing, and then proceed to the next operation. Skip this step when week function not start.

2.13.2.4 Short press the "🕒" key, "1", "ON" icon at the bottom left of the screen, the hour display area flashes, it means enter the "first group of timing Start" setting state, digital flashing at hour, press "△" or "▽" key to modify the time, then press "Timer" key to confirm the modification and go to the minute Setting, digital flashing at the minute, press "△" or "▽" to modify the time, then press "Timer" to confirm the modification; at the same time, enter "1", "OFF" icon display, setting status, digital flashing display at hour, press "△" or "▽" key to modify the time, and then press "Timer" key to confirm the modification and go to the minute setting, digital flashing display at the minute, then press "△" or "▽" key to modify the time, then press "🕒" key to confirm the modification and start "Timing of time slot 1", and enter the setting of time period 2.

2.13.2.5 The operation of "Time slot 2 and 3" settings is the same as above.

2.13.3 **Exit setting timing:** When the timer is set, press the "🕒" key or no key operation for 60 seconds to abandon the current timer and exit the set timer.

2.13.4 When the weekly timer is enabled, set the weekly timer at the current time and press and hold the "🕒" key for 3 seconds to cancel the timer for the day.

2.13.5 **Timed display:** After setting the timing, the clock immediately updates the current state, executes power on during the power-on time period, executes power off outside the timing time period, and then executes once at the time. The "🕒" and "OFF" icons are displayed when it is in the shutdown period, and the "🕒" and the current working period "1/2/3" and "ON" are displayed when it is in the power-on period.

2.14 ECO Mode Setting

For TB series models, long press "△" or "▽" key in the main interface 3S to turn on/off ECO function, "🌞" lights up when it is on.

2.15 Timed return water temperature setting

Long press "🕒" key + "▽" key under the main interface for 3 seconds, you can enable or cancel the timer back to the water function mode, enable the timer back to the water function mode into the timer back to the water time settings, then "🚿" and "🕒" characters flashing at the same time, set the same method and set the switch timing

A total of three timer back to the water period can be set.

2.16 Set timer refill function and (valid for commercial hot water models)

Long press "🕒" key + "△" key for 3 seconds under the main interface, you can enable or cancel the timer refill function mode, enable the timer refill function mode into the timer refill time settings, at this time "🚿" and "🕒" characters flashing at the same time, set the same method and set the switch timing.

A total of two timer back to the water period can be set

2.17 Maintenance Mode

Press and hold the "▽" key for more than 3 seconds to enter the maintenance mode, at this time the maintenance symbol "🔧" is lit up and displayed. In this mode, you can check the information, controller self-test and other operations, press and immediately release the "🕒" key or no key operation within 60 seconds will automatically return to the normal display state.

After entering the maintenance mode, the last viewed data code and its corresponding value are displayed, and thereafter each time the "▽" key is pressed and immediately released or "△" key can be displayed in sequence as shown in the attached table.

Maintenance mode, press and release the "📄" key can display the main control board product information (temperature display area shows "r10" on behalf of the motherboard software version V1.1), the clock display area shows: "SBP2 "SBP2" represents the commercial inverter two-unit supply, "SBP3" represents the commercial inverter three-unit supply, "JdP" represents the home fixed-frequency machine, "SdP" represents commercial fixed-frequency machine; after pressing and releasing the "🕒" key can display the product information of the line controller ("d10" represents software version V1.1), and return to the data display after 3 seconds.

Enter maintenance mode in the off state.

Press and hold the "⏸" key for more than 5 seconds to restore the factory settings and exit.
Press and hold the "⏸" key for more than 5 seconds to display self-test, all the display fields in turn after the end of the display self-test; display self-test after the end of the clock chip and memory chip, WIFI module detection. The left side of the temperature display area shows the detection result of the clock chip, the successful detection shows "OK", the failure shows "--", the right side shows the detection result of the memory chip, the successful detection shows "OK", failure display "--". Clock area shows WIFI detection results, successful detection shows the current WIFI signal strength, failure shows "----", 3S after the end of the self-test

Press and hold the "M" key for more than 5 seconds for output self-test, the relays of the control board are sucked and disconnected in turn, then end the output self-test.

Press and hold the "△" key for more than 5 seconds to enter or exit the refrigerant charging or recovery mode, the "frost" character flashes in this mode, while the compressor, four-way valve, evaporator fan high speed, circulation pump and bypass valve are working, press any key or 20 minutes to exit automatically. After pressing any key or 20 minutes, it will exit automatically.

Note that the output self-test function is only for the quick test of the product, and it is strictly forbidden to use this function when it is under load. In order to avoid damage to the unit by misoperation, the factory setting cannot be restored after the controller is powered on for 5 minutes, and the output self-test and refrigerant charging or recovery mode cannot be entered.

In maintenance mode, press and hold the "⏸"+"⏸"+"△"+"▽" key for 5 seconds to enter the model parameter setting Work-installation mode, which is shown on the right.

In the work mode, press and hold the "⏸"+"⏸"+"△"+"▽" key for 5 seconds, then exit the work mode and carry out normal work display.

Work mode, power on and after the initialization is complete, the display board cycle 1 second to send a setting command, and according to the motherboard to reply the results of success or failure instructions. Among them, when the setting is successful, "JC" and "0" are always displayed; when the setting fails, "JC" is always displayed and "0" flashes.

In the tooling mode, the model number "0" can be adjusted by "△" key and "▽" key, and in the process of model adjustment, "JC" and "0" are both flashing, you can confirm the setting by " " key

2.18 Online fast detection mode (valid for commercial machines with fixed frequency)

Power on and within 5 minutes, press and hold the "⏸"+"M"+"▽" keys simultaneously for more than 5 seconds to enable the fast detection mode, which optimizes the press start-up delay, as follows :

- (1) The time to keep the electronic expansion valve initialized for 60 seconds before the press starts is shortened to 3 seconds.
- (2) The default 90-second time for the circulating water pump to start the press in advance is shortened to 15 seconds.
- (3) The electronic expansion valve opens up to 480 steps after the press stops and maintains a 2-minute delay time cancellation.

In the fast detection mode, press and hold "⏸"+"M"+"▽" at the same time for more than 5 seconds, then the fast detection mode is cancelled and normal control is restored. Power off and power on again, then normal control is automatically restored.

2.19 Usage period password setting

In the unlocked state while holding down 5 keys 5S until "beep" into the use of the term password input, then the temperature zone display password "0000", you can press "△" or "▽" key to enter the password, and then press "M" to switch to the next password input, enter the 4-bit password and press "M" key to confirm, the password is correct to enter the term settings, then the clock area is displayed before the set value, press "△" or "▽" key to adjust, and then press "M" to confirm, return to the main interface, press and immediately release the "⏸" key or no key operation within 60 seconds will automatically return to the normal display state, does not save

the set value.

2.20 Photovoltaic timing (valid for home machines)

Under the main interface long press the "⏸" "+" "⌚" "+" "M" key for 3 seconds to enter the PV timing settings, press and immediately release "⌚" key can switch the hour part, minute part, hour part and minute part of the end time of the two time periods in turn, flashing display when switching to the corresponding value, while displaying the corresponding time period and flashing display "ON" or "OFF" symbol, press "△" or "▽" can be adjusted up or down and flashing display the corresponding value. After setting the timing period, press and release the "⏸" key immediately or no key operation within 15 seconds can save the modification and return to normal display status.

2.21 Networking Features

Network function display: when there is a slave access to the host, the host line controller display "👤" indicates that the device uses multiple devices networking function. Due to the display area limitation, the number shown in "1234
5678" during the operation of the equipment indicates that the N (1~8) slave accesses the network connected to the host, and the actual network can be grouped 16 units (1 master, 15 slaves).

How to query the operating parameters of master and slave machines under the network function: long press "△" for 5 seconds to enter the query of master and slave machine parameters, the symbol "👤" indicates the master and slave machine number (0 is the master, 1, 2, 3, 4, 5, 6, 7, 8, 9, A, B, C, D, E F represents the slave code), switch the number of the group being checked by tapping "⌚" key. After entering a host or slave, tap "△", "▽" to scroll through the lines to display each "operation parameter"; press "On/Off" key or no key operation for 60 seconds to exit automatically to view the parameter status.

3. Temperature Compensation Curve

Heating High Water Temperature
Climate Temperature Compensation Curve HH1-HH8

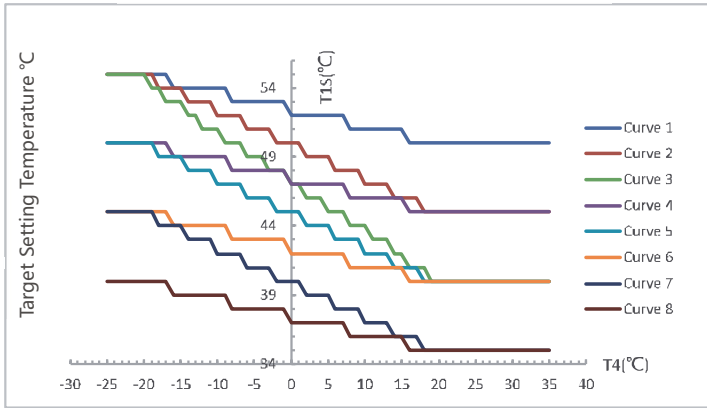

Ambient Temperature °C

Heating Low Water Temperature
Climate Temperature Compensation Curve CH1-CH8

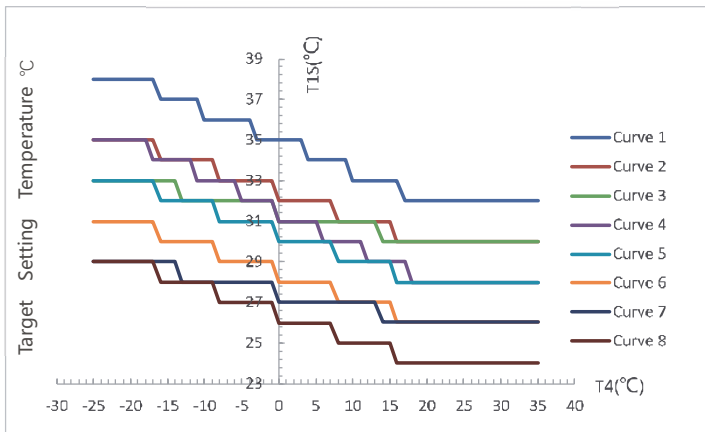

Ambient Temperature °C

Cooling High Water Temperature
Climate Temperature Compensation Curve CH1-CH8

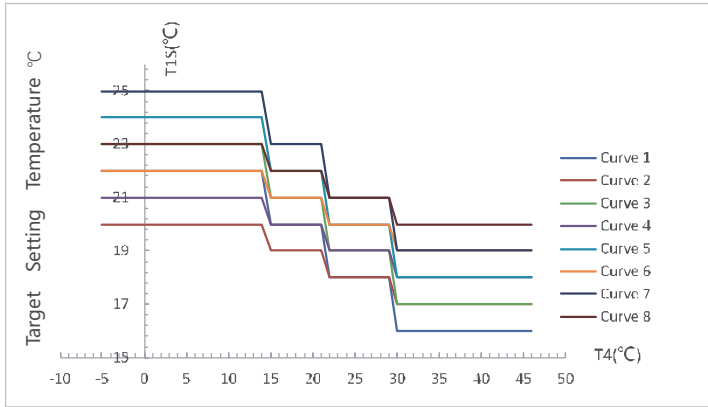

Ambient Temperature °C

Cooling Low Water Temperature
Climate Temperature Compensation Curve CL1-CL8

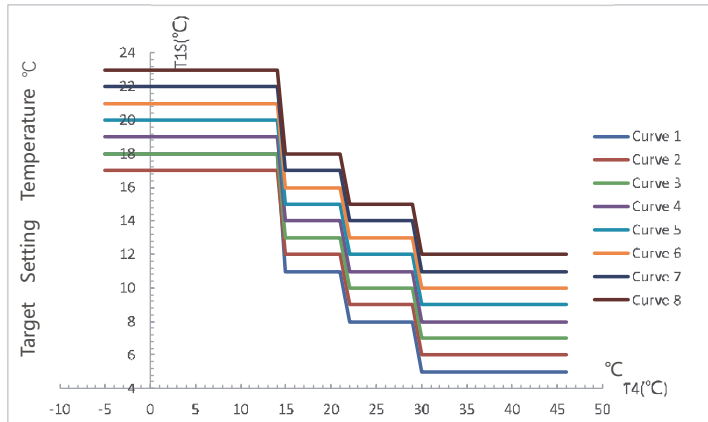

Ambient Temperature °C

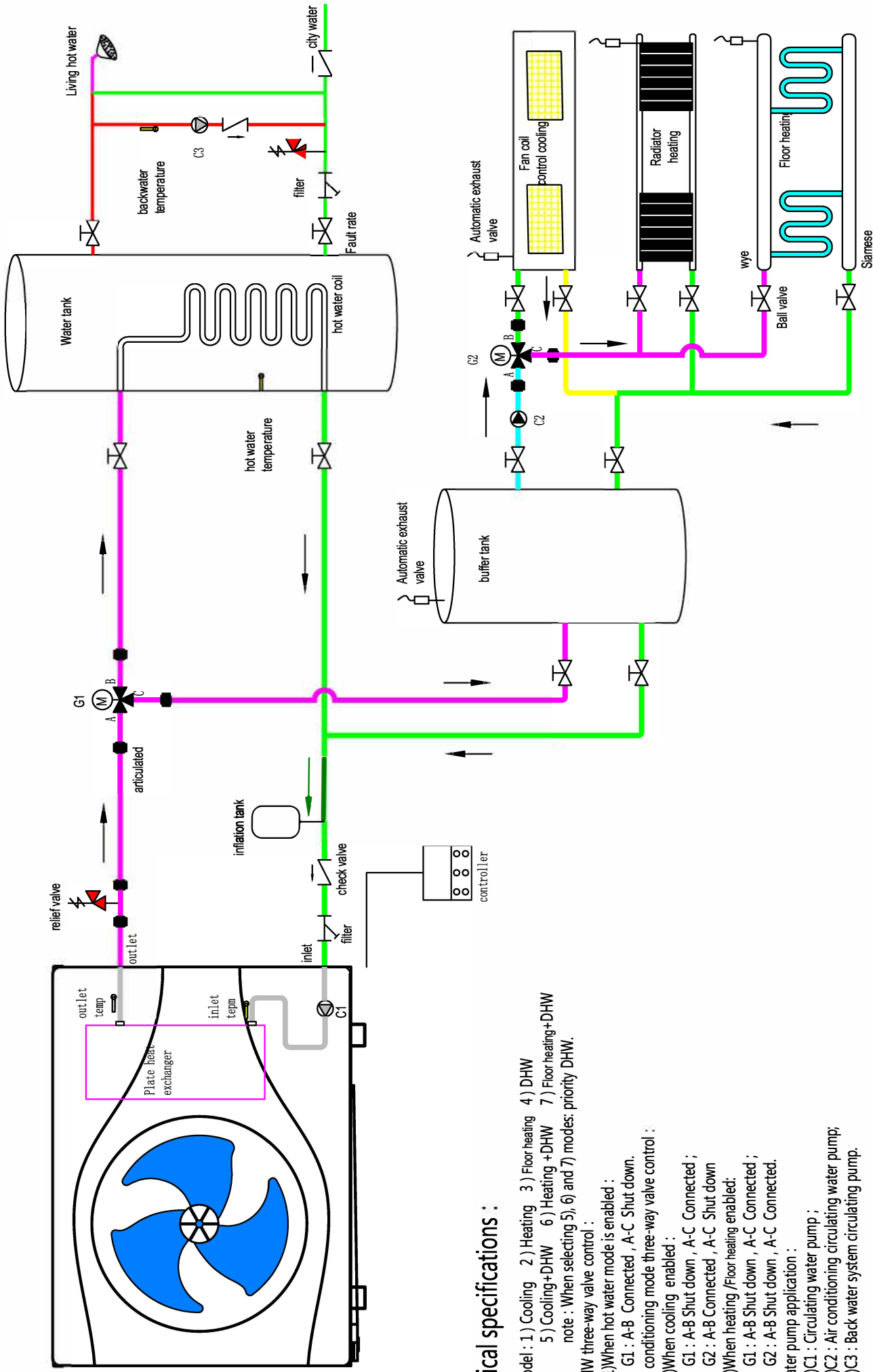

Technical specifications :

1. Model : 1) Cooling 2) Heating 3) Floor heating 4) DHW
 5) Cooling+DHW 6) Heating +DHW 7) Floor heating+DHW
 note : When selecting 5), 6) and 7) modes: priority DHW.
2. DHW three-way valve control :
 1) When hot water mode is enabled :
 G1 : A-B Connected , A-C Shut down.
3. Air conditioning mode three-way valve control :
 1) When cooling enabled :
 G1 : A-B Shut down , A-C Connected ;
 G2 : A-B Connected , A-C Shut down
 2) When heating /Floor heating enabled:
 G1 : A-B Shut down , A-C Connected ;
 G2 : A-B Shut down , A-C Connected.
4. Water pump application :
 1) C1 : Circulating water pump ;
 2) C2 : Air conditioning circulating water pump ;
 3) C3 : Back water system circulating pump.