

komfovent®



RHP Standard units

EN Installation and Operation Manual

Content

1. TRANSPORTATION	3
2. BRIEF DESCRIPTION OF THE UNIT	4
3. INSTALLATION	8
3.1. Maintenance space requirements	8
4. MAINTENANCE	10
5. TECHNICAL INFORMATION	14
6. ELECTRICAL INSTALLATION MANUAL	17
6.1. Air Handling Units Sections Connection.....	17
6.2. Electric Power Supply Connection	17
6.3. External Elements Connection.....	18
6.4. Temperature Sensors Installation.....	19
6.5. Requirements for the installation of the control panel.....	19
6.6. Control panel connection	19
7. OPERATION MANUAL	20
7.1. Unit Control	20
7.2. Control panel indication.....	20
7.3. Parameters overview	21
7.4. Operation modes selection	21
7.5. Menu.....	21
7.5.1. Overview.....	22
7.5.1.1. Alarms.....	22
7.5.1.2. Operation counters	22
7.5.1.3. Efficiency status.....	22
7.5.1.4. Detailed information.....	22
7.5.2. Functions	22
7.5.2.1. Air quality control	23
7.5.2.2. Operation on demand	23
7.5.2.3. Outdoor compensated ventilation	23
7.5.2.4. Summer night cooling	24
7.5.2.5. Minimum temperature control	24
7.5.2.6. Override function	24
7.5.2.7. Humidity control	25
7.5.3. Scheduling	25
7.5.3.1. Operation program	26
7.5.4. Settings.....	26
7.5.4.1. Air handling unit settings	26
7.5.4.2. Holidays.....	26
7.5.4.2. Personalization	27
7.6. Control of air handling units through a web browser.....	27
7.7. Additional control options	28
7.7.1. Combined water coil control	28
7.7.2. Inverter direct evaporation cooler control	28
7.7.3. Multi-level control of direct evaporation cooler	28
7.7.4. Reversal of direct evaporation coolers	29
7.8. Troubleshooting.....	29



This symbol indicates that this product is not to be disposed of with your household waste, according to the WEEE Directive (2002/96/EC) and your national law. This product should be handed over to a designated collection point, or to an authorised collection site for recycling waste electrical and electronic equipment (EEE). Improper handling of this type of waste could have a possible negative impact on the environment and human health due to potentially hazardous substances that are generally associated with EEE. At the same time, your cooperation in the correct disposal of this product will contribute to the effective usage of natural resources. For more information about where you can drop off your waste equipment for recycling, please contact your local city office, waste authority, approved WEEE scheme or your household waste disposal service.

1. TRANSPORTATION

The air handling units are ready for transit and storage (1 Picture). The unit is packed to prevent damage of the external and internal parts of the unit, dust and moisture penetration.

Corners of the air handling units are protected against the damage – protective corners are used. The entire unit is wrapped up in protective film. For transit or storage, units are mounted on timber pallets. The unit is fastened to the pallet with polypropylene packing tape over protective corners

Vertical and horizontal units ready for transit and storage

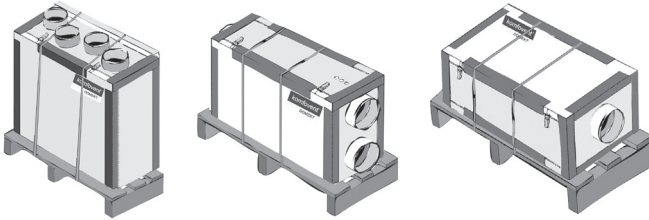

1 Picture

When unit is loaded or unloaded by crane, cargo rope is fastened in its designated places. RHP units can not be carried, slanted more than 15° (measuring by unit mounting position). If in transportation phase unit was slanted more than 15°, heat pump can't be started in a 2 hours.

Forklift truck or hand pallet truck can transport air handling unit as it is shown (1 a, b, c Pictures).

Vertical and horizontal unit transportation by forklift truck, hand pallet truck or crane

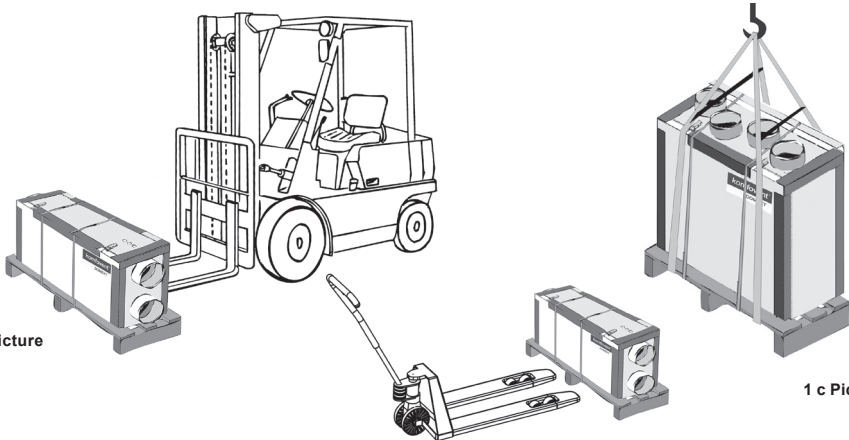

1 a Picture

- 1 a Unit is transported by forklift truck on a wooden pallet;
- 1 b Unit is transported by hand pallet truck on a wooden pallet;
- 1 c Unit is lifted by crane on a wooden pallet.

1 b Picture

1 c Picture

The unit should be examined upon receipt, to ensure that no visible damage has occurred during transit, and the advice note checked to ensure that all items have been received. If damage or delivery shortages are discovered, the carrier should be immediately informed. KOMFOVENT should be notified within three days of receipt, with a written confirmation sent within seven days. KOMFOVENT can accept no responsibility for damage by unloading from carrier or for subsequent damage on site.

If the unit is not to be installed immediately, it should be stored in a clean, dry area. If stored externally, it should be adequately protected from the weather.

2. BRIEF DESCRIPTION OF THE UNIT

- Casings of air handling units are made of galvanized steel sheets, which are powder painted. Mineral wool is used for thermal insulation and sound attenuation. Unit cover panels are 45 mm thick.
- The air handling units are intended for ventilation of medium-sized spaces (eg. single family houses, offices, etc.), having operating ambient temperature and relative humidity. As standard, the unit is designed for indoor placement. The operating temperature range for the unit is -30 °C ... 40 °C, outdoor air temperature. Heat pump operation limits are from -20 °C to +40 °C. For reliable air handling unit operation is recommended to use air handling unit in the room with temperature between 18-28 °C.
- The air handling unit is not to be used to transport solid particles, even not in areas where there is a risk of explosive gases.
- RHP units is equipped with a rotary heat exchanger, air filters, an electric or water heater, fans and automation control system, to ensure safe and efficient operation of the unit.
- Before you open the door, the unit must be switched off and the fans must have been given time to stop (up to 3 minutes).
- The unit contains heating elements that must not be touched when they are hot.
- We recommend to leave air handling unit in working mode (minimum 20 percent of power) during the first operation year. Due to moisture in building constructions, condensation may occur inside and outside the air handling unit. Continuous operation of the equipment will significantly reduce the risk of condensation.
- To maintain a good indoor climate, comply with regulations and, to avoid condensation damage, the unit must never be stopped apart from during service/maintenance or in connection with an accident.
- If the unit is placed in spaces with high humidity, condensation might occur on the surface of the unit when outdoor temperatures are very low.
- Under conditions, when the outdoor air temperature is low and humidity is high, risk of heat exchanger frosting may appear. For this reason anti-frost protection function is foreseen in the controller of the Komfovent air handling units. Depending on the type of the recovery, different methods of anti-frost protection are available: cold air by-passing, or / and supply air fan speed reducing. For extremely low outdoor air temperature the duct mounted preheater is recommended. The lowest risk and the highest resistance to cold outside air is a competitive feature of the rotary heat exchanger, as it is not freezing even at the temperatures of -30 °C if the humidity level of the air is appropriate.
- If one or both air flow(s) are lower than meaning in table 1, heat pump will be switch off and information icon will be displayed on control panel.
- When device controlling mode is set by supply air temperature, at that moment when supply air temperature is same as setpoint or exceed it, heat pump may be turned off (heat pump kept turned off for minimum 6 minutes). Maximum stopping number is five times per hour. Therefore it is recommended, set the device controlling mode under the indoor temperature (duct or room) for stable operation of the device.
- In heating mode supply air temperature can range due to frozen evaporator. Therefore, this unit is not recommended for use as a basic unit for heating. Unit has integrated supply air second electric heater.
- When heating mode is changed to cooling mode (or contrary) heat pump is turned off. After stopping heat pump cooling/heating function will start after 6 min.

Table 1

Unit size	Min air flow when compressor switched off [m ³ /h]
RHP 400 U-2.2/1.4	150
RHP 400 U-2.8/2.4	250
RHP 600 U-3.7/3	250
RHP 600 U-4.4/3.8	400
RHP 800 U-5.3/4.7	400
RHP 800 U-6.1/5.8	600
RHP 1300 U-8.1/6.6	600
RHP 1300 U-9.2/7.6	800
RHP 1500 U-9.6/7.8	800

Air Handling Units Schemes

RHP 600 UH

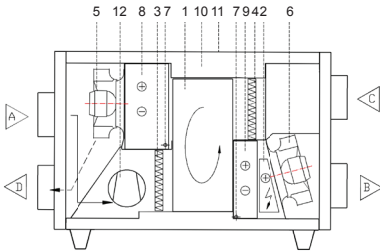

RHP 800/1300-1500 UH

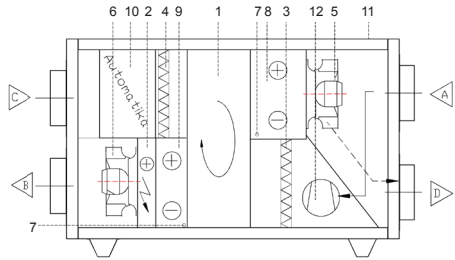

RHP 600 UV

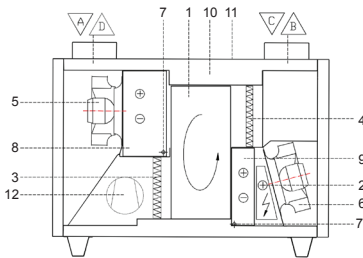



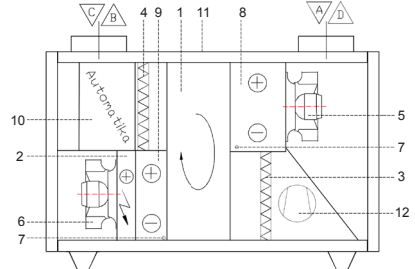

RHP 800/1300-1500 UV



1. Rotary heat exchanger
2. Electric air heater
3. Supply air filter
4. Exhaust air filter
5. Supply fan
6. Exhaust fan
7. Condensate drain
8. Extract air heat exchanger
9. Extract air heat exchanger
10. Automatic control
11. Connection of main cable
12. Heat pump

* R – right inspection side.

* L – left inspection side is mirror view of the right.

-  Outdoor intake
-  Supply air
-  Extract indoor
-  Exhaust air

RHP 400 V

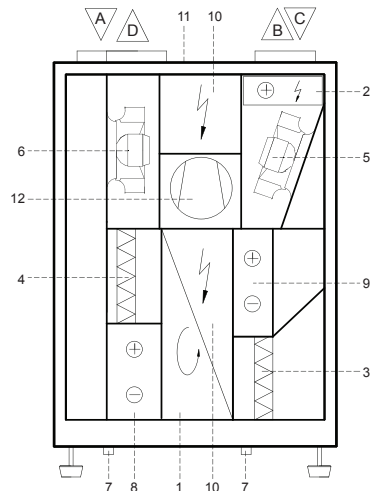

Heat pump

Air handling units are with integrated heat pumps for cooling and heating operations.

- Inside the unit is refrigerant R134A.
- Max operation pressure 18 bar.
- High pressure cut out – 18 bar, cut in – 13 bar (automatic reset). Low pressure cut out 0.7 bar, cut in - 1.7 bar (automatic reset).
- If one or both air flows are bellow switch off limit (as stated in the data sheet) heat pump will be switched off and indication icon will be displayed on control panel screen (see page 20).
- Maximum outside temperature for heating is 15 °C and minimum outside air temperature for cooling is 20 °C. If outside air temperature exceed this limits heat pump will be switched off and indication icon will be displayed on control panel screen (see page 20).
- Before commissioning, make sure that the air handling unit is filled with refrigerant. This can be done by looking through the moisture indicator.
- The unit is equipped with moisture indicator. At high moisture content of the system, it must be cleaned, changed the filter and re-filled with refrigerant..
- The unit washing, cleaning, maintenance is carried out as well as any other type of device described in this manual.
- Device information sticker of the used refrigerants is applied near to the high-and low-pressure filling valve. Sticker is seen when doors are opened.
- Extract air heat exchanger defrost, in heating mode, are carried out with hot gas by pass.

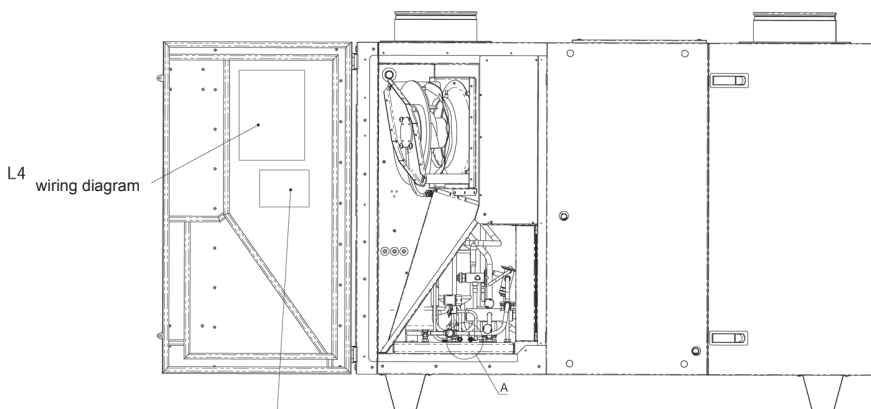

L1

komfovent

Air handling unit model / Vėdinimo įrenginio modelis	REGO 600L/RHP
Heat pump model / Šilumos siurblio modelis	HP-0280
Maximum operating pressure Maksimalus darbinis slėgis	P _{max} [bar] 18
Refrigerant / Šaltnešis	R134A
Number of circuits / Kortelių skaičius	1
Quantity of refrigerant / Šaltnešio kiekis	m _{ref} [kg] 2,6

- Hermetically sealed system / Hermetiška sistema
- Contains fluorinated greenhouse gases covered by Kyoto Protocol
Sudėtyje yra Kyoto protokole nurodytų fluorintų šiltnamio efektą sukeliančių dujų
- DO NOT VENT INTO ATMOSPHERE / NEŠIŠIŠTI Į APLINKĄ
- R-134A Global Warming Potential (GWP)=1300
- R-134A globalinio šiltnamio efekto potencialas (GWP)=1300

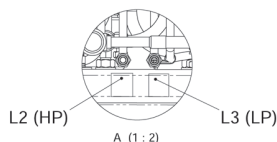

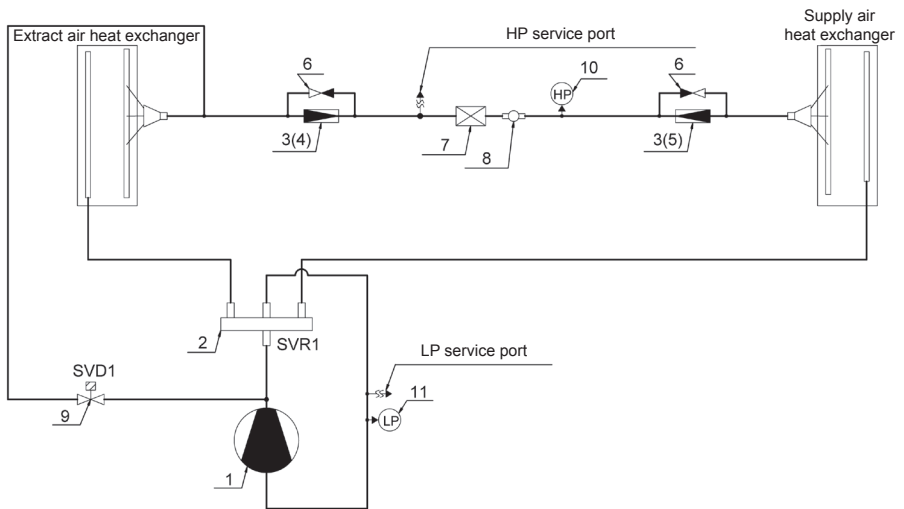

1. Compressor
2. Reversing valve
3. Expansion valve
4. Expansion valve orifice for heating mode
5. Expansion valve orifice for cooling mode
6. Check valve
7. Filter-dryer
8. Sight glass
9. Defrost valve
10. High pressure pressostat
11. Low pressure pressostat

Fig. 2. Heat pumps hydraulic diagram

Heat pump built-in air handling unit are controlled by air set point temperature. Heating or cooling function is activated automatically by set point and demand. Default temperature control order:

1. Rotary heat exchanger;
2. Heat pump;
3. Electric heater;
4. Additional cooler or heater (if installed).

HP operation at low outdoor air temperatures and high indoor humidity, potential evaporator freezing (in exhaust air flow). At the time on the heat exchanger forms white frost, snow, ice. To manage freezing defrost function are activated. Due defrost, supply air temperature decrease. Units are equipped with electric heater to heat up air in defrost mode or in low outside temperatures. Heat pump start may be limited due to low pressure or low outside air temperature information message shows up on display. If heat pump operation are limited, heating or cooling function carried out by secondary heater/cooler (if installed). Heat pump capacity depends from air flow. It's not recommended to use units with high air flows difference between supply and extract air. If there are more than 20 % difference between supply and extract air flows, heat pump efficiency and capacity decreases or heat pump may not work properly at all. For stable operation of the device, set the device controlling mode under the indoor temperature (duct or room).

3. INSTALLATION

3.1. Maintenance space requirements

It is recommended to install the air handling unit in a separate room or in the attic on a hard smooth surface insulated with a rubber mat. The place for the unit must be selected with allowance for minimum access to the unit for maintenance or service and must comply with safety requirements. Opening for inspection can not be smaller than dimensions of the unit and unit itself must be mounted in a way, that if needed (for example in case of complicated repair) it can be easily dismounted. The minimum free space in front of the control panel should be not less than 700 mm. The free space over the top of the unit should be at least 500 mm (3.1 a, b Picture).

Rubber mat must be used when unit is going to be mounted on the wall.

Minimum Maintenance Space for Horizontal Units

Minimum Maintenance Space for Vertical Units

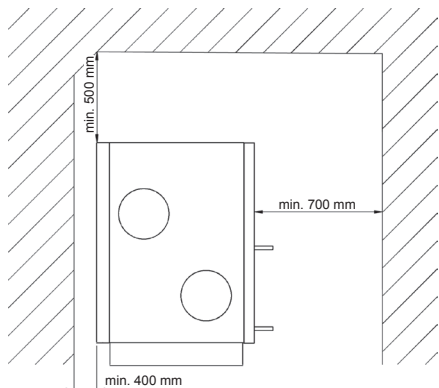

3.1 a Picture

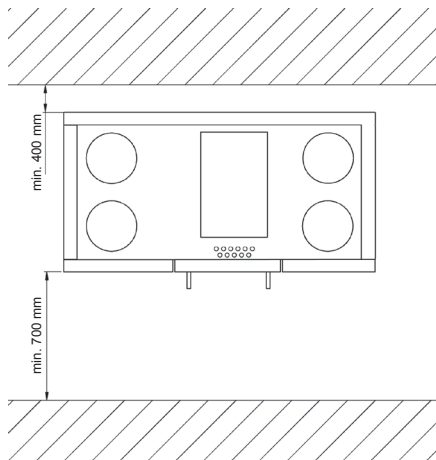

3.1 b Picture

RHP unit Installation Scheme

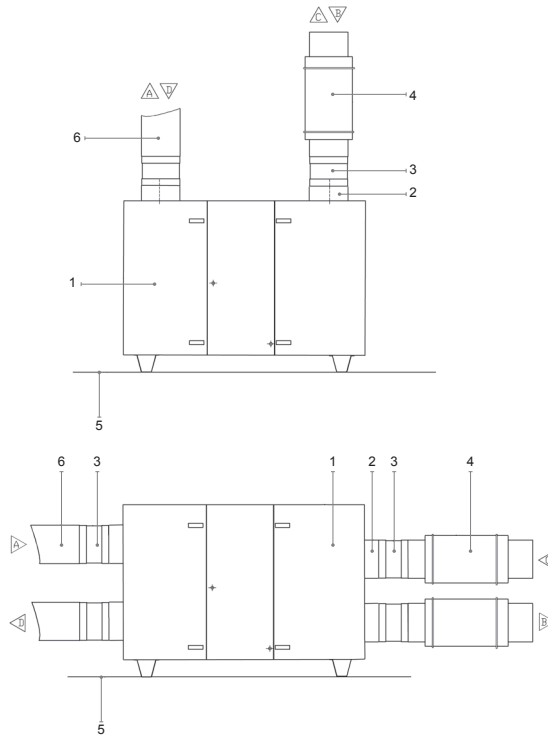

1. Air handling unit
2. Connection with ducts
3. Flexible joint
4. Silencer
5. Vibration insulation
6. Ducts

Condensate Drain Connections

All condensate drain connections must be correctly trapped. Incorrect trapping can result in flooding within the unit and consequent flooding of the immediate area. Fill the drain trap with water before starting up the unit.

All drain lines should be insulated where passing through any space where damage from condensation drip might occur. If the unit is installed in unheated premises the condensate pipe should be heat-insulated and heated with heating cable.

A condensate pipe and a drain trap

Drain scheme of Vertical Unit

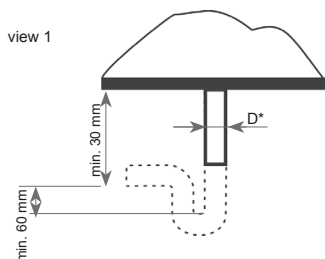

3.1 c Picture

* D = 15 mm

Drain scheme of Horizontal Unit

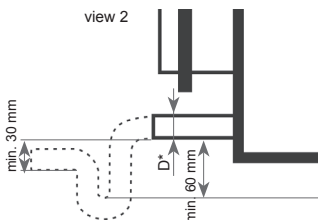

3.1 d Picture

Units extract air condensate tray are with self controlled heating cable. Heating cable are activated in heating mode only. The water trap must be installed D = 28mm.

Ductwork

The air flows in/out air handling unit through ductwork. We recommend using galvanized steel (Zn 275 gr/m²) ductwork, to ensure easy cleaning and durability. It is necessary to use the ductwork system with low air flow rate and small pressure drop to have necessary air volume and low sound level and save the energy. The appropriate sound attenuators will reduce the noise level of the fans in the premises.

All ductwork should be insulated with 50–100 mm thickness insulation to avoid the condensation.

Note: temperature sensor B1 has to be mounted in the supply air duct under electric heater (see the functional diagram in Control System Electrical Installation and Operation Manual). It is necessary to leave space in straight air duct for sensor mounting and guarantee the space for maintenance and service work. Minimal space between the unit and B1 sensor is the space of double air duct diameter.

 Ductwork, steelwork and any other services should not be supported off the unit.

 It is recommended to install air dampers in the inlet and outlet ducts. For ventilation units with water air heater, it is mandatory to use inlet air closing damper with spring return mechanism.

Final Inspection

After installation of the unit, a thorough inspection should be carried out. This should include inspecting the inside of the unit and removing debris and tools, which may have been left behind by on site contractors. Replace any panels, which may have been removed and close all access doors, ensuring that the door sealing gaskets have not been damaged.

4. MAINTENANCE

It is recommended to carry out routine maintenance of the air handling unit, 3–4 times per year.

 Units are filled with f-gas. Service should be carried out in accordance with the local laws.

Besides preventive maintenance inspection, the following operations should be performed:

- 1. Rotary heat exchanger check.** Inspection of the rotary heat exchanger is performed once per year. Free rotation of the rotary heat exchanger, continuity of the rotating belt, absence of damages of the rotor drums and the seal gasket are checked. It is necessary to check the stretch of belt. Free belt will slide and the efficiency of rotary heat exchanger will fall down. To reach maximal efficiency, rotor must turn at least 8 times per minute. Polluted heat exchanger will decrease efficiency. Clean heat exchanger with an air blast or wash with tepid water. Check out water falling on the electric motor.

2. Fans check (once per year). Polluted fans decrease efficiency.



Before performing any inspection work, check whether the unit is switched off from the electric power supply.

Fans should be carefully cleaned with textile or soft brush. Do not use water. Do not break balance. Check if direction of fan turns is right, because wrong direction of turns gives only 30% rating. Check if fan freely rotates and is not mechanically damaged, if impeller does not touch suction nozzles, fan does not spread noise, the pressure tubes are connected to the nozzle (if it is required), mounting bolts are screwed.

The rubber couplings connecting the motor base and the unit should be visually inspected for signs of wear and replaced as necessary.

Any unusual noise or vibration when the fan is running should be immediately investigated, as this usually an indication of wear or imbalance in the fan system.

3. **Air heater check.** Recommended to perform periodical inspection and cleaning of heater. Check the plates of water air heater. The air heater is cleaned with hoover from supply air side or with air blast from exhaust air side. If it is very dirty, wash with tepid water, which will not make corrosion of aluminium. Check if position of return water temperature sensor is right. Check if electric air heater is properly fixed, wires connections are not damaged and heating elements are not bent. They can be damaged or bent due to uneven heat or uneven and turbulent air direction. Check if electric air heater is clear of unnecessary things and heating elements are not clogged, because this can cause unpleasant smell or in the worst case – dust can start burning. Heating elements can be cleaned with hoover or wet textile.
4. **Air damper check (if it is required).** Not fully opened outside air damper rises up the pressure in the system. Water air heater can freeze if outside air damper does not fully close in not working air handling unit. Mounting and running of air damper should be checked and regulated.
5. **Air filter clogging check.** Change air filters when air filter clogging is indicated. We recommend to change filters at least twice per year: before and after heating season, or more¹. Filters are one time used. We do not recommend cleaning them. Stop the air handling unit before changing filters.

Pressure sensor

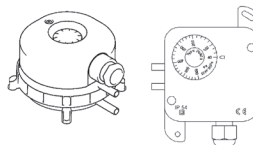

4 Picture

6. **Pressure sensor setting, which indicates impurity of filters.** Pressure sensor is set according to EN 13779:2007 standard: 100 Pa for small systems, 150 Pa for big systems. Remove cover from the pressure sensor and turn the cursor due to proper position. The indicator will turn on when filters will be clogged.
 - One of pressure sensors shown in 4 Picture can be mounted in the air handling unit.
 - Close the door after pressure sensor regulating process. Be sure that sensor does not indicate impurity of clear filters.
7. **Heat pump maintenance.** Sight glass must be checked. If in the heat pump hydraulic circuit are moisture (indicated by sight glass), it is possible for incorrect expansion valve operation. Heat pump's visual maintenance should be carried out if where are no cracks or refrigerant leakage. Tubes insulation should be checked if where are no cracks or damaged places.

¹ Clogged filters unbalance ventilation system, air handling unit uses more power.

Heat pump

For heat pump service, back unit's casing should be dismount.

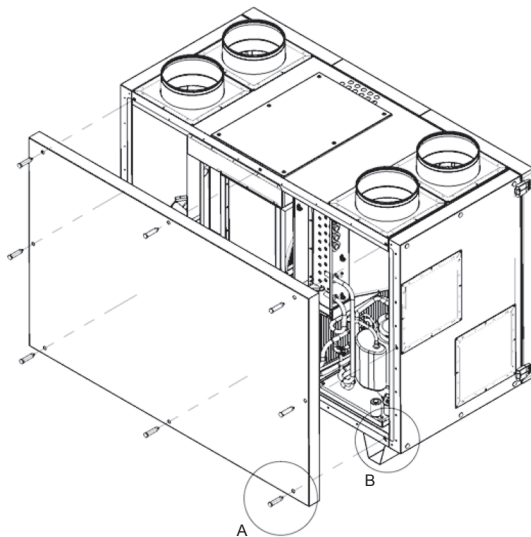

5 Picture

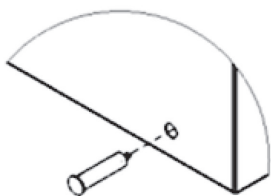

A (1 : 4)

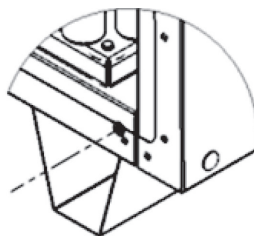

B (1 : 4)

6 Picture

Carefully, max torque 1.5 Nm.

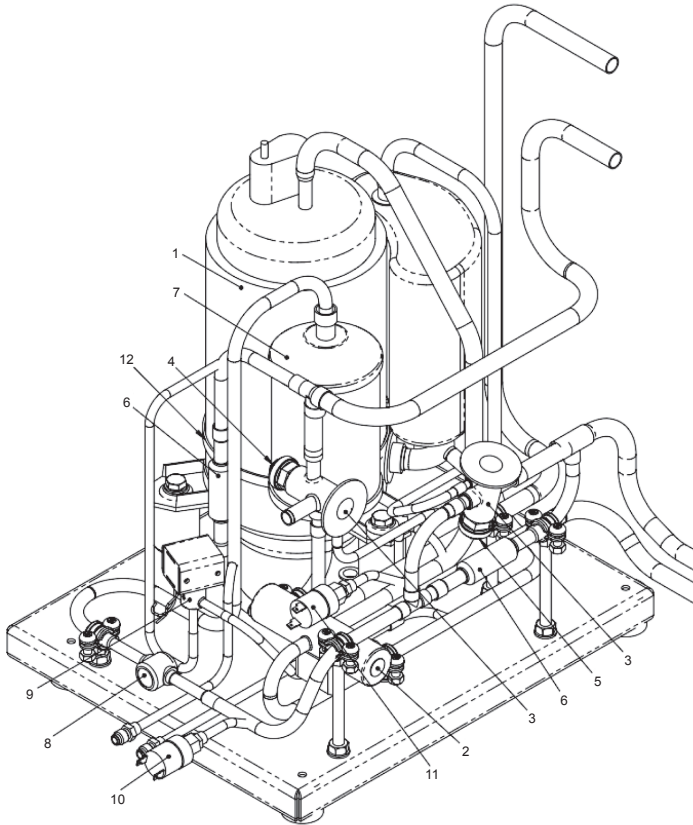

7 Picture. Heat pump assembly

1. Compressor
2. 4-way valve
3. Expansion valve
4. Expansion valve orifice for heating mode
5. Expansion valve orifice for cooling mode
6. Check valve
7. Filter - dryer
8. Sight glass
9. Defrost valve
10. High pressure pressostat
11. Low pressure pressostat
12. Crankcase heating element

5. TECHNICAL INFORMATION

Horizontal units RHP 600-1500 UH

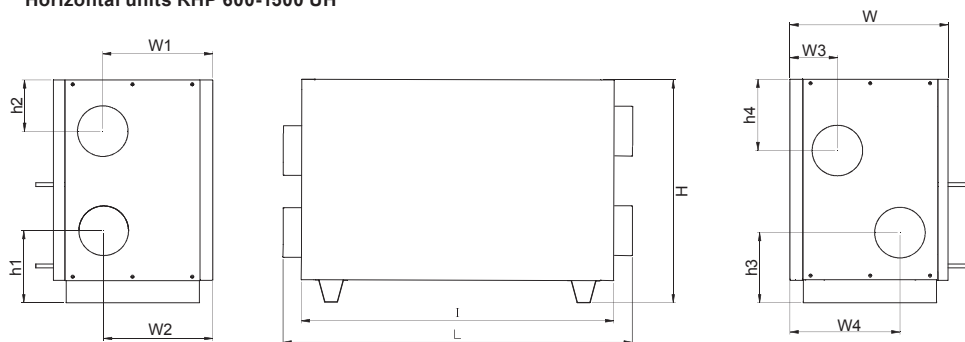

Vertical units RHP 600-1500 UV

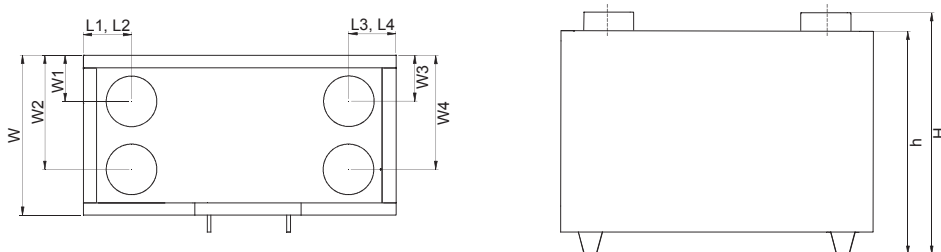

Vertical unit RHP 400 V

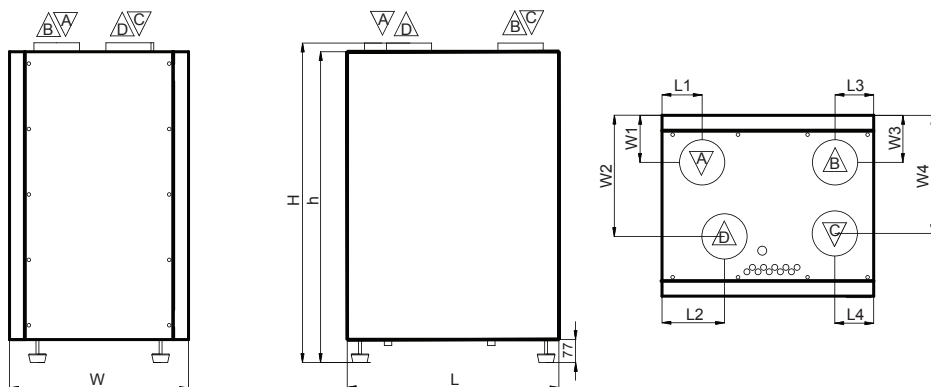

Dimensions and technical information

Parameters	Overall dimensions			Weight	Supply voltage	Operating current	Heater capacity	Fans input power	Ducts connection size, D	Heat pump			
	Width	Length L/l	Height H/h							Heating capacity	Cooling capacity	Refrigerant	Amount of refrigerant
	[mm]	[mm]	[mm]							[kW]	[kW]	–	[kg]
400 V-2,2/1,4	600	712	1074/1045	120	1~230	6.6	1	2*96	160	2,2	1,4	R134A	1.1
400 V-2,8/2,4	600	712	1074/1045	120	1~230	7.7	1	2*96	160	2,8	2,4		1.1
600 UH-3.7/3	650	1258/1400	900	194	1~230	9.6	1	2*170	200	3,7	3	R134A	2.2
600 UV-3.7/3	650	1258	986/900	194	1~230	9.6	1	2*170	200	3,7	3		
600 UH-4.4/3.8	650	1258/1400	900	194	1~230	10.5	1	2*170	200	4,4	3,8		
600 UV-4.4/3.8	650	1258	986/900	194	1~230	10.5	1	2*170	200	4,4	3,8		
800 UH-5.3/4.7	910	1670/1508	989	255	3~400	14.8	2	2*385	250	5,3	4,7		
800 UV-5.3/4.7	910	1508	1059/989	255	3~400	14.8	2	2*385	250	5,3	4,7		
800 UH-6.1/5.8	910	1670/1508	989	255	3~400	16.1	2	2*385	250	6,1	5,8	R134A	3.1
800 UV-6.1/5.8	910	1508	1059/989	255	3~400	16.1	2	2*385	250	6,1	5,8		
1300 UH-8.1/6.6	910	1670/1508	989	260	3~400	18.2	2	2*385	250	8,1	6,5		
1300 UV-8.1/6.6	910	1508	1059/989	260	3~400	18.2	2	2*385	250	8,1	6,5		
1300 UH-9.2/7.6	910	1670/1508	989	260	3~400	20.5	2	2*385	250	9,2	7,6		
1300 UV-9.2/7.6	910	1508	1059/989	260	3~400	20.5	2	2*385	250	9,2	7,6		
1500 UH-9.6/7.8	910	1670/1508	989	260	3~400	21.9	2	2*470	250	9,6	7,8		
1500 UV-9.6/7.8	910	1508	1059/989	260	3~400	21.9	2	2*470	250	9,6	7,8		

Dimensions of Ductwork Connection

	w1	w2	w3	w4	L1	L2	L3	L4	h1	h2	h3	h4
	[mm]	[mm]	[mm]	[mm]	[mm]	[mm]	[mm]	[mm]	[mm]	[mm]	[mm]	[mm]
400 V	158	407	158	398	135	210	130	130				
600 UH	441	438	190	432					284	200	284	292
600 UV	185	458	185	458	192	192	193	193				
800 UH	650	252	252	650					323	267	294	245
800 UV	236	650	231	597	240	240	240	240				
1300-1500 UH	650	252	252	650					323	267	294	245
1300-1500 UV	236	650	231	597	240	240	240	240				

Filters

Unit	Type	Overall dimensions, mm			
		Width	Height	Supply	Extract
				Length	Length
400 V	2 x KF5	462	200	46	46
600 UH	2 x KF5	500	280	46	46
600 UV	2 x KF5	500	280	46	46
800 UH	2 x KF5	750	400	46	46
800 UV	2 x KF5	750	400	46	46
1300-1500 UH	2 x KF5	750	400	46	46
1300-1500 UV	2 x KF5	750	400	46	46

Troubleshooting of heat pump

No.	Message	Probable cause	Possible solution in heating mode	Possible solution in cooling mode	
(A1)	Compressor failure	Compressor motor, drive or control system failure.	See operation manual (p. 94).		
(A2)		Overload protection activated.	The compressor has operated in critical conditions or there is insufficient refrigerant amount in heat pump hydraulic circuit. Check the working conditions and make sure they are in limits. Low refrigerant level see item C8.		
B1	High pressure on compressor	Low air flow.	Increase supply air flow.	Increase extracted air flow.	
B2		Condenser obstructed.	Clean condenser surface.		
(B3)		High pressure transducer failure.	Check pressure in heat pump system with manometers. If pressure reading does not match, check cable connection or replace transmitter if necessary.		
(B4)		Incondensable gas in heat pump hydraulic circuit.	Recharge circuit after having drained and evacuated it.		
(B5)		Refrigerant filter clogged.	Check and replace if necessary.		
(B6)		Excessive refrigerant charge.	Discharge the excess gas.		
(B7)		Expansion valve does not work properly.	Check and replace if necessary.		
C1		Low pressure on compressor	Low air flow.	Increase supply air flow.	Increase extracted air flow.
C2			Frosted evaporator.	See item D1.	
(C3)			Low pressure transducer failure.	Check pressure in heat pump system with manometers. If pressure reading does not match, check cable connection or replace transmitter if necessary.	
(C4)	Evaporator obstructed.		Clean evaporator surface.		
(C5)	Expansion valve does not work properly.		Check and replace if necessary.		
(C6)	Refrigerant filter clogged.		Check and replace if necessary.		
(C7)	Moisture in heat pump hydraulic circuit.		Replace filter and dry out system.		
(C8)	Low level of refrigerant.		Check circuit with leak detector. Repair, evacuate and refill circuit with refrigerant.		
(D1)	Evaporator is icing		Defrost solenoid valve does not open.	Check solenoid valve coil. Check solenoid valve and replace if necessary.	
(D2)			Air pressure transducer failure.	Check air pressure measurement tubes. Replace air pressure transducer if necessary.	
(D3)		Evaporator tray heating element failure.	Check and replace if necessary.		
E1	Heat pump does not start	Too low outdoor temperature.	Heat pump will start operating when the outside air temperature will be above -15 °C (approximately).		
E2		Low supply or/and exhaust air volume.	Set air flow more than in table 1		
F1	Heat pump works regularly but with an insufficient capacity	Low air flow.	Increase supply and (or) extracted air flow.		
F2		Low level of refrigerant.	See C8.		
(F3)		4-way valve failure.	Check 4-way valve coil. Check 4-way valve and replace if necessary.		
(F4)		Defrost solenoid valve is open.	Check solenoid valve coil. Check solenoid valve and replace if necessary.		
(G1)	Frost in compressor suction line	Expansion valve does not work properly.	Check and replace if necessary.		
(G2)		Refrigerant filter clogged.	Check and replace if necessary.		
(G3)		Evaporator obstructed.	Clean evaporator surface.		
H1	Abnormal noises in heat pump system	Components vibrate.	Fasten properly.		
(H2)		The compressor is noisy.	Replace the compressor.		

○ – the cause must be eliminated only by qualified person.

6. ELECTRICAL INSTALLATION MANUAL

Installation works can be performed only by the specialists that have required qualification. During installation following requirements must be fulfilled.

 It is recommended to lay control cables separately from power cables, or use shielded cables. In such case it is necessary to earth cable shielding!

6.1. Air Handling Units Sections Connection

After unit parts have been connected together (see unit installation instruction), unit sections connecting cables and wires are connected.

 Connector connection is performed strictly according to numeration given in wiring diagram, or adequate markings (see unit electric scheme).

 When disconnecting unit sections, do not pull by connecting wires and cables!

6.2. Electric Power Supply Connection

If the air handling unit voltage is ~230 V; 50 Hz it is necessary to install the socket with grounding of corresponding capacity (see electric diagram unit). If the voltage is ~400 V; 50 Hz, the cable of electrical power supply is connected to the main switch, which is located on the unit's outside wall. It is necessary to connect earthing! Types of cables of connection of electrical power supply are specified in 6.2 Table:

6.2 Table. Electrical Power Supply Cable Types

Air Handling Unit Type	Cable type
RHP 600 U	3 × 1,5 mm ² (Cu)
RHP 800 U, RHP 1300 U, RHP 1500 U	5 × 2,5 mm ² (Cu)

 Air handling units designed for 400 V AC supply voltage must be connected to the stationary installation by solid cable. All units must be connected through circuit breaker with 30 mA current leakage protection (type B or B+).

 Before connecting unit to the electrical power supply, it is necessary to check whether earthing has been installed properly.

6.3. External Elements Connection

The air handling unit is designed with external connection terminals which are located on the controller box, inside the air handling unit. All external control elements are connected to the terminals.

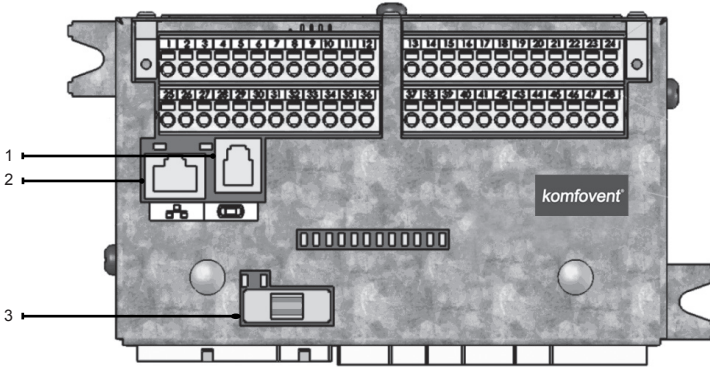

1. Control panel connection
2. „Ethernet“ computer network or internet connection
3. Fuse 1A

6.3 a Picture. Controller with connection terminals

				B5				B1				TG3				TG2				TG1				S2				S1																																			
MODBUS RS485 connection				External control				Return water temperature sensor				Supply air temperature sensor				Humidifier control				Cold water mixing valve actuator				Hot water mixing valve actuator				Cooling water pump 230V AC, 1A				Heating water pump 230V AC, 1A																															
External control				External control				NTC				NTC				0..10V				0..10V				0..10V				L				L																															
B				A				GND				IN4				IN3				IN2				IN1				C				NTC				NTC																											
1				2				3				4				5				6				7				8				9				10				11				12																			
25				26				27				28				29				30				31				32				33				34				35				36																			
0..10V				~24V				N				0..10V				~24V				N				0..10V				~24V				N				0..10V				~24V				N																			
Humidity sensor				Air quality sensor				Exhaust air pressure sensor				Supply air pressure sensor				0..10V				GND				0..10V				~24V				N				0..10V				~24V				N																			
B9				B8				B7				B6				C				~24V				N				NO				NO				C				NO				NO				NO				C				L				N			
Air damper actuator				Run				Alarm				Common				Indication				Cooling control				DX3 signal				DX2 signal				DX1 signal				Common				230V AC, 0.5A																							
FG1				DX				DX				DX				DX				DX				DX				DX				DX				DX				DX				DX				DX															

6.3 b Picture. External control elements connection

6.4. Temperature Sensors Installation

The supply air temperature sensor B1 (6.4 a Picture) is mounted in the air duct in a projected place for it; after cooler section (if provided). The minimal distance from the duct connection of the unit up to the sensor should be not less than double diameter of the circular connection or a diagonal of rectangular connection.

Supply air temperature sensor B1

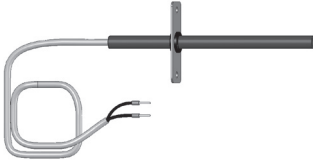

6.4 a Picture

Water temperature sensor B5



6.4 b Picture

6.5. Requirements for the installation of the control panel

1. The control console should be installed in a room where the following conditions are ensured:
 - 1.1. ambient temperature: 0 °C ... 40 °C;
 - 1.2. relative humidity range: 20 % ... 80 %;
 - 1.3. protection against vertical dripping of water (IP X2).
2. Control panel connection is provided through a hole in the back or bottom side.
3. The panel can be mounted on a flush mounting box or in any other place just screwing two holes on the fastening surface.

6.6. Control panel connection

The control panel is connected to the controller box (see Picture 6.3 a). The length of the cable for connecting the panel with the unit may not exceed 150 m. The cable type is indicated on the electrical diagram of the unit.

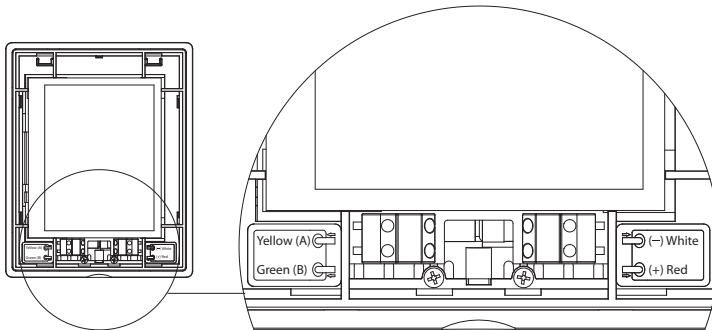

6.6 Picture. Control panel connection

Control panel connection and other cable thicknesses are specified in the wiring diagram!

7. OPERATION MANUAL

7.1. Unit Control

Air handling units control system ensures control of the physical processes that are taking place inside the air handling unit.

Control system consists of:

- main controller module;
- circuit breakers and main switch;
- control panel, which can be installed in the convenient place for the user;
- pressure and temperature sensors.

Control panel (7.1 Picture) is designed for remote air handling unit control, setting and display of controller parameters.



7.1 Picture. Control panel

7.2. Control panel indication

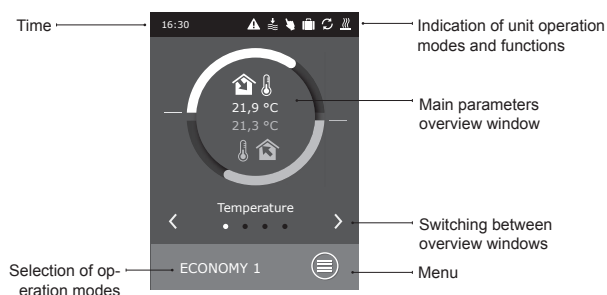

Explanation of the displayed symbols

	Supply air temperature		Fan operation		Air humidifier operation
	Extract air temperature		Air flow increasing by activated function (see chapter Functions)		Summer night cooling mode
	Supply air volume		Air flow decreasing by activated function (see chapter Functions)		Weekly operation mode
	Extract air volume		Energy recovery operation		Holiday operation mode
	Supply air humidity		Air heater operation		„Override“ mode
	Extract air humidity		Air cooler operation		Alarm signal
	Extract (room) air quality				Heat pump operating prohibition*

* Under certain conditions, the heat pump cannot operate due to low (high) outdoor air temperature or due to low air flow of the air handling unit. For more details, see the section “Heat pump”.

7.3. Parameters overview

The main parameters of the unit are indicated in four main windows of the panel: temperatures indication, air flow, air quality (humidity) and energy saving.

All other unit parameters are presented in the menu “Overview” (see 22 page).

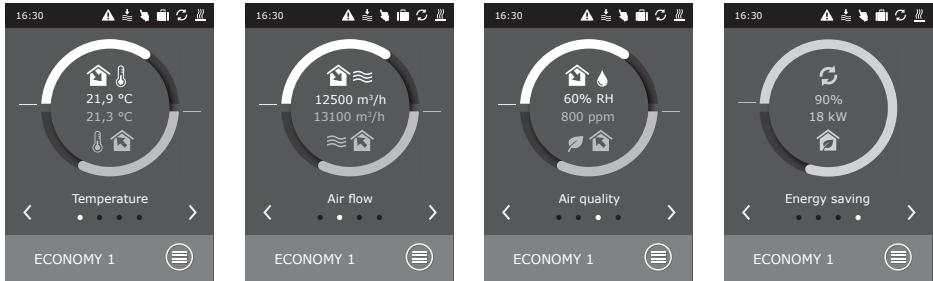

7.4. Operation modes selection

Six operation modes are possible, one of them user can select directly from control panel main window:

- Two Comfort and two Economy modes, for each of them the user can set air flow and temperature.
- Special mode allows the user not only to set air flow and temperature, but also to select blocking or using heating, cooling and other functions.
- OFF mode completely turns off the unit.

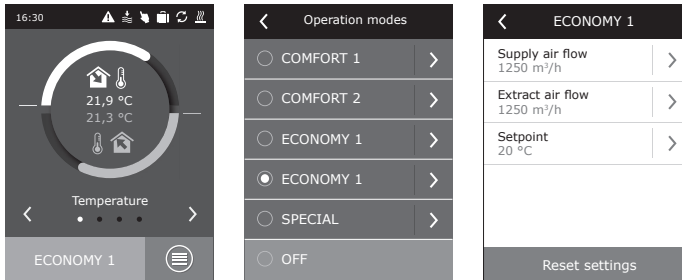

7.5. Menu

Menu of panel consists of the four points:

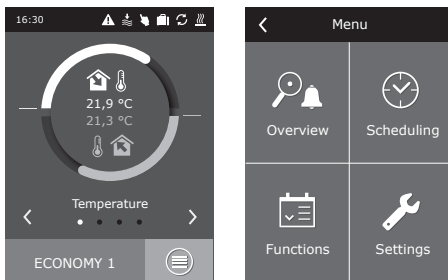

7.5.1. Overview

Main air handling unit parameters are presented in the main windows (Chapter 7.3). All other information, relating to the operation of the unit, malfunctions and efficiency status is detailed in overview menu.

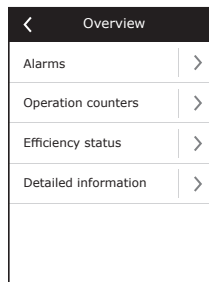
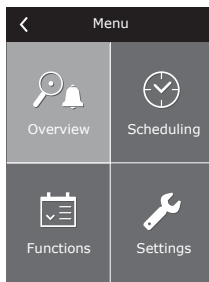

7.5.1.1. Alarms

This menu displays the notification of existing faults.

After failure elimination (see chapter 7.8), messages are deleted by selecting "Delete". By clicking on „History“ can be viewed up to 50 registered alarms.

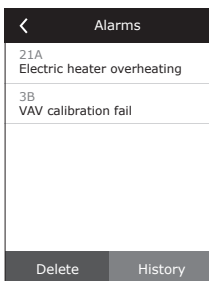

7.5.1.2. Operation counters

This menu displays operation time of the fans, the consumed energy of the heater and how much energy was recovered by the heat exchanger.

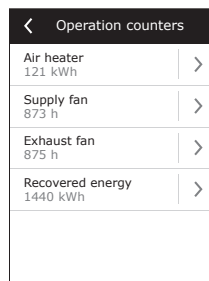

7.5.1.3. Efficiency status

Menu for the heat exchanger efficiency and energy recovery monitoring in real time.

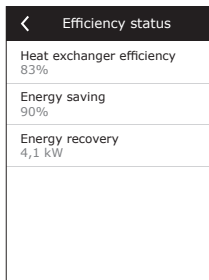

7.5.1.4. Detailed information

All temperature sensor readings, functioning of separate air handling unit elements and other detailed information is available in this menu.

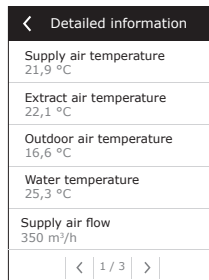

7.5.2. Functions

In this menu item, the user can activate and set additional unit functions.

- blank box: function is not activated
- gray box: function is activated, but currently not operating
- blue box: currently operating function

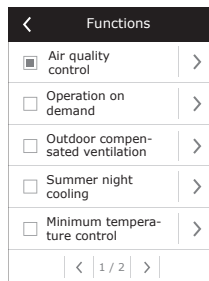
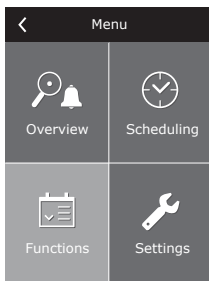

7.5.2.1. Air quality control

Air quality control is designed according to:

- CO₂ sensor¹ [0...2000 ppm];
- air quality sensor VOCq [0...100 %];
- air pollution sensor VOCp [0...100 %];
- relative humidity sensor [0...100 %];
- temperature sensor [0...50 °C].

Depending on the type of the selected sensor, the value of the air quality function to be maintained is set, and the air handling unit intensity will be adjusted according to that value. Ventilation intensity will be increased automatically in the case of deviation from the set value and decreased again when it is approached. For example, if the unit is designed with the CO₂ maintenance function and is equipped with a CO₂ sensor, after setting value 800 ppm, this set CO₂ level will be maintained by adjusting ventilation intensity, i.e. ventilation intensity will be increased if the CO₂ level grows and will be decreased when it returns to the previous condition.



The function of air quality operates only if no other below function is active at the same time:

- summer night cooling;
- min. temperature control;
- outdoor compensated ventilation.

7.5.2.2. Operation on demand

The air handling unit start-up function is designed to start the unit which currently off, when one of the selected parameters has exceeded the critical limit.

The function provided for the start-up of the unit according to:

- room CO₂ sensor;
- room air quality sensor VOCq;
- room air pollution sensor VOCp;
- room relative humidity sensor;
- room temperature sensor.



Operation on demand (start-up / shut-down) is performed by the same sensor which is used in the control of the "Air quality function".



A room sensor with the analogue output (0...10 V DC) should be designed for this function.

7.5.2.3. Outdoor compensated ventilation

The ventilation compensation function adjusts the air volume depending on the existing outdoor temperature. It is possible to enter four temperature points, with two of them defining winter conditions and the other two defining summer conditions. When compensation start and end points for both winter and summer seasons are entered (it is also possible to enter only one of them, example only winter compensation; in this case, the start and the end points of summer compensation should be the same), the current ventilation intensity will be decreased in proportion according to the outdoor temperature until it reaches the minimum possible ventilation level of 20 %.



The ventilation compensation function does not operate when summer night cooling function is active.

Air quality control	
<input checked="" type="checkbox"/> Enable	
Setpoint 1 1000 ppm	>
Mode 1 COMFORT 1	>
Setpoint 2 880 ppm	>
Mode 2 COMFORT 2	>
Reset settings	

Operation on demand	
<input checked="" type="checkbox"/> Enable	
Setpoint 1000 ppm	>
Reset settings	

Outdoor compensated ...	
<input checked="" type="checkbox"/> Enable	
Winter stop -15 °C	>
Winter start 5 °C	>
Summer start 25 °C	>
Summer stop 35 °C	>
Reset settings	

¹ Factory setting.

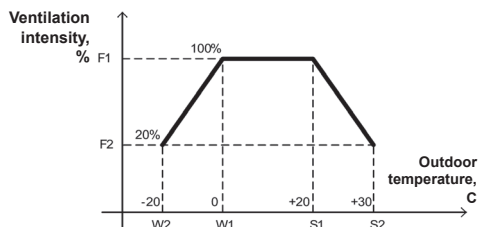

F1 – user-selected air flow (actual)
 F2 – minimum air flow 20 %
 W1 – winter compensation start point
 W2 – winter compensation end point
 S1 – summer compensation start point
 S2 – summer compensation end point

7.5.2.4. Summer night cooling

Summer night cooling function is intended for energy saving during the summer season: by utilizing the outside chill of night hours, it is possible to cool down heated rooms, i.e. to remove excessive heat that accumulated in the room during day hours.

Summer night cooling function can start at night (from 00:00 h to 06:00 h a.m.) at any time, even when the air handling unit is not working and is in standby mode. User can set indoor temperature, at which this function starts and stops.

When this function is active, the current ventilation level is switched to the maximum ventilation intensity (100 %) and ventilation is performed only by means of fans, i.e. at that time neither the air cooling nor the energy recovery functions operate.

Summer night cooling function has an operating priority over the following functions: outdoor compensated ventilation and the air quality function.

← Summer night cooling

<input checked="" type="checkbox"/> Enable	
Start when indoor 25 °C	>
Stop when indoor 20 °C	>
Reset settings	

7.5.2.5. Minimum temperature control

In winter time the minimum temperature control function forcibly reduces the supply and extract air flow set by the user when the heater capacity available in the unit is insufficient and/or heat recovery does not ensure minimally possible temperature supply to the room. The user can set a separate supply air temperature value so that when that value is not achieved, the intensity of the ventilation unit starts to be reduced automatically. The air flow may be reduced to the minimally possible ventilation intensity of 20 %.

During the summer, when the air handling unit provided with cooler, this function according to the same user-set value limits the cooling capacity, thus ensuring the minimum possible temperature supply to the room.

In ventilation intensity control, this function has top priority over “Outdoor compensated ventilation” and “VAV” functions.

← Minimum temperature ...

<input checked="" type="checkbox"/> Enable	
Setpoint 15 °C	>
Reset settings	

7.5.2.6. Override function

Override (OVR) control of the unit can be performed by the external contact (see Picture 6.3 b) or device (timer, switch, thermostat, etc.). The received signal from the outside activates the OVR function, which ignores the current operation modes of the unit and performs one of the selected actions listed below:

- switches off the air handling unit;
- switches over the unit to operation according to the mode “Comfort1”;
- switches over the unit to operation according to the mode “Comfort2”;
- switches over the unit to operation according to the mode “Economy1”;
- switches over the unit to operation according to the mode “Economy2”;
- switches over the unit to operation according to the mode “Special”;
- switches over the unit to operation according to the weekly schedule.

← Override function

<input checked="" type="checkbox"/> Enable	
Override If on	>
Mode ECONOMY 1	>
Reset settings	

The OVR function provides for three operation modes selectable depending on the needs of the user:

1. The mode “When on” – the function will respond to the external control contact only when the air handling unit is on.
2. The mode “When off” – the function will respond to the external control contact only when the air handling unit is off.
3. The mode “Always” – the function will respond to the external control contact irrespective of the operating condition of the unit.

 The OVR function has the top priority and, therefore, ignores all previous modes. The function remains active as long as the external control contact is in the closed position.

7.5.2.7. Humidity control

Humidity control function is designed for maintenance of air humidity determined by the user. For proper operation of the function one or two additional humidity sensors shall be connected, depending on where humidity will be maintained. There are two modes for maintenance of humidity:

- **Supply air.** The determined humidity of supply air is maintained, using the supply air duct humidity sensor (B9).
- **Room air.** The determined humidity of indoor air is maintained, using the room air or exhaust air duct humidity sensor (B8). The supply air humidity limit is set using the duct humidity sensor or hydrostat (B9).

One of the below methods can be chosen for maintenance of the determined humidity:

- **Humidification of air.** There is a control signal of 0...10 V, directly reflecting the capacity of the humidifier from 0 to 100 %. If humidification is required, the control is transferred through the output TG3 of the controller.
- **Dehumidification of air.** There is a control signal of 0...10 V, directly reflecting the capacity of the dehumidifier from 0 to 100 %. If dehumidification is required, the control is transferred through the output TG3 of the controller.
- **Dehumidification of air: cooling-heating.** Dehumidification is performed using the coolers and heaters available in the air handling unit. If there are several coolers and heaters, then it shall be pre-determined which of them will be used in the dehumidification process.
- **Humidification and dehumidification of air.** For humidification of air the control signal of 0...10 V is used through the output TG3 of the controller, and the dehumidification of air is performed using the coolers and heaters available in the unit.

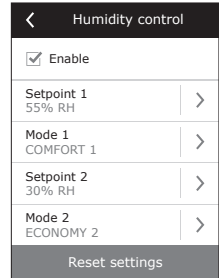

 If the maintenance of the room air humidity is provided for, then the humidity function will prevail over the air quality and recirculation functions, i.e. when humidification or dehumidification is required, these functions will be blocked.

 Humidity control function must be ordered in advance.

7.5.3. Scheduling

Menu for planning of the air handling unit operation according to the weekly program and the annual calendar.

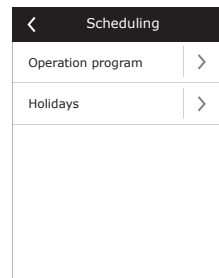
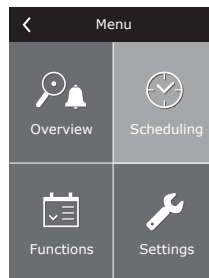

7.5.3.1. Operation program

User can set up to twenty operation programs for the unit. For each program possible to adjust the mode of operation, day of the week and the time interval.

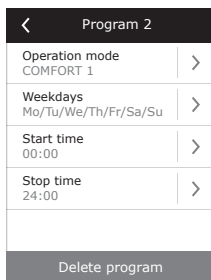
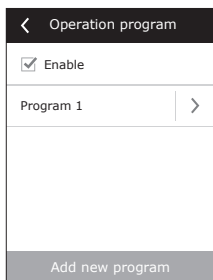

7.5.3.2. Holidays

Holiday schedule specifies the time period during which the unit operates under selected mode. Possible to set up to ten holidays.

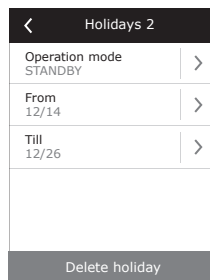
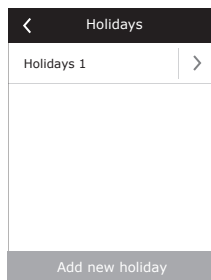

7.5.4. Settings

This menu is for air handling unit and the user parameter setting.

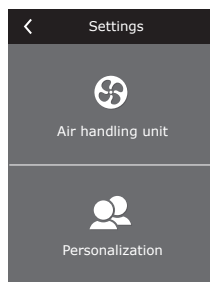
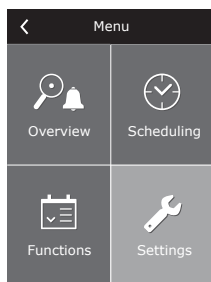

7.5.4.1. Air handling unit settings

Temperature control

The air handling unit provides for several temperature control modes:

- Supply. The unit supplies air according to the temperature preset by the user.
- Extract. Unit automatically supplies air of such temperature to maintain preset exhaust air temperature.
- Room. Operation is similar to the mode “exhaust” but temperature is maintained by the sensor mounted in the room (B8).
- Balance. Supply air temperature maintenance value will be determined automatically from the existing exhaust air temperature, i. e., what the air will be removed from the premises, and the same will be returned back.

When “Balance” is selected, the temperature setpoint disappears.

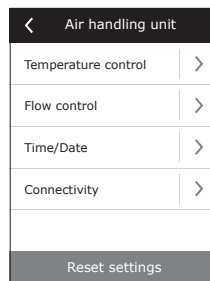

Air volume control

Supply and exhaust air volumes control modes have been provided in the unit:

- **CAV** – constant air volume control mode. The unit will supply and extract a constant air flow which is preset by the user, irrespective of any changes occurring in the ventilation system;
- **VAV** – variable air volume control mode. The unit will supply and extract an air flow with regard to the ventilation needs in different rooms. In case of frequently changing ventilation demands this air volumes maintenance mode signally reduces unit exploitation costs.

It is possible to use a simplified VAV control function, “single-flow VAV control”. It means that the performance of this function requires only a single air flow pressure sensor, which is installed in a variable air duct system (e. g. in supply air). This variable system is called the master ventilation system, according to which

control is performed, while the other air flow (in this case, discharged air) operates as the slave ventilation system and always follows the master one. If the supply air requirement in the ventilation system which is assigned as the master system decreases, the intensity of discharged air in the slave system is reduced correspondingly by the same percentage.

 If the variable air volume control function is mode is selected, the initial calibration of the control mode must be performed; otherwise, the unit will not operate if the VAV mode is selected.

Variable air volume control mode calibration:

1. Before start of calibration the air distribution and exhaust devices in ventilation system should be adjusted, all valves for variable air flow in a way enabling air supply to all ventilated premises should be opened.
2. After switch on of the unit the VAV mode should be selected and calibration procedure should be confirmed. After the end of the calibration, depending on the configuration of pressure sensors, VAV mode status will change to Supply, Extract, Double.
3. After calibration the air handling unit further will operate in the previous mode.
 - **DCV**– direct controlled volume. The air handling unit will operate similarly as in the CAV mode, but air volumes will be maintained directly in accordance with the values of the B6 and B7 analog input signals of controller. After giving the signal 0... 10 V to the appropriate input, it will be converted according to the current determined air volume. For example, if the maximum air flow of the unit is 1000 m³/h, setpoint in the panel – 800 m³/h, and the B6 input value – 7 V, the unit will supply constant air volume of 560 m³/h, i. e., 70 % of the set value. The same applies to the exhaust air only by B7 input (see picture 6.3 b).

Time / Date

Time and date is required for air handling unit operation planning.

Connectivity

- IP address and subnet mask. Setting is required when air handling unit is connected to PC network or Internet.
- Controller ID. Number that identifies the controller, when several air handling units are connected to common network and controlled by one control panel.
- RS-485. Settings of external RS-485 interface (1, 2, 3 terminals, picture 6.3 b).

7.5.4.2. Personalization

In this item for the user are presented menu language, measurement units and other control panel settings.

Personalization	
Language	English >
Flow units	m ³ /h >
Screen saver	On >
Panel lock	Off >
Touch sound	Click >

7.6. Control of air handling units through a web browser

You may not only monitor the operation of air handling units and the functionality of their individual components, change settings and activate extra functions by means of control panel but also by your computer. All you need is to connect the unit to the computer, local area network or the Internet using a network cable.

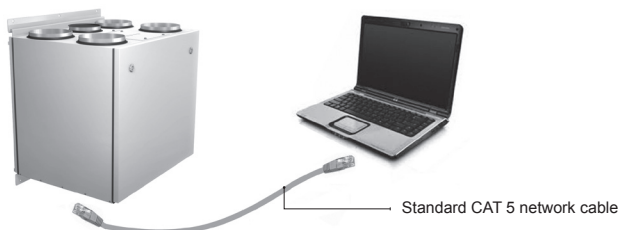

How to connect the unit directly to your computer:

1. Plug one end of the network cable into the controller port on the unit (see Picture 6.3 a) and the other end to the computer.
2. Go to the properties of your network card and enter IP address, e.g. 192.168.0.200, and subnet mask 255.255.0.0.
3. Open the web browser on your computer and disable all proxy servers in the settings.
4. In the address bar of your web browser enter the IP address associated with the air handling unit; the default IP address is 192.168.0.50. You can change it at any time on the control panel or from web browser (see connection settings).



Note: It is recommended to download the latest version of your web browser before use.

5. If the connection is successful, a window prompting to enter your user name and password appears:

 A screenshot of a login form. It has a grey background. On the left, it says 'User:' followed by a text input field containing the text 'user|'. To the right of this is 'Password:' followed by a password input field with six black dots. To the right of the password field is a button labeled 'Log in'.

Note: the user name is “user”. The default password is also “user”; after logging in, the user can later change the password to any other of his/her choice (see user interface settings).

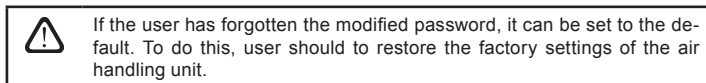

7.7. Additional control options

7.7.1. Combined water coil control

For the air handling unit with the combined water coil (Combi-coil – heater and cooler in one) the control of the mixing valve actuator is provided both under the air heating and cooling modes. The actuator is connected to the control terminals of the heating circuit and operates only under the heating mode by default. However upon transfer of the feedback signal confirming that there is cold water within the circulation system to the control terminals (IN4) of the external control (e. g., by connecting additional device: thermostat, switch, etc.), the air cooling function will be activated, and the mixing valve actuator (TG1) will be controlled under the air cooling mode.

7.7.2. Inverter direct evaporation cooler control

By default all RHP units are provided with inverter type DX cooler control, which allows stepless control of the compressor. For the inverter unit power control, there is a modulated signal (TG2), as well as signals: cooler start (DX1), cooling demand DX2, heating demand DX3 (see Pic. 6.3 b).

There are three different control methods:

1. Universal control, suitable for most cooler units¹.
2. Control adapted to Panasonic cooler units.
3. Control adapted to Daikin cooler units.

7.7.3. Multi-level control of direct evaporation cooler

For air cooling in the air handling unit there is provided 3 control contacts (connection is shown in Picture 6.3 b). Depending on how much will be cooling steps and how it will be divided on steps, it is recommended to select the optimal control method. If the capacity of all steps is the same, then only three control steps are possible. If cooling capacities of steps are close to ratio 1-2-4 (the capacity of each of the following steps is double the previous), then cooler control will be realized with seven cooling steps.

Example: To the terminals DX1 is connected 1kW cooler, to DX2 – 2kW and to terminals DX3 connected cooler with 4kW capacity. Control will be in steps:

- 1: 1 kW; 2: 2 kW; 3: 1 kW + 2 kW; 4: 4 kW; 5: 1 kW + 4 kW; 6: 2 kW + 4 kW; 7: 1 kW + 2 kW + 4 kW.

¹ Factory setting.

 The function of step rotation is provided, when capacities of coolers are the same.

 The number of direct evaporation cooling units must be provided in advance.

7.7.4. Reversal of direct evaporation coolers

There is a reverse option of direct evaporation coolers, i.e. when the cooler is switched to the heating mode. In such case, there must be only max 3 cooling control steps. There are control terminals DX3 for connection of the cooler reversing signal "Heating" (Pic. 6.3 b).

 The option of reversal of direct evaporation cooling units must be provided in advance.

7.8. Troubleshooting

If the unit fails to operate:

- Make sure that the unit is connected to the power supply network.
- Check whether the main switch (if designed) is turned on.
- Check all fuses of the automatics. If necessary, replace blown-out fuses with new ones having the same electrical parameters (the sizes of the fuses are indicated on the schematic electrical diagram).
- Check whether there is any failure message on the control panel. If there is indication, it needs to be eliminated first. In order to eliminate the failure, follow the table.
- If nothing is indicated on the control panel, check whether cable connecting control panel with the unit is not damaged.

7.8 Table. Alarms indicated on the control panel, their possible causes and elimination methods

Message	Possible cause	Elimination
Service time	If unit continuous operation (without breaks) was 12 months, then periodic inspection message appears.	After disconnecting the unit from power supply, it is necessary to carry out periodic inspection of the unit, i.e. to check the condition of the heat exchanger, the heater and fans.
Low supply air flow	Too high resistance of the ventilation system.	Check pressure pipes, air dampers, air filters and make sure that the ventilation system is not blocked.
Low extract air flow	Too high resistance of the ventilation system.	Check pressure pipes, air dampers, air filters and make sure that the ventilation system is not blocked.
VAV calibration fail	Pressure sensors are not connected or broken.	Check connections of the sensor or replace the sensor.
Change outdoor air filter	The fresh air filter is blocked.	Shut down the unit and replace the filter.
Change extract air filter	The extract air filter is blocked.	Shut down the unit and replace the filter.
Electric heater off	The heater is disconnected due to too low air volume.	As soon as the heater cools down, protection resets automatically. It is recommended to increase the ventilation intensity level.
Service mode	Temporary mode, which can be activated by the service personnel.	The service mode is switched off by simply deleting the alert message.
Supply air temperature sensor failure	The supply air temperature sensor is not connected or broken.	Check connections of the sensor or replace the sensor.
Extract air temperature sensor failure	The discharged air temperature sensor is not connected or broken.	Check connections of the sensor or replace the sensor.
Outdoor air temperature sensor failure	The external air temperature sensor is not connected or broken.	Check connections of the sensor or replace the sensor.
Exhaust air temperature sensor failure	The exhaust air temperature sensor is not connected or blocked.	Check connections of the sensor or replace the sensor.
Water temperature sensor failure	The water temperature sensor is not connected or broken.	Check connections of the sensor or replace the sensor.
Return water temperature low	Return water temperature of the heater dropped below the permissible limit.	Check the status and operation of the circulation pump, heating system and mixing valve actuator.

Message	Possible cause	Elimination
Internal fire alarm	Fire danger in the ventilation system.	Check the ventilation system. Find the source of the heat.
External fire alarm	A fire signal has been received from the fire signalization system of the building.	Delete alarm message and restart the unit when the fire signal disappears.
External stop	A signal from an external device (switch, timer, or sensor) has been received.	As soon as the auxiliary device is switched off, the unit will operate in the previous mode.
Heat exchanger failure	Blocked or not rotating rotor, by-pass damper failure.	Check the rotor drive, replace the belt or check the by-pass channel operation.
Heat exchanger icing	Icing may form under a low outdoor temperature and high room humidity.	Check the operation of the rotation heat exchanger drive or the air bypass damper of the plate heat exchanger.
Low supply air temperature	The heating equipment fails to operate or its capacity is insufficient.	Check the heating equipment.
High supply air temperature	The heating equipment is not controllable (mixing valve or contactor is blocked).	Check the heating equipment.
Electric heater overheat	The emergency overheating protection of the electrical heater has actuated.	Protection can be reset only by pressing the RESET press-button on the heater.
Evaporator air temperature sensor failure	The evaporator air temperature sensor is not connected or broken.	Check connections of the sensor or replace the sensor.
Evaporator icing	The evaporator is iced over due to excessively high humidity content in the exhaust air and low outdoor temperatures.	Check the operation of the evaporator defrost system.
High pressure on compressor	Compressor system operated in an overload mode as a result of too high temperature in the condensing unit.	Identify the cause and eliminate it.
Low pressure on compressor	Compressor system is leaky or the amount of refrigerant is insufficient.	Identify the cause and eliminate it.
Compressor failure	No power supply.	Check supply voltage on the circuit breaker and/or make sure whether it is on.
	Supply voltage mismatches.	Check that the supply voltage is on all three phases, if necessary, swap the two phase conductor positions.
	Compressor motor failure.	Check the compressor motor and replace it if necessary.
	Compressor drive failure.	Check the operation of the compressor drive and replace it if necessary.
Supply fan drive failure	A fault signal has been received from the supply fan drive.	Check the supply fan drive and its messages.
Supply fan drive overload	The supply fan drive is overloaded.	Check the condition of the supply fan drive and its cooling.
Supply fan motor failure	The supply fan is broken.	Check the supply fan and replace it if necessary.
Supply fan motor overload	The supply fan is overloaded.	Check the condition of the supply fan and make sure that the resistance of the ventilation system is not exceeded.
Exhaust fan drive failure	A fault signal has been received from exhaust fan drive.	Check the exhaust fan drive and its messages.
Exhaust fan drive overload	The exhaust fan drive is overloaded.	Check the condition of the exhaust fan drive and its cooling.
Exhaust fan motor failure	The exhaust fan is broken.	Check the exhaust fan and replace it if necessary.
Exhaust fan motor overload	The exhaust fan is overloaded.	Check the condition of the exhaust fan and make sure that the resistance of the ventilation system is not exceeded.
Rotor drive failure	A fault signal has been received from the rotor drive.	Check the rotor drive and its messages.
Rotor drive overload	The rotor drive is overloaded.	Check the condition of the rotor drive and its cooling.
Rotor motor failure	The rotor motor is broken.	Check the rotor motor and replace it if necessary.

Message	Possible cause	Elimination
Rotor motor overload	The rotor motor is overloaded.	Check the condition of the rotor motor and make sure that the rotor is not blocked.
Communication error	No communication with the internal components of the air handling unit (controller extension modules, frequency converters, fans, etc.) or one / several of them are broken.	Check internal connections and functioning of separate components.
Controller failure	Main controller module fault.	Replace the main controller.

 The emergency protection of the electrical heater against overheating can be reset with the RESET button only if the cause of the overheating of the heater has been clarified and eliminated.

 If the unit is shut down and a failure text message is shown on the control panel, the fault must be eliminated!

 Before performing any jobs inside the unit make sure that the unit is stopped and disconnected from the electrical power supply.

After failure has been eliminated and power supply connected the error messages should be deleted. However if the failure has not been eliminated, unit either starts operating and after some time it stops again, or it does not operate and failure message is indicated.

UAB KOMFOVENT

VILNIUS Ozo g. 10, LT-08200
Tel. +370 (5) 2779 701
Mob. tel. 8-685 44658
el. p. info@komfovent.com

KAUNAS Taikos pr. 149, LT-52119
Tel.: (8-37) 473 153, 373 587
Mob. tel. 8 685 63962
el. p. kaunas@komfovent.com

KLAIPĖDA Dubysos g. 25, LT-91181
Mob. tel.: 8 685 93706, 8 685 93707
el. p. klaipeda@komfovent.com

ŠIAULIAI Metalistų g. 6H, LT-78107
Tel. (8-41) 500090,
mob. tel. +370 685 93700
el. p. siauliai@komfovent.com

PANEVĖŽYS Beržų g. 44, LT-36144
Mob. tel. 8 640 55988
el. p. panevezys@komfovent.com

EXPORT & SALES DEPARTMENT
Ph.: +370 (5) 205 1579, 231 6574
Fax +370 (5) 230 0588
export@komfovent.com

**GARANTINIO APTARNAVIMO SK. /
SERVICE AND SUPPORT**
Tel. / Ph. +370 (5) 200 8000,
mob. tel. / mob. ph.: +370 652 03180
service@komfovent.com

www.komfovent.com

PARTNERS

AT	J. PICHLER Gesellschaft m. b. H.	www.pichlerluft.at
AU	Pacific HVAC	www.pacificvac.com
BE	Ventilair group	www.ventilairgroup.com
	ACB Airconditioning	www.acbairco.be
CZ	REKUVENT s.r.o.	www.rekuvent.cz
CH	WESCO AG	www.wesco.ch
	SUDCLIMATAIR SA	www.sudclimatair.ch
DK	KAPAG Kälte-Wärme AG	www.kapag.ch
	UNIQ COMFORT ApS	www.uniqcomfort.dk
EE	AIR2TRUST	www.air2trust.com
FR	BVT Partners	www.bvtpartners.ee
GB	AERIA	www.aeria-france.fr
HR	ELTA FANS	www.eltafans.com
HU	Microclima	www.microclima.hr
	AIRVENT Légtechnikai Zrt.	www.airvent.hu
IR	Gevent Magyarorszáig Kft.	www.gevent.hu
	Merkapt	www.merkapt.hu
IS	Fantech Ventilation Ltd	www.fantech.ie
	Bliikk & Tækniþjónustan ehf	www.bogt.is
NL	Hitataekni ehf	www.hitataekni.is
	Ventilair group	www.ventilairgroup.com
NO	DECIPOL-Vortvent	www.vortvent.nl
	Ventistål AS	www.ventistal.no
PL	Thermo Control AS	www.thermocontrol.no
	Ventia Sp. z o.o.	www.ventia.pl
SE	Nordisk Ventilator AB	www.nordiskventilator.se
SI	Agregat d.o.o	www.agregat.si
SK	TZB produkt, s.r.o.	www.tzbprodukt.sk

ООО «АМАЛБА-Р»

Россия, Москва
ул. Выборгская д. 16,
стр. 1, 2 этаж, 206 офис
тел./факс +7 495 640 6065,
info@komfovent.ru
www.komfovent.ru

ООО «АМАЛБА-ОКА»

390017 г. Рязань
Рязское шоссе, 20 литера Е, пом Н6
тел. +7 4912 950575, +7 4912 950672,
+7 4912 950648
info@komfovent-oka.ru
www.komfovent.ru

ИООО «Комфoвент»

Республика Беларусь, 220125 г. Минск,
ул. Уручская 21 – 423
Тел. +375 17 266 5297, 266 6327
minsk@komfovent.by
www.komfovent.by

Komfovent AB

Ögärdesvägen 12B
433 30 Partille, Sverige
Phone +46 31 487752
info_se@komfovent.com
www.komfovent.se

Komfovent Oy

Muuntotie 1 C1
FI-01 510 VANTAA
+358 (0) 40 8263 500
info_fi@komfovent.com
www.komfovent.com

Komfovent GmbH

Konrad-Zuse-Str. 2a, 42551 Velbert,
Deutschland
Mob. ph. +49 (0) 2051/6051180
info@komfovent.de
www.komfovent.de

Komfovent SIA

Katlakalna iela 9,
LV-1073 Riga
Tel. +371 67 20 1572
Fakss +371 67 20 1570
info@komfovent.lv
www.komfovent.lv