



Installation Instructions
separately attached



Panasonic®

Operating Instructions
Wired Remote Controller

Model No. **CZ-RTC6BLW**

<https://eu.datanavi.ac.smartcloud.panasonic.com/documents/>

ENGLISH	2 – 14
Before operating the unit, read these Operating Instructions thoroughly and keep them for future reference. This booklet mainly mentions the safety-related regulatory matters. Regarding the contents of the operation, please scan the matrix two-dimensional (2D) barcode and refer to the detailed manuals.	
FRANÇAIS	15 – 17
Avant d'utiliser l'unité, lisez ce mode d'emploi dans son intégralité et conservez-le pour toute référence ultérieure. Ce livret décrit principalement des questions réglementaires et de sécurité. Pour des explications sur le fonctionnement, veuillez scanner le code-barres 2D de la matrice et vous reporter aux manuels détaillés.	
ESPAÑOL	18 – 20
Antes de utilizar la unidad, lea estas Instrucciones de uso atentamente y guárdelas para poder consultarlas en el futuro. En este folleto se describen principalmente las cuestiones relacionadas con la seguridad y reglamentarias. Si desea consultar explicaciones relativas al funcionamiento, escanee el código de barras 2D de matriz y consulte los manuales detallados.	
DEUTSCH	21 – 23
Lesen Sie diese Bedienungsanleitung vor der Inbetriebnahme der Einheit und bewahren Sie sie dann zum späteren Nachschlagen auf. Diese Broschüre beschreibt hauptsächlich sicherheitsrelevante und regulatorische Angelegenheiten. Für Erläuterungen, die den Betrieb betreffen, scannen Sie bitte den Matrix-2D-Barcode und beziehen sich auf die detaillierten Handbücher.	
ITALIANO	24 – 26
Prima di mettere in funzione l'unità, leggere attentamente le presenti istruzioni per l'uso e conservarle per riferimento futuro. Questo opuscolo descrive principalmente argomenti inerenti la sicurezza e normativi. Per le spiegazioni riguardanti il funzionamento, scansionare il codice a barre 2D a matrice e fare riferimento ai manuali dettagliati.	
NEDERLANDS	27 – 29
Lees deze bedieningsinstructies zorgvuldig door voor u de unit gaat gebruiken en bewaar ze zodat u er later nog eens iets in kunt opzoeken. Dit boekwerkje beschrijft voornamelijk zaken die te maken hebben met de veiligheid en met regelgeving. Voor uitleg over de bediening kunt u de matrix 2D-streepjescode scannen en dan de gedetailleerde handleidingen raadplegen.	
PORTUGUÊS	30 – 32
Antes de operar a unidade, leia completamente estas instruções de operação e guarde-as para futuras consultas. Este manual descreve principalmente as questões regulatórias e relacionadas com a segurança. Para as explicações sobre a operação, digitalize o código de barras 2D em matriz e consulte os manuais detalhados.	
TÜRKÇE	33 – 35
Üniteni çalıştırmadan önce bu çalışma talimatlarını dikkatlice okuyun ve daha sonra başvurmak üzere saklayın. Bu kitapçıkta temel olarak güvenlikle ilgili bilgiler ve mevzuat bilgileri açıklanmıştır. Çalıştırma ile ilgili açıklamalar için lütfen matris 2D barkodunu okutun ve ayrıntılı kılavuzlara bakın.	
POLSKI	36 – 38
Przed uruchomieniem urządzenia należy dokładnie przeczytać instrukcję obsługi i zachować ją do wykorzystania w przyszłości. W niniejszej broszurze omówiono głównie kwestie prawne związane z bezpieczeństwem. Jeśli chodzi o treści związane z obsługą, należy zeskanować dwuwymiarowy (2D) kod kreskowy i zapoznać się ze szczegółowymi instrukcjami obsługi.	

ENGLISH

FRANÇAIS

ESPAÑOL

DEUTSCH

ITALIANO

NEDERLANDS

PORTUGUÊS

TÜRKÇE

POLSKI



Panasonic Corporation
1006 Kadoma, Kadoma City, Osaka, Japan

ACXF55-27551
F0820-10920

Thank you for purchasing the Panasonic wired remote controller.

- Read the Operating Instructions carefully for safe use. This manual describes the Operating Instructions of the wired remote controller. Read this manual as well as operating instructions supplied with indoor units and outdoor units.
- **Be sure to read the “Safety precautions” (P.3) before use.**
- **This product is a remote controller that comes equipped with Bluetooth® wireless technology.**
Be sure to read the “General precautions for Bluetooth® functionality” (P.4) before use.
- Keep this manual with operating instructions supplied with indoor units and outdoor units in a safe place.
- Be sure to keep this manual in a place easily accessible by users. In the case of user change, be sure to give this manual to the new user.

■ You can use your mobile device (a smartphone, for example) to control the air conditioner.

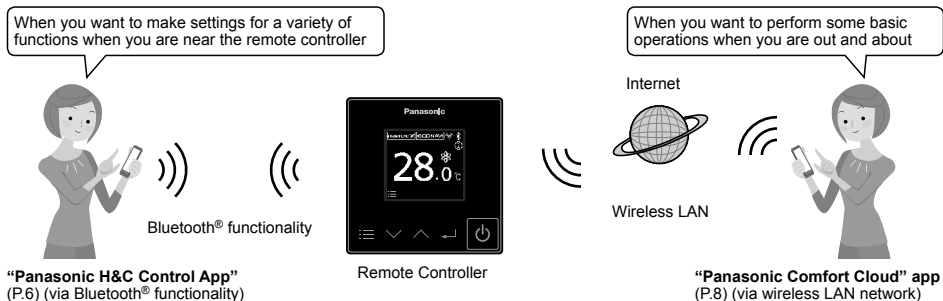

* The Bluetooth® functionality and Wireless LAN functionality cannot be used simultaneously.

NOTICE

The English text is the original instructions. Other languages are translation of the original instructions.

Information for Users on Collection and Disposal of Old Equipment and Used Batteries



These symbols on the products, packaging, and/or accompanying documents mean that used electrical and electronic products and batteries should not be mixed with general household waste. For proper treatment, recovery and recycling of old products and used batteries, please take them to applicable collection points, in accordance with your national legislation and the Directives 2002/96/EC and 2006/66/EC.

By disposing of these products and batteries correctly, you will help to save valuable resources and prevent any potential negative effects on human health and the environment which could otherwise arise from inappropriate waste handling.

For more information about collection and recycling of old products and batteries, please contact your local municipality, your waste disposal service or the point of sale where you purchased the items. Penalties may be applicable for incorrect disposal of this waste, in accordance with national legislation.

For business users in the European Union

If you wish to discard electrical and electronic equipment, please contact your dealer or supplier for further information.

[Information on Disposal in other Countries outside the European Union]

These symbols are only valid in the European Union. If you wish to discard these items, please contact your local authorities or dealer and ask for the correct method of disposal.

Note for the battery symbol (bottom two symbol examples):

This symbol might be used in combination with a chemical symbol. In this case it complies with the requirement set by the Directive for the chemical involved.



Pb



Please scan the matrix two-dimensional (2D) barcode and refer to the detailed manuals.

Contents

Safety precautions	3	Firmware Update Function for Wireless LAN functionality	39
Part names	5	Software License Information (Bluetooth® functionality)	39
Language/Clock	5	Software License Information (Wireless LAN functionality)	40
Bluetooth® settings	6		
Wireless LAN settings	8		
Specifications	14		

Safety precautions



WARNING

This symbol refers to a hazard or unsafe practice which can result in severe personal injury or death.



CAUTION

This symbol refers to a hazard or unsafe practice which can result in personal injury or product or property damage.



Matters to be observed



Prohibited matters



WARNING



Do not use this appliance in a potentially explosive atmosphere.

In case of malfunction of this appliance, do not repair by yourself. Contact the sales or service dealer for repair and disposal.



In case of emergency, remove the power plug from the socket or switch off the circuit breaker or the means by which the system is isolated from the mains power.



CAUTION



This appliance is not intended for use by persons (including children) with reduced physical, sensory or mental capabilities, or lack of experience and knowledge, unless they have been given supervision or instruction concerning use of the appliance by a person responsible for their safety. Children should be supervised to ensure that they do not play with the appliance. <for European market only>

This appliance can be used by children aged from 8 years and above and persons with reduced physical, sensory or mental capabilities or lack of experience and knowledge if they have been given supervision or instruction concerning use of the appliance in a safe way and understand the hazards involved. Children shall not play with the appliance. Cleaning and user maintenance shall not be made by children without supervision.

This equipment is not suitable for use in locations where children are likely to be present.



- Do not operate with wet hands.
- Do not wash with water.

[General precautions for ECONAVI]

⚠ WARNING

- Do not use the ECONAVI function in a room with disabled persons or infants only. Due to their limited motions, the ECONAVI sensor may judge no person is present, causing the indoor unit to stop the operation.

[General precautions for Bluetooth® functionality]

⚠ WARNING

- Do not use the remote controller where pacemaker users may be around. If used, turn off Bluetooth® functionality.
 - Bluetooth® functionality may cause pacemakers to malfunction and lead to an accident.
- Do not use the remote controller near electrical medical devices. If used, turn off Bluetooth® functionality.
 - Bluetooth® functionality may cause these devices to malfunction and lead to an accident.
- Do not use the remote controller near automatic doors, fire alarms, or other automatically controlled devices. If used, turn off Bluetooth® functionality.
 - Bluetooth® functionality may cause these devices to malfunction and lead to an accident.

⚠ CAUTION

- This product is permitted for use only in the country where it was purchased.
- This product uses signals in the 2.4 GHz band.
 - Signals in the 2.4 GHz band are used by medical devices, other similar devices, and nonlicensed amateur radio stations (hereafter referred to as other radio stations).
 - Before using this product, make sure there are no other radio stations in the vicinity.
 - If a radio interference occurs between this product and other radio stations, move the product or stop using the product (turn off Bluetooth® functionality).
 - If problems with radio interference occur, consult the dealer from which the product was purchased.
- Keep an appropriate distance between the product and radio-emitting devices, such as cordless phones, microwave ovens, and wireless LANs, to prevent Bluetooth® interference from these devices that can affect normal operation and performance of the product.
- The following actions may be punishable by law.
 - Disassembling or alteration of this product
 - Removal of certification labels
- The maximum line-of-sight distance of this product is 10 meters. This distance will be shorter when obstacles or people are in the path of radio waves or radio interference from appliances (e.g., microwave ovens) exists.

[General precautions for Wireless LAN functionality]

- The wireless LAN coverage must include the remote controller installation location.
- Please ensure that the router supports WPA2-PSK (TKIP/AES) encryption.
- To complete connection of this remote controller to the wireless network service the router may be required.
- The End user should read and accept the Terms of use and Privacy Notice in the contents of "Panasonic Comfort Cloud" app.
- There is a risk of unauthorised operation if a vulnerable password is set for the wireless router.
- Users are responsible for all costs associated with downloading and using the "Panasonic Comfort Cloud" app and the remote controller, including without limitation all fees charged by your Device carrier and internet service provider and any other wireless LAN or data access charges.
- Panasonic remote controller is designed for communication to the "Panasonic Comfort Cloud" app.
- Third party wireless LAN interfaces cannot be connected to the "Panasonic Comfort Cloud" app.
- Updates to the service may mean there are changes to the design of the "Panasonic Comfort Cloud" app screen and display.

[Precautions for using mobile device application]

- When operating an air conditioner from a remote controller located outside the visibility of the air conditioner, make sure that the operation of the air conditioner will not negatively affect its surroundings or the occupants beforehand.
- When occupants include children, elderly people, people with ailments, or people with disabilities, make sure the product is used in the presence of a capable, supervising adult.
- When one or more people are in a room with an air conditioner, let them know beforehand that the air conditioner is going to be operated from a remote controller located outside the visibility of the air conditioner.
- Children should be supervised or instructed to stay away from the product.
- Poor radio-wave conditions due to an existence of obstacles or radio-emitting devices, such as a microwave oven, in the vicinity of the product can lead to a non-response error. Periodically check the operating conditions of the product.
- Regarding Bluetooth® functionality, the maximum line-of-sight distance of this product is 10 meters. Obstacles in the path of radio waves can shorten this distance. If a problem occurs, remove the obstacles or shorten the distance between this product and the connected device.
- It is recommended to lock the mobile device screen to prevent inadvertent operation of the air-conditioning system.



Declaration of Conformity (DOC)

Hereby, "Panasonic Corporation" declares that this product is in compliance with the essential requirements and other relevant provisions of Directive 2014/53/EU.

The full text of the EU declaration of conformity is available at the following internet address:

<http://www.ptc.panasonic.eu/>

Authorized Representative: Panasonic Testing Centre, Panasonic Marketing Europe GmbH, Winsbergring 15, 22525 Hamburg, Germany

Norway: There are usage restrictions within a radius of 20 km from the centre of Ny-Alesund on Svalbard.

Maximum radio-frequency power transmitted in the frequency bands

Type of wireless	Frequency band	Max EIRP (dBm)
Bluetooth® functionality	2402 - 2480 MHz	6.7 dBm
Wireless LAN functionality	2412 - 2472 MHz	20 dBm

- The Bluetooth® word mark and logos are registered trademarks owned by Bluetooth SIG, Inc. and any use of such marks by Panasonic Corporation is under license. Other trademarks and trade names are those of their respective owners.
- iOS is the name of the OS of Apple Inc. iOS is a trademark or registered trademark of Cisco in the US and other countries which has been licensed for use.
- Apple and the Apple logo are trademarks of Apple Inc. that are registered in the US and other countries. App Store is a service mark of Apple Inc.
- Android™, Google Play™ and Google Play™ logos are registered trademarks of Google LLC.

Part names

Control panel / Top screen

■ When stopped

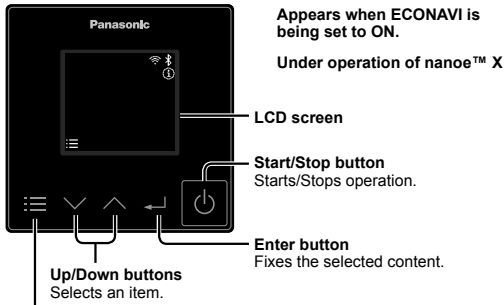

■ When operating

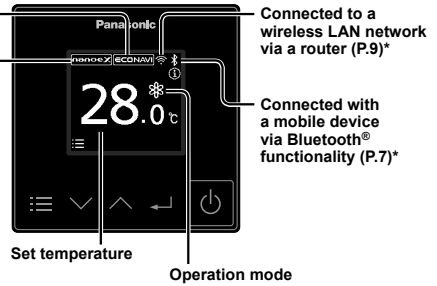

* The Bluetooth® functionality and Wireless LAN functionality cannot be used simultaneously.

Menu button

- When pressed repeatedly during operation, this shows operating status confirmation, set temperature, operation mode, fan speed, flap, and the menu screen.
- When pressed while stopped, the menu screen is displayed.

Note

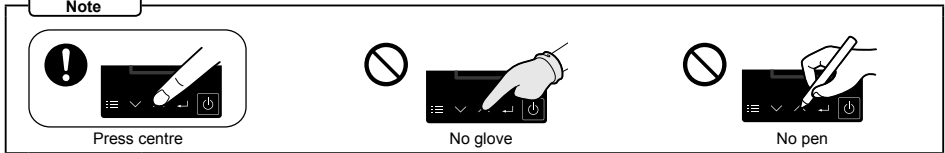

Language/Clock

Steps 1 and 2 are common operations for each item.

1 Display the menu screen.

■ When stopped

Press .

■ When operating

Press repeatedly until the menu screen is displayed.

- To return to the top screen, press .

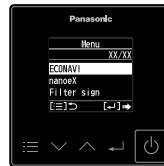

2 Select the item to set.

Press → .



Language

3 Select the language to display from among 7 languages shown on the right.

Press → → .

(Press to finish.)

- Default setting: ENGLISH

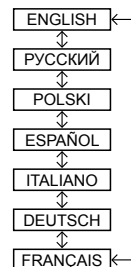

Clock

3 Set the present date and time.

Press → → .
(Repeat) (Press to finish.)

- [-] appears in situations where the clock is reset, such as when power is not supplied to the remote controller for 24 hours or more.

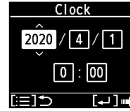

Bluetooth® settings

Before use, confirm the version of the OS on the mobile device and the Bluetooth® version (P.14), and install the “Panasonic H&C Control App” onto the mobile device. In addition, be sure to read the “General precautions for Bluetooth® functionality” (P.4).

Panasonic H&C Control App

You can use the “Panasonic H&C Control App” on your mobile device to operate the air conditioning unit, make detailed settings for functions such as the energy saving function, etc.

■ Functions that can be set with the “Panasonic H&C Control App” (some examples)

- Weekly timer*1
- Energy saving operation On/Off
- Power consumption monitor*2
- Rotation and Backup functions*3

*1 This is not synchronised with the Weekly timer set with the “Panasonic Comfort Cloud” app.

*2 Supported only by models that support the power consumption monitor

*3 Rotation operation is available only when there is a control group of 2 PAC systems (each system being a combination of 1 outdoor unit and 1 indoor unit).

■ Installing the “Panasonic H&C Control App”

For iOS user

- Open App Store.
- Search for “Panasonic H&C Control App”.
- Download and install.

For Android™ user

- Open Google Play.
- Search for “Panasonic H&C Control App”.
- Download and install.

- The “Panasonic H&C Control App” is free, but the communication fees for downloading it and updating it are at the customer’s expense.
- The “Panasonic H&C Control App” screen may change without notice due to updates.
- Functions are not displayed in the “Panasonic H&C Control App” screen if the air conditioner does not support them.
- The screen operations are the same on iOS and Android™. The iOS screen has been used in the examples.

Bluetooth® functionality

1 Display the menu screen.

■ When stopped

Press .

■ When operating

Press repeatedly until the menu screen is displayed.

- To return to the top screen, press .

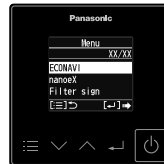

2 Select [Bluetooth].

Press → .



3 Select [Enable/disable].

Press → .



4 Select [Enable].

Press → → .

(Press twice to finish.)

- [Enable] cannot be set for the Bluetooth® functionality and Wireless LAN functionality simultaneously.

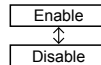
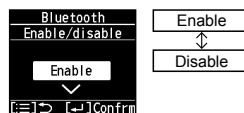

To disable Bluetooth® functionality

1. Start with Step 1 and select [Disable] in Step 4.
2. Press .
3. Press twice to finish.

Connecting with the “Panasonic H&C Control App”

Before connecting, set Bluetooth® functionality to [Enable] on the remote controller. (Step 4 on page 6)
When connecting, try getting the mobile device as close as possible to the remote controller.

1 Start the “Panasonic H&C Control App”.

- Remote controllers in the vicinity are displayed on the Home screen.
- Remote controllers that have been paired have “



2 Select the remote controller you want to operate.

■ Mobile device

Tap “

- If the remote controller is not displayed, slide down to update and the remote controller is detected.

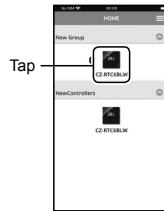

■ When making a Bluetooth® connection for the first time, go to Step 3.

■ For the second and subsequent Bluetooth® connections, go to Step 5.

3 Confirm the numbers on the mobile device match the 6 digits on the remote controller.

- If the numbers do not match, check the remote controller you want to connect again. (Step 2)

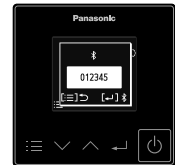

4 Start connecting.

■ Mobile device

Tap “Pair”.

■ Remote controller

Press .

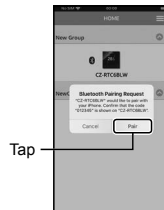

5 Confirm that the Bluetooth® connection is completed.

 is displayed on the top screen when the Bluetooth® connection is established. Once this step is complete, subsequent connections will be made automatically.

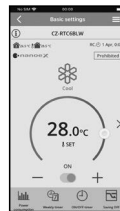

ENGLISH

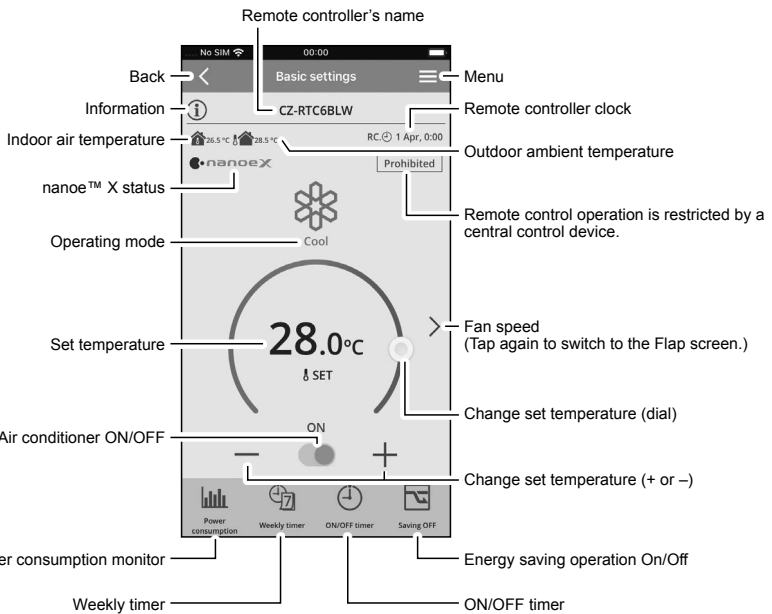

■ datanavi

This unit supports datanavi.
For details on the usage, supporting regions, etc., visit the following URL.
<https://datanavi.ac.smartcloud.panasonic.com/global/>



Wireless LAN settings

Before use, confirm the version of the OS on the mobile device (P.14), and install the "Panasonic Comfort Cloud" app onto the mobile device. In addition, be sure to read the "General precautions for Wireless LAN functionality" (P.4).

"Panasonic Comfort Cloud" app

You can use the "Panasonic Comfort Cloud" app on your mobile device to control the air conditioner when you are out and about.

■ Functions that can be set with the "Panasonic Comfort Cloud" app

- Operation start/stop, Operation mode, Set temperature, Fan speed, Flap
- Weekly timer*¹
- Statistics*²

*¹ This is not synchronised with the Weekly timer set with the "Panasonic H&C Control App".

*² The data for Statistics is collected on and managed by a Panasonic server. The power consumption data in particular may possibly show a difference to the data shown on the "Panasonic H&C Control App".

■ Installing the "Panasonic Comfort Cloud" app

For iOS user

- Open App Store
- Search for "Panasonic Comfort Cloud" app.
- Download and install.

For Android™ user

- Open Google Play
- Search for "Panasonic Comfort Cloud" app.
- Download and install.

- You need to login with your Panasonic ID to use the "Panasonic Comfort Cloud" app. (P.14)
- There is no charge for using the "Panasonic Comfort Cloud" app. However, other charges may be incurred for connection and operation.
- The "Panasonic Comfort Cloud" app screen may change without notice due to updates.
- The screen operations are the same on iOS and Android™.
- The remote controller is available for use with all indoor units of commercial air conditioners released in April 2020 and after (PACI NX series and subsequent series) with names which start with "S-" except S-80/125MW1E5*³.

*³ As of October 2020

Wireless LAN functionality

1 Display the menu screen.

■ When stopped

Press .

■ When operating

Press  repeatedly until the menu screen is displayed.

- To return to the top screen, press .

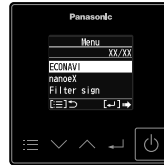

2 Select [WLAN].

Press   → .



3 Select [Enable/disable].

Press   → .

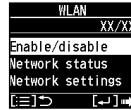

4 Select [Enable].



Press   →  → .

(Press twice to finish.)

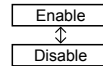
- [Enable] cannot be set for the Bluetooth® functionality and Wireless LAN functionality simultaneously.



To disable Wireless LAN functionality

1. Start with Step 1 and select [Disable] in Step 4.
2. Press .
3. Press  twice to finish.

Note

- Depending on the type of indoor unit, the display shown on the right may appear.



Connecting network

At first, set Wireless LAN functionality to [Enable]. (P.9)
Establish network connection to the internet via Wireless mode.

■ Before setting

- Confirm the wireless router is connected to the network and the router has access to the internet.
- Confirm the Wireless LAN of the mobile device is activated.
- Mobile device and air conditioner should be connected to the same wireless LAN.
- Ensure Wireless LAN is broadcasting SSID.

■ Setting flow

You will need to operate both the remote controller and the "Panasonic Comfort Cloud" app to perform these settings.

- ① Start the "Panasonic Comfort Cloud" app (Step 1)
- ② Connect wirelessly with a router (Step 2 - Step 5)
- ③ Register the information for the air conditioner on the server (Step 6 - Step 7)

< ① Start the "Panasonic Comfort Cloud" app >

1 Start the "Panasonic Comfort Cloud" app and login.

- If you do not have a Panasonic ID, create one and then login. (Refer to "To create new Panasonic ID" (P.14) for details.)

■ Mobile device

Enter the information required for login and tap "Login".

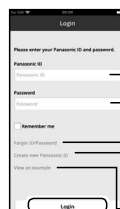

- Panasonic ID
- Password
- Reset Panasonic ID / Password
- Register for new Panasonic ID (P.14)
- Start a demonstration

< ② Connect wirelessly with a router >

2 Add new air conditioner device.

- The air conditioner needs to be registered before using "Panasonic Comfort Cloud" app.

1. At My Home screen, tap "+" to add new product.

■ Mobile device

Tap "+".



2. Select the "Commercial air conditioner" and choose the "Wired Remote controller".

■ Mobile device

Tap "Commercial air conditioner".

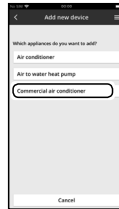

Tap "Wired Remote controller".



3. Tap "Start" to begin the connection setup.

■ Mobile device

Tap "Start".

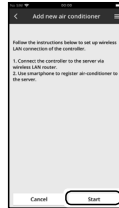

Then, tap "Newly purchased air-conditioner".

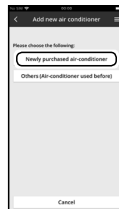

3 Make the settings for network connection.

1. After confirming that the Wireless LAN functionality on the remote controller is set to [Enable] (P.9), tap “Next”.

- Remote controller

Follow the instructions on the app screen.

- Mobile device

Tap “Next”.

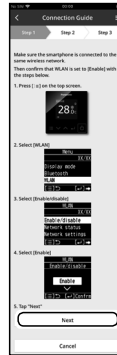

2. Select the option that matches the status displayed on the remote controller screen.

- Remote controller

Follow the instructions on the app screen.

- Mobile device

Tap to select the option.

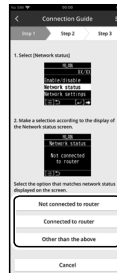

3. Select the preferred router support connectivity mode.

- Mobile device

Tap to select the option.

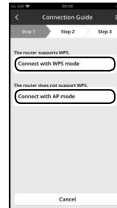

Refer to your router’s operating instructions and proceed as follows.

- If the router supports the WPS mode, go to Step 4.

- If the router does not support the WPS mode, or if you do not know whether it supports the mode, go to Step 5.

4 Connect to the network using WPS mode.

1. Press the WPS button on the router to establish connection.
2. Tap “Next” after the router is ready for connection.

- Mobile device

Tap “Next”.



3. Make the remote controller operate in Auto mode.

■ Remote controller

Follow the instructions on the app screen.

■ Mobile device

Confirm that “Operating in Auto mode” is displayed then tap “Next”.



4. When the network connection to the router is successful, “Connected to router” is displayed on the remote controller screen.

- It may take some minutes for the connection to be established.

■ Mobile device

Tap “Next”.



Note

- If the remote controller screen does not change to “Connected to router”, check the wireless LAN router connections.

■ This completes the settings for connecting to the router. Go to Step 6 to continue making the settings.

5 Connect to the network using AP mode. (For iOS 11.0 or later and Android™ 4.4 or later only)

1. Make the remote controller operate in Manual mode.

■ Remote controller

Follow the instructions on the app screen.

■ Mobile device

Confirm that “Operating in Manual mode” is displayed, then tap “Next”.

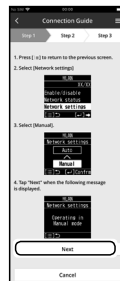

2. Join to connect to the “Panasonic-CZ-C-wirelessAP” network.

■ Mobile device

(First time only)

Tap “Allow While Using App”. Then, tap “Join”.

(Subsequent connections)

Tap “Join”.



3. Enter the password of the selected wireless router and continue.

■ Mobile device

Enter the password, then tap "OK".

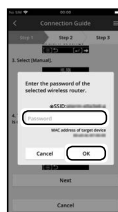

4. When the network connection to the router is successful, "Connected to router" is displayed on the remote controller screen.

- It may take some minutes for the connection to be established.

■ Mobile device

Tap "Next". Then, tap "Join".



Note

- If "Connected to router" is displayed on the remote controller, connect the mobile device to wireless router. (return to this application after completing the wireless network settings to continue the setup)
- If the remote controller screen does not change to "Connected to router", check the wireless LAN router connections.

■ This completes the settings for connecting to the router. Go to Step 6 to continue making the settings.

< ③ Register the information for the air conditioner on the server >

6 Select the air conditioner and set the password.

1. Select the air conditioner model to register the device.

■ Mobile device

Tap the indoor unit model number to register. Then, tap "Register".



2. Make the remote controller operate in registration mode.

■ Remote controller

Follow the instructions on the app screen.

■ Mobile device

Tap "Next".

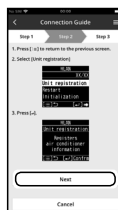

3. Set a password for new air conditioner model to complete the registration. Password must be between 8-15 characters with letters and numbers.

■ Mobile device

Tap and enter the password. Then, tap "Register".



Note

- Keep the password for future use with additional user registrations.

7 Complete registration.

Once connection is established between the app and the new air conditioner, set a preferred name for this air conditioner to help identify it.

- By registering the new name of air conditioner, the function of "Panasonic Comfort Cloud" app is ready to be used.

■ Mobile device

Tap and enter the name. Then, tap "Register".

■ Remote controller

Press .

(Press twice to finish.)

- In addition to operation control, this application can monitor the estimated energy consumption and perform comparisons for different time frames by referring to the statistic's graph.



 is displayed on the top screen of the remote controller when network settings are completed.

The network information and air conditioner information are saved in the Wireless LAN module, so even if the power of the remote controller is lost due to a power failure, the connection with the network is automatically re-established using the saved information when power is restored.

Note

- Confirm the "Panasonic Comfort Cloud" app's screen connectivity status before or during operation, if the status is not reflected, use in-house remote controller to operate.

■ To create new Panasonic ID

If you do not have a Panasonic ID, create one and then login.

Use "Panasonic Comfort Cloud" app as an option to control the air conditioner.

- For new user, select "Create new Panasonic ID" to register. Password must be 8-16 characters with letters and numbers. You can input the following characters. (As of October 2020)

Numeric characters	0123456789
Alphabetical characters (upper and lower cases)	ABCDEFGHIJKLMN OPQRSTUVWXYZ abcdefghijklmnopqrstuvwxyz
Symbols	~!@#\$%^&*()-_+={}

- For registered user, login using your Panasonic ID and password.

Note

- It is recommended that the password be changed periodically.



Specifications

Model No.	CZ-RTC6BLW	
Dimensions	(H) 86 mm x (W) 86 mm x (D) 25 mm	
Weight	0.10 kg	
Temperature/Humidity range	0 °C to 40 °C / 20% to 80% (No condensation) * Indoor use only.	
Power Source	DC16 V (supplied from indoor unit)	
Clock	Precision	± 30 seconds/month (at normal temperature 25 °C) * Adjust periodically.
	Holding time	24 hours (When fully charged) (at normal temperature 25 °C) * Approx. 8 hours are required for full charge.
Number of connected indoor units	Indoor unit: Up to 8 units (Within group-controlling)	
OS version on the mobile device for "Panasonic H&C Control App"	iOS: 10.0 or later Android™: 6.0 or later	
Bluetooth® version	4.2 or later	
Wireless LAN standard	IEEE 802.11 b/g/n	
Frequency range	2.4 GHz band	
Encryption	WPA2-PSK (TKIP/AES)	
OS version on the mobile device for "Panasonic Comfort Cloud" app	iOS: 9.0 or later Android™: 4.4 or later	



Veuillez scanner le code-barres 2D de la matrice et vous reporter aux manuels détaillés.

Table des Matieres

Consignes de sécurité	15	Software License Information	
Spécifications	17	(Bluetooth® functionality)	39
Firmware Update Function for Wireless LAN functionality	39	Software License Information	
		(Wireless LAN functionality).....	40

Consignes de sécurité



AVERTISSEMENT

Signale un danger ou une pratique dangereuse susceptible de blesser gravement ou mortellement.



MISE EN GARDE

Signale un danger ou une pratique dangereuse susceptible de blesser ou d'endommager le matériel.



Points à observer



Actions interdites



AVERTISSEMENT



Ne pas installer l'appareil dans un milieu où pourraient se trouver des substances explosives.

En cas de dysfonctionnement de l'appareil, ne le réparez pas vous-même. Contactez les points de vente ou les services d'entretien pour la réparation et la dépose.



En cas d'urgence, enlevez la fiche d'alimentation de la prise ou coupez le disjoncteur ou les moyens par lesquels le système est isolé du secteur électrique.



MISE EN GARDE



Cet appareil n'est pas conçu pour être utilisé par des personnes (y compris les enfants) aux capacités physiques, sensorielles ou mentales diminuées, ou manquant d'expérience ou de connaissances, sauf si une personne responsable de leur sécurité leur a expliqué le fonctionnement de l'appareil et les garde sous surveillance. Les enfants doivent être supervisés afin qu'ils ne jouent pas avec l'appareil.

<Uniquement pour le marché européen>

Cet appareil peut être utilisé par des enfants âgés de plus de 8 ans et par des personnes ayant des capacités physiques, sensorielles ou mentales réduites ou ayant un manque d'expérience ou de connaissance si elles sont sous la surveillance d'un tiers ou ont appris à utiliser l'appareil en toute sécurité et si elles ont compris les dangers inhérents. Les enfants ne devront pas jouer avec cet appareil. Le nettoyage et l'entretien par l'utilisateur ne devra pas être effectué par des enfants sans surveillance.

Cet équipement n'est pas adapté pour être utilisé dans des lieux où les enfants sont susceptibles d'être présents.



- Ne pas utiliser avec les mains mouillées.
- Ne pas laver à l'eau.

NOTIFICATION

Le texte anglais correspond aux instructions d'origine. Les autres langues sont les traductions des instructions d'origine.

[Précautions générales pour ECONAVI]

⚠ AVERTISSEMENT

- N'utilisez pas la fonction ECONAVI dans une pièce où seuls des personnes à mobilité réduite ou des nourrissons sont présents. En raison de leurs mouvements limités, le capteur ECONAVI risque de ne pas les détecter et causer l'arrêt de l'unité intérieure.

[Précautions générales pour la fonctionnalité Bluetooth®]

⚠ AVERTISSEMENT

- Ne pas utiliser la télécommande si des possesseurs de pacemaker se trouvent aux alentours. Si c'est le cas, désactiver la fonctionnalité Bluetooth®.
 - La fonctionnalité Bluetooth® peut provoquer des dysfonctionnements du stimulateur cardiaque et conduire à un accident.
- Ne pas utiliser la télécommande près de dispositifs médicaux électriques. Si c'est le cas, désactiver la fonctionnalité Bluetooth®.
 - La fonctionnalité Bluetooth® peut provoquer des dysfonctionnements de ces dispositifs et conduire à un accident.
- Ne pas utiliser la télécommande près de portes automatiques, d'alarmes incendie ou d'autres dispositifs contrôlés automatiquement. Si c'est le cas, désactiver la fonctionnalité Bluetooth®.
 - La fonctionnalité Bluetooth® peut provoquer des dysfonctionnements de ces dispositifs et conduire à un accident.

⚠ MISE EN GARDE

- L'utilisation de ce produit est autorisée uniquement dans le pays où il a été acheté.
- Ce produit utilise des signaux dans la bande des 2,4 GHz.
 - Les signaux de la bande des 2,4 GHz sont utilisés par des dispositifs médicaux, d'autres dispositifs similaires et des stations radioamateurs non déclarées (dénommées ci-après autres stations de radio).
 1. Avant d'utiliser ce produit, assurez-vous qu'aucune autre station de radio ne se trouve à proximité.
 2. Si des interférences radio se produisent entre ce produit et d'autres stations de radio, déplacez celui-ci ou arrêtez-le (désactivez la fonctionnalité Bluetooth®).
 3. Si des problèmes liés à des interférences radio se produisent, veuillez contacter le revendeur auprès duquel vous avez acheté le produit.
- Veuillez conserver une distance adéquate entre le produit et les appareils émetteurs de radiofréquences tels que les téléphones sans fil, les fours à micro-ondes et les réseaux sans fil afin d'empêcher toute interférence Bluetooth® provoquée par ces appareils pouvant perturber le fonctionnement normal et affecter les performances du produit.
- Les activités suivantes peuvent être sanctionnées par la loi.
 - Démontage ou altération du produit
 - Retrait des étiquettes de certification
- La portée maximale en ligne directe du produit est de 10 mètres. Cette portée sera réduite par la présence d'obstacles ou de personnes sur le trajet des ondes radio ou par des interférences provoquées par certains dispositifs (p. ex. fours à micro-ondes).

[Précautions générales concernant la fonctionnalité du réseau local (LAN) sans fil]

- La couverture du réseau LAN sans fil doit inclure le lieu d'installation de la télécommande.
- S'assurer que le routeur prend en charge le chiffrement WPA2-PSK (TKIP/AES).
- Pour terminer la connexion de cette télécommande au service du réseau sans fil, le routeur pourrait être nécessaire.
- L'utilisateur final doit lire et accepter les conditions d'utilisation et la déclaration de confidentialité du contenu de l'appli « Panasonic Comfort Cloud ».
- Il existe un risque d'utilisation non autorisée si un mot de passe vulnérable est défini pour le routeur sans fil.
- Les utilisateurs sont responsables de tous les coûts engendrés par le téléchargement et l'utilisation de l'application « Panasonic Comfort Cloud » et de la télécommande, incluant sans limitation les frais facturés par l'opérateur mobile et le fournisseur de service Internet ainsi que de tout autre frais d'accès au réseau LAN sans fil ou aux données.
- La télécommande Panasonic est conçue pour communiquer avec l'application « Panasonic Comfort Cloud ».
- Les interfaces du réseau LAN sans fil tierces ne peuvent pas être connectées à l'application « Panasonic Comfort Cloud ».
- Les mises à jour du service peuvent signifier des changements dans la conception de l'écran et de l'affichage de l'appli « Panasonic Comfort Cloud ».

[Précautions pour utiliser l'application de l'appareil mobile]

- En actionnant un climatiseur à partir d'une télécommande située en dehors du champ de visibilité de celui-ci, assurez-vous préalablement que le fonctionnement du climatiseur ne nuira ni à l'environnement ni aux occupants.
- Si des enfants, des personnes âgées, handicapées ou des personnes souffrant de maladies font partie des occupants, assurez-vous de la présence d'un adulte apte à surveiller l'utilisation du produit.
- Si une ou plusieurs personnes se trouvent dans une pièce équipée d'un climatiseur, informez-les au préalable que le climatiseur sera utilisé depuis une télécommande située en dehors du champ de visibilité de celui-ci.
- Les enfants doivent rester à l'écart du produit ou être accompagnés d'une personne majeure et responsable.
- De mauvaises conditions de transmission d'ondes radio inhérentes à la présence envahissante d'obstacles ou d'appareils émetteurs de radiofréquences tels qu'un four à micro-ondes peuvent provoquer une erreur de non-réponse. Veuillez vérifier périodiquement les conditions de fonctionnement du produit.
- Concernant la fonctionnalité Bluetooth®, la portée maximale en ligne directe de ce produit est de 10 mètres. Les obstacles se trouvant sur le trajet des ondes radio peuvent réduire cette portée. Si vous rencontrez un problème, éloignez les obstacles ou réduisez la distance entre le produit et le dispositif connecté.
- Il est recommandé de verrouiller l'écran de l'appareil mobile pour éviter l'actionnement involontaire du système de climatisation.



Déclaration de conformité (DdC)

Par les présentes, « Panasonic Corporation » déclare que ce produit est conforme aux exigences fondamentales et autres dispositions pertinentes de la Directive 2014/53/UE.

Le texte intégral de la déclaration de conformité UE est disponible à l'adresse Internet suivante : <http://www.ptc.panasonic.eu/>

Représentant autorisé : Panasonic Testing Centre, Panasonic Marketing Europe GmbH, Winsbergring 15, 22525 Hambourg, Allemagne

Norvège : Des restrictions d'utilisation existent dans un rayon de 20 km autour du centre de Ny-Alesund, dans le Svalbard.

Spécifications

Modèle n°	CZ-RTC6BLW	
Dimensions	(H) 86 mm x (L) 86 mm x (P) 25 mm	
Poids	0,10 kg	
Plage de Température/Humidité	0 °C à 40 °C / 20% à 80% (pas de condensation) * Usage intérieur uniquement.	
Source d'alimentation	16 Vcc (fourni par l'unité intérieure)	
Horloge	Précision	± 30 secondes/mois (à une température normale de 25 °C) * Ajustez-la périodiquement.
	Autonomie	24 heures (après un chargement complet) (à une température normale de 25 °C) * Env. 8 heures sont nécessaires pour une recharge complète.
Nombre d'unités intérieures connectées	Unité intérieure : 8 appareils maximum (Dans le contrôle de groupe)	
Version du système d'exploitation de l'appareil mobile pour « Panasonic H&C Control App »	iOS : 10.0 ou ultérieure Android™ : 6.0 ou ultérieure	
Version Bluetooth®	4.2 ou ultérieure	
Norme LAN sans fil	IEEE 802.11 b/g/n	
Plage de fréquences	Bande 2,4 GHz	
Chiffrement	WPA2-PSK (TKIP/AES)	
Version du système d'exploitation de l'appareil mobile pour l'application « Panasonic Comfort Cloud »	iOS : 9.0 ou ultérieure Android™ : 4.4 ou ultérieure	

- Le nom de la marque Bluetooth® ainsi que les logos sont des marques déposées appartenant à Bluetooth SIG, Inc. et toute utilisation de ces marques par Panasonic Corporation est effectuée sous licence. Les autres marques et noms commerciaux appartiennent à leurs propriétaires respectifs.
- iOS est le nom du système d'exploitation d'Apple Inc. IOS est une marque ou marque déposée de Cisco aux États-Unis et dans d'autres pays qui fait l'objet d'une licence d'utilisation.
- Apple et le logo Apple sont des marques d'Apple Inc., déposées aux États-Unis et dans d'autres pays. App Store est une marque de service d'Apple Inc.
- Android™, Google Play™ et les logos Google Play™ sont des marques déposées de Google LLC.

Puissance maximale de la fréquence radio envoyée sur les bandes de fréquence

Type de communication sans fil	Bande de fréquence	PIRE max (dBm)
Fonctionnalité Bluetooth®	2402 - 2480 MHz	6,7 dBm
Fonctionnalité du réseau local (LAN) sans fil	2412 - 2472 MHz	20 dBm

Avis aux utilisateurs concernant la collecte et l'élimination des piles et des appareils électriques et électroniques usagés



Apposé sur le produit lui-même, sur son emballage, et/ou figurant dans la documentation qui l'accompagne, ce pictogramme indique que les piles et appareils électriques et électroniques usagés doivent être séparés des ordures ménagères. Afin de permettre le traitement, la valorisation et le recyclage adéquats des piles et des appareils usagés, veuillez les porter à l'un des points de collecte prévus, conformément à la législation nationale en vigueur ainsi qu'aux directives 2002/96/CE et 2006/66/CE.

En éliminant piles et appareils usagés conformément à la réglementation en vigueur, vous contribuez à prévenir le gaspillage de ressources précieuses ainsi qu'à protéger la santé humaine et l'environnement contre les effets potentiellement nocifs d'une manipulation inappropriée des déchets. Pour de plus amples renseignements sur la collecte et le recyclage des piles et appareils usagés, veuillez vous renseigner auprès de votre mairie, du service municipal d'enlèvement des déchets ou du point de vente où vous avez acheté les articles concernés.

Le non-respect de la réglementation relative à l'élimination des déchets est passible d'une peine d'amende.

Pour les utilisateurs professionnels au sein de l'Union européenne

Si vous souhaitez vous défaire de pièces d'équipement électrique ou électronique, veuillez vous renseigner directement auprès de votre détaillant ou de votre fournisseur.

[Information relative à l'élimination des déchets dans les pays extérieurs à l'Union européenne]

Ce pictogramme n'est valide qu'à l'intérieur de l'Union européenne. Pour connaître la procédure applicable dans les pays hors Union européenne, veuillez vous renseigner auprès des autorités locales compétentes ou de votre distributeur.



Note for the battery symbol (bottom two symbol examples):

This symbol might be used in combination with a chemical symbol. In this case it complies with the requirement set by the Directive for the chemical involved.



Pb



Escanee el código de barras 2D de matriz y consulte los manuales detallados.

Contenido

Precauciones de seguridad.....	18	Software License Information	
Especificaciones	20	(Bluetooth® functionality)	39
Firmware Update Function for Wireless LAN		Software License Information	
functionality	39	(Wireless LAN functionality).....	40

Precauciones de seguridad



ADVERTENCIA

Este símbolo hace referencia a un peligro o práctica no segura que pueden producir daños personales graves o, incluso, la muerte.



PRECAUCIÓN

Este símbolo hace referencia a un peligro o práctica no segura que pueden producir daños personales, en los productos o en la propiedad.



Elementos que deben observarse



Elementos prohibidos



ADVERTENCIA



No utilice este aparato en un entorno potencialmente explosivo.

Si el aparato no funciona correctamente, no intente repararlo usted mismo. Póngase en contacto con el vendedor o el servicio técnico para reparar o desechar la unidad.



En caso de emergencia, retire el enchufe de alimentación de la toma o apague el disyuntor del circuito o el medio mediante el cual el sistema queda aislado de la red eléctrica.



PRECAUCIÓN



Este aparato no debe ser utilizado por personas (incluyendo niños) con discapacidades mentales, sensoriales o físicas, o falta de experiencia y conocimiento, a menos que hayan recibido formación o supervisión en relación al uso del aparato por una persona responsable por su seguridad. Los niños deberían estar supervisados para asegurar que no juegan con el aparato.

<para el mercado europeo solo>

Este aparato puede ser utilizado por niños a partir de 8 años y por personas con capacidades físicas, sensoriales o mentales reducidas o con falta de experiencia y conocimientos, siempre que sean supervisados o hayan sido instruidos en el uso del aparato de forma segura y comprendan los peligros que conlleva. Los niños no deben jugar con el aparato. Los niños no deben realizar la limpieza y el mantenimiento de usuario sin supervisión.

Este equipo no es adecuado para su uso en lugares donde es probable que haya niños presentes.



- No utilizar con las manos mojadas.
- No lavar con agua.

AVISO

[Precauciones generales para ECONAVI]

⚠ ADVERTENCIA

- No utilice la función ECONAVI en una sala en la que se encuentren únicamente bebés o personas con alguna discapacidad. Debido a la limitación de movimiento, el sensor ECONAVI puede valorar que no hay nadie en la sala, ocasionando que la unidad interior deje de funcionar.

[Precauciones generales para la funcionalidad Bluetooth®]

⚠ ADVERTENCIA

- No utilice el mando a distancia donde haya usuarios con marcapasos. Si se utilizase, desactivar la funcionalidad Bluetooth®.
 - La funcionalidad Bluetooth® podría provocar el mal funcionamiento de los marcapasos con posible resultado de accidente.
- No utilice el mando a distancia cerca de dispositivos médicos eléctricos. Si se utilizase, desactivar la funcionalidad Bluetooth®.
 - La funcionalidad Bluetooth® podría provocar el mal funcionamiento de dichos dispositivos con posible resultado de accidente.
- No utilice el mando a distancia cerca de puertas automáticas, alarmas de incendios u otros dispositivos controlados automáticamente. Si se utilizase, desactivar la funcionalidad Bluetooth®.
 - La funcionalidad Bluetooth® podría provocar el mal funcionamiento de dichos dispositivos con posible resultado de accidente.

⚠ PRECAUCIÓN

- Este producto solo se puede usar en el país donde se adquirió.
- Este producto usa señales en la banda de los 2,4 GHz.
 - Las señales en la banda de los 2,4 GHz se usan también en dispositivos médicos, otros dispositivos similares y estaciones de radioaficionados sin licencia (a partir de ahora denominadas "otras estaciones de radio").
 1. Antes de usar este producto, asegúrese de que no haya otras estaciones de radio en las proximidades.
 2. Si se produce una interferencia de radio entre este producto y otras estaciones de radio, cambie la ubicación del producto o deje de usarlo (desactive la funcionalidad Bluetooth®).
 3. Si surgen problemas de interferencias de radio, consulte al distribuidor donde adquirió el producto.
- Guarde una distancia adecuada entre el producto y dispositivos emisores de ondas de radio tales como auriculares inalámbricos, hornos microondas o redes de área local inalámbricas, con el fin de evitar que dichos dispositivos provoquen interferencias con Bluetooth® que pudieran afectar al normal funcionamiento y al rendimiento del producto.
- Las siguientes acciones pueden ser sancionables por ley.
 - Desmontaje o alteración del producto
 - Retirada de las etiquetas de certificación
- El radio de alcance máximo de este producto es de 10 metros. Esta distancia será inferior si hay obstáculos (incluidas personas) en la trayectoria de las ondas de radio o bien interferencias de radio provocadas por aparatos tales como hornos microondas.

[Precauciones generales para la funcionalidad de LAN inalámbrica]

- La cobertura de la LAN inalámbrica debe incluir el lugar de instalación del mando a distancia.
- Asegúrese de que el enrutador es compatible con el cifrado WPA2-PSK (TKIP/AES).
- Para completar la conexión de este mando a distancia al servicio de red inalámbrica, puede que sea necesario el enrutador.
- El usuario final debe leer y aceptar las Condiciones de uso y el Aviso de privacidad en el contenido de la aplicación "Panasonic Comfort Cloud".
- Existe riesgo de funcionamiento no autorizado si se establece una contraseña vulnerable para el enrutador inalámbrico.
- Los usuarios son responsables de todos los costes asociados con la descarga y el uso de la aplicación "Panasonic Comfort Cloud" y el mando a distancia, incluyendo, sin limitación, todas las tarifas cobradas por su proveedor de servicios de Internet y su compañía telefónica y cualquier otra tarifa de acceso a datos o LAN inalámbrica.
- El mando a distancia de Panasonic está diseñado para la comunicación con la aplicación "Panasonic Comfort Cloud".
- Las interfaces para LAN inalámbrica de terceros no se pueden conectar a la aplicación "Panasonic Comfort Cloud".
- Las actualizaciones del servicio pueden significar cambios en el diseño de la pantalla de la aplicación "Panasonic Comfort Cloud" y en la pantalla.

[Precauciones para el uso de aplicaciones de dispositivos móviles]

- Cuando opere un acondicionador de aire desde un mando a distancia situado fuera de la visibilidad del acondicionador de aire, asegúrese de antemano de que el funcionamiento del acondicionador de aire no afecte negativamente a su entorno o a los ocupantes.
- Cuando entre los ocupantes haya niños, ancianos o personas enfermas o con discapacidades, asegúrese de que un adulto capaz supervise el funcionamiento del producto.
- Cuando una o más personas estén en una habitación con un acondicionador de aire, hágalas saber de antemano que se va a operar el acondicionador de aire desde un mando a distancia situado fuera de la visibilidad del acondicionador de aire.
- Los niños deben estar supervisados o instruidos para mantenerse alejados del producto.
- La mala propagación de las ondas de radio debido a la presencia en las proximidades del producto de obstáculos u otros dispositivos emisores de ondas de radio tales como hornos microondas pueden provocar un error de ausencia de respuesta. Compruebe regularmente las condiciones de funcionamiento del producto.
- En cuanto a la funcionalidad Bluetooth®, el radio de alcance máximo de este producto es de 10 metros. Los obstáculos en la trayectoria de las ondas de radio pueden acortar esta distancia. Si se produce un problema, retire los obstáculos o acorte la distancia entre el producto y el dispositivo conectado.
- Se recomienda bloquear la pantalla del dispositivo móvil para evitar el funcionamiento involuntario del sistema de aire acondicionado.



Declaración de conformidad (DOC)

Por el presente, "Panasonic Corporation" declara que este producto cumple con los requisitos esenciales y demás disposiciones relevantes de la Directiva 2014/53/EU.

El texto completo de la declaración de conformidad de la UE está disponible en la siguiente dirección de Internet:

<http://www.ptc.panasonic.eu/>

Representante autorizado: Panasonic Testing Centre, Panasonic Marketing Europe GmbH, Winsbergring 15, 22525 Hamburgo, Alemania

Noruega: Existen restricciones de uso en un radio de 20 km desde el centro de Ny-Alesund en Svalbard.

Especificaciones

N.º de modelo		CZ-RTC6BL
Dimensiones		(Al.) 86 mm x (An.) 86 mm x (Prof.) 25 mm
Peso		0,09 kg
Temperatura/Rango de humedad		0 °C a 40 °C / 20% a 80% (sin condensación) * Solo para uso interior.
Fuente de alimentación		16 V CC (suministrada desde la unidad interior)
Reloj	Precisión	± 30 segundos/mes (a una temperatura normal de 25 °C) * Ajustar periódicamente.
	Tiempo de espera	24 horas (cuando está totalmente cargado) (a una temperatura normal de 25 °C) * La carga completa requiere aprox. 8 horas.
Número de unidades interiores conectadas		Unidad interior: Hasta 8 unidades (Dentro del control de grupo)
Versión del sistema operativo del dispositivo móvil para "Panasonic H&C Control App"		iOS: 10.0 o posterior Android™: 6.0 o posterior
Versión de Bluetooth®		4.2 o posterior
LAN inalámbrica estándar		Instituto de Ingeniería Eléctrica y Electrónica (IEEE) 802,11 b/g/n
Rango de frecuencia		Banda de 2,4 GHz
Cifrado		WPA2-PSK (TKIP/AES)
Versión del sistema operativo del dispositivo móvil para la aplicación "Panasonic Comfort Cloud"		iOS: 9.0 o posterior Android™: 4.4 o posterior

- La marca denominativa Bluetooth® y sus logos son marcas comerciales registradas de Bluetooth SIG, Inc. y cualquier uso de dichas marcas por parte de Panasonic Corporation se realiza bajo licencia. Otros nombres de marcas y marcas comerciales son propiedad de sus respectivos propietarios.
- iOS es el nombre del sistema operativo de Apple Inc. IOS es una marca comercial o marca comercial registrada de Cisco en los Estados Unidos y otros países que han adquirido licencia para su uso.
- Apple y el logotipo de Apple son marcas comerciales de Apple Inc. que están registradas en los Estados Unidos y otros países. App Store es una marca de servicio de Apple Inc.
- Android™, Google Play™ y los logotipos de Google Play™ son marcas comerciales registradas de Google LLC.

Potencia máxima de radiofrecuencia transmitida en las bandas de frecuencia

Tipo de conexión inalámbrica	Banda de frecuencia	PIRE máx. (dBm)
Funcionalidad Bluetooth®	2402 - 2480 MHz	6,7 dBm
Funcionalidad de LAN inalámbrica	2412 - 2472 MHz	20 dBm

Información para los usuarios relativa a la recopilación y eliminación de equipos y pilas usados



Estos símbolos en los productos, embalajes y/o documentos adjuntos, significan que los aparatos eléctricos y electrónicos y las baterías no deberían ser mezclados con los desechos domésticos. Para un tratamiento, una recuperación y un reciclaje adecuados de los productos usados y de las pilas gastadas, llévelos a los puntos de recogida correspondientes, según la normativa de su país y las Directivas 2002/96/EC y 2006/66/EC.

Al deshacerse de estos productos y de estas pilas correctamente estará ayudando a ahorrar valiosos recursos y a evitar posibles efectos negativos para la salud humana y para el medio ambiente. La manipulación inadecuada de estos residuos podría provocar situaciones perniciosas.

Si desea obtener más información sobre la recopilación y el reciclaje de productos usados y de pilas gastadas, póngase en contacto con el ayuntamiento, con el servicio de recogida de basuras o con el punto de venta en el que compró los productos en cuestión.

El desechado incorrecto de estos residuos podría suponer la aplicación de multas según la normativa vigente.

Para usuarios empresariales de la Unión Europea

Si desea deshacerse de productos eléctricos y electrónicos, póngase en contacto con su distribuidor o proveedor para obtener más información.

[Información de desechado en otros países fuera de la Unión Europea]

Estos símbolos son válidos únicamente en la Unión Europea. Si desea deshacerse de estos productos, póngase en contacto con las autoridades locales o con su distribuidor y pregunte cuál es el método de desechado correcto.



Nota para el símbolo de batería (ejemplos de dos símbolos de la parte inferior):

Este símbolo podría utilizarse en combinación con un símbolo de producto químico. En este caso cumple con los requisitos impuestos por la Directiva en relación al producto químico en cuestión.



Pb



Scannen Sie bitte den Matrix-2D-Barcode und beziehen sich auf die detaillierten Handbücher.

Inhalt

Sicherheitshinweise.....	21	Software License Information (Bluetooth® functionality)	39
Technische Daten	23	Software License Information (Wireless LAN functionality)	40
Firmware Update Function for Wireless LAN functionality	39		

Sicherheitshinweise



VORSICHT

Dieses Symbol warnt vor einer gefährlichen Situation, bei der die Nichtbeachtung des Sicherheitshinweises zu schweren Verletzungen oder gar zum Tod führen kann.



ACHTUNG

Dieses Symbol warnt vor einer gefährlichen Situation, bei der die Nichtbeachtung des Sicherheitshinweises zu Verletzungen oder zu Produkt- und Sachschäden führen kann.



Zu beachten



Zu unterlassen



VORSICHT



Das Gerät darf nicht an Orten installiert werden, wo brennbare oder explosive Gase entweichen können.

Im Fall von Störungen an diesem Geräts, führen Sie auf keinen Fall Reparaturen selbst aus! Für Reparaturen und Entsorgung wenden Sie sich an den Händler oder Kundendienst.



Im Notfall ist die Stromzufuhr zum Gerät wie folgt zu unterbrechen: Ziehen Sie den Netzstecker aus der Steckdose oder betätigen Sie den Sicherungsautomaten bzw. einen anderen, eventuell vorhandenen Trennschalter.



ACHTUNG



Dieses Gerät ist nicht zur Verwendung durch Personen (Kinder mit eingeschlossen) bestimmt, welche eingeschränkte körperliche, sensorische oder geistige Fähigkeiten aufweisen bzw. fehlende Erfahrung und Kenntnis im Umgang mit diesem Gerät haben. Solche Personen müssen von einer für ihre Sicherheit verantwortlichen Aufsichtsperson zuerst instruiert oder während der Gerätebedienung beaufsichtigt werden. Kinder sollten beaufsichtigt werden, um sicherzustellen, dass sie nicht mit dem Gerät spielen. Nur für den europäischen Markt:

Dieses Gerät kann von Kindern ab 8 Jahren und von Personen mit eingeschränkten körperlichen, sensorischen oder geistigen Fähigkeiten oder mangelnden Erfahrungen und Kenntnissen benutzt werden, wenn sie beaufsichtigt werden oder im sicheren Gebrauch des Geräts unterwiesen wurden und die damit verbundenen Gefahren verstehen. Kinder dürfen nicht mit dem Gerät spielen. Die Reinigung und benutzerseitige Wartung darf nicht von unbeaufsichtigten Kindern durchgeführt werden.

Dieses Gerät ist nicht für den Einsatz an Orten geeignet, an denen die Anwesenheit von Kindern wahrscheinlich ist.



- Bedienen Sie das Gerät nicht mit nassen Händen.
- Waschen Sie es nicht mit Wasser.

HINWEIS

Bei der englischen Textfassung handelt es sich um das Original. Bei den Anleitungen in anderen Sprachen handelt es sich um Übersetzungen des Originals.

[Allgemeine Vorsichtsmaßnahmen für ECONAVI]

⚠ WARNUNG

- Verwenden Sie die ECONAVI-Funktion nicht in einem Raum, in dem sich nur Kleinkinder oder Menschen mit Behinderung aufhalten. Aufgrund von eingeschränkten Bewegungen könnte der ECONAVI-Sensor eventuell nicht feststellen, dass sich Personen im Raum aufhalten und daher das Klimagerät ausschalten.

[Allgemeine Vorsichtsmaßnahmen für die Bluetooth®-Funktionalität]

⚠ WARNUNG

- Verwenden Sie die Fernbedienung nicht, wenn Personen mit Herzschrittmachern in der Nähe sein könnten. Falls Sie die Fernbedienung verwenden, schalten Sie die Bluetooth®-Funktionalität aus.
 - Die Bluetooth®-Funktionalität kann die Funktion von Herzschrittmachern stören und zu einem Unfall führen.
- Verwenden Sie die Fernbedienung nicht in der Nähe von elektromedizinischen Geräten. Falls Sie die Fernbedienung verwenden, schalten Sie die Bluetooth®-Funktionalität aus.
 - Die Bluetooth®-Funktionalität kann die Funktion dieser Geräte stören und zu einem Unfall führen.
- Verwenden Sie die Fernbedienung nicht in der Nähe von automatischen Türen, Feuermeldern oder anderen automatisch gesteuerten Geräten. Schalten Falls Sie die Fernbedienung verwenden, schalten Sie die Bluetooth®-Funktionalität aus.
 - Die Bluetooth®-Funktionalität kann die Funktion dieser Geräte stören und zu einem Unfall führen.

⚠ ACHTUNG

- Dieses Produkt darf nur in dem Land verwendet werden, in dem es gekauft wurde.
- Dieses Produkt verwendet Signale im 2,4-GHz-Band.
 - Signale im 2,4-GHz-Band werden von medizinischen Geräten, anderen ähnlichen Geräten und nicht lizenzierten Amateurfunkstationen (im Folgenden als „andere Funkstationen“ bezeichnet) verwendet.
 1. Stellen Sie vor der Verwendung dieses Produkts sicher, dass sich keine anderen Funkstationen in der Nähe befinden.
 2. Wenn eine Funkinterferenz zwischen diesem Produkt und anderen Funkstationen auftritt, bewegen Sie das Produkt weg oder verwenden Sie das Produkt nicht weiter (schalten Sie Bluetooth®-Funktionalität aus).
 3. Falls Probleme mit Funkinterferenzen auftreten, wenden Sie sich an den Händler, von dem das Produkt erworben wurde.
- Halten Sie einen angemessenen Abstand zwischen diesem Produkt und Geräten mit Funkausstrahlung wie beispielsweise schnurlosen Telefonen, Mikrowellenherden und WLANs ein, um eine Bluetooth®-Interferenz durch diese Geräte zu verhindern, welche den normalen Betrieb und die Leistung des Produkts beeinträchtigen könnte.
- Die folgenden Aktionen können strafbare Handlungen darstellen.
 - Zerlegung oder Umbau dieses Produkts
 - Entfernung von Zertifizierungsetiketten
- Die maximale Sichtlinienentfernung für dieses Produkt beträgt 10 Meter. Diese Entfernung verkürzt sich, wenn sich Hindernisse oder Personen im Pfad der Funkwellen befinden oder wenn Funkinterferenzen durch Geräte (z. B. Mikrowellenherde) vorhanden sind.

[Allgemeine Vorsichtsmaßnahmen für die WLAN-Funktion]

- Die Fernbedienung muss innerhalb der WLAN-Reichweite des Routers montiert sein.
- Bitte stellen Sie sicher, dass der Router die Verschlüsselung WPA2-PSK (TKIP/AES) unterstützt.
- Um die Verbindung dieser Fernbedienung mit dem drahtlosen Netzwerk abzuschließen, ist möglicherweise Zugriff auf den Router erforderlich.
- Der Endbenutzer sollte die Nutzungsbedingungen und die Datenschutzerklärung in der App „Panasonic Comfort Cloud“ lesen und akzeptieren.
- Die Verwendung eines unsicheren Passworts für den WLAN-Router birgt die Gefahr des Zugriffs durch Unbefugte.
- Die Benutzer tragen alle Kosten, die mit dem Herunterladen und der Nutzung der „Panasonic Comfort Cloud“-App und der Fernbedienung verbunden sind, einschließlich, aber nicht beschränkt auf alle Gebühren, die von Ihrem Geräte-Netzbetreiber und Internetdiensteanbieter erhoben werden, sowie jegliche anderen WLAN- oder Datenzugriffsgebühren.
- Die Panasonic-Fernbedienung ist für die Kommunikation mit der „Panasonic Comfort Cloud“-App konzipiert.
- WLAN-Adapter von Fremdanbietern können nicht mit der „Panasonic Comfort Cloud“-App verbunden werden.
- Bei Aktualisierung des Dienstes kann es zu Änderungen am Aufbau des App-Bildschirms und der Anzeige der „Panasonic Comfort Cloud“ kommen.

[Vorsichtsmaßnahmen bei Verwendung der Anwendung für Mobilgeräte]

- Beim Betrieb einer Klimaanlage mit einer Fernbedienung, die sich außerhalb der Sichtweite der Klimaanlage befindet, ist vorab sicherzustellen, dass sich der Betrieb der Klimaanlage weder auf die Umgebung noch auf die anwesenden Personen negativ auswirkt.
- Wenn sich Kinder, ältere Personen, Kranke oder Menschen mit Behinderungen im Umfeld befinden, stellen Sie sicher, dass das Produkt in Gegenwart eines fähigen Erwachsenen benutzt wird, der die Aufsicht führt.
- Wenn sich Personen in einem Raum mit einer Klimaanlage befinden, informieren Sie sie vorab darüber, dass die Klimaanlage mit einer Fernbedienung bedient wird, die sich außerhalb der Sichtweite der Klimaanlage befindet.
- Kinder sollten beaufsichtigt oder von dem Produkt ferngehalten werden.
- Schlechte Funkwellenbedingungen, die durch Hindernisse oder funkabstrahlende Geräte wie beispielsweise Mikrowellenherde in der Nähe des Produkts verursacht werden, können zu Fehlern führen, bei denen das Produkt nicht mehr reagiert. Überprüfen Sie regelmäßig die Betriebsbedingungen des Produkts.
- In Bezug auf die Bluetooth®-Funktionalität beträgt die maximale Sichtlinienentfernung dieses Produkts 10 Meter. Durch Hindernisse im Pfad der Funkwellen kann sich diese Distanz verkürzen. Falls ein Problem auftritt, entfernen Sie die Hindernisse oder verringern Sie den Abstand zwischen dem Produkt und dem angeschlossenen Gerät.
- Es wird empfohlen, den Bildschirm des Mobilgeräts zu sperren, um ein versehentliches Betätigen der Klimaanlage zu verhindern.



Konformitätserklärung (DOC)

Hiermit erklärt die „Panasonic Corporation“, dass dieses Produkt die maßgeblichen Anforderungen sowie andere relevante Bestimmungen der Richtlinie 2014/53/EU erfüllt.

Der vollständige Wortlaut der EU-Konformitätserklärung ist unter folgender Internetadresse abrufbar:
<http://www.ptc.panasonic.eu/>

Bevollmächtigter Vertreter: Panasonic Testing Centre, Panasonic Marketing Europe GmbH, Winsberggring 15, 22525 Hamburg, Deutschland
Norwegen: Im Umkreis von 20 km um das Zentrum von Ny-Alesund auf Svalbard gibt es Nutzungsbeschränkungen.

Technische Daten

Modellbezeichnung		CZ-RTC6BL
Abmessungen (H x B x T)		86 mm x 86 mm x 25 mm
Gewicht		0,09 kg
Einsatzgrenzwerte Temperatur / Luftfeuchte		0 bis 40 °C / 20 bis 80% r. F. (ohne Kondensation) * Nur für den Einsatz in Innenräumen vorgesehen.
Spannungsversorgung		16 V DC (über Innengerät)
Uhr	Genauigkeit	± 30 Sekunden/Monat (bei Normtemperatur 25 °C) * Gelegentlich nachstellen.
	Laufzeit	24 Stunden (bei voller Aufladung) (bei Normtemperatur 25 °C) * Vollständiges Aufladen dauert ca. 8 Stunden.
Anzahl angeschlossener Innengeräte		Innengerät: Max. 8 Innengeräte (mit Gruppensteuerung)
Betriebssystemversion des Mobilgeräts für „Panasonic H&C Control App“		iOS: 10.0 oder höher Android™: 6.0 oder höher
Bluetooth®-Version		4.2 oder höher
WLAN-Standard		IEEE 802.11 b/g/n
Frequenzbereich		2,4-GHz-Band
Verschlüsselung		WPA2-PSK (TKIP/AES)
Betriebssystemversion des Mobilgeräts für die App „Panasonic Comfort Cloud“		iOS: 9.0 oder höher Android™: 4.4 oder höher

- Die Bluetooth®-Wortmarke und -Logos sind eingetragene Markenzeichen von Bluetooth SIG, Inc. und jede Verwendung dieser Marken durch Panasonic Corporation erfolgt unter Lizenz. Andere Warenzeichen und Handelsnamen sind Eigentum der jeweiligen Inhaber.
- iOS ist der Name des Betriebssystems von Apple Inc. IOS ist ein Warenzeichen oder eingetragenes Warenzeichen von Cisco in den USA und anderen Ländern und steht unter Lizenz.
- Apple und das Apple-Logo sind Warenzeichen von Apple Inc., die in den USA und anderen Ländern eingetragen sind. App Store ist eine Dienstleistungsmarke von Apple Inc.
- Android™, Google Play™ und die Logos Google Play™ sind eingetragene Warenzeichen von Google LLC.

Maximale Sendeleistung in den Frequenzbändern

Funknetz	Frequenzband	Max. EIRP (dBm)
Bluetooth®-Funktionalität	2402 - 2480 MHz	6,7 dBm
WLAN-Funktionalität	2412 - 2472 MHz	20 dBm

Benutzerinformation zur Sammlung und Entsorgung von Altgeräten und verbrauchten Batterien



Diese Symbole auf den Produkten, Verpackungen und/oder Begleitdokumenten bedeuten, dass gebrauchte elektrische und elektronische Produkte und Batterien nicht in den allgemeinen Hausmüll gegeben werden dürfen.

Bitte bringen Sie alte Produkte und verbrauchte Batterien zur korrekten Behandlung für Aufarbeitung und Recycling in Übereinstimmung mit der Landesgesetzgebung und den Richtlinien 2002/96/EG und 2006/66/EG zu den zuständigen Sammelstellen.

Durch die vorschriftsmäßige Entsorgung dieser Produkte und Batterien tragen Sie zum Schutz wertvoller Ressourcen und zur Vermeidung potenziell negativer Auswirkungen auf die menschliche Gesundheit und die Umwelt bei, die anderenfalls durch eine unsachgemäße Abfallbehandlung entstehen können.

Für weitere Informationen zu Sammlung und Recycling von alten Produkten und Batterien wenden Sie sich bitte an Ihre Gemeinde- oder Stadtverwaltung, das örtliche Entsorgungsunternehmen oder die Verkaufsstelle, bei der die Gegenstände erworben wurden.

Eine nicht vorschriftsmäßige Entsorgung solcher Abfälle kann je nach Landesgesetzgebung strafbar sein.

An kommerzielle Benutzer in der Europäischen Union

Wenn Sie elektrische oder elektronische Geräte entsorgen möchten, wenden Sie sich bitte an Ihren Händler oder Lieferanten. Dort erhalten Sie weitere Informationen.

[Informationen zur Entsorgung in Ländern außerhalb der Europäischen Union]

Diese Symbole sind nur in der Europäischen Union gültig. Wenn Sie diese Gegenstände entsorgen möchten, wenden Sie sich an die örtliche Behörde oder an Ihren Händler und fragen Sie nach der korrekten Entsorgungsmethode.



Anmerkung zum Batteriesymbol (unten mit zwei Kennbuchstaben als Beispiel):

Dieses Symbol kann in Kombination mit einem chemischen Symbol verwendet werden. In diesem Fall erfüllt es die Anforderungen der für die betreffende Chemikalie erlassenen Richtlinie.



Pb



Scansionare il codice a barre 2D a matrice e fare riferimento ai manuali dettagliati.

Contenuti

Precauzioni di Sicurezza.....	24	Software License Information (Bluetooth® functionality)	39
Specifiche.....	26	Software License Information (Wireless LAN functionality).....	40
Firmware Update Function for Wireless LAN functionality	39		

Precauzioni di Sicurezza



ATTENZIONE

Questo simbolo si riferisce a rischi o pratiche non sicure che possono causare serie ferite alla persona o persino la morte.



CAUTELA

Questo simbolo si riferisce a rischi o pratiche non sicure che possono causare ferite alla persona o danni al prodotto o alla proprietà.



Regole da osservare



Operazioni proibite



ATTENZIONE



Non utilizzare questo apparecchio in un'atmosfera potenzialmente esplosiva.

In caso di malfunzionamento di questo apparecchio, evitare di ripararlo da soli. Contattare il rivenditore o il fornitore di servizi per la riparazione e lo smaltimento.



In caso di emergenza, rimuovere la spina di alimentazione dalla presa o spegnere l'unità tramite il sezionatore o altro mezzo tramite cui il sistema può essere isolato dall'alimentazione principale.



CAUTELA



L'uso di questo apparecchio non è destinato a persone con capacità fisiche, sensoriali o mentali ridotte (compresi i bambini), o mancanza di esperienza o competenza, a meno che non siano supervisionate o istruite sull'uso dell'apparecchio da una persona responsabile della loro sicurezza. Fare attenzione che i bambini non giochino con l'apparecchio.

<solo per il mercato europeo>

Questo apparecchio può essere utilizzato da bambini con più di 8 anni di età e da persone con ridotte capacità fisiche, sensorie e mentali o con scarsa esperienza o conoscenza, se sotto supervisione o se gli saranno date istruzioni sull'utilizzo sicuro dell'apparecchio, e previa comprensione dei relativi rischi. I bambini non devono giocare con l'apparecchiatura. La pulizia e la manutenzione utente non devono essere effettuate da bambini senza supervisione.

Questa apparecchiatura non è adatta all'uso in luoghi dove è probabile che siano presenti bambini.



- Non lavorare con le mani bagnate.
- Non lavare con acqua.

AVVISO

[Precauzioni generali per ECONAVI]

⚠ ATTENZIONE

- Non utilizzare la funzione ECONAVI in una stanza in cui siano presenti solo persone disabili o neonati. A causa delle loro attività limitate, il sensore ECONAVI potrebbe non rilevare la presenza di persone causando di conseguenza l'arresto del funzionamento dell'unità interna.

[Precauzioni generali per funzionalità Bluetooth®]

⚠ ATTENZIONE

- Non usare il telecomando dove possono essere presenti portatori di pacemaker. In tal caso, disattivare la funzionalità Bluetooth®.
 - La funzionalità Bluetooth® potrebbe causare il malfunzionamento del pacemaker e creare problemi al suo portatore.
- Non usare il telecomando vicino a dispositivi medici elettrici. In tal caso, disattivare la funzionalità Bluetooth®.
 - La funzionalità Bluetooth® potrebbe causare il malfunzionamento dei suddetti dispositivi e creare problemi.
- Non usare il telecomando vicino a porte automatiche, allarmi antincendio e dispositivi controllati automaticamente. In tal caso, disattivare la funzionalità Bluetooth®.
 - La funzionalità Bluetooth® potrebbe causare il malfunzionamento dei suddetti dispositivi e creare problemi.

⚠ CAUTELA

- L'utilizzo del prodotto è consentito unicamente nel paese nel quale è stato acquistato.
- Questo prodotto utilizza segnali nella banda dei 2,4 GHz.
 - I segnali nella banda dei 2,4 GHz vengono usati da dispositivi medici e altri dispositivi simili, nonché da stazioni radioamatoriali abusive (di seguito indicate come "altre stazioni radio").
 1. Prima di utilizzare questo prodotto, assicurarsi che nelle vicinanze non siano presenti altre stazioni radio.
 2. Qualora si verifichi un'interferenza radio tra questo prodotto e altre stazioni radio, spostare il prodotto oppure cessarne l'utilizzo (disattivare la funzionalità Bluetooth®).
 3. Qualora si verifichino problemi causati da un'interferenza radio, consultare il concessionario dal quale è stato acquistato il prodotto.
- Mantenere una distanza adeguata tra il prodotto e dispositivi radioemittenti, quali telefoni cordless, forni a microonde e LAN wireless, al fine di evitare che i suddetti dispositivi interferiscano con il Bluetooth® e compromettano il normale funzionamento e le prestazioni del prodotto.
- Le azioni seguenti potrebbero essere perseguibili per legge.
 - Smontaggio o modifica del prodotto
 - Rimozione delle etichette di certificazione
- La distanza in linea di veduta massima di questo prodotto è di 10 metri. Questa distanza si riduce quando sono presenti ostacoli o persone lungo il percorso delle onde radio oppure in presenza di interferenze causate da apparecchi elettrici (es.: forni a microonde).

[Precauzioni generali per funzionalità Wireless LAN]

- La copertura wireless LAN deve comprendere la posizione di installazione del telecomando.
- Accertarsi che il Router supporti codifica WPA2-PSK (TKIP/AES).
- Per completare il collegamento di questo telecomando al servizio di rete wireless potrebbe essere richiesto il Router.
- L'utente finale deve leggere ed accettare i Termini di utilizzo e l'Informativa sulla privacy nei contenuti dell'app "Panasonic Comfort Cloud".
- Se per il router wireless viene impostata una password vulnerabile, esiste il rischio di utilizzo non autorizzato.
- Gli utenti sono responsabili di tutti i costi associati al download ed all'uso dell'app "Panasonic Comfort Cloud" e del telecomando, compresi in modo non limitativo tutti i costi addebitati dal fornitore di servizi di telefonia mobile e dall'Internet service provider del proprio Dispositivo e qualsiasi altro addebito relativo a wireless LAN o accesso dati.
- Il telecomando Panasonic è progettato per comunicare con l'app "Panasonic Comfort Cloud".
- Non è possibile collegare all'app "Panasonic Comfort Cloud" interfacce wireless LAN di terzi.
- Aggiornamenti al servizio potrebbero significare che ci sono modifiche del design delle schermate e della visualizzazione dell'app "Panasonic Comfort Cloud".

[Precauzioni per l'uso dell'app sul dispositivo mobile]

- Quando si controlla un condizionatore da un telecomando che si trova al di fuori della visibilità del condizionatore, prima di tutto accertarsi che il funzionamento non influisca negativamente sull'ambiente circostante.
- Quando tra le persone presenti sono inclusi bambini, anziani, persone con disturbi o con disabilità, assicurarsi che il prodotto sia utilizzato dalla presenza di un adulto abile e in grado di sorvegliare la situazione.
- Quando una o più persone sono in una stanza con un condizionatore, avvertirle in anticipo che il condizionatore sarà controllato da un telecomando che si trova fuori dalla visibilità del condizionatore.
- I bambini devono essere supervisionati o istruiti a non interagire con il telecomando.
- La scarsa trasmissione delle onde radio dovuta alla presenza di ostacoli o di dispositivi radioemittenti nelle vicinanze del prodotto, come un forno a microonde, può causare un errore di mancata risposta. Controllare periodicamente il funzionamento del prodotto.
- Riguardo alla funzionalità Bluetooth®, la massima distanza senza ostacoli per questo prodotto è di 10 metri. La presenza di ostacoli lungo il percorso delle onde radio può ridurre questa distanza. Se si verifica un problema, rimuovere gli ostacoli o ridurre la distanza tra il prodotto e il dispositivo connesso.
- Si raccomanda di bloccare la schermata del dispositivo mobile per prevenire l'utilizzo involontario del sistema di condizionamento dell'aria.



Dichiarazione di conformità (DOC)

Con il presente documento, "Panasonic Corporation", dichiara che questo prodotto è conforme ai requisiti essenziali e alle altre disposizioni in materia previste dalla Direttiva 2014/53/UE.

Il testo completo della Dichiarazione di Conformità UE è disponibile presso il seguente indirizzo Internet:

<http://www.ptc.panasonic.eu/>

Rappresentante autorizzato: Panasonic Testing Centre, Panasonic Marketing Europe GmbH, Winsbergring 15, 22525 Hamburg, Germania

Norvegia: Vi sono limitazioni all'utilizzo entro un raggio di 20 km dal centro di Ny-Alesund nelle Svalbard.

Specifiche

Modello N.		CZ-RTC6BL
Dimensioni		(H) 86 mm x (W) 86 mm x (D) 25 mm
Peso		0,09 Kg
Intervallo temperatura/umidità		Da 0 °C a 40 °C / da 20% a 80% (Niente condensa) * Solo uso interno.
Fonte di Alimentazione		DC16 V (fornita dall'unità interna)
Orologio	Precisione	± 30 secondi/mese (alla temperatura normale di 25 °C) * Regolare periodicamente.
	Tempo di tenuta	24 ore (se completamente carico) (alla temperatura normale di 25 °C) * Circa 8 ore sono necessarie per la ricarica completa.
Numero di unità interne connesse		Unità interna: Fino a 8 unità (All'interno del controllo gruppo)
Versione sistema operativo sul dispositivo mobile per "Panasonic H&C Control App"		iOS: 10.0 o più recente Android™: 6.0 o più recente
Versione Bluetooth®		4.2 o più recente
Standard LAN senza fili		IEEE 802.11 b/g/n
Gamma di frequenza		Banda a 2,4 GHz
Crittografia		WPA2-PSK (TKIP/AES)
Versione sistema operativo sul dispositivo mobile per app "Panasonic Comfort Cloud"		iOS: 9.0 o più recente Android™: 4.4 o più recente

- Il marchio denominativo Bluetooth® e i loghi sono marchi registrati di proprietà di Bluetooth SIG, Inc. e qualsiasi utilizzo di tali marchi da parte di Panasonic Corporation è concesso in licenza. Altri marchi e nomi di marchi sono di proprietà dei rispettivi proprietari.
- iOS è il nome del sistema operativo di Apple Inc. IOS è un marchio o un marchio registrato di Cisco negli USA e in altri Paesi che dispongono della licenza per il suo utilizzo.
- Apple e il logo di Apple sono marchi di Apple Inc. registrati negli Usa e in altri Paesi. App Store è un marchio di servizio di Apple Inc.
- Android™, Google Play™ e i loghi di Google Play™ sono marchi registrati di Google LLC.

Potenza radio frequenza massima trasmessa nelle bande di frequenza

Tipo di wireless	Banda di frequenza	EIRP massimo (dBm)
Funzionalità Bluetooth®	2402 - 2480 MHz	6,7 dBm
Funzionalità Wireless LAN	2412 - 2472 MHz	20 dBm

Informazioni per gli utenti sulla raccolta e lo smaltimento di apparecchiature vecchie e batterie usate



Questi simboli sui prodotti, sugli imballaggi e/o sulla documentazione in dotazione significano che i prodotti elettrici ed elettronici usati e le batterie non devono essere smaltiti insieme ai rifiuti domestici. Per il corretto trattamento, recupero e riciclo di prodotti vecchi e batterie usate, conferirli presso gli appositi centri di raccolta, in conformità con la legislazione nazionale e le Direttive 2002/96/CE e 2006/66/CE.

Il corretto smaltimento di questi prodotti e delle batterie concorre a salvaguardare risorse preziose e previene potenziali effetti nocivi per la salute umana e l'ambiente causati da uno smaltimento non corretto dei rifiuti.

Per ulteriori informazioni sulla raccolta e il riciclo di prodotti vecchi e batterie usate, rivolgersi alle autorità locali, al centro di smaltimento rifiuti locale o al proprio rivenditore.

A seconda della legislazione nazionale, lo smaltimento incorretto di questo rifiuto può essere soggetto a sanzioni.

Per gli utenti commerciali nell'Unione Europea

Per ulteriori informazioni sullo smaltimento delle apparecchiature elettriche ed elettroniche, rivolgersi al proprio rivenditore o fornitore.

[Informazioni sullo smaltimento al di fuori dell'Unione Europea]

Questi simboli sono validi solo nell'Unione Europea. Per il corretto smaltimento di questi prodotti, rivolgersi alle autorità locali o al proprio rivenditore.



Nota relativa al simbolo della batteria (esempio con simbolo chimico riportato sotto il simbolo principale):

Questo simbolo può venire usato insieme a un simbolo chimico. Il questo caso è conforme ai requisiti della Direttiva relativamente alla sostanza chimica in questione.



Pb



Kunt u de matrix 2D-streepjescode scannen en dan de gedetailleerde handleidingen raadplegen.

Inhoud

Veiligheidsvoorschriften.....	27	Software License Information (Bluetooth® functionality)	39
Specificaties.....	29	Software License Information (Wireless LAN functionality).....	40
Firmware Update Function for Wireless LAN functionality.....	39		

Veiligheidsvoorschriften



WAARSCHUWING

Dit symbool wijst naar een gevaar of onveilige praktijk die tot een ernstig letsel of de dood kan leiden.



OPGELET

Dit symbool wijst naar een gevaar of onveilige praktijk die tot een letsel of product- of eigendomschade kan leiden.



Dingen die moeten worden nageleefd



Dingen die verboden zijn



WAARSCHUWING



Gebruik dit apparaat niet in een mogelijke explosieve omgeving.

Herstel dit apparaat niet zelf als het defect is. Neem contact op met de dienst verkoop of klantendienst voor herstelling en verwijdering.



Haal In geval van nood de stekker uit het stopcontact of schakel de stroomonderbreker of de middelen waarmee het systeem op het voedingsnetwerk is aangesloten uit.



OPGELET



Dit apparaat is niet bestemd voor gebruik door personen (kinderen inbegrepen) met verminderde fysieke, sensorische of mentale capaciteiten, of zonder ervaring of kennis, tenzij onder toezicht van of na instructie door een persoon die voor hun veiligheid verantwoordelijk is. Pas op, dat kinderen niet met het apparaat spelen.

<alleen voor Europese markt>

Dit apparaat kan gebruikt worden door kinderen van 8 jaar en ouder en door mensen met beperkte lichamelijke, zintuiglijke of geestelijke bekwaamheden, of gebrek aan ervaring en kennis, als ze onder toezicht staan of instructies ontvangen hebben over het veilige gebruik van het apparaat en de betrokken gevaren begrijpen. Kinderen mogen niet met het apparaat spelen. De reiniging en het onderhoud die door de gebruiker uitgevoerd kunnen worden, mogen niet zonder toezicht door kinderen uitgevoerd worden.

Deze uitrusting is niet geschikt om gebruikt te worden op plaatsen waar waarschijnlijk kinderen aanwezig zullen zijn.



- Bedien het apparaat niet met natte handen.
- Was het apparaat niet met water.

OPMERKING

De Engelse tekst zijn de originele instructies. De andere talen zijn vertalingen van de originele instructies.

[Algemene voorzorgsmaatregelen voor ECONAVI]

⚠ WAARSCHUWING

- Gebruik de ECONAVI-functie niet in een kamer met alleen gehandicapten of kinderen. Vanwege hun beperkte bewegingen, kan de ECONAVI-sensor oordelen dat er niemand aanwezig is, waardoor de werking van de binnenunit wordt stopgezet.

[Algemene voorzorgsmaatregelen voor Bluetooth® functionaliteit]

⚠ WAARSCHUWING

- Gebruik de afstandsbediening niet waar er pacemakergebruikers in de buurt kunnen zijn. Schakel indien gebruikt de Bluetooth®-functionaliteit uit.
 - De Bluetooth® functionaliteit kan de onjuiste werking van pacemakers veroorzaken en een ongeval tot gevolg hebben.
- Gebruik de afstandsbediening niet in de buurt van elektrische medische apparatuur. Schakel indien gebruikt de Bluetooth®-functionaliteit uit.
 - De Bluetooth® functionaliteit kan de onjuiste werking van deze apparaten veroorzaken en een ongeval tot gevolg hebben.
- Gebruik de afstandsbediening niet in de buurt van automatische deuren, brandmelders of andere automatisch bediende apparaten. Schakel indien gebruikt de Bluetooth®-functionaliteit uit.
 - De Bluetooth® functionaliteit kan de onjuiste werking van deze apparaten veroorzaken en een ongeval tot gevolg hebben.

⚠ OPGELET

- Dit product mag uitsluitend worden gebruikt in het land waar het is aangeschaft.
- Houd voldoende afstand signalen in de 2,4 GHz-band.
 - Signalen in de 2,4 GHz-band worden gebruikt door medische apparaten, andere soortgelijke apparaten, en niet-geïdentificeerde amateurradiozenders (hierna te noemen "andere radiozenders").
 1. Controleer voordat u dit product gebruikt of er geen andere radiozenders in de buurt zijn.
 2. Als er radiostoring optreedt tussen dit product en andere radiozenders, verplaatst het product dan of gebruik het niet meer (schakel de Bluetooth® functionaliteit uit).
 3. Als er zich problemen met radiostoring voordoen, raadpleeg dan de dealer waar u het product heeft aangeschaft.
- Houd voldoende afstand tussen het product en radiozendapparaten, zoals cordless telefoons, magnetronovens en draadloze LAN's, om interferentie door Bluetooth® vanaf deze apparaten, die de normale werking en prestaties van het product kan beïnvloeden, te voorkomen.
- De volgende acties kunnen strafbaar zijn.
 - Uit elkaar halen of wijziging van dit product
 - Verwijdering van certificeringslabels
- Het maximale gezichtsveld van dit product is 10 meter. Deze afstand is korter als er zich obstakels of mensen op het pad van de radiogolven bevinden, of als er sprake is van radiostoring door apparaten (bv. magnetronovens).

[Algemene voorzorgsmaatregelen voor Draadloos LAN-functionaliteit]

- De draadloos LAN-dekking moet het vertrek van installatie van de afstandsbediening bevatten.
- Controleer of de router WPA2-PSK (TKIP/AES)-codering ondersteunt.
- Om de verbinding van deze afstandsbediening met de draadloze netwerkdienst te voltooien, kan de router nodig zijn.
- De eindgebruiker moet de Gebruiksvoorwaarden en de Privacyverklaring in de app "Panasonic Comfort Cloud" lezen en accepteren.
- Er bestaat het risico van niet-geautoriseerde bediening als een kwetsbaar wachtwoord voor de draadloze router ingesteld is.
- Gebruikers zijn verantwoordelijk voor alle kosten die verband houden met het downloaden en gebruiken van de "Panasonic Comfort Cloud" app en de afstandsbediening, met inbegrip en zonder beperking van alle kosten die door uw telefoonbedrijf en internetprovider aangerekend worden en alle andere kosten voor draadloos LAN of gegevenstoegang.
- De Panasonic afstandsbediening is ontworpen om met de "Panasonic Comfort Cloud" app te communiceren.
- Draadloos LAN-interfaces van derde partijen kunnen niet met de "Panasonic Comfort Cloud" app verbonden worden.
- Updates van de dienst kunnen betekenen dat er veranderingen van het ontwerp van het scherm en het display van de app "Panasonic Comfort Cloud" zijn.

[Voorzorgsmaatregelen bij het gebruik van mobiele apparaattoepassingen]

- Bij gebruik van een airconditioner vanaf een afstandsbediening buiten het zicht van de airconditioner moet u er van tevoren voor zorgen dat de werking van de airconditioner geen negatieve invloed heeft op zijn omgeving of inzittenden.
- Als er kinderen, ouderen of mensen met een aandoening of handicap aanwezig zijn, mag het product alleen worden gebruikt als er ook een competente, toezichthoudende volwassene aanwezig is.
- Wanneer er een of meer mensen zijn in een kamer met een airconditioner, laat ze dan op voorhand weten dat de airconditioner zal worden bediend vanaf een afstandsbediening die zich buiten het zicht van de airconditioner bevindt.
- Kinderen moeten onder toezicht staan of worden geïnstrueerd om uit de buurt van het product te blijven.
- Slechte omstandigheden voor radiogolven vanwege de aanwezigheid van obstakels of radiozendapparaten, zoals een magnetronoven, in de buurt van het product kunnen leiden tot het uitblijven van respons. Controleer regelmatig de werkingstoestand van het product.
- Voor de Bluetooth® functionaliteit is de maximum afstand van de gezichtslijn van dit product 10 meter. Door obstakels op het pad van radiogolven kan deze afstand korter zijn. Als er een probleem optreedt, moeten de obstakels worden verwijderd of de afstand tussen dit product en het verbonden apparaat worden verkleind.
- Aanbevolen wordt het scherm van het mobiele apparaat te vergrendelen om onbedoeld gebruik van het airconditioningsysteem te voorkomen.



Conformiteitsverklaring

Hierbij verklaart "Panasonic Corporation" dat dit product voldoet aan de fundamentele eisen en overige relevante voorzieningen van Richtlijn 2014/53/EU.

De volledige tekst van de Europese conformiteitsverklaring is beschikbaar op het volgende internetadres:

<http://www.ptc.panasonic.eu/>

Bevoegde vertegenwoordiger: Panasonic Testing Centre, Panasonic Marketing Europe GmbH, Winsberggring 15, 22525 Hamburg, Duitsland

Noorwegen: Er zijn beperkingen in het gebruik binnen een cirkel van 20 km vanaf het centrum van Ny-Alesund op Spitsbergen.

Specificaties

Modelnummer.	CZ-RTC6BL	
Afmetingen	(H) 86 mm x (B) 86 mm x (D) 25 mm	
Gewicht	0,09 kg	
Temperatuur/vochtigheidsbereik	0 °C tot 40 °C / 20% tot 80% (niet condenserend) * Uitsluitend voor gebruik binnenshuis.	
Voedingsbron	DC16 V (geleverd door de binneneunit)	
Klok	Precisie	± 30 seconden/maand (bij een normale temperatuur van 25 °C) * Periodiek afstellen.
	Bewaartijd	24 uur (wanneer volledig opgeladen) (bij een normale temperatuur van 25 °C) * Ongeveer. 8 uur zijn nodig om volledig te zijn opgeladen.
Aantal aansluitbare binneneunits	Binneneunit: Tot maximum 8 units (Binnen groepbediening)	
OS-versie op het mobiele apparaat voor "Panasonic H&C Control App"	iOS: 10.0 of hoger Android™: 6.0 of hoger	
Bluetooth®-versie	4.2 of hoger	
Norm voor draadloos LAN	IEEE 802.11 b/g/n	
Frequentiebereik	2,4 GHz-band	
Versleuteling	WPA2-PSK (TKIP/AES)	
OS-versie op het mobiele apparaat voor "Panasonic Comfort Cloud" app	iOS: 9.0 of hoger Android™: 4.4 of hoger	

- Het Bluetooth® woordmerk en logo's zijn gedeponeerde handelsmerken die het bezit zijn van Bluetooth SIG, Inc. en ieder gebruik van dergelijke merken door Panasonic Corporation vindt plaats onder licentie. Andere handelsmerken en handelsnamen zijn die van de respectievelijke eigenaren.
- iOS is de naam van het besturingssysteem van Apple Inc. IOS is een handelsmerk of geregistreerd handelsmerk van Cisco in de VS en andere landen waaraan een licentie is verleend voor gebruik.
- Apple en het Apple-logo zijn handelsmerken van Apple Inc., geregistreerd in de VS en andere landen. App Store is een handelsmerk van Apple Inc.
- Logo's van Android™, Google Play™ en Google Play™ zijn geregistreerd handelsmerken van Google LLC.

In de frequentiebanden verzonden maximum vermogen van radiofrequentie

Type draadloos	Frequentieband	Max EIRP (dBm)
Bluetooth®-functionaliteit	2402 - 2480 MHz	6,7 dBm
Draadloos LAN-functionaliteit	2412 - 2472 MHz	20 dBm

Informatie voor gebruikers over inzamelen en verwijderen van oude apparatuur en gebruikte batterijen



Deze symbolen op de producten, verpakking en/of betekenen dat gebruikte elektrische en elektronische producten en batterijen niet gemengd mogen worden met het gewone huishoudelijke afval.

Breng voor een correcte behandeling, verwerking en recycling oude producten en gebruikte batterijen naar de daartoe aangewezen inzamelingspunten in overeenstemming met de nationale regelgeving op de betreffende locatie en de Richtlijnen 2002/96/EG en 2006/66/EG.

Door deze producten en batterijen op de juiste manier te verwijderen helpt u waardevolle hulpbronnen te conserveren en mogelijke negatieve invloeden op de volksgezondheid en het milieu als gevolg van onjuiste afvalverwerking te voorkomen.

Voor meer informatie over het inzamelen en recyclen van oude producten en batterijen dient u contact op te nemen met uw gemeente, uw afvalverwerking of het verkooppunt waar u de items in kwestie gekocht hebt.

In overeenstemming met de geldende regelgeving op uw locatie kunnen er sancties rusten op het incorrect verwijderen van dergelijk afval.

Voor zakelijke gebruikers in de Europese Unie

Als u elektrische en elektronische apparatuur wilt verwijderen, dient u contact op te nemen met uw dealer of leverancier voor meer informatie.

[Informatie over verwijdering in andere landen, buiten de Europese Unie]

Deze symbolen gelden alleen in de Europese Unie. Als u deze items wilt verwijderen, moet u contact opnemen met de plaatselijke autoriteiten en vragen hoe u dat moet doen.

Opmerking batterijsymbool (onderschrift dient alleen als voorbeeld):

Dit symbool wordt mogelijk gebruikt in combinatie met een chemische aanduiding. In een dergelijk geval voldoet dit aan de eisen uit de Richtlijn met betrekking tot het chemische middel in kwestie.



Pb



Digitalize o código de barras 2D em matriz e consulte os manuais detalhados.

Índice

Precauções de segurança	30	Software License Information (Bluetooth® functionality)	39
Especificações	32	Software License Information (Wireless LAN functionality)	40
Firmware Update Function for Wireless LAN functionality	39		

Precauções de segurança



AVISO

Este símbolo refere-se a um perigo ou a uma prática não segura que pode resultar em ferimentos pessoais graves ou morte.



CUIDADO

Este símbolo refere-se a um perigo ou a uma prática não segura que pode resultar em ferimentos pessoais ou danos no produto ou materiais.



Aspectos a ter em conta



Aspectos proibidos



AVISO



Não utilize este aparelho numa atmosfera potencialmente explosiva.

Se ocorrer uma avaria com este dispositivo, não a tente reparar sozinho. Contacte o serviço de vendas ou o revendedor para proceder à reparação e eliminação.



Em caso de emergência, retire a ficha de alimentação da tomada ou desligue o disjuntor ou o meio através do qual o sistema fica isolado da fonte de alimentação.



CUIDADO



Este dispositivo não se destina ao uso por pessoas (incluindo crianças) com reduzidas capacidades físicas, sensoriais ou mentais, ou falta de experiência e conhecimento, excepto se tiverem supervisão ou instrução relacionadas com o uso do dispositivo por uma pessoa responsável pela sua segurança. As crianças devem ser supervisionadas para assegurar que não brincam com o dispositivo. <apenas para o mercado europeu>

Este aparelho pode ser usado por crianças com mais de 8 anos e por pessoas com capacidades físicas, sensoriais ou mentais reduzidas ou falta de experiência e conhecimentos se forem supervisionadas ou ensinadas a usar o aparelho de modo seguro e compreendam os perigos envolvidos. As crianças não deverão brincar com o aparelho. A limpeza e manutenção por parte do utilizador não deverão ser efetuadas por crianças sem supervisão.

Este equipamento não é adequado para ser usado em locais onde seja provável a presença de crianças.



- Não utilize com as mãos molhadas.
- Não lave com água.

AVISO

[Precauções gerais do ECONAVI]

⚠ AVISO

- Não utilize a função ECONAVI numa divisão onde se encontrem apenas pessoas com deficiências ou crianças. Devido à limitação de movimentos, o sensor ECONAVI poderá determinar que não se encontram presentes pessoas, fazendo com que a unidade interior pare de funcionar.

[Precauções gerais para a funcionalidade Bluetooth®]

⚠ AVISO

- Não use o telecomando quando houver utilizadores de pacemakers por perto. No caso de utilizar, desligar a funcionalidade Bluetooth®.
 - A funcionalidade Bluetooth® pode provocar uma avaria nos pacemakers e levar a um acidente.
- Não use o telecomando perto de dispositivos médicos elétricos. No caso de utilizar, desligar a funcionalidade Bluetooth®.
 - A funcionalidade Bluetooth® pode provocar uma avaria desses dispositivos e levar a um acidente.
- Não use o telecomando perto de portas automáticas, alarmes de fogo ou outros dispositivos controlados automaticamente. No caso de utilizar, desligar a funcionalidade Bluetooth®.
 - A funcionalidade Bluetooth® pode provocar uma avaria desses dispositivos e levar a um acidente.

⚠ CUIDADO

- Apenas é permitida a utilização deste produto no país onde este foi adquirido.
- Este produto utiliza sinais na banda 2,4 GHz.
 - Os sinais na banda 2,4 GHz são utilizados pelos dispositivos médicos, outros dispositivos similares e estações de rádio amadoras sem licença (adiante referidas como outras estações de rádio).
 1. Antes de utilizar este produto, certifique-se de que não existem outras estações de rádio nas vizinhanças.
 2. Se ocorrer uma interferência rádio entre este produto e outras estações de rádio, desloque o produto ou interrompa a utilização do produto (desligue a funcionalidade Bluetooth®).
 3. Se ocorrerem problemas de interferência rádio, consulte o concessionário onde o produto foi adquirido.
- Mantenha uma distância apropriada entre o produto e os dispositivos emissores de rádio, como telefones sem fio, micro-ondas e LAN sem fios, para evitar a interferência Bluetooth® destes dispositivos que pode afetar o funcionamento normal e o desempenho do produto.
- As seguintes ações podem ser punidas por lei.
 - Desmontagem ou alteração deste produto
 - Remoção das etiquetas de certificação
- A distância máxima da linha de visualização deste produto é de 10 metros. Esta distância será encurtada no caso de existirem obstáculos ou pessoas no caminho das ondas rádio ou interferência rádio dos aparelhos (p. ex., micro-ondas).

[Precauções gerais para a funcionalidade LAN sem fios]

- A cobertura da LAN sem fios tem de incluir o local de instalação do telecomando.
- Certifique-se de que o router suporta encriptação WPA2-PSK (TKIP/AES).
- Para completar a ligação deste telecomando ao serviço de rede sem fios, poderá precisar do router.
- O utilizador final deverá ler e aceitar os Termos de utilização e Política de privacidade na aplicação "Panasonic Comfort Cloud".
- Existe o risco de utilização sem autorização se escolher uma palavra-passe fraca para o router sem fios.
- Os utilizadores são responsáveis por todos os custos associados ao download e utilização da aplicação "Panasonic Comfort Cloud" e telecomando, incluindo, mas não estando limitado a todas as despesas cobradas pela sua empresa telefónica e fornecedor de serviços de Internet e quaisquer outras despesas de LAN sem fios ou de acesso de dados.
- O telecomando da Panasonic foi criado para comunicação com a aplicação "Panasonic Comfort Cloud".
- Interfaces de LAN sem fios de terceiros não podem ser ligados à aplicação "Panasonic Comfort Cloud".
- As atualizações ao serviço podem ser sinónimo de alterações ao design no ecrã e visualização da aplicação "Panasonic Comfort Cloud".

[Precauções ao utilizar a aplicação de dispositivos móveis]

- Quando utilizar o ar condicionado com o telecomando localizado fora de visibilidade do ar condicionado, certifique-se de que o funcionamento do ar condicionado não afeta negativamente o que se encontra em seu redor e as pessoas.
- Se os ocupantes incluírem crianças, idosos, pessoas com problemas de saúde ou pessoas com incapacidades, certifique-se de que o produto é utilizado na presença de um adulto capaz e supervisor.
- Quando houver uma ou mais pessoas na divisão com um ar condicionado, avise-as de que o ar condicionado vai ser operado com um telecomando localizado fora de visibilidade do ar condicionado.
- As crianças devem ser supervisionadas ou instruídas para ficar longe do equipamento.
- Fracas condições de ondas rádio devido à existência de obstáculos ou dispositivos emissores de rádio, como micro-ondas, na área adjacente do produto podem levar a um erro por não resposta. Efetue periodicamente a verificação das condições de funcionamento do produto.
- Relativamente à funcionalidade Bluetooth®, a distância máxima do sinal deste produto é de 10 metros. Os obstáculos no caminho das ondas rádio podem encurtar esta distância. Se ocorrer um problema, remova os obstáculos ou encurte a distância entre este produto e o dispositivo ligado.
- Recomendamos que bloqueie o ecrã do dispositivo móvel para evitar uma operação involuntária do sistema de ar condicionado.



Declaração de Conformidade (DdC)

A "Panasonic Corporation" declara pelo presente que este produto está em conformidade com os requisitos essenciais e outras disposições relevantes da Diretiva 2014/53/UE.

O texto integral da Declaração de Conformidade da UE está disponível no seguinte endereço da Internet:

<http://www.ptc.panasonic.eu/>

Representante Autorizado: Panasonic Testing Centre, Panasonic Marketing Europe GmbH, Winsbergring 15, 22525 Hamburg, Alemanha

Noruega: Existem restrições de uso dentro de um raio de 20 km desde do centro de Ny-Alesund e Svalbard.

Especificações

N.º do modelo	CZ-RTC6BL	
Dimensões	(A) 86 mm x (L) 86 mm x (P) 25 mm	
Peso	0,09 kg	
Intervalo da temperatura/humidade	0 °C a 40 °C / 20% a 80% (sem condensação) * Apenas utilização interior.	
Fonte de alimentação	16 V CC (fornecida pela unidade interior)	
Relógio	Precisão	± 30 segundos/mês (a uma temperatura normal de 25 °C) * Ajuste periodicamente.
	Tempo de espera	24 horas (quando totalmente carregado) (a uma temperatura normal de 25 °C) * São necessárias aproximadamente 8 horas para carregamento total.
Número de unidades interiores ligadas	Unidade interior: Até 8 unidades (Dentro do controlo do grupo)	
Versão do sistema operativo do dispositivo móvel para "Panasonic H&C Control App"	iOS: 10.0 ou posterior Android™: 6.0 ou posterior	
Versão do Bluetooth®	4.2 ou posterior	
LAN sem fios padrão	IEEE 802.11 b/g/n	
Banda de frequências	Banda de 2,4 GHz	
Encriptação	WPA2-PSK (TKIP/AES)	
Versão do sistema operativo do dispositivo móvel para a aplicação "Panasonic Comfort Cloud"	iOS: 9.0 ou posterior Android™: 4.4 ou posterior	

- A marca Bluetooth® e os logótipos são marcas registadas pertencentes à Bluetooth SIG, Inc. e o uso de tais marcas por parte da Panasonic Corporation é feito sob licença. Outras marcas comerciais ou nomes comerciais pertencem aos respetivos proprietários.
- iOS é o nome do sistema operativo da Apple Inc. IOS é uma marca comercial ou registada da Cisco nos Estados Unidos e noutros países em que tenha licença.
- Apple e o logótipo da Apple são marcas comerciais da Apple Inc. registadas nos Estados Unidos e noutros países. App Store é uma marca de serviço da Apple Inc.
- Android™, Google Play™ e os logótipos do Google Play™ são marcas registadas da Google LLC.

Potência máxima de radiofrequência transmitida nas bandas de frequência

Tipo de ligação sem fios	Banda de frequência	EIRP máx (dBm)
Funcionalidade Bluetooth®	2402 - 2480 MHz	6,7 dBm
Funcionalidade de LAN sem fios	2412 - 2472 MHz	20 dBm

Informações para utilizadores sobre a recolha e eliminação de equipamentos velhos e pilhas usadas



Estes símbolos nos produtos, embalagem e/ou documentos acompanhantes significam que os produtos eléctricos e electrónicos velhos e pilhas usadas não devem ser misturados com o lixo doméstico geral.

Para o tratamento, recuperação e reciclagem de produtos velhos e pilhas usadas de maneira apropriada, leve-os aos pontos de recolha aplicáveis de acordo com a legislação nacional do seu país e com as Directivas 2002/96/CE e 2006/66/CE.

Mediante a eliminação correcta destes produtos e pilhas, ajudará a salvar recursos valiosos e prevenir efeitos negativos potenciais sobre a saúde humana e o meio ambiente, que poderiam decorrer do manuseio de resíduos inadequado.

Para mais informações sobre a recolha e reciclagem de produtos velhos e pilhas usadas, contacte a autarquia local, o serviço de eliminação de resíduos ou o ponto de venda de onde comprou os itens. Poderão ser aplicadas penalidades em caso de eliminação indevida de lixo de acordo com a legislação nacional.

Para utilizadores comerciais na União Europeia

Se quiser eliminar algum equipamento eléctrico ou electrónico, contacte o seu revendedor ou distribuidor para mais informações.

[Informações sobre a eliminação em outros países fora da União Europeia]

Estes símbolos são válidos apenas na União Europeia. Se quiser eliminar estes itens, contacte a autoridade local ou o seu revendedor e informe-se sobre o método de eliminação correcto.



Nota para os símbolos de pilha (dois exemplos inferiores):

Este símbolo pode ser utilizado em combinação com um símbolo químico. Neste caso, ele satisfaz os requisitos estipulados pela Directiva para o elemento químico envolvido.



Pb



Lütfen matriks 2D barkotunu okutun ve ayrıntılı kılavuzlara bakın.

İçindekiler

Güvenlik Önlemleri.....	33	Software License Information (Bluetooth® functionality)	39
Teknik Özellikler	35	Software License Information (Wireless LAN functionality).....	40
Firmware Update Function for Wireless LAN functionality	39		

Güvenlik Önlemleri



UYARI

Bu simge, ciddi kişisel yaralanma ya da ölüme sonuçlanabilecek tehlikeli veya güvenli olmayan bir uygulamayı belirtir.



DİKKAT

Bu simge, kişisel yaralanma veya ürün ya da mülk hasarıyla sonuçlanabilecek tehlikeli veya güvenli olmayan bir uygulamayı belirtir.



Dikkat edilecek durumlar



İzin verilmeyen durumlar



UYARI



Bu cihazı, patlama olasılığı olan bir atmosferde kullanmayın.

Cihazın arızalanması durumunda kendi kendinize tamir etmeyin. Tamir ve imha için satış veya servis bayinizle temasa geçin.



Acil durumda, güç fişini prizden çekin veya sigortayı ya da sistemi ana şebekeden ayırma yolunu kapatın.



DİKKAT



Bu ürün (çocuklar da dahil) sınırlı fiziksel veya mental yeterliliği olan, bilgi ve tecrübe eksikliği olan kişiler tarafından, güvenliklerinden sorumlu bir kişinin gözetiminde değilse, kullanılmaya uygun değildir. Çocukların ürün ile oynamadıklarından emin olunması için gözetim altında tutulmaları gerekir. <Sadece Avrupa pazarı için>

Bu cihaz, güvenli kullanım için gözetim altında tutulmaları veya yönlendirilmeleri ve geçerli tehlikeleri anlamaları şartıyla, 8 yaş ve üstü çocuklar ve fiziksel, duysal veya zihinsel yetenekleri düşük ya da yeterli deneyimi ve bilgisi olmayan kişiler tarafından kullanılabilir. Çocuklar cihazla oynamamalıdır. Temizlik ve kullanıcı bakımı, gözetimsiz çocuklar tarafından yapılmamalıdır.

Bu cihaz, çocukların bulunabileceği yerlerde kullanım için uygun değildir.



- Islak ellerle çalıştırmayın.
- Suyla yıkamayın.

UYARI

İngilizce metin orijinal talimatlardır. Diğer diller, orijinal talimatların çevirisidir.

[ECONAVI ile ilgili genel önlemler]

⚠ UYARI

- Yalnızca engelli kişilerin veya küçük çocukların bulunduğu odada ECONAVI işlevini kullanmayın. Sınırlı hareketlerinden dolayı, ECONAVI sensörü, hiç kimsenin olmadığına karar verip, iç ünitenin çalışmayı durdurmasına neden olabilir.

[Bluetooth® işlevi ile ilgili genel önlemler]

⚠ UYARI

- Uzaktan kumandayı çevrede kalp pili kullanan kişilerin olabileceği yerlerde kullanmayın. Kullanıldığında, Bluetooth® işlevini kapatın.
 - Bluetooth® işlevi, kalp pillerinin arıza yapmasına ve kaza oluşmasına neden olabilir.
- Uzaktan kumandayı elektrikli tıbbi cihazların yakınında kullanmayın. Kullanıldığında, Bluetooth® işlevini kapatın.
 - Bluetooth® işlevi, bu cihazların arıza yapmasına ve kaza oluşmasına neden olabilir.
- Uzaktan kumandayı otomatik kapıların, yangın alarmlarının veya otomatik olarak kontrol edilen başka cihazların yakınında kullanmayın. Kullanıldığında, Bluetooth® işlevini kapatın.
 - Bluetooth® işlevi, bu cihazların arıza yapmasına ve kaza oluşmasına neden olabilir.

⚠ DİKKAT

- Bu ürün yalnızca satın alındığı ülkede kullanılmalıdır.
- Bu ürün, 2,4 GHz bandındaki sinyalleri kullanır.
 - 2,4 GHz bandındaki sinyaller ayrıca tıbbi cihazlar, diğer benzer cihazlar ve lisanssız amatör radyo istasyonları (bundan sonra diğer radyo istasyonları olarak adlandırılacaktır) tarafından da kullanılır.
 1. Bu ürünü kullanmadan önce, yakında başka bir radyo istasyonu olmadığından emin olun.
 2. Bu ürünle diğer radyo istasyonları arasında radyo sinyali paraziti ortaya çıkarsa, ürünü taşıyın veya ürünü kullanmayı durdurun (Bluetooth® işlevini kapatın).
 3. Radyo sinyali parazitiyle ilgili sorunlar ortaya çıkarsa, ürünün satın alındığı bayiye danışın.
- Kablosuz telefonlar, mikrodalga fırınlar ve kablosuz LAN cihazları gibi radyo sinyali yayan ürünlerden, ürünün normal çalışmasını ve performansını etkileyebilecek Bluetooth® sinyali parazitine maruz kalmamak için, ürünle bu cihazlar arasında uygun bir mesafe bırakın.
- Aşağıdaki eylemler kanunen cezalara tabi olabilir.
 - Bu ürünün sökülmesi veya üründe değişiklik yapılması
 - Sertifika etiketlerinin çıkarılması
- Bu ürünün maksimum görüş hattı mesafesi 10 metredir. Mikrodalga fırın gibi cihazlardan yayılan radyo dalgalarının veya radyo sinyali parazitlerinin yolunda insanlar veya nesnelere varsa, bu mesafe daha kısa olacaktır.

[Kablosuz LAN işlevi ile ilgili genel önlemler]

- Uzaktan kumandanın kurulum yeri kablosuz LAN kapsama alanına girmelidir.
- Yönlendiricinin WPA2-PSK (TKIP/AES) şifrelemesini desteklediğinden emin olun.
- Bu uzaktan kumandanın kablosuz ağ hizmetine bağlantısını tamamlamak için yönlendirici gerekebilir.
- Son kullanıcının "Panasonic Comfort Cloud" uygulamasının içindeki Kullanım Koşullarını ve Gizlilik Bildirimini okuyup kabul etmesi gerekmektedir.
- Kablosuz yönlendirici için zayıf bir parola ayarlarsanız, sisteminize izinsiz girişler olabilir.
- Cihaz operatörünüz ve internet servis sağlayıcınız tarafından uygulanan tüm ücretler ve varsa diğer kablosuz LAN veya veri erişim ücretleri dahil olmak üzere, "Panasonic Comfort Cloud" uygulaması ve uzaktan kumandanın indirilip kullanılması ile ilgili tüm maliyetler kullanıcıya aittir.
- Panasonic uzaktan kumanda, "Panasonic Comfort Cloud" uygulaması ile iletişim kurmak amacıyla tasarlanmıştır.
- Üçüncü parti kablosuz LAN arayüzleri "Panasonic Comfort Cloud" uygulamasına bağlanamaz.
- Hizmette güncellemeler yapılması, "Panasonic Comfort Cloud" uygulama ekranı ve görüntüsünün tasarımında değişiklikler olduğu anlamına gelebilir.

[Mobil cihaz uygulamasının kullanımına yönelik önlemler]

- Bir klimayı, klimanın görüş alanı dışında kalan bir uzaktan kumanda ile çalıştırmadan önce, klimanın çalışmasının bulunduğu çevreyi veya bu alandaki kişileri olumsuz etkilememesini sağlayın.
- Etrafta çocuklar, yaşlılar, hastalar veya engelli kişiler varsa, ürünün yetkin ve denetleme becerisine sahip bir yetişkin tarafından kullanıldığından emin olun.
- Klimalı bir odada bir veya daha fazla kişi bulunduğu, klimanın görüş alanı dışında kalan bir uzaktan kumanda kullanılarak çalıştırılacağını bu kişilere önceden bildirin.
- Çocuklara ürünün uzak durmaları için denetlenmeli veya talimat verilmelidir.
- Mikrodalga fırın gibi radyo sinyali yayan ürünlerin veya engellerin olması durumunda, ürün yakın mesafeden yanıt vermeme hatası verebilir. Ürünün çalışma koşullarını düzenli olarak kontrol edin.
- Bluetooth® işlevi ile ilgili olarak, bu ürünün maksimum görüş hattı mesafesi 10 metredir. Radyo sinyallerinin yolu üzerindeki engeller, bu mesafeyi kısaltabilir. Bir sorun ortaya çıkarsa, engel olabilecek nesnelere ortadan kaldırın veya ürünle bağlı cihaz arasındaki mesafeyi azaltın.
- Klima sisteminin yanlışlıkla çalıştırılmasının önüne geçmek için mobil cihaz ekranının kilitlemesi önerilir.



Uygunluk Beyanı (DOC)

İşbu belgede, "Panasonic Corporation" bu ürünün 2014/53/EU Direktifinin temel gerekliliklerine ve diğer ilgili hükümlerine uygun olduğunu beyan eder.

AB uygunluk beyanının tam metni aşağıdaki internet adresinde mevcuttur:

<http://www.ptc.panasonic.eu/>

Yetkili Temsilci: Panasonic Testing Centre, Panasonic Marketing Europe GmbH, Winsbergring 15, 22525 Hamburg, Almanya

Norveç: Ny-Alesund, Svalbard merkezinden 20 km yarıçap dahilinde kullanım kısıtlamaları bulunmaktadır.

Teknik Özellikler

Model No.	CZ-RTC6BL	
Boyutlar	(Y) 86 mm x (G) 86 mm x (D) 25 mm	
Ağırlık	0,09 kg	
Sıcaklık/Nem aralığı	0 °C ila 40 °C / %20 ila %80 (Yoğuşmasız) * Yalnızca iç mekân kullanımı.	
Güç Kaynağı	DC16 V (iç üniteden sağlanır)	
Saat	Hassasiyeti	± 30 saniye/ay (25 °C normal sıcaklıkta) * Düzenli olarak ayarlayın.
	Bekleme süresi	24 saat (tamamen şarj edildiğinde) (25 °C normal sıcaklıkta) * Tam şarj için yaklaşık 8 saat gereklidir.
Bağlı iç ünite sayısı	İç ünite: 8 üniteye kadar (Grup kontrolü dahilinde)	
"Panasonic H&C Control App" için mobil cihazda yüklü İşletim Sistemi sürümü	iOS: 10.0 veya sonrası Android™: 6.0 veya sonrası	
Bluetooth® sürümü	4.2 veya sonrası	
Standart Kablosuz LAN	IEEE 802.11 b/g/n	
Frekans aralığı	2,4 GHz bant	
Şifreleme	WPA2-PSK (TKIP/AES)	
"Panasonic Comfort Cloud" uygulaması için mobil cihazda yüklü İşletim Sistemi sürümü	iOS: 9.0 veya sonrası Android™: 4.4 veya sonrası	

- Bluetooth® sözcük işareti ve logoları, Bluetooth SIG, Inc.'ye ait tescilli ticari markalar olup bu markaların Panasonic Corporation tarafından her türlü kullanımı lisansa tabidir. Diğer ticari markalar ve ticari adlar kendi sahiplerine aittir.
- iOS, Apple Inc.'nin sahibi olduğu İşletim Sisteminin adıdır. IOS Cisco'nun ABD'de ve diğer ülkelerde kullanım için lisans verdiği ticari markası veya tescilli ticari markasıdır.
- Apple ile Apple logosu Apple Inc.'nin ABD'de ve diğer ülkelerde tescilli ticari markalarıdır. App Store, Apple Inc.'nin bir hizmet markasıdır.
- Android™, Google Play™ ve Google Play™ logoları Google LLC'nin tescilli ticari markalarıdır.

Frekans bantlarından iletilen maksimum radyo frekansı gücü

Kablosuz ağ türü	Frekans bandı	Maksimum EIRP (dBm)
Bluetooth® işlevini	2402 - 2480 MHz	6,7 dBm
Kablosuz LAN işlevi	2412 - 2472 MHz	20 dBm

Kullanıcıların Eski Cihazları ve Kullanılmış Pilleri Toplaması ve Bertaraf Etmesiyle İlgili Bilgiler



Ürün, ambalaj ve/veya ürünle verilen belgeler üzerindeki bu simgeler, kullanılan elektrikli ve elektronik ürünlerin ve pillerinin ve akülerinin genel evsel atıklarla karıştırılmaması gerektiğini gösterir.

Eskimiş ürünlerin ve bitmiş pillerin düzgün bir biçimde işlenmesi, kurtarılması ve geri dönüşümü için bunları lütfen ilgili kurumlar ve 2002/96/EC ve 2006/66/EC sayılı Direktifler uyarınca uygun toplama merkezlerine götürün.

Bu ürünleri ve pilleri doğru biçimde bertaraf ederek, değerli kaynakları korumaya yardımcı olursunuz ve uygunsuz şekilde bertaraf edilmesi durumunda insan sağlığı ve çevre üzerinde ortaya çıkabilecek potansiyel olumsuz etkileri önlersiniz.

Eski ürün ve pillerin toplanması ve geri dönüşümü hakkında daha fazla bilgi için lütfen yerel belediyenizle, çöp toplama hizmetini veren kuruluşla veya ürünleri satın aldığınız mağazayla irtibata geçin.

Bu çöplerin yanlış bertaraf edilmesi durumunda ulusal yasalar uyarınca cezalar söz konusu olabilir.

Avrupa Birliği'ndeki ticari kullanıcıları için

Elektrikli veya elektronik cihazları çöpe atmak istiyorsanız bilgi edinmek için lütfen satıcınıza veya tedarikçinize danışın.

[Avrupa Birliği dışındaki Ülkelerde Bertarafa İlgili Bilgiler]

Bu simgeler yalnızca Avrupa Birliğinde geçerlidir. Bu ürünleri çöpe atmak isterseniz, doğru bertaraf yöntemi için lütfen yetkili kurumlarla irtibat kurun ve doğru yöntemin ne olduğunu öğrenin.



Pil simgesi için not (en alttaki iki simge örneği):

Bu simge bir kimyasal madde simgesiyle birlikte kullanılabilir. Bu durumda, ilgili kimyasal maddeler için geçerli Direktifin gereksinimlerine uygundur.



Pb







Należy zeskanować dwuwymiarowy (2D) kod kreskowy i zapoznać się ze szczegółowymi instrukcjami obsługi.



Spis treści

Środki ostrożności	36	Software License Information (Bluetooth® functionality)	39
Dane techniczne	38	Software License Information (Wireless LAN functionality)	40
Firmware Update Function for Wireless LAN	39		

Środki ostrożności

 <p>OSTRZEŻENIE</p> <p>Ten symbol odnosi się do zagrożenia lub niebezpiecznych praktyk, które mogą skutkować poważnymi obrażeniami lub śmiercią ludzi.</p>	 <p>UWAGA</p> <p>Ten symbol odnosi się do zagrożenia lub niebezpiecznych praktyk, które mogą skutkować obrażeniami lub uszkodzeniem produktu, lub mienia.</p>
 <p>Wskazania których należy przestrzegać</p>	 <p>Zachowanie zabronione</p>

OSTRZEŻENIE

-  Nie używać tego urządzenia w potencjalnie wybuchowej atmosferze.
-  W przypadku niesprawności urządzenia nie naprawiać go samodzielnie. W celu naprawy i utylizacji należy skontaktować się z przedstawicielem handlowym lub serwisem.
-  W sytuacji awaryjnej wyciągnąć wtyczkę z gniazdka sieciowego lub użyć przycisku wyłączającego obwód (bezpiecznik) lub wyłączyć inne urządzenie odcinające system od zasilania.



UWAGA

-  To urządzenie nie jest przeznaczone do użytku przez osoby (w tym dzieci) o obniżonych zdolnościach fizycznych, sensorycznych lub umysłowych, lub nie mających odpowiedniego doświadczenia i wiedzy, o ile nie są one pod opieką lub nie są instruowane w zakresie obsługi urządzenia przez osobę odpowiedzialną za ich bezpieczeństwo. Należy dopilnować, aby dzieci nie bawiły się urządzeniem.

<tylko dla rynku europejskiego>

Urządzenie mogą obsługiwać dzieci po ukończeniu 8 roku życia oraz osoby o ograniczonych zdolnościach fizycznych, sensorycznych lub umysłowych, a także nieposiadające odpowiedniej wiedzy lub doświadczenia, jeśli będą one nadzorowane lub zostaną poinstruowane w zakresie bezpiecznego korzystania z urządzenia i będą świadome związanych z tym zagrożeń. Dzieci nie powinny bawić się urządzeniem. Czyszczenie i konserwacja użytkowa nie mogą być wykonywane przez dzieci bez nadzoru.

Sprzęt ten nie jest odpowiedni do stosowania w miejscach, w których mogą przebywać dzieci.

- 
 - Nie pracować z mokrymi rękami.
 - Nie czyścić wodą.

UWAGA

[Ogólne środki ostrożności dotyczące ECONAVI]

⚠ OSTRZEŻENIE

- Nie korzystaj z funkcji ECONAVI w pomieszczeniu, w którym przebywają tylko osoby niepełnosprawne lub niemowlęta. Z powodu ich ograniczeń ruchowych czujnik ECONAVI może uznać, że w pomieszczeniu nikogo nie ma i wyłączyć urządzenie wewnętrzne.

[Ogólne środki ostrożności dotyczące funkcji Bluetooth®]

⚠ OSTRZEŻENIE

- Nie używaj zdalnego sterownika w miejscach, w których mogą przebywać osoby z rozrusznikiem serca. Jeśli jest używany, wyłącz funkcję Bluetooth®.
 - Funkcja Bluetooth® może spowodować nieprawidłowe działanie rozrusznika serca i doprowadzić do wypadku.
- Nie używaj zdalnego sterownika w pobliżu elektrycznych urządzeń medycznych. Jeśli jest używany, wyłącz funkcję Bluetooth®.
 - Funkcja Bluetooth® może spowodować nieprawidłowe działanie tych urządzeń i doprowadzić do wypadku.
- Nie należy używać zdalnego sterownika w pobliżu automatycznych drzwi, alarmów pożarowych lub innych urządzeń sterowanych automatycznie. Jeśli jest używany, wyłącz funkcję Bluetooth®.
 - Funkcja Bluetooth® może spowodować nieprawidłowe działanie tych urządzeń i doprowadzić do wypadku.

⚠ UWAGA

- Produkt jest dopuszczony do użytku tylko w kraju, w którym został zakupiony.
- Produkt korzysta z sygnału w paśmie 2,4 GHz.
 - Sygnał w paśmie 2,4 GHz wykorzystywany jest przez urządzenia medyczne, inne podobne urządzenia oraz nielicencjonowane amatorskie stacje radiowe (zwane dalej innymi stacjami radiowymi).
 1. Przed rozpoczęciem korzystania z produktu należy się upewnić, czy w pobliżu nie ma innych stacji radiowych.
 2. W przypadku wystąpienia zakłóceń radiowych między produktem a innymi stacjami radiowymi, należy przenieść produkt w inne miejsce lub zaprzestać korzystania z niego (wyłączyć funkcję Bluetooth®).
 3. Jeśli wystąpią problemy z zakłóceniami radiowymi, należy skonsultować się ze sprzedawcą, u którego produkt został zakupiony.
- Konieczne jest zachowanie odpowiedniej odległości pomiędzy produktem a urządzeniami emitującymi fale radiowe, takimi jak telefony bezprzewodowe, kuchenki mikrofalowe i bezprzewodowe sieci LAN, aby zapobiec zakłóceniom połączenia Bluetooth® z tych urządzeń, co może mieć wpływ na działanie produktu.
- Następujące działania mogą podlegać sankcjom prawnym.
 - Demontaż lub modyfikacja produktu
 - Usunięcie oznakowań certyfikacyjnych
- Maksymalna odległość produktu w linii prostej wynosi 10 metrów. Odległość ta zmniejszy się, gdy na drodze fal radiowych znajdują się przeszkody bądź osoby, lub kiedy wystąpią zakłócenia pochodzące z innych urządzeń (np. kuchenek mikrofalowych).

[Ogólne środki ostrożności dotyczące funkcji bezprzewodowej sieci LAN]

- Zasięg bezprzewodowej sieci LAN musi zawierać lokalizację instalacji sterownika zdalnego.
- Upewnij się, że router obsługuje szyfrowanie WPA2-PSK (TKIP/AES).
- Do sfinalizowania połączenia sterownika zdalnego z usługą sieci bezprzewodowej konieczne może być użycie routera.
- Użytkownik końcowy powinien przeczytać i zaakceptować Warunki użytkownika oraz Informację o polityce prywatności w aplikacji „Panasonic Comfort Cloud”.
- Istnieje ryzyko nieautoryzowanego działania w przypadku ustawienia słabego hasła dla routera bezprzewodowego.
- Użytkownicy ponoszą wszelkie koszty związane z pobieraniem i korzystaniem z aplikacji „Panasonic Comfort Cloud” i sterownika zdalnego, w tym m.in. wszelkie opłaty pobierane przez operatora urządzenia i dostawcę usług internetowych oraz wszelkie inne opłaty związane z dostępem do bezprzewodowej sieci LAN lub danych.
- Sterownik zdalny firmy Panasonic został stworzony z myślą o komunikacji z aplikacją „Panasonic Comfort Cloud”.
- Interfejsów bezprzewodowej sieci LAN innych firm nie można podłączyć do aplikacji „Panasonic Comfort Cloud”.
- Aktualizacje usługi mogą oznaczać zmiany w wyglądzie ekranu i wyświetlacza aplikacji „Panasonic Comfort Cloud”.

[Środki ostrożności przy korzystaniu z aplikacji na urządzenia przenośne]

- W przypadku obsługi klimatyzatora za pomocą zdalnego sterownika umieszczonego w miejscu, z którego nie jest on widoczny, należy upewnić się, że działanie klimatyzatora nie będzie miało negatywnego wpływu na otoczenie lub osoby przebywające w pomieszczeniu.
- Jeżeli do grupy mieszkańców należą dzieci, osoby starsze, osoby z dolegliwościami lub osoby niepełnosprawne, produkt powinien być używany pod nadzorem sprawnej osoby dorosłej.
- Gdy w pomieszczeniu z klimatyzatorem przebywa jedna lub więcej osób, należy wcześniej poinformować je, że klimatyzator będzie obsługiwany za pomocą zdalnego sterownika znajdującego się w miejscu, które nie jest dla nich widoczne.
- Dzieci powinny być nadzorowane lub instruowane, aby trzymały się z dala od produktu.
- Zakłócenia fal radiowych spowodowane przeszkodami na ich drodze lub znajdującymi się w pobliżu urządzeniami emitującymi fale radiowe, takimi jak kuchenka mikrofalowa, mogą doprowadzić do wystąpienia błędów braku połączenia. Cyklicznie sprawdzać stan i działanie urządzenia.
- Jeśli chodzi o funkcjonalność Bluetooth®, maksymalna odległość działania tego produktu wynosi 10 metrów. Przeszkody znajdujące się na drodze fal radiowych mogą spowodować zmniejszenie tej odległości. W razie wystąpienia problemu, usunąć przeszkody lub zmniejszyć odległość między produktem a podłączonym urządzeniem.
- Zaleca się zablokowanie ekranu urządzenia przenośnego, aby zapobiec niezamierzonemu sterowaniu klimatyzacją.



Deklaracja zgodności (DOC)

Firma „Panasonic Corporation” oświadcza, iż niniejszy produkt spełnia niezbędne wymagania oraz inne odnośne postanowienia dyrektywy 2014/53/UE.

Pełny tekst deklaracji zgodności UE jest dostępny pod poniższym adresem:

<http://www.ptc.panasonic.eu/>

Autoryzowany przedstawiciel: Panasonic Testing Centre, Panasonic Marketing Europe GmbH, Winsbergring 15, 22525 Hamburg, Niemcy

Norwegia: Obowiązują ograniczenia eksploatacyjne w promieniu 20 km od centrum miejscowości Ny-Alesund w prowincji Svalbard.

Dane techniczne

Nr modelu	CZ-RTC6BL	
Wymiary	(WYS.) 86 mm x (SZER.) 86 mm x (GŁ.) 25 mm	
Masa	0,09 kg	
Temperatura / zakres wilgotności	0 °C do 40 °C / 20% do 80% (bez skraplania) * Tylko do użytku w pomieszczeniach.	
Źródło zasilania	DC16 V (zasilanie z urządzenia wewnętrznego)	
Zegar	Dokładność	± 30 sekund/miesiąc (przy temperaturze 25 °C) * Regulować okresowo.
	Czas podtrzymywania	24 godziny (przy pełnym naładowaniu) (przy temperaturze 25 °C) * Do pełnego naładowania potrzeba ok. 8 godzin.
Liczba podłączonych urządzeń wewnętrznych	Urządzenie wewnętrzne: Do 8 urządzeń (W ramach kontroli grupowej)	
Wersja systemu operacyjnego na urządzeniu mobilnym dla „Panasonic H&C Control App”	iOS: 10.0 lub nowsza Android™: 6.0 lub nowsza	
Wersja Bluetooth®	4.2 lub nowsza	
Standard bezprzewodowej sieci LAN	IEEE 802.11 b/g/n	
Zakres częstotliwości	Pasmo 2,4 GHz	
Szyfrowanie	WPA2-PSK (TKIP/AES)	
Wersja systemu operacyjnego na urządzeniu mobilnym dla aplikacji „Panasonic Comfort Cloud”	iOS: 9.0 lub nowsza Android™: 4.4 lub nowsza	

- Nazwa marki Bluetooth® i logotypy są zarejestrowanymi znakami towarowymi firmy Bluetooth SIG, Inc. i wszelkie ich użycie przez firmę Panasonic Corporation jest objęte licencją. Pozostałe znaki towarowe i nazwy handlowe są własnością ich posiadaczy.
- iOS jest nazwą systemu operacyjnego (OS) Apple Inc. IOS jest znakiem towarowym lub zastrzeżonym znakiem towarowym firmy Cisco w USA i innych krajach, które uzyskały licencję na użytkowanie.
- Apple i logo Apple są znakami towarowymi firmy Apple Inc. zarejestrowanymi w USA i innych krajach. App Store jest znakiem usługowym firmy Apple Inc.
- Logo Android™, Google Play™ i Google Play™ są zastrzeżonymi znakami towarowymi firmy Google LLC.

Maksymalne częstotliwości radiowe przesyłanej mocy w granicach pasm częstotliwości

Typ sieci bezprzewodowej	Pasmo częstotliwości	Max EIRP (dBm)
Funkcję Bluetooth®	2402 - 2480 MHz	6,7 dBm
Funkcja bezprzewodowej sieci LAN	2412 - 2472 MHz	20 dBm

Informacje o zbiorce i usuwaniu starych urządzeń i zużytych baterii



Przedstawione obok symbole, umieszczone na produktach, opakowaniach i/lub załączonych dokumentach oznaczają, że zużytych produktów elektrycznych i elektronicznych oraz baterii nie należy mieszać z odpadami gospodarczymi.

W celu prawidłowego przetworzenia, powtórnego wykorzystania i recyklingu starych produktów oraz baterii należy przekazać je do odpowiednich punktów zbiórki, zgodnie z przepisami krajowymi oraz dyrektywami 2002/96/WE i 2006/66/WE.

Usuwanie produktów i baterie w prawidłowy sposób pomagasz chronić cenne zasoby naturalne i zapobiegasz ewentualnym negatywnym oddziaływaniom na zdrowie ludzi i środowisko, które mogłyby być spowodowane niewłaściwym obchodzeniem się z odpadami.

Więcej informacji o zbiorce i recyklingu starych produktów oraz baterii można uzyskać kontaktując się z urzędem miasta/gminy, miejscową firmą zajmującą się usuwaniem odpadów lub punktem, w którym dokonano zakupu produktów.

Nieprawidłowe usuwanie odpadów może podlegać karze przewidzianej zgodnie z obowiązującymi przepisami krajowymi.

Dla użytkowników biznesowych w Unii Europejskiej

Aby pozbyć się urządzeń elektrycznych lub elektronicznych, należy skontaktować się z przedstawicielem handlowym lub dostawcą, który udzieli dalszych informacji.

[Informacje o usuwaniu odpadów w krajach poza Unią Europejską]

Te symbole obowiązują wyłącznie w krajach Unii Europejskiej. Aby pozbyć się tych produktów, należy kontaktować się z lokalnymi władzami lub przedstawicielem handlowym i poprosić o określenie właściwego sposobu usunięcia produktów.

Dotyczy symbolu baterii (dwa symbole poniżej):

Ten symbol może występować wraz z symbolem pierwiastka chemicznego. W takim przypadku wymagania Dyrektywy w sprawie określonego środka chemicznego są spełnione.



Pb

Firmware Update Function for Wireless LAN functionality

This product has functionality for connecting to the Panasonic firmware update server over the Internet to automatically update the device firmware to the latest version. To update the firmware, the device will do check, once per day, whether its firmware is the latest version after power up. And if an update is required, the update is applied and the device restarts automatically. Operations are not possible while the device is being restarted (Requires a maximum of five minutes).

Software License Information (Bluetooth® functionality)

This product incorporates the following software:

- (1) The software developed independently by or for Panasonic Corporation,
- (2) The software owned by third party and licensed to Panasonic Corporation,
- (3) The open source software under the Apache 2.0 license.
- (4) The open source software under the BSD license and/or equivalent license.

The software categorized as of (3), (4) is distributed in the hope that it will be useful, but WITHOUT ANY WARRANTY, without even the implied warranty of MERCHANTABILITY or FITNESS FOR A PARTICULAR PURPOSE.

mbedTLS

Copyright (C) 2006-2015, ARM Limited, All Rights Reserved

Apache License

Version 2.0, January 2004

<http://www.apache.org/licenses/>

TERMS AND CONDITIONS FOR USE, REPRODUCTION, AND DISTRIBUTION

1. Definitions.

"License" shall mean the terms and conditions for use, reproduction, and distribution as defined by Sections 1 through 9 of this document.

"Licensor" shall mean the copyright owner or entity authorized by the copyright owner that is granting the License.

"Legal Entity" shall mean the union of the acting entity and all other entities that control, are controlled by, or are under common control with that entity. For the purposes of this definition, "control" means (i) the power, direct or indirect, to cause the direction or management of such entity, whether by contract or otherwise, or (ii) ownership of fifty percent (50%) or more of the outstanding shares, or (iii) beneficial ownership of such entity.

"You" (or "Your") shall mean an individual or Legal Entity exercising permissions granted by this License.

"Source" form shall mean the preferred form for making modifications, including but not limited to software source code, documentation source, and configuration files.

"Object" form shall mean any form resulting from mechanical transformation or translation of a Source form, including but not limited to compiled object code, generated documentation, and conversions to other media types.

"Work" shall mean the work of authorship, whether in Source or Object form, made available under the License, as indicated by a copyright notice that is included in or attached to the work.

"Derivative Works" shall mean any work, whether in Source or Object form, that is based on (or derived from) the Work and for which the editorial revisions, annotations, elaborations, or other modifications represent, as a whole, an original work of authorship. For the purposes of this License, Derivative Works shall not include works that remain separate from, or merely link (or bind by name) to the interfaces of, the Work and Derivative Works thereof.

"Contribution" shall mean any work of authorship, including the original version of the Work and any modifications or additions to that Work or Derivative Works thereof, that is intentionally submitted to Licensor for inclusion in the Work by the copyright owner or by an individual or Legal Entity authorized to submit on behalf of the copyright owner.

For the purposes of this definition, "submitted" means any form of electronic, verbal, or written communication sent to the Licensor or its representatives, including but not limited to communication on electronic mailing lists, source code control systems, and issue tracking systems that are managed by, or on behalf of, the Licensor for the purpose of discussing and improving the Work, but excluding communication that is conspicuously marked or otherwise designated in writing by the copyright owner as "Not a Contribution." "Contributor" shall mean Licensor and any individual or Legal Entity on behalf of whom a Contribution has been received by Licensor and subsequently incorporated within the Work.

2. Grant of Copyright License. Subject to the terms and conditions of this License, each Contributor hereby grants to You a perpetual, worldwide, non-exclusive, no-charge, royalty-free, irrevocable copyright license to reproduce, prepare Derivative Works of, publicly display, publicly perform, sublicense, and distribute the Work and such Derivative Works in Source or Object form.

3. Grant of Patent License. Subject to the terms and conditions of this License, each Contributor hereby grants to You a perpetual, worldwide, non-exclusive, no-charge, royalty-free, irrevocable (except as stated in this section) patent license to make, have made, use, offer to sell, sell, import, and otherwise transfer the Work, where such license applies only to those patent claims licensable by such Contributor that are necessarily infringed by their Contribution(s) alone or by combination of their Contribution(s) with the Work to which such Contribution(s) was submitted.

If You institute patent litigation against any entity (including a cross-claim or counterclaim in a lawsuit) alleging that the Work or a Contribution incorporated within the Work constitutes direct or contributory patent infringement, then any patent licenses granted to You under this License for that Work shall terminate as of the date such litigation is filed.

4. Redistribution. You may reproduce and distribute copies of the Work or Derivative Works thereof in any medium, with or without modifications, and in Source or Object form, provided that You meet the following conditions:

- (a) You must give any other recipients of the Work or Derivative Works a copy of this License; and
 - (b) You must cause any modified files to carry prominent notices stating that You changed the files; and
 - (c) You must retain, in the Source form of any Derivative Works that You distribute, all copyright, patent, trademark, and attribution notices from the Source form of the Work, excluding those notices that do not pertain to any part of the Derivative Works; and
 - (d) If the Work includes a "NOTICE" text file as part of its distribution, then any Derivative Works that You distribute must include a readable copy of the attribution notices contained within such NOTICE file, excluding those notices that do not pertain to any part of the Derivative Works, in at least one of the following places: within a NOTICE text file distributed as part of the Derivative Works; within the Source form or documentation, if provided along with the Derivative Works; or, within a display generated by the Derivative Works, if and wherever such third-party notices normally appear. The contents of the NOTICE file are for informational purposes only and do not modify the License.
- You may add Your own attribution notices within Derivative Works that You distribute, alongside or as an addendum to the NOTICE text from the Work, provided that such additional attribution notices cannot be construed as modifying the License. You may add Your own copyright statement to Your modifications and may provide additional or different license terms and conditions for use, reproduction, or distribution of Your modifications, or for any such Derivative Works as a whole, provided Your use, reproduction, and distribution of the Work otherwise complies with the conditions stated in this License.

5. Submission of Contributions. Unless You explicitly state otherwise, any Contribution intentionally submitted for inclusion in the Work by You to the Licensor shall be under the terms and conditions of this License, without any additional terms or conditions. Notwithstanding the above, nothing herein shall supersede or modify the terms of any separate license agreement you may have executed with Licensor regarding such Contributions.

6. Trademarks. This License does not grant permission to use the trade names, trademarks, service marks, or product names of the Licensor, except as required for reasonable and customary use in describing the origin of the Work and reproducing the content of the NOTICE file.

7. Disclaimer of Warranty. Unless required by applicable law or agreed to in writing, Licensor provides the Work (and each Contributor provides its Contributions) on an "AS IS" BASIS, WITHOUT WARRANTIES OR CONDITIONS OF ANY KIND, either express or implied, including, without limitation, any warranties or conditions of TITLE, NON-INFRINGEMENT, MERCHANTABILITY, or FITNESS FOR A PARTICULAR PURPOSE. You are solely responsible for determining the appropriateness of using or redistributing the Work and assume any risks associated with Your exercise of permissions under this License.

8. Limitation of Liability. In no event and under no legal theory, whether in tort (including negligence), contract, or otherwise, unless required by applicable law (such as deliberate and grossly negligent acts) or agreed to in writing, shall any Contributor be liable to You for damages, including any direct, indirect, special, incidental, or consequential damages of any character arising as a result of this License or out of the use or inability to use the Work (including but not limited to damages for loss of goodwill, work stoppage, computer failure or malfunction, or any and all other commercial damages or losses), even if such Contributor has been advised of the possibility of such damages.

9. Accepting Warranty or Additional Liability. While redistributing the Work or Derivative Works thereof, You may choose to offer, and charge a fee for, acceptance of support, warranty, indemnity, or other liability obligations and/or rights consistent with this License. However, in accepting such obligations, You may act only on Your own behalf and/or on Your sole responsibility, not on behalf of any other Contributor, and only if You agree to indemnify, defend, and hold each Contributor harmless for any liability incurred by, or claims asserted against, such Contributor by reason of your accepting any such warranty or additional liability.

END OF TERMS AND CONDITIONS

APPENDIX: How to apply the Apache License to your work.

To apply the Apache License to your work, attach the following boilerplate notice, with the fields enclosed by brackets "[]" replaced with your own identifying information. (Don't include the brackets!) The text should be enclosed in the appropriate comment syntax for the file format. We also recommend that a file or class name and description of purpose be included on the same "printed page" as the copyright notice for easier identification within third-party archives.

Copyright [yyyy] [name of copyright owner]

Licensed under the Apache License, Version 2.0 (the "License"); you may not use this file except in compliance with the License. You may obtain a copy of the License at

<http://www.apache.org/licenses/LICENSE-2.0>

Unless required by applicable law or agreed to in writing, software distributed under the License is distributed on an "AS IS" BASIS, WITHOUT WARRANTIES OR CONDITIONS OF ANY KIND, either express or implied.

See the License for the specific language governing permissions and limitations under the License.

Software License Information (Wireless LAN functionality)

This product incorporates the following software:

- (1) The software developed independently by or for Panasonic Corporation,
- (2) The software owned by third party and licensed to Panasonic Corporation,
- (3) The open source software under the BSD licence and/or equivalent licences.

The software categorized as of (3) is distributed in the hope that it will be useful, but WITHOUT ANY WARRANTY, without even the implied warranty of MERCHANTABILITY or FITNESS FOR A PARTICULAR PURPOSE.

The following license terms shall be applied to Open-Sourced Components.

1. Supplicant license

Copyright (C) 2003-2016, Jouni Malinen <j@w1.fi > and contributors.
All rights reserved.

This software may be distributed, used, and modified under the terms of BSD license:

Redistribution and use in source and binary forms, with or without modification, are permitted provided that the following conditions are met:

1. Redistributions of source code must retain the above copyright notice, this list of conditions and the following disclaimer.
2. Redistributions in binary form must reproduce the above copyright notice, this list of conditions and the following disclaimer in the documentation and/or other materials provided with the distribution.
3. Neither the name(s) of the above-listed copyright holder(s) nor the names of its contributors may be used to endorse or promote products derived from this software without specific prior written permission.

THIS SOFTWARE IS PROVIDED BY THE COPYRIGHT HOLDERS AND CONTRIBUTORS AS IS AND ANY EXPRESS OR IMPLIED WARRANTIES, INCLUDING, BUT NOT LIMITED TO, THE IMPLIED WARRANTIES OF MERCHANTABILITY AND FITNESS FOR A PARTICULAR PURPOSE ARE DISCLAIMED. IN NO EVENT SHALL THE COPYRIGHT OWNER OR CONTRIBUTORS BE LIABLE FOR ANY DIRECT, INDIRECT, INCIDENTAL, SPECIAL, EXEMPLARY, OR CONSEQUENTIAL DAMAGES (INCLUDING, BUT NOT LIMITED TO, PROCUREMENT OF SUBSTITUTE GOODS OR SERVICES; LOSS OF USE, DATA, OR PROFITS; OR BUSINESS INTERRUPTION) HOWEVER CAUSED AND ON ANY THEORY OF LIABILITY, WHETHER IN CONTRACT, STRICT LIABILITY, OR TORT (INCLUDING NEGLIGENCE OR OTHERWISE) ARISING IN ANY WAY OUT OF THE USE OF THIS SOFTWARE, EVEN IF ADVISED OF THE POSSIBILITY OF SUCH DAMAGE.

Copyright^①

- The App Store is a service mark of Apple Inc.
- iPhone is a trademark of Apple Inc. registered in the United States and other countries. The iPhone trademarks is used under license of iPhone Co., Ltd.
- Android and Google Play are trademarks or registered trademarks of Google LLC.
- Other names, company names, product names, etc described in this manual are trademarks or registered trademarks of each company. In the text, some TM and [®] marks are not listed.

About Software

This product incorporates the following software:

- 1) The software developed independently by or for Panasonic Corporation,
- 2) The software owned by third party and licensed to Panasonic Corporation,
- 3) The software licensed under the GNU GENERAL PUBLIC LICENSE Version 2.0 (GPL V2.0),
- 4) Open sourced software other than the software licensed under the GPL V2.0.

The software categorized as (3) and (4) are distributed in the hope that it will be useful, but without any warranty, without even the implied warranty of [merchantability] or [fitness for a particular purpose]. Please refer to the detailed terms and conditions thereof shown in the "Software License" menu on this product.

At least three (3) years from delivery of this product, Panasonic will give to any third party who contacts us at the contact information provided below, for a charge no more than our cost of physically performing source code distribution, a complete machine-readable copy of the corresponding source code covered under GPL V2.0 or the other licenses with the obligation to do so, as well as the respective copyright notice thereof.

Contact information:

oss-cd-request@gg.jp.panasonic.com

The source code and the copyright notice are also available for free in our website below.

<https://panasonic.net/cns/oss/ap/>

lwIP

lwIP is licenced under the BSD licence:

Copyright (c) 2001-2004 Swedish Institute of Computer Science. All rights reserved.

Redistribution and use in source and binary forms, with or without modification, are permitted provided that the following conditions are met:

1. Redistributions of source code must retain the above copyright notice, this list of conditions and the following disclaimer.
2. Redistributions in binary form must reproduce the above copyright notice, this list of conditions and the following disclaimer in the documentation and/or other materials provided with the distribution.
3. The name of the author may not be used to endorse or promote products derived from this software without specific prior written permission.

THIS SOFTWARE IS PROVIDED BY THE AUTHOR "AS IS AND ANY EXPRESS OR IMPLIED WARRANTIES, INCLUDING, BUT NOT LIMITED TO, THE IMPLIED WARRANTIES OF MERCHANTABILITY AND FITNESS FOR A PARTICULAR PURPOSE ARE DISCLAIMED. IN NO EVENT SHALL THE AUTHOR BE LIABLE FOR ANY DIRECT, INDIRECT, INCIDENTAL, SPECIAL, EXEMPLARY, OR CONSEQUENTIAL DAMAGES (INCLUDING, BUT NOT LIMITED TO, PROCUREMENT OF SUBSTITUTE GOODS OR SERVICES; LOSS OF USE, DATA, OR PROFITS; OR BUSINESS INTERRUPTION) HOWEVER CAUSED AND ON ANY THEORY OF LIABILITY, WHETHER IN CONTRACT, STRICT LIABILITY, OR TORT (INCLUDING NEGLIGENCE OR OTHERWISE) ARISING IN ANY WAY OUT OF THE USE OF THIS SOFTWARE, EVEN IF ADVISED OF THE POSSIBILITY OF SUCH DAMAGE.

mbedTLS

Apache License

Version 2.0, January 2004

<http://www.apache.org/licenses/>

TERMS AND CONDITIONS FOR USE, REPRODUCTION, AND DISTRIBUTION

1. Definitions.

"License" shall mean the terms and conditions for use, reproduction, and distribution as defined by Sections 1 through 9 of this document.

"Licensor" shall mean the copyright owner or entity authorized by the copyright owner that is granting the License.

"Legal Entity" shall mean the union of the acting entity and all other entities that control, are controlled by, or are under common control with that entity. For the purposes of this definition, "control" means (i) the power, direct or indirect, to cause the direction or management of such entity, whether by contract or otherwise, or (ii) ownership of fifty percent (50%) or more of the outstanding shares, or (iii) beneficial ownership of such entity.

"You" (or "Your") shall mean an individual or Legal Entity exercising permissions granted by this License.

"Source" form shall mean the preferred form for making modifications, including but not limited to software source code, documentation source, and configuration files.

"Object" form shall mean any form resulting from mechanical transformation or translation of a Source form, including but not limited to compiled object code, generated documentation, and conversions to other media types.

"Work" shall mean the work of authorship, whether in Source or Object form, made available under the License, as indicated by a copyright notice that is included in or attached to the work.

"Derivative Works" shall mean any work, whether in Source or Object form, that is based on (or derived from) the Work and for which the editorial revisions, annotations, elaborations, or other modifications represent, as a whole, an original work of authorship. For the purposes of this License, Derivative Works shall not include works that remain separable from, or merely link (or bind by name) to the interfaces of, the Work and Derivative Works thereof.

"Contribution" shall mean any work of authorship, including the original version of the Work and any modifications or additions to that Work or Derivative Works thereof, that is intentionally submitted to Licensor for inclusion in the Work by the copyright owner or by an individual or Legal Entity authorized to submit on behalf of the copyright owner.

For the purposes of this definition, "submitted" means any form of electronic, verbal, or written communication sent to the Licensor or its representatives, including but not limited to communication on electronic mailing lists, source code control systems, and issue tracking systems that are managed by, or on behalf of, the Licensor for the purpose of discussing and improving the Work, but excluding communication that is conspicuously marked or otherwise designated in writing by the copyright owner as "Not a Contribution." "Contributor" shall mean Licensor and any individual or Legal Entity on behalf of whom a Contribution has been received by Licensor and subsequently incorporated within the Work.

2. Grant of Copyright License. Subject to the terms and conditions of this License, each Contributor hereby grants to You a perpetual, worldwide, non-exclusive, no-charge, royalty-free, irrevocable copyright license to reproduce, prepare Derivative Works of, publicly display, publicly perform, sublicense, and distribute the Work and such Derivative Works in Source or Object form.

3. Grant of Patent License. Subject to the terms and conditions of this License, each Contributor hereby grants to You a perpetual, worldwide, non-exclusive, no-charge, royalty-free, irrevocable (except as stated in this section) patent license to make, have made, use, offer to sell, sell, import, and otherwise transfer the Work, where such license applies only to those patent claims licensable by such Contributor that are necessarily infringed by their Contribution(s) alone or by combination of their Contribution(s) with the Work to which such Contribution(s) was submitted.

Copyright²

If You institute patent litigation against any entity (including a cross-claim or counterclaim in a lawsuit) alleging that the Work or a Contribution incorporated within the Work constitutes direct or contributory patent infringement, then any patent licenses granted to You under this License for that Work shall terminate as of the date such litigation is filed.

4. Redistribution. You may reproduce and distribute copies of the Work or Derivative Works thereof in any medium, with or without modifications, and in Source or Object form, provided that You meet the following conditions:

- (a) You must give any other recipients of the Work or Derivative Works a copy of this License; and
- (b) You must cause any modified files to carry prominent notices stating that You changed the files; and
- (c) You must retain, in the Source form of any Derivative Works that You distribute, all copyright, patent, trademark, and attribution notices from the Source form of the Work, excluding those notices that do not pertain to any part of the Derivative Works; and
- (d) If the Work includes a "NOTICE" text file as part of its distribution, then any Derivative Works that You distribute must include a readable copy of the attribution notices contained within such NOTICE file, excluding those notices that do not pertain to any part of the Derivative Works, in at least one of the following places: within a NOTICE text file distributed as part of the Derivative Works; within the Source form or documentation, if provided along with the Derivative Works; or, within a display generated by the Derivative Works, if and wherever such third-party notices normally appear. The contents of the NOTICE file are for informational purposes only and do not modify the License.

You may add Your own attribution notices within Derivative Works that You distribute, alongside or as an addendum to the NOTICE text from the Work, provided that such additional attribution notices cannot be construed as modifying the License.

You may add Your own copyright statement to Your modifications and may provide additional or different license terms and conditions for use, reproduction, or distribution of Your modifications, or for any such Derivative Works as a whole, provided Your use, reproduction, and distribution of the Work otherwise complies with the conditions stated in this License.

5. Submission of Contributions. Unless You explicitly state otherwise, any Contribution intentionally submitted for inclusion in the Work by You to the Licensor shall be under the terms and conditions of this License, without any additional terms or conditions.

Notwithstanding the above, nothing herein shall supersede or modify the terms of any separate license agreement you may have executed with Licensor regarding such Contributions.

6. Trademarks. This License does not grant permission to use the trade names, trademarks, service marks, or product names of the Licensor, except as required for reasonable and customary use in describing the origin of the Work and reproducing the content of the NOTICE file.

7. Disclaimer of Warranty. Unless required by applicable law or agreed to in writing, Licensor provides the Work (and each Contributor provides its Contributions) on an "AS IS" BASIS, WITHOUT WARRANTIES OR CONDITIONS OF ANY KIND, either express or implied, including, without limitation, any warranties or conditions of TITLE, NON-INFRINGEMENT, MERCHANTABILITY, or FITNESS FOR A PARTICULAR PURPOSE. You are solely responsible for determining the appropriateness of using or redistributing the Work and assume any risks associated with Your exercise of permissions under this License.

8. Limitation of Liability. In no event and under no legal theory, whether in tort (including negligence), contract, or otherwise, unless required by applicable law (such as deliberate and grossly negligent

acts) or agreed to in writing, shall any Contributor be liable to You for damages, including any direct, indirect, special, incidental, or consequential damages of any character arising as a result of this License or out of the use or inability to use the Work (including but not limited to damages for loss of goodwill, work stoppage, computer failure or malfunction, or any and all other commercial damages or losses), even if such Contributor has been advised of the possibility of such damages.

9. Accepting Warranty or Additional Liability. While redistributing the Work or Derivative Works thereof, You may choose to offer, and charge a fee for, acceptance of support, warranty, indemnity, or other liability obligations and/or rights consistent with this License. However, in accepting such obligations, You may act only on Your own behalf and/ or Your sole responsibility, not on behalf of any other Contributor, and only if You agree to indemnify, defend, and hold each Contributor harmless for any liability incurred by, or claims asserted against, such Contributor by reason of your accepting any such warranty or additional liability.

END OF TERMS AND CONDITIONS

=====

Copyright (c) 2003-2016, Jouni Malinen

<j@w1.fi> and contributors All Rights Reserved.

This program is licensed under the BSD license (the one with advertisement clause removed).

If you are submitting changes to the project, please see CONTRIBUTIONS file for more instructions.

License

This software may be distributed, used, and modified under the terms of BSD license:

Redistribution and use in source and binary forms, with or without modification, are permitted provided that the following conditions are met:

1. Redistributions of source code must retain the above copyright notice, this list of conditions and the following disclaimer.
2. Redistributions in binary form must reproduce the above copyright notice, this list of conditions and the following disclaimer in the documentation and/or other materials provided with the distribution.
3. Neither the name(s) of the above-listed copyright holder(s) nor the names of its contributors may be used to endorse or promote products derived from this software without specific prior written permission.

THIS SOFTWARE IS PROVIDED BY THE COPYRIGHT HOLDERS AND CONTRIBUTORS "AS IS" AND ANY EXPRESS OR IMPLIED WARRANTIES, INCLUDING, BUT NOT LIMITED TO, THE IMPLIED WARRANTIES OF MERCHANTABILITY AND FITNESS FOR A PARTICULAR PURPOSE ARE DISCLAIMED. IN NO EVENT SHALL THE COPYRIGHT OWNER OR CONTRIBUTORS BE LIABLE FOR ANY DIRECT, INDIRECT, INCIDENTAL, SPECIAL, EXEMPLARY, OR CONSEQUENTIAL DAMAGES (INCLUDING, BUT NOT LIMITED TO, PROCUREMENT OF SUBSTITUTE GOODS OR SERVICES; LOSS OF USE, DATA, OR PROFITS; OR BUSINESS INTERRUPTION) HOWEVER CAUSED AND ON ANY THEORY OF LIABILITY, WHETHER IN CONTRACT, STRICT LIABILITY, OR TORT (INCLUDING NEGLIGENCE OR OTHERWISE) ARISING IN ANY WAY OUT OF THE USE OF THIS SOFTWARE, EVEN IF ADVISED OF THE POSSIBILITY OF SUCH DAMAGE.

Free RTOS

The FreeRTOS source code is licensed by a "modified" GNU General Public License (GPL). The modification is provided in the form of an exception.

NOTE: The modification to the GPL is included to allow you to distribute a combined work that includes FreeRTOS without being obliged to provide the source code for proprietary components outside of the FreeRTOS kernel.

Copyright②

The FreeRTOS GPL Exception Text:
Any FreeRTOS source code, whether modified or in its original release form, or whether in whole or in part, can only be distributed by you under the terms of the GNU General Public License plus this exception. An independent module is a module which is not derived from or based on FreeRTOS.

Clause 1:

Linking FreeRTOS statically or dynamically with other modules is making a combined work based on FreeRTOS. Thus, the terms and conditions of the GNU General Public License cover the whole combination.

As a special exception, the copyright holder of FreeRTOS gives you permission to link FreeRTOS with independent modules that communicate with FreeRTOS solely through the FreeRTOS API interface, regardless of the license terms of these independent modules, and to copy and distribute the resulting combined work under terms of your choice, provided that

- + Every copy of the combined work is accompanied by a written statement that details to the recipient the version of FreeRTOS used and an offer by yourself to provide the FreeRTOS source code (including any modifications you may have made) should the recipient request it.
- + The combined work is not itself an RTOS, scheduler, kernel or related product.
- + The independent modules add significant and primary functionality to FreeRTOS and do not merely extend the existing functionality already present in FreeRTOS.

Clause 2:

FreeRTOS may not be used for any competitive or comparative purpose, including the publication of any form of run time or compile time metric, without the express permission of Real Time Engineers Ltd. (this is the norm within the industry and is intended to ensure information accuracy).

The standard GPL exception text:

GNU GENERAL PUBLIC LICENSE Version 2, June 1991

Copyright (C) 1989, 1991 Free Software Foundation, Inc. 59 Temple Place, Suite 330, Boston, MA 02111-1307 USA
Everyone is permitted to copy and distribute verbatim copies of this license document, but changing it is not allowed.

Preamble

The licenses for most software are designed to take away your freedom to share and change it. By contrast, the GNU General Public License is intended to guarantee your freedom to share and change free software—to make sure the software is free for all its users.

This General Public License applies to most of the Free Software Foundation's software and to any other program whose authors commit to using it. (Some other Free Software Foundation software is covered by the GNU Library General Public License instead.) You can apply it to your programs, too.

When we speak of free software, we are referring to freedom, not price. Our General Public Licenses are designed to make sure that you have the freedom to distribute copies of free software (and charge for this service if you wish), that you receive source code or can get it if you want it, that you can change the software or use pieces of it in new free programs; and that you know you can do these things.

To protect your rights, we need to make restrictions that forbid anyone to deny you these rights or to ask you to surrender the rights.

These restrictions translate to certain responsibilities for you if you distribute copies of the software, or if you modify it.

For example, if you distribute copies of such a program, whether gratis or for a fee, you must give the recipients all the rights that you have. You must make sure that they, too, receive or can get the source code. And you must show them these terms so they know their rights.

We protect your rights with two steps: (1) copyright the software, and (2) offer you this license which gives you legal permission to copy, distribute and/or modify the software.

Also, for each author's protection and ours, we want to make certain that everyone understands that there is no warranty for this free software. If the software is modified by someone else and passed on, we want its recipients to know that what they have is not the original, so that any problems introduced by others will not reflect on the original authors' reputations.

Finally, any free program is threatened constantly by software patents. We wish to avoid the danger that redistributors of a free program will individually obtain patent licenses, in effect making the program proprietary. To prevent this, we have made it clear that any patent must be licensed for everyone's free use or not licensed at all.

The precise terms and conditions for copying, distribution and modification follow.

GNU GENERAL PUBLIC LICENSE TERMS AND CONDITIONS FOR COPYING, DISTRIBUTION AND MODIFICATION

0. This License applies to any program or other work which contains a notice placed by the copyright holder saying it may be distributed under the terms of this General Public License. The "Program", below, refers to any such program or work, and a "work based on the Program" means either the Program or any derivative work under copyright law: that is to say, a work containing the Program or a portion of it, either verbatim or with modifications and/or translated into another language. (Hereinafter, translation is included without limitation in the term "modification".) Each licensee is addressed as "you".

Activities other than copying, distribution and modification are not covered by this License; they are outside its scope. The act of running the Program is not restricted, and the output from the Program is covered only if its contents constitute a work based on the Program (independent of having been made by running the Program). Whether that is true depends on what the Program does.

1. You may copy and distribute verbatim copies of the Program's source code as you receive it, in any medium, provided that you conspicuously and appropriately publish on each copy an appropriate copyright notice and disclaimer of warranty; keep intact all the notices that refer to this License and to the absence of any warranty; and give any other recipients of the Program a copy of this License along with the Program.

You may charge a fee for the physical act of transferring a copy, and you may at your option offer warranty protection in exchange for a fee.

2. You may modify your copy or copies of the Program or any portion of it, thus forming a work based on the Program, and copy and distribute such modifications or work under the terms of Section 1 above, provided that you also meet all of these conditions:

- a) You must cause the modified files to carry prominent notices stating that you changed the files and the date of any change.
- b) You must cause any work that you distribute or publish, that in whole or in part contains or is derived from the Program or any part thereof, to be licensed as a whole at no charge to all third parties under the terms of this License.
- c) If the modified program normally reads commands interactively when run, you must cause it, when started running for such interactive use in the most ordinary way, to print or display an announcement including an appropriate copyright notice and a notice that there is no warranty (or else, saying that you provide a warranty) and that users may redistribute the program under these conditions, and telling the user how to view a copy of this License. (Exception: if the Program itself is interactive but does not normally print such an announcement, your work based on the Program is not required to print an announcement.)

Copyright³

These requirements apply to the modified work as a whole. If identifiable sections of that work are not derived from the Program, and can be reasonably considered independent and separate works in themselves, then this License, and its terms, do not apply to those sections when you distribute them as separate works. But when you distribute the same sections as part of a whole which is a work based on the Program the distribution of the whole must be on the terms of this License, whose permissions for other licensees extend to the entire whole, and thus to each and every part regardless of who wrote it.

Thus, it is not the intent of this section to claim rights or contest your rights to work written entirely by you; rather, the intent is to exercise the right to control the distribution of derivative or collective works based on the Program.

In addition, mere aggregation of another work not based on the Program with the Program (or with a work based on the Program) on a volume or a storage or distribution medium does not bring the other work under the scope of this License.

3. You may copy and distribute the Program (or a work based on it, under Section 2) in object code or executable form under the terms of Sections 1 and 2 above provided that you also do one of the following:

- a) Accompany it with the complete corresponding machine-readable source code, which must be distributed under the terms of Sections 1 and 2 above on a medium customarily used for software interchange; or,
- b) Accompany it with a written offer, valid for at least three years, to give any third party, for a charge no more than your cost of physically performing source distribution, a complete machine-readable copy of the corresponding source code, to be distributed under the terms of Sections 1 and 2 above on a medium customarily used for software interchange; or,
- c) Accompany it with the information you received as to the offer to distribute corresponding source code. (This alternative is allowed only for noncommercial distribution and only if you received the program in object code or executable form with such an offer, in accord with Subsection b above.)

The source code for a work means the preferred form of the work for making modifications to it. For an executable work, complete source code means all the source code for all modules it contains, plus any associated interface definition files, plus the scripts used to control compilation and installation of the executable. However, as a special exception, the source code distributed need not include anything that is normally distributed (in either source or binary form) with the major components (compiler, kernel, and so on) of the operating system on which the executable runs, unless that component itself accompanies the executable.

If distribution of executable or object code is made by offering access to copy from a designated place, then offering equivalent access to copy the source code from the same place counts as distribution of the source code, even though third parties are not compelled to copy the source along with the object code.

4. You may not copy, modify, sublicense, or distribute the Program except as expressly provided under this License. Any attempt otherwise to copy, modify, sublicense or distribute the Program is void, and will automatically terminate your rights under this License.

However, parties who have received copies, or rights, from you under this License will not have their licenses terminated so long as such parties remain in full compliance.

5. You are not required to accept this License, since you have not signed it. However, nothing else grants you permission to modify or distribute the Program or its derivative works. These actions are prohibited by law if you do not accept this License. Therefore, by modifying or distributing the Program (or any work based on the Program), you indicate your acceptance of this License to do so, and all its terms and conditions for copying, distributing or modifying the Program or works based on it.

6. Each time you redistribute the Program (or any work based on the Program), the recipient automatically receives a license from the original licensor to copy, distribute or modify the Program subject to these terms and conditions. You may not impose any further restrictions on the recipients' exercise of the rights granted herein. You are not responsible for enforcing compliance by third parties to this License.

7. If, as a consequence of a court judgment or allegation of patent infringement or for any other reason (not limited to patent issues), conditions are imposed on you (whether by court order, agreement or otherwise) that contradict the conditions of this License, they do not excuse you from the conditions of this License. If you cannot distribute so as to satisfy simultaneously your obligations under this License and any other pertinent obligations, then as a consequence you may not distribute the Program at all. For example, if a patent license would not permit royalty-free redistribution of the Program by all those who receive copies directly or indirectly through you, then the only way you could satisfy both it and this License would be to refrain entirely from distribution of the Program.

If any portion of this section is held invalid or unenforceable under any particular circumstance, the balance of the section is intended to apply and the section as a whole is intended to apply in other circumstances. It is not the purpose of this section to induce you to infringe any patents or other property right claims or to contest validity of any such claims; this section has the sole purpose of protecting the integrity of the free software distribution system, which is implemented by public license practices. Many people have made generous contributions to the wide range of software distributed through that system in reliance on consistent application of that system; it is up to the author/donor to decide if he or she is willing to distribute software through any other system and a licensee cannot impose that choice.

This section is intended to make thoroughly clear what is believed to be a consequence of the rest of this License.

8. If the distribution and/or use of the Program is restricted in certain countries either by patents or by copyrighted interfaces, the original copyright holder who places the Program under this License may add an explicit geographical distribution limitation excluding those countries, so that distribution is permitted only in or among countries not thus excluded. In such case, this License incorporates the limitation as if written in the body of this License.

9. The Free Software Foundation may publish revised and/or new versions of the General Public License from time to time. Such new versions will be similar in spirit to the present version, but may differ in detail to address new problems or concerns. Each version is given a distinguishing version number. If the Program specifies version number of this License which applies to it and "any later version", you have the option of following the terms and conditions either of that version or of any later version published by the Free Software Foundation. If the Program does not specify a version number of this License, you may choose any version ever published by the Free Software Foundation.

10. If you wish to incorporate parts of the Program into other free programs whose distribution conditions are different, write to the author to ask for permission. For software which is copyrighted by the Free Software Foundation, write to the Free Software Foundation; we sometimes make exceptions for this. Our decision will be guided by the two goals of preserving the free status of all derivatives of our free software and of promoting the sharing and reuse of software generally.

Copyright③

NO WARRANTY

11. BECAUSE THE PROGRAM IS LICENSED FREE OF CHARGE, THERE IS NO WARRANTY FOR THE PROGRAM, TO THE EXTENT PERMITTED BY APPLICABLE LAW. EXCEPT WHEN OTHERWISE STATED IN WRITING THE COPYRIGHT HOLDERS AND/OR OTHER PARTIES PROVIDE THE PROGRAM "AS IS" WITHOUT WARRANTY OF ANY KIND, EITHER EXPRESSED OR IMPLIED, INCLUDING, BUT NOT LIMITED TO, THE IMPLIED WARRANTIES OF MERCHANTABILITY AND FITNESS FOR A PARTICULAR PURPOSE. THE ENTIRE RISK AS TO THE QUALITY AND PERFORMANCE OF THE PROGRAM IS WITH YOU. SHOULD THE PROGRAM PROVE DEFECTIVE, YOU ASSUME THE COST OF ALL NECESSARY SERVICING, REPAIR OR CORRECTION.

12. IN NO EVENT UNLESS REQUIRED BY APPLICABLE LAW OR AGREED TO IN WRITING WILL ANY COPYRIGHT HOLDER, OR ANY OTHER PARTY WHO MAY MODIFY AND/OR REDISTRIBUTE THE PROGRAM AS PERMITTED ABOVE, BE LIABLE TO YOU FOR DAMAGES, INCLUDING ANY GENERAL, SPECIAL, INCIDENTAL OR CONSEQUENTIAL DAMAGES ARISING OUT OF THE USE OR INABILITY TO USE THE PROGRAM (INCLUDING BUT NOT LIMITED TO LOSS OF DATA OR DATA BEING RENDERED INACCURATE OR LOSSES SUSTAINED BY YOU OR THIRD PARTIES OR A FAILURE OF THE PROGRAM TO OPERATE WITH ANY OTHER PROGRAMS), EVEN IF SUCH HOLDER OR OTHER PARTY HAS BEEN ADVISED OF THE POSSIBILITY OF SUCH DAMAGES.

END OF TERMS AND CONDITIONS

How to Apply These Terms to Your New Programs

If you develop a new program, and you want it to be of the greatest possible use to the public, the best way to achieve this is to make it free software which everyone can redistribute and change under these terms.

To do so, attach the following notices to the program. It is safest to attach them to the start of each source file to most effectively convey the exclusion of warranty; and each file should have at least the "copyright" line and a pointer to where the full notice is found.

<one line to give the program's name and a brief idea of what it does.>

Copyright (C) <year> <name of author>

This program is free software; you can redistribute it and/or modify it under the terms of the GNU General Public License** as published by the Free Software Foundation; either version 2 of the License, or (at your option) any later version.

This program is distributed in the hope that it will be useful, but WITHOUT ANY WARRANTY; without even the implied warranty of MERCHANTABILITY or FITNESS FOR A PARTICULAR PURPOSE. See the GNU General Public License for more details.

You should have received a copy of the GNU General Public License along with this program; if not, write to the Free Software Foundation, Inc., 59 Temple Place, Suite 330, Boston, MA 02111- 1307 USA

Also add information on how to contact you by electronic and paper mail.

If the program is interactive, make it output a short notice like this when it starts in an interactive mode:

Gnomovision version 69, Copyright (C) year name of author
Gnomovision comes with ABSOLUTELY NO WARRANTY; for details type `show w`.

This is free software, and you are welcome to redistribute it under certain conditions; type `show c` for details.

The hypothetical commands `show w` and `show c` should show the appropriate parts of the General Public License. Of course, the commands you use may be called something other than `show w` and `show c`; they could even be mouseclicks or menu items--whatever suits your program.

You should also get your employer (if you work as a programmer) or your school, if any, to sign a "copyright disclaimer" for the program, if necessary. Here is a sample; alter the names:

Yoyodyne, Inc., hereby disclaims all copyright interest in the program "Gnomovision" (which makes passes at compilers) written by James Hacker.

<signature of Ty Coon>, 1 April 1989

Ty Coon, President of Vice

This General Public License does not permit incorporating your program into proprietary programs. If your program is a subroutine library, you may consider it more useful to permit linking proprietary applications with the library. If this is what you want to do, use the GNU Library General Public License instead of this License.

Setting Information

Indoor unit model name	
Indoor unit serial number	
Outdoor unit model name	
Outdoor unit serial number	
System commissioning date	
Remote controller installation date	

Installer Contact Details

Name	
Telephone number	

Regulatory Information



Authorized representative in EU Panasonic Testing Centre Panasonic Marketing Europe GmbH Winsbergring 15, 22525 Hamburg, Germany

Panasonic Corporation
<http://www.panasonic.com>

© Panasonic Corporation 2020
Printed in China

ACXF55-27551
F0820-10920