

***komfovent***<sup>®</sup>



# VERSO Standard Units

**EN** Installation and Maintenance Service Manual

## Content

<b>1. SAFETY REQUIREMENTS</b> .....	3
<b>2. TRANSPORTATION</b> .....	3
<b>3. BRIEF DESCRIPTION OF THE UNIT</b> .....	5
<b>4. INSTALLATION</b> .....	9
4.1. Maintenance space requirements .....	9
<b>5. CONDENSATE DRAIN CONNECTIONS</b> .....	11
5.1. Water trap installation for a unit section mounted on the suction side.....	11
5.2. Water trap installation for a unit section mounted on the pressure side .....	12
<b>6. SECTION-TO-SECTION JOINTS</b> .....	12
6.1. Heating coil connection .....	12
<b>7. MAINTENANCE</b> .....	14
<b>8. TECHNICAL INFORMATION</b> .....	15



This symbol indicates that this product is not to be disposed of with your household waste, according to the WEEE Directive (2002/96/EC) and your national law. This product should be handed over to a designated collection point, or to an authorised collection site for recycling waste electrical and electronic equipment (EEE). Improper handling of this type of waste could have a possible negative impact on the environment and human health due to potentially hazardous substances that are generally associated with EEE. At the same time, your cooperation in the correct disposal of this product will contribute to the effective usage of natural resources. For more information about where you can drop off your waste equipment for recycling, please contact your local city office, waste authority, approved WEEE scheme or your household waste disposal service.

## 1. SAFETY REQUIREMENTS

	<ul style="list-style-type: none"> <li>• To avoid accidents and/or unit damage, only a trained technician must carry out the connection.</li> <li>• The appropriate Personal Protective Equipment (PPE) attire is worn relative to the operation being carried out.</li> <li>• Electrical equipment is rated, connected and earthed in accordance with CE regulations.</li> </ul>
---	---

The air handling unit must be plugged in to an electrical outlet (with earth), which is in good order and corresponds with all requirements of electric safety. Before starting any operations inside the unit, make sure that the unit is switched off, and the power cable is unplugged.

	<ul style="list-style-type: none"> <li>• Earth must be installed according EN61557, BS 7671.</li> <li>• The unit should be installed according to Installation and Maintenance Manual.</li> <li>• Before starting the unit, check correct position of air filters.</li> <li>• Service maintenance should be carried out only in conformity with the instructions specified herein below.</li> <li>• If main cable is damaged, only manufacturer, service team or trained technician must change it in order to avoid accidents.</li> </ul>
---	--

## 2. TRANSPORTATION

The air handling units are ready for transit and storage (1 Picture). The unit is packed to prevent damage of the external and internal parts of the unit, dust and moisture penetration.

Corners of the air handling units are protected against the damage – protective corners are used. The entire unit is wrapped up in protective film. For transit or storage, units are mounted on timber pallets. The unit is fastened to the pallet with polypropylene packing tape over protective corners.

### Vertical and horizontal units ready for transit and storage

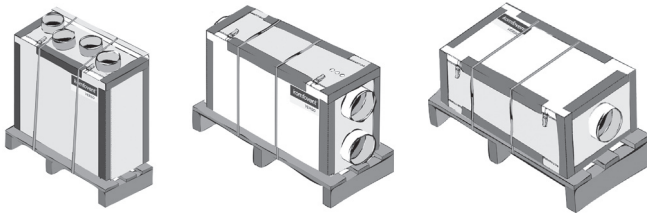

1 Picture

When unit is loaded or unloaded by crane, cargo rope is fastened in its designated places. Forklift truck or hand pallet truck can transport air handling unit as it is shown (2 a, b, c Pictures).

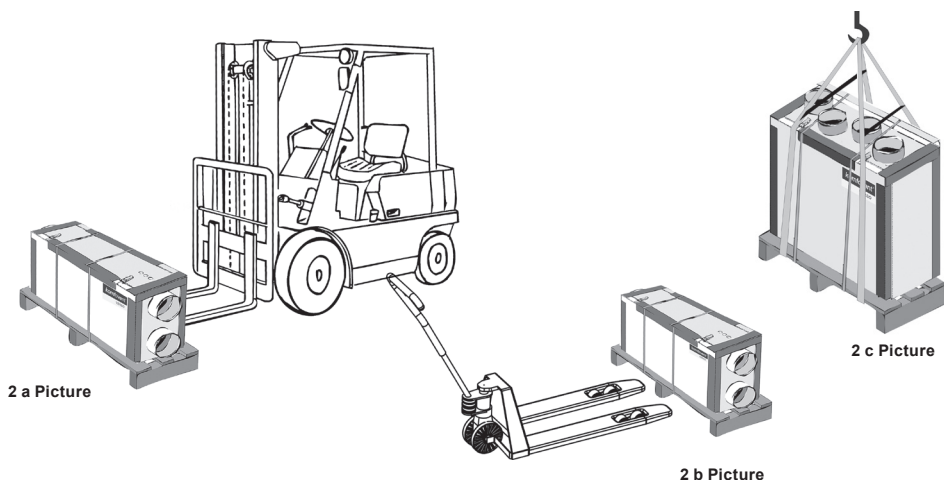
**Vertical and horizontal unit transportation by forklift truck, hand pallet truck or crane**

- 2 a Unit is transported by forklift truck on a wooden pallet;  
2 b Unit is transported by hand pallet truck on a wooden pallet;  
2 c Unit is lifted by crane on a wooden pallet.

The unit should be examined upon receipt, to ensure that no visible damage has occurred during transit, and the advice note checked to ensure that all items have been received. If damage or delivery shortages are discovered, the carrier should be immediately informed. KOMFOVENT should be notified within three days of receipt, with a written confirmation sent within seven days. KOMFOVENT can accept no responsibility for damage by unloading from carrier or for subsequent damage on site.

If the unit is not to be installed immediately, it should be stored in a clean, dry area. If stored externally, it should be adequately protected from the weather.

### 3. BRIEF DESCRIPTION OF THE UNIT

- Casings of air handling units are made of galvanized steel sheets, which are powder painted. Mineral wool is used for thermal insulation and sound attenuation. Unit Verso Standard cover panels are 45–50 mm thick.
- The air handling units are intended for ventilation of medium-sized spaces (eg. single family houses, offices, etc.), having operating ambient temperature and relative humidity. As standard, the unit is designed for indoor placement. The operating temperature range for the unit is -30 °C ... +40 °C, outdoor air temperature.
- Inside of the air handling unit it is integrated heat-exchanger and heater (or cooler), which compensates losses of the heat/cold during ventilation of the premises, thus AHU is not recommended to be used as main heating/cooling source of the building. AHU may not reach the supply temperature setpoint if the actual room temperature differs a lot from the desired value, since in that case heat exchanger capacity will be low.
- The air handling unit is not to be used to transport solid particles, even not in areas where there is a risk of explosive gases.
- Before you open the door, the unit must be switched off and the fans must have been given time to stop (up to 3 minutes).
- The unit contains heating elements that must not be touched when they are hot.
- We recommend to leave air handling unit in working mode (minimum 20 percent of power) during the first operation year. Due to moisture in building constructions, condensation may occur inside and outside the air handling unit. Continuous operation of the equipment will significantly reduce the risk of condensation.
- To maintain a good indoor climate, comply with regulations and, to avoid condensation damage, the unit must never be stopped apart from during service/maintenance or in connection with an accident.
- If the unit is placed in spaces with high humidity, condensation might occur on the surface of the unit when outdoor temperatures are very low.
- Under conditions, when the outdoor air temperature is low and humidity is high, risk of heat exchanger frosting may appear. For this reason anti-frost protection function is foreseen in the controller of the Komfovent air handling units. Depending on the type of the air handling unit, different methods of anti-frost protection are available: cold air by-passing, supply air fan speed reducing and/or integrated preheater. Counter cross flow heat exchanger is the mostly sensitive for low outside air temperatures, as the risk of frosting appears in the temperature range from 0 to -5 °C and below. Standard aluminium cross-flow plate heat exchanger has better features, as the risk of freezing appears only at -10 °C. The lowest risk and the highest resistance to cold outside air is a competitive feature of the rotary heat exchanger, as it is not freezing even at the temperatures of -30 °C if the humidity level of the air is appropriate.



In the units with counter flow or cross flow plate exchangers without integrated preheater, it is necessary to install additional duct mounted preheater in the outside air intake duct, which will ensure temperature of the intake air higher than -4 °C.

- If you choose to operate without the primary heater, it is necessary to increase the power of the secondary heater through a cold air damper.

Air Handling Units Schemes

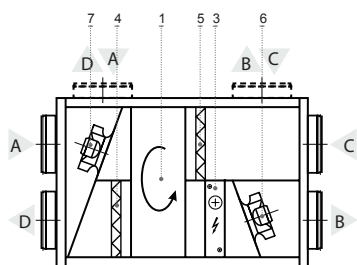

VERSO R  
1000 UH/UV/H/V

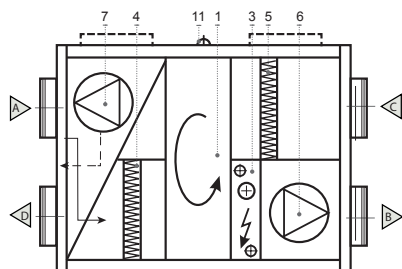

VERSO R  
1300 UH/UV/H/V / 1500 UH/UV/H/V / 1700 UH/UV/H/V /  
2000 UH/UV/H/V

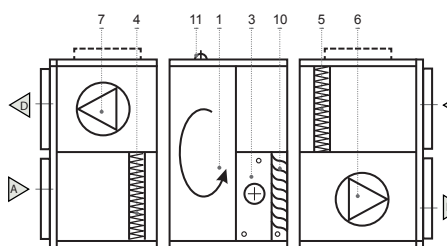

VERSO R  
3000 UH/UV/H/V / 4000 UH/UV/H/V

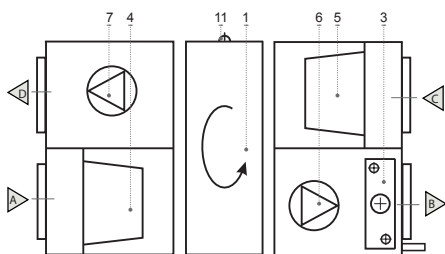

VERSO R  
7000 H

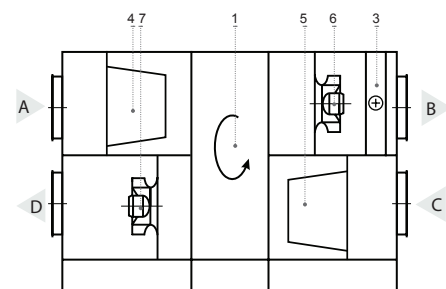

VERSO R 2500 H

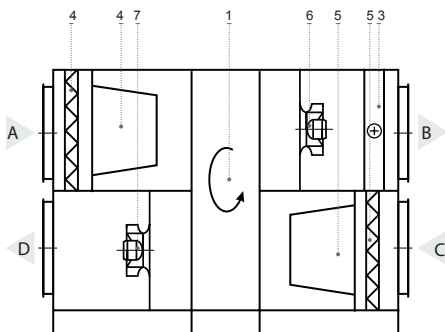

VERSO R 5000 H

- |  |                  |
|--|------------------|
| 1. Rotary heat exchanger   | △ Outdoor intake |
| 2. Plate heat exchanger  | △ Supply air     |
| 3. Electric or water air heater                                  | △ Extract indoor |
| 4. Supply air filter   | △ Exhaust air    |
| 5. Exhaust air filter  |                  |
| 6. Supply fan  |                  |
| 7. Exhaust fan   |                  |
| 8. Air by-pass damper  |                  |
| 9. Condensate drain (the water trap must be installed D = 28 mm) |                  |
| 10. Drop eliminator  |                  |
| 11. Connection of main cable                                     |                  |
| 12. Water connection tube  |                  |

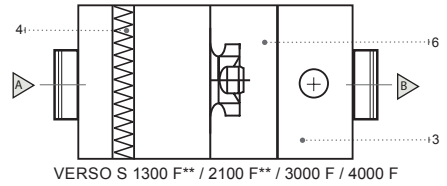
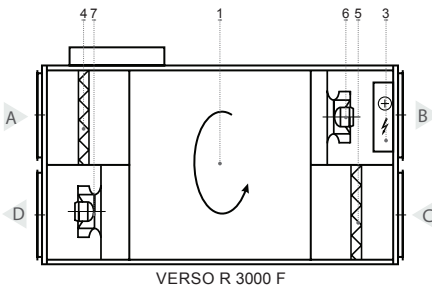
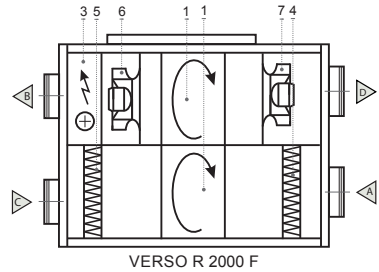
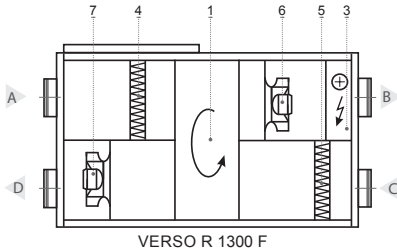

\*\* Ducted water heater.

- |  |                  |
|--|------------------|
| 1. Rotary heat exchanger   |                  |
| 2. Plate heat exchanger  |                  |
| 3. Electric or water air heater                                  |                  |
| 4. Supply air filter   |                  |
| 5. Exhaust air filter  |                  |
| 6. Supply fan  |                  |
| 7. Exhaust fan   |                  |
| 8. Air by-pass damper  |                  |
| 9. Condensate drain (the water trap must be installed D = 28 mm) |                  |
| 10. Drop eliminator  |                  |
| 11. Connection of main cable                                     |                  |
| 12. Water connection tube  |                  |
|  | △ Outdoor intake |
|  | △ Supply air     |
|  | △ Extract indoor |
|  | △ Exhaust air    |

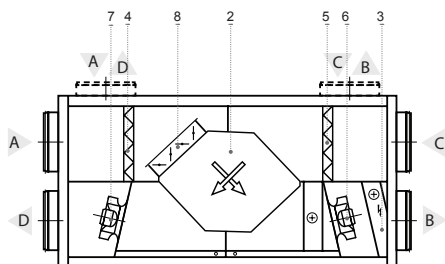

VERSO CF 1000 U/H/V

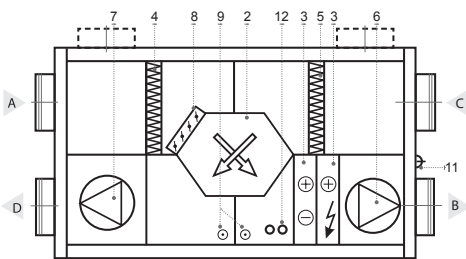

VERSO CF 1300 UH/UV/H/V / 1700 UH/UV/H/V

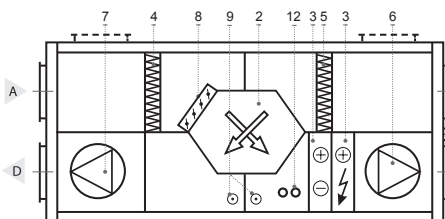

VERSO CF 2300 UH/UV/H/V

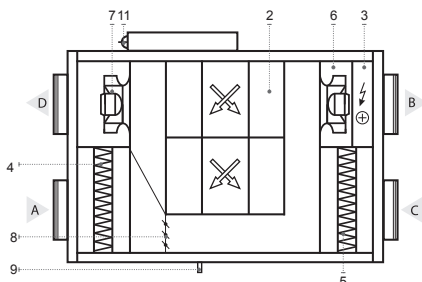

VERSO CF 1300 F / 1500 F

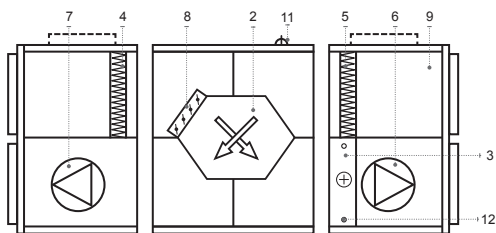

VERSO CF 3500 UH/UV/H/V

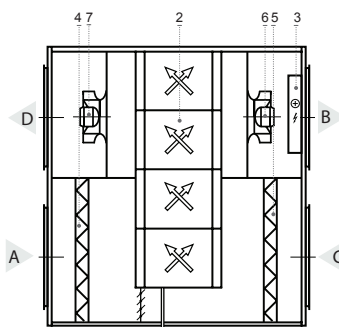

VERSO CF 2500 F

- |  |                  |
|--|------------------|
| 1. Rotary heat exchanger   | ▲ Outdoor intake |
| 2. Plate heat exchanger  | ▲ Supply air     |
| 3. Electric or water air heater                                  | ▲ Extract indoor |
| 4. Supply air filter   | ▲ Exhaust air    |
| 5. Exhaust air filter  |                  |
| 6. Supply fan  |                  |
| 7. Exhaust fan   |                  |
| 8. Air by-pass damper  |                  |
| 9. Condensate drain (the water trap must be installed D = 28 mm) |                  |
| 10. Drop eliminator  |                  |
| 11. Connection of main cable                                     |                  |
| 12. Water connection tube  |                  |



**4. INSTALLATION**

**4.1. Maintenance space requirements**

It is recommended to install the air handling unit in a separate room or in the attic on a hard smooth surface insulated with a rubber mat. The minimum free space in front of the control panel should be not less than 700 mm. The free space over the top of the unit should be at least 300 mm (3.1 a, b Picture). Rubber vibration absorbers must be used when unit is going to be mounted on the wall or ceiling.

The place for the unit must be selected with allowance for minimum access to the unit for maintenance or service and must comply with safety requirements. Opening for inspection can not be smaller than dimensions of the unit and unit itself must be mounted in a way, that if needed (for example in case of complicated repair) it can be easily dismantled.

**Minimum Maintenance Space for Horizontal Units**

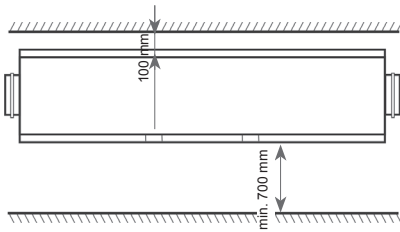

3.1 a Picture

**Minimum Maintenance Space for Vertical Units**

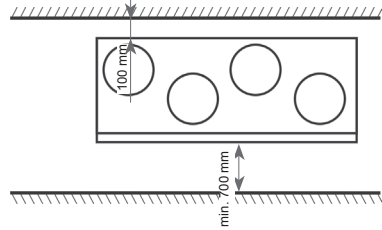

3.1 b Picture

**Verso Standard unit Installation Scheme**

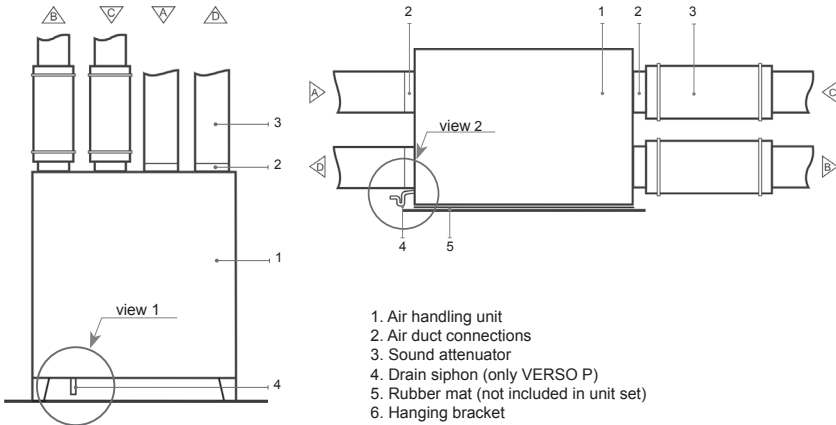

- 1. Air handling unit
- 2. Air duct connections
- 3. Sound attenuator
- 4. Drain siphon (only VERSO P)
- 5. Rubber mat (not included in unit set)
- 6. Hanging bracket
- 7. Ceiling holder (Included in the unit set)

**Verso Standard Maintenance space for unit**

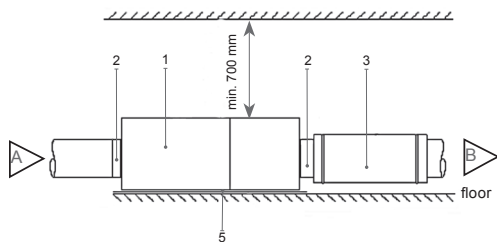

3.1 c Picture\*

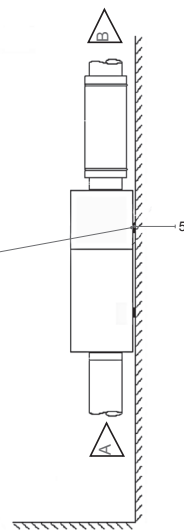

3.1 e Picture\*\*

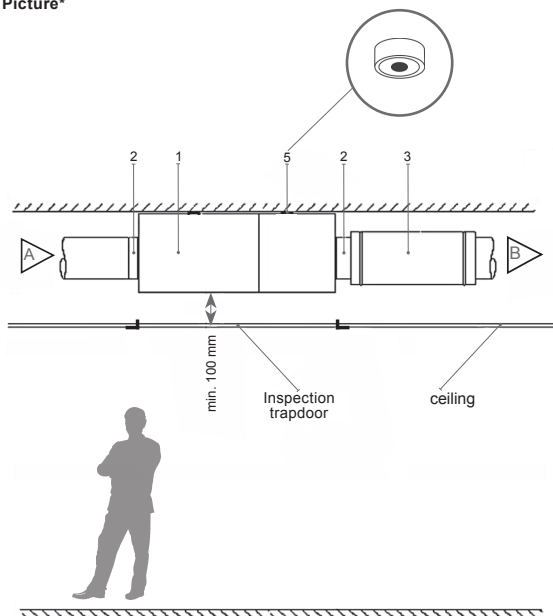

3.1 d Picture

**VERSO R 1300 F-VERSO R 2000 F**

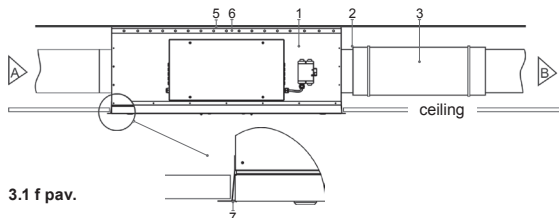

3.1 f pav.

1. Air handling unit
2. Air duct connections
3. Sound attenuator
4. Drain siphon (only VERSO P)
5. Rubber mat (not included in unit set)
6. Hanging bracket
7. Ceiling holder (Included in the unit set)

Unit holder is made of 2,5 mm galvanized steel sheets according to EN 10142.

\* Only for VERSO S 1300 F/2100 F with duct heater.

\*\* Only for VERSO S 1300 F/2100 F with duct heater.

## 5. CONDENSATE DRAIN CONNECTIONS

All condensate drain connections must be correctly trapped. Incorrect trapping can result in flooding within the unit and consequent flooding of the immediate area. Fill the drain trap with water before starting up the unit.

All drain lines should be insulated where passing through any space where damage from condensation drip might occur. If the unit is installed in unheated premises the condensate pipe should be heat-insulated and heated with heating cable.

**A condensate pipe and a drain trap**  
**Drain scheme of Vertical Unit**                      **Drain scheme of Horizontal Unit**

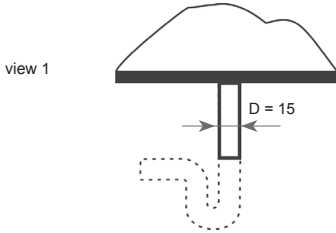

4 a Picture

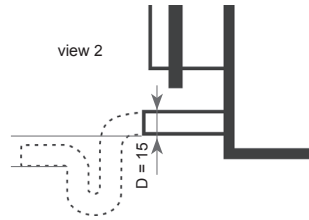

4 b Picture

\* VERSO P 1600-2000 – D = 28 mm

The bend of the water trap can be repositioned by turning it to the right or the left. The drain line from the water trap must be arranged so that it will not damage adjacent unit sections or building elements. If the drain line is run through cold spaces, it should be insulated to prevent freezing. A heating cable may be required.

### 5.1. Water trap installation for a unit section mounted on the suction side

Since the fans in most air handling units are last in the chain of functions and generate sub-atmospheric pressure inside the unit, it is very important to correctly install the water trap. Because of that reason condensate can be hardly eliminated from the air handling unit and the technical premise may get covered with condensate. Height  $H_1$  must be at least equivalent in mm to half of the negative pressure inside the unit in mm water gauge. Height  $H_2$  must be at least equivalent in mm to the negative pressure inside the unit in mm water gauge.

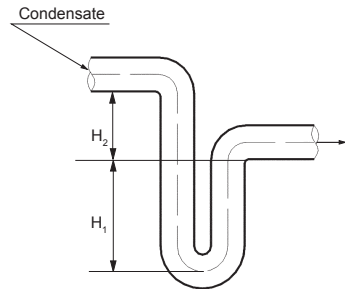
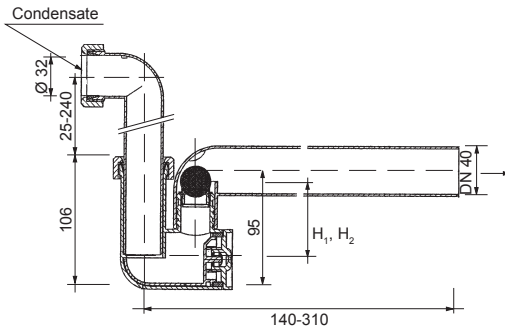

**⚠ Precaution:** The drainage siphon should be mounted on the outlet fitting pipe of every drip tray for complete condensate drainage from the air handling unit and prevention of penetration of offensive odours from an effluent into the ventilation system.

**⚠** In case of the outdoor operation of the air handling unit, the siphon and the bleeders should be heated with an electric thermal cable (if ambient air temperature  $t_{amb} < 0$  °C). The siphon and the bleeders should be heat-insulated with an insulating material.

**5.2. Water trap installation for a unit section mounted on the pressure side**

Since the fans in most air handling units are not last in the chain of functions and generate over-atmospheric pressure inside the cooling section. In such case the consisted condensate can be easily removed from AHU and there will be no strict requirements for siphon's installation. A drainage siphon is enough with a minimum rake.

RECOMMENDATION: The drainage siphon must be installed in connection with not less size pipe diameter.

Any drainage systems must not be connected directly to the municipal sewage system. The condensate tray shall be easily accessible for cleaning and disinfection.

**6. SECTION-TO-SECTION JOINTS**

Air handling units VERSO R 3000 U, 4000 U, 4500 U and 7000 H are produced from three sections. Separate sections are easy to install on site. Ensure that sections or section assemblies are positioned in their proper sequence and that the unit handling and reference is correct. Sections should be accurately aligned prior to bolting together using the fixings and gaskets provided. The sealing gasket and fastening parts are available with every air handling unit. Incorrect installation will result in air leakage, air blow marks to the unit casings and unacceptable noise. Section connection scheme is shown in 5 Picture.

**Section Connection Scheme**

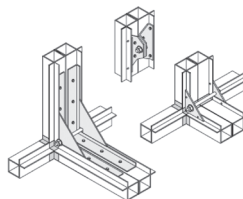

**6.1. Heating coil connection<sup>1</sup>**

Pipe work should be connected in accordance with good engineering practice. All pipe work must be adequately supported to ensure that no additional load is stressing the unit. Mounting the pipes on the heating coil, tight the pipes with spanners. As shown in 5.1 Picture.

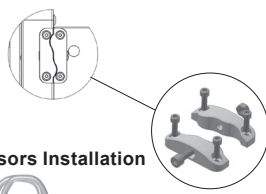

**5 Picture**

**Fitting Pipes Connection**

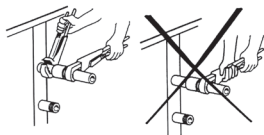

**Sensors Installation**

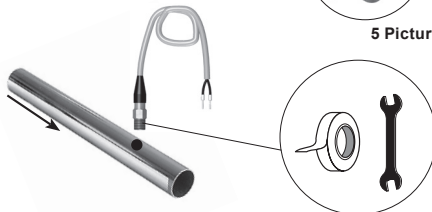

**5.1 Picture**

<sup>1</sup> If water heater build in.

The pipe work should be done in order to ensure the space for maintenance and service work. When carrying out the installation of heater pipes, make sure that hot water supply is completely disconnected. Before start-up of the air handling unit, the heater system should be filled in with water. Glycol is used in the air handling units with coil heat exchanger. Never pour glycol down a drain; collect it in a receptacle and leave it at a recycling centre or the like. Glycol is highly dangerous to consume and can cause fatal poisoning or damage the kidneys. Contact a doctor! Avoid breathing glycol vapour in confined spaces. If you get glycol in your eyes, flush them thoroughly with water (for about 5 minutes).



When operating air handling unit in the temperatures lower than 0 °C, it is necessary to use glycol additionally or assure the reversible heating agent temperature more than 25 °C.



It is important to maintain air heaters and coolers cleanliness; that is to change filters installed in the air handling unit on time. If the air heater or cooler gets dirty, to perform periodical cleaning.

## Ductwork

The air flows in/out air handling unit through ductwork. We recommend using galvanized steel (Zn 275 gr/m<sup>2</sup>) ductwork, to ensure easy cleaning and durability. It is necessary to use the ductwork system with low air flow rate and small pressure drop to have necessary air volume and low sound level and save the energy. The appropriate sound attenuators will reduce the noise level of the fans in the premises. All ductwork should be insulated with 50–100 mm thickness insulation to avoid the condensation.

**Note:** *temperature sensor B1 has to be mounted in the supply air duct under electric heater (see the functional diagram in Control System Electrical Installation and Operation Manual). It is necessary to leave space in straight air duct for sensor mounting and guarantee the space for maintenance and service work. Minimal space between the unit and B1 sensor is the space of double air duct diameter.*



Ductwork, steelwork and any other services should not be supported off the unit.



It is recommended to install air dampers in the inlet and outlet ducts. For ventilation units with water air heater, it is mandatory to use inlet air closing damper with spring return mechanism.

## Final Inspection

After installation of the unit, a thorough inspection should be carried out. This should include inspecting the inside of the unit and removing debris and tools, which may have been left behind by on site contractors. Replace any panels, which may have been removed and close all access doors, ensuring that the door sealing gaskets have not been damaged.

## 7. MAINTENANCE

It is recommended to carry out routine maintenance of the air handling unit, 3–4 times per year. VERSO R 1300 F, 2000 F use the key to open the door. Do not release the door to swing freely, but open it slowly at a 90 degree angle. Be careful while opening, because clogged filters might fall out.

### Apžiūros metu taip pat turi būti atliekama:

**1. Rotary heat exchanger check.** Inspection of the rotary heat exchanger is performed once per year. Free rotation of the rotary heat exchanger, continuity of the rotating belt, absence of damages of the rotor drums and the seal gasket are checked. It is necessary to check the stretch of belt. Free belt will slide and the efficiency of rotary heat exchanger will fall down. To reach maximal efficiency, rotor must turn at least 8 times per minute. Polluted heat exchanger will decrease efficiency. Clean heat exchanger with an air blast or wash with tepid water. Check out water falling on the electric motor.

**2. Plate heat exchanger check.** Inspection and dedusting of the plate heat exchanger is performed once per year (it is removed from the unit and blown with an air blast or washed with tepid water).

**Note:** plate heat exchanger may be replaced with summer cassette, when recuperation is needless.

**3. Fans check (once per year).** Polluted fans decrease efficiency.



Before performing any inspection work, check whether the unit is switched off from the electric power supply.

Fans should be carefully cleaned with textile or soft brush. Do not use water. Do not break balance. Check if direction of fan turns is right, because wrong direction of turns gives only 30% rating. Check if fan freely rotates and is not mechanically damaged, if impeller does not touch suction nozzles, fan does not spread noise, the pressure tubes are connected to the nozzle (if it is required), mounting bolts are screwed.

The rubber couplings connecting the motor base and the unit should be visually inspected for signs of wear and replaced as necessary.

Any unusual noise or vibration when the fan is running should be immediately investigated, as this usually an indication of wear or imbalance in the fan system.

**4. Air heater check.** Recommended to perform periodical inspection and cleaning of heater. Check the plates of water air heater. The air heater is cleaned with Hoover from supply air side or with air blast from exhaust air side. If it is very dirty, wash with tepid water, which will not make corrosion of aluminium. Check if position of return water temperature sensor is right. Check if electric air heater is properly fixed, wires connections are not damaged and heating elements are not bent. They can be damaged or bent due to uneven heat or uneven and turbulent air direction. Check if electric air heater is clear of unnecessary things and heating elements are not clogged, because this can cause unpleasant smell or in the worst case – dust can start burning. Heating elements can be cleaned with Hoover or wet textile.

**5. Air damper check (if it is required).** Not fully opened outside air damper rises up the pressure in the system. Water air heater can freeze if outside air damper does not fully close in not working air handling unit. Mounting and running of air damper should be checked and regulated.

**6. Air filter clogging check.** Change air filters when air filter clogging is indicated. We recommend to change filters at least twice per year: before and after heating season, or more<sup>1</sup>.

Filters are one time used. We do not recommend cleaning them. Stop the air handling unit before changing filters.

### Pressure sensor

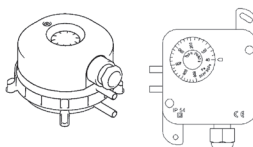

6 Picture

<sup>1</sup> Clogged filters unbalance ventilation system, air handling unit uses more power.

**7. Pressure sensor setting, which indicates impurity of filters.** Pressure sensor is set according to EN 13779:2007 standard: 100 Pa for small systems, 150 Pa for big systems. Remove cover from the pressure sensor and turn the cursor due to proper position. The indicator will turn on when filters will be clogged.

- One of pressure sensors shown in 6 Picture can be mounted in the air handling unit.
- Close the door after pressure sensor regulating process. Be sure that sensor does not indicate impurity of clear filters.

**8. TECHNICAL INFORMATION**

**VERSO R, VERSO P Horizontal and ceiling units**

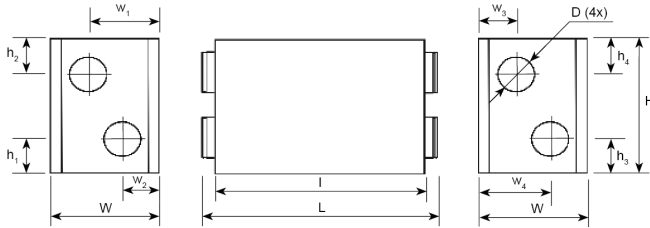

**VERSO R, VERSO P Vertical units**

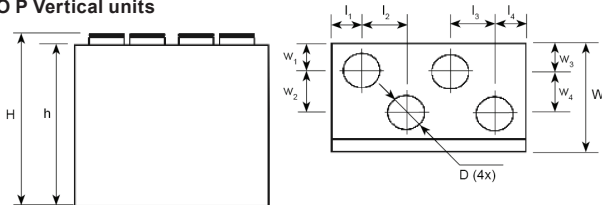

**VERSO S**

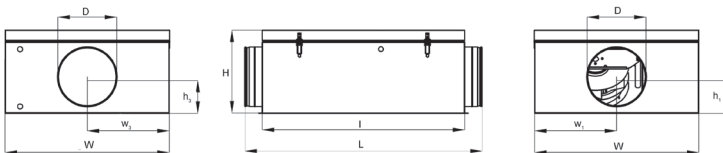

Type	Parameters			Weight	Supply voltage	Operating current	Heater capacity		Fans input power	Ducts connection D
	Width, W	Length, L/l (L <sub>1</sub> , L <sub>2</sub> , L <sub>3</sub> ) <sup>1</sup>	Height, H/h				Hot water	Electric		
<b>VERSO R</b>										
1000 UH/H	905	1505/1355	905	195	3~400 <sup>3</sup>	7,6	-	3,0	2*182	4×315
1000 UV/V	905	1355	980/905	195	3~400 <sup>3</sup>	7,6	-	3,0	2*182	4×315
1300 UH/UV/H/V	905	1505/1355	980/905	195	3~400 <sup>3</sup>	13,2	-	4,5	2*470	4×315
1300 UV/UV/H/V	905	1505/1355	980/905	195	1~230	7,2	3,3	-	2*470	4×315
1300 F	480	1510/1360	1050	135	3~400	11	-	3,0	2*470	4×315
1300 F	480	1510/1360	1050	135	1~230	7,2	4,2	-	2*470	4×315
1500 UH/UV/H/V	905	1505/1355	980/905	195	3~400 <sup>3</sup>	13,2	-	4,5	2*470	4×315
1500 UV/UV/H/V	905	1505/1355	980/905	195	1~230	7,2	4,0	-	2*470	4×315
1700 UH/UV/H/V	910	1547/1485	1030/1000	270	3~400 <sup>3</sup>	13,2	-	4,5	2*470	4×300*400
1700 UV/UV/H/V	910	1547/1485	1030/1000	270	1~230	7,2	5,4	-	2*470	4×300*400
2000 UH/UV/H/V	910	1547/1485	1030/1000	285	3~400 <sup>3</sup>	17,1	-	7,5	2*660	4×300*400
2000 UV/UV/H/V	910	1547/1485	1030/1000	285	1~230	6,8	9,1	-	2*660	4×300*400
3000 UH/UV/H/V	1150	2160/2100 (650,700,750)	1181/1150	440 (135/160/145)	3~400 <sup>3</sup>	16,7	-	9	2*1000	4×400*500
3000 UV/UV/H/V	1150	2160/2100 (650,700,750)	1181/1150	440 (135/160/145)	3~400 <sup>3</sup>	4,2	11,6	-	2*1000	4×400*500
4000 UH/UV/H/V	1150	2160/2100 (650,700,750)	1181/1150	450 (140/160/150)	3~400	27,4	-	15	2*1700	4×400*500
4000 UV/UV/H/V	1150	2160/2100 (650,700,750)	1181/1150	450 (140/160/150)	3~400	6,2	16,6	-	2*1700	4×400*500
2500 H	1000	1606 (618, 370, 618)	1000	340	3~400	22	-	7,5	2*780	4×700*300
2500 H	1000	1606 (618, 370, 618)	1000	340	1~230	11,7	10,9	-	2*780	4×700*300
5000 H	1300	1872	1300	442	3~400	13,1	20,4	-	2*2000	4x1000*500
7000 H	1500	1992/1892	1520	780 (270/230/280)	3~400	18,1	27,9	-	2*2900	1200*600



Parameters  Type	Dimensions			Weight  kg	Supply voltage  V	Operating current  A	Heater capacity		Fans input power  W	Ducts connection D  mm
	Width, W  mm	Length, L/l (L <sub>1</sub> , L <sub>2</sub> , L <sub>3</sub> ) <sup>1</sup>  mm	Height, H/h  mm				Hot water  kW <sup>2</sup>	Electric  kW		
<b>VERSO CF</b>										
1000 UV/V	910	1810	980/905	267	1~230	3,3	2,0	-	2*162	4×315
1000 UV/V	910	1810	980/905	267	3~400 <sup>3</sup>	9,5	-	4,5	2*162	4×315
1000 UH/H	910	1960/1810	905	267	1~230	3,3	2,0	-	2*162	4×315
1000 UH/H	910	1960/1810	905	267	3~400 <sup>3</sup>	9,5	-	4,5	2*162	4×315
1300 UH/UV/H/V	910	1962/1810	980/905	269	1~230	5,5	2,9	-	2*273	4×315
1300 UH/UV/H/V	910	1962/1810	980/905	225	3~400	11,7	-	4,5	2*273	4×315
1700 UH/UV/H/V	910	1962/1810	905/980	270	1~230	6,7	4,2	-	2*470	4×315
1700 UH/UV/H/V	910	1962/1810	905/980	270	3~400	12,9	-	4,5	2*470	4×315
2300 UH/UV/H/V	910	2060/2000	935/905	250	1~230	6,8	5,9	-	2*660	300*400
2300 UH/UV/H/V	910	2060/2000	935/905	250	3~400	17,1	-	7,5	2*660	300*400
1000 F	527	1795/1650	1100	161	1~230	3,3	2,0	-	2*167	4×315
1000 F	527	1795/1650	1100	161	3~400 <sup>3</sup>	7,3	-	3,0	2*167	4×315
1300 F	1100	1795/1650	527	162	1~230	4,8	3,9	-	2*273	4×315
1300 F	1100	1795/1650	527	162	3~400	10,8	-	4,5	2*273	4×315
1500 F	1100	1795/1650	527	162	1~230	7,2	4,7	-	2*470	4×315
1500 F	1100	1795/1650	527	162	3~400	13,2	-	4,5	2*470	4×315
3500 UH/UV/H/V	1150	2500 (750,1000,750)	1150	510 (145/190/175)	3~400	7,1	8,2	-	2*895	400*500
3500 UH/UV/H/V	1150	2500 (750,1000,750)	1150	510 (145/190/175)	3~400	19,8	-	9,0	2*895	400*500
<b>VERSO S</b>										
2100 F**	1000	893	350	73	3~400	25,0	-	15	2*170	700*250
2100 F**	1000	893	350	73	3~400	35,9	-	22,5	2*170	700*250
2100 F	1000	893	350	73	1~230	3,8	28,8	-	2*170	750*250
3000 F	1075	1160	555	125	3~400	2,7	43,3	-	2*1000	600*400
4000 F	1075	1160	555	125	3~400	2,7	55,8	-	2*1000	600*400

Parameters with nominal air volume,  $t_{\text{outside}} = -23\text{ }^{\circ}\text{C}$ ,  $t_{\text{inside}} = 22\text{ }^{\circ}\text{C}$ .

<sup>1</sup> (L<sub>1</sub>, L<sub>2</sub>) – sectional unit.

<sup>2</sup> Parameters of hot water 80–60 °C.

<sup>3</sup> 3~ 230 V is available as an option.

## Dimensions of Ductwork Connection

Type \ Parameter	w <sub>1</sub>	w <sub>2</sub>	w <sub>3</sub>	w <sub>4</sub>	l <sub>1</sub>	l <sub>2</sub>	l <sub>3</sub>	l <sub>4</sub>	h <sub>1</sub>	h <sub>2</sub>	h <sub>3</sub>	h <sub>4</sub>
	mm	mm	mm	mm	mm	mm	mm	mm	mm	mm	mm	mm
<b>Verso R</b>												
1300 UH/H	653	281	281	653	-	-	-	-	246	247	246	247
1300 UV/V	253	400	253	400	250	0	0	250	-	-	-	-
1300 F	220	220	220	220	-	-	-	-	245	250	245	250
1500 UH/H	653	281	281	653	-	-	-	-	246	247	246	247
1500 UV/V	253	400	253	400	250	0	0	250	-	-	-	-
1700 UH/H	624	234	234	624	-	-	-	-	270	270	273	263
1700 UV/V	225	404	225	404	280	0	0	280	-	-	-	-
2000 UH/H	624	234	234	624	-	-	-	-	270	270	273	263
2000 UV/V	225	404	225	404	280	0	0	280	-	-	-	-
2500 H	500	500	500	500	-	-	-	-	269	269	269	269
3000 UH/H	827	323	323	827	-	-	-	-	303	303	303	303
3000 UV/V	323	504	323	504	328,5	0	0	328,5	-	-	-	-
4000 UH/H	827	323	323	827	-	-	-	-	303	303	303	303
4000 UV/V	323	504	323	504	328,5	0	0	328,5	-	-	-	-
5000 H	650	650	650	650	-	-	-	-	340	340	340	340
7000 H	750	750	750	750	-	-	-	-	400	400	400	400
<b>Verso CF</b>												
1300 UH/H	253	625	253	625	-	-	-	-	242	242	242	242
1300 UV/V	253	398	253	398	253	0	0	253	-	-	-	-
1300 F	275	275	275	275	-	-	-	-	263	263	263	263
1500 F	275	275	275	275	-	-	-	-	263	263	263	263
1700 UH/H	253	625	253	625	-	-	-	-	242	242	242	242
1700 UV/V	253	398	253	398	253	0	0	253	-	-	-	-
2300 UH/H	250	649	250	649	-	-	-	-	250	250	250	250
2300 UV/V	250	404	250	404	281	0	0	281	-	-	-	-
3500 UH/H	827	323	827	323	-	-	-	-	303	303	303	303
3500 UV/V	323	504	323	504	329	0	0	329	-	-	-	-
<b>Verso S</b>												
2100 F	500	-	500	-	-	-	-	-	154	-	154	-
3000 F	507,5	-	657,5	-	-	-	-	-	250	-	250	-
4000 F	507,5	-	657,5	-	-	-	-	-	250	-	250	-

**Filters**

Type	Filter type	Filtration class	Overall dimensions		Supply	Exhaust
			Width	Height	Length	Length
<b>VERSO R</b>						
1300 UH/UV/H/V	Compact	F5/F7*	800	400	46	46
1300 F	Compact	F5/F7*	410	420	46	46
1500 UH/UV/H/V	Compact	F5/F7*	800	400	46	46
1700 UH/UV/H/V 2000 UH/UV/H/V	Compact	F5/F7*	800	450	46	46
2000 F	Compact	F5/F7*	560	420	96	96
3000 UH/UV/H/V 4000 UH/UV/H/V	Compact	F5x2/F7*×2	525	510	46	46
2500 H	Bag	F5/F7	792	392-10	500	500
5000 H	Bag	F5x2/F7x2	592	592-8	500	500
7000 H	Bag	F5x2/F7*×2	592	592	635	635
<b>VERSO CF</b>						
1300 UH/UV/H/V	Compact	F5/F7*	800	400	46	46
1300 F	Compact	F5/F7*	550	420	46	46
1500 F	Compact	F5/F7*	550	420	46	46
1700 UH/UV/H/V	Compact	F5/F7*	800	400	46	46
2300 UH/UV/H/V	Compact	F5/F7*	800	400	46	46
3500 U	Compact	F5/F7*	525	510	46	46
<b>VERSO S</b>						
2100 F	Compact	F5/F7*	858	287	46	46
3000 F / 4000 F	Compact	F5x2/F7*×2	450	480	96	96

\* Can be changed to F7 by request.

## UAB KOMFOVENT

**VILNIUS** Ozo g. 10, LT-08200  
Tel. +370 (5) 2779 701  
Mob. tel. 8-685 44658  
el. p. info@komfovent.com

**KAUNAS** Taikos pr. 149, LT-52119  
Tel.: (8-37) 473 153, 373 587  
Mob. tel. 8 685 63962  
el. p. kaunas@komfovent.com

**KLAIPĖDA** Dubysos g. 25, LT-91181  
Mob. tel.: 8 685 93706, 8 685 93707  
el. p. klaipeda@komfovent.com

**ŠIAULIAI** Metalistų g. 6H, LT-78107  
Tel. (8-41) 500090,  
mob. tel. +370 685 93700  
el. p. siauliai@komfovent.com

**PANEVĖŽYS** Beržų g. 44, LT-36144  
Mob. tel. 8 640 55988  
el. p. panevezys@komfovent.com

**EXPORT & SALES DEPARTMENT**  
Ph.: +370 (5) 205 1579, 231 6574  
Fax +370 (5) 230 0588  
export@komfovent.com

**GARANTINIO APTARNAVIMO SK. /  
SERVICE AND SUPPORT**  
Tel. / Ph. +370 (5) 200 8000,  
mob. tel. / mob. ph.: +370 652 03180  
service@komfovent.com

www.komfovent.com

## PARTNERS

AT	J. PICHLER Gesellschaft m. b. H.	www.pichlerluft.at
AU	Pacific HVAC	www.pacificvac.com
BE	Ventilair group	www.ventilairgroup.com
	ACB Airconditioning	www.acbairco.be
CZ	REKUVENT s.r.o.	www.rekuvent.cz
CH	WESCO AG	www.wesco.ch
	SUDCLIMATAIR SA	www.sudclimatair.ch
DK	KAPAG Kälte-Wärme AG	www.kapag.ch
	UNIQ COMFORT ApS	www.uniqcomfort.dk
EE	AIR2TRUST	www.air2trust.com
	BVT Partners	www.bvtpartners.ee
FR	AERIA	www.aeria-france.fr
GB	ELTA FANS	www.eltafans.com
HR	Microclima	www.microclima.hr
	AIRVENT Légtechnikai Zrt.	www.airvent.hu
HU	Gevent Magyarorszáig Kft.	www.gevent.hu
	Merkapt	www.merkapt.hu
IR	Fantech Ventilation Ltd	www.fantech.ie
IS	Blikk & Tækniþjónustan ehf	www.bogt.is
	Hitataekni ehf	www.hitataekni.is
NL	Ventilair group	www.ventilairgroup.com
	DECIPOL-Vortvent	www.vortvent.nl
NO	Ventistål AS	www.ventistal.no
	Thermo Control AS	www.thermocontrol.no
PL	Ventia Sp. z o.o.	www.ventia.pl
SE	Nordisk Ventilator AB	www.nordiskventilator.se
SI	Agregat d.o.o	www.agregat.si
SK	TZB produkt, s.r.o.	www.tzbprodukt.sk

### ООО «АМАЛБА-Р»

Россия, Москва  
ул. Выборгская д. 16,  
стр. 1, 2 этаж, 206 офис  
тел./факс +7 495 640 6065,  
info@komfovent.ru  
www.komfovent.ru

### ООО «АМАЛБА-ОКА»

390017 г. Рязань  
Рязское шоссе, 20 литера Е, пом Н6  
тел. +7 4912 950575, +7 4912 950672,  
+7 4912 950648  
info@komfovent-oka.ru  
www.komfovent.ru

### ИООО «Комфoвент»

Республика Беларусь, 220125 г. Минск,  
ул. Уручская 21 – 423  
Тел. +375 17 266 5297, 266 6327  
minsk@komfovent.by  
www.komfovent.by

### Komfovent AB

Ögärdesvägen 12B  
433 30 Partille, Sverige  
Phone +46 31 487752  
info\_se@komfovent.com  
www.komfovent.se

### Komfovent Oy

Muuntotie 1 C1  
FI-01 510 VANTAA  
+358 (0) 40 8263 500  
info\_fi@komfovent.com  
www.komfovent.com

### Komfovent GmbH

Konrad-Zuse-Str. 2a, 42551 Velbert,  
Deutschland  
Mob. ph. +49 (0) 2051/6051180  
info@komfovent.de  
www.komfovent.de

### Komfovent SIA

Katlakalna iela 9,  
LV-1073 Riga  
Tel. +371 67 20 1572  
Fakss +371 67 20 1570  
info@komfovent.lv  
www.komfovent.lv