

Air conditioner Installation Instruction

CAUTION R32 REFRIGERANT This Air Conditioner contains and operates with refrigerant R32. THIS PRODUCT MUST ONLY BE INSTALLED OR SERVICED BY QUALIFIED PERSONNEL.

MODEL NO. :- CS/CU-BZ25, BZ35, BZ50, BZ60XKE Series.

Required tools for Installation Works

- 1 Phillips screw driver
2 Level gauge
3 Electric drill, hole core drill (ø70 mm)
4 Hexagonal wrench (4 mm)
5 Spanner
6 Pipe cutter
7 Reamer
8 Knife
9 Gas leak detector
10 Measuring tape
11 Thermometer
12 Megameter
13 Multimeter
14 Torque wrench
15 Nm (1.8 kgfcm)
16 Nm (4.3 kgfcm)
17 Nm (5.6 kgfcm)
18 Nm (6.6 kgfcm)
19 Nm (10.2 kgfcm)
15 Vacuum pump
16 Gauge manifold

SAFETY PRECAUTIONS

- Read the following "SAFETY PRECAUTIONS" carefully before installation.
Electrical work must be installed by a licensed electrician.
The caution items stated here must be followed because these important contents are related to safety.

WARNING This indication shows the possibility of causing death or serious injury. CAUTION This indication shows the possibility of causing injury or damage to properties only.

Symbol with white background denotes item that is PROHIBITED. Symbol with dark background denotes item that must be carried out.

- Carry out test running to confirm that no abnormally occurs after the installation. Then, explain to user the operation, care and maintenance as stated in instructions.

WARNING Do not use means to accelerate the defrosting process or to clean, other than those recommended by the manufacturer. Do not install outdoor unit near handrail of veranda. Do not use unspecified cord, modified cord, joint cord or extension cord for power supply cord.

WARNING Engage authorized dealer or specialist for installation. For refrigeration system work, install according to this installation instructions strictly. Do not install in a place where leakage of flammable gas may occur. Prevent liquid or vapor from entering stomps or sewers since vapor is heavier than air.

CAUTION Do not install the unit in a place where leakage of flammable gas may occur. Do not release refrigerant during piping work for installation, re-installation and during repairing refrigeration parts. Do not touch the sharp aluminum fins, sharp parts may cause injury.

PRECAUTION FOR USING R32 REFRIGERANT

WARNING When connecting flare at indoor side, make sure that the flare connection is used only once. The flare must be remade. The mixing of different refrigerants within a system is prohibited.

WARNING Precautions shall be taken to avoid excessive vibration or pulsation to refrigerating piping. Expansion and contraction of long runs piping in refrigerating systems shall be designed and installed securely.

CAUTION 1. General Must ensure the installation of pipe-work shall be kept to a minimum. Avoid use dented pipe and do not allow acute bending. 2.1. Qualification Any qualified person who is involved with working on or breaking into a refrigerant circuit should hold a current valid certificate.

2-1. Qualification Any qualified person who is involved with working on or breaking into a refrigerant circuit should hold a current valid certificate. 2-2. Checks to the area Prior to beginning work on systems containing flammable refrigerants, safety checks are necessary to ensure that the risk of ignition is minimised.

2-3. Work procedure Work shall be undertaken under a controlled procedure so as to minimize the risk of a flammable gas or vapour being present while the work is being performed. 2-4. General work area All maintenance staff and others working in the local area shall be instructed and supervised on the nature of work being carried out.

2-5. Checking for presence of refrigerant The area shall be checked with an appropriate refrigerant detector prior to and during work, to ensure the technician is aware of potentially flammable atmospheres. 2-6. Presence of fire extinguisher If any hot work is to be conducted on the refrigerating equipment or any associated parts, appropriate fire extinguishing equipment shall be available at hand.

2-7. No ignition sources No person carrying out work in relation to a refrigerating system which involves exposing any pipe work that contains or has contained flammable refrigerant shall use any sources of ignition in such a manner that it may lead to the risk of fire or explosion. 2-8. Ventilated area Ensure that the area in which the system is to be installed is adequately ventilated before breaking into the system or conducting any hot work.

10. Labelling Equipment shall be labelled stating that it has been de-commissioned and emptied of refrigerant. 11. Recovery When removing refrigerant from a system, either for servicing or decommissioning, it is recommended good practice that all refrigerants are removed safely.

Explanation of symbols displayed on the indoor unit or outdoor unit.

WARNING This symbol shows that this equipment uses a flammable refrigerant. CAUTION This symbol shows that the Installation Manual should be read carefully. CAUTION This symbol shows that a service personnel should be handling this equipment with reference to the Installation Manual.

Indoor/Outdoor Unit Installation Diagram

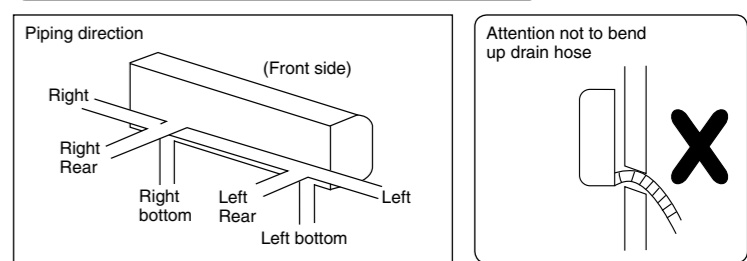

Attached accessories

Table with columns: No., Accessories part, Qty., No., Accessories part, Qty., No., Accessories part, Qty. Lists items like Installation plate, remote control holder, and drain elbow.

Table with columns: Applicable piping kit, Gas, Liquid. Lists piping kit models like CZ-3F5, 7BP and their dimensions.

SELECT THE BEST LOCATION

- INDOOR UNIT Do not install the unit in excessive oil fume area such as kitchen, workshop and etc. Do not install the unit near the door way.

OUTDOOR UNIT

- If an awning is built over the unit to prevent direct sunlight or rain, be careful that heat radiation from the condenser is not obstructed. Do not place any obstacles which may cause a short circuit of the discharged air.

Table A

Table A: Capacity, Piping size, Std. Length, Max. Elevation, Min. Piping Length, Max. Piping Length, Additional Refrigerant, Piping Length for add. gas, Max. Refrigerant Charge, Indoor A_min.

(*) Systems with total refrigerant charge, m_c, lower than 1.84 kg are not subjected to any room area requirements.

Example: For BZ25*** If the unit is installed at 10 m distance, the quantity of additional refrigerant should be 25 g....

A_min = (m_c / (2.5 x (LFL)^0.8 x h_o))^2 ** not less than safety factor margin

A_min = Required minimum room area, in m^2
m_c = Refrigerant charge in appliance, in kg
LFL = Lower flammability limit (0.307 kg/m^3)
h_o = Installation height of the appliance (1.8 m for wall mounted)
SF = Safety factor with a value of 0.75

** The required minimum room area, A_min, shall also be governed by the safety factor margin formula below :

A_min = m_c / (SF x LFL x h_o)

The higher value shall be taken when determining the room area.

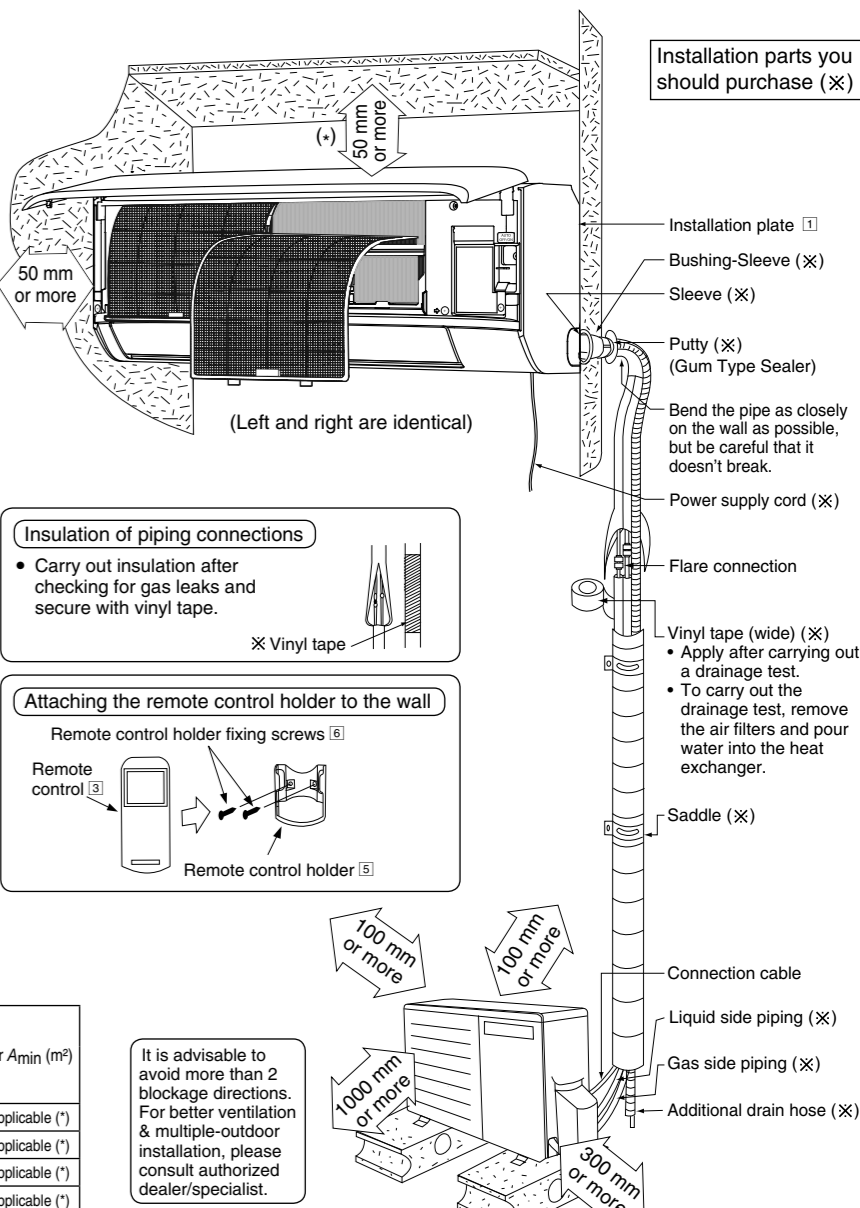

It is advisable to give more than 2 block directions. For better ventilation & multiple-outdoor installation, please contact authorized dealer/specialist. This illustration is for explanation purposes only.

INDOOR UNIT

1 SELECT THE BEST LOCATION

(Refer to "Select the best location" section)

2 HOW TO FIX INSTALLATION PLATE

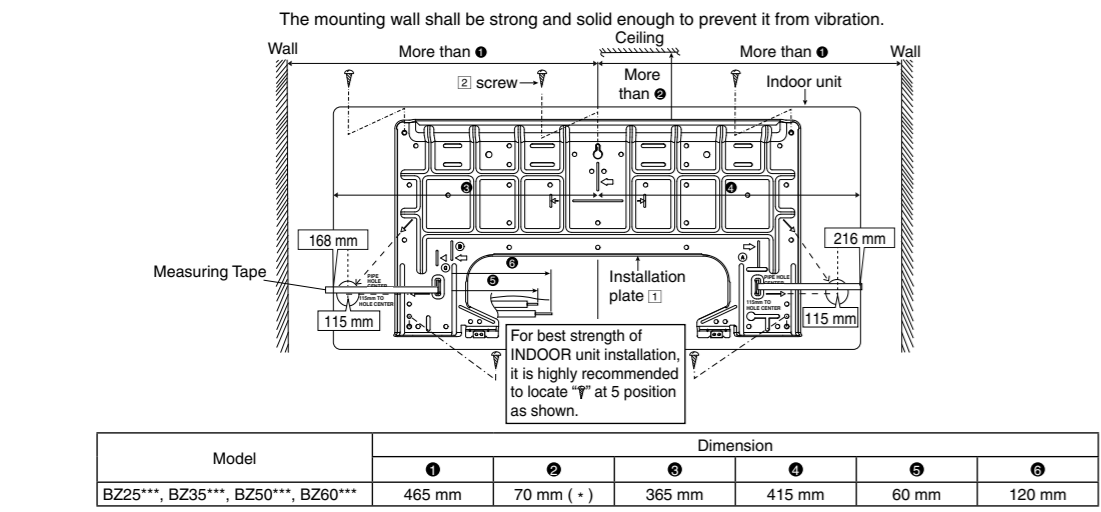

The center of installation plate should be at more than ① at right and left of the wall. The distance from installation plate edge to ceiling should more than ②. From installation plate center to unit's left side is ③. From installation plate center to unit's right side is ④. For left side piping, piping connection for liquid should be about ⑤ from this line. For right side piping, piping connection for gas should be about ⑥ from this line. Mount the installation plate on the wall with 5 screws or more (at least 5 screws). (If mounting the unit on the concrete wall, consider using anchor bolts.) Always mount the installation plate horizontally by aligning the marking-off line with the thread and using a level gauge. Drill the piping plate hole with $\phi 70$ mm hole-core drill. Line according to the left and right side of the installation plate. The meeting point of the extended line is the center of the hole. Another method is by putting measuring tape at position as shown in the diagram above. The hole center is obtained by measuring the distance, namely 115 mm for left and right hole respectively. Drill the piping hole at either the right or the left and the hole should be slightly slanting to the outdoor side.

3 TO DRILL A HOLE IN THE WALL AND INSTALL A SLEEVE OF PIPING

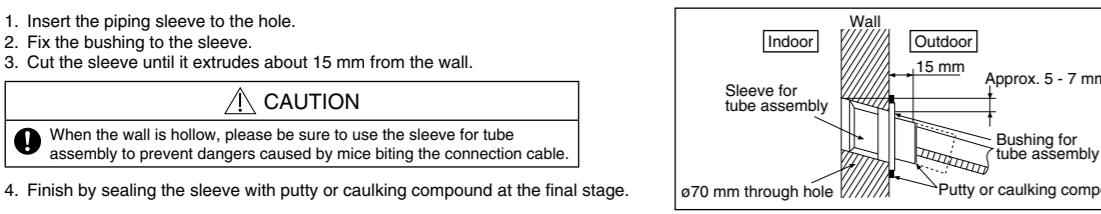

5 CONNECT THE CABLE TO THE INDOOR UNIT

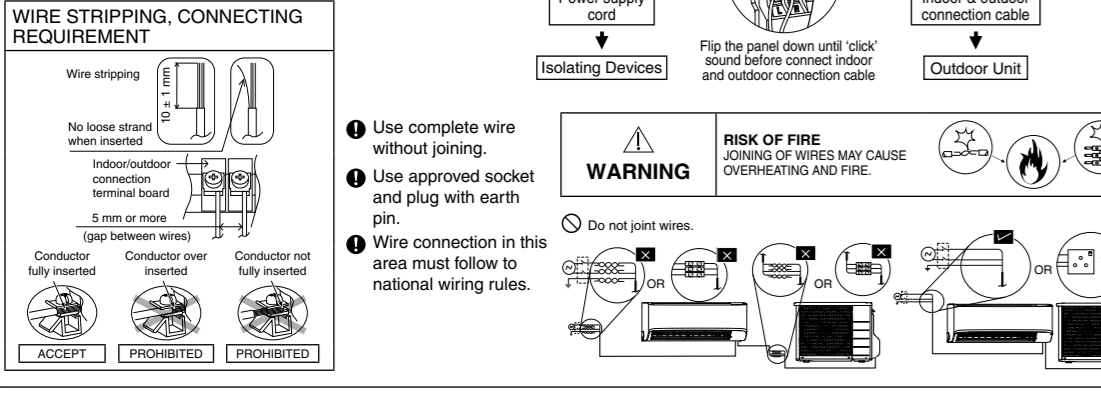
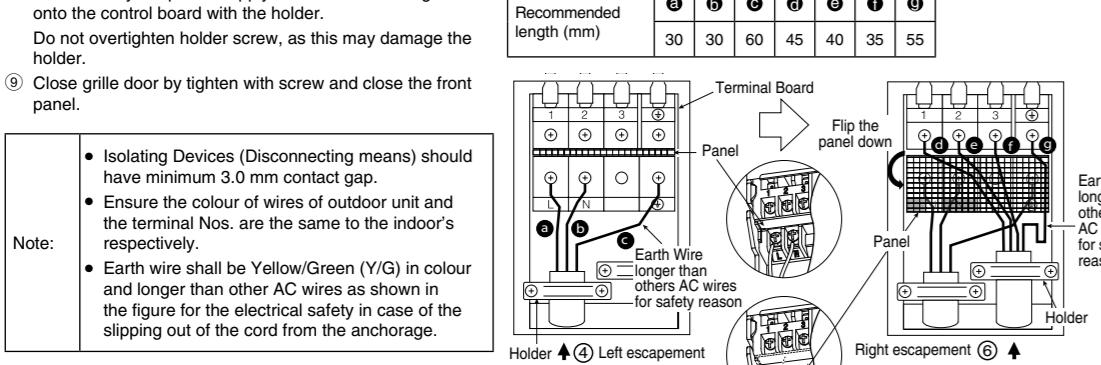
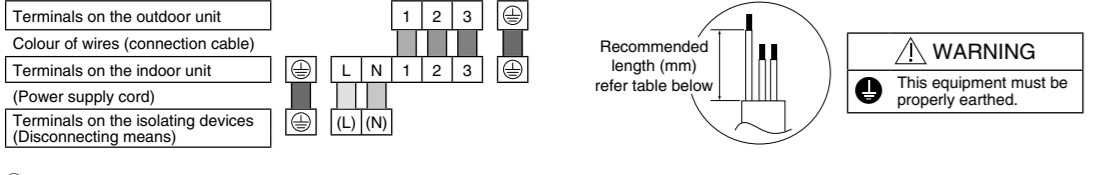
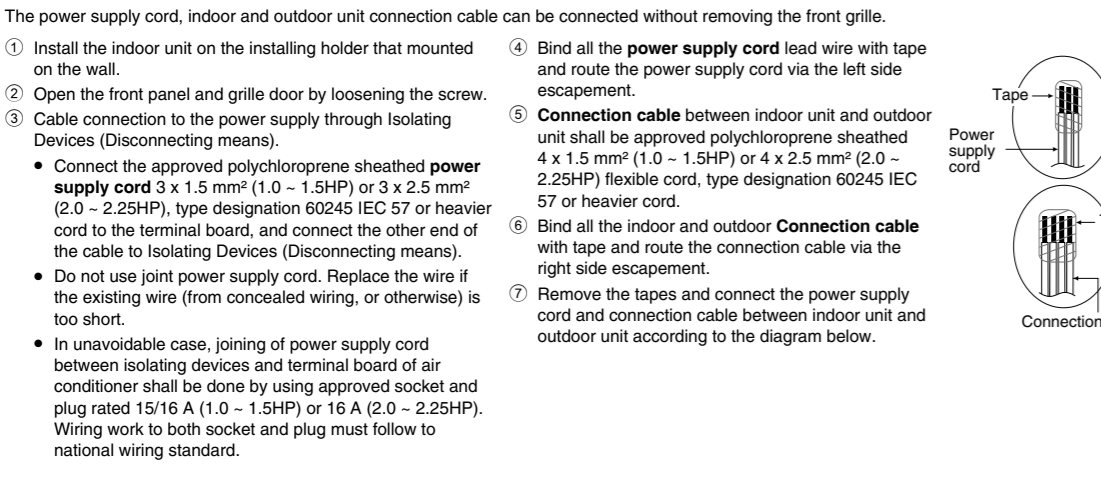

4 INDOOR UNIT INSTALLATION

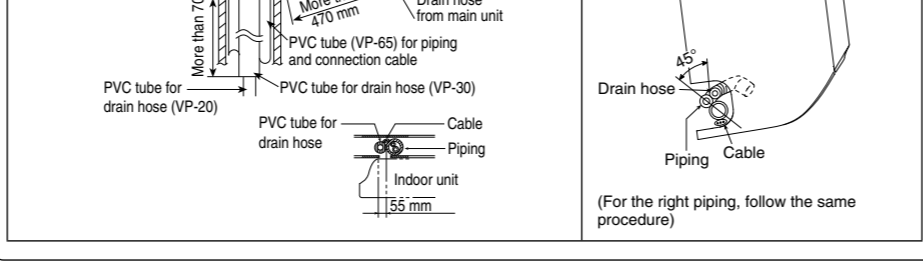
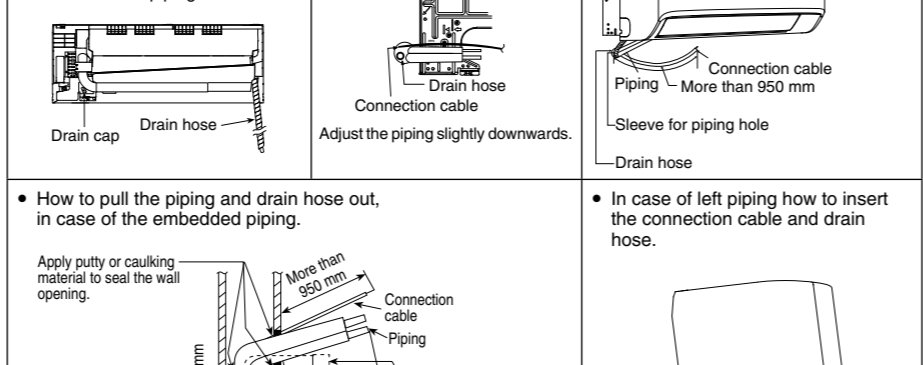
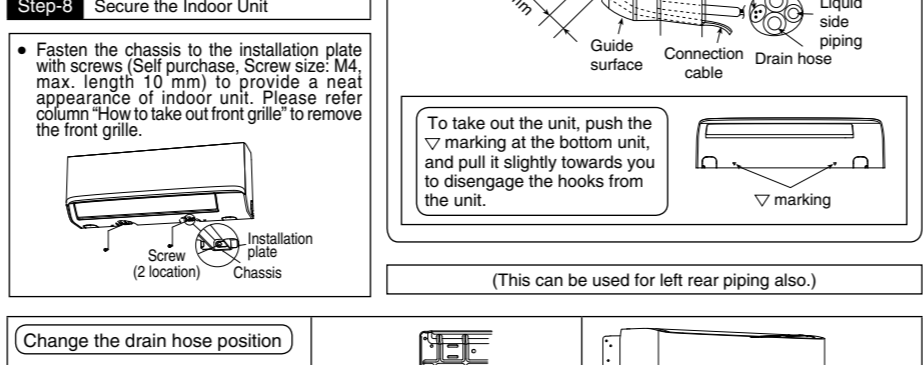
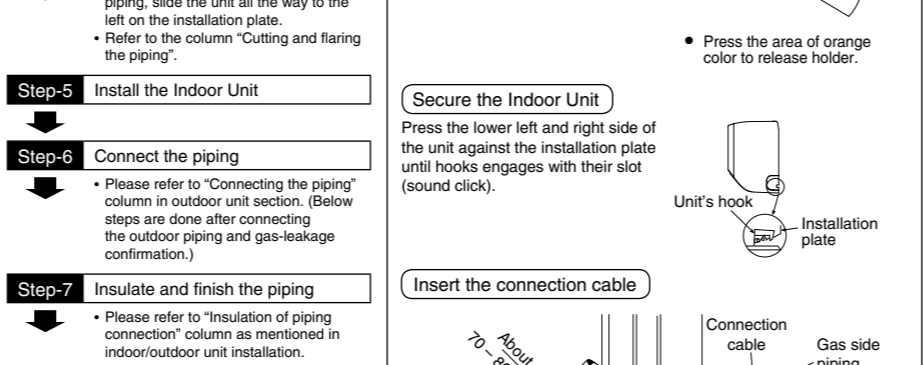
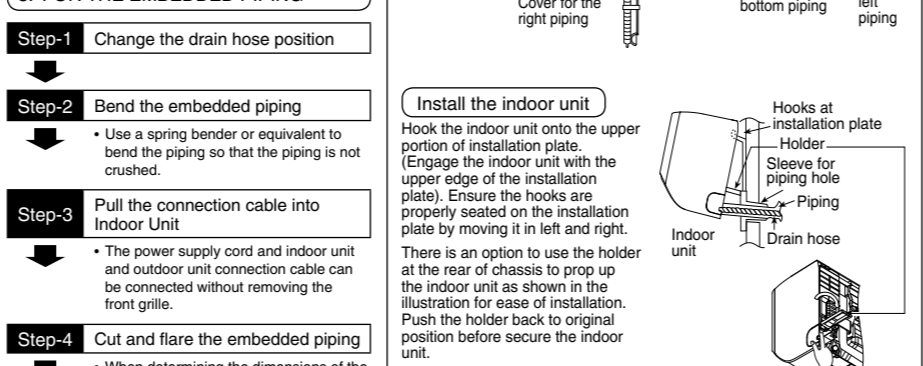
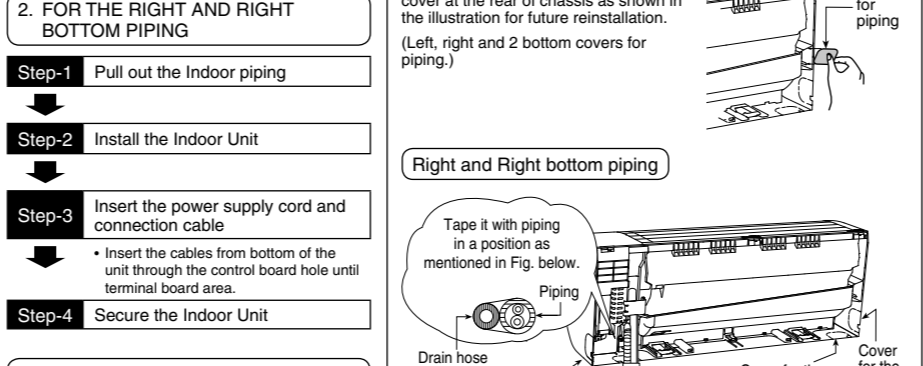
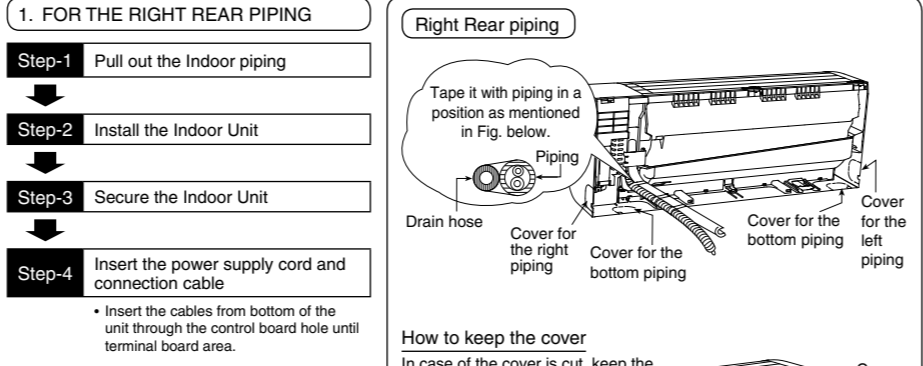
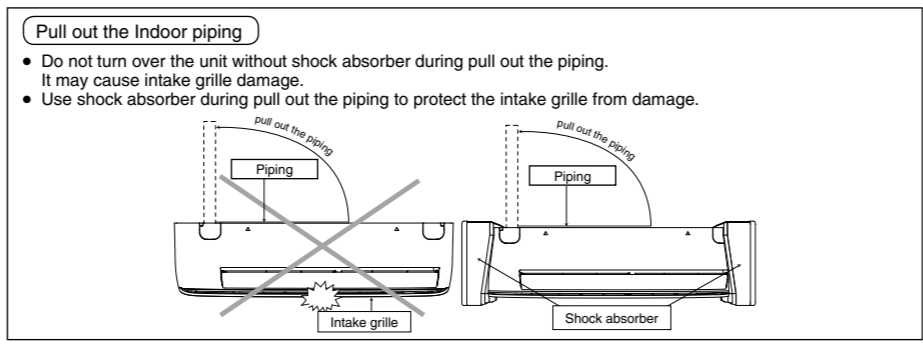

OUTDOOR UNIT

1 SELECT THE BEST LOCATION

(Refer to "Select the best location" section)

2 INSTALL THE OUTDOOR UNIT

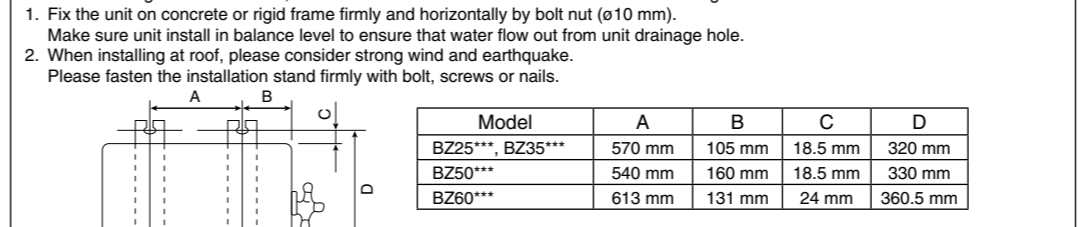

3 CONNECT THE PIPING

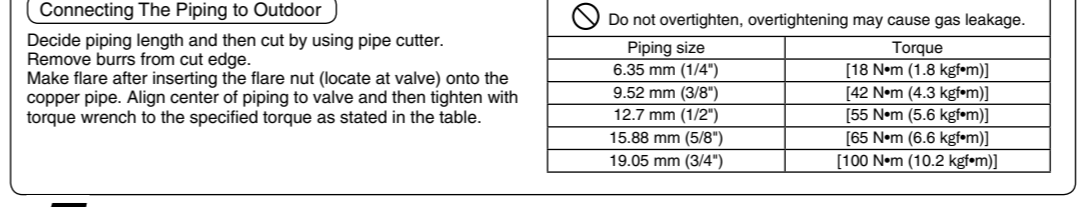
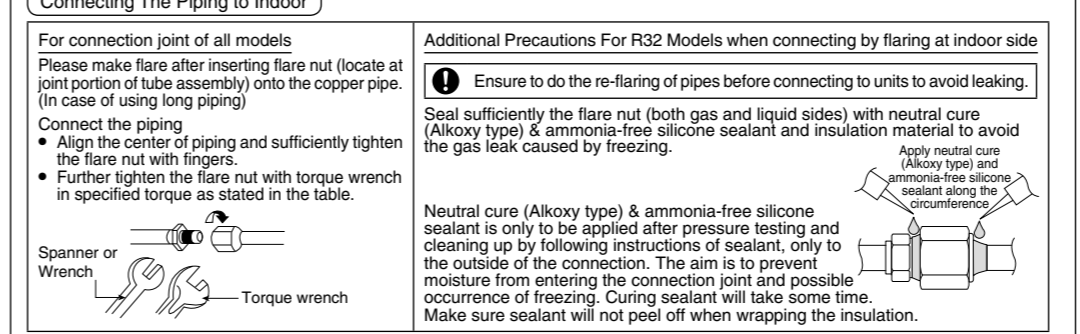

5 CONNECT THE CABLE TO THE OUTDOOR UNIT

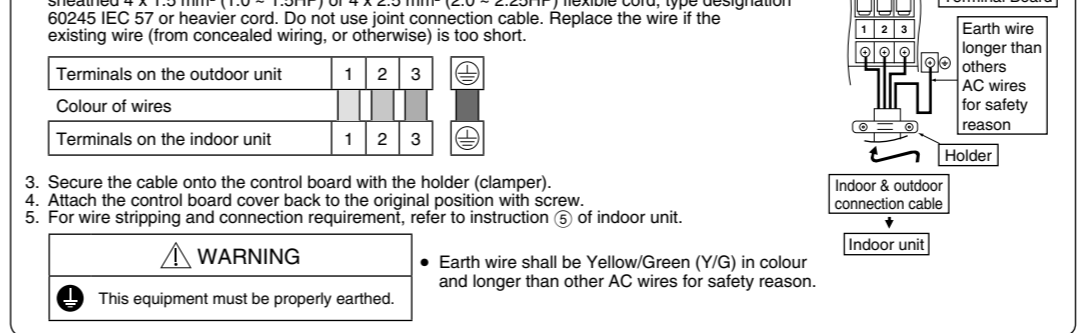

6 PIPING INSULATION

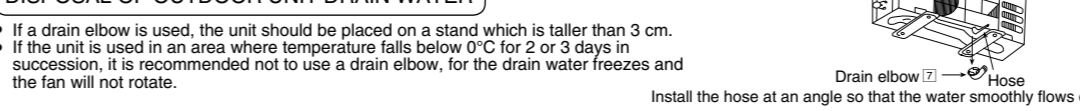
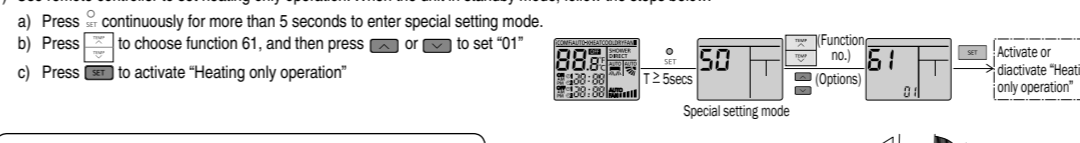
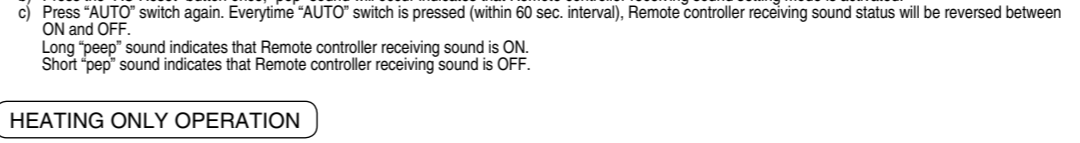
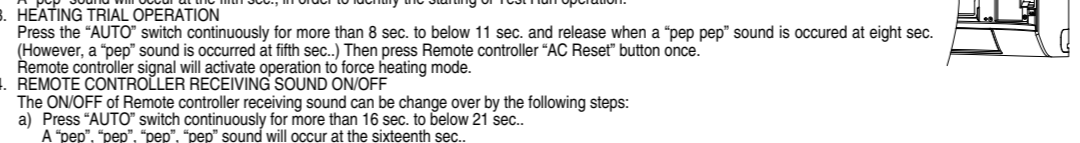
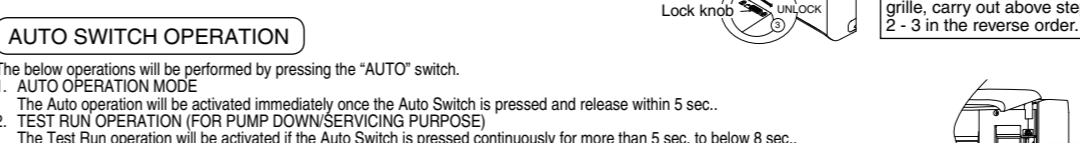
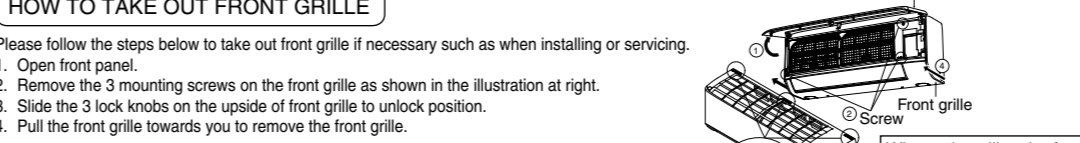
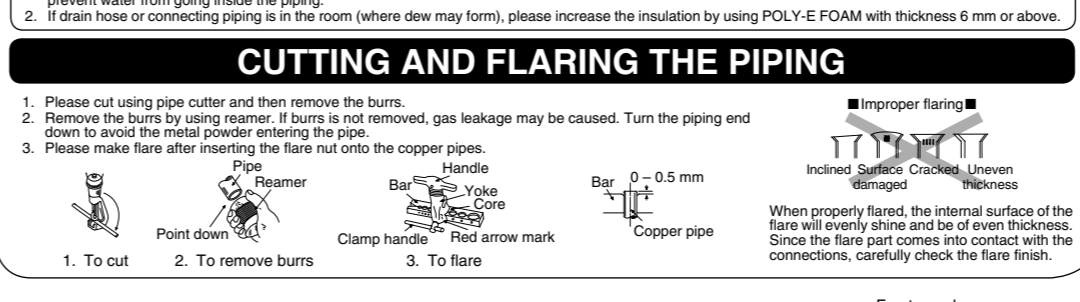

4 AIR TIGHTNESS TEST ON THE REFRIGERATING SYSTEM

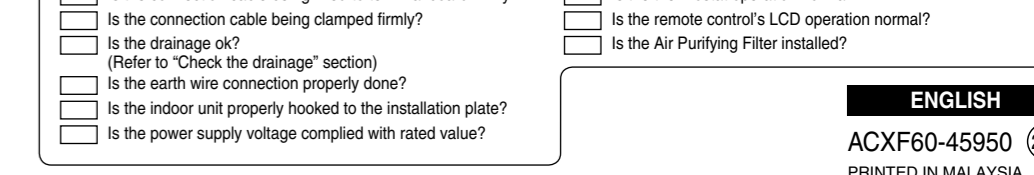
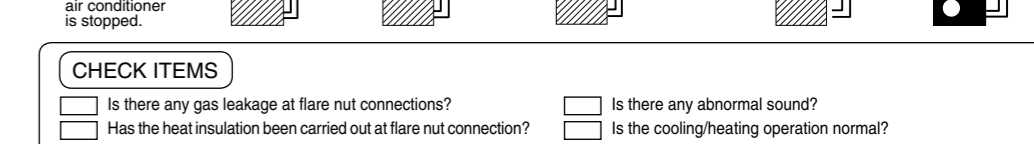
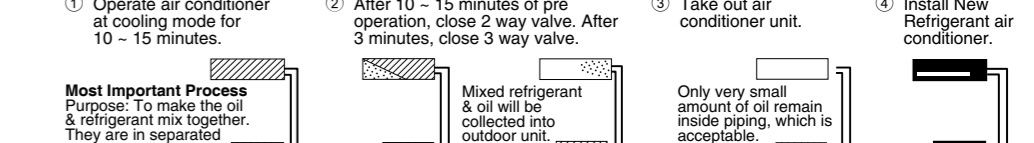
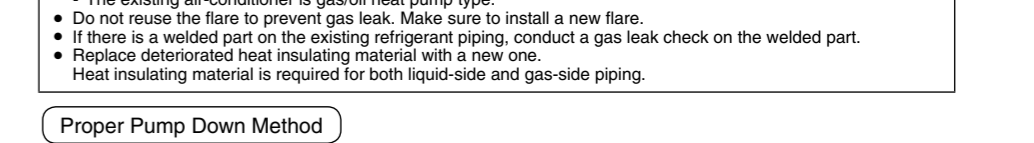
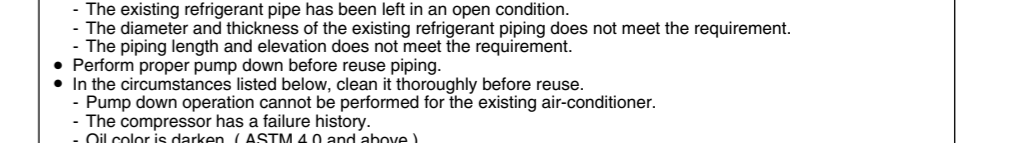
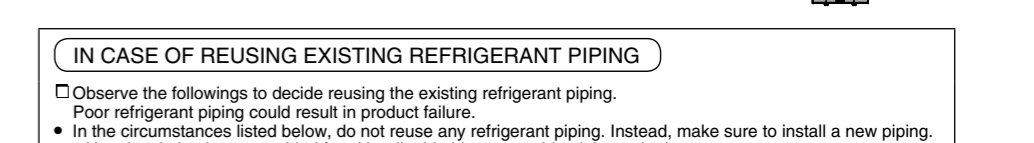
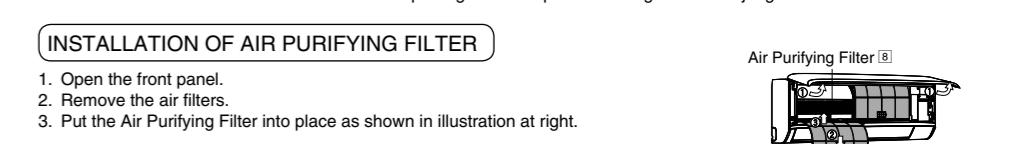
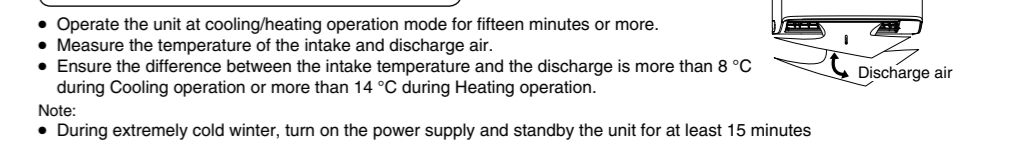
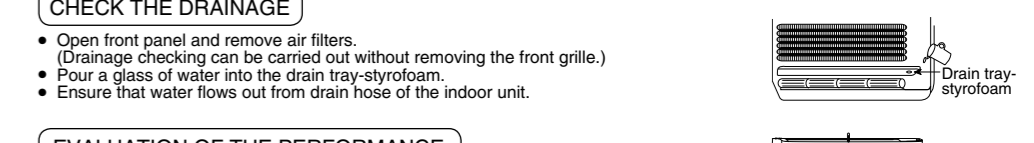
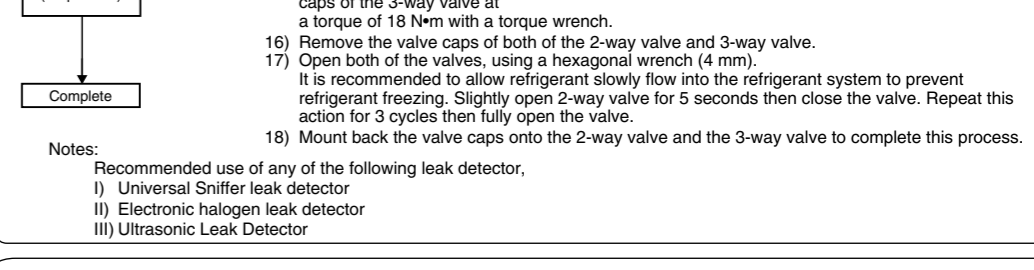
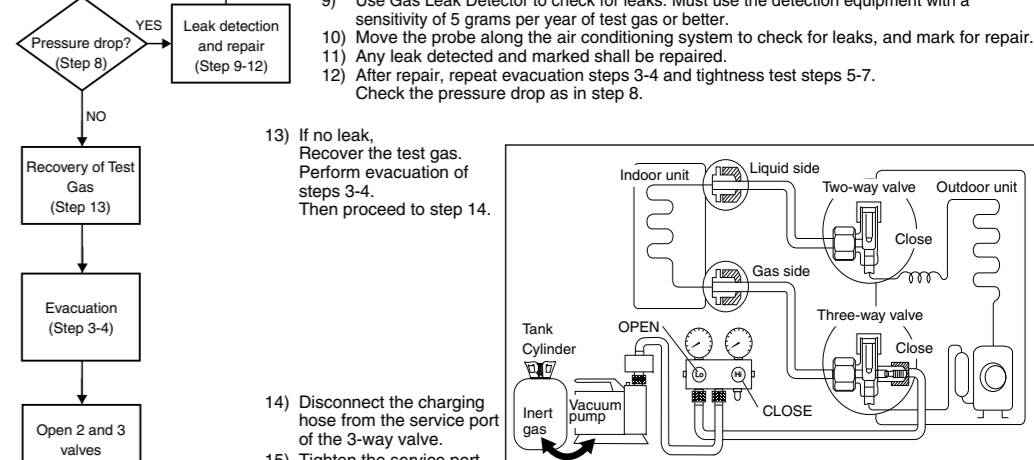
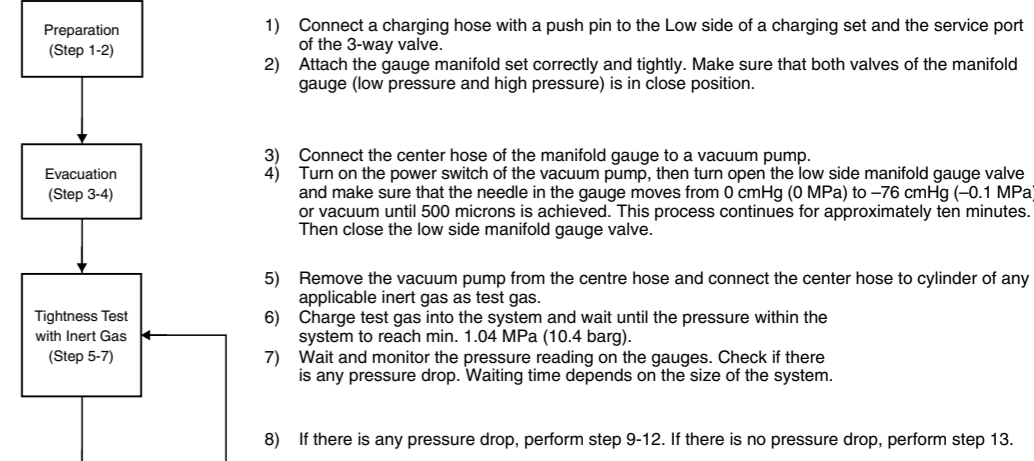
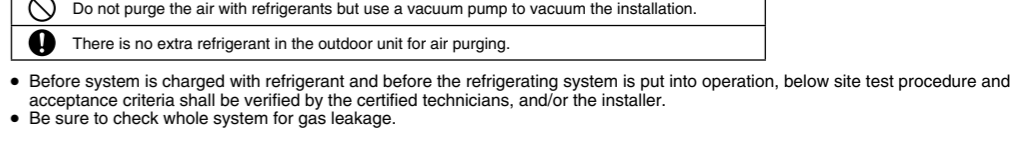

UNIDAD INTERIOR

1 SELECCIONE LA MEJOR UBICACIÓN

(Vea la sección "Selección de la mejor ubicación")

2 COMO MONTAR LA PLACA DE INSTALACIÓN

La pared de soporte deberá ser suficientemente robusta y sólida para evitar vibraciones.

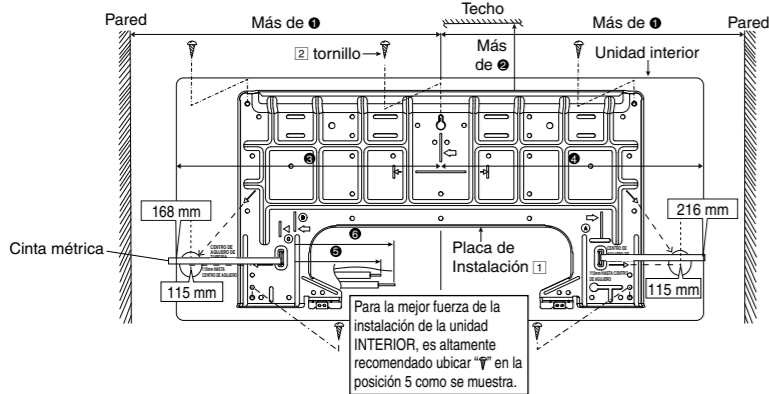

Modelo	1	2	3	4	5	6
BZ25***, BZ35***, BZ50***, BZ60***	465 mm	70 mm (+)	365 mm	415 mm	60 mm	120 mm

El centro de la placa de montaje debería estar a más de ① a la derecha e izquierda de la pared. La distancia entre el borde de la placa de montaje y el techo debe ser más de ②. Desde el centro de la placa de montaje hasta el lateral izquierdo de la unidad, debe haber ③. Desde el centro de la placa de montaje hasta el lateral derecho de la unidad, debe haber ④. Si se necesita utilizar el soporte de la parte trasera del chasis (consulte la columna "Instalación de unidad interior") para sostener la unidad, esta distancia debe ser de 85 mm o más.

⑤ Para la tubería del lado izquierdo, la conexión de la conducción para líquido debe estar a unos ⑤ de esta línea. Para la tubería del lado derecho, la conexión de la conducción para gas debe estar a unos ⑥ de esta línea.

- Monte la placa de instalación en la pared con 5 tornillos o más (por lo menos 5 tornillos). (Si fija la unidad en una pared de hormigón considere utilizar pernos de anclaje).
- Coloque siempre la lámina de instalación horizontalmente alineando la línea de demarcación utilizando un nivel.
- Perfore el hueco de la placa de tubería con un taladro de broca de 670 mm.
- Nivélelo de acuerdo con el lado izquierdo y derecho de la placa de instalación. El punto de encuentro de la línea extendida es el centro del agujero.

Otro método consiste en aplicar cinta métrica en la posición indicada en el diagrama de arriba. El centro del agujero se obtiene midiendo la distancia, o sea, 115 mm para el agujero de la izquierda y de la derecha respectivamente.

- Perfore el hueco de la tubería ya sea a la derecha o a la izquierda y el hueco deberá estar apenas inclinado hacia el lado exterior.

3 PARA PERFORAR UN HUECO EN LA PARED E INSTALAR UNA MANGA DE TUBERÍA

- Inserte la manga de tubería al hueco.
- Fije la manga metálica a la manga.
- Corte la manga hasta sacarla cerca de 15 mm de la pared.

PRECAUCIÓN

- Si la pared es hueca, utilice la manga para montaje de tubería para evitar los peligros causados por las mordeduras de roedores al cable de conexión.

- Termine sellando la manga con masilla o compuesto enmasillado en la fase final.

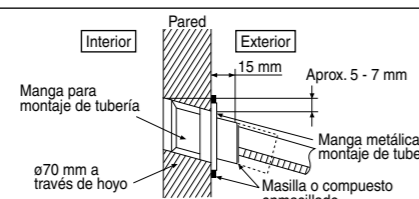

5 CONECTE EL CABLE A LA UNIDAD INTERIOR

El cable de alimentación eléctrica, la unidad interior y el cable de conexión de la unidad exterior pueden ser conectados sin desmontar la rejilla frontal.

- Instale la unidad interior en el soporte de instalación montado en la pared.
- Abra el panel frontal y la puerta de rejilla alojando el tornillo.
- Conexión del cable a la red con dispositivos de aislamiento (Medio de desconexión).
- Conecte el cable de alimentación homologado, con forro de polipropileno de 3 x 1.5 mm² (1.0 - 1.5HP) o 3 x 2.5 mm² (2.0 - 2.25HP), con designación tipo 60245 IEC 57 o de calibre superior, a la tarjeta de control y conecte el otro extremo del cable a los dispositivos de aislamiento (dispositivo de desconexión).
- No utilice el cable de alimentación eléctrica unido. Sustituya el cable si el cable existente (de cableado oculto, o no) es demasiado corto.
- En caso inevitable, la unión del cable de alimentación eléctrica entre los dispositivos de aislamiento y el cuadro de terminales del aire acondicionado se realizará utilizando una tuerca y un conector aprobados de 15/16 A (1.0 - 1.5HP) o 16 A (2.0 - 2.25HP). El trabajo de cableado para toma y conector ha de seguir las especificaciones de cableado nacional.
- Conecte todos los cables de suministro eléctrico de conexión con cinta y dirija el cable de alimentación eléctrica a través del escape lateral izquierdo.
- El cable de conexión entre la unidad interior y la unidad exterior debe ser un cordón flexible 4 x 1.5 mm² (1.0 - 1.5HP) o 4 x 2.5 mm² (2.0 - 2.25HP) torrado de polipropileno aprobado, del tipo de designación 60245 IEC 57 o cable de resistencia superior.
- Conecte todos los Cables de conexión interiores y exteriores con cinta y dirija el cable de conexión a través del escape lateral derecho.
- Retire las cintas y conecte el cable de alimentación eléctrica y el cable de conexión entre la unidad interior y la unidad exterior según el diagrama de abajo.

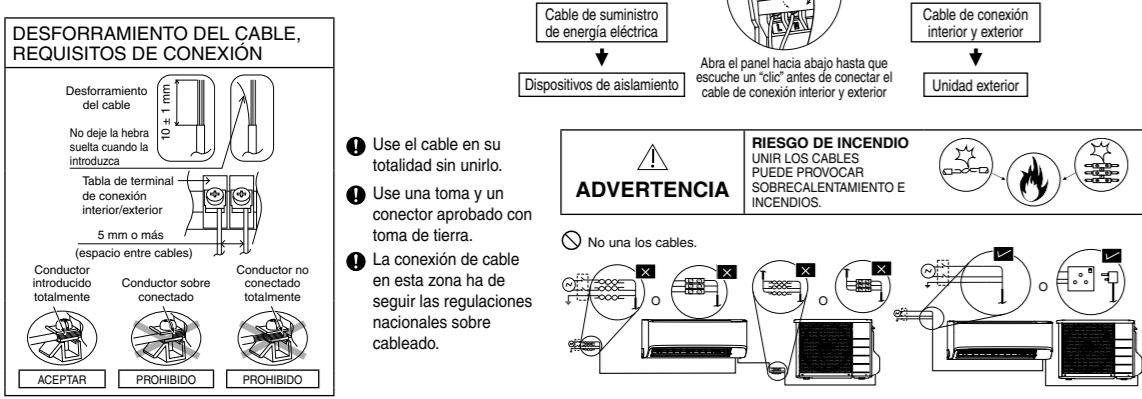
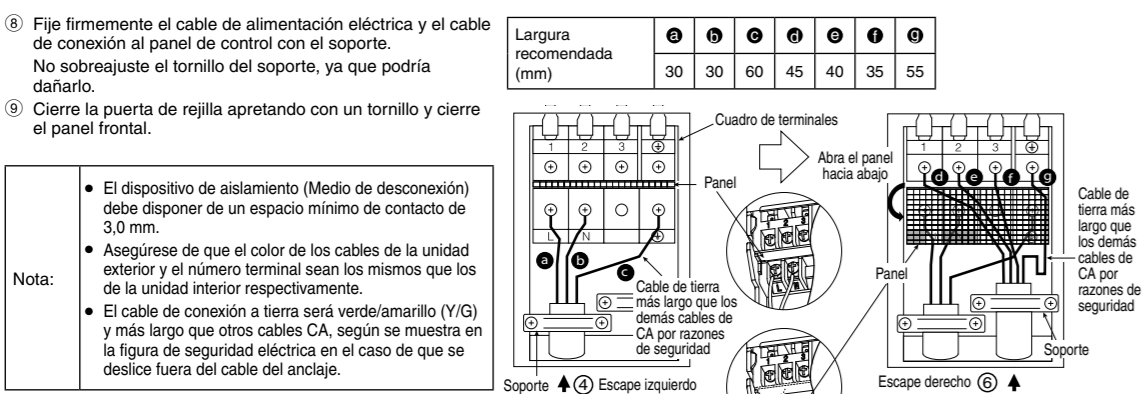
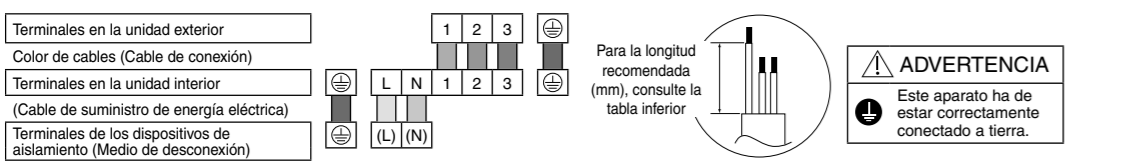

RIESGO DE INCENDIO UNIR LOS CABLES PUEDE PROVOCAR SOBRECARGAS E INCENDIOS

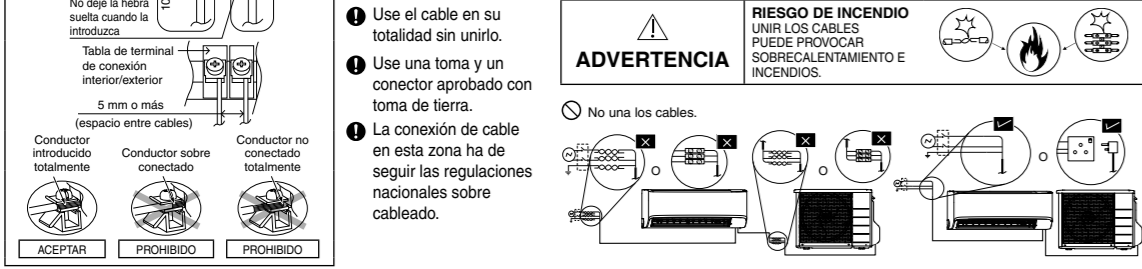

4 INSTALACIÓN DE UNIDAD INTERIOR

- Tire hacia afuera de la tubería Interior.
- No dé la vuelta a la unidad sin su amortiguador de golpes cuando retire la tubería. Podría causar daños a la rejilla de entrada.
- Utilice un amortiguador de golpes durante la retirada de la tubería para protegerla rejilla interior de posibles daños.

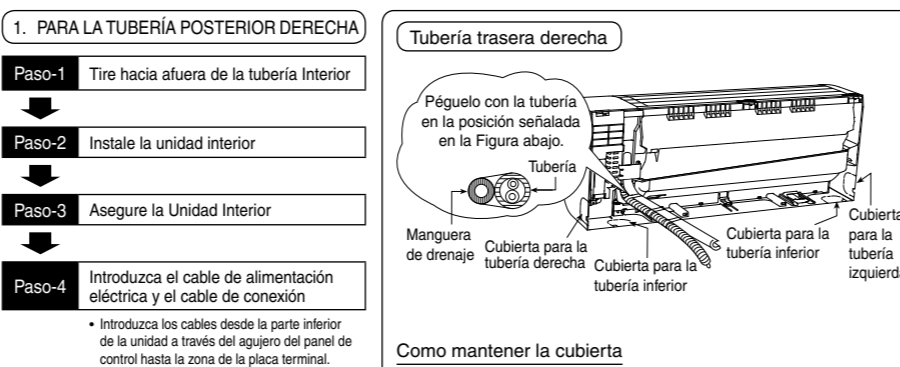
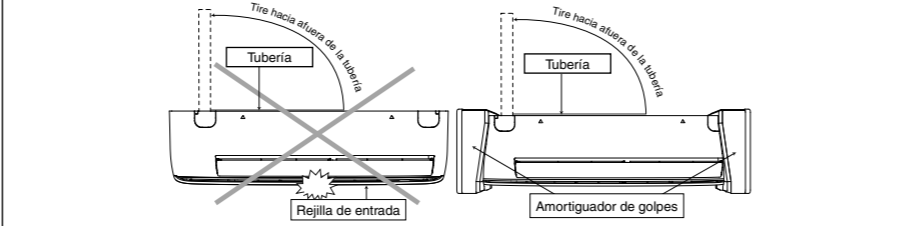

2. PARA LA TUBERÍA DERECHA E INFERIOR DERECHA

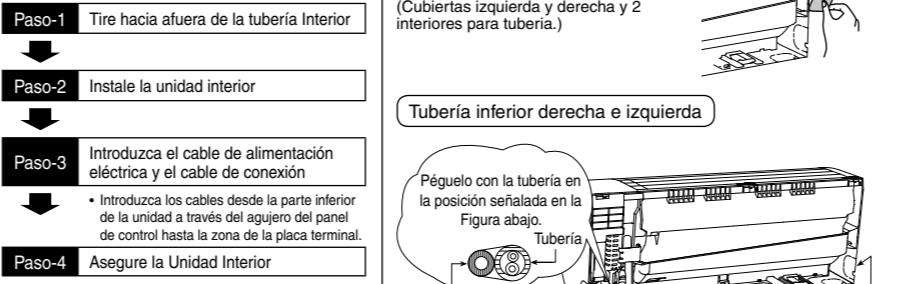

3. PARA LA TUBERÍA EMPOTRADA

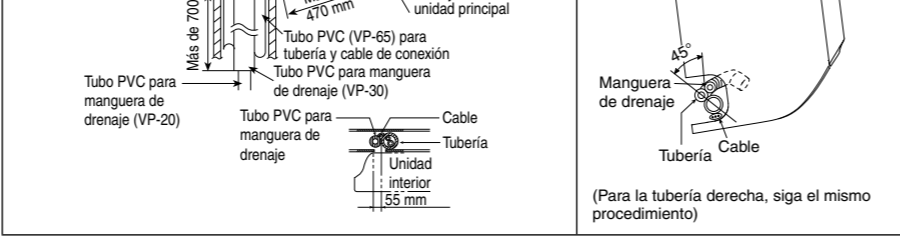
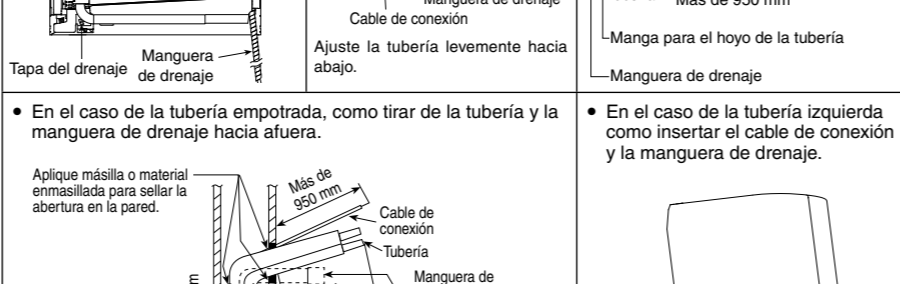
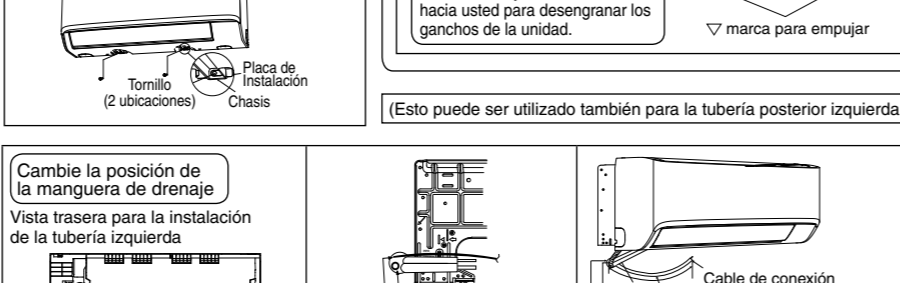
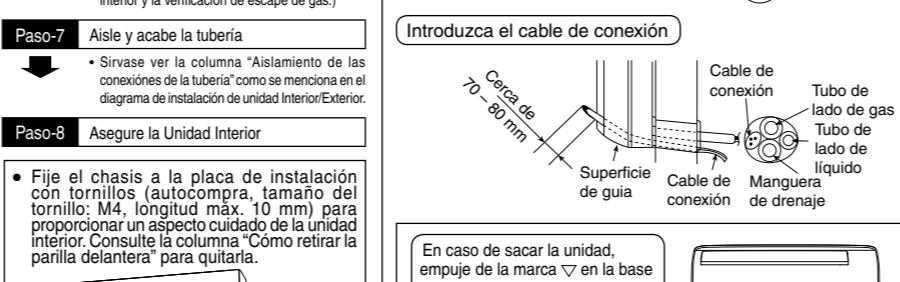
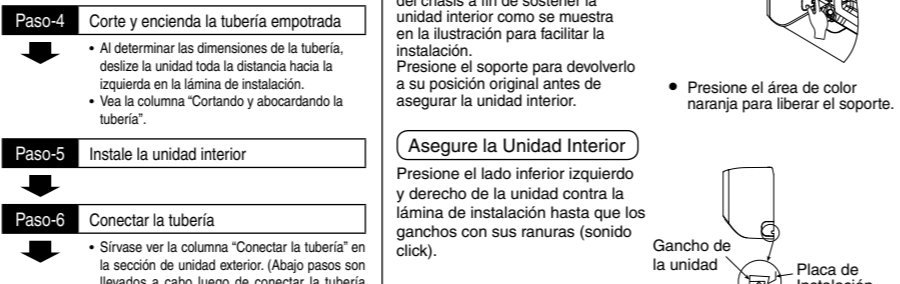
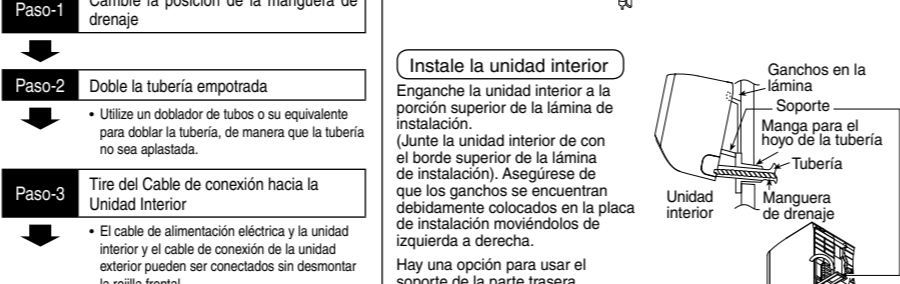

UNIDAD EXTERIOR

1 SELECCIONE LA MEJOR UBICACIÓN

(Vea la sección "Selección de la mejor ubicación")

2 INSTALE LA UNIDAD EXTERIOR

- Luego de escoger la mejor ubicación, inicie la instalación de acuerdo al Diagrama de Instalación de la Unidad Interior/Exterior.
- Fije la unidad al hormigón o a un marco sólido firme y horizontalmente por medio una tuerca sujeta con tornillos (ø10 mm).
- Asegúrese de que la unidad se instala a nivel equilibrado para garantizar que el caudal de agua salga por el agujero de drenaje de la unidad.
- Al instalar en el techo, tome en consideración el viento fuerte y terremoto.
- Sujete el pie de la instalación firmemente con pernos, tornillos o clavos.

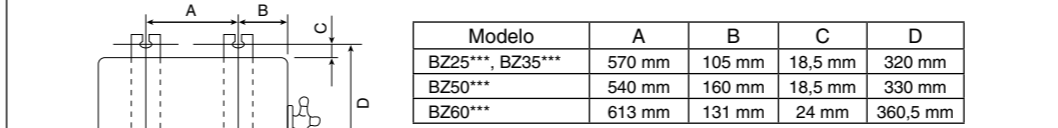

3 CONECTAR LAS TUBERÍAS

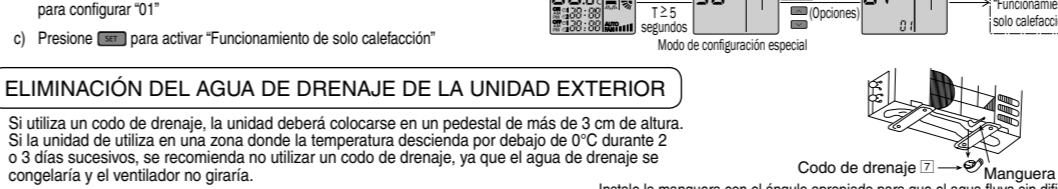
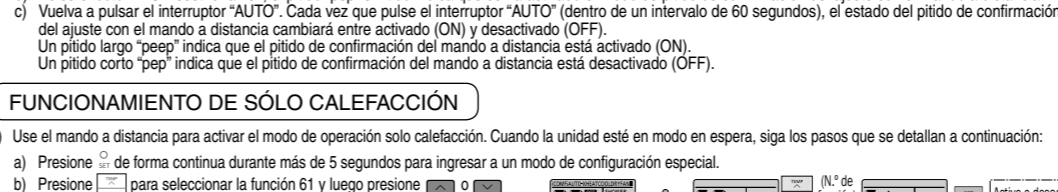
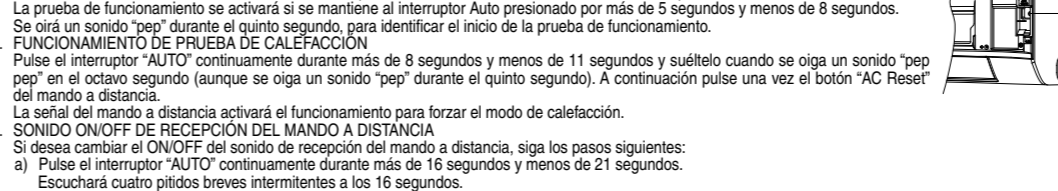
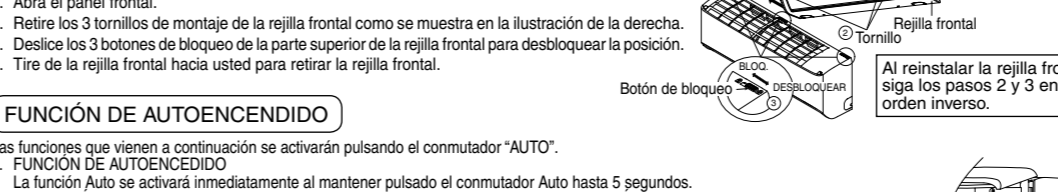
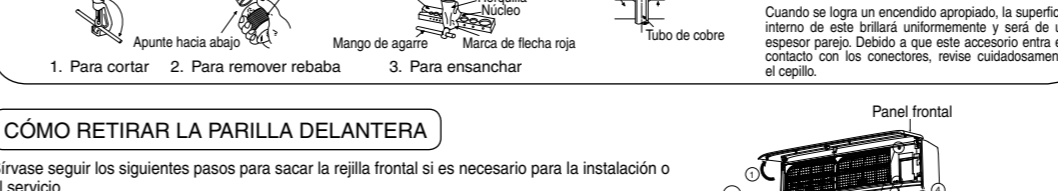
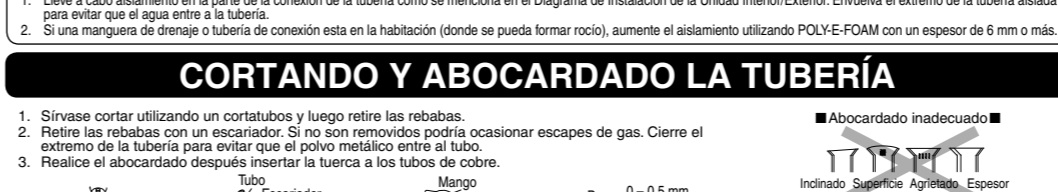
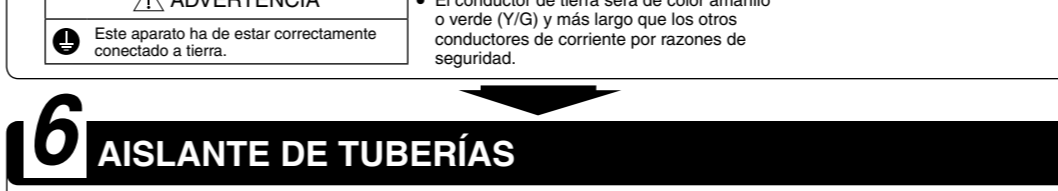
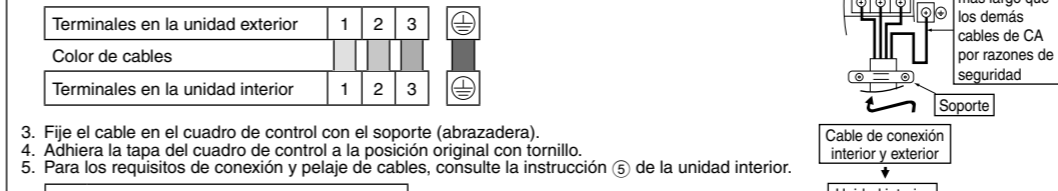
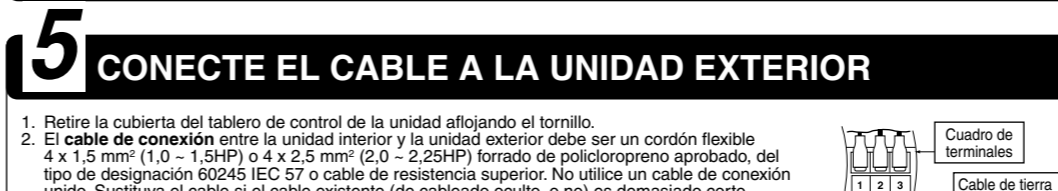
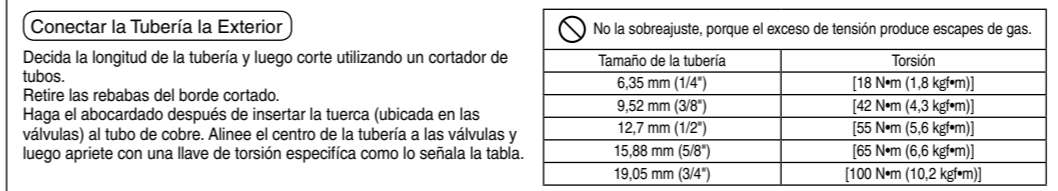
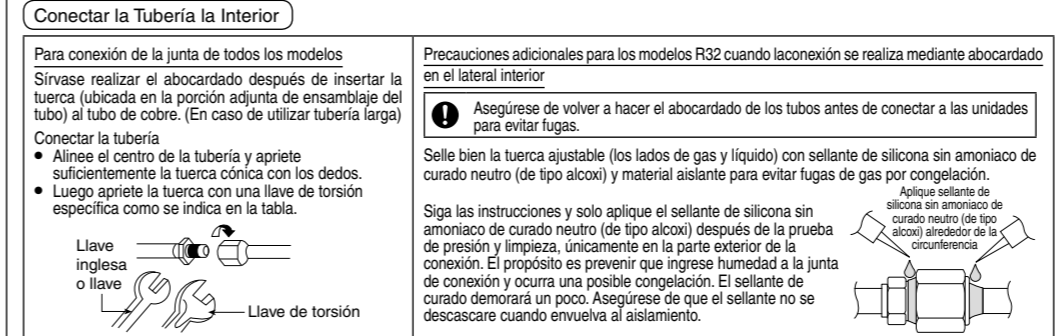

4 PRUEBA DE ESTANQUEIDAD AL AIRE DEL SISTEMA DE REFRIGERACIÓN

- No purgue el aire con refrigerantes. Utilice en su lugar una bomba de vacío para aspirar la instalación.
- La unidad exterior no contiene refrigerante adicional para la purga del aire.

- Antes de cargar el sistema con refrigerante y antes de poner en funcionamiento el sistema de refrigeración, un técnico certificado y/o el instalador deben verificar el procedimiento de pruebas en alta y los criterios de aprobación que se muestran a continuación.
- Asegúrese de comprobar escapes de gas en el sistema completo.

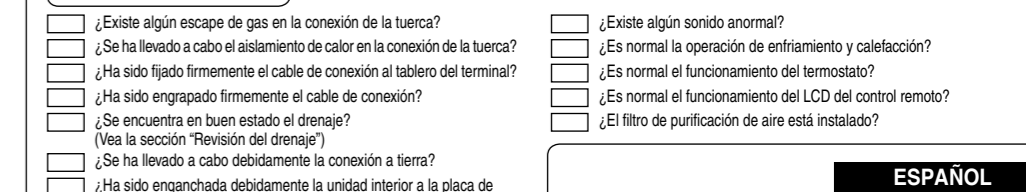
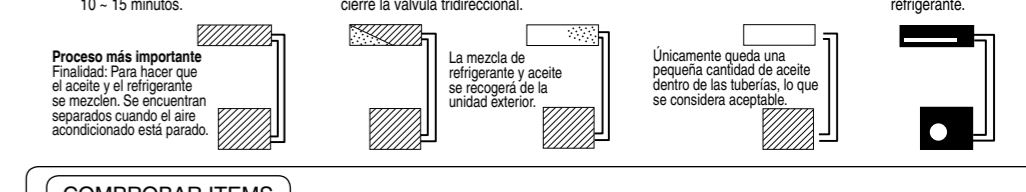
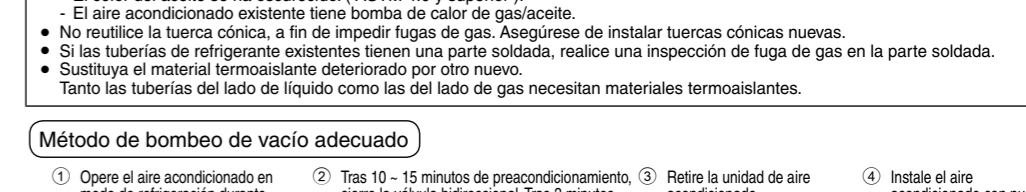
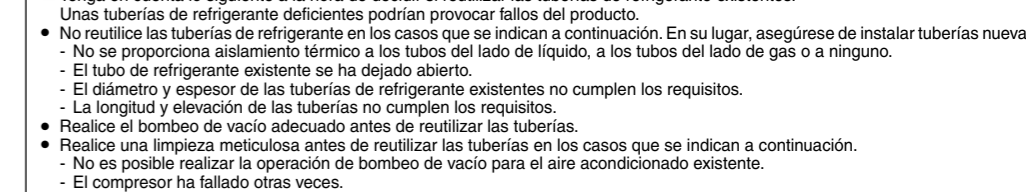
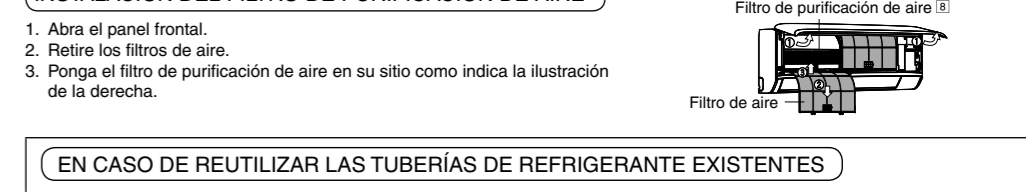
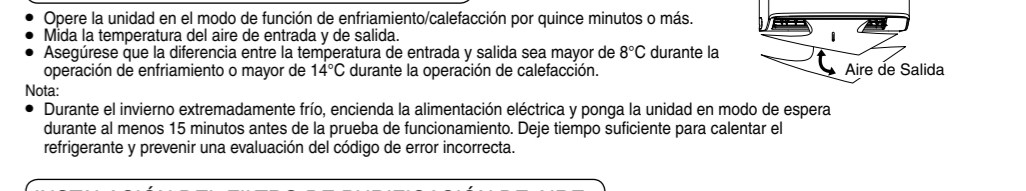
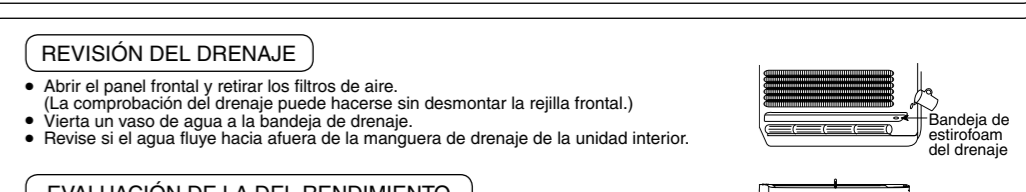
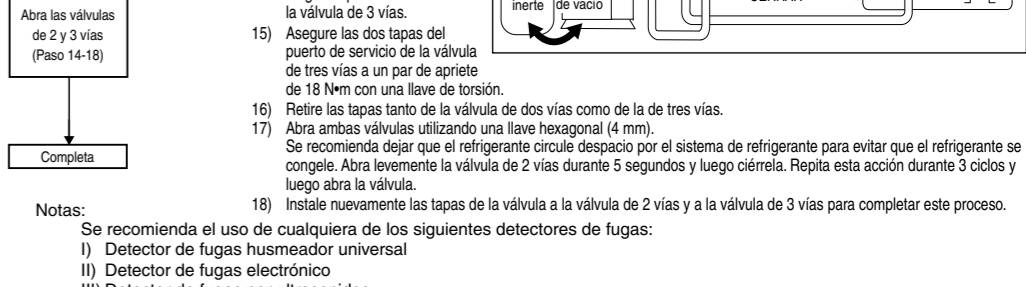
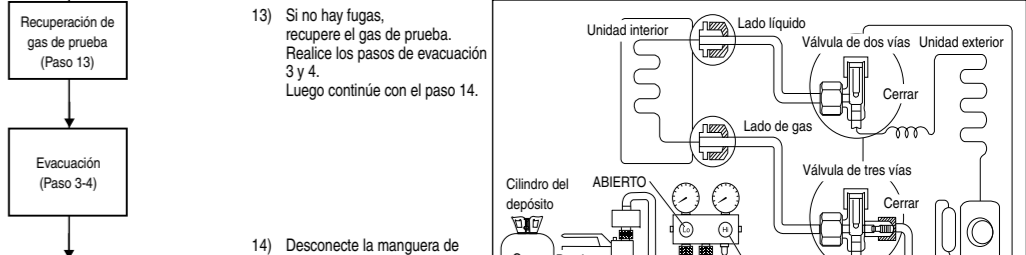
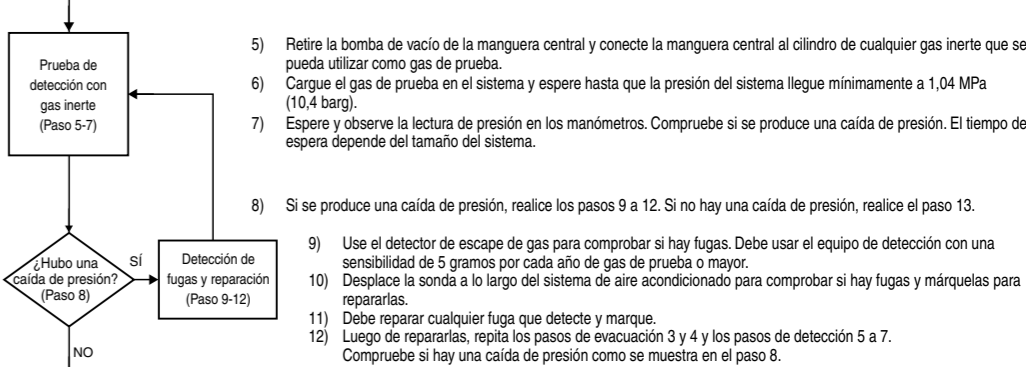
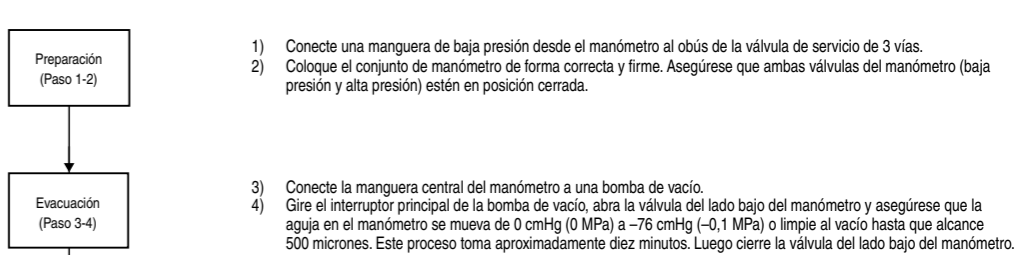

UNITÀ INTERNA

1 SCEGLIERE LA POSIZIONE MIGLIORE

(Vedi il paragrafo "Scegliere la posizione migliore")

2 COME FISSARE LA DIMA DI INSTALLAZIONE

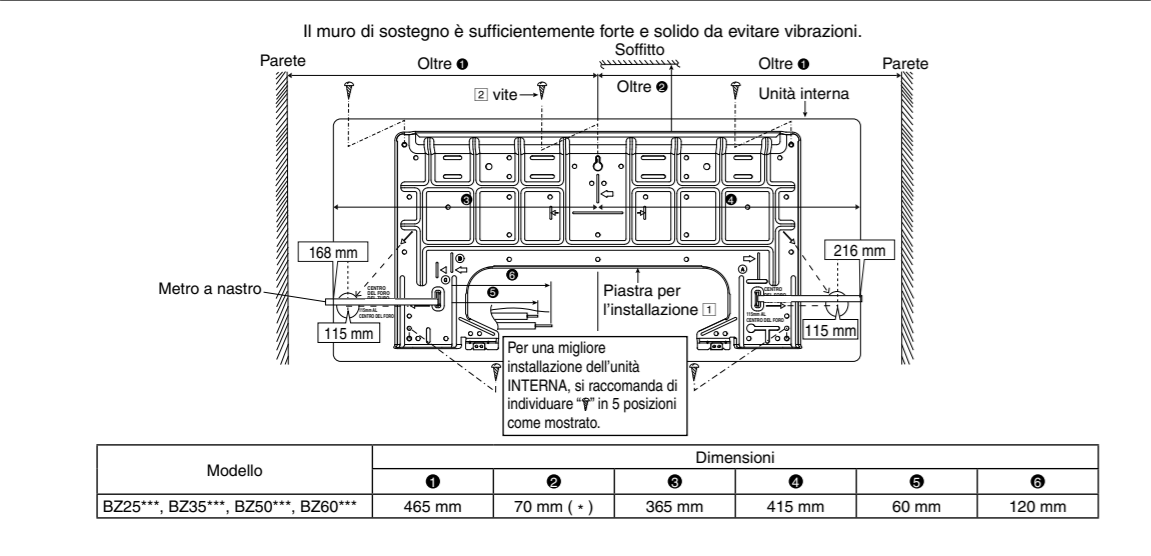

La distanza fra il centro della piastra di installazione e i lati destro e sinistro della parete deve essere superiore a ①. La distanza fra il bordo della piastra di installazione e il soffitto deve essere superiore a ②. La distanza fra il centro della dima di installazione e il lato sinistro dell'unità è di ③. La distanza fra il centro della dima di installazione e il lato destro dell'unità è di ④. Per le tubazioni di sinistra, il collegamento dei tubi per il liquido deve trovarsi a circa ⑤ da questa linea. Per le tubazioni di destra, il collegamento dei tubi per il gas deve trovarsi a circa ⑥ da questa linea. Montare la piastra di installazione sulla parete con le 5 viti o più (almeno 5 viti). (Se l'apparecchio viene montato su muro in calcestruzzo, usare bulloni di ancoraggio.) Montare sempre la piastra per l'installazione orizzontalmente allineando la tracciatura con il filo a piomba e usando la livella. Forare la piastra per l'installazione con un trapano e una punta di 470 mm. Linea in base al lato destro e sinistro della piastra d'installazione. Il punto d'incontro della linea estesa corrisponde al centro del foro. Un altro metodo è mettendo un metro nella posizione come mostrato nel diagramma di cui sopra. Il centro del foro si ottiene misurando la distanza, cioè 115 mm rispettivamente per il foro sinistro e destro. Forare il tubo sia a destra che a sinistra. Il foro dovrebbe essere leggermente inclinato verso il lato esterno.

3 FORARE IL MURO E INSTALLARE UN MANICOTTO PER TUBI

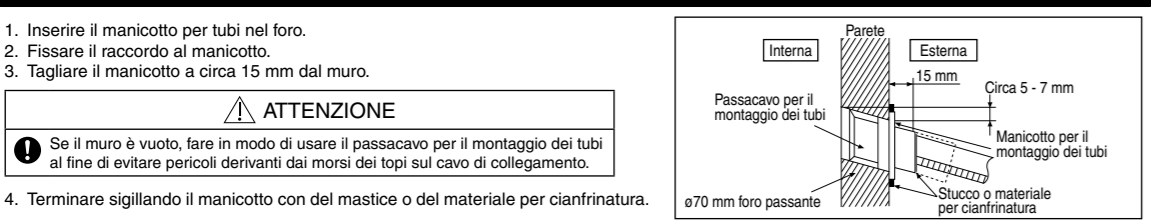

5 COLLEGAMENTO DEL CAVO ALL'UNITÀ INTERNA

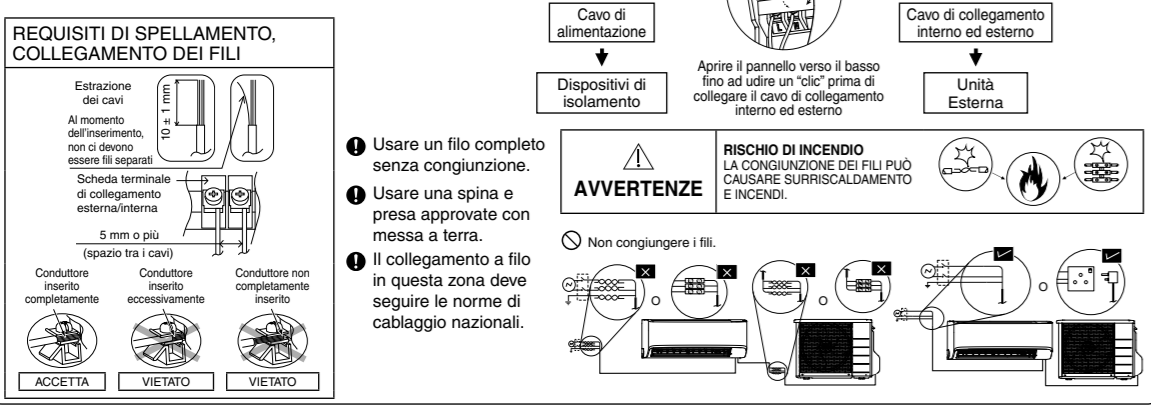
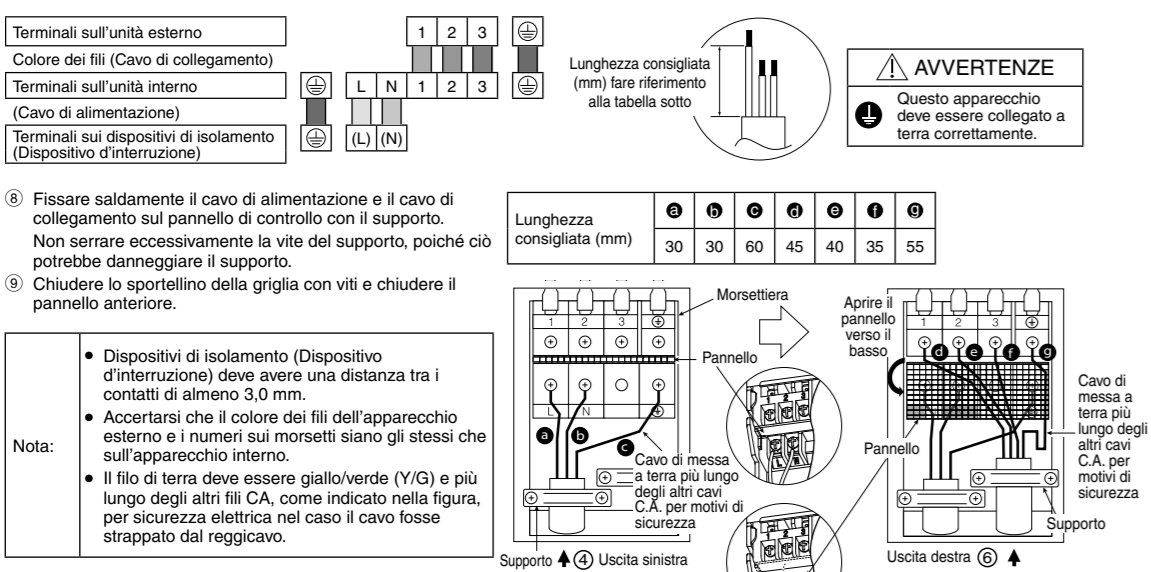
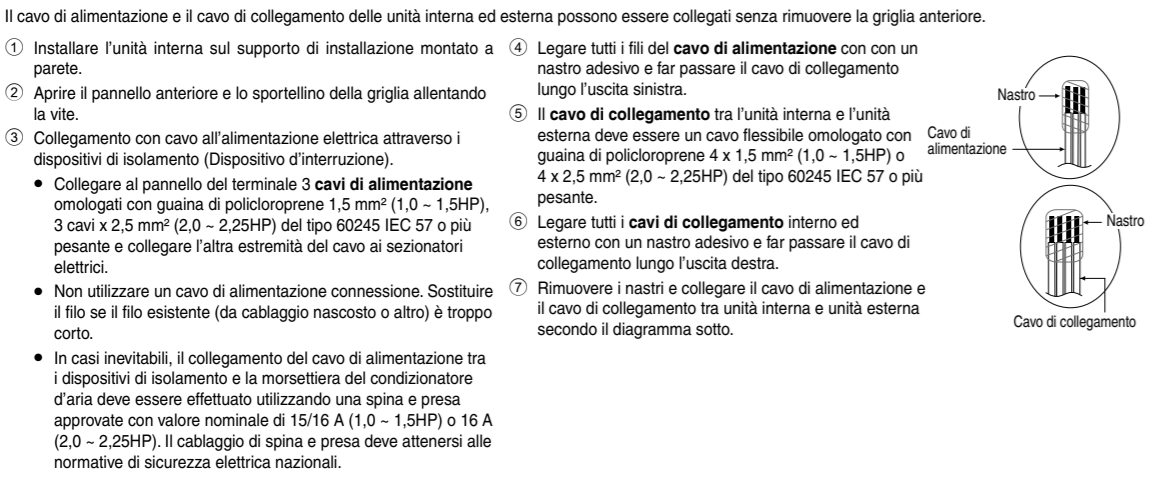

4 INSTALLAZIONE DEL TUBO INTERNA

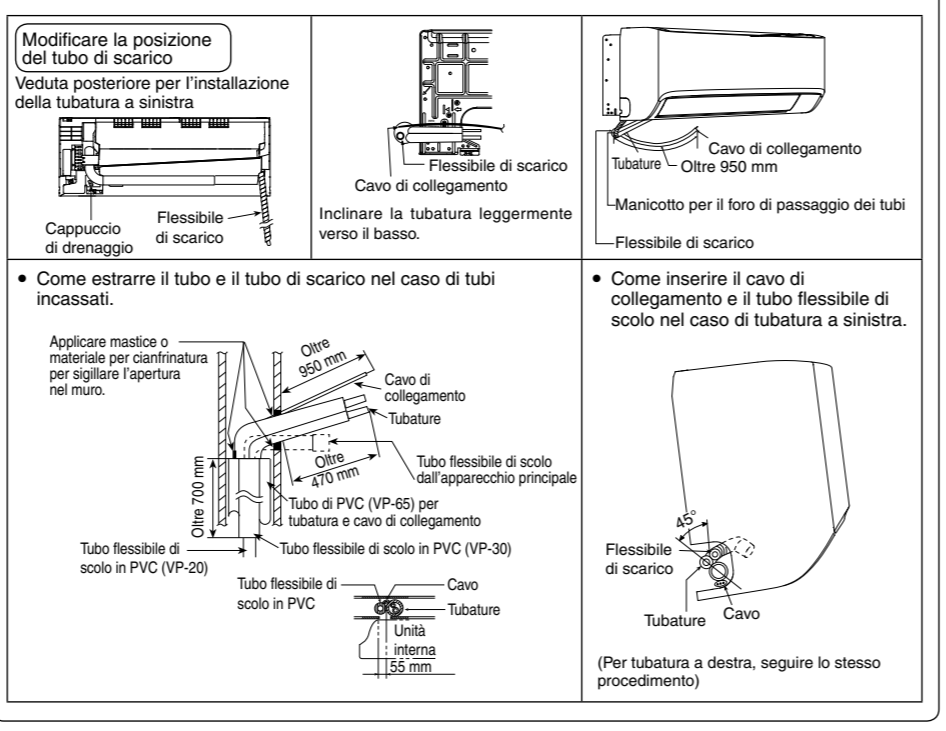
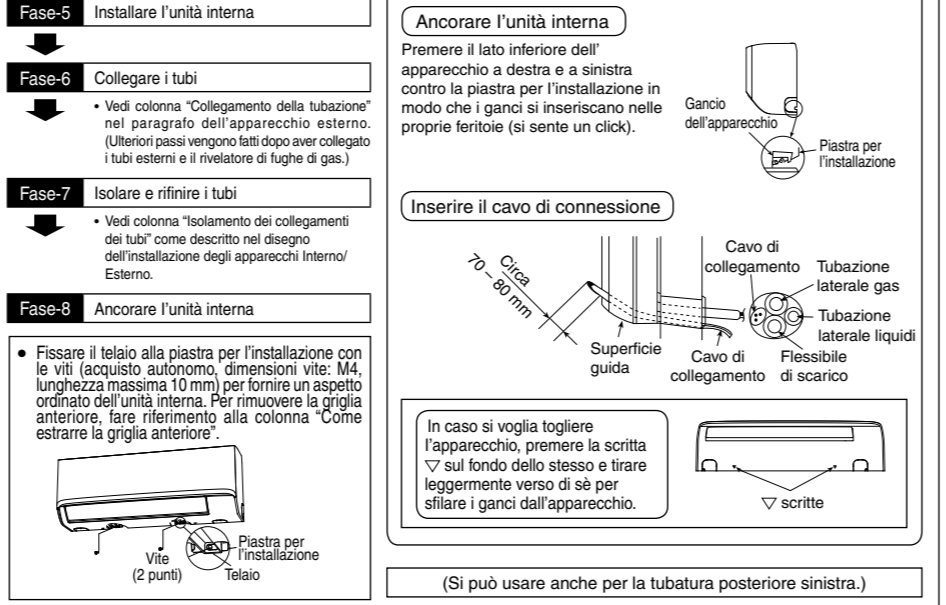
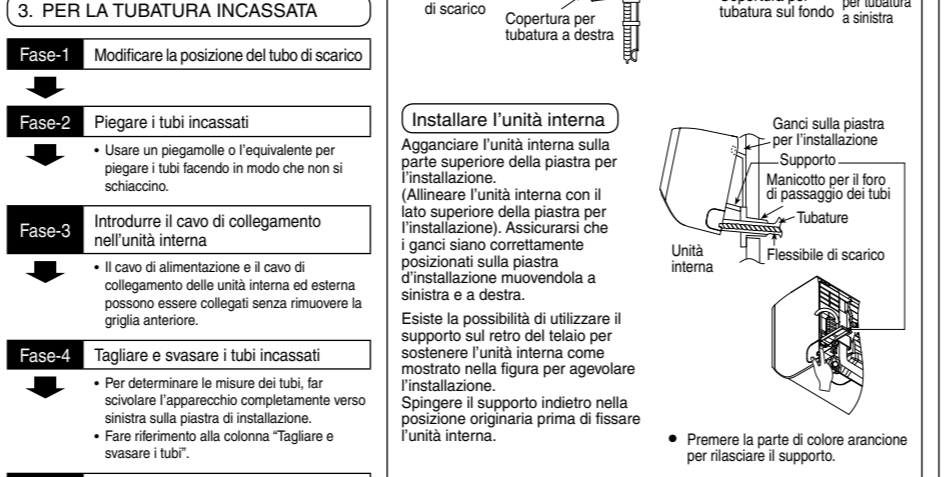
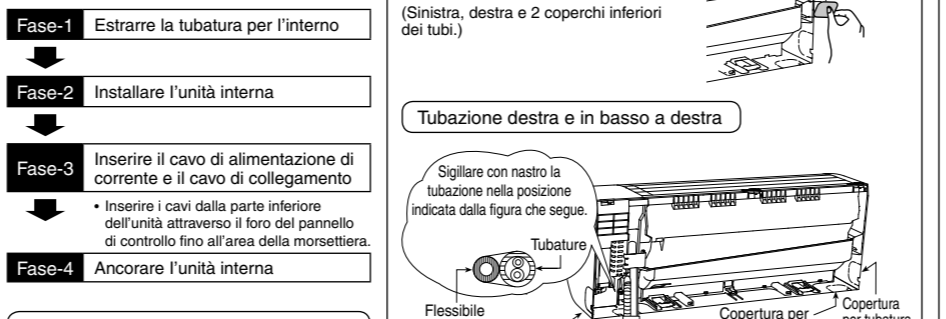
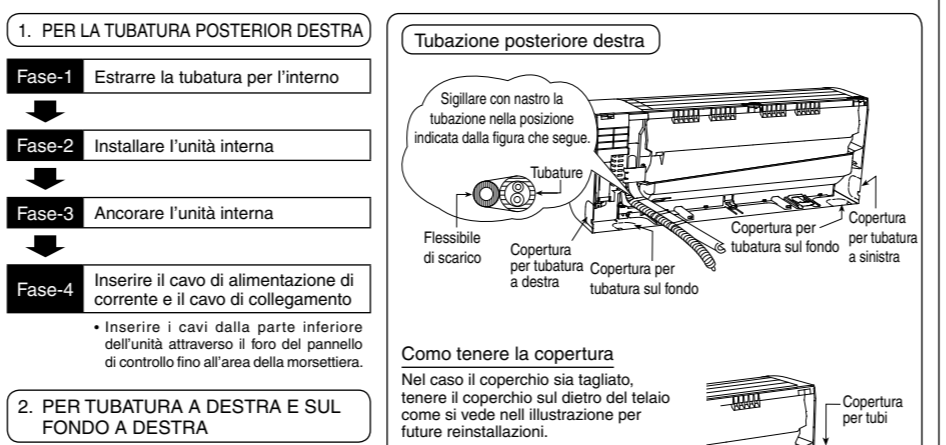
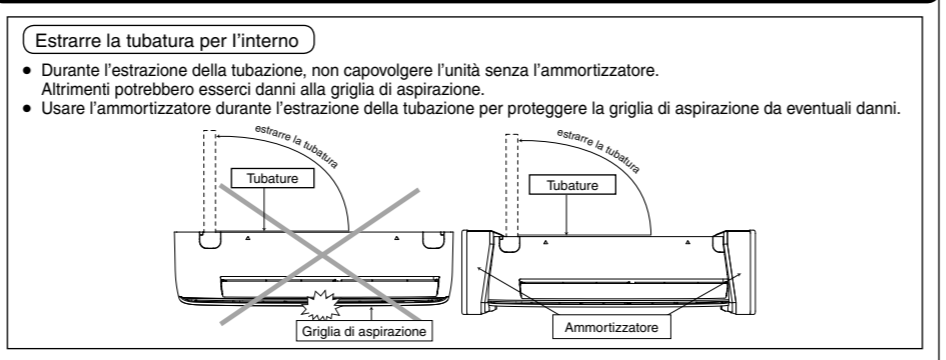

1 SCEGLIERE LA POSIZIONE MIGLIORE

(Vedi il paragrafo "Scegliere la posizione migliore")

2 INSTALLAZIONE DELL'UNITÀ ESTERNA

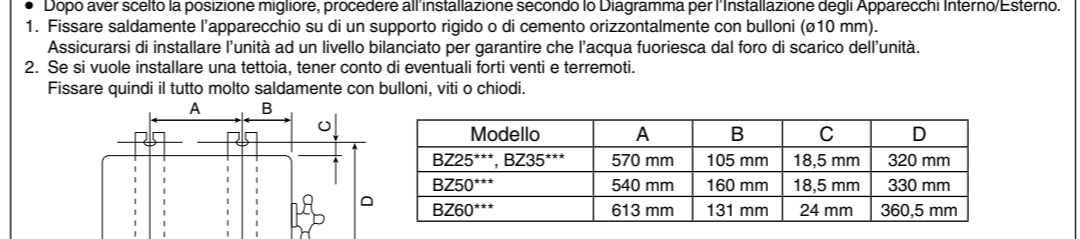

3 COLLEGARE I TUBI

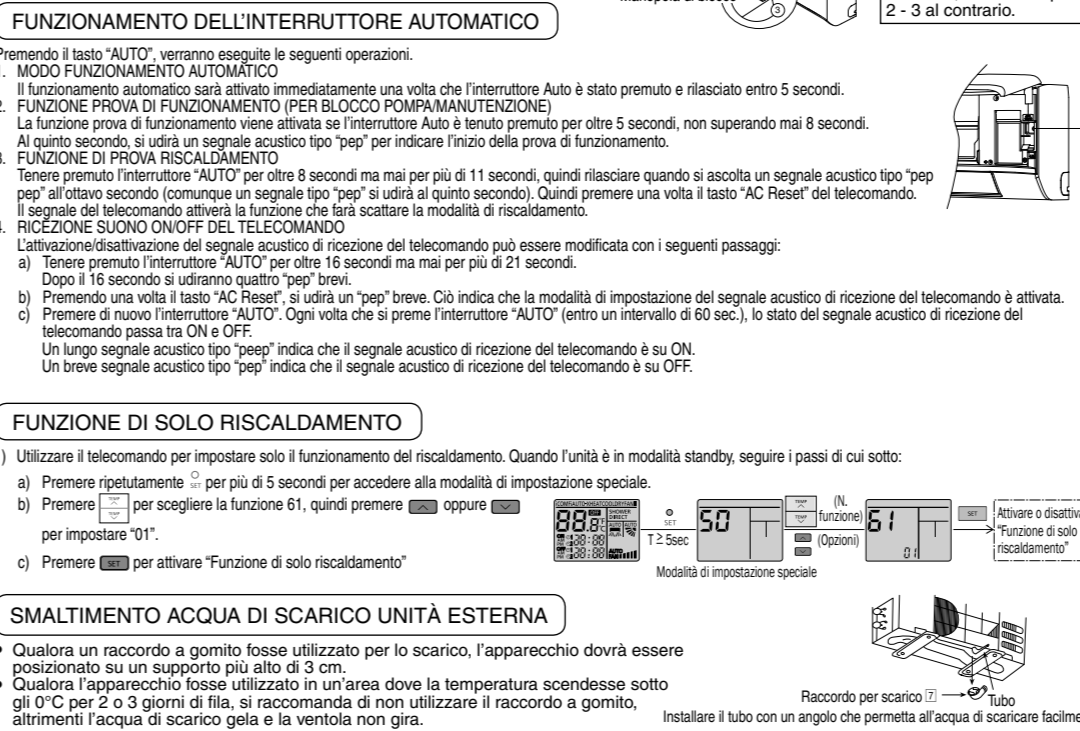
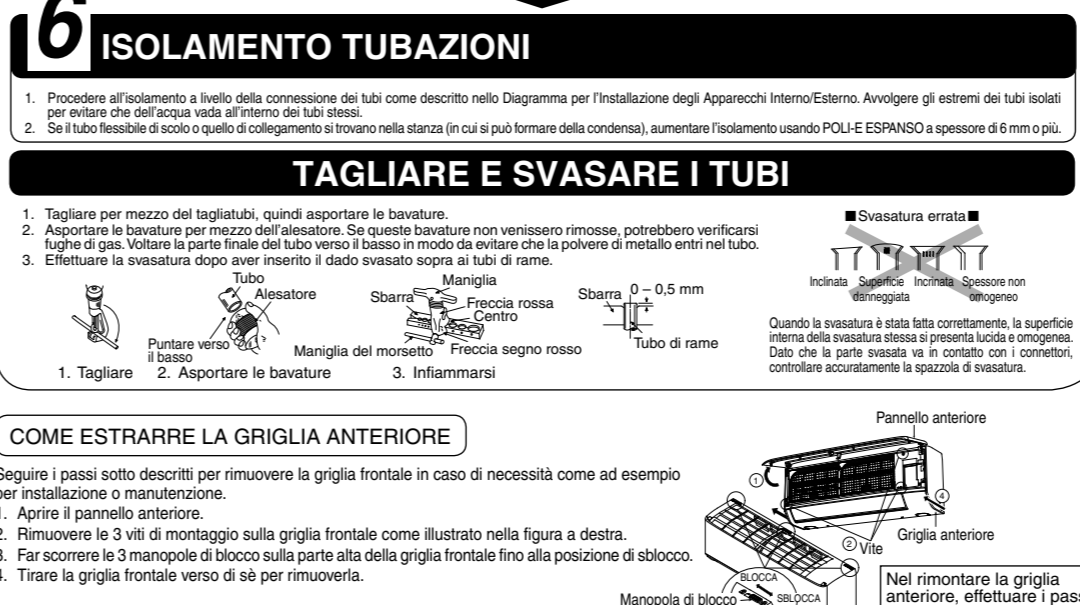
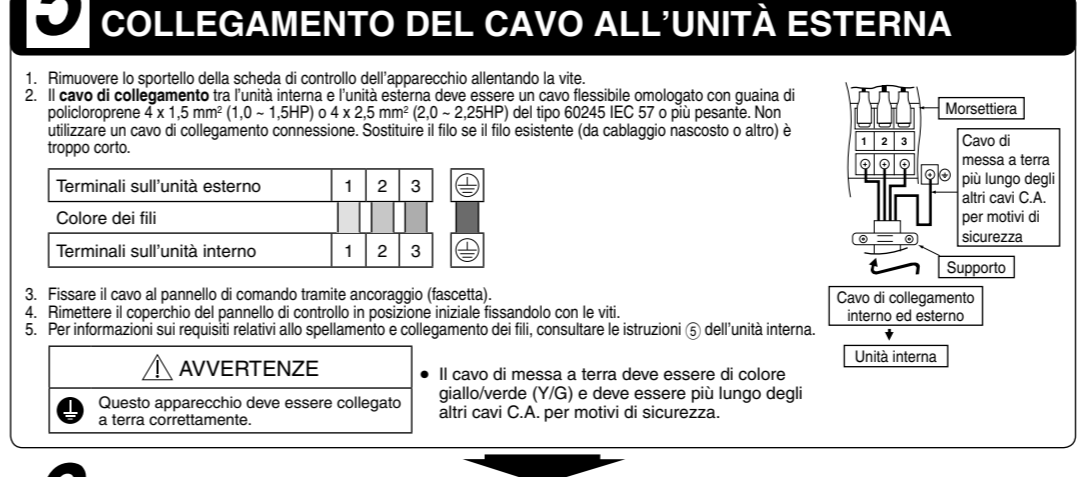
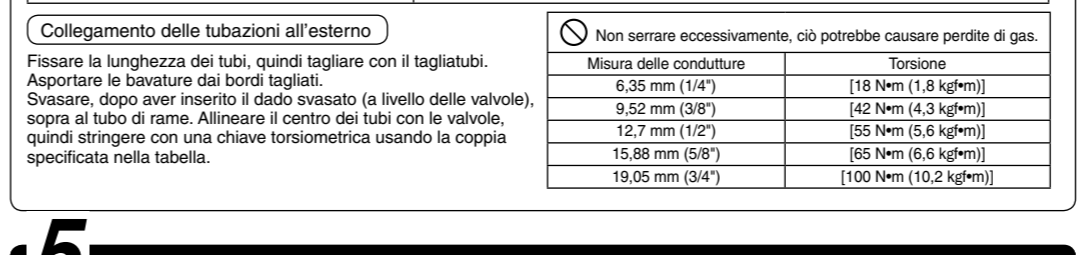
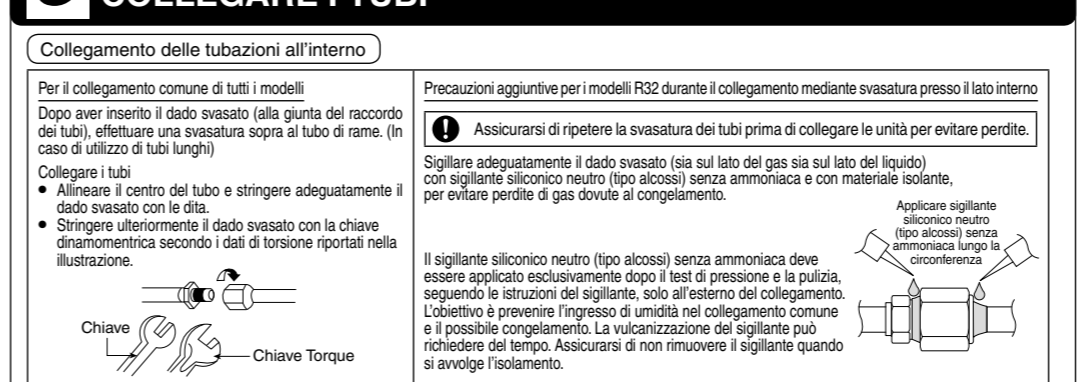

UNITÀ ESTERNA

4 TEST DI ERMETICITÀ SUL SISTEMA DI REFRIGERAZIONE

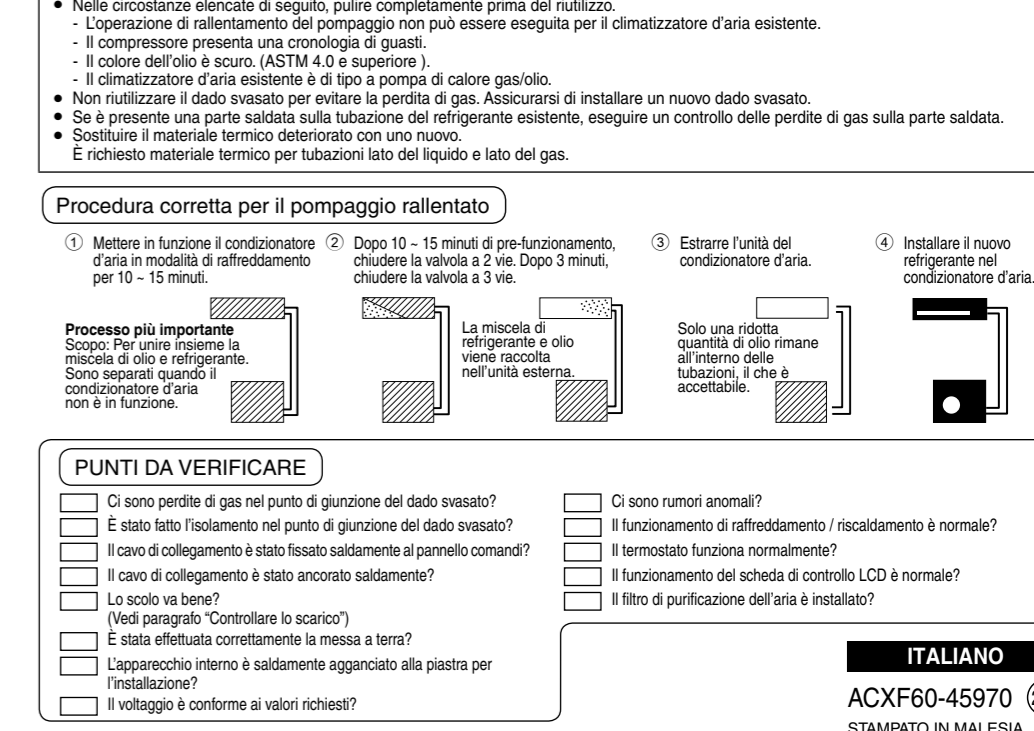
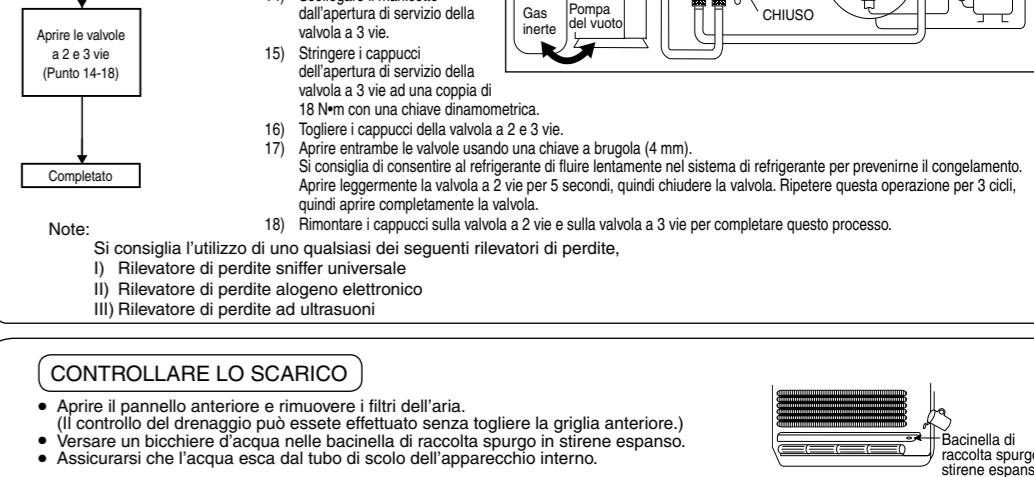
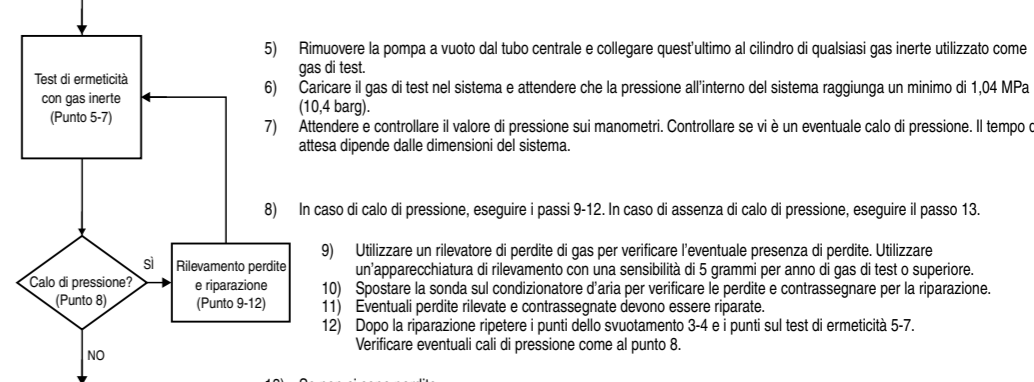
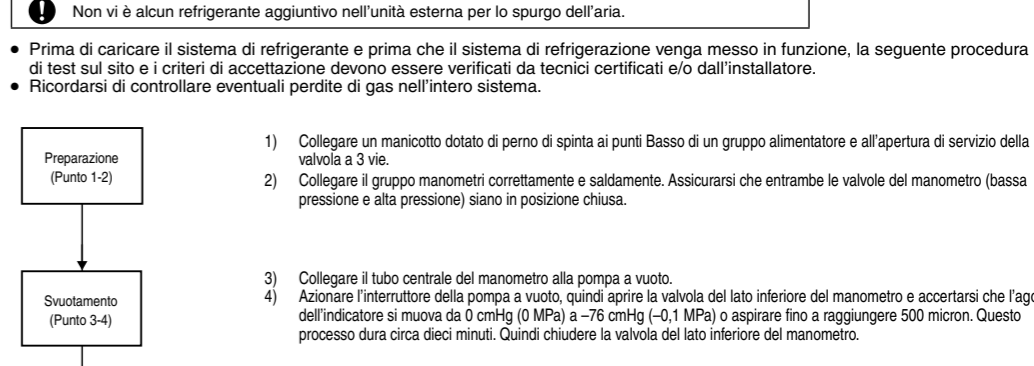

UNITÉ INTÉRIEURE

1 CHOIX DE L'EMPLACEMENT

(Cf. chapitre « Choix de l'emplacem. »)

2 MONTAGE DE LA PLAQUE D'INSTALLATION

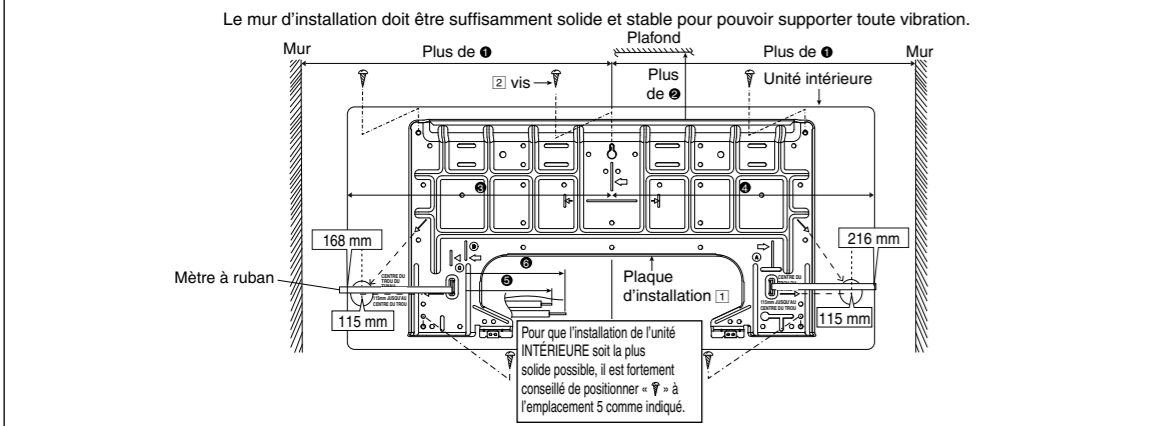

Modèle	Dimension					
	1	2	3	4	5	6
BZ25***, BZ35***, BZ50***, BZ60***	465 mm	70 mm (+)	365 mm	415 mm	60 mm	120 mm

Le centre de la plaque d'installation doit se trouver à plus de ① de la gauche et de la droite du mur. La distance entre le bord de la plaque d'installation et le plafond doit être supérieure à ②. La distance entre le centre de la plaque d'installation et le bord gauche de l'unité est de ③. La distance entre le centre de la plaque d'installation et le bord droit de l'unité est de ④.

⑤ : Pour la conduite gauche, le raccordement du liquide doit se trouver à ⑤ environ de cette ligne.

⑥ : Pour la conduite droite, le raccordement du gaz doit se trouver à ⑥ environ de cette ligne.

- Fixez la plaque d'installation au mur à l'aide de 5 vis ou plus (au moins 5 vis). (Si vous comptez installer l'unité sur un mur en béton, utilisez des boutons-agrafe.)
- Veillez toujours fixer la plaque d'installation à l'horizontale en alignant la ligne verticale de référence et le fil et en utilisant un niveau.
- Percer le trou pour le raccordement de tuyauterie à l'aide d'un foret hélicoïdal à fraiser de ø70 mm.
- Alignez en fonction de côté gauche et du côté droit de la plaque d'installation.

Le point de rencontre de la ligne d'extension est le centre de ce trou.

Une autre méthode consiste à utiliser un mètre à ruban comme indiqué dans le schéma ci-dessous.

Le centre du trou est obtenu en mesurant la distance, à savoir 115 mm, pour le trou de droite et le trou de gauche respectivement.

⑦ Percer le trou pour le raccordement de tuyauterie soit à droite, soit à gauche en veillant à ce qu'il soit légèrement en biais vers le côté extérieur.

3 PERÇAGE D'UN TROU DANS LE MUR ET INSTALLATION D'UNE GAINE DE TUYAUTERIE

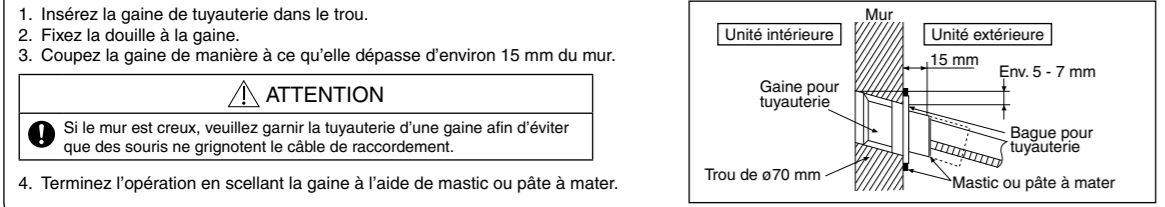

5 RACCORDEMENT DU CÂBLE À L'UNITÉ INTÉRIEURE

Le cordon d'alimentation électrique et le câble de raccordement de l'unité extérieure peuvent être raccordés sans retirer la grille frontale.

- Installez l'unité intérieure sur le support d'installation monté sur le mur.
- Ouvrez le panneau avant et la porte de la grille en desserrant la vis.
- Raccordement du câble à l'alimentation par vanne d'isolement (Dispositif de sectionnement).
- Connectez le cordon d'alimentation à gaine de polychloroprène approuvé 3 x 1,5 mm² (1,0 - 1,5HP), 3 x 2,5 mm² (2,0 - 2,25HP) classification 60245 CEI 57 ou un câble de calibre supérieur au bornier et raccordez l'autre extrémité du câble à un dispositif d'isolement (Dispositif de sectionnement).
- N'utilisez pas de cordon d'alimentation électrique équipé d'une rallonge. Remplacez le fil si le fil existant (du câblage dissimulé, ou autre) est trop court.
- Si c'est inévitable, il est possible d'ajouter une rallonge au cordon d'alimentation électrique entre les vannes d'isolement et le bornier du climatiseur en utilisant une prise et une fiche homologuées de 1516 A (1,0 - 1,5HP) ou 16 A (2,0 - 2,25HP). Les travaux de câblage de la prise et de la fiche doivent respecter les normes de câblage nationales.

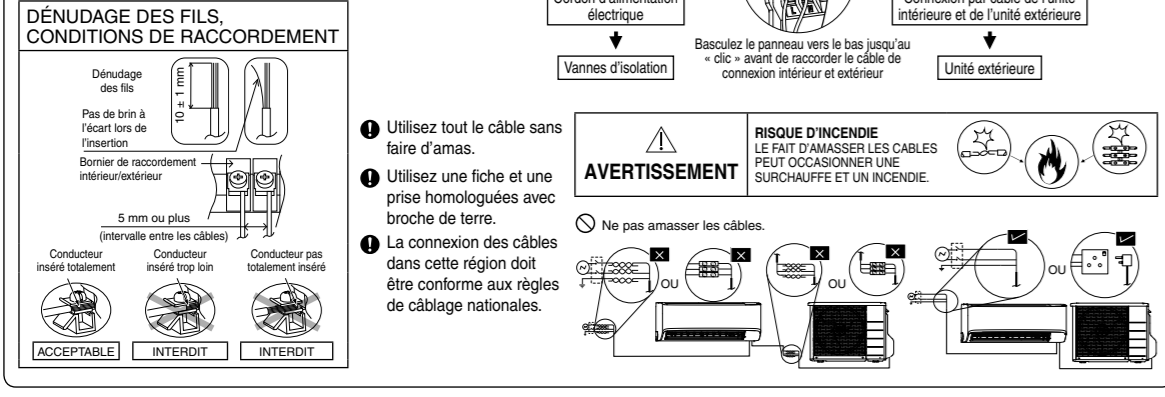
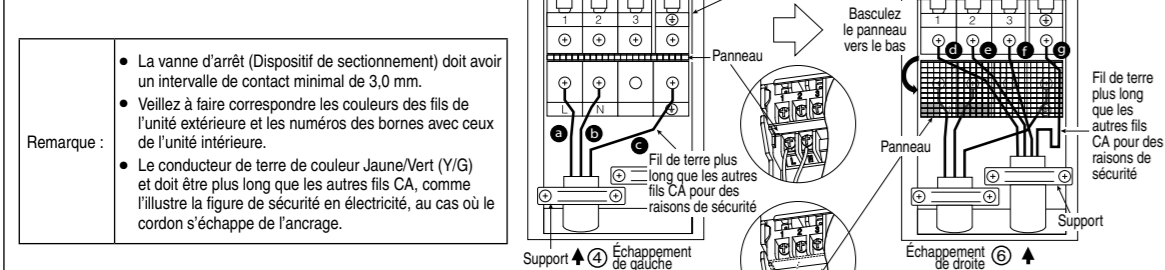
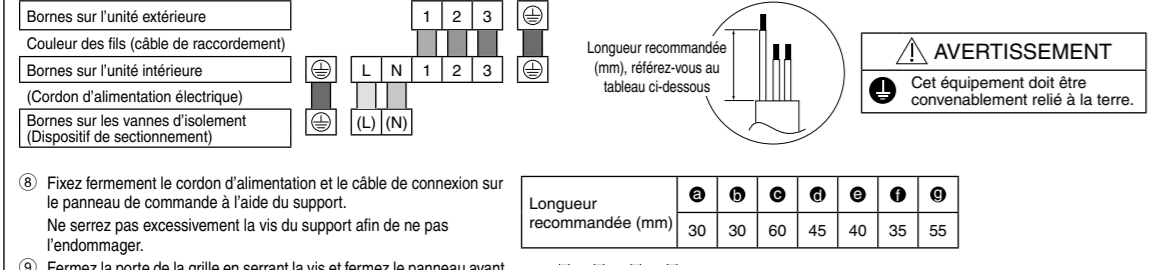

4 INSTALLATION DE L'UNITÉ INTÉRIEURE

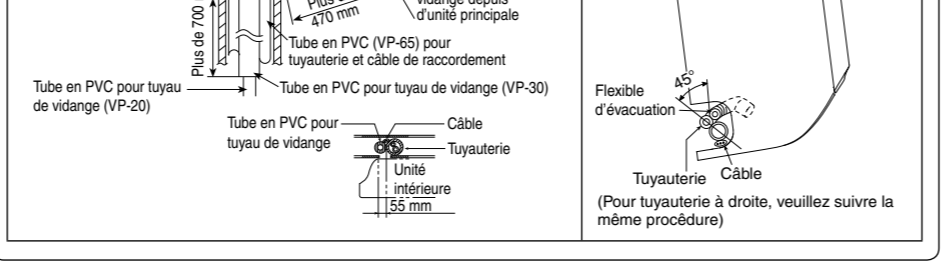
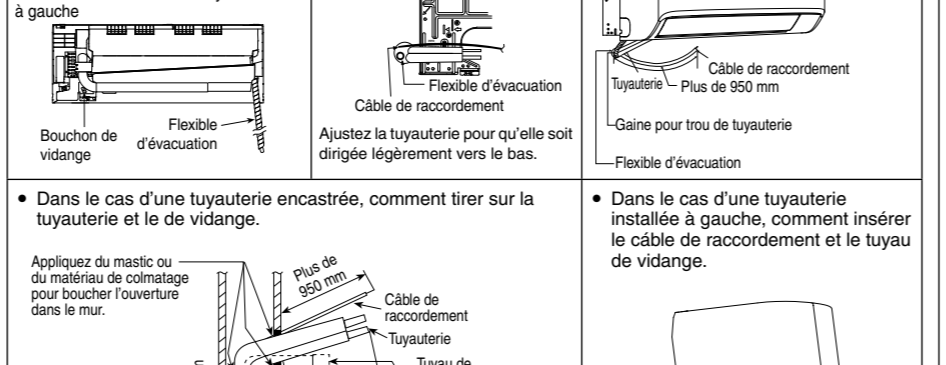
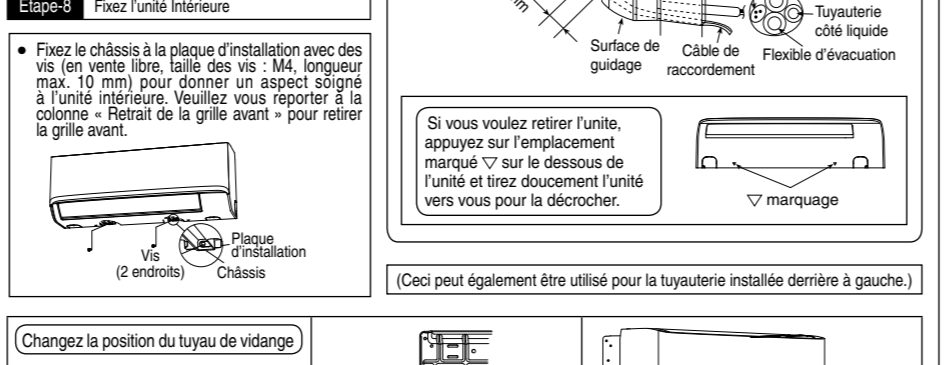
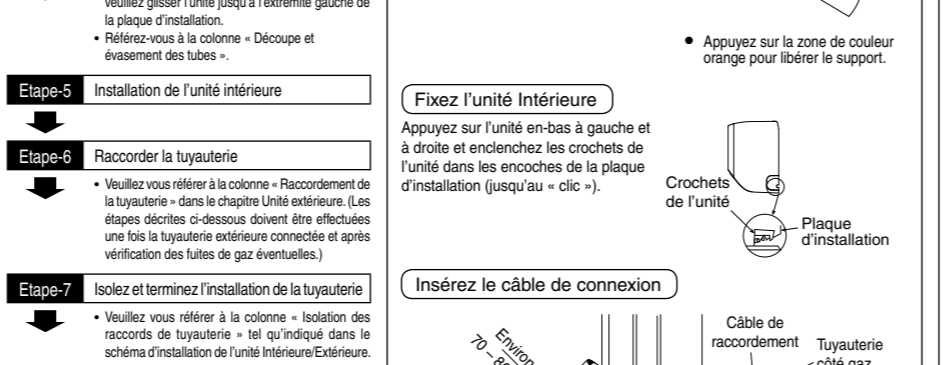
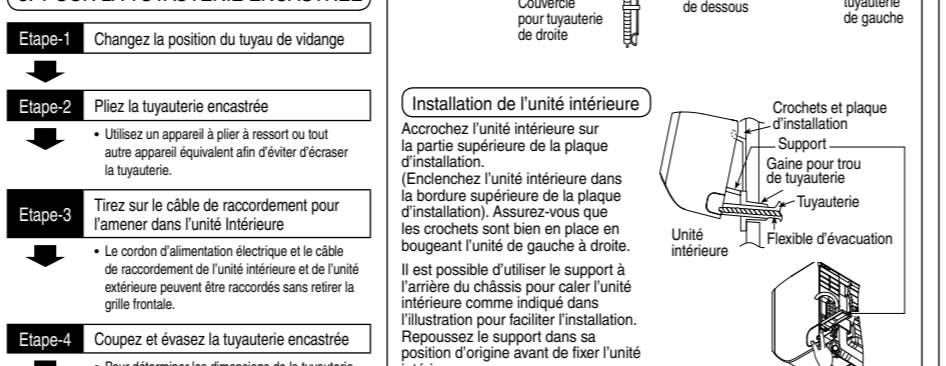
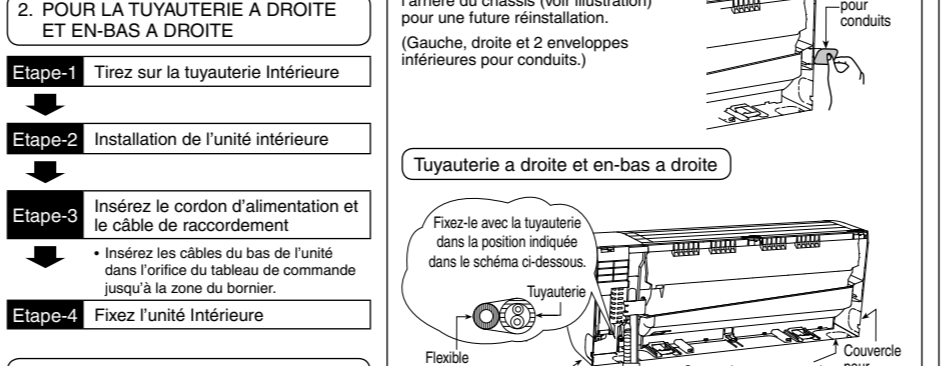
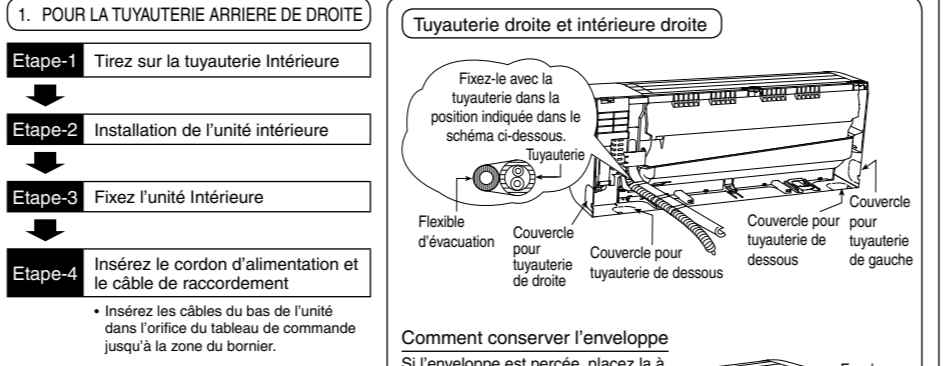
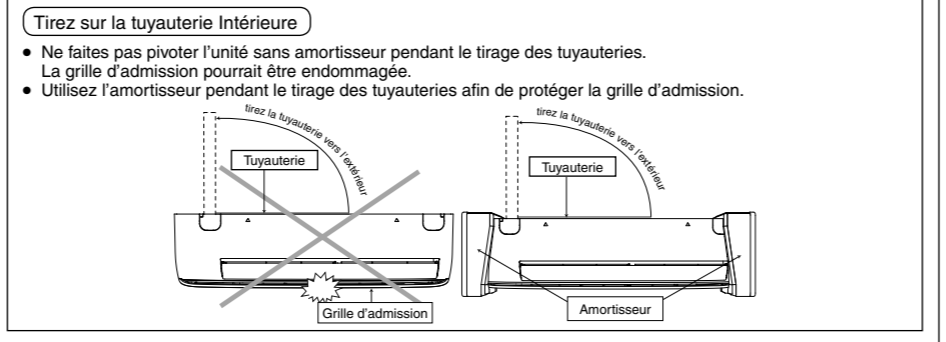

UNITÉ EXTÉRIEURE

1 CHOIX DE L'EMPLACEMENT

(Cf. chapitre « Choix de l'emplacem. »)

2 INSTALLATION DE L'UNITÉ EXTÉRIEURE

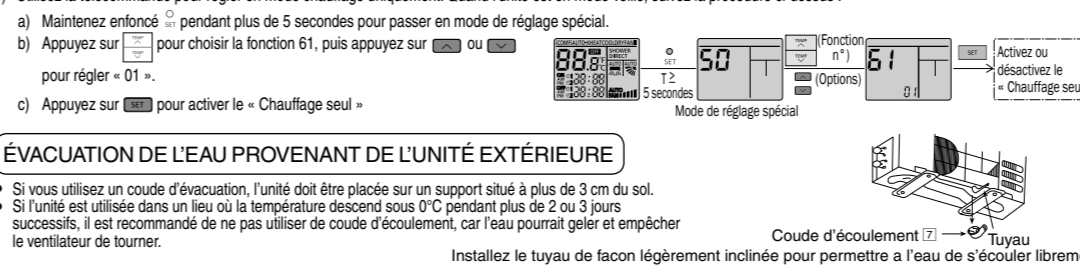
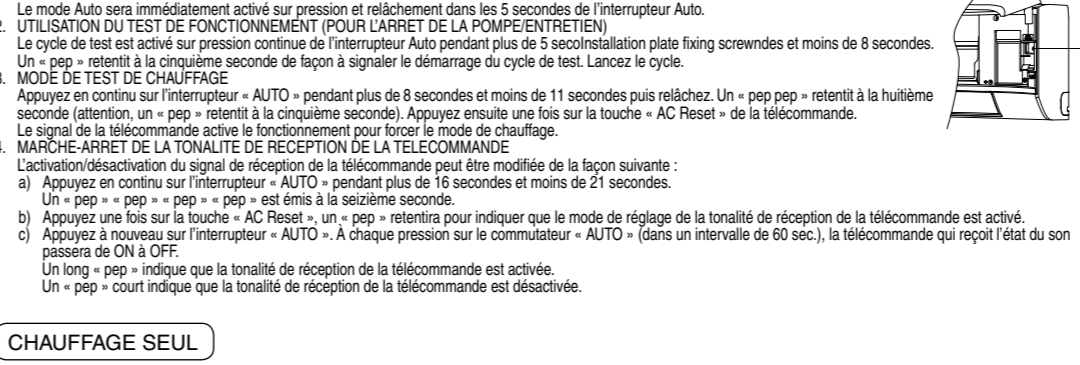
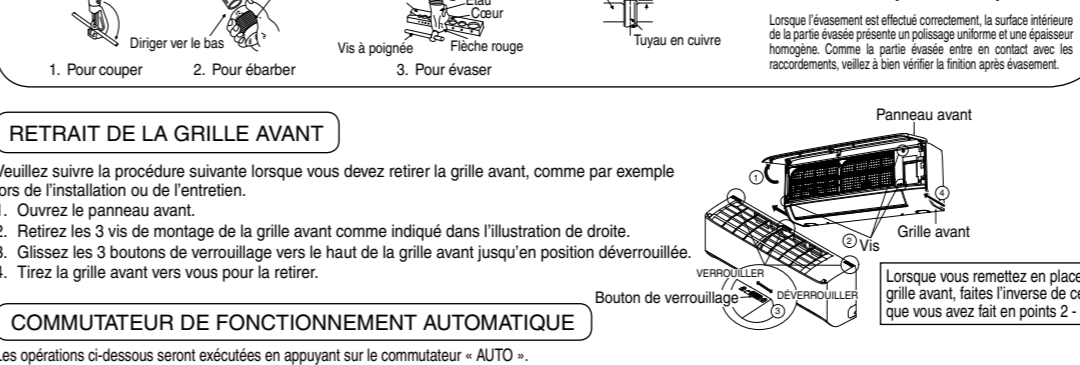
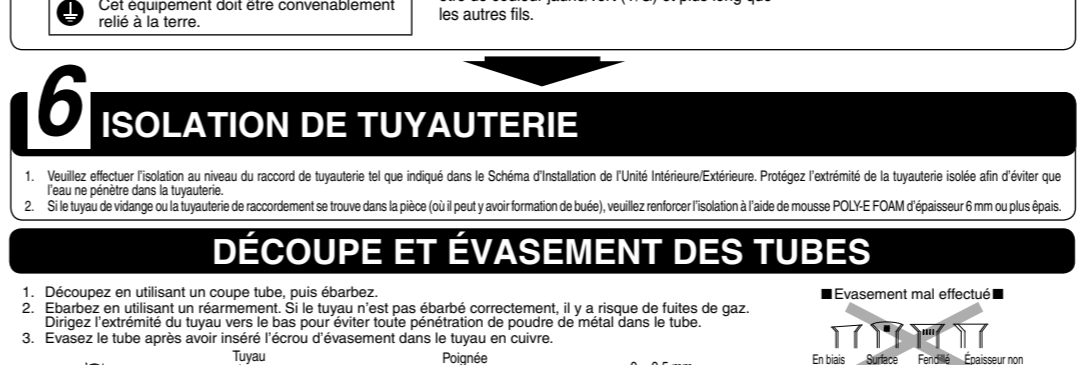
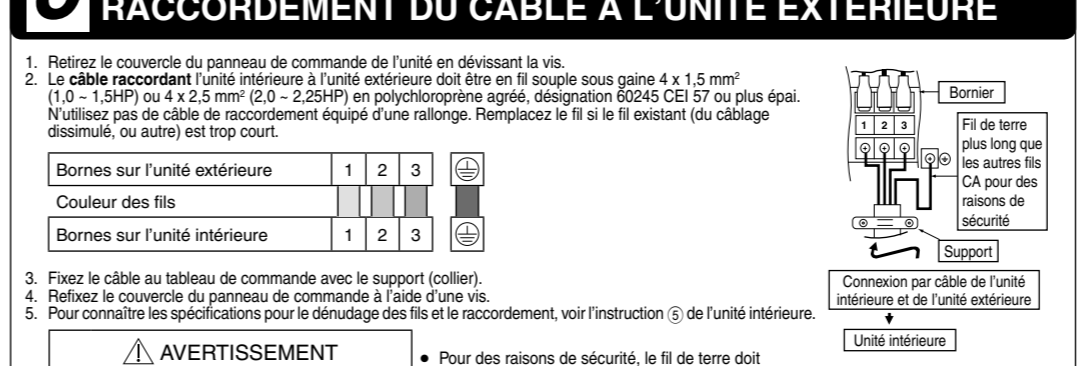
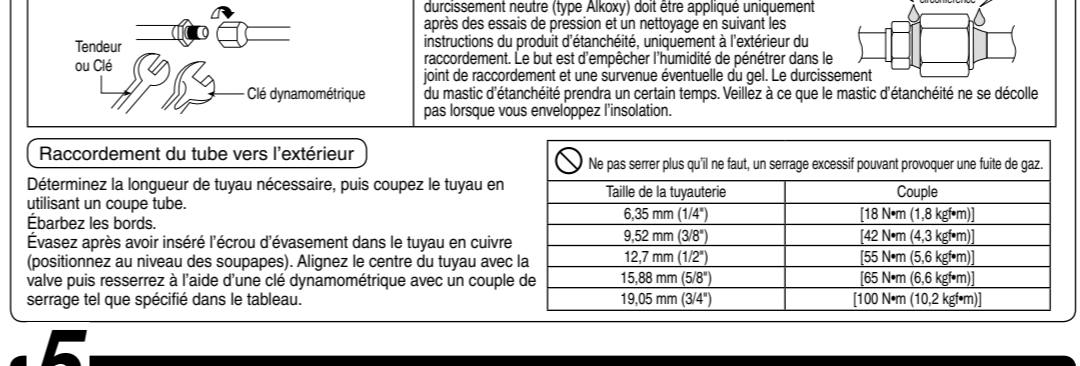
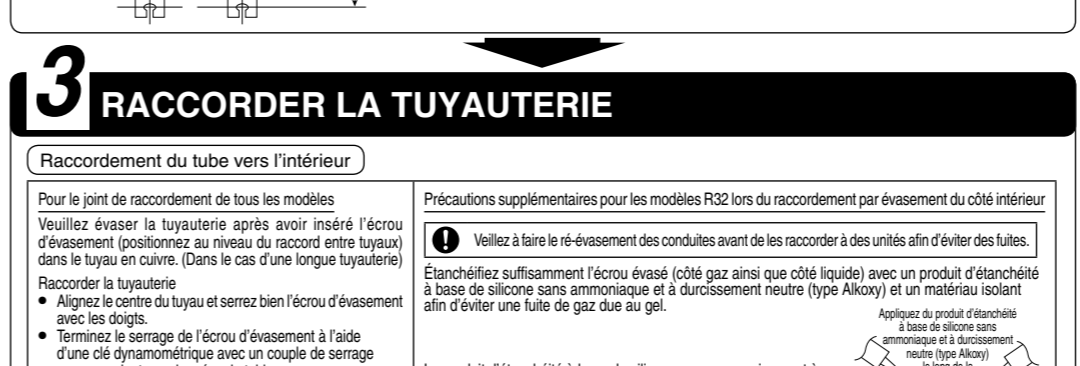
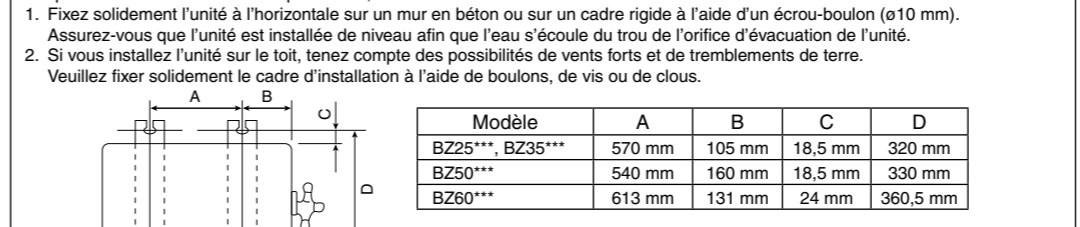

LA MÉTHODE DE PURGE DE L'AIR EST INTERDITE POUR LE SYSTÈME R32

4 TEST D'ÉTANCHÉITÉ À L'AIR SUR LE SYSTÈME DE RÉFRIGÉRANT

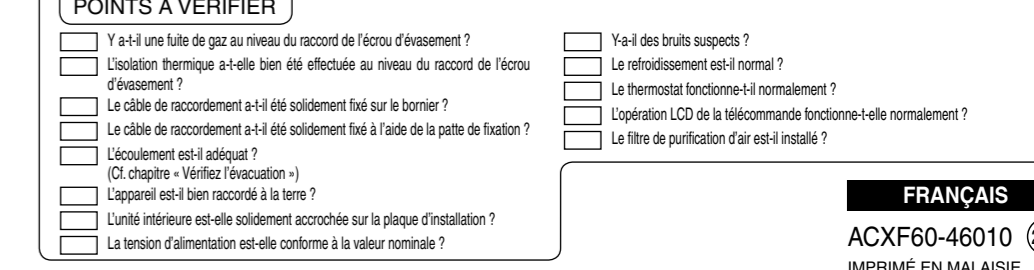
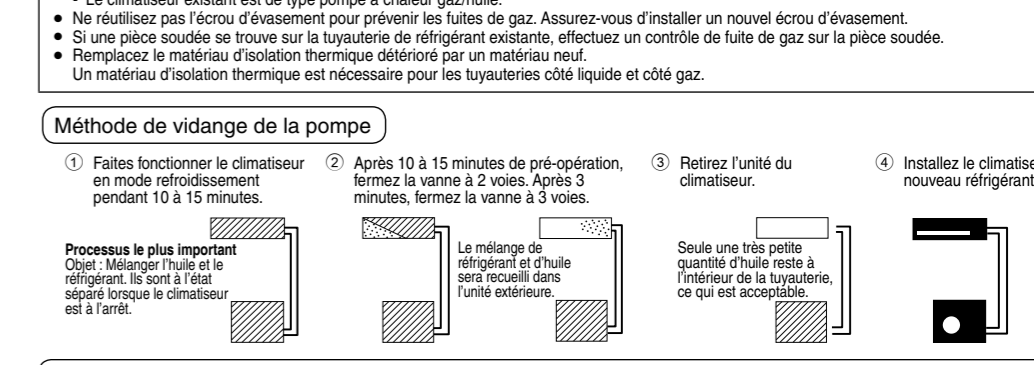
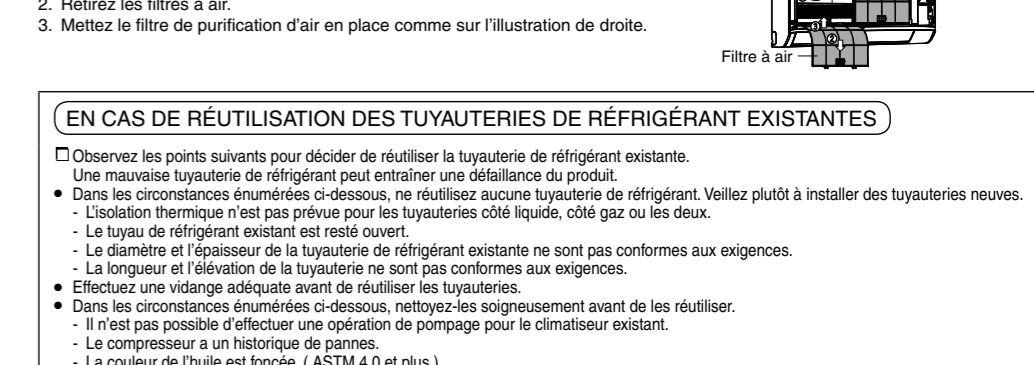
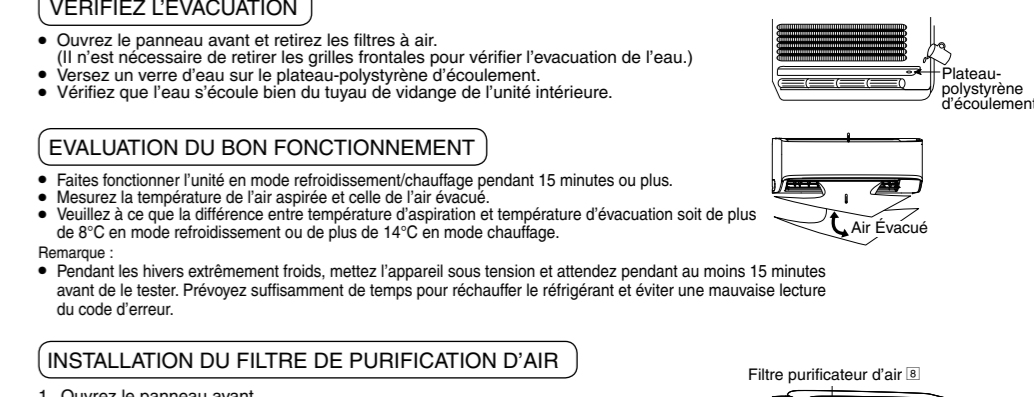
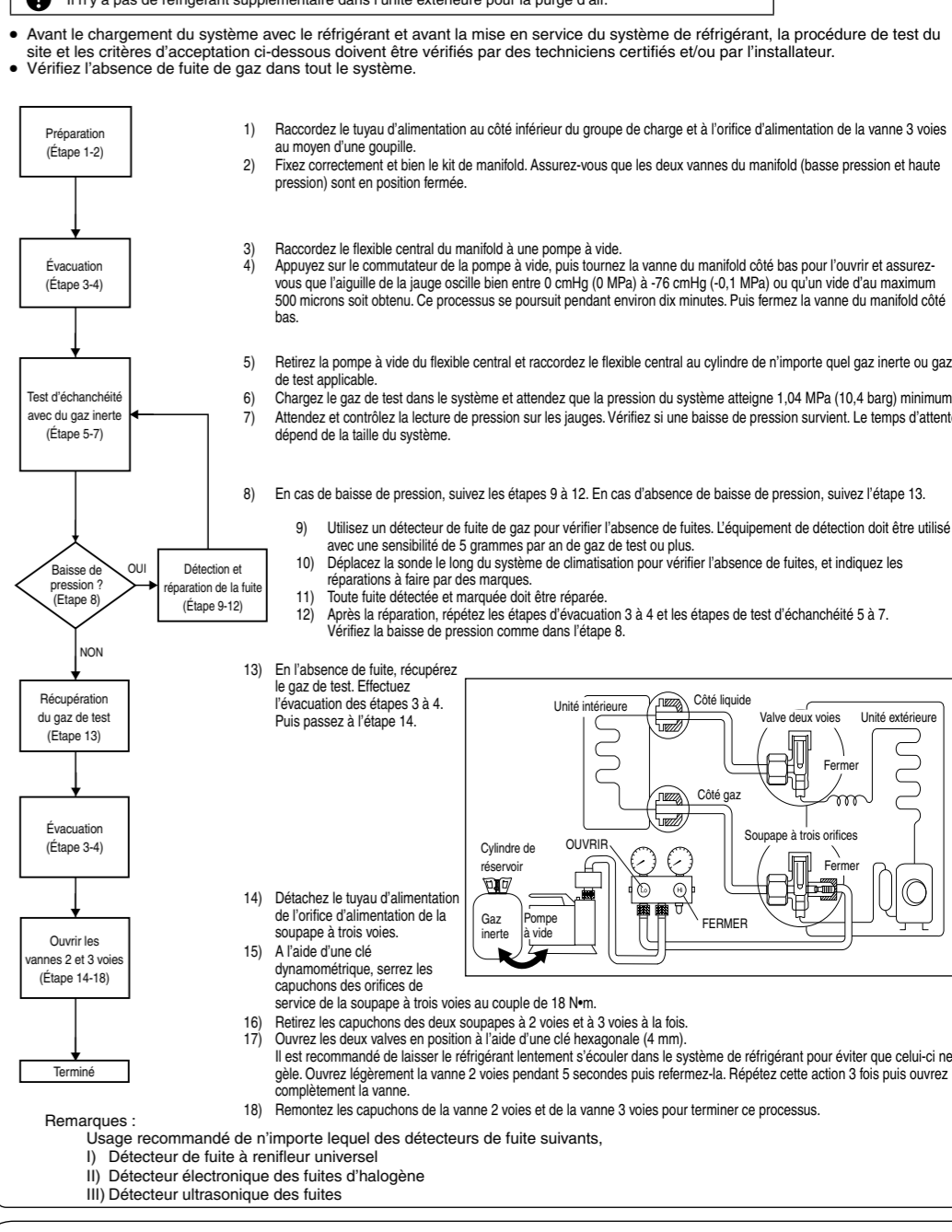

INNENGERÄT

1 WAHL DES STANDORTS

2 ANBRINGEN DER MONTAGEPLATTE

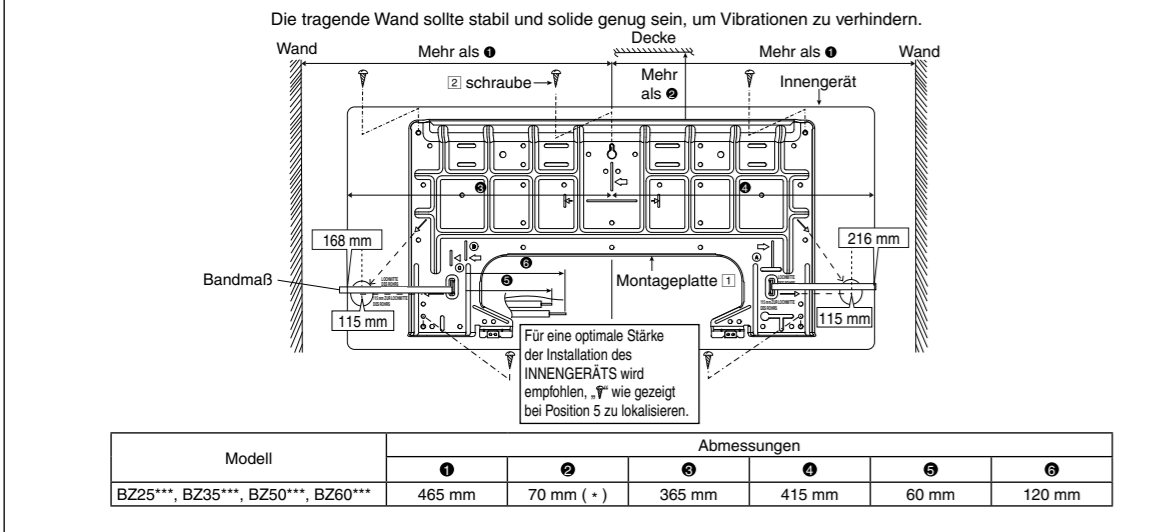

Der Mittelpunkt der Montageplatte sollte rechts und links mindestens 1 von der Wand entfernt sein. Abstand vom Rand der Montageplatte zur Decke muss mehr als 2 sein. Abstand von der Mitte der Montageplatte zur linken Geräteseite: 3. Abstand von der Mitte der Montageplatte zur rechten Geräteseite: 4.

3 BOHREN DER WANDDURCHFÜHRUNG UND ANBRINGEN DER MUFFE

- 1. Muffe in die Durchführung einsetzen. 2. Überziehmuffe einsetzen. 3. Muffe so abschieben, dass sie ca. 15 mm von der Wand absteht.

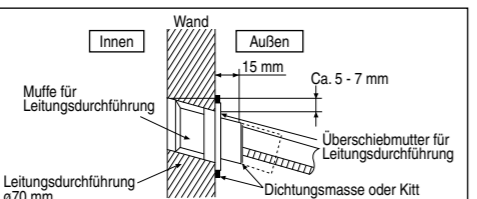

5 KABELANSCHLUSS AM INNENGERÄT

- Zum Anschluss des Netzkabels sowie des Verbindungskabels zwischen Innengerät und Außengerät muss das vordere Gitter nicht abgenommen werden. 1. Installieren Sie das Innengerät an der an der Wand angebrachten Haltervorrichtung.

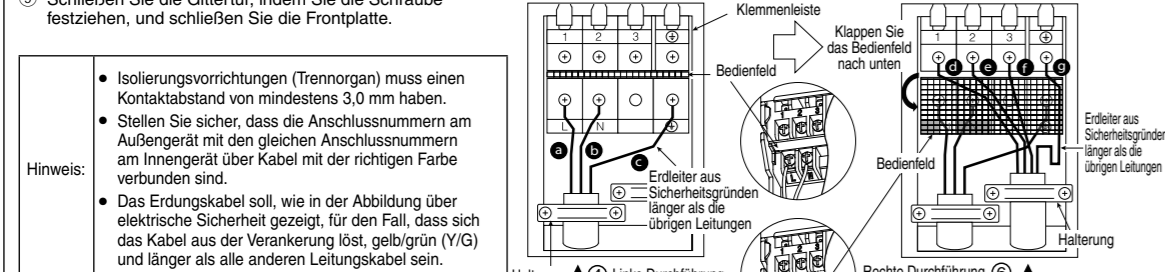
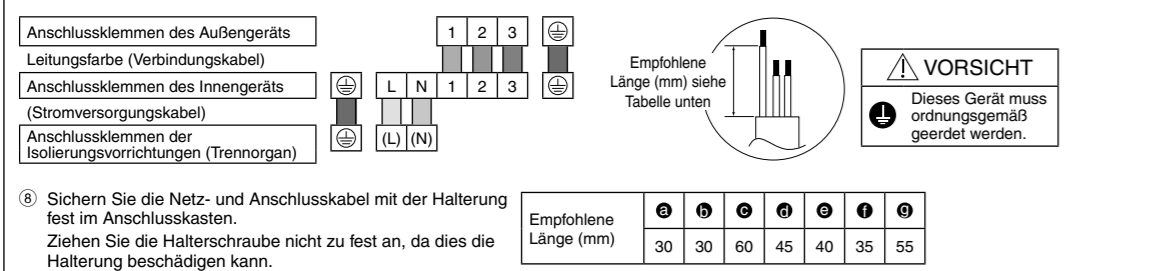

- ABISOLIEREN, ANSCHLUSSBEDINGUGEN: 1. Verwenden Sie den kompletten Draht, ohne ihn kurzzuschneiden. 2. Verwenden Sie eine geeignete Steckdose und einen geeigneten Stecker mit Erdungsstift.

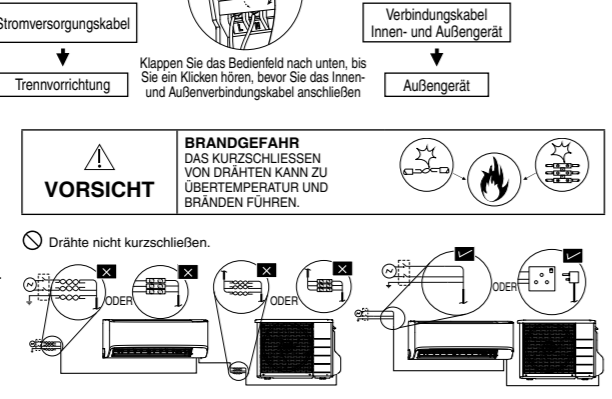

4 MONTAGE DES INNENGERÄTS

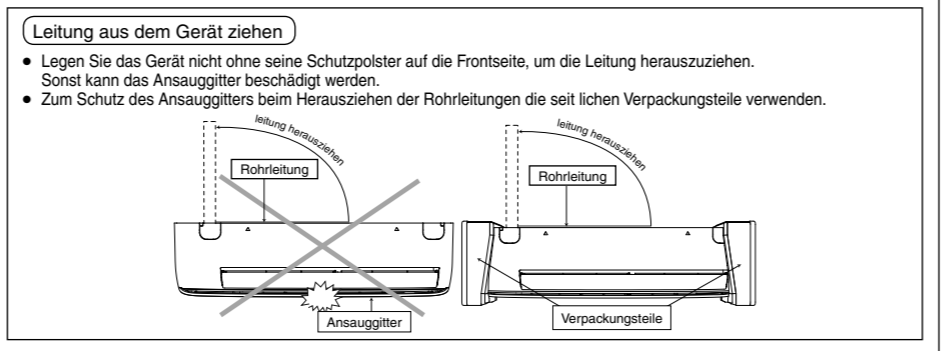

- 1. ROHRAUSTRITT RECHTS NACH HINTEN: Schritt 1: Leitung aus dem Gerät ziehen. Schritt 2: Innengerät anbringen. Schritt 3: Innengerät befestigen. Schritt 4: Stecken Sie das Netzkabel und das Verbindungskabel ein.

- 2. ROHRAUSTRITT RECHTS NACH UNTEN: Schritt 1: Leitung aus dem Gerät ziehen. Schritt 2: Innengerät anbringen. Schritt 3: Stecken Sie das Netzkabel und das Verbindungskabel ein.

- 3. ROHRLEITUNG IN ZWISCHENWAND: Schritt 1: Passen Sie die Position des Ablaufschlauchs an. Schritt 2: Rohrleitung biegen. Schritt 3: Verbindungskabel in das Innengerät ziehen.

- Schritt 4: Rohrleitung schneiden und bündeln. Schritt 5: Innengerät anbringen. Schritt 6: Anschließen der Rohrleitung. Schritt 7: Rohrleitung isolieren. Schritt 8: Innengerät befestigen.

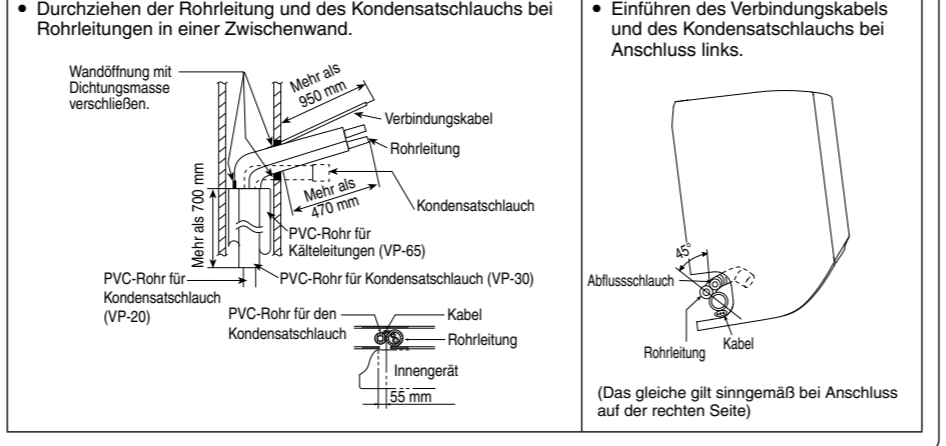
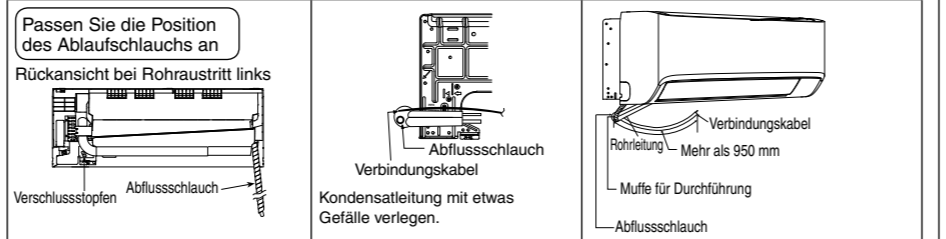
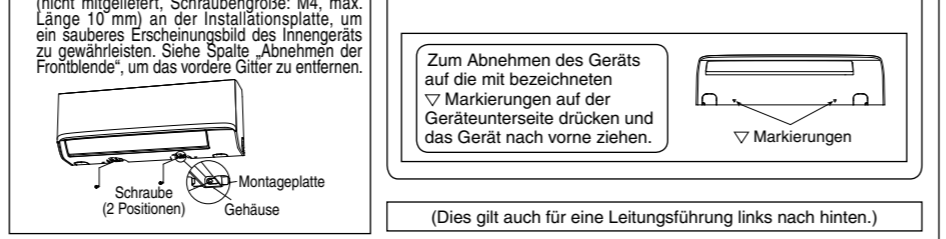
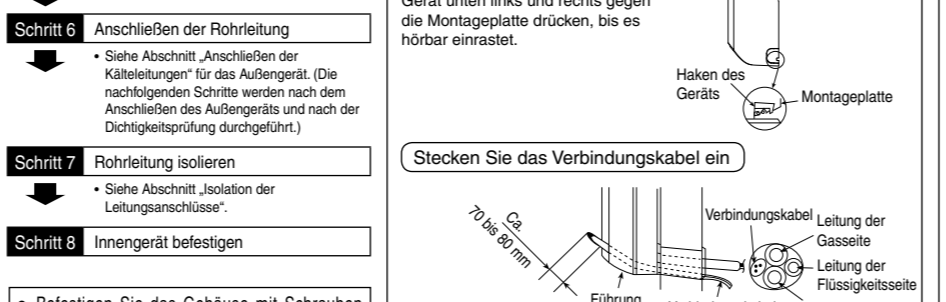

AUßENGERÄT

1 WAHL DES STANDORTS

2 INSTALLATION DES AUSSENERÄTS

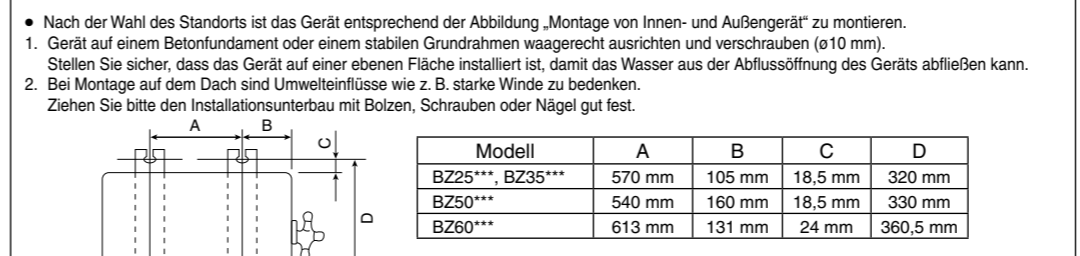

3 ANSCHLIESSEN DER ROHRLEITUNG

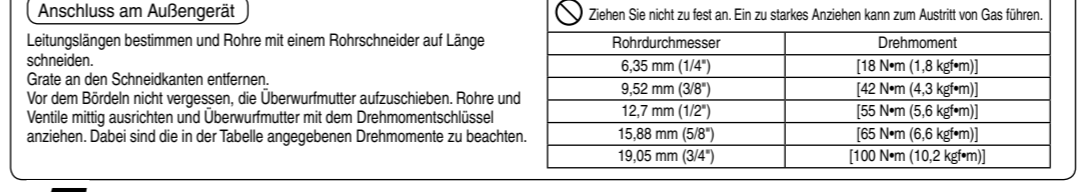
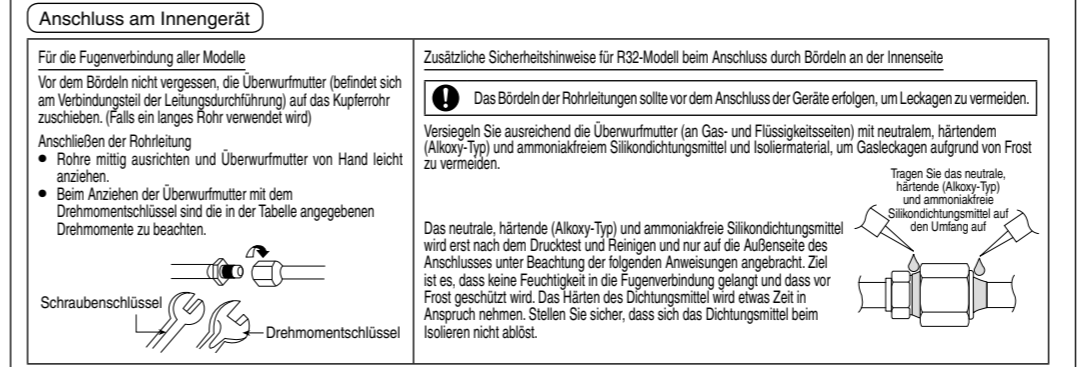

5 KABELANSCHLUSS AM AUSSENERÄT

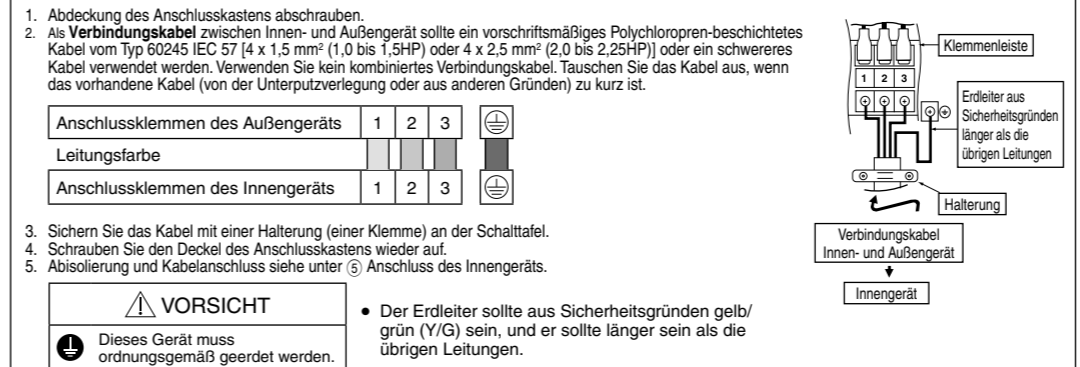

6 ROHRDÄMMSTOFF

SCHNEIDEN UND BÜNDELN DER ROHRE

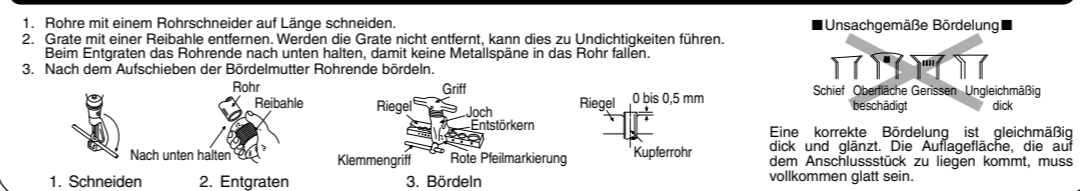

ABNEHMEN DER FRONTBLENDE

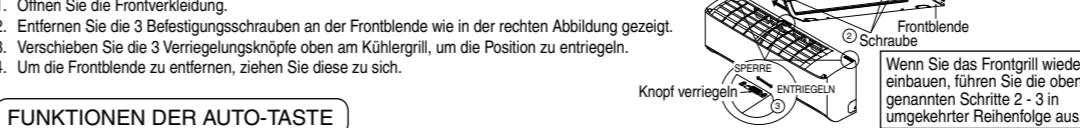

FUNKTIONEN DER AUTO-TASTE

- Durch Betätigung der „AUTO“-Taste sind folgende Funktionen verfügbar. 1. AUTOMATIKBETRIEB: Der Automatikbetrieb wird aktiviert, wenn die Auto-Taste innerhalb von 5 Sekunden gedrückt wird.

NUR-HEIZBETRIEB

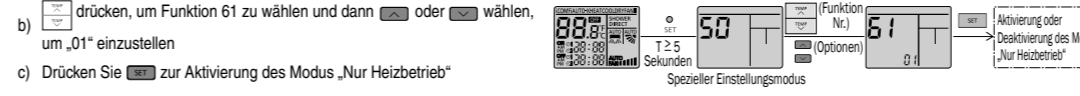

KONDENSATABLAUF DES AUSSENERÄTS

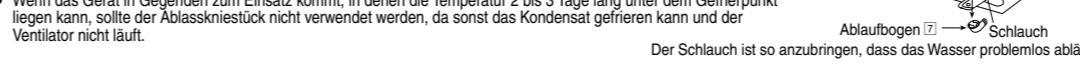

4 LUFTDICHTHEITSPRÜFUNG DES KÄLTESYSTEMS

- 1. Bereinigen Sie die Luft nicht mit Kältemitteln, sondern verwenden Sie zum Entlüften der Installation eine Vakuumpumpe. Es gibt kein zusätzliches Kältemittel in der Außeneinheit für die Luftpumpung.

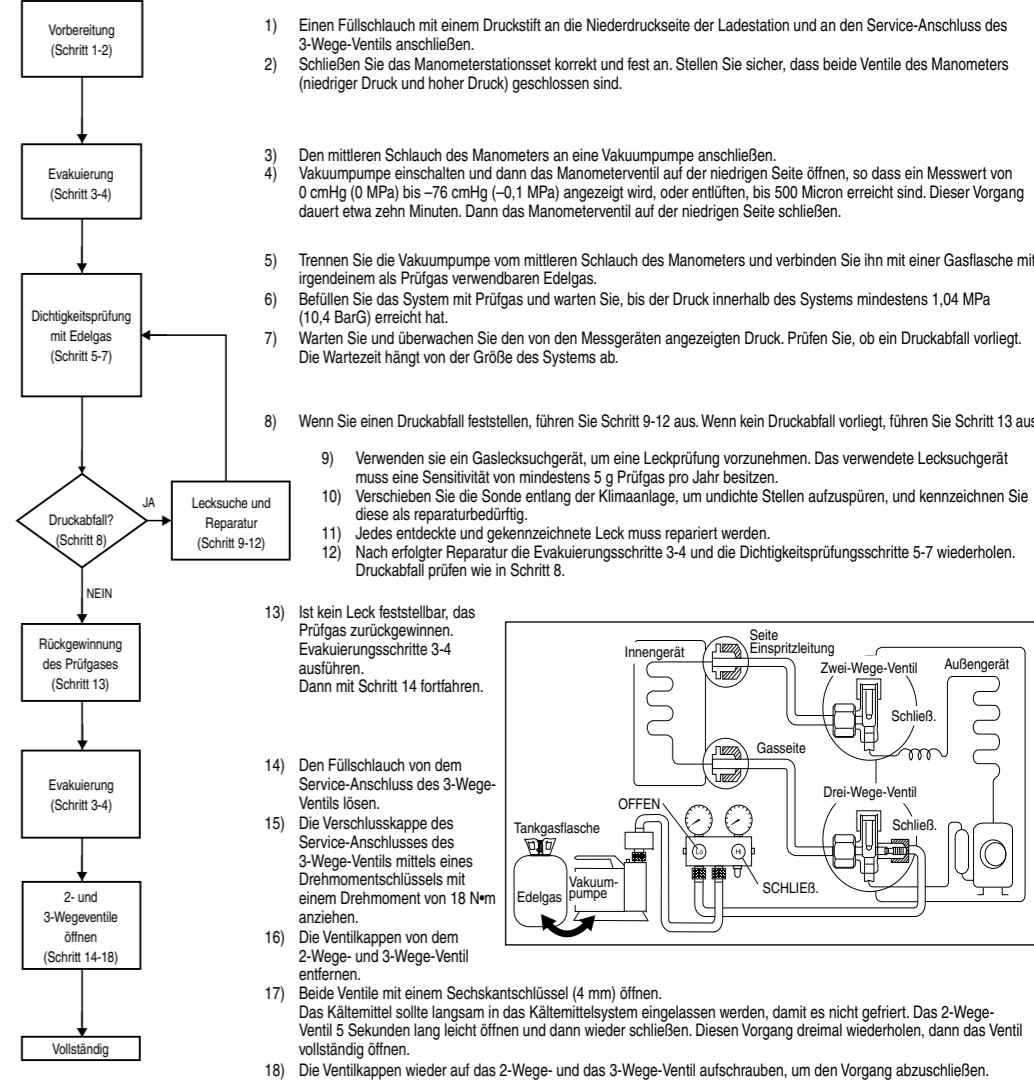

- Hinweise: Empfehlungen für die Verwendung eines der folgenden Lecksuchgeräte: I) Universeller Schnüffellecksucher II) Elektronischer Halogen-Lecksucher III) Ultraschall-Lecksucher

ÜBERPRÜFEN DES KONDENSATABLAUFS

- 1. Offnen Sie die Frontplatte, und nehmen Sie die Luftfilter heraus. 2. Betreiben Sie das Gerät 15 Minuten oder länger im Kühl- oder im Heizbetrieb.

INSTALLATION LUFTREINIGUNGSFILTER

- 1. Öffnen Sie die Frontverkleidung. 2. Nehmen Sie die Luftfilter heraus. 3. Positionieren Sie den Luftreinigungsfilter wie in der rechten Abbildung gezeigt.

BEI WIEDERVERWENDUNG EXISTIERENDER KÄLTEMITTELLEITUNGEN

- Beachten Sie bei der Entscheidung, vorhandene Kältemittelleitungen wiederzuverwenden Folgendes. Schlechte Kältemittelleitungen können zu Produktverschärfungen führen.

Korrekte Abbumpmethode

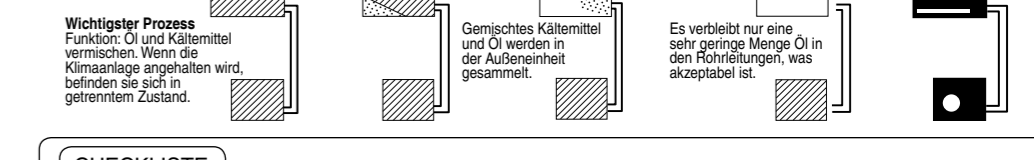

CHECKLISTE: Tritt an den Bördelverbindungen Kältemittel aus? Wurden die Bördelverbindungen isoliert? Wurde das Verbindungskabel richtig angeklemt? Wurde das Verbindungskabel ordentlich befestigt? Ist der Kondensatablauf in Ordnung? Ist die Erdung richtig vorgenommen worden? Ist das Innengerät richtig an der Montageplatte befestigt? Stimmt die Netzspannung mit der Nennspannung überein?

ΕΣΩΤΕΡΙΚΗ ΜΟΝΑΔΑ

1 ΕΠΙΛΟΓΗ ΤΗΣ ΚΑΛΥΤΕΡΗΣ ΘΕΣΗΣ ΤΟΠΟΘΕΤΗΣΗΣ (Ανατρέξτε στην παράγραφο "Επιλογή της καλύτερης θέσης τοποθέτησης")

2 ΤΡΟΠΟΣ ΣΤΕΡΕΩΣΗΣ ΤΗΣ ΠΛΑΚΑΣ ΕΓΚΑΤΑΣΤΑΣΗΣ

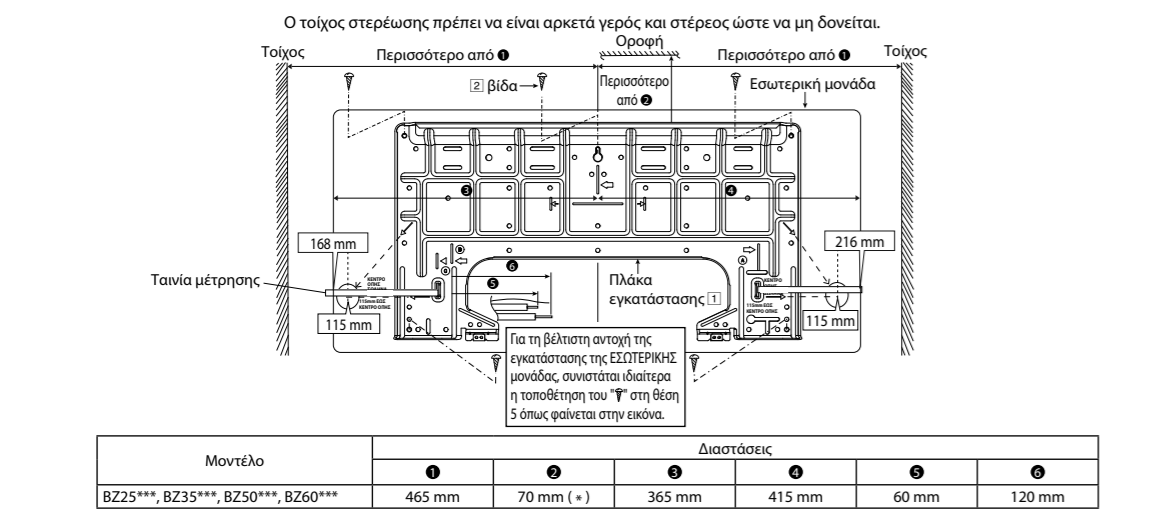

Μοντέλο	●	●	●	●	●
BZ25***, BZ35***, BZ50***, BZ60***	465 mm	70 mm (+)	365 mm	415 mm	60 mm

Το κέντρο της πλάκας εγκατάστασης πρέπει να απέχει δεξιά και αριστερά περισσότερο από 1 από τον τοίχο. Η απόσταση από την άκρη της πλάκας εγκατάστασης έως την αριστερή πρίζα να είναι περισσότερο από 2. Από το κέντρο της πλάκας εγκατάστασης ως την αριστερή πλευρά της μονάδας είναι 3. Από το κέντρο της πλάκας εγκατάστασης ως τη δεξιά πλευρά της μονάδας είναι 4. Σε περίπτωση που πρέπει να χρησιμοποιηθεί η βάση στήριξης στον τοίχο με 5 βίδες ή περισσότερο τουλάχιστον 5 βίδες. (Ανατρέξτε στη στήλη "4 Εγκατάσταση εξωτερικής μονάδας") για τη στερέωση της μονάδας, η απόσταση αυτή πρέπει να είναι τουλάχιστον 85 mm.

Μια άλλη μέθοδος είναι τοποθέτηση ταινία μέτρησης σε θέση όπως δείχνεται στο αντίκρυ διάγραμμα. Το κέντρο της στήλης λαμβάνεται μετράμενος την απόσταση 115 mm για την αριστερή και τη δεξιά από αντίστοιχα. Κάντε την τρύπα για τη σωλήνωση είτε στα δεξιά είτε στα αριστερά. Η τρύπα θα πρέπει να γίνει αμέσως προς την εξωτερική πλευρά.

3 ΑΝΟΙΓΜΑ ΟΠΗΣ ΣΤΟΝ ΤΟΙΧΟ ΚΑΙ ΤΟΠΟΘΕΤΗΣΗ ΧΙΤΩΝΙΟΥ ΣΩΛΗΝΩΣΗΣ

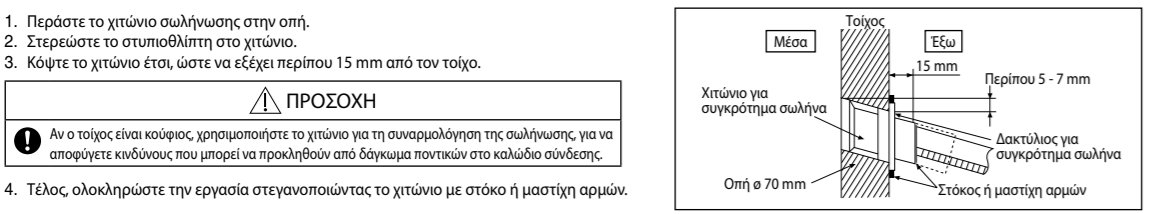

5 ΣΥΝΔΕΣΗ ΤΟΥ ΚΑΛΩΔΙΟΥ ΣΤΗΝ ΕΣΩΤΕΡΙΚΗ ΜΟΝΑΔΑ

- Εγκαταστήστε την εσωτερική μονάδα στη βάση στήριξης που είναι στερεωμένη στον τοίχο.
- Ανοίξτε τον μπροστινό πίνακα και τη θύρα της γρίλιας βιδώνοντας τη βίδα.
- Συνδέστε καλώδιο στην προφοδία ρεύματος μέσω συσκευής αποσύνδεσης (Διάταξη αποσύνδεσης).
 - Συνδέστε το εγκατεμένο, επαυξημένο με πολυκλωροπρένιο **καλώδιο παροχής ρεύματος** 3 x 1,5 mm² (1,0 - 1,5HP) ή 3 x 2,5 mm² (2,0 - 2,25HP) προδιαγραφών τύπου 60245 IEC 57 ή βαρέστερο καλώδιο στον πίνακα ακροδεκτών, και συνδέστε το άλλο άκρο του καλωδίου στις διατάξεις αποσύνδεσης (Διατάξεις αποσύνδεσης).
 - Μη χρησιμοποιείτε ενωμένο καλώδιο παροχής ρεύματος. Αντικαταστήστε το καλώδιο αν το υπάρχουν καλώδια (από κρηφή καλωδίου ή άλλα) είναι πολύ κοντά.
 - Σε περίπτωση που δεν μπορεί να αποφευχθεί η ένωση του καλωδίου παροχής ρεύματος μεταξύ των διατάξεων αποσύνδεσης και του πίνακα ακροδεκτών του κλιματιστικού γίνεται χρησιμοποιώντας εγκατεμμένη πρίζα και βύσμα κατηγορίας 15/16 A (1,0 - 1,5HP) ή 16 A (2,0 - 2,25HP). Οι εργασίες καλωδίωσης στην πρίζα και το βύσμα πρέπει να συμπληρώνονται με το εθνικό πρότυπο καλωδίωσης.
- Δεξιά όλα τα αγινάκια **καλώδιο παροχής ρεύματος** με ταινία ασφαλείας διαχωριστικής.
- Το **καλώδιο σύνδεσης** μεταξύ της εσωτερικής και της εξωτερικής μονάδας πρέπει να είναι εγκατεμένο εύκαμπτο καλώδιο με εξωτερική μόνωση από πολυκλωροπρένιο και διατομή 4 x 1,5 mm² (1,0 - 1,5HP) ή 4 x 2,5 mm² (2,0 - 2,25HP) ονομασίας τύπου 60245 IEC 57 ή ανώτερης κατηγορίας.
- Δεξιά όλα τα εσωτερικά και εξωτερικά **καλώδια σύνδεσης** με ταινία και δρομολογημένα το καλώδιο σύνδεσης μέσω της δεξιάς διαδρομής.
- Αφαιρέστε τις ταινίες και συνδέστε το καλώδιο παροχής ρεύματος και το καλώδιο σύνδεσης ανάμεσα στην εσωτερική μονάδα και την εξωτερική μονάδα σύμφωνα με το κατωτέρω διάγραμμα.

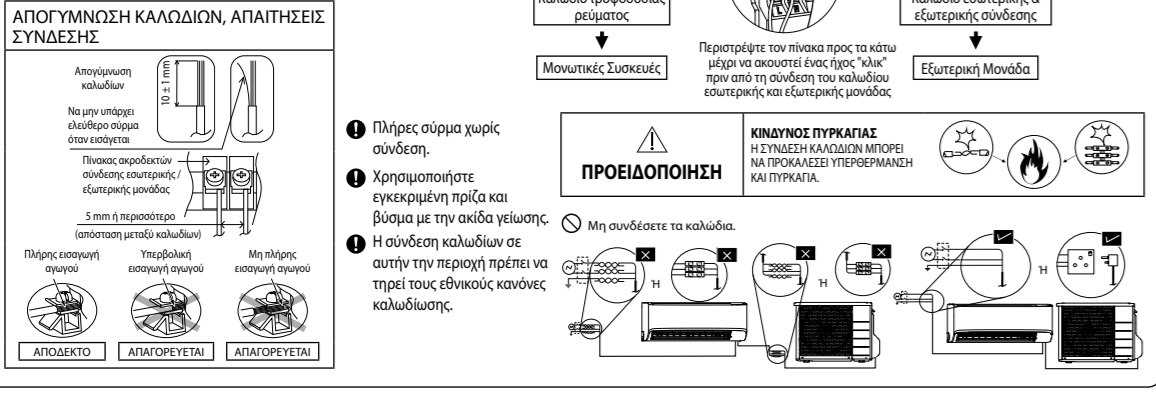
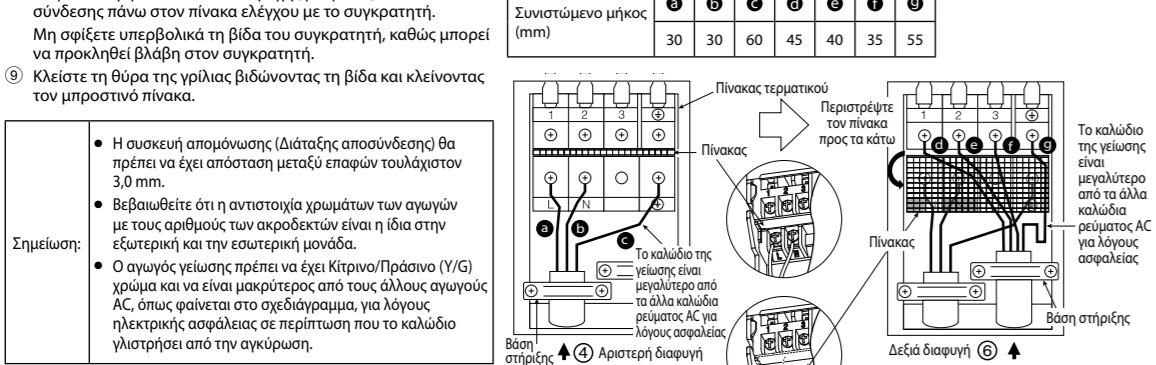
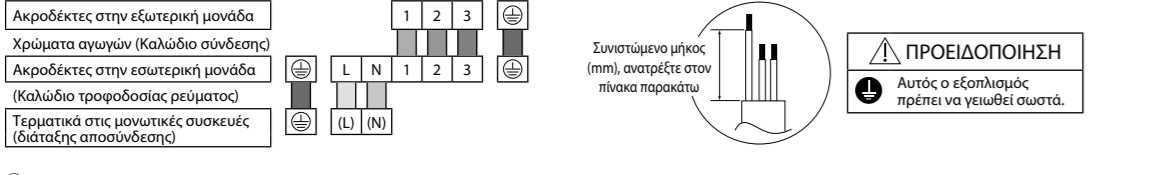

4 ΕΓΚΑΤΑΣΤΑΣΗ ΕΣΩΤΕΡΙΚΗΣ ΜΟΝΑΔΑΣ

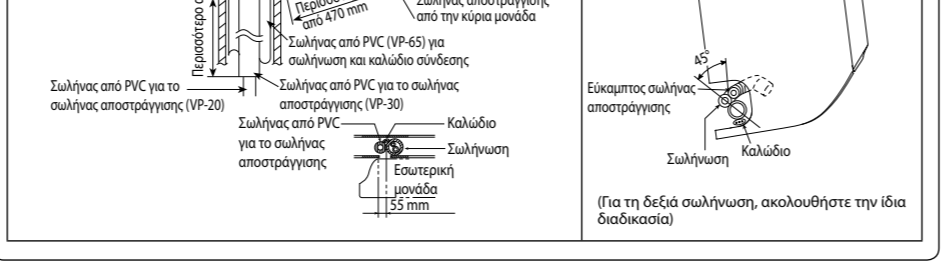
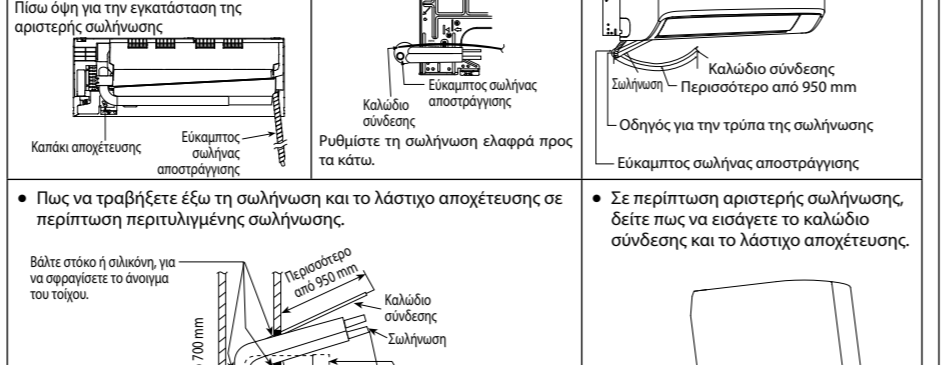
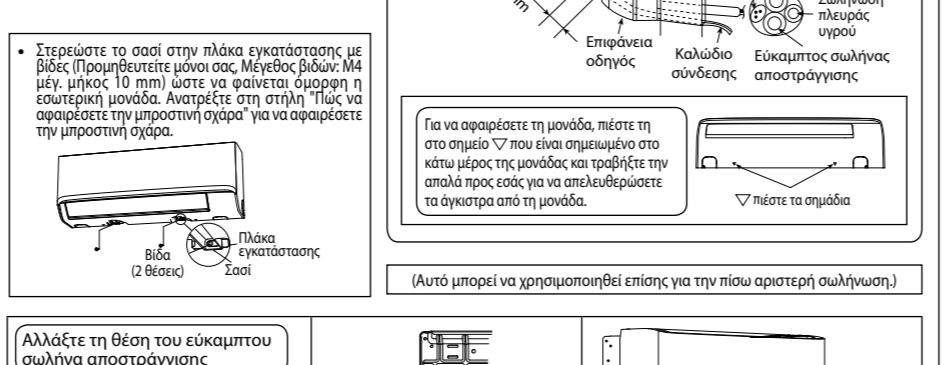
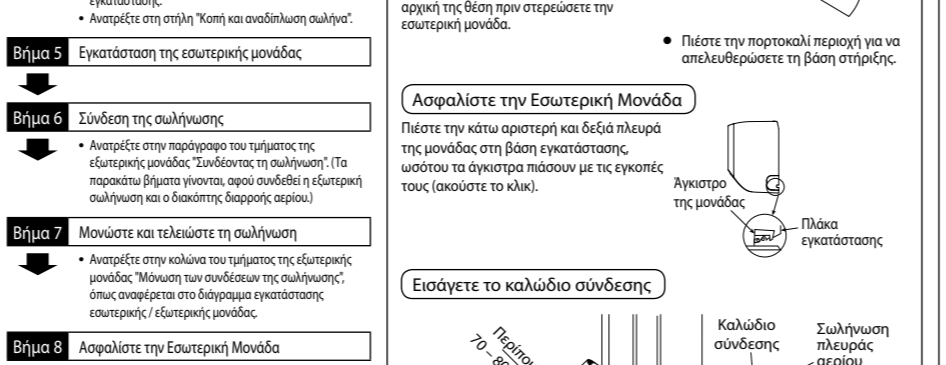
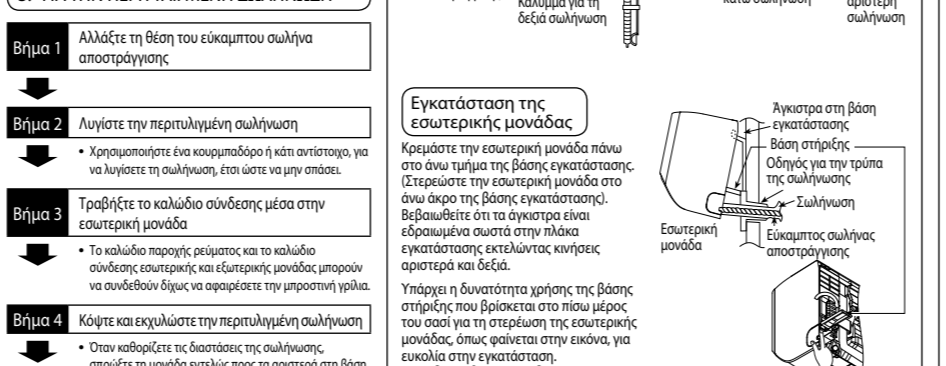
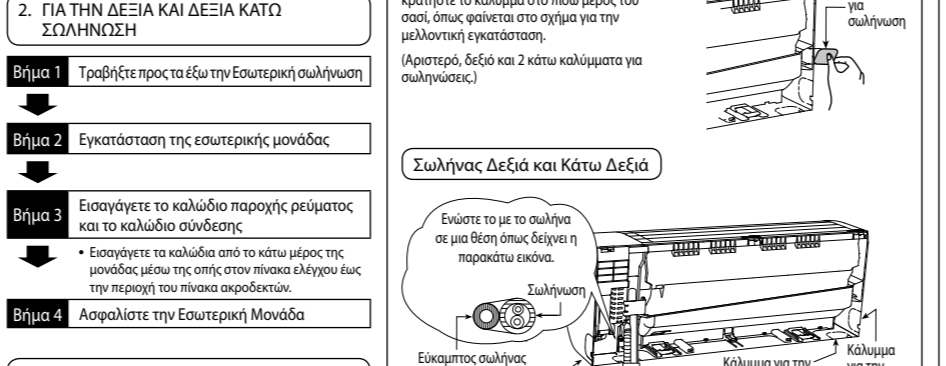
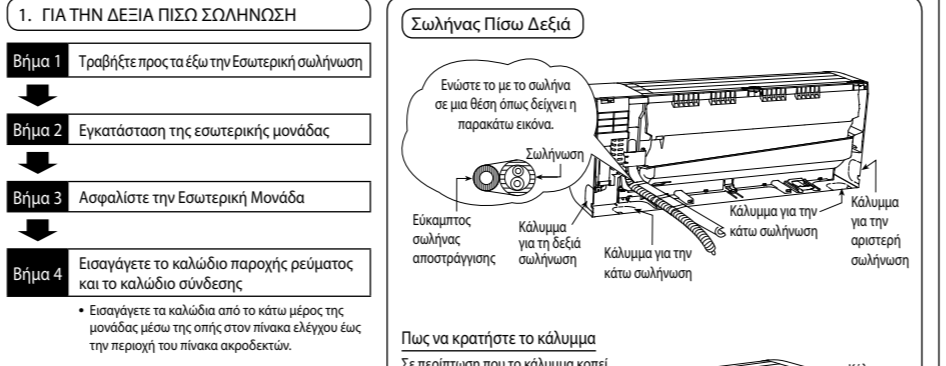
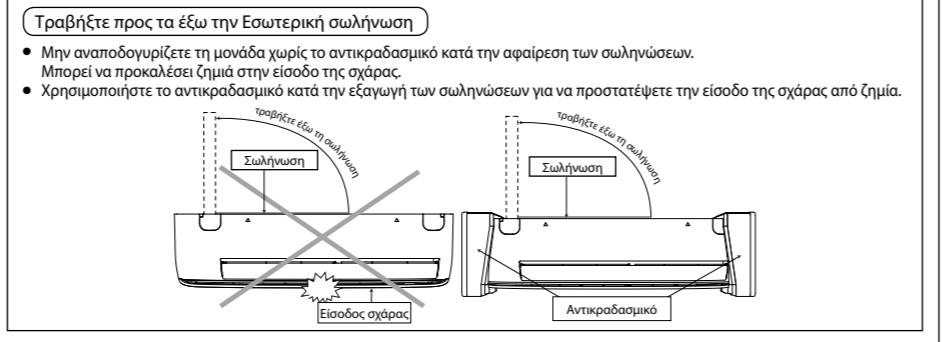

ΕΞΩΤΕΡΙΚΗ ΜΟΝΑΔΑ

1 ΕΠΙΛΟΓΗ ΤΗΣ ΚΑΛΥΤΕΡΗΣ ΘΕΣΗΣ ΤΟΠΟΘΕΤΗΣΗΣ (Ανατρέξτε στην παράγραφο "Επιλογή της καλύτερης θέσης τοποθέτησης")

2 ΕΓΚΑΤΑΣΤΑΣΗ ΤΗΣ ΕΞΩΤΕΡΙΚΗΣ ΜΟΝΑΔΑΣ

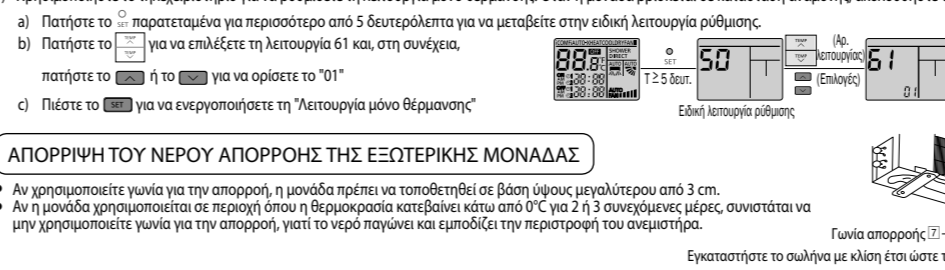
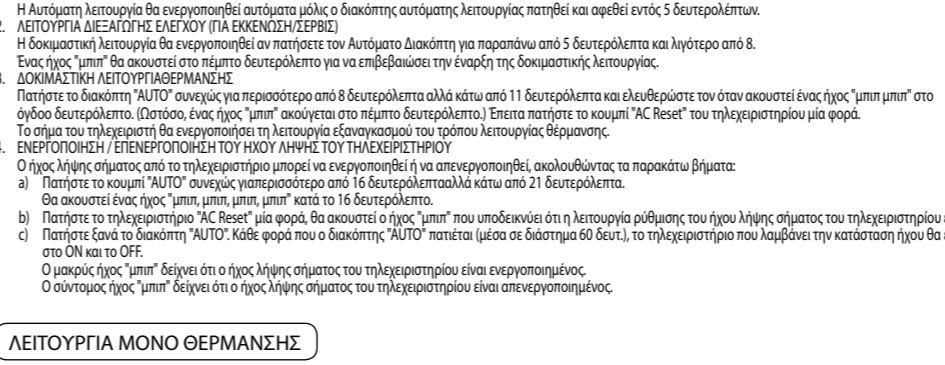
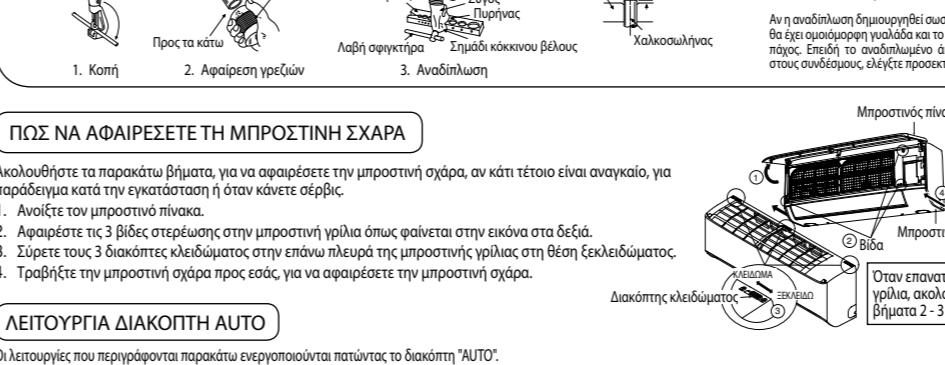
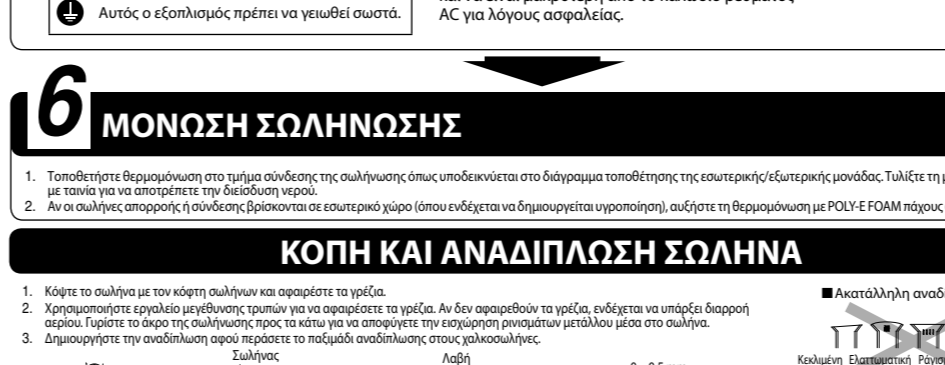
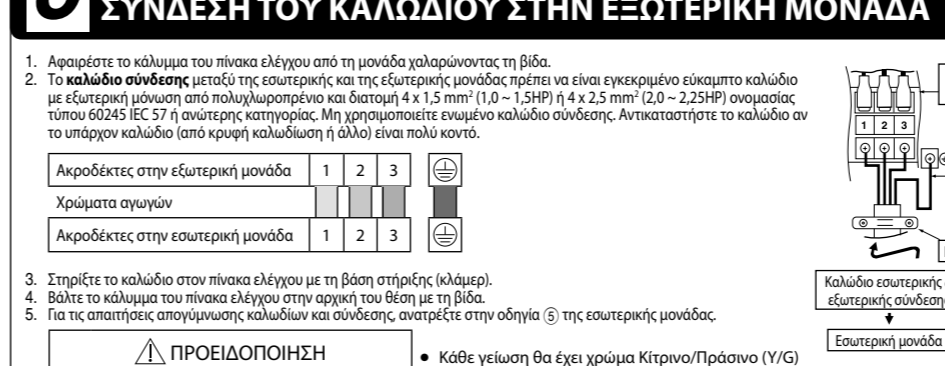
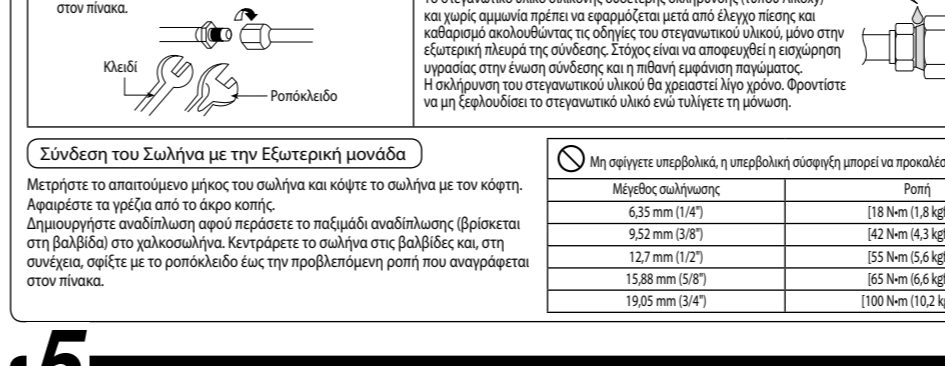
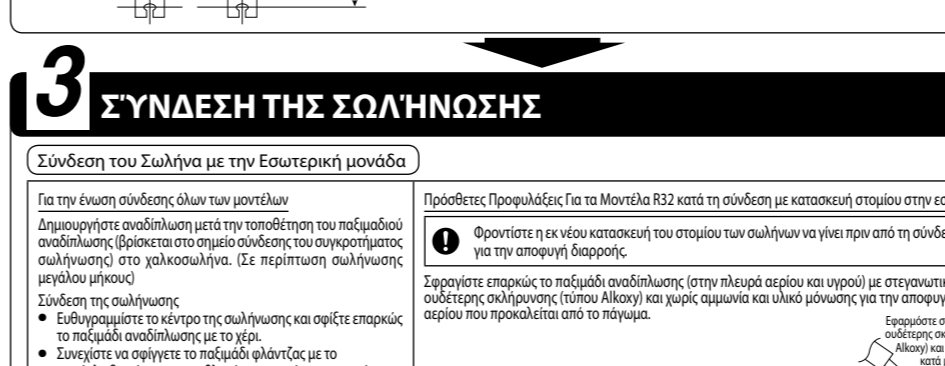
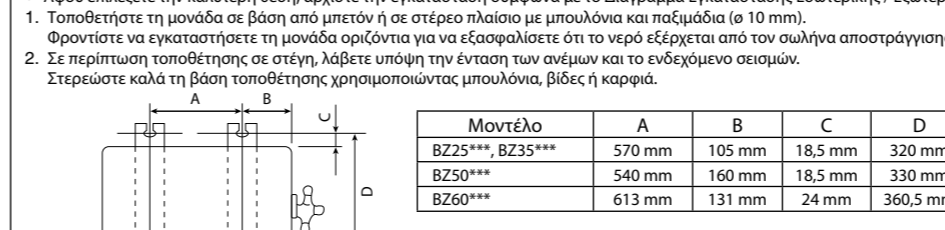

4 ΕΛΕΓΧΟΣ ΑΕΡΟΣΤΕΓΑΝΟΤΗΤΑΣ ΣΤΟ ΣΥΣΤΗΜΑ ΨΥΞΗΣ

