

Service Manual

This Service Manual is written for the after sale service department, especially for the fix and maintenance workers.

Energy Recovery Ventilator (sold in Europe market)

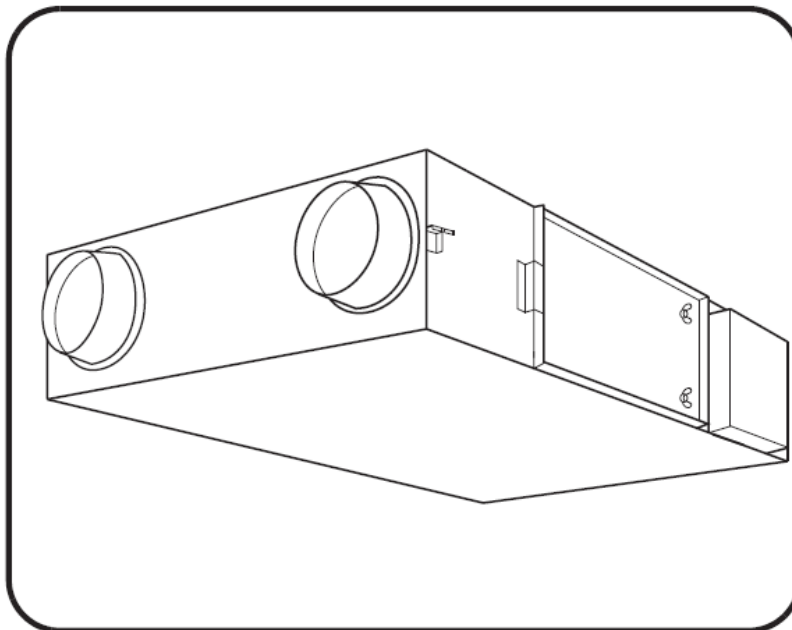

Model No.

FY-250ZDY8

FY-650ZDY8

FY-350ZDY8

FY-800ZDY8

FY-500ZDY8

FY-01KZDY8A

Panasonic Ecology Systems Guangdong Co., Ltd.



Cautions on Safety

This appliance is not intended for use by persons (including children) with reduced physical, sensory or mental capabilities, or lack of experience and knowledge, unless they have been given supervision or instruction concerning use of the appliance by a person responsible for their safety.



Children should be supervised to ensure that they do not play with the appliance.

Described below are the way we are gaining your attention to what you are supposed to observe to prevent dangers to the users or other people as well as loss to the property.









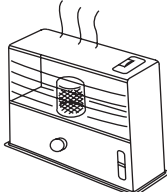

- The degrees of danger or damage that is likely to occur due to the wrong use ignoring the indications are categorized for explanation as marked below.

 DANGEROUS	The column with this mark shows "Impending Danger of Death or Serious Injury".
 WARNING	The column with this mark shows "Conceivable Threat of Death or Serious Injury".
 CAUTION	The column with this mark shows "Likelihood of Damage or Loss to Materials only".

- Kinds of the items to be observed are categorized for clarification with the following pictorial symbols. (The marks described below are samples.)

	This pictorial indication shows "Prohibited".
	This pictorial indication shows "Forced Execution".













Cautions for Operation

<p> DANGEROUS</p> <ul style="list-style-type: none"> ■ Do not use as an air circulators for open-type burners (heaters). <p> Prohibited</p>  <p>When gas or oil stoves are used in the home, separate equipment for circulating the air should be used.</p> <ul style="list-style-type: none"> ■ When any abnormal condition (scorching smell or others) is found, stop the operation immediately and switch the exclusive circuit breaker "OFF". <p> </p> <p>If you continue the operation without removing the cause, it could cause an electric shock or a fire.</p> <ul style="list-style-type: none"> ● When the system needs a repair, consult your dealer. 	<p> WARNING</p> <ul style="list-style-type: none"> ■ Don't push a finger or a stick into the air inlet or the outlet. <p> Prohibited</p> <p>A fan with a high rpm will injure you.</p> <ul style="list-style-type: none"> ■ Modification of the system is strictly prohibited. <p> Disassembly Prohibited</p> <p>Improper practice of repair could cause a water leakage, an electric shock or a fire.</p> <ul style="list-style-type: none"> ● When the system needs a repair, consult your dealer. 	<ul style="list-style-type: none"> ■ If there is a combustible gas leakage from other appliances, ventilate the room by opening windows. <p></p> <p>If operation were to be attempted in such a situation, sparking at electrical contact points could cause an explosion.</p> <ul style="list-style-type: none"> ■ Netting or something similar should be provided at the external air intake opening to prevent birds etc. interfering with the unit. <p></p> <p>Nests or other foreign objects should be removed. That could lead to a lack of oxygen in the room.</p> <ul style="list-style-type: none"> ■ If the supply cord is damaged, it must be replaced by the manufacturer or its service agent or a similarly qualified person in order to avoid a hazard. <p></p>
--	---	--



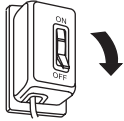

Cautions on Safety

Cautions for Operation

CAUTION

<p>■ It is strictly prohibited to place a container of combustible gas or liquid near Energy Recovery Ventilators or to spray it directly with the gas or liquid.</p> <p style="text-align: center;">It could cause a fire.</p> <div style="text-align: center;">  <p>Prohibited</p> </div>	<p>■ Combustion apparatus should not be placed allowing a direct exposure to wind of Energy Recovery Ventilators.</p> <p style="text-align: center;">Incomplete combustion could occur on the apparatus.</p> <div style="text-align: center;">  <p>Prohibited</p> </div>	<p>■ Do not wash Energy Recovery Ventilators with water.</p> <p style="text-align: center;">It could cause an electric shock.</p> <div style="text-align: center;">  <p>Keep from water</p> </div>
<p>■ Do not use outside the rated voltage.</p> <p style="text-align: center;">It could cause a fire or an electric shock.</p> <div style="text-align: center;">  <p>Prohibited</p> </div>	<p>■ Don't blow directly towards animals or plants.</p> <p style="text-align: center;">Likely to cause bad effect on animals and plants.</p> <div style="text-align: center;">  <p>Prohibited</p>  </div>	<p>■ Do not handle switches with a wet hand.</p> <p style="text-align: center;">It could cause an electric shock.</p> <div style="text-align: center;">  <p>Don't touch with wet hands</p> </div>
<p>■ This appliance can be used by children aged from 8 years and above and persons with reduced physical, sensory or mental capabilities or lack of experience and knowledge if they have been given supervision or instruction concerning use of the appliance in a safe way and understand the hazards involved.</p> <div style="text-align: center;">  </div>	<p>■ Don't put a container of water on Energy Recovery Ventilators.</p> <p style="text-align: center;">When water spills, it is likely to enter inside the unit and degrade electric insulation, possibly resulting in an electric shock.</p> <div style="text-align: center;">  <p>Prohibited</p> </div>	<p>■ If Energy Recovery Ventilators are not used for a long period of time, switch the exclusive circuit breaker "OFF" for safety reasons.</p> <p style="text-align: center;">If the power is left on, any build-up of dust could cause a heat generation or a fire.</p> <div style="text-align: center;">   </div>
<p>■ Children shall not play with the appliance. Cleaning and user maintenance shall not be made by children without supervision.</p> <div style="text-align: center;">  </div>		

Cautions for Installation

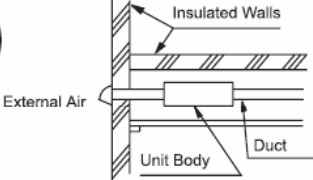
<p>■ The system should never be used for any other purposes than intended such as for preservation of foods, flora and fauna, precision devices or work of art.</p> <div style="text-align: center;">   </div> <p>● It could cause deterioration of foods or other problems.</p>	<p>■ Don't incline Energy Recovery Ventilators when removing the unit.</p> <p style="text-align: center;">Otherwise, water remaining inside is likely to drop and wet the furniture or other property.</p> <div style="text-align: center;">  <p>Prohibited</p> </div> <p>● Ask the sales office or the engineering shop to perform the work.</p>
<p>■ Install at a stable place of sufficient strength.</p> <p>Please note that there might be some places not strong enough to install due the structure of building.</p> <p>■ Do not install in locations where harmful or corrosive gasses may be present (i.e. acidic, alkali, organic solvent, paint gasses etc. from machinery or factories)</p> <p style="text-align: center;">Installation in such a location could cause a gas-poisoning and a fire.</p> <div style="text-align: center;">  <p>Prohibited</p> </div>	<p>■ Never fail to install the unit inside the heat insulating walls or, in other words, in the space insulated from the open air.</p> <div style="text-align: center;">   </div>

Specific Caution Items

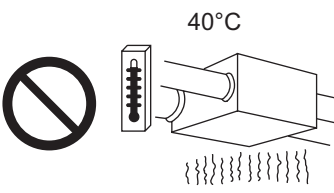
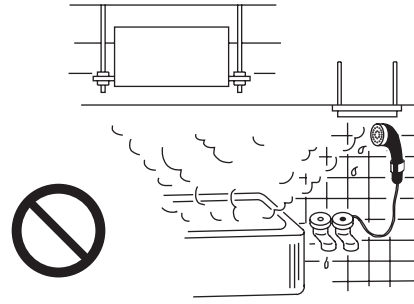
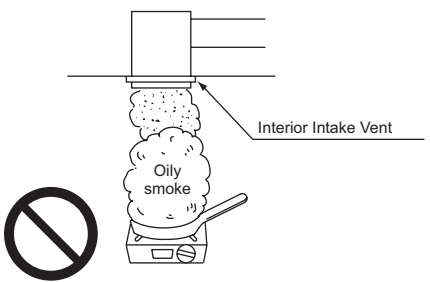

Checking Location of Installation

This Energy Recovery Ventilators have been designed especially for use in offices, conference rooms, etc. Please check to ensure that neither the main unit nor the inlet-outlet grill are installed in any of the following locations.

<p>Locations exposed to high temperatures or direct flame. Avoid installing the Energy Recovery Ventilators or the inlet-outlet grill in locations which reach temperatures of 40°C or above. Usage under high temperature conditions may cause distortion of the filter or Heat Exchange Element or motor burn-out.</p> 	<p>Locations with high humidity. Do not install in high humidity locations such as bathrooms. Doing so may cause a breakdown of the unit or an electric shock.</p> 	<p>Locations with large amounts of oily smoke, such as food preparation areas. The unit will become inoperable if the filter or Heat Exchange Element become clogged with oil.</p> 
<p>Make sure that Inspection Opening is provided so that filter and Heat Exchange Element maintenance and periodic spot checks of the unit can be easily carried out. (Refer to the Model Installation for its space)</p>	<p>Do not install the unit in locations such as machinery or chemical plants where it will be exposed to noxious gases containing acids, alkali, organic solvents, paint fumes, etc., to gases containing corrosive ingredients, or where dust or oil mist will be produced.</p>	

If there are any problems concerning the location or installation of the unit, please consult either store from which it was purchased or the agent who installed it.

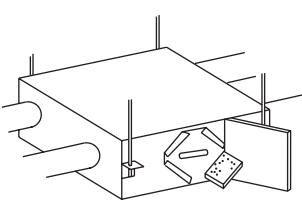
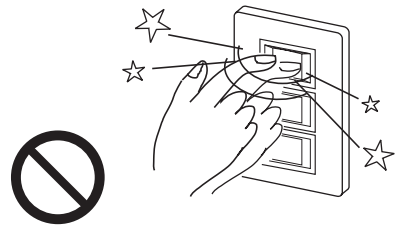



When Using

<p>Always be sure to use a filter. Failure to do so may cause dust and dirt to build up on the heat exchange element, lowering its efficiency and rendering it inoperable.</p> 	<p>Operate the switch with certainty. In particular, suddenly turning the switch on and off will not only cause improper operation of the unit, but will also affect the relay inside the switch, and may damage it.</p> 	<p>Never operate the on "Normal ventilation" during the winter when the room is being heated, as this will cause condensation to form inside the unit and in the inlet-outlet vent.</p> 
--	--	---

Cautions on Safety

Cautions for Maintenance

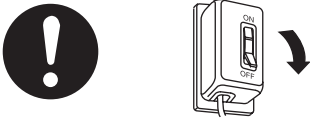
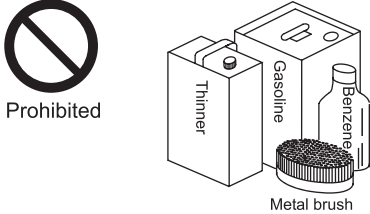
It must be replaced by the manufacturer, its service agent or similarly qualified persons in order to avoid a hazard.

 WARNING	 CAUTION	
<p>■ When the system is checked and the power cable undergoes maintenance, stop the operation, and switch the exclusive circuit breaker "OFF".</p>  <p>The internal fan is revolving at high speeds and can cause serious injury. And when using a stepladder, etc., make sure to fix it properly.</p>	<p>■ Don't use benzene or metal brush when cleaning the filter and heat exchange element.</p> <p>Prohibited</p>  <p>Otherwise, the unit will get unfit for use.</p>	<p>■ The filter should be cleaned regularly.</p>  <p>Dust or dirt building-up on it can lead to a lack of oxygen in the room.</p> <p>■ Use gloves when cleaning the filter or heat exchange element.</p>  <p>Doing so will reduce any possibility of injury.</p>

Model Installation

In order to prevent the reduced effectiveness of your Energy Recovery Ventilator, be sure to clean dirt and dust from the filter and Heat Exchange Element at regular intervals.

Caution

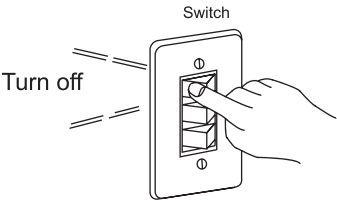
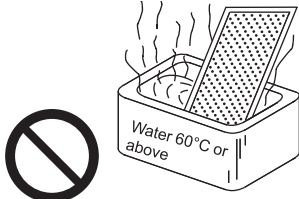
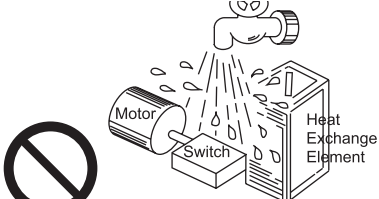
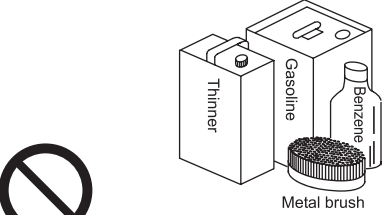
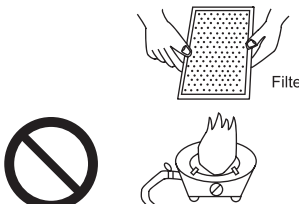
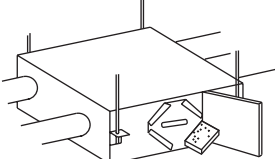

<p>Be sure to turn the power off, and to switch the exclusive breaker off before carrying out maintenance activities.</p> 	<p>Do not immerse the filter or other resin components in water 60°C or above.</p> 	<p>Never use water on the motor, the switch, or the Heat Exchange Element.</p> 
<p>Do not use the following items for cleaning.</p> 	<p>Avoid using heat to dry the filter, as it may cause changes in shape or quality.</p> 	<p>Always be sure to use a filter. Failure to do so may cause dust and dirt to build up on the heat exchange element, lowering its efficiency and rendering it inoperable.</p> 



Cautions on Safety

- Read through this "Cautions on Safety" with care before installing the unit.
- Described below are the way we are stimulating your attention to what you are supposed to observe to prevent dangers to the users or other people as well as loss to the property.





Never fail to observe the caution items described hereinafter because all of them refer to the critical matters on safety. The meanings of the marks or indications are described below.

- The degrees of danger or damage that is likely to occur due to the wrong use ignoring the indications are categorized for explanation as marked below.
- Kinds of the items to be observed are categorized for clarification with the following pictorial symbols.



	WARNING	The column with this mark shows "Conceivable Threat of Death or Serious Injury".
	CAUTION	The column with this mark shows "Likelihood of Damage or Loss to Materials only".

	This pictorial indication shows "Prohibited".
	This pictorial indication shows "Forced Execution".

WARNING

	Never fail to ask the sales office from which you bought the unit or the installation service shop to install the unit. If you install it by yourself, any inappropriate installation works would cause an electric shock or a fire.		The external air intake opening should be positioned away from the exhaust openings of combustion gases etc. The intake of such gases could cause a lack of oxygen in the room. The external air intake opening should not be positioned where discharged air may directly enter it. A situation like this will lead to the room being contaminated and this may pose a health risk.
	Carry out the installation works accurately in line with this installation work manual. Improper practice of installation could cause an electric shocks or a fire.		Netting or something similar should be provided at the external air intake opening to prevent birds etc. interfering with the unit. Nests or other foreign objects should be removed. That could cause a lack of oxygen in the room.
	Choose the installation place where is enduring in quality as well as in weight, then install the unit accurately with adequate strength and completeness of installation in accordance with the installation work manual. Otherwise, it is likely to cause an electric shock, a fire, a drop of the unit, thus causing the injury on the human body.		Carry out the ground work. Never connect the ground wire to a gas pipe, a water supply pipe, a lightning conductor, a ground line of a telephone, etc. An incomplete ground wire is likely to cause an electric shock.
	Carry out electrical work in accordance with the laws and regulations prevailing in the country concerned, technical standard and explanation for work, and make absolutely sure that an exclusive circuit is used. Any insufficient capacity of power circuit and improper work can result in electric shock and fire hazard.		When the system is checked and the power cable undergoes maintenance, stop the operation, and switch the exclusive circuit breaker "OFF". Otherwise, it could cause an electric shock.

CAUTION

	Provide an exclusive circuit breaker that can completely break contacts on all the poles by more than 3mm through direct connection to the power terminals. Depending upon the environment for installation, it becomes necessary to install an earth leakage breaker.		Install the power line and the connecting line with accuracy so the power source cover may not float. If the installation of the power source cover is inappropriate, the pin connection area is likely to cause a heat generation, a fire and an electric shock due to dust or powder.	
	When you want to pierce the metal duct through the metal lath or the wire lath or the metal plate of the wooden facility, do not forget to insulate electrically between the duct and the wall. Otherwise, it would cause an electric shock or an electric leakage.			Never install the unit near the place where there is a fear of leakage of an inflammable gas. If gas happens to leak and stays around the unit, it is likely to cause a fire.
	Don't use other parts than specified (including the auxiliary parts) for installation works. If you do not use the specified parts, it is likely to cause a drop of the unit, a fire, an electric shock, etc.			Don't use the unit at the other voltages than the rated one. It could cause a fire or an electric shock.
	Install the outdoor duct in a falling gradient toward the outside so as to prevent water from coming in. If it is not installed so, the building is likely to be flooded, wetting the household effects.			Do not install the unit in locations with large amounts of oily smoke, such as food preparation areas. It could cause a fire.
	Heat-insulate the outdoor duct (including the indoor side, if necessary) to prevent dewing. If heat insulation is not adequate, water likely goes indoor and wets the household properties.			Don't install the unit at the place of a high temperature or a flame. It could cause a heat generation or a fire.
	When it is high humid and high temperature inside the ceiling, a ventilation system must be installed inside the ceiling. Otherwise, it could cause a fire or an electric leakage.			Do not install in locations where harmful or corrosive gasses may be present (i.e. acidic, alkali, organic solvent, paint gasses etc. from machinery or factories). Installation in such a location could cause a gas-poisoning and a fire.
Connect the power line and the connecting line with accuracy using the specified cables and fix them firmly so as not to put the outer stress of the cables on the pin connecting area. Incomplete connection or fixing is likely to cause a heat generation or a fire.	Do not install in locations with high humidity, such as close to bathroom etc. It could cause an electric shock or an electric leakage etc.			

Specifications

Model No.	FY-250ZDY8					
Item						
Power Source	220-240V~ 50Hz					
Ventilation Mode	Heat Exchange Ventilation			Normal Ventilation		
Notch	(Extra high)	High	Low	(Extra high)	High	Low
Input (W)	112-128	108-123	87-96	112-128	108-123	87-96
Air Volume (m³/h)	250	250	190	250	250	190
External Static Pressure (Pa)	105	95	45	105	95	45
Noise (dB)	30.0-31.5	29.5-30.5	23.5-26.5	30.0-31.5	29.5-30.5	23.5-26.5
Temperature Exchange Efficiency(%)	75	75	77	—	—	—
Dimensions(mm)	Width 882 ×Depth 599×Height 270					
Weight (kg)	29					

Model No.	FY-350ZDY8					
Item						
Power Source	220-240V~ 50Hz					
Ventilation Mode	Heat Exchange Ventilation			Normal Ventilation		
Notch	(Extra high)	High	Low	(Extra high)	High	Low
Input (W)	182-190	178-185	175-168	182-190	178-185	175-168
Air Volume (m³/h)	350	350	240	350	350	240
External Static Pressure (Pa)	140	60	45	140	60	45
Noise (dB)	32.5-33.0	30.5-31.0	22.5-25.5	32.5-33.0	30.5-31.0	22.5-25.5
Temperature Exchange Efficiency(%)	75	75	78	—	—	—
Dimensions(mm)	Width 1050 ×Depth 804×Height 317					
Weight (kg)	49					

Model No.	FY-500ZDY8					
Item						
Power Source	220-240V~ 50Hz					
Ventilation Mode	Heat Exchange Ventilation			Normal Ventilation		
Notch	(Extra high)	High	Low	(Extra high)	High	Low
Input (W)	263-289	204-225	165-185	263-289	204-225	165-185
Air Volume (m³/h)	500	500	440	500	500	440
External Static Pressure (Pa)	120	60	35	120	60	35
Noise (dB)	36.5-37.5	34.5-35.5	31.0-32.5	37.5-38.5	37.0-38.0	31.0-32.5
Temperature Exchange Efficiency(%)	75	75	76	—	—	—
Dimensions(mm)	Width 1090 ×Depth 904×Height 317					
Weight (kg)	57					

Specifications

Item	Model No. FY-650ZDY8					
Power Source	220-240V~ 50Hz					
Ventilation Mode	Heat Exchange Ventilation			Normal Ventilation		
Notch	(Extra high)	High	Low	(Extra high)	High	Low
Input (W)	326-347	269-295	200-210	326-347	269-295	200-210
Air Volume (m ³ /h)	650	650	460	650	650	460
External Static Pressure (Pa)	65	40	40	65	40	40
Noise (dB)	36.5-37.5	34.5-35.5	30.0-32.0	36.5-37.5	35.0-35.5	30.0-32.0
Temperature Exchange Efficiency(%)	75	75	79	—	—	—
Dimensions(mm)	Width 1204 ×Depth 884×Height 388					
Weight (kg)	68					

Item	Model No. FY-800ZDY8					
Power Source	220-240V~ 50Hz					
Ventilation Mode	Heat Exchange Ventilation			Normal Ventilation		
Notch	(Extra high)	High	Low	(Extra high)	High	Low
Input (W)	387-418	360-378	293-295	387-418	360-378	293-295
Air Volume (m ³ /h)	800	800	630	800	800	630
External Static Pressure (Pa)	140	110	55	140	110	55
Noise (dB)	37.0-37.5	36.5-37.0	33.5-34.5	37.0-37.5	36.5-37.0	33.5-34.5
Temperature Exchange Efficiency(%)	75	75	76	—	—	—
Dimensions(mm)	Width 1322 ×Depth 884×Height 388					
Weight (kg)	71					

Item	Model No. FY-01KZDY8A					
Power Source	220-240V~ 50Hz					
Ventilation Mode	Heat Exchange Ventilation			Normal Ventilation		
Notch	(Extra high)	High	Low	(Extra high)	High	Low
Input (W)	437-464	416-432	301-311	437-464	416-432	301-311
Air Volume (m ³ /h)	1000	1000	700	1000	1000	700
External Static Pressure (Pa)	105	80	75	105	80	75
Noise (dB)	37.5-38.5	37.0-37.5	33.5-34.5	39.5-40.5	39.0-39.5	35.5-36.5
Temperature Exchange Efficiency(%)	75	75	79	—	—	—
Dimensions(mm)	Width 1322 ×Depth 1134×Height 388					
Weight (kg)	83					

(Note) The ratings mentioned above shows the values under the external static pressure.
 (Only the noise level shows the value under the external static pressure: 0Pa)
 Noise Level shall be measured 1.5 m below the center of the unit. (It shall be measured at the acoustic room.)

Performance (P-Q curve)

FY-250ZDY8

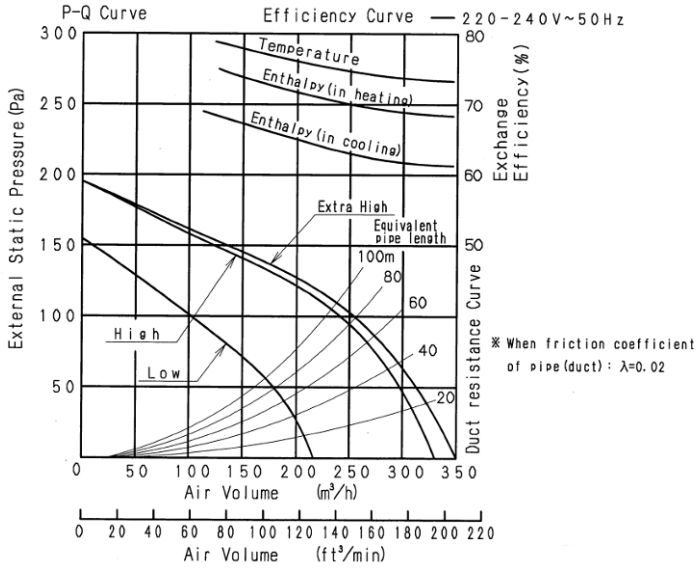

FY-350ZDY8

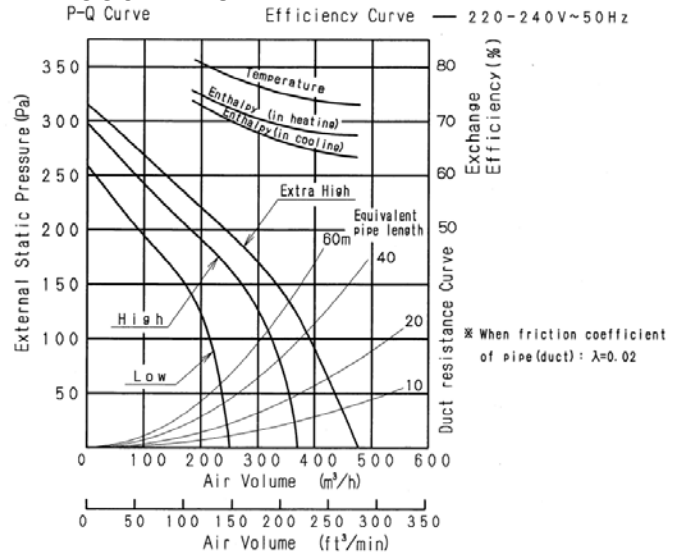

FY-500ZDY8

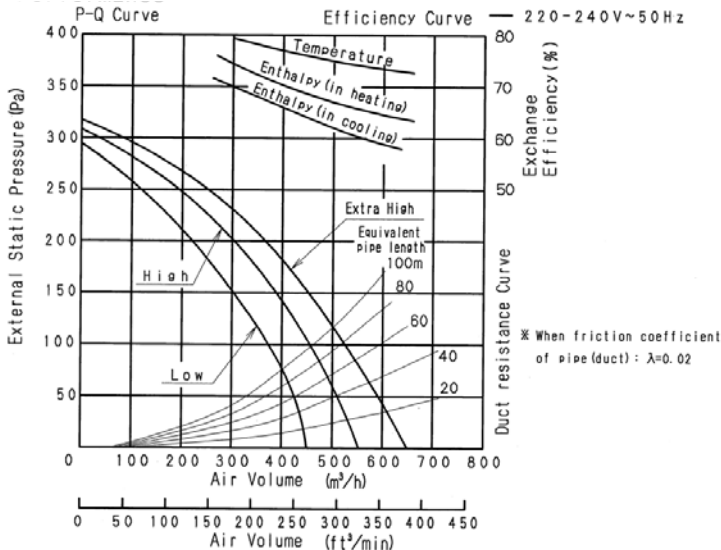

FY-650ZDY8

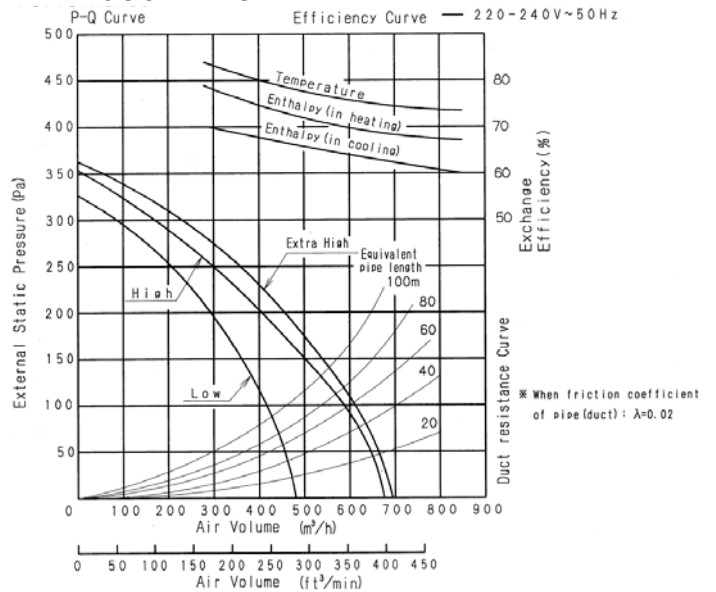

FY-800ZDY8

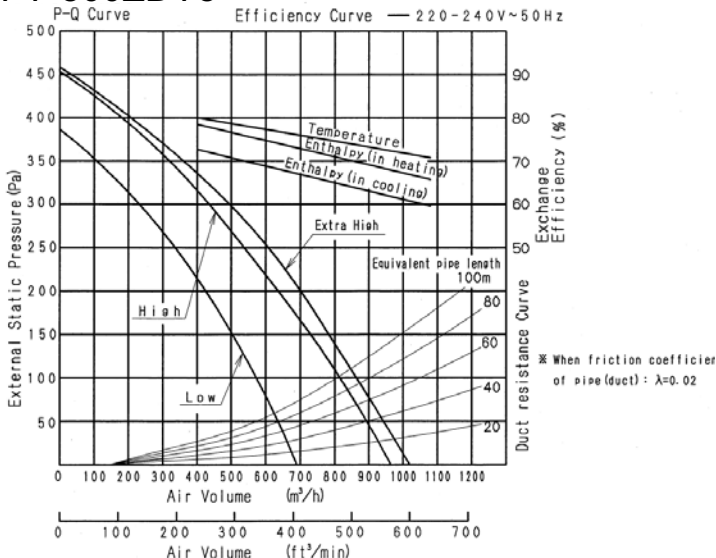

FY-01KZDY8A

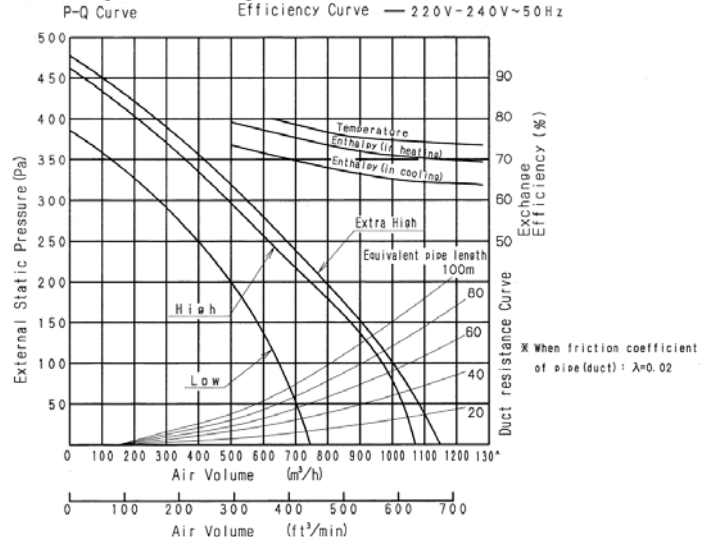

Cautions for Operation

Never fail to make the inspection opening at the specific place on the ceiling so you can perform the constant cleaning or the equipment checking of filter and heat exchange element.

- The inspection opening shown below is necessary to clean the heat exchange element and the filter as required. If not cleaned, they are likely to get clogged, resulting in degradation of performance.

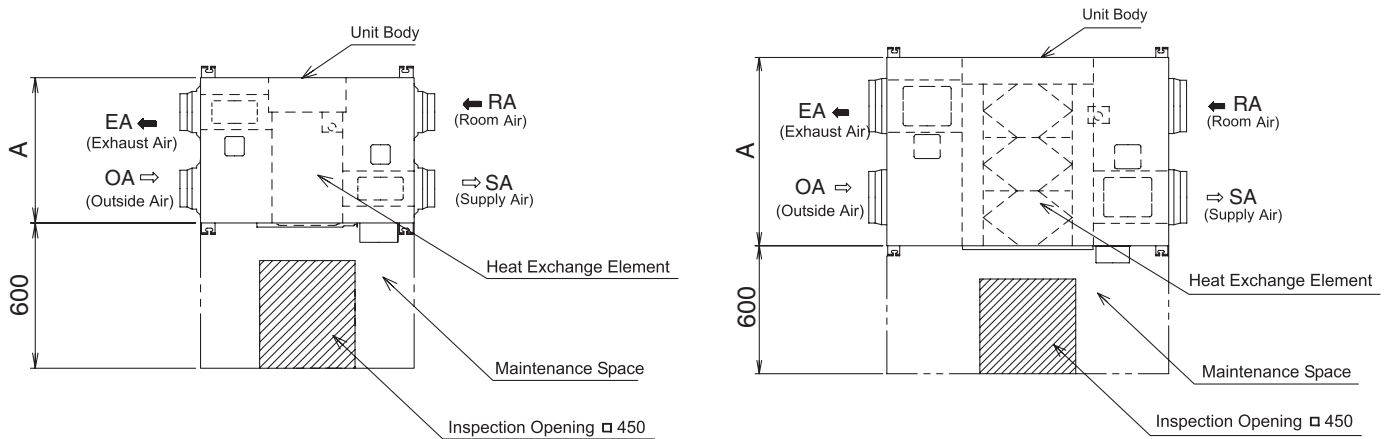

Note) Model FY-350ZDY8 and FY-500ZDY8 have two Heat Exchange Element.

Unit: mm

Model No.	A
FY-250ZDY8	599
FY-350ZDY8	804
FY-500ZDY8	904

Note) Model FY-01KZDY8A has four Heat Exchange Elements.

Unit: mm

Model No.	A
FY-650ZDY8	884
FY-800ZDY8	884
FY-01KZDY8A	1134

- This Energy Recovery Ventilators should be installed at the place where a larger space than the sizes shown below can be secured for the ceiling space.

Unit: mm

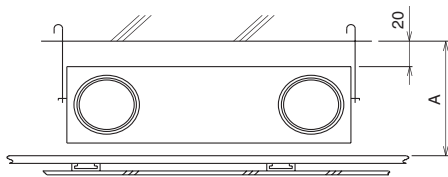

Model No.	Ceiling Space A	Model No.	Ceiling Space A
FY-250ZDY8	320	FY-650ZDY8	440
FY-350ZDY8	370	FY-800ZDY8	
FY-500ZDY8		FY-01KZDY8A	

- Don't install it near the water-heater.
- Refrain from the following duct installation works.

(1) Excessive bending



(2) Multi-times bending



(3) Making the connecting duct smaller

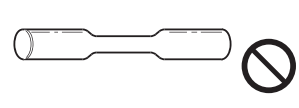

- Do not use in bathrooms or food preparation areas etc. If you use the unit at the place of much soot and high humidity, the filter or the heat exchange element gets clogged and disables you to use it.
- Use the Energy Recovery Ventilators in the ambient temperature of 40°C or less. Never install the unit at the place where the flame likely reaches directly the unit. If you use it at the atmosphere of more than 40°C for hours, it is likely to cause deterioration or deformation or damage of the resin part.
- Be careful of dewing and frosting.

As shown in the figure to the right, suppose a high temp absorbing air condition A and a low temp absorbing air condition B are plotted on the air line figure, then a high temp air A is heat-exchanged by the unit and goes out of the saturation curve as shown by Point C. In this case, the unit will be dewed or frosted. To avoid this, you are required to heat a low temp air B up to B' so as to get C' below the saturation curve, before using the unit.

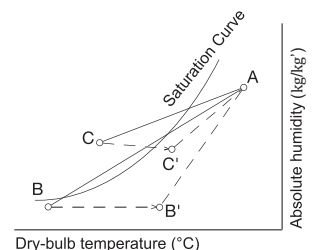

Name and Dimension of Each Part

Model No. FY-250ZDY8
FY-350ZDY8
FY-500ZDY8

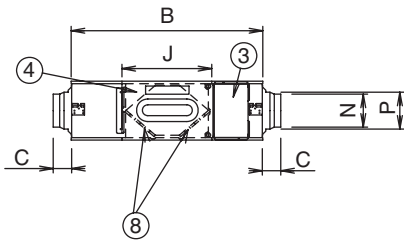
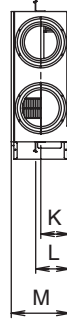
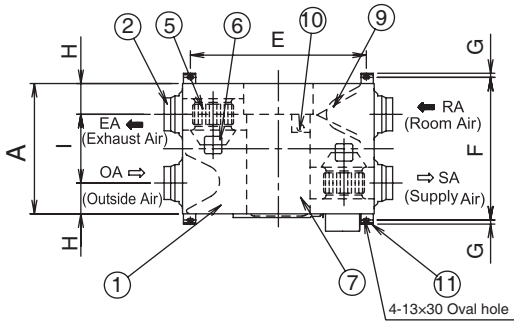

Applicable Duct

Model No.	Nominal Diameter
FY-250ZDY8	φ 150
FY-350ZDY8	φ 150
FY-500ZDY8	φ 200

Number	Name	Quantity	Note
1	Frame	1	
2	Adapter	4	
3	Terminal	1	
4	Inspection Cover	1	
5	Fan	2	
6	Motor	2	Note 2)
7	Heat Exchange element	1	Note 1)
8	Filter	2	
9	Damper	1	
10	Damper Motor	1	
11	Ceiling Suspension Fixture	4	
12	Electrical Equipment Box	1	

Note1) Model No.FY-350ZDY8 and FY-500ZDY8 have two Heat Exchange Element.

Note2) Model No.FY-350ZDY8 and FY-500ZDY8 have different fan and motor locations.

Unit: mm

Model No.	A	B	C	E	F	G	H	I	J	K	L	M	N	P
FY-250ZDY8	599	882	95	810	655	19	142	315	414	135	159	270	φ 144	φ 164
FY-350ZDY8	804	1050	70	978	860	19	112	580	470	159	182	317	φ 144	φ 164
FY-500ZDY8	904	1090	70	1018	960	19	132	640	470	159	182	317	φ 194	φ 210

Model No. FY-650ZDY8
FY-800ZDY8
FY-01KZDY8A

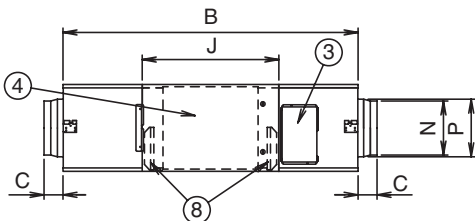
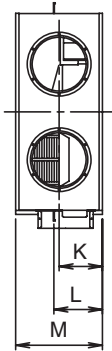
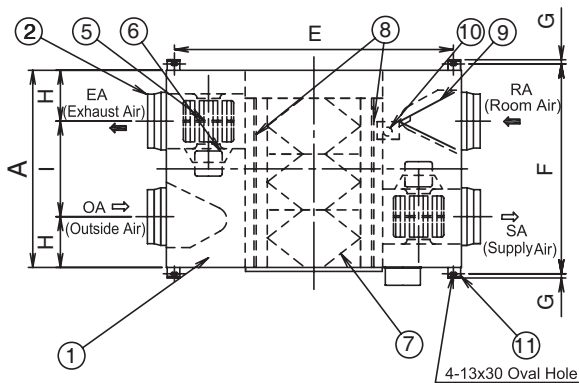

Applicable Duct

Model	Nominal Diameter
FY-650ZDY8	φ 200
FY-800ZDY8	φ 250
FY-01KZDY8A	φ 250

Number	Name	Quantity	Note
1	Frame	1	
2	Adapter	4	
3	Terminal	1	
4	Inspection Cover	1	
5	Fan	2	
6	Motor	2	Note 2)
7	Heat Exchange Element	3	Note 1)
8	Filter	2	
9	Damper	1	
10	Damper Motor	1	
11	Ceiling Suspension Fixture	4	
12	Electrical Equipment Box	1	

Note1) Model No.FY-01KZDY8A has four Heat Exchange Elements.

Note2) Model No.FY-650ZDY8 has different fan and motor locations.

Unit: mm

Model No.	A	B	C	E	F	G	H	I	J	K	L	M	N	P
FY-650ZDY8	884	1204	70	1132	940	19	132	620	560	194	218	388	φ 194	φ 210
FY-800ZDY8	884	1322	85	1250	940	19	228	428	612	194	218	388	φ 242	φ 258
FY-01KZDY8A	1134	1322	85	1250	1190	19	228	678	612	194	218	388	φ 242	φ 258

Installation Method

1. Model Installation

- You are required to prepare the ceiling suspension bolts, nuts and washers.
- Install the unit firmly and horizontally enough to support its weight. (Fig. 1)
- If you do not fit it firmly, it is not only dangerous but also easily vibrated. If it is not fitted horizontally, the damper unit becomes defective in operation.

Caution

- When you are required to be cautious on prevention of vibration, we recommend you to use the anti-vibration ceiling suspension fixtures.
- Never fail to make an inspection opening with \square 450 mm or more at the place shown on the paragraph of "Cautions For Operation", so that you can inspect filters, Heat Exchange Elements, power source and motors.

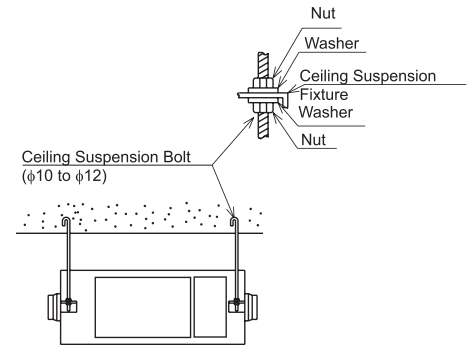

Fig. 1

2. Cautions on Installing The Unit Body Upside Down

- Re-fit the ceiling suspension fixture in an opposite side. (If they are left as it is, the foolproof function of ceiling suspension bolts do not work and will cause the danger of dropping of the unit.)

- Printed indication is in a reversed position.

In particular, be careful of the arrow mark [\uparrow] showing the direction of inserting a Heat Exchange Element.

Electric Works

Ask a specialized electrical construction operator for advice regarding wiring in accordance with "Technical Standards for Electrical Equipment" and "Interior Wiring Regulation".

- Connect wires/cables indicated by broken lines.

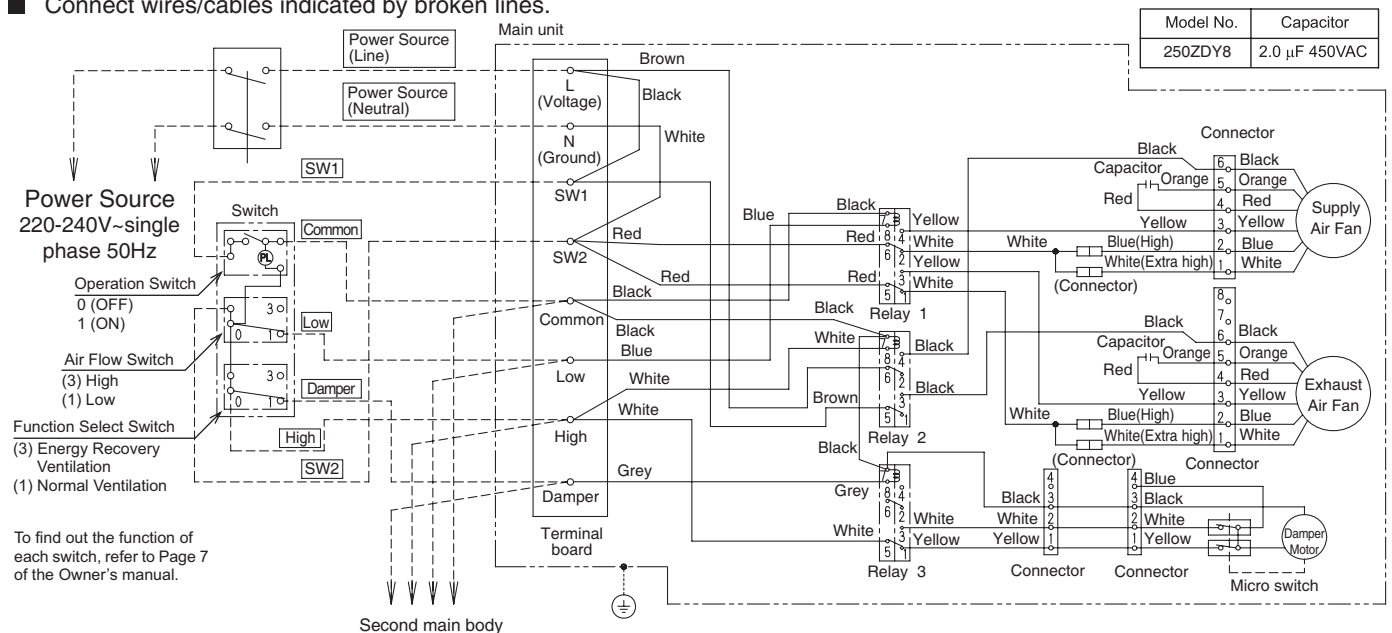

- For power supply, use a VVF cable with ϕ 1.6 or ϕ 2.

- Take the following steps on connect wires/cables:

- Remove two screws fixing the cover of the electrical components box, open the cover, and connect wires/cables correctly.
- Secure the cable drawn from the terminal board firmly with the cable holder.

- If a large volume of air is required or a long duct is used, switch the wire connection from Low to Extra high according to the following steps:

- Remove two screws securing the cover of the electrical components box, and open the cover.
- In the electrical components box, change the connection of fan motor leads from High to Extra high.

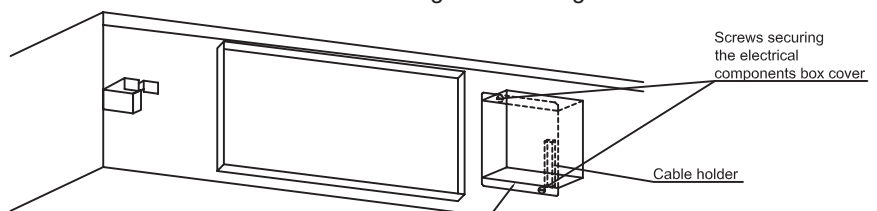
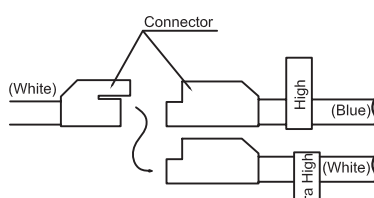

Electric works

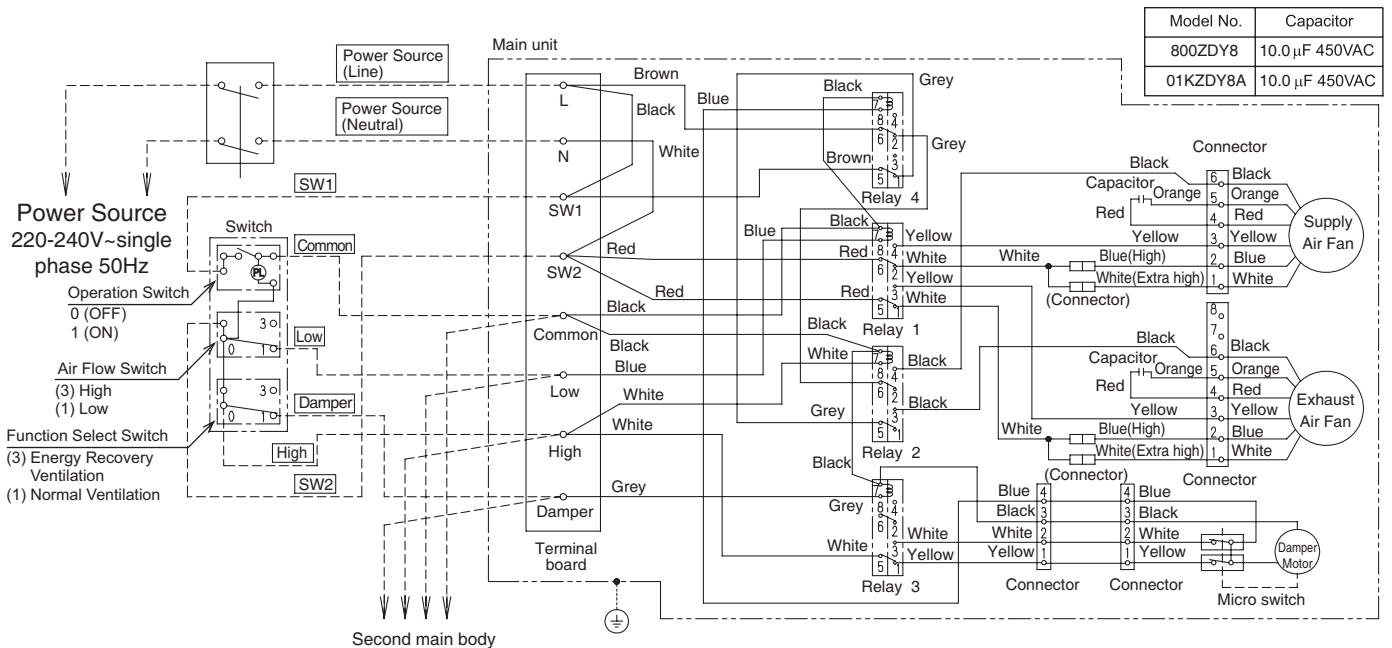
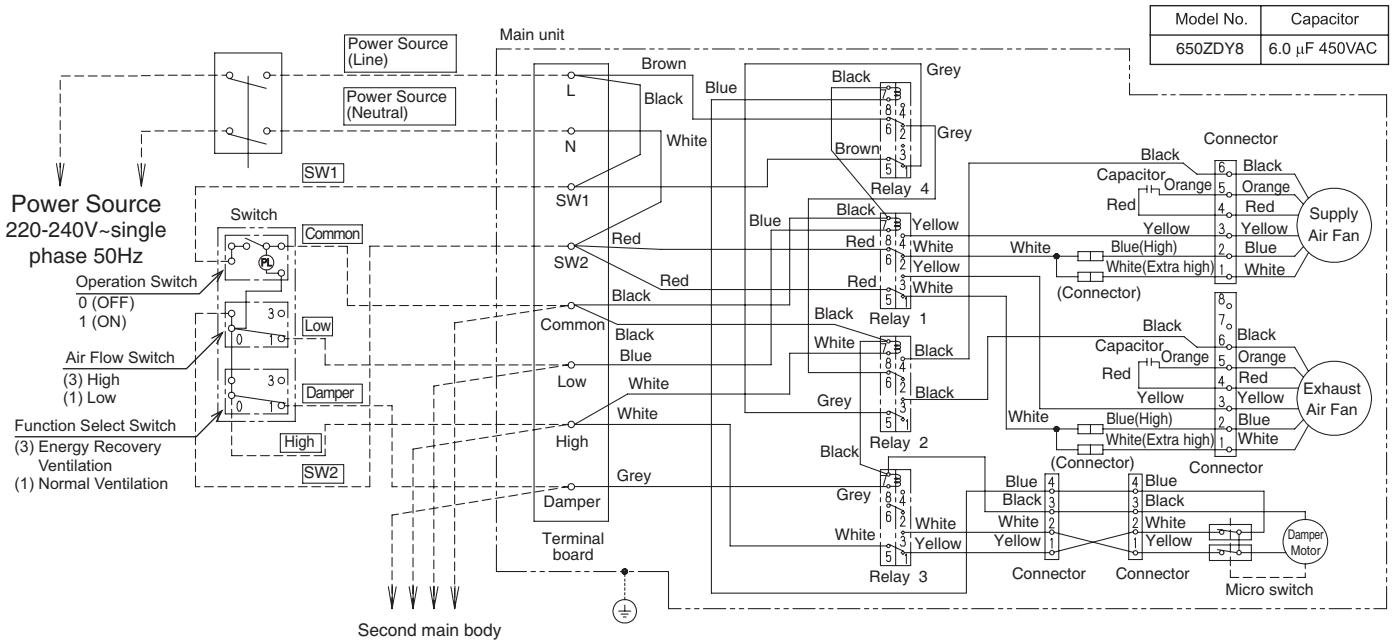
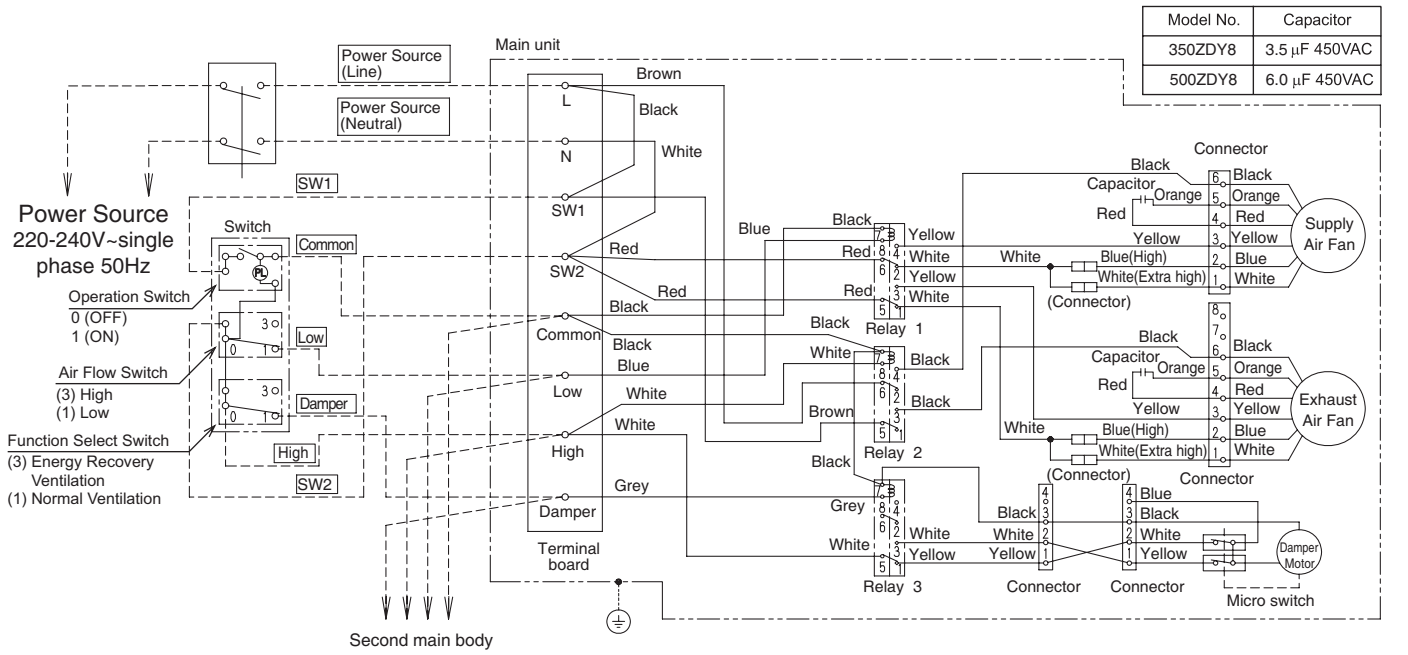

Disassembly Instruction

Method of remove the Heat Exchange Element and the filter

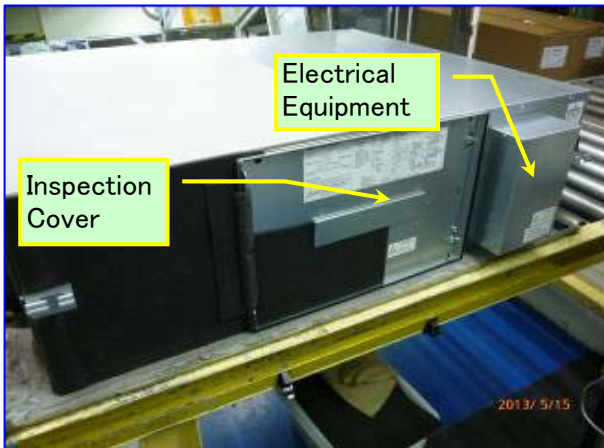

Picture 1
1: Stop operation and cut the power supply (breaker).
※The upper picture shows model FY-500ZDY8.

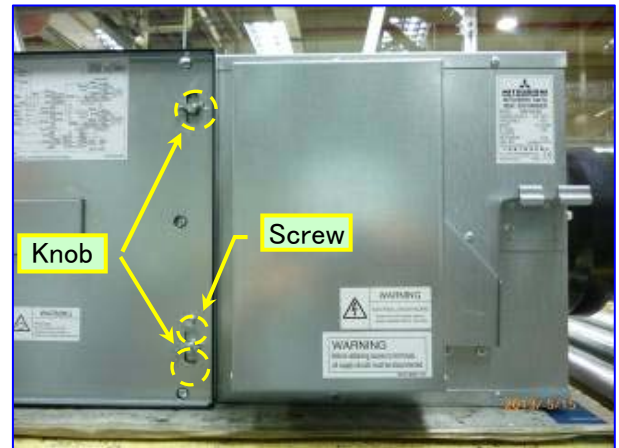

Picture 2
1: Turn the knob (2 pieces) and the screw (1 piece) and remove the Inspection Cover.

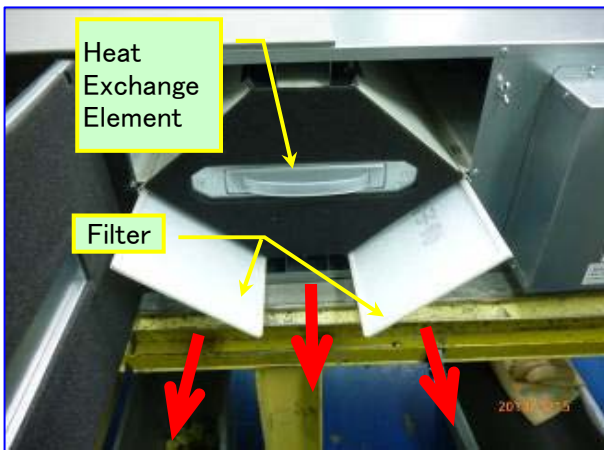

Picture 3
model No.FY-250ZDY8/350ZDY8/500ZDY8
1: Remove the Heat Exchange Element and the filter.
Note) The quantity and form of Heat Exchange Element differ depending on the model.

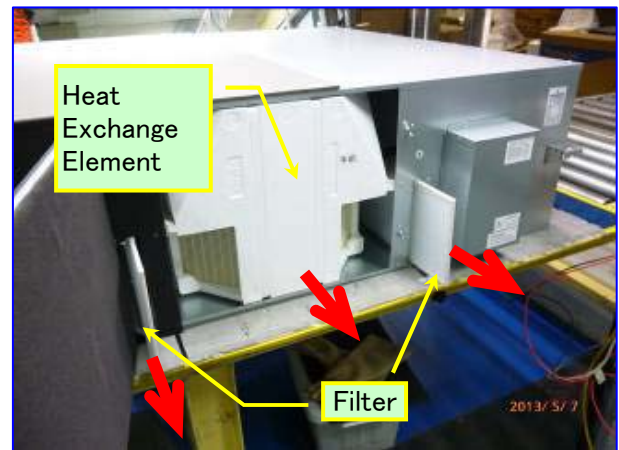

Picture 4
model No.FY-650ZDY8/800ZDY8/01KZDY8A
1: Remove the filter and the Heat Exchange Element.
Note) The quantity and form of Heat Exchange Element differ depending on the model.

The quantity of Heat Exchange Element by Model

No	型番	ELEMENT	FILTER
1	FY-250ZDY8	1	2
2	FY-350ZDY8	2	2
3	FY-500ZDY8	2	2
4	FY-650ZDY8	3	2
5	FY-800ZDY8	3	2
6	FY-01KZDY8A	4	2

Note: There are differences in the form of Heat Exchange Element between No.1~No.3 and No.4~No.6.
Refer to the upper picture 3 and picture 4.

Disassembly Instruction

Method of remove the Motor Assembly (FY-250ZDY8/350ZDY8/500ZDY8)

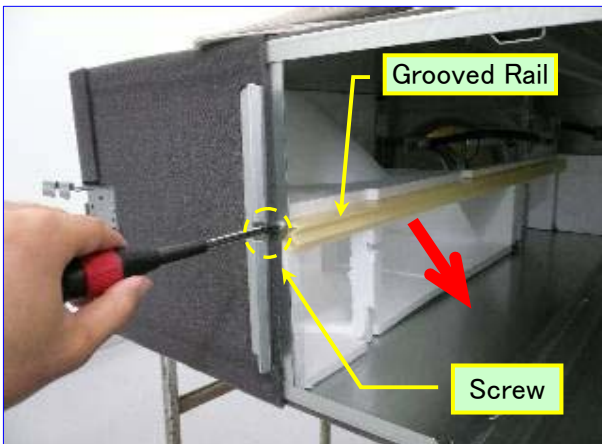

Picture 5

- 1: Remove the filter and the Heat Exchange Element.
※Refer to the attached 『Method of remove the Heat Exchange Element and the filter』.
- 2: First remove the screw (1 piece) and then remove the Grooved Rail.

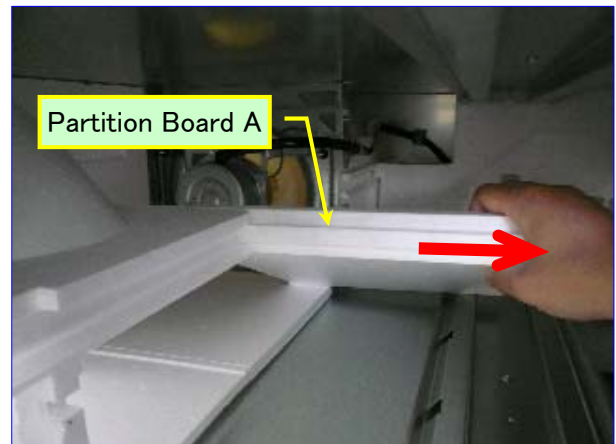

Picture 6

- 1: Pull the partition board A out to the direction of arrow.

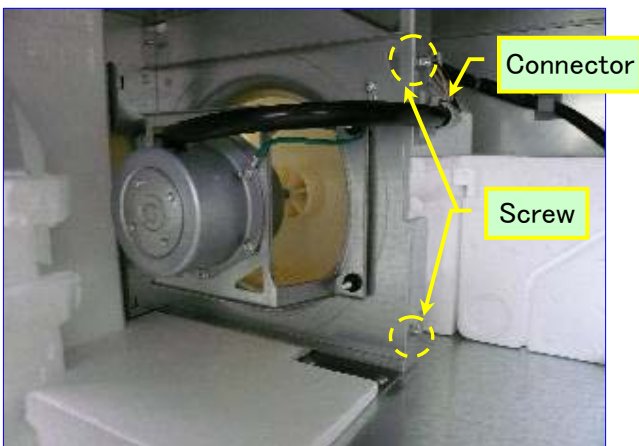

Picture 7

- 1: Turn two pieces of screw on the Motor ASSY and remove the wired connector.

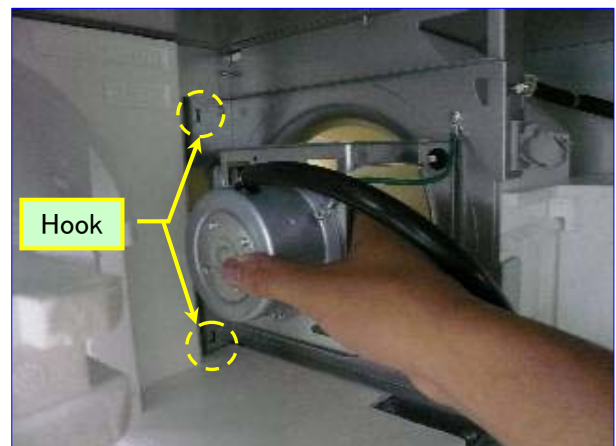

Picture 8

- 1: Unhook the Motor ASSY.



Picture 9

- 1: Rotate the Motor ASSY around the axis.
(Note) Actually, The color of a wheel is black.

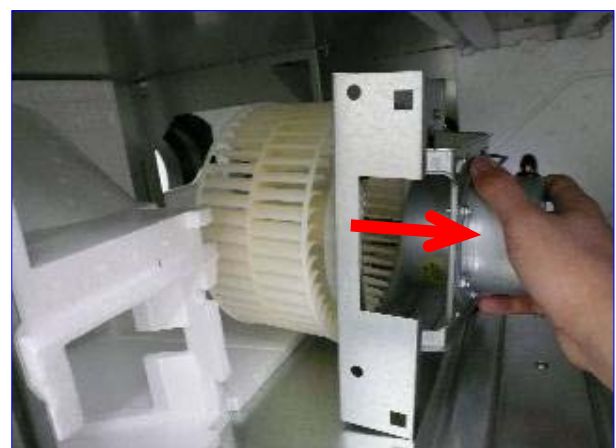

Picture 10

- 1: Pull it out to the direction of arrow and put outside of product.

Disassembly Instruction

Method of remove the Motor Assembly (**FY-650ZDY8/800ZDY8/01KZDY8A**)



Picture 11

- 1: Remove the filter and the Heat Exchange Element.
※Refer to the attached 『Method of remove the Heat Exchange Element and the filter』.
- 2: First remove the screw (1 piece) and then remove the Grooved Rail.

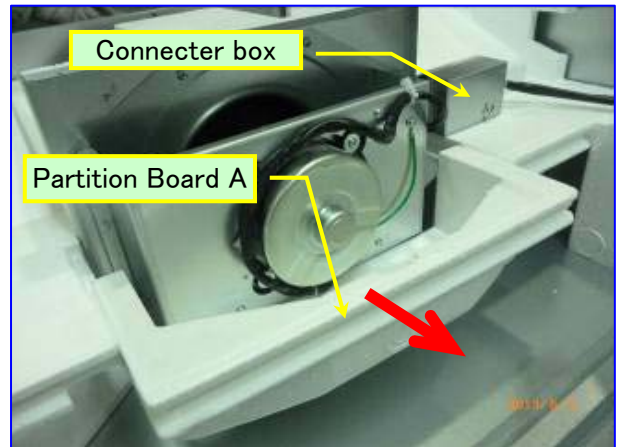

Picture 12

- 1: Pull the partition board A out to the direction of arrow.

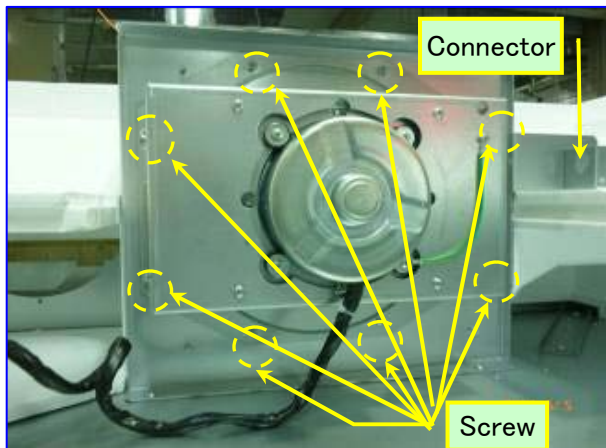

Picture 13

- 1: Trun 8 pieces of screw on the Motor ASSY and remove the wired connector.



Picture 14

- 1: Pull it out to the direction of arrow and put outside of product.

Disassembly Instruction

Method of remove the parts of Electrical Equipment

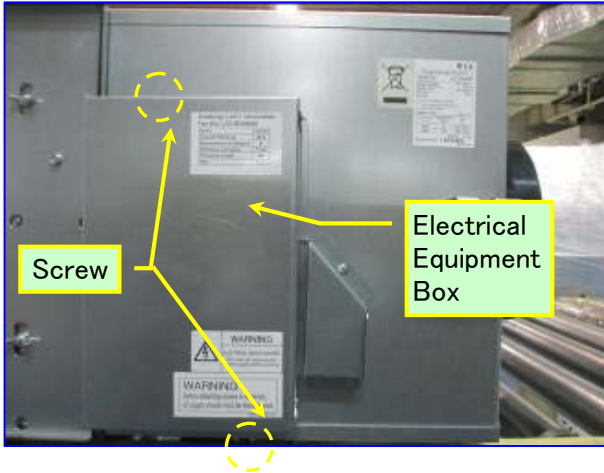

Picture 15

1: First remove the screw (2 pieces) and then remove the cover of Electrical Equipment Box.

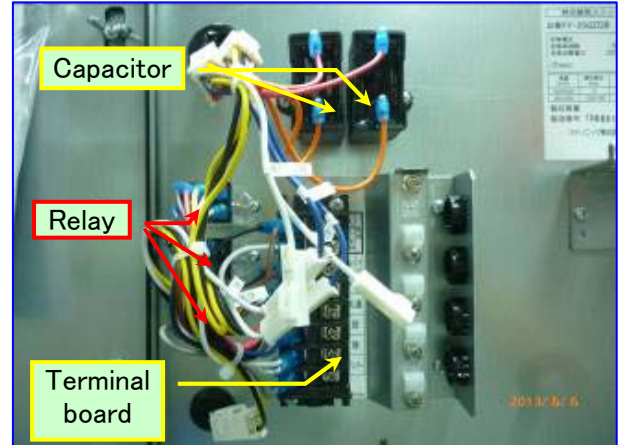

Picture 16

1: Inside of the Electrical Equipment Box.

■ Disassembly Instruction Method of remove the parts of Damper Unit

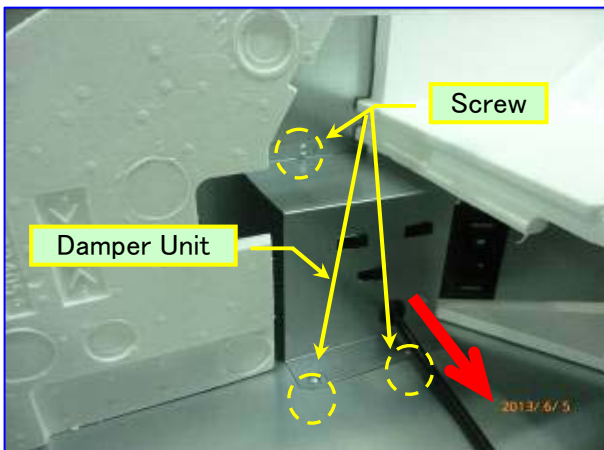

Picture 17

1: Remove the screw (3 piece).
2: Pull the Damper Unit out to the direction of arrow 2.



Picture 18

1: Put outside of product.

Exploded View

FY-250ZDY8, FY-800ZDY8, FY-01KZDY8A

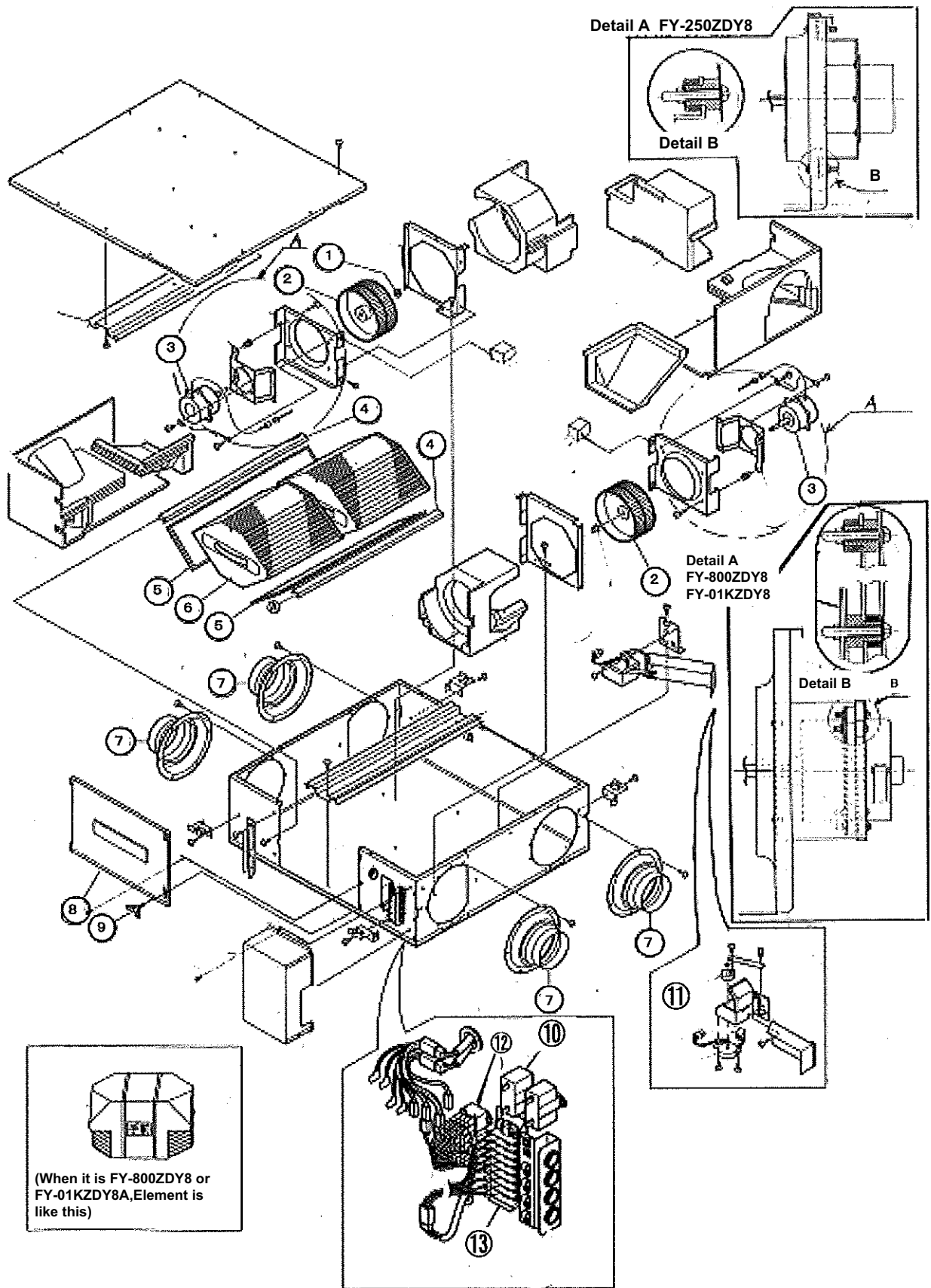

Exploded View

FY-350ZDY8, FY-500ZDY8, FY-650ZDY8

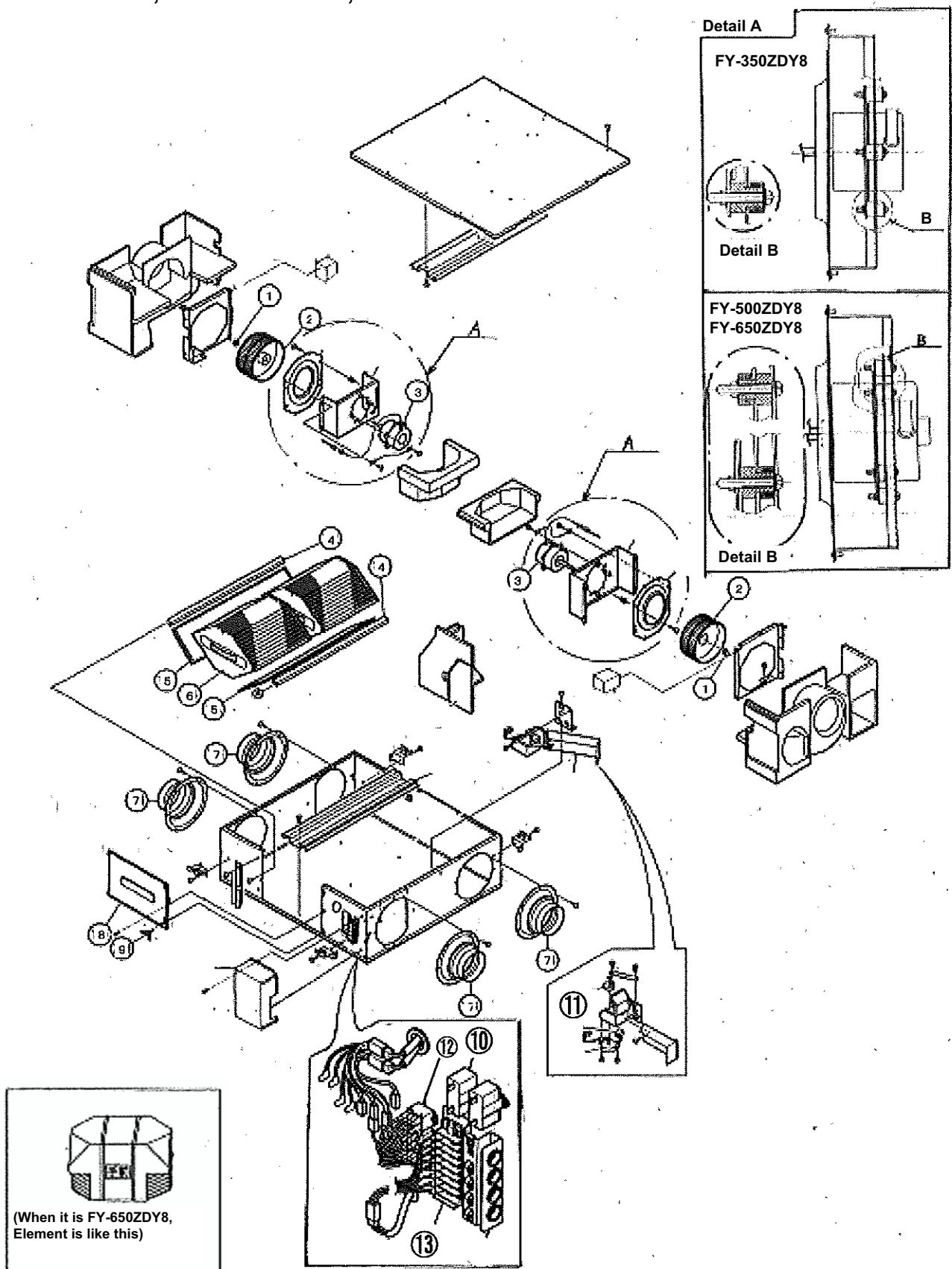

Parts List

No.	Part Name	FY-250ZDY8		FY-800ZDY8		FY-01KZDY8A	
		Part No.	Q'ty per Set	Part No.	Q'ty per Set	Part No.	Q'ty per Set
1	Nut	F05070006A	2	80ZDY20251A	2	80ZDY20251A	2
2	Fan	25ZD80702A	2	80ZD80702A	2	80ZD80702A	2
3	Motor	25ZDY3M200B	2	80ZDY3M200B	2	01KZDY3M200B	2
4	Rail	25ZD80218	2	80ZD80218	2	01KZD80218	2
5	Filter	25ZD80811	2	65ZD80811	2	01KZD80811	2
6	Element	25ZD80800A	1	80ZD80800B	3	80ZD80800B	4
7	Adapter	25ZDY20220	4	80ZDY20220	4	80ZDY20220	4
8	Element Cover	15ZD80212A	1	80ZD80213A	1	80ZD80213A	1
9	Chou Bolt M5	BT50ZD60299A	2	BT50ZD60299A	2	BT50ZD60299A	2
10	Capacitor	12ESN06C2	2	DS451106Q1AA	2	DS451106Q1AA	2
11	Damper Unit	25ZD8S400A	1	80ZD8S400A	1	01KZD8T400A	1
12	Relay	AP5528F	3	AP5528F	4	AP5528F	4
13	Terminal-8P	JXO-B-8P-00	1	JXO-B-8P-00	1	JXO-B-8P-00	1

No.	Part Name	FY-350ZDY8		FY-500ZDY8		FY-650ZDY8	
		Part No.	Q'ty per Set	Part No.	Q'ty per Set	Part No.	Q'ty per Set
1	Nut	F05070006A	2	F05070006A	2	F05070006A	2
2	Fan	50ZD80702	2	50ZD80702	2	50ZD80702	2
3	Motor	XM-350ZDY8	2	XM-50ZDY3M200	2	XM-65ZDY3M200	2
4	Rail	35ZD80218	2	50ZD80218	2	65ZDY30230B	1
						65ZDY30231B	1
5	Filter	35ZD80811	2	50ZD80811	2	65ZD80811	2
6	Element	15ZD80800A	2	50ZD80800A	2	65ZD80800B	2
7	Adapter	35ZD80220	4	50ZD80220	4	50ZD80220	4
8	Element Cover	35ZD80212A	1	35ZD80212A	1	65ZD80213A	1
9	Chou Bolt M5	BT50ZD60299A	2	BT50ZD60299A	2	BT50ZD60299A	2
10	Capacitor	12ESN06C2	2	DS451605Q1AA	2	DS451605Q1AA	2
11	Damper Unit	35ZD8S400A	1	50ZD8S400A	1	65ZDY80400	1
12	Relay	AP5528F	3	AP5528F	3	AP5528F	4
13	Terminal-8P	JXO-B-8P-00	1	JXO-B-8P-00	1	JXO-B-8P-00	1

Package

	Model No.	Packing dimension (mm)				Gross weight (kg)
		W	L	H	Detail	
1	FY-250ZDY8	349	1132	795		35
2	FY-350ZDY8	396	1250	1000		57
3	FY-500ZDY8	396	1290	1100		66
4	FY-650ZDY8	467	1434	1170	※1080+bottom support 90mm	77
5	FY-800ZDY8	467	1552	1170	※1080+bottom support 90mm	82
6	FY-01KZDY8A	467	1552	1420	※1330+bottom support 90mm	98

Model No. FY-250ZDY8, FY-350ZDY8, FY-500ZDY8

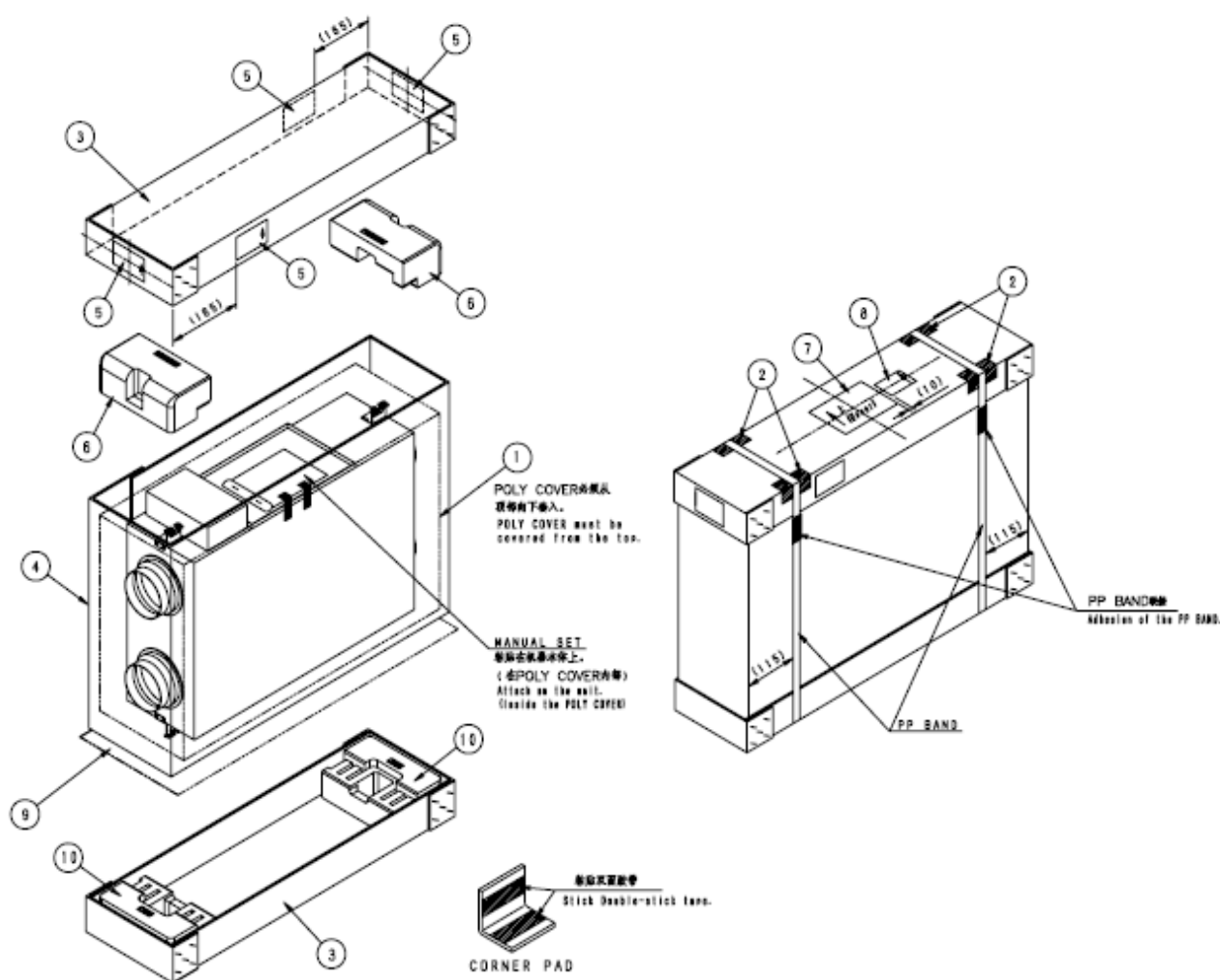

序号No.	图名 Parts name	数量Qty	备注Remarks
1	POLY COVER	1	
2	CORNER PAD	4	
3	CAP	2	
4	SIDE CAP	1	
5	PACKAGE LABEL	4	
6	TEN ATE	2	
7	KONPOU LABEL	1	
8	CAUTION LABEL	1	
9	POLY SHEET	1	
10	SOKO ATE	2	

Package

Model No. FY-650ZDY8, FY-800ZDY8, FY-01KZDY8A

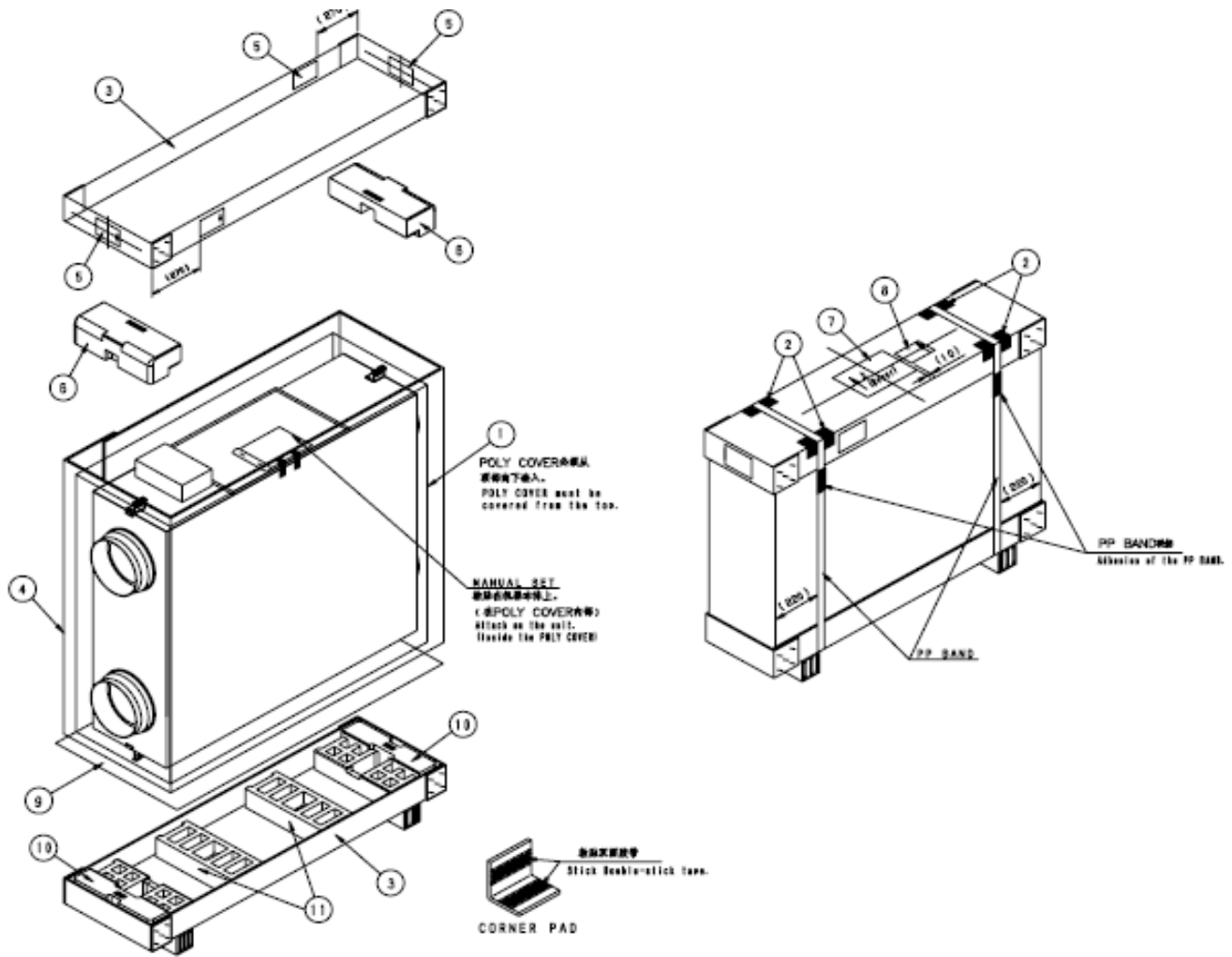

序号No.	图名 Parts name	数量Qty	备注Remarks
1	POLY COVER	1	
2	CORNER PAD	4	
3	CAP	2	
4	SIDE CAP	1	
5	PACKAGE LABEL	4	
6	TEN ATE	2	
7	KONPOU LABEL	1	
8	CAUTION LABEL	1	
9	POLY SHEET	1	
10	SOKO ATE	2	
11	NAKA ATE	2	

Modification Process

No.	Modified Date	Modification Process
1	2013.07.23	Making a new version (Ver.1.0)
2		
3		
4		
5		