

TECHNICAL DATA

Intelligent Controller

■ Intelligent Controller

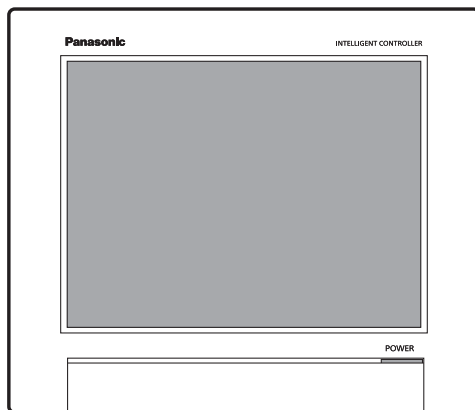

Intelligent Controller

CZ-256ESMC3

■ Communication Adaptor

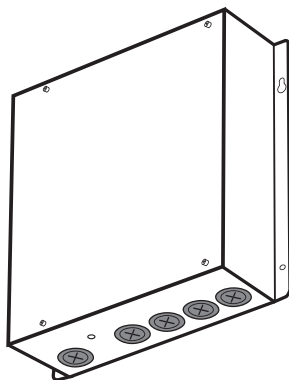

Communication Adaptor

CZ-CFUNC2

★ The appearance and specifications of this unit and the contents of this Technical Data may be changed without notice due to performance improvement or other reasons.

Panasonic Corporation
Commercial Air-Conditioner Business Unit

Table of Contents

	Page
■ Safety Precautions	1
■ Note	2
■ Fault diagnosis	3
■ Various procedures	14
— Display and settings for the communication adaptor board	14
— Communication adaptor microcomputer rewrite procedure	34
— Intelligent Controller software update procedure	36
— Replacement of SD card, and operation procedure at time of failure	37
— Procedure for replacing touch panel LCD	41
— Procedure when adding/removing a unit	44
— Procedure when entering or leaving an area mid-period	45
■ Operating Instructions	46
— Intelligent Controller	46
■ Installation Instructions	149
— Intelligent Controller	149
— Communication adaptor	154
■ Intelligent Controller web settings	162
— Advance check sheet	162
— Web setting	167
— Outgoing email settings	173
■ Input of the admin number (password)	175



Safety Precautions

- Before repair work, please read this “Safety Precautions” carefully and use the unit correctly.
- The notes shown here are categorized as “⚠ Warning” and “⚠ Caution”, but since they all describe important contents on safety, be sure to observe them.
- The display and meaning are as follows.

 **WARNING** This symbol refers to a hazard or unsafe practice which can result in severe personal injury or death.

 **CAUTION** This symbol refers to a hazard or unsafe practice which can result in personal injury or product or property damage.





- Meaning of symbol

-  A “warning” or “caution” item.
-  Content that must not be done (prohibited item).
-  Content that must be done (mandatory item).

- After the repair work, make a test run to check whether there is any error and explain the notes on use to the customer.



1. Notes on repair

 **WARNING**

-  When performing disassembly repair, be sure to stop operation and switch off the earth leakage breaker. Failure to do so may cause electric shock. Be careful not to touch the charging unit when performing a repair or a circuit inspection that requires a power supply.
-  Switch off the earth leakage breaker of the unit before repair work. Failure to do so may cause electric shock.
-  Do not repair electrical parts with wet hands. Doing so may cause electric shock.
-  Do not spray detergent spray or water on the unit. Doing so may cause electric shock or fire due to malfunction or electrical short circuit.

2. Notes on products after repair

 **WARNING**

-  Be sure to repair the unit with parts that are described in the service parts list of the applicable model and use the appropriate tools. In addition, never modify the product. Doing so may cause electric shock, overheating or fire.
-  When moving the unit, be sure to install it securely. Inadequate strength or incomplete installation may cause a fall, electric shock, overheating or fire.
-  Do not damage or modify the power cord. Doing so may cause electric shock or fire. Placing heavy objects on the power cord, heating it, or pulling it, may cause damage.

3. Inspection items after repair

 **WARNING**

-  Scratched or deteriorated power cords or lead wires must be replaced. Also, do not connect the power cord partway. Doing so may cause electric shock, overheating or fire.

 **CAUTION**

-  Check that product mounting positions, wiring conditions, and connection state such as soldering, crimp terminal, and so on are normal. Failure to do so may cause overheating, fire or electric shock.

When disposing of this unit or other items, please take appropriate measures such as collecting and erasing internal information to prevent leakage of confidential information.

N o t e

1. About noise malfunction

Since communication control is performed by pulse signal, it has the property that it is easily affected by external noise. In normal use, there is no problem since this is taken into consideration on the circuit, but please note that an influence may occur depending on the installation state.

<Items that add high frequency noise to the signal line, causing error in the signal pulse and malfunction>

Places susceptible to noise	Symptoms	Measures
1. Area with strong radio waves in the vicinity of a broadcasting station 2. Near to wireless station 3. Near to use of high-frequency sewing machines or arc welding machines 4. Hospitals (such as X-ray rooms) 5. Near to plasma or liquid crystal televisions	1. Stops in the middle of operation 2. The liquid crystal display flickers	Prevent noise from being received by the signal wiring ↓ · Keep away from source · Adopt shielded wire

Fault Diagnosis Table of Contents

1. Communication error related

1-1.	[C06] error appears on [Alarm list] screen	4
1-2.	[C17] or [Outdoor C17] error appears on [Alarm list] screen	5
1-3.	[C19] error appears on [Alarm list] screen	5
1-4.	[Disc.] error appears on [Alarm list] screen	5

2. Screen display related

2-1.	Touch panel LCD does not work (Screen operation is not possible)	6
2-2.	Nothing is displayed on screen	6
2-3.	No indoor unit is displayed on the screen, or the number of units is too small	7
2-4.	Cannot enter the screen selected in the menu	7
2-5.	Distribution ratio and usage are displayed as 0	7
2-6.	Pulse count does not enter properly	8
2-7.	Cumulative operation time (or distribution ratio) is counted even though the unit has not been operating	9
2-8.	Cannot back up or restore to USB memory device (button is greyed out and cannot be pressed)	9
2-9.	Intelligent Controller does not start	10
2-10.	[Config. change] appears on [Alarm list] screen	11
2-11.	Room temperature display is in error ([I/D unit list] screen)	11

3. Unit operation related

3-1.	Schedule timer does not work properly	12
3-2.	Unit does not stop (operate) even when Batch stop (startup) input is ON	12
3-3.	External alarm (operation) output does not turn ON even though unit alarm is detected	13
3-4.	Even if remote controller prohibition is set, function settings can be individually changed by the remote controller	13

《Note》 The meaning of the symbols below are as follows.

- Adaptor Communication adaptor
- MAIN board MAIN board of communication adaptor

1. Communication error related

1-1. [C06] error appears on [Alarm list] screen

① Detection method

If the Intelligent Controller cannot receive data from the communication adaptor board for a certain period of time or longer, or if in an error is detected in the received data.

② Diagnosis of failure

1. Communication adaptor (Power supply system)	1-1	Is anything displayed on the 7-segment LED (6) on the board?	Yes	2-1
			No	1-2
	1-2	Is the power switch on the board ON?	Yes	1-3
			No	Turn ON
	1-3	Is there a disconnection or open circuit in a connector on the board? · CN 5 (white 6P)	Yes	Correct wiring
No			1-4	
1-4	(External adaptor only) Is there a disconnection or open circuit in a connector on the power supply board? · CN1 (white 5P) · CN2 (white 4P / 7P)	Yes	Correct wiring	
1-5	Has the fuse (F1) of the board burned out?	No	1-5	
		Yes	Replace the fuse	
2. Communication adaptor (Communication system)	2-1	Is there a disconnection, looseness, an open circuit, or a short circuit in the wiring of 11P or 12P [ADAPT] (RS485) of the 20P terminal block CN2?	Yes	Replace the fuse
			No	2-1
2-2	Is the wiring polarity of 11P, 12P "ADAPT" (RS485) of the 20P terminal block CN2 correct? (+, -)	Yes	Correct wiring	
		No	3-1	
3. Construction / settings related	3-1	Did you change the adaptor address settings since the Intelligent Controller started?	Yes	Undo or check configuration
			No	3-2
	3-2	Are the "LINK connect Yes/No" settings correct? (See the "Display and settings on the communication adaptor board" section)	Yes	3-3
			No	Modify settings
	3-3	Is jumper plug CN032 of the communication adaptor at the end of the crossover wiring set to "B" (with terminating resistance)? * Built-in board of Intelligent Controller main body set to "B" (with terminating resistance).	Yes	3-4
No			Set it to "B"	
3-4	Is jumper plug CN032 of the communication board that's located <u>not</u> at the end of the crossover wiring set to "A" (with terminating resistance)?	Yes	3-5	
		No	Set it to "A"	
3-5	Are there any of the following types of deficiencies in the construction of the communication adaptor control wiring? · Power lines and bundled lines or running in parallel · The total extension exceeds 1 km · It is not crossover wiring (there is a branch point) · Shielded wire is not used · The shield is grounded on both sides or not grounded	Yes	Reconstruct properly	
		No	4	
4. Replace the communication adaptor board for which there is an alarm Or, replace the product main unit				

1-2. [C17] or [Outdoor C17] error appears on [Alarm list] screen

① Detection method

If the communication adaptor cannot receive data from the indoor or O/D unit for a certain period of time or longer, or if an error is detected in the received data.

② Diagnosis of failure

1. Unit	1-1	Is there a unit that is turned off?	Yes	Turn on the power
			No	1-2
	1-2	Is there looseness, a disconnection, an open circuit, or a short circuit in the inter-unit control wiring connection?	Yes	Correct wiring
			No	1-3
	1-3	Are there any of the following types of deficiencies in the construction of the inter-unit control wiring? <ul style="list-style-type: none"> · Running in parallel with power lines · Branch points exceed 16 places · The total extension exceeds 1 km · There is re-branching after branching · There is a branch point with many branches ("star" or "octopus" configuration) · The distance between one branch point and the next branch point is 2 m or less · Defective termination resistance settings (too low or too high) · When shielded wire is used, the shield is grounded on both sides or not grounded 	Yes	Reconstruct properly
			No	2-1
2. Intelligent Controller	2-1	Is there looseness, a disconnection, an open circuit, or a short-circuit in the wiring of 1, 2 (LINK1) or 4, 5 (LINK2) of the Intelligent Controller's 27P terminal board?	Yes	Correct wiring
			No	3
3. Replace the communication adaptor board for which there is an alarm Or, replace the product main unit				

1-3. [C19] error appears on [Alarm list] screen

① Detection method

When there are multiple adaptors with the same address in one communication adaptor control wiring system.

② Diagnosis of failure

1. Communication adaptor	1-1	Is there more than one adaptor with the same address in one communication adaptor control wiring system?	Yes	Modify settings *
			No	2-1
2. Communication adaptor control wiring	2-1	Are there any of the following types of deficiencies in the construction of the communication adaptor control wiring? <ul style="list-style-type: none"> · Power lines and bundled lines or running in parallel · The total extension exceeds 1 km · It is not a crossover wiring (there is a branch point) · Shielded wire is not used · The shield is grounded on both sides or not grounded 	Yes	Reconstruct properly
			No	3
3. Replace the adaptor board for which there is an alarm Or, replace the product main unit				

* After correctly setting the adaptor address, perform [Check configuration] on the Intelligent Controller screen, to confirm.

* [Check configuration] is displayed under [Settings] → [System settings].

1-4. [Disc.] error appears on [Alarm list] screen

① Detection method

It is the same as for "1-1. [C06] error appears on [Alarm list] screen". However, if an air conditioner is connected to the communication adaptor, a "Disc." error is displayed on that air conditioner (Indoor unit, Outdoor unit).

② Diagnosis of failure

Refer to "② Diagnosis of failure" in 1-1.

2. Screen display related

2-1. Touch panel LCD does not work (Screen operation is not possible)

1. Intelligent Controller	1-1	Is [InitCom...] displayed?	Yes	Wait till it disappears
			No	1-2
	1-2	Is the following displayed? · Checking config... Wait... · Updating config... Wait... · Calculating distribution... · Please wait a moment now	Yes	Wait till it disappears
			No	1-3
	1-3	Is it processing one of the following? · Backup to USB memory device · Restore from USB memory device · Distribution calculation processing	Yes	Wait till processing finishes
			No	1-4
	1-4	Restart the Intelligent Controller (turn the power off / on) and wait for it to start up. Is the touch panel working at this time?	Yes	OK (END)
			No	1-5
	1-5	Replace touch panel LCD Or, replace the product main unit		

2-2. Nothing is displayed on screen

1. Intelligent Controller	1-1	Is the power indicator (green) on the front lit?	Yes	1-7
			No	1-2
	1-2	Is the main power supply ON?	Yes	1-3
			No	Turn ON
	1-3	Is power supplied to the power terminal board?	Yes	1-4
			No	Connect the power supply.
	1-4	Is fuse F1 blown?	Yes	Replace the power supply board.
			No	1-5
	1-5	Is there a disconnection or an open circuit of a connector on the MAIN board? · CN5 (white 6P) · CN9 (white 2P)	Yes	Correct wiring
			No	1-6
	1-6	Is anything displayed when the main power supply of the Intelligent Controller is turned OFF once and then turned ON again?	Yes	(END)
			No	1-9
	1-7	Is anything displayed when you press somewhere on the screen?	Yes	(END)
			No	1-8
	1-8	Remove the sheet metal cover on the LAN connector (2 sides). At this time, is the SD memory card not installed or defective?	Yes	Insert it correctly, then turn ON the power again
			No	1-9
	1-9	Replace Intelligent Controller		

2-3. No indoor unit is displayed on the screen, or the number of units is too small

1. Intelligent Controller	1-1	Can you perform the basic settings for the indoor unit? * For the basic settings of an indoor unit, select [I/D unit settings] from [Settings] → [System settings], check the details of the setting, place a check in the [Register] field and register with the [Register] button.	Yes	1-2
			No	Register
	1-2	Is the [No-comm mode] setting set to [YES]? * [No-comm mode] setting is displayed under [Settings] → [A/C maintenance] → [A/C communication settings] → [Next].	Yes	Set it to "NO" Check configuration
			No	1-3
	1-3	Is the setting of [A/C conctn] set to [None]?	Yes	Correct the setting to "ON"
			No	1-4
	1-4	Are you connecting 17 or more linked air conditioners?	Yes	Reduce to within 16 links
			No	1-5
1-5	What happens when you perform [Check configuration]*? [Config. has been chngd Confirm configuration?] is displayed → [Begin config] [The configuration has not changed.] is displayed → Go to 1-6			
1-6	Refer to the items "1-1. [C06] error appears on [Alarm list] screen", "1-2. [C17] or [Outdoor C17] error appears on [Alarm list] screen" and check all the same contents			

* [Check configuration] is displayed under [Settings] → [System settings].

2-4. Cannot enter the screen selected in the menu

1. Intelligent Controller	1-1	Are you registering an admin number (password)? (Settings → System settings → Web user settings)* * For screens protected by the admin number (password), refer to the Operating Instructions.	Yes	(END)
			No	

* When entering each menu on the Intelligent Controller, the PIN is set on the Settings → IntlgtCtrlr maintnce → Initialize screen.

2-5. Distribution ratio and usage are displayed as 0

If the distribution ratio is 0%, start from "1-1".

If distribution ratio is displayed, but usage is 0, start from "1-7".

1. Intelligent Controller	1-1	When performing time slot integration, is the displayed time slot selection correct? (RglHour (RglHour 1 to 8) / OutOfHours / SpcfdDay / AllHours)	Yes	1-2
			No	Select the correct time slot
	1-2	When confirming the operation time of the indoor unit belonging to that area under [Oper./Status] → [Accumul/Distrib] → [I/D unit acc.] screen, are all "0: 00"?	Yes	1-3
			No	1-4
	1-3	If the operation time is 0:00, the distribution ratio, charge, and usage are all displayed as 0. (In the case of time distribution) (END)		
	1-4	Are the area distribution settings completed? ([Settings] → [System settings] → [Area group name settings] screen)	Yes	1-5
			No	1-7
	1-5	Are the distribution settings of the distribution group completed? ([Settings] → [System settings] → [Distribution group settings] screen)	Yes	1-6
			No	1-7
	1-6	In the case of an area consisting of all local adaptors, is the capability value set? ([Settings] → [System settings] → [I/D unit settings] screen)	Yes	1-8
			No	1-7
	1-7	Set the contents of 1 - 4, 1 - 5, 1 - 6 correctly. (*) If [0] is still displayed for usage, go to 1-8.		
	1-8	Is the count from the pulse meter on? (Check the [Oper./Status] → [Accumul/Distrib] → [Pulse acc.] screen)	Yes	1-9
			No	*1
1-9	Is the pulse unit quantity setting complete? ([Settings] → [System settings] → [Pulse meter settings] screen)	Yes		
		No	Apply settings *2	

* 1 Diagnosed as item "2-6. Pulse count does not enter properly".

2-6. Pulse count does not enter properly

1. Intelligent Controller	1-1	Is the distribution group correctly set on the [Settings] → [System Settings] → [Distribution group settings] screen?	Yes	1-2
			No	Apply settings
	1-2	Are you looking at the Cut off data display on the [Oper./Status] → [Accumult/Distrib] → [Pulse acc.] screen? (Are the dates (e.g. 08/01 - 08/31) displayed in the upper right of the screen?)	Yes	Look at the “Current (calculating)” display
			No	1-3
	1-3	When performing time slot totals calculation, is the displayed time slot selection correct? (RglHour (RglHour 1 to 8) / OutOfHours / SpcfdDay / AllHours)	Yes	2-1
			No	Select the correct time slot
2. Communication adaptor	2-1	Is the wiring from the pulse meter correctly connected? Is there a terminal mix-up, disconnection, open circuit, or short circuit? (Pi1 to Pi3 of the 27P terminal board on the MAIN board) Pi1 (7, 8) Pi2 (7, 9) Pi3 (7, 10)	Yes	2-2
			No	Correct wiring
	2-2	Remove all the wiring of the pulse meter from the terminal board, and use a wire, scrap of lead wire, or other appropriate object to short-circuit the input parts (Pi1 to Pi3) of the terminal board several times while looking at the [Pulse acc.] screen of the Intelligent Controller. Does the number of pulses increase correctly? (It may take several minutes to update the display)	Yes	3-1
			No	2-3 2-4
2-3	Replace MAIN board			
2-4	If the distance between the pulse meter and the communication adaptor is 20 m or more, please use a relay. Even if the distance is within 20 m, please use a relay if you are concerned about the effect of noise.			
3. Pulse meter	3-1	Is the wiring to the communication adaptor correct? Is there a terminal on the meter side with a disconnection, open circuit, short circuit or the like?	Yes	3-2
			No	Correct wiring
	3-2	Is the signal line from the pulse meter definitely a no-voltage a contact (relay contact)? * There is polarity in the case of open collector output. (Number 7 is positive, numbers 8, 9, 10 are negative)	Yes	3-3
			No	Correct wiring
	3-3	Remove the wiring from the terminal section, and short-circuit the wires with each other several times while looking at the [Oper./Status] → [Accumult/Distrib] → [Pulse acc.] screen of the Intelligent Controller. Does the number of pulses increase correctly? (It may take several minutes to update the display)	Yes	3-4
			No	Go back to 2-1
3-4	Is there a mistake in connecting the wattmeter and power line, or the gas flow meter and fuel gas pipe?	Yes	3-5	
		No	Reconstruct them correctly	
3-5	Is the power amount or gas flow rate per pulse for this model of pulse meter larger than necessary, or is the setting larger than necessary?	Yes	3-6	
		No	Change meter model, or modify settings	
3-6	Investigate the main unit of the pulse meter			

2-7. Cumulative operation time (or distribution ratio) is counted even though the unit has not been operating

1. Intelligent Controller	1-1	Is the cumulative time zero? (Distribution ratio is counted)	Yes	*1
			No	1-2
	1-2	Did you not operate the unit but “forgot to stop it”?	Yes	(END)
			No	1-3
	1-3	Did the schedule timer or event control work? (Remote controller, other centralised equipment, external input, and so on)	Yes	(END)
			No	1-4
	1-4	Is there evidence of forced operation of an indoor unit from a PC or the like during repair service or maintenance?	Yes	(END)
			No	1-5
	1-5	When performing time slot integration, is the displayed time slot selection correct? (RglHour (RglHour 1 to 8) / OutOfHours / SpcfdDay / AllHours)	Yes	1-6
			No	Select the correct time slot
	1-6	(When using time slot distribution) Are the timer settings and distribution specified day settings correct?	Yes	1-7
			No	Modify settings
	1-7	(When using time slot distribution) Is an OFF timer set at the same time as or close to the switching of the time slot?	Yes	Modify settings *2
			No	

* 1 In the Load Distribution mode, standby power is distributed even without operation.

* 2 Avoid setting the OFF timer within about 10 minutes before the time slot switching time.

2-8. Cannot back up or restore to USB memory device (button is greyed out and cannot be pressed)

1. USB memory device*	1-1	Is the USB memory device properly inserted in the specified place?	Yes	1-2
			No	Insert it
	1-2	Is backup or restoration also impossible with another USB memory device?	Yes	1-3
			No	(END)
	1-3	Replace the Intelligent Controller.		

* USB memory device specifications

Standard type (USB 2.0)

Capacity: 4 GB or more

Precautions for use

- Even if the USB memory device matches the above specifications, operation is not guaranteed.
- USB memory device with encryption function (with security software) cannot be used.

2-9. Intelligent Controller does not start

1. Intelligent Controller does not start

If “now loading ...” ① is displayed or the screen remains black ② even with the power turned on, turn the power OFF once and then turn it back ON again.

If the device does not start up even after turning on the power again, replace the SD card.

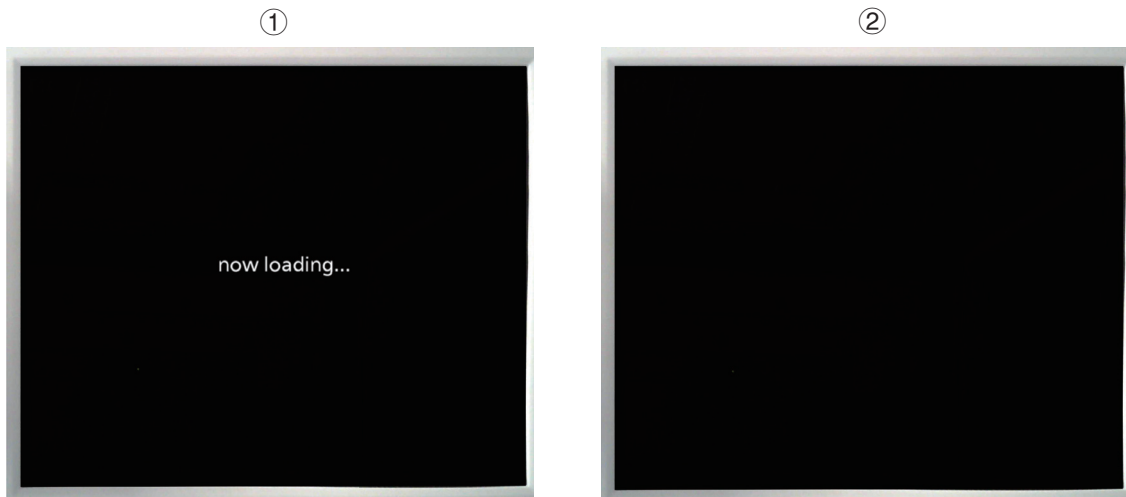

3. Unit operation related

3-1. The Schedule Timer does not work properly

1. Intelligent Controller	1-1	Have you definitely set [Oper./Status] → [Set schedule]?	Yes	1-2
			No	Apply settings
	1-2	Is the timer selected for the indoor unit?	Yes	1-3
			No	Select
	1-3	Is that day set as an area holiday or timer special day for that indoor unit? * Area holidays and timer special days work with a dedicated timer	Yes	(END)
			No	1-4
	1-4	Is the current date / time setting correct?	Yes	1-5
			No	Correct the settings
	1-5	Did the following happen at the time of the timer? · Power outage of indoor unit · Power outage of Intelligent Controller · Power outage of communication adaptor · Communication error with air conditioner due to other causes	Yes	(END)
			No	1-6
1-6	Is it set so that the units in one O/D unit system are in different cooling / warming modes? (Not allowed because of mismatch of heating and cooling)	Yes	Modify timer settings	
		No	1-7	
1-7	Depending on the model, are the settings invalid? (Example: Trying to set a cooling-only model to heating operation)	Yes	Modify timer settings	
		No	1-8	
1-8	Are settings applied that change directly from cooling (dry) to heating (or vice versa)?	Yes	1-10	
		No	1-9	
1-9	Is the timer also used for other equipment (remote controller, Schedule Timer, etc.)?	Yes	Check setting conflict.	
		No		
1-10	Set a timer for [OFF] or [Fan] for one minute before (for example) switching the cooling / heating mode.			

3-2. Unit does not stop (operate) even when Batch stop (startup) input is ON

1. Intelligent Controller or communication adaptor	1-1	Have you definitely set [System Settings] → [Event Control]?	Yes	1-2								
			No	Modify settings								
	1-2	Is the connection of Batch stop (startup) input correct? <table border="1" style="width: 100%; border-collapse: collapse;"> <tr> <td style="width: 50%; text-align: center;">Intelligent Controller 27P terminal board</td> <td style="width: 50%; text-align: center;">Communication Adaptor 20P terminal board</td> </tr> <tr> <td style="text-align: center;">20, 21 (DI1)</td> <td style="text-align: center;">16, 17 (DI1)</td> </tr> <tr> <td style="text-align: center;">20, 22 (DI2)</td> <td style="text-align: center;">16, 18 (DI2)</td> </tr> <tr> <td style="text-align: center;">20, 23 (DI3)</td> <td style="text-align: center;">16, 19 (DI3)</td> </tr> </table> Is there a mistake in the connection, or a disconnection or open circuit?	Intelligent Controller 27P terminal board	Communication Adaptor 20P terminal board	20, 21 (DI1)	16, 17 (DI1)	20, 22 (DI2)	16, 18 (DI2)	20, 23 (DI3)	16, 19 (DI3)	Yes	1-3
			Intelligent Controller 27P terminal board	Communication Adaptor 20P terminal board								
			20, 21 (DI1)	16, 17 (DI1)								
			20, 22 (DI2)	16, 18 (DI2)								
			20, 23 (DI3)	16, 19 (DI3)								
			No	Correct wiring								
	1-3	When the wiring of the Batch stop (startup) input signal is removed from the terminal board and the Batch stop (startup) input part of the terminal board is short-circuited by using an appropriate wire, or broken piece of lead wire, does the unit turn OFF (ON) correctly?	Yes	1-4								
			No	1-5								
1-4	Is the Batch stop (startup) input signal input with no voltage "a" contact or a static signal?	Yes	Go back to 1-2									
		No	Modify									
1-5	On the [Settings] → [System Settings] → [I/D unit settings] screen, ① is there no check mark in the [Register] field, or is it ② [Not managed]?	Yes	Modify settings									
		No	1-6									
1-6	Replace MAIN board of communication adaptor connecting bulk input signal. If only an Intelligent Controller is used, replace the Intelligent Controller.											

3-3 External alarm (operation) output does not turn ON even though unit alarm is detected

1. Intelligent Controller or Communication Adaptor	1-1	Have you definitely set [System Settings] → [Event Control]?	Yes	1-2		
			No	Modify settings		
	1-2	Is the external output wiring properly connected?	Intelligent Controller 27P terminal board	Communication Adaptor 20P terminal board	Yes	1-3
					No	Correct wiring
			17, 18 (DO1)	13, 14 (DO1)		
			17, 19 (DO2)	13, 15 (DO2)		
			Is there disconnection, open circuit, or short circuit?			
	1-3	Is the load side (alarm device, etc.) properly connected? (Contact rating: DC30 V, 0.5 A)	Yes	1-4		
			No	Modify		
	1-4	Is the “unit alarm” one of the following? · Filter cleaning sign · Engine oil Inspection Sign · Remote control Inspection Sign * In the case above, the external bulk warning is not output.	Yes	(END)		
No			1-5			
1-5	Replace MAIN board of communication adaptor connecting bulk output signal. If only an Intelligent Controller is used, replace the Intelligent Controller.					

3-4 Even if remote controller prohibition is set, function settings can be individually changed by the remote controller

1. Intelligent Controller	1-1	Is the centralised address set? (Confirm on the [Settings] → [System Settings] → [I/D unit settings] screen)	Yes	2-1
			No	Apply settings
2. ON / OFF Controller	2-1	The ON / OFF Controller main-sub changeover of the linked ON / OFF Controller (ON / OFF CON) is OFF Is it set to (Main)?	Yes	Set it to ON (Sub)
			No	2-2
	2-2	Is the “centralised control main-sub changeover” of the linked ON / OFF Controller (ON / OFF CON) set to OFF (Main)?	Yes	Set it to ON (Sub)
			No	2-3
	2-3	Replace the ON / OFF Controller		

Display and settings for the communication adaptor board

1. Overview

① Communication adaptor board

- It is possible to display/set using the four keys (HOME/UP/DOWN/SET), 6-digit 7-segment and 2 LEDs (red/green).

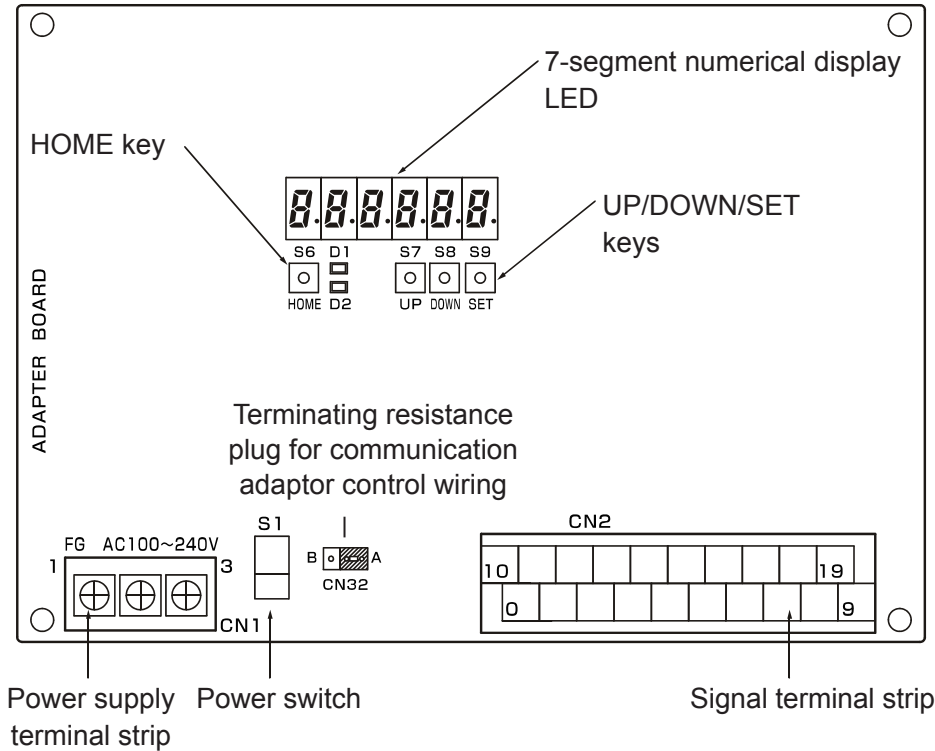

② 7-segment numerical display

Contents	Display	Contents	Display	Contents	Display	Contents	Display
0	0	8	8	G	G	R	R
1	1	9	9	H	H	S	S
2	2	A	A	I	I	T	T
3	3	B	B	J	J	U	U
4	4	C	C	L	L	V	V
5	5	D	D	N	N	Y	Y
6	6	E	E	O	O	—	—
7	7	F	F	P	P		

2. Display immediately after power on

- Immediately after turning on the power of the communication adaptor, all the segments light for 3 seconds, then the microcomputer software version is displayed for 3 seconds, then the normal display is displayed.

Power on

8. 8. 8. 8. 8. 8. (All segments lit: 3 seconds)

V. 3. 0 0 (Microcomputer software version display: 3 seconds)

Indication that air conditioner information is being collected is displayed.

Indication for air conditioner configuration

3. Air conditioner information collection in progress indication

x x. S C A n

(SCAN blinking)
Air conditioner link number (X = 00 to 14)

- In the following case, indication that air conditioner information is being collected is displayed.
 - ① When collecting information from the air conditioner immediately after turning on the power.
 - ② When checking configuration

4. Indication for air conditioner configuration

- While the indication for air conditioner configuration is displayed, information on the configurations of the indoor unit linked system 1 and linked system 2 are alternately displayed for 10 seconds each.
- If the touch switch on the adaptor board is not operated, the indication for air conditioner configuration is normally displayed.

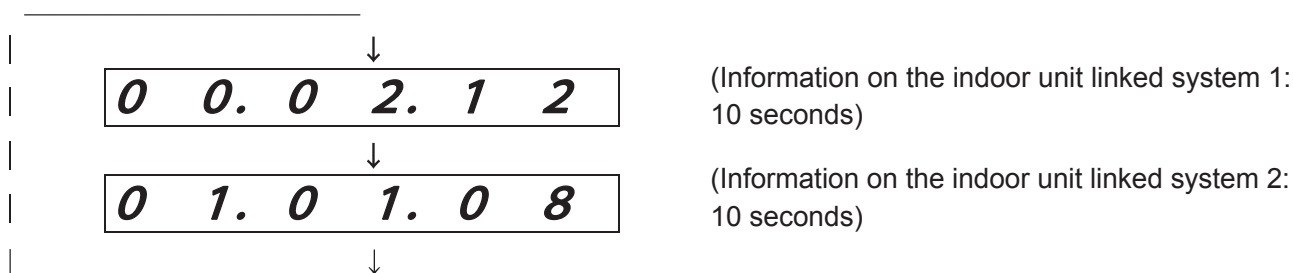

- Content displayed during normal display

Example: When 2 outdoor units and 12 indoor units are connected to the air conditioner LINK 1, and 3 outdoor units and 18 indoor units are connected to the air conditioner linked system 2

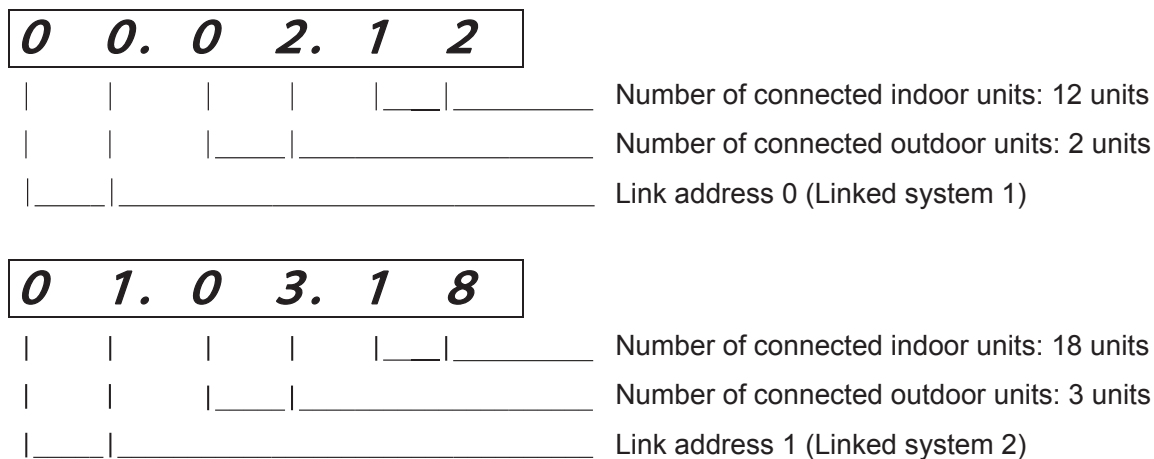

5. System OFF indication

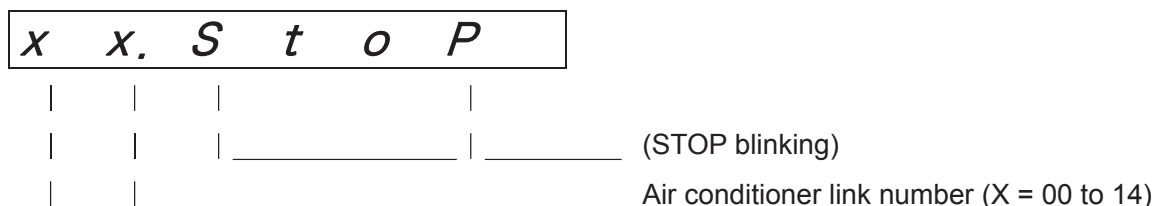

- While the system is OFF, the above is displayed.
- The normal status is restored by restarting the power supply.

6. How to display the microcomputer version

There are two ways to display the microcomputer version.

① Restart power supply of communication adaptor board

- Restart the power switch of the communication adaptor (if it is built in to the Intelligent Controller, restart the switch of the Intelligent Controller).
- The microcomputer version is displayed for 3 seconds immediately after turning on the power (refer to “2. Display immediately after power on”).

② Press the HOME and DOWN keys on the communication adaptor board simultaneously.

While the two keys are pressed, the microcomputer version is displayed.

7. Advanced settings

It is possible to refer to and set detailed data using the four keys on the communication adaptor board.

Main menu	Sub menu
00: Adaptor data display	(* 1)
01: Indoor unit data display	(* 1)
02: Outdoor unit data display	Connection outdoor unit address display
03: Error data display (alarm log)	(* 1)
04: Adaptor data settings	01: Pulse count 1
	02: Pulse count 2
	03: Pulse count 3
	04: Interval for regular communication 2 of air conditioner linked system 1
	05: Interval for regular communication 2 of air conditioner linked system 2
	06: Communication speed
	07: Communication error detection interval
	08: EEPROM initialisation
	09: Software reset
	10: No response settings
	11: Delayed response settings
	12: Outdoor unit maintenance data not required
	13: Centralised address settings
05: Adaptor initial settings	01: Adaptor number
	02: Address valid
	03: Centralised equipment main-sub
	04: Communication adaptor number of air conditioner linked system 1
	05: Communication adaptor number of air conditioner linked system 2
	06: Chattering cancel time
	07: Local adaptor
	08: Initial communication at power on
06: Physical address settings and check	01: Physical address check / individual settings of air conditioner linked system 1
	02: Physical address check / individual settings of air conditioner linked system 2
	03: Clear the physical address of all indoor units of air conditioner linked system 1
	04: Clear the physical address of all indoor units of air conditioner linked system 2
	05: Automatic settings of physical address of all indoor units of air conditioner linked system 1
	06: Automatic settings of physical address of all indoor units of air conditioner linked system 2
07:	(* 1)

(* 1) There are currently no items to display.

■ Main menu display

- Press and hold the HOME key for 2 seconds or longer to display the menu display (level 0) screen.

n o . 0 0

In this status, the UP key or DOWN key can be pressed to select an item from the main menu.

On the main menu, 00 to 07 in the table below can be selected.

- The main menu item number is displayed during and for 2 seconds after item change, and then the board display content in the table below is displayed.
- If an item (00 - 07) is selected and the SET key is pressed, the screen will shift to the detailed display screen for that item.

	Main menu item	Board display content	Overview
↑ DOWN	00	<i>A d P . d t</i>	Adaptor data display (*1)
	01	<i>i n . d t</i>	Indoor unit data display (*1)
	02	<i>o u t . d t</i>	Outdoor unit data display
	03	<i>E r r . d t</i>	Error data display (alarm log) (*1)
UP ↓	04	<i>A d P . S E t</i>	Adaptor data settings
	05	<i>F i r S t</i>	Adaptor initial settings
	06	<i>P H y S i C</i>	Physical address settings and check
	07	<i>d A t E</i>	Date settings and display

(* 1) There are currently no items to display.

- Even during detailed settings, if you press and hold the HOME key, it will return to the main menu selection.
(Content in the process of being set will be discarded.)
- If there is no operation for 30 seconds, the unit returns to the indication for air conditioner configuration.
(Content in the process of being set will be discarded.)

■ (02) Outdoor unit data display

- This screen is not used normally; it is used when you want to add special specifications to a particular outdoor unit model.
- On the main menu screen, select (02: outdoor unit data display) and press the SET key to display the data of the currently connected outdoor unit.
If there is no operation for 30 seconds, the unit returns to normal display.

	Air conditioner link address	Outdoor unit No.	Board display
↑ DOWN	XX	Outdoor unit No. 1	X X. 0 1. Z Z
		Outdoor unit No. 2	X X. 0 2. Z Z
		:	:
		Outdoor unit No. 30	X X. 3 0. Z Z
UP ↓	YY	Outdoor unit No. 1	Y Y. 0 1. Z Z
		Outdoor unit No. 2	Y Y. 0 2. Z Z
		:	:
		Outdoor unit No. 30	Y Y. 3 0. Z Z

- ZZ is an outdoor unit model. The factory setting of the communication adaptor is 0.
ZZ cannot be changed by communication adaptor board operation.
- An outdoor unit with a value between 80 and 82 registered can acquire maintenance data and send it to the higher software.

ZZ	Outdoor unit
80	T-type Eco-multi
81	T-type W Eco-multi
82	T-type 3WAY
0	Outdoor units other than the above

■ (04) Adaptor data settings

• This screen is for browsing and changing the internal data of the communication adaptor and is not normally used.

• If (04: Adaptor settings) is selected on the main menu and the SET key is pressed, a screen with current detailed information on the communication adaptor is displayed.

If there is no operation for 30 seconds, the unit returns to normal display.

• Use the UP and DOWN keys to browse/set necessary data from the following items.

Select a data number using the UP and DOWN keys to display the data.

Data display example 1. 1 2 3 4 5

↑ ↑ _____ ↑ _____

The characters to the right of the point are the data.

| _____

Data number

• Adaptor detailed data

	Data number	Item	Display	Remarks
↑ DOWN	1	Pulse count 1	1. 2 3 4 5	2345 times
	2	Pulse count 2	2. 2 3 4 5	2345 times
	3	Pulse count 3	3. 2 3 4	234 times
	4	Interval for regular communication 2 of air conditioner linked system 1	4. t 2. 1. 1 8	18 minutes
	5	Interval for regular communication 2 of air conditioner linked system 2	5. t 2. 1. 1 8	18 minutes
UP ↓	6	Communication speed	6. 1 9 2 0 0	19200 BPS
	7	Communication error detection	7. E r r. 1 0	10 minutes
	8	EEPROM initialisation	8. E E P C L	
	9	Reset	9. r E S E t	
	10	No response settings	1 0. n o r. 0	
	11	Delayed response	1 1. d L. 2 0	20 msec
	12	No maintenance data required	1 2. n o d. 0	
	13	Central address settings	1 3. S C S t	

(04–01) Pulse count 1

(04–02) Pulse count 2

(04–03) Pulse count 3

- Displays the current pulse count (P1, P2, P3).
- If the pulse count value is changed, the distribution function of the Intelligent Controller will not operate properly.

[How to change]

- ① Press and hold the SET key for at least 1 second and the pulse count value blinks.
- ② Press the UP or DOWN key to change it to the pulse count value you want to set.
(Changeable range: 0 to 65535)
- ③ Press and hold the SET key and when the display changes from blinking to lit, the change is completed.

(04–04) Interval for regular communication 2 of air conditioner linked system 1

(04–05) Interval for regular communication 2 of air conditioner linked system 2

- Displays the interval for the air conditioner regular communication 2.
- At factory shipment, the interval for regular communication 2 is 18 minutes.

[How to change]

- ① Press and hold the SET key for at least 1 second and the regular communication interval (minutes) will blink.
- ② Press the UP or DOWN key to change it to the regular communication interval you want to set.
(Changeable range: 0 to 99)
- ③ Press and hold the SET key. When the display changes from blinking to lit, the change is completed.

- Air conditioner regular communication 2 is not performed when 0 minutes is set.

(04–06) Communication speed

- Displays the communication speed of the communication adaptor control wiring.
- The factory setting is 19,200 BPS.
- The following BPS can be selected.
 - ① 19200 BPS ... Intelligent Controller (Do not change from this setting)
 - ② 9600 BPS ... AMY software

[How to change]

- ① Press and hold the SET key for at least 1 second and the BPS value blinks.
- ② Press the UP or DOWN key to display 19200 and 9600 alternately.
- ③ Press and hold the SET key. When the display changes from blinking to lit, the change is completed.
- ④ It becomes valid after power supply restart of the communication adaptor board.

(04–07) Communication error detection interval

- Displays the time (minutes) until judging that a communication error with the air conditioner has occurred.
- The factory setting is 10 minutes.
- It can be set in the range from 0 to 99 minutes.
- If it is set to 0 minutes, communication error detection will not be performed.

(04–08) EEPROM initialisation

- Use this to restore the EEPROM to the factory settings.
- EEPROM initial values list

Pulse count 1	0
Pulse count 2	0
Pulse count 3	0
Address on air conditioner linked system 1	0x150
Address on air conditioner linked system 2	0x151
Address for air conditioner linked system 1 on communication adaptor control wiring	0x00
Address for air conditioner linked system 2 on communication adaptor control wiring	0x01
Presence/absence of air conditioner connection to indoor unit or outdoor unit communication wire	Air conditioner linked system 1: Yes Air conditioner linked system 2: Yes
Centralised equipment main-sub	Air conditioner linked system 1: Main Air conditioner linked system 2: Main
Presence of local adaptor	Air conditioner linked system 1: Yes Air conditioner linked system 2: Yes
Check of air conditioner configuration at power on	Air conditioner linked system 1: No Air conditioner linked system 2: No
Response to RS485	Air conditioner linked system 1: Yes Air conditioner linked system 2: Yes
Adaptor number	0
Pulse input chattering cancel time	100 msec
Communication speed of RS485	19200 BPS
Interval for air conditioner regular communication 2	Air conditioner linked system 1: 18 minutes Air conditioner linked system 2: 18 minutes
Time until air conditioner communication error detection	10 minutes
Reset count	0

[EEPROM initialisation method]

- ① Press and hold the SET key for at least 1 second.
- ② If all segments of the 7-segment numerical display light up, EEPROM initialisation is completed.

(04–09) Software reset

[Reset method]

- ① Press and hold the SET key for at least 1 second.
- ② Reset is completed if all segments of the 7-segment numerical display light up.

(04–10) No response settings

- Sets whether to respond to request data from the communication adaptor control wiring.

[How to change]

- ① Press and hold the SET key for at least 1 second and the setting value blinks.
- ② Press the UP or DOWN key to change the setting value in the order of 0 → 1 → 2 → 3 → 0 →

Setting value	HBS1	HBS2
0 (factory default)	Responds	Responds
1	Responds	Does not respond
2	Does not respond	Responds
3	Does not respond	Does not respond

- ③ Press and hold the SET key. When the display changes from blinking to lit, the change is completed.
- ④ Valid after power restart.

(04–11) Delayed response settings

- Send response data xx milliseconds after receiving data from the communication adaptor control wiring.
(xx: factory default is 20 milliseconds)
- Changing this setting may prevent communication with devices such as Intelligent Controller.

[How to change]

- ① Press and hold the SET key for at least 1 second and the response delay time (milliseconds) will blink.
- ② Press the UP or DOWN key to change it to the delayed response time you want to set.
(Changeable range: 0 to 99)
- ③ Press and hold the SET key. When the display changes from blinking to lit, the change is completed.

(04–12) Outdoor unit maintenance data not required

- Use to reduce communication load by not acquiring outdoor unit data.
- At factory shipment, it is set to acquire outdoor unit data.

[How to change]

- ① Press and hold the SET key for at least 1 second and the rightmost digit '0' flashes.
- ② Press the UP or DOWN key and '0' and '1' are alternately displayed.

0	Acquire outdoor unit maintenance data.
1	Do not acquire outdoor unit maintenance data.

- ③ Press and hold the SET key. When the display changes from blinking to lit, the change is completed.

(04–13) Central address settings

- Use this when forcibly setting a central address to an indoor unit for which a central address is not set.

[Central address setting method]

- ① Press and hold the SET key for at least 1 second.
- ② If END is displayed on the 7-segment numerical display, the setting is completed.

(It is automatically set in order of indoor unit address in the range of 1 to 64)

- * The central address of already set units is not changed.

Set unused central addresses in the order of address of unconfigured units.

■ (05) Communication adaptor initial settings

Press the UP or DOWN key to select a function from the following options.

	Display	Function
↑ DOWN UP ↓	1. A n o. x x	Adaptor number
	2. A d Y u. x	Address valid
	3. C o n t. x	Centralised equipment main-sub
	4. C A n 1. x	Communication adaptor number of air conditioner linked system 1
	5. C A n 2. x	Communication adaptor number of air conditioner linked system 2
	6. P U L. x x	Chattering cancel time
	7. L o C A. x	Local adaptor
	8. S C A n. x	Initial communication at power on

(05–01) Adaptor number

- The factory default is 0.
- It is the address on the communication adaptor control wiring.
- Set it in the range of 0 to 15.

[How to change]

- ① Press and hold the SET key for at least 1 second and the adaptor number blinks.
- ② Press the UP or DOWN key to display the adaptor number you want to set.
(Make sure not to duplicate addresses.)
- ③ Press and hold the SET key and when the display changes from blinking to lit, the change is completed.

(05–02) Address valid

- Set whether the air conditioner is connected to air conditioner linked systems 1 or 2.

Address valid	Air conditioner linked systems 1	Air conditioner linked systems 2
0 (factory default)	Air conditioner connected	Air conditioner connected
1	Air conditioner connected	Air conditioner not connected
2	Air conditioner not connected	Air conditioner connected
3	Air conditioner not connected	Air conditioner not connected

[How to change]

- ① Press and hold the SET key for at least 1 second and the address valid data blinks.
- ② Press the UP or DOWN key to display the value you want to set.
(Select from 0 to 3 in the table above.)
- ③ Press and hold the SET key and when the display changes from blinking to lit, the change is completed.

(05–03) Centralised device main-sub

- Set main and sub of the centralised control.

Address valid	Air conditioner linked systems 1	Air conditioner linked systems 2
0 (factory default)	Main	Main
1	Main	Sub
2	Sub	Main
3	Sub	Sub

[How to change]

- ① Press and hold the SET key for at least 1 second and the main/sub setting data of centralised control blinks.
- ② Press the UP or DOWN key to display the value you want to set.
(Select from 0 to 3 in the table above.)
- ③ Press and hold the SET key and when the display changes from blinking to lit, the change is completed.

(05–04) Communication adaptor number of air conditioner linked system 1

- When there are two or more communication adaptors on the air conditioner linked system, set the communication adaptor number so as to avoid address duplication.

Communication adaptor number	Contents
0 (factory default)	First communication adaptor to the indoor / outdoor communication wire
1	Second communication adaptor to the indoor / outdoor communication wire
:	:
7	Eighth communication adaptor to the indoor / outdoor communication wire

[How to change]

- ① Press and hold the SET key for at least 1 second and the communication adaptor number blinks.
- ② Press the UP or DOWN key to display the value you want to set.
(Select from 0 to 7 in the table above.)
- ③ Press and hold the SET key and when the display changes from blinking to lit, the change is completed.

(05–05) Communication adaptor number of air conditioner linked system 2

- When there are two or more communication adaptors on the air conditioner link, set the communication adaptor number so as to avoid address duplication.

Communication adaptor number	Contents
0 (factory default)	First communication adaptor to the indoor / outdoor communication wire
1	Second communication adaptor to the indoor / outdoor communication wire
:	:
7	Eighth communication adaptor to the indoor / outdoor communication wire

[How to change]

- ① Press and hold the SET key for at least 1 second and the communication adaptor number blinks.
- ② Press the UP or DOWN key to display the value you want to set.
(Select from 0 to 7 in the table above.)
- ③ Press and hold the SET key and when the display changes from blinking to lit, the change is completed.

(05–06) Chattering cancel time

- Set the chattering cancel time.

Communication adaptor number	Described in manual	Capability
03	30 msec	24 msec
10 (factory default)	100 msec	80 msec

[How to change]

- ① Press and hold the SET key for at least 1 second and the chattering cancel time blinks.
- ② Press the UP or DOWN key to display 03 and 10 alternately.
- ③ Press and hold the SET key and when the display changes from blinking to lit, the change is completed.

(05–07) Local adaptor

- In systems without a local adaptor, it is possible to delete the local adaptor detection during configuration check.

Local adaptor detection during configuration check	Air conditioner linked system 1	Air conditioner linked system 2
0 (factory default)	Yes	Yes
1	No	Yes
2	Yes	No
3	No	No

[How to change]

- ① Press and hold the SET key for at least 1 second and the data blinks.
- ② Press the UP or DOWN key to display the value you want to set.
(Select from 0 to 3 in the table above.)
- ③ Press and hold the SET key and when the display changes from blinking to lit, the change is completed.

(05–08) Initial communication at power on

Initial communication at power on	Air conditioner linked system 1	Air conditioner linked system 2
0 (factory default)	No	No
1	Yes	No
2	No	Yes
3	Yes	Yes

[How to change]

- ① Press and hold the SET key for at least 1 second and the data blinks.
- ② Press the UP or DOWN key to display the value you want to set.
(Select from 0 to 3 in the table above.)
- ③ Press and hold the SET key and when the display changes from blinking to lit, the change is completed.

■ (06) Physical address settings and check

Normally, it is not necessary to check/set the physical address.

	Display	Function
↑ DOWN	1. P 1. C H E	Physical address check / individual setting of air conditioner linked system 1
	2. P 2. C H E	Physical address check / individual setting of air conditioner linked system 2
	3. P 1. C L r	Clear the physical address of all indoor units of air conditioner linked system 1
UP ↓	4. P 2. C L r	Clear the physical address of all indoor units of air conditioner linked system 2
	5. P 1. A L L	Automatic physical address setting of all indoor units of air conditioner linked system 1
	6. P 2. A L L	Automatic physical address setting of all indoor units of air conditioner linked system 2

(06-01) Physical address check / individual setting of air conditioner linked system 1

(06-02) Physical address check / individual setting of air conditioner linked system 2

- Check screen

0 1. 0 5. 0 5

| | | | |__|_____ Physical address

| | |__|_____ Indoor unit number

|__|_____ System address

- Press the UP or DOWN key on the check screen to confirm the physical addresses of all indoor units.
- Press and hold the SET key for at least 1 second on the check screen to display the individual settings screen.

0 1. 0 5. 0 5

| | | | |__|_____ Blinking: Physical address

| | |__|_____ Lit: Indoor unit number

|__|_____ Lit: System address

- On the individual settings screen, press the UP or DOWN key to change it to the physical address you want to set.

(Changeable range: 0 to 99)

- Press and hold the SET key and when the display changes from blinking to lit, the change is completed.

(06–03) Clear the physical address of all indoor units of air conditioner linked system 1

(06–04) Clear the physical address of all indoor units of air conditioner linked system 2

- Press and hold the SET key for at least 1 second on the Physical Address Clear screen and the physical address of all connected indoor units is cleared.

(06–05) Automatic physical address setting of all indoor units of air conditioner linked system 1

(06–06) Automatic physical address setting of all indoor units of air conditioner linked system 2

- Press and hold the SET key for at least 1 second on the Physical Address Auto Settings screen and the physical address of all connected indoor units is automatically set in the order of indoor unit address in the range of 1 to 64.

* The physical address of already-set units is not changed.

Set unused physical addresses in the order of addresses of unconfigured units.

■ (07)

There is no function for this item.

Communication adaptor microcomputer rewrite procedure

1. Things to prepare

- | | |
|-------------------------------------|---------------------|
| ① Communication adaptor [CZ-CFUNC2] | |
| ② Flash Writer 3 (software written) | Factory procurement |
| ③ 12 V power supply | Factory procurement |
| ④ Dedicated wiring | Factory procurement |

2. Communication adaptor board software rewriting method

- ① Wire as shown below and turn on the power.

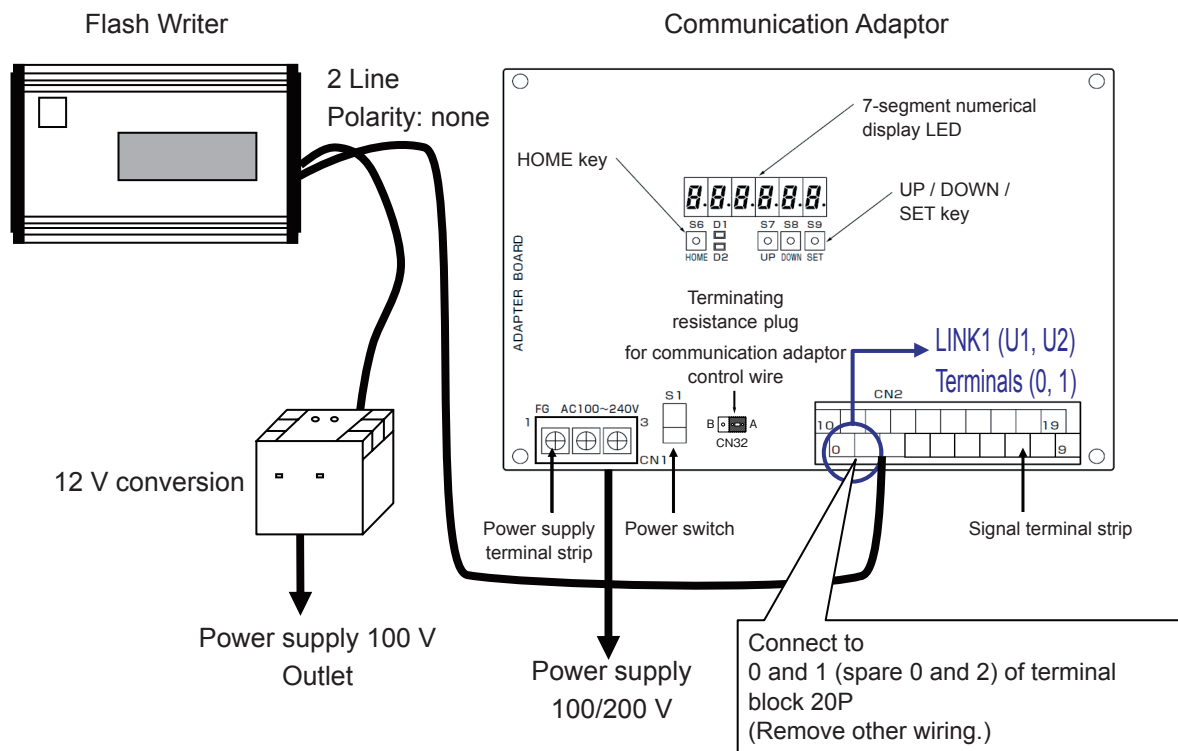

- ② Press the button of Flash Writer 3. Software rewrite starts.
The rewrite time is 3 minutes 50 seconds. Progress is indicated as a percentage (%).
- ③ If [Completed!] is displayed on the Flash Writer 3 screen, rewriting is completed.
Turn off the power supply.

3. How to check the version of the communication adaptor microcomputer

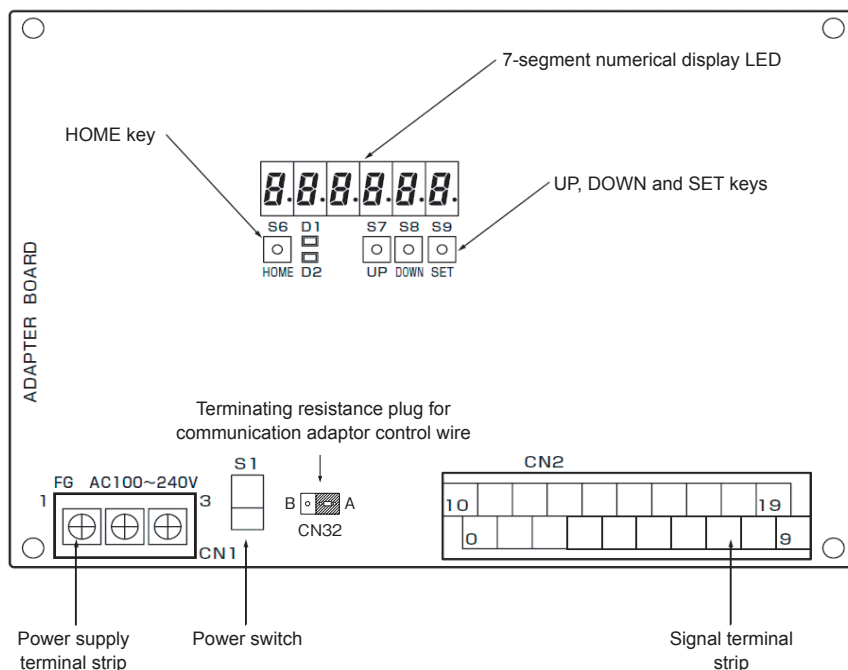

① Checking method using touch buttons

Press the HOME key and DOWN key at the same time.

The communication adaptor version is displayed on the 7-segment numerical display.

[Example] If version 4.62

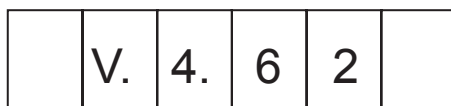

② Checking method using power supply restart

Restart the power supply of the communication adaptor.

Immediately after turning on the power of the communication adaptor, all segments of the numerical display (888888) will light up for 3 seconds, then the version will be displayed for 3 seconds.

Intelligent Controller software update procedure

The software is updated from the USB memory device.
A service engineer should perform this operation.

1. Open the storage door and insert the USB memory device into the USB terminal.

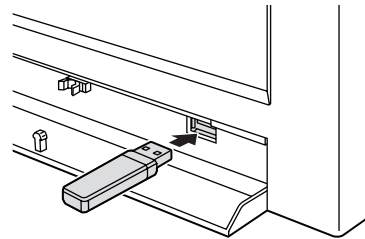

2. Touch [IntlgCtrlr maintnce] in [Settings].

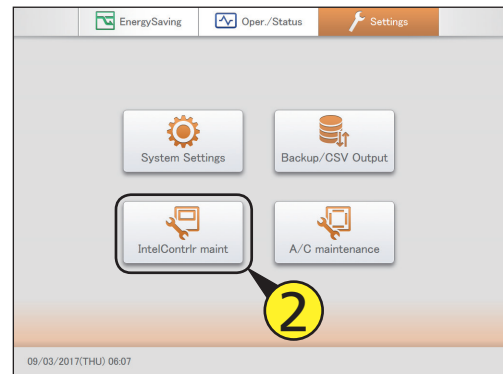

3. Touch [Software update].

- The [Software update] screen is displayed.



4. Select the version to update (4-1), then touch [Start] (4-2).

- The software update confirmation message is displayed.

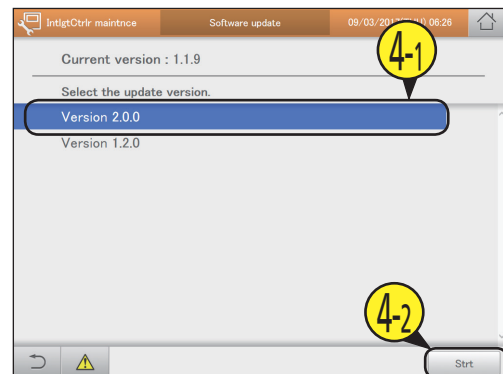

5. Touch [OK].

- The confirmation message is displayed again.
- To cancel the update, touch [Cancel].

6. Touch [Update].

- Start updating the software. During the update, the progress status is displayed.
- When the update is completed, the unit will restart automatically.

Replacement of SD card, and operation procedure at time of failure

The operation procedure is different depending on the type of SD device and SD card. Always replace the SD card according to the replacement procedure of the SD card you want to replace. If you perform SD card copy, database switch operation, etc. without following the operation procedure, it will cause data loss or damage, which will not be possible to recover from, so please observe caution.

●●● Caution ●●● (Cause of malfunction!)

- Do not insert or remove the SD card while working or with the power turned on.
- Be sure to turn off the power before each time the SD card is replaced (or switched between slots 1 and 2) during operation.
- Do not forcibly remove the USB memory device except if instructed to do so on the screen. Doing so may cause data corruption.

If you have started the Intelligent Controller normally without removing the USB memory device, please push down on the USB removal button on the normal screen and remove it.

- When replacing the SD card, turn off the power of the main unit, set the DIP switch (SW7) 3 on the main board to ON, and turn on the main unit. To return to the normal screen, turn off the main unit, set the DIP switch (SW7) 3 to OFF, and turn on the main unit.

Normal mode

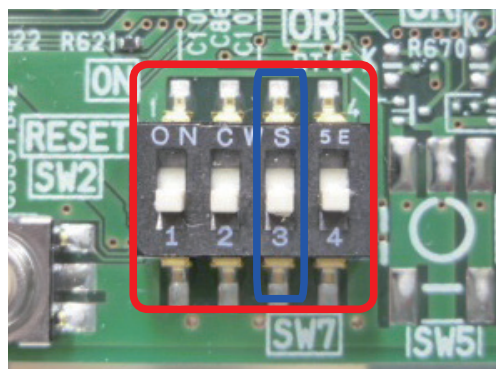

SD card exchange mode

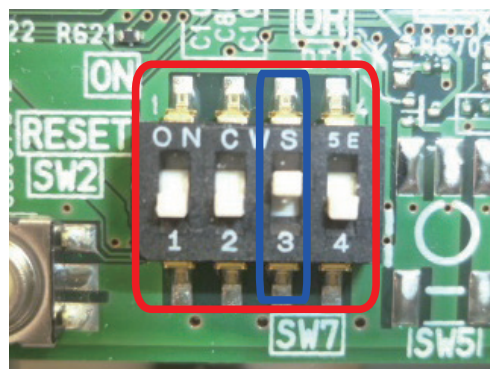

When starting up with SW7 3 set to ON, the following screen starts up.

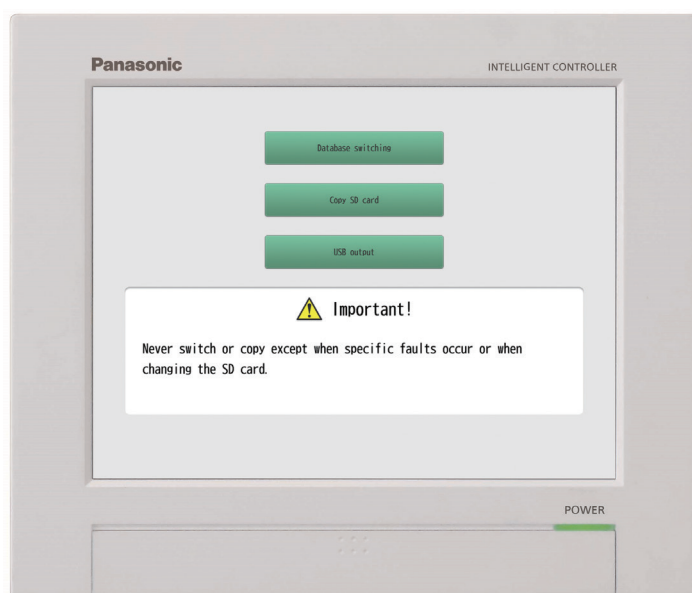

• Definition of terms

Two SD devices are built-in to the Intelligent Controller.

Since SD cards of different types (SLC/MLC) are inserted into each device, we will explain based on the following definition of terms.

Term	Description
Main SD card	A high durability SLC SD card In normal operation, it is used as the storage location for main data.
Sub SD card	A standard durability MLC SD card In normal operation, it is used as the backup storage location. * If the main SD card fails, as an emergency measure you can temporarily operate the unit by switching the database mode so that the sub SD card is used as the main SD card (master database). (*1)
SD device 1	It is used as the main SD card device.
SD device 2	It is used as the sub SD card device.
Master database	This is the database mode to set the SD card inserted in SD device 1. When used as the main SD card, it is a mandatory settings mode.
Replication database	This is the database mode to set the SD card inserted in SD device 2. When used as the sub SD card, it is a mandatory settings mode.

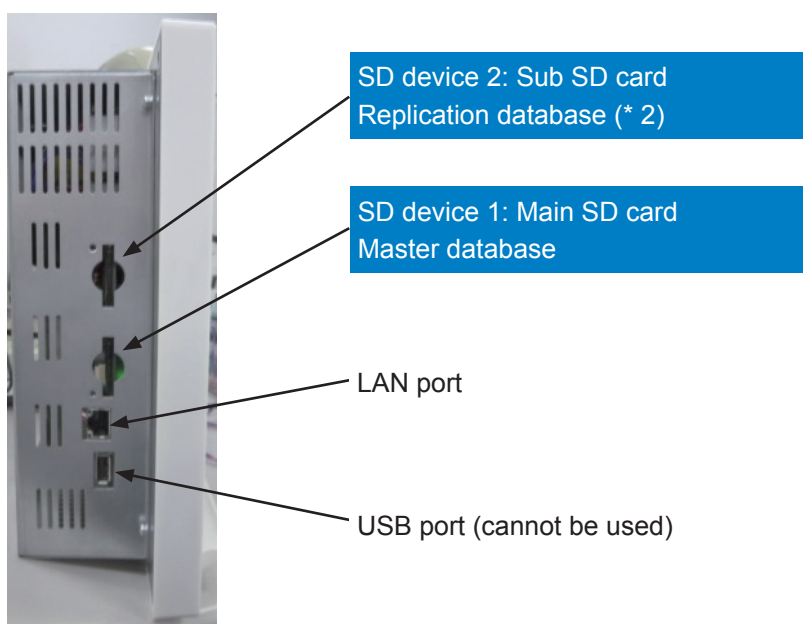

*1: In temporary operation, insert the sub SD card that was being used in SD device 2 into SD device 1, and switch to master database mode to operate the unit. In this case, backups will not be made because there is no SD card inserted in SD device 2, and the unit is operated with one SD card (SD device 1 only). If the SD card fails under temporary operation, the data cannot be restored. Temporary operation is for temporary use. Promptly replace the service parts of the main SD card of SD device 1.

*2: The sub SD card is allowed to be used only for temporary operation. Insert the sub SD card in SD device 1 and switch the mode to master database in accordance with the operation procedure.

• Description of operation procedure

After inserting the media correctly in SD device 1 and SD device 2, follow the procedure described below, and execute by pressing the ① “Database switch” or ② “Copy SD card” button.

After pressing the button, execute the process according to the screen message.

① Database switch

Change the settings so that SD device 1 (with SD card inserted) is the master database, and SD device 2 is in replication database mode.

SD insertion (○: insert)		State of the database mode of the SD card after database switch process	
SD device 1	SD device 2	SD card of device 1	SD card of device 2
○	○	Master database	Replication database
○	×	Master database	-
×	○	-	-

* Regardless of the SD card type (SLC/MLC), the database mode will be set according to the devices where they are inserted.

② SD card copy

The contents of the SD card inserted in SD device 1 will be completely copied to the SD card inserted in SD device 2.

* The unit cannot be operated with just copying. Follow the procedure to change the database mode correctly using the “database switch” process.

③ USB output (* not used in the SD card exchange process)

Back up (extract) only the master database of SD1 onto the USB memory device.

* Insert the USB memory device correctly in the front USB terminal. (The side USB port can not be used)

* You can not restore from this backup (extracted) database file.

* Do not use this output function unless it is necessary.

Properly execute the procedure according to the SD card you want to replace, based on the operation procedure of ① to ② in the operating procedure description.

【Power ON/OFF】 : Turn on/off the power of the Intelligent Controller unit

【DPSW ON/OFF】 : Turn on/off DIP switch (SW7) 3

【New SD card】 : A special formatted SD card which can be obtained as a service parts. Commercial SD cards cannot be used.

● Procedures for failure and replacement of the main SD card

For replacement, a main SD card (SLC) as a service part is required. In the following table, it is described as “new SD card”.

Procedure	For main SD card failure/replacement (after acquiring service parts) When returning from temporary operation of the sub SD card to normal operation (after acquiring service parts)	Temporary operation with sub SD card
1	Power OFF	Power OFF
2	Insert the SD cards as follows. SD device 1: SD card of SD device 2 SD device 2: New SD card	Insert the SD cards as follows. SD device 1: SD card of SD device 2 SD device 2: None
3	DPSW ON	DPSW ON
4	Power ON	Power ON
5	SD card copy (procedure ②)	Database switch
6	Power OFF	Power OFF
7	Insert the SD cards as follows. SD device 1: New SD card SD device 2: SD card of device 2	DPSW OFF
8	Power ON	Power ON (normal startup in temporary operation)
9	Database switch (procedure ①)	
10	Power OFF	
11	DPSW OFF	
12	Power ON (normal startup)	

* The sub SD card will be used from the backup point (once a day).

● Procedure for failure and replacement of the sub SD card

A sub SD card (MLC) as a service part is required. In the following table, it is described as “new SD card”.

Procedure	For sub SD card failure/replacement
1	Power OFF
2	SD device 1: SD card of SD device 1 SD device 2: New SD card
3	DPSW ON
4	Power ON
5	SD card copy (procedure ②)
6	Database switch (procedure ①)
7	Power OFF
8	DPSW OFF
9	Power ON (normal startup)

Procedure for replacing touch panel LCD

Procedure manual for replacing the LCD panel with touch panel of the Intelligent Controller.

- * Remove the power cable, etc., and do the work with the main unit removed from the incorporated control board, etc.
- * The touch panel is integrated with the LCD.

① Remove the resin front panel. (Two countersunk screws)

As shown in the figure below, remove the two screws on the bottom left and right sides, and lift the bottom side to remove the front panel.

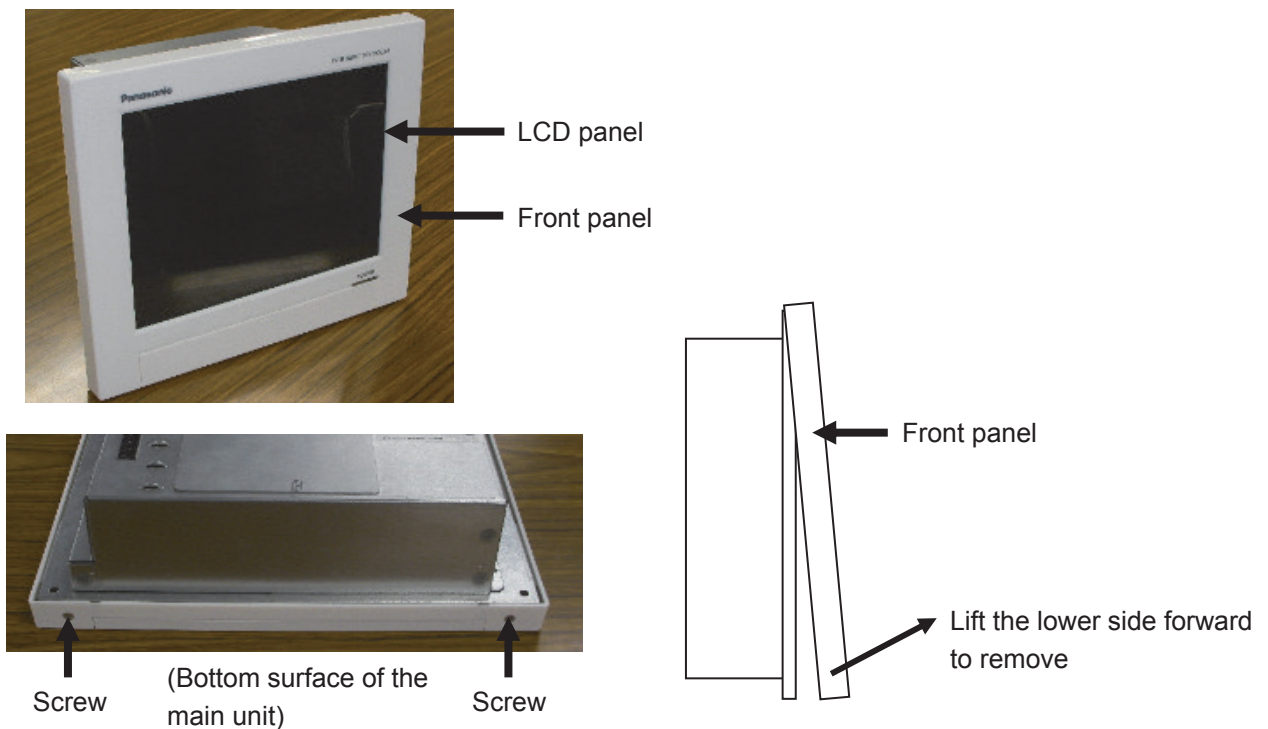

② Remove the sheet metal on the back of the main unit. (Four screws)

Remove the four screws (left and right sides) of the sheet metal as shown in the figure below.



- ③ Remove the LCD and touch panel connectors. (Three places)

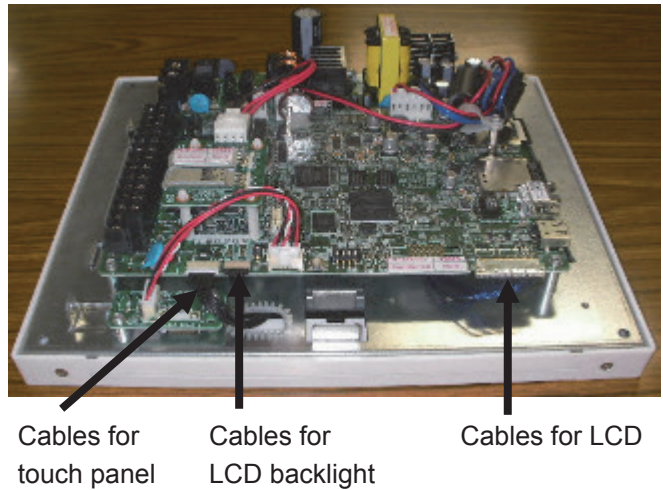

- ④ Temporarily mount the sheet metal on the back of the main unit (screw fastening not required), remove the screws on the sides of the LCD with the LCD facing up. (Four places)

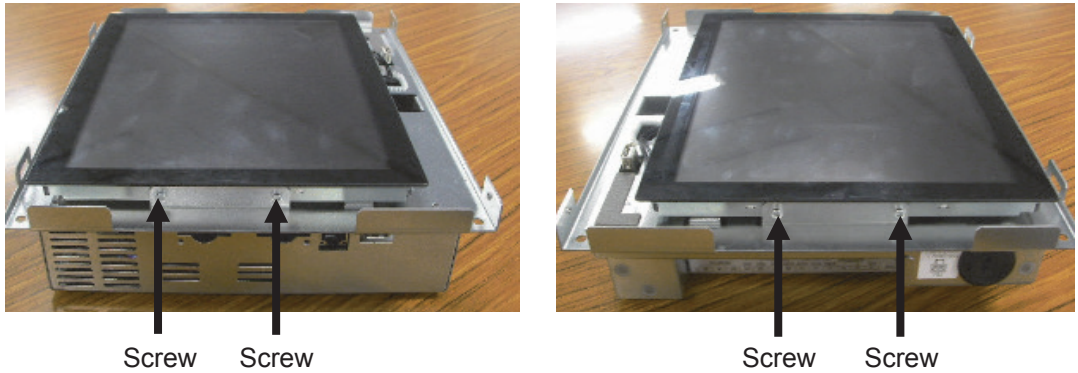

- ⑤ Lift the front side of the LCD forward and pull out the three cables.

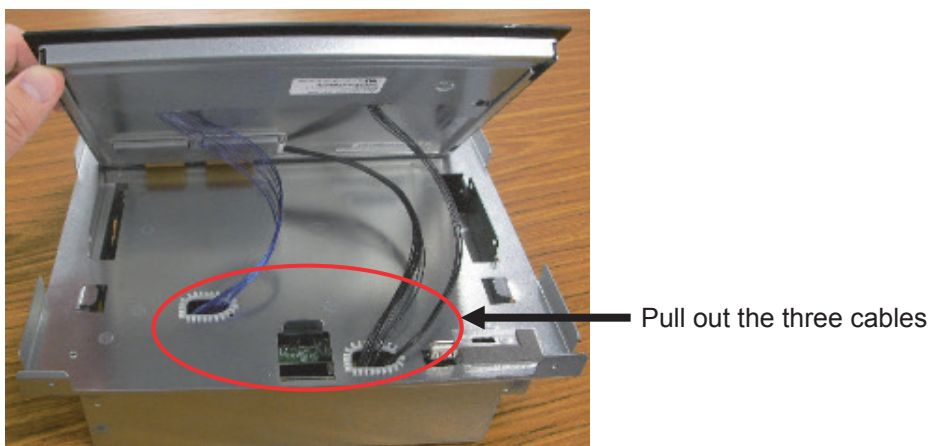

⑥ Remove the following cables and replace the LCD.

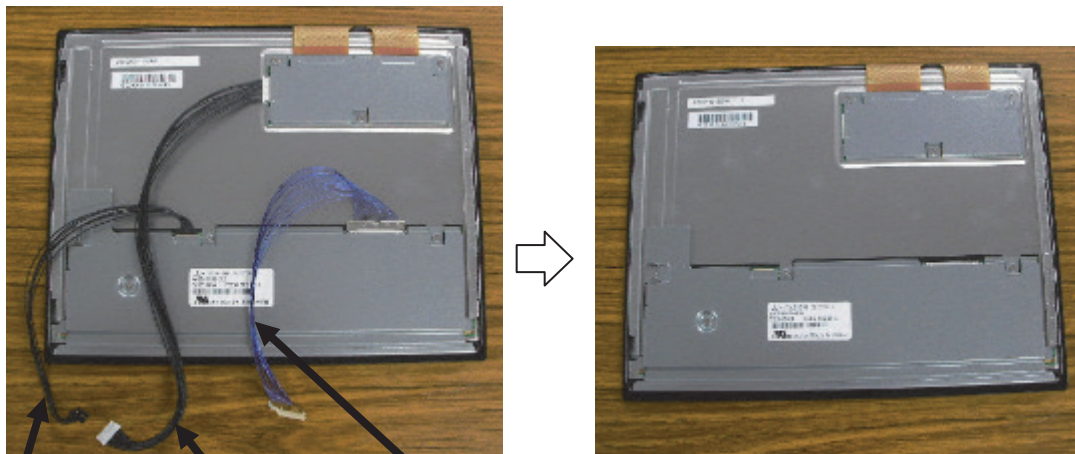

Cables for
LCD backlight

Cables for
touch panel

Cables for LCD

⑦ Assembly is done by reversing the above procedure.

- * Pass the cable through the hole in the original sheet metal.
- * Be careful that the cable does not get caught during assembly.

Procedure when adding/removing a unit

When adding, removing or relocating units managed by the Intelligent Controller (indoor units, outdoor units, and local adaptors), problems may occur such as with centralised control and air conditioning distribution calculation unless the settings and registration are changed for the Intelligent Controller.

Take adequate care, since the necessary work varies case by case.

- * In the linked system (or adaptor system), if you simply move the physical installation location, there is no need to reapply the settings.

■ Flow of overall work (*1)

First of all, distribution calculation is done in the state before work.

(Specify the date of the current day as the end day using [Oper./Status] → [Accumult/Distrib] → [Distribution data].)

Add, remove, and relocate the units, complete necessary address settings, etc. and confirm normal operation as an air conditioner

- * The [Config. change] warning may be displayed on the Intelligent Controller screen, but do not operate the screen until the air conditioner work is complete.

↓

After completing the work on the air conditioner, perform [Check configuration] with the Intelligent Controller

↓

After a short period of time, [Config. has been chngd] is displayed.

↓

When prompted with [Confirm configuration?], select [Begin config]

↓

When the check configuration process is complete, confirm the indoor address display (On the [Settings] / [System settings] / [I/D unit settings] screen, etc.)

↓

Make necessary changes to settings, such as the area settings and unit name according to the modification work.

Be sure to set the central address for added units

↓

Make backup and end (① Insert USB memory device in USB terminal → ② [Backup/CSV output] in [Settings] → ③ [Backup] → ⑤ Save to USB memory device)

* The number is the number of the Intelligent Controller operating instructions.

*1

If distribution calculation is required:

In cases where distribution processing is affected by the addition, removal, or relocation of indoor units, distribution calculation is always required.

For example,

- Addition of indoor units to area
- Removal of indoor units from area
- Relocation of indoor units between areas
- Partition change of area

On the other hand, distribution processing may not be affected in some cases.

For example,

- Addition/removal/relocation of units not subject to distribution (shared parts, etc.)
- Addition/removal/relocation of units in vacant rooms (area not registered)
- Physical relocation within an area (there is also no [Config. change])

In such cases, distribution calculation is not required.

Procedure when entering or leaving an area mid-period

If occupants move into or move out from an area while doing air conditioning distribution or charge distribution, unless the work for that is performed, note that it will affect the distribution of the other areas.

■ Ideally

Ideally, occupants should move in or move out the next day after the cutoff day (that is, after the cutoff is over) and then the settings work for addition or removal of area should be performed immediately.

If occupants move in or out without waiting for the cutoff day, perform the work as follows.

■ In the case that occupants move out from the area mid-period

- (1) Calculate the distribution on the day of moving out. (Specify the date of the current day as the end day using [Oper./Status] → [Accumult/Distrib] → [Distribution data].)
- (2) For the area from which occupants have moved out, process the billing with the usage amount based on the cutoff data.
- (3) Delete the area from which occupants have moved out from the settings of the area number, area name, distribution group, etc.
- (4) Wait for the normal cutoff day and calculate the monthly usage amount by summing up the data for two times in each area together with the distribution calculation of (1) for that month only.
 - * If it is obvious that nobody will move into the vacated area by the next cutoff day (such that the air conditioners will not be used), it is possible to wait until the next cutoff day while keeping the last billing processing on hold, then carry out billing processing in the same way as other areas according to the cutoff day. Then perform (3) above.

■ In the case that occupants move into the area at the period

- (1) Calculate the distribution on the day before moving in. (Specify the date of the current day as the end day using [Oper./Status] → [Accumult/Distrib] → [Distribution data].)
- (2) On the day of moving in, perform the settings for the area number, area name, distribution group, etc. for the area.
- (3) Then wait for the normal cutoff day, and perform billing processing for the area that occupants have moved into part way through according to the contents of the cutoff data.
For other areas, calculate the monthly usage amount by summing up the data for two times in each area together with the distribution calculation of (1) for that month only.
 - * If it is obvious that nobody has occupied the area at least from the previous cutoff day until the present day (the air conditioners have not been used), it is possible not to perform the manual cutoff in (1).

■ Do not forget to remove from the [Distrib. Grp.] settings for indoor units in rooms of areas which are not occupied.

If you remove them from the distribution group, it is no problem to register them as areas with area names such as "vacant room".

In addition, it is recommended that you set [ON/OFF Prhbt.] for the remote controller of vacant rooms.

- * If you leave a vacant room in the distribution group and the indoor unit is operated, distribution to that vacant room will occur.

Also, if load distribution is used, the standby power will be counted even in the OFF state, so the distribution will not be 0%.

● Intelligent Controller (CZ-256ESMC3)

Panasonic[®]

Operating Instructions
Intelligent Controller

Model No. **CZ-256ESMC3**

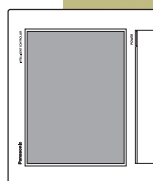

ENGLISH

Before operating the unit, read these operating instructions thoroughly and keep them for future reference.

Installation Instructions
Separately Attached.



Panasonic Corporation
1006 Kadoma, Kadoma City, Osaka, Japan

Panasonic Corporation
<http://www.panasonic.com>

CV623334158

Contents

Features	2	Displaying data in graphs	105
Contents	3	Graph display function	106
Simple guide to features	4	Graphing operating times and energy usage	109
Safety precautions	5	Graphing temperature changes	113
Operating precautions	6	Setting items freely	116
Installation precautions	6	Perform remote operation of the unit over a network	122
System configuration	7	Setting the network	123
Explanation of terms	8	Setting the users	125
The Energy Saving function	9	Control remotely	128
Energy navigation function	11	Backing up/restoring data	129
Preparations before changing settings	12	Backing up data	130
Part names	13	Restoring data	132
Operations on this unit	14	Outputting settings as a CSV file	134
Menu list	18	Inputting settings as a CSV file	136
Initial settings	20	Saving automatically generated files	138
Input of the admin number (password)	22	Configuring the system	140
Check the status of air conditioning units	23	Basic settings on the indoor unit	141
Checking the settings on the indoor unit	24	Basic settings on the outdoor unit	145
Changing the settings on the indoor unit	26	Basic settings for distribution calculation	148
Checking the operational status of indoor units	28	Changing the name of the schedule group	151
Checking the operational status of the outdoor unit	32	Changing the name of the area group	153
Checking on current alarms	35	Changing the name of the distribution group	155
Setting a schedule	39	Basic settings for the pulse meter	158
Schedule setting flow	40	Set the distribution mode	160
Setting a schedule	43	Set the units for electricity/gas charges	161
Allocating a schedule to a calendar	49	Linked control of air conditioning units	162
Checking the future schedule and past performance	53	Configuring outgoing mail	168
Temporarily modifying or adding a schedule	55	Registering a communication adaptor	170
Checking the alarm logs and operation/status change logs	57	Maintenance settings	172
Checking the alarm logs	58	Setting the screen display and volume for this unit	173
Checking the operation/status change log in a list	61	Register the contacts for servicing for this unit	174
Check accumulated values	64	Update the software	175
Checking the list of accumulated values on the indoor unit	65	Initialising the unit and setting log levels	178
Checking the list of accumulated values on the outdoor unit	67	Setting the date and time	178
Checking the list of accumulated values on a pulse meter	69	Setting the language and time zone	179
Checking distribution data	71	Running a test operation	181
Checking distribution data in a list	72	Setting communications with air conditioning units	184
Settings for energy saving	76	Ignoring alarms from the units	186
Automatically return to set temperatures	77	Appendix	187
[Set temp. auto return]	77	Number and letter input	188
Automatically stopping restarts [Unattended auto shutoff]	80	Connections with external signals	190
[Set temperature range limit]	83	Methodology for calculating distributions	191
Restricting operating capacity according to the time slot	85	Things you should know	195
[Energy saving timer]/[Efficient operation setting]	87	Troubleshooting	200
Demand settings on the indoor unit	89	Cautions when cleaning and maintaining	201
[I/D unit demand settings]	89	Trademark and indemnity	202
[O/D unit demand settings]	92	Specifications	203
Suppressing the consumption of electricity/gas	94		
[Demand/peak shaving settings]/[Peak cut settings]	94		
Control operation at regular intervals [I/D unit cyclic]	97		
Control operation at regular intervals [O/D unit cyclic]	101		
Registering demand point input [Register demand point]	104		

● Read the Operating Instructions carefully for safe use. This manual describes the Operating Instructions of the intelligent controller. Read this manual as well as operating instructions supplied with indoor units and outdoor units.

- **Be sure to read the "Safety precautions" (P.5) before using.**
- Keep this manual with operating instructions supplied with indoor units and outdoor units in a safe place.
- Be sure to keep this manual in a place easily accessible by users. In the case of user change, be sure to give this manual to the new user.

NOTICE
The English text is the original instructions. Other languages are translation of the original instructions.

Features

This unit is a centralized air conditioning management system designed for use with precision air conditioning systems (PAC, air conditioning systems for offices and shops, and multi-unit systems for buildings) and gas heat pump (GHP) air conditioners.

- With one of these units you can connect and control up to 128 indoor units (2 systems of 64 units each) and 60 outdoor units (2 systems of 30 units each).
- By connecting a communication adaptor, this can be increased to 256 indoor units and 120 outdoor units.
- The unit is equipped with a 10.4-inch TFT colour touch panel display (1024 x 768 dots), enabling control by almost anyone.

Operation and status

P.23
You can check operational status (ON/OFF, operating mode, alarms, etc.) of all indoor units and outdoor units in real time.
You can also select indoor units to change their settings.

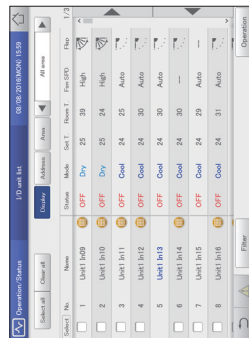

Operation scheduling

P.39
You can register daily operation schedules (ON/OFF time, operating modes, set temperatures, etc.) for individual indoor units or groups of indoor units.
Operations can be schedule for up to 2 years in advance.



Distributing air conditioner energy

P.71
You can view cumulative operating times for indoor units, engine operating times for outdoor units, and operation cycles in a list. (Cumulative values)
Using these data, you can calculate the distribution ratio of electricity or gas consumed for air conditioning and volumes used (kWh, m³) per indoor unit or in an area, then show these calculations in a list.

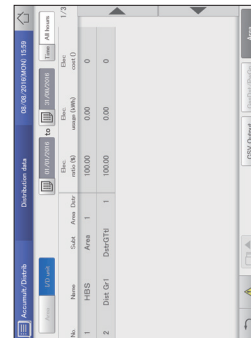

Remote control

P.122
The LAN terminal on this unit enables you connect it to a network.
Connecting to Internet will enable you to operate the unit and check the status using a PC from a remote location.

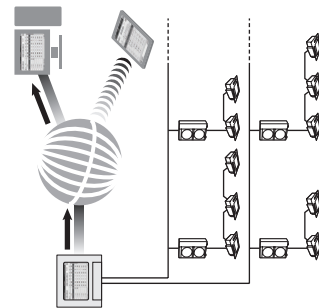

Simple guide to features

This guide only shows the main features.

Operations on the indoor unit

What you want to do	Title	Page
To change the settings on the indoor unit	Changing the settings on the indoor unit	26
To change the operating mode	Changing the settings on the indoor unit	26
To change the set temperature	Changing the settings on the indoor unit	26
To reset the filler sign	Checking the settings on the indoor unit	25
To change the airflow direction and fan speed	Changing the settings on the indoor unit	26
To prevent operation by remote controllers	Changing the settings on the indoor unit	26

Checking the operating status

What you want to do	Title	Page
To check the operational status of the indoor units you are managing	Checking the operational status of indoor units	28
To check the current alarms	Checking on current alarms	35
To check alarm history	Checking the alarm logs	58
To check the current or past cumulative times	Checking the list of accumulated values on the indoor unit	65
To check the current or past distribution ratios	Checking distribution data in a list	72

Settings

What you want to do	Title	Page
To change the name of an indoor unit	Basic settings on the indoor unit	141
To change the name of the area group	Changing the names of the area group	153
To adjust the date or time	Setting the date and time	178
To operate an indoor unit according to a schedule	Setting a schedule	39
To adjust the brightness of the screen	Setting the screen display and volume for this unit	173
To adjust the sound of the buzzer	Setting the screen display and volume for this unit	173

Miscellaneous

What you want to do	Title	Page
To backup data (settings, cumulative values, distribution data, etc.) to a USB memory device	Backing up data	130
To show the operating times, temperature changes, and other information in graphs	Displaying data in graphs	105

Safety precautions

WARNING

This symbol refers to a hazard or unsafe practice which can result in severe personal injury or death.

CAUTION

This symbol refers to a hazard or unsafe practice which can result in personal injury or product or property damage.

! Matters to be observed

! Prohibited matters

! WARNING

! Do not use this appliance in a potentially explosive atmosphere.

! In case of malfunction of this appliance, do not repair by yourself. Contact the sales or service dealer for repair.

! In case of emergency, remove the power plug from the socket or switch off the circuit breaker or the means by which the system is isolated from the mains power.

! CAUTION

! This appliance is intended to be used by expert or trained users in shops, in light industry and on farms, or for commercial use by lay persons.

This appliance can be used by children aged from 8 years and above and persons with reduced physical, sensory or mental capabilities or lack of experience and knowledge if they have been given supervision or instruction concerning use of the appliance in a safe way and understand the hazards involved.

! Do not operate with wet hands.

! Do not wash with water.

System configuration

The following is an example of a system configuration.

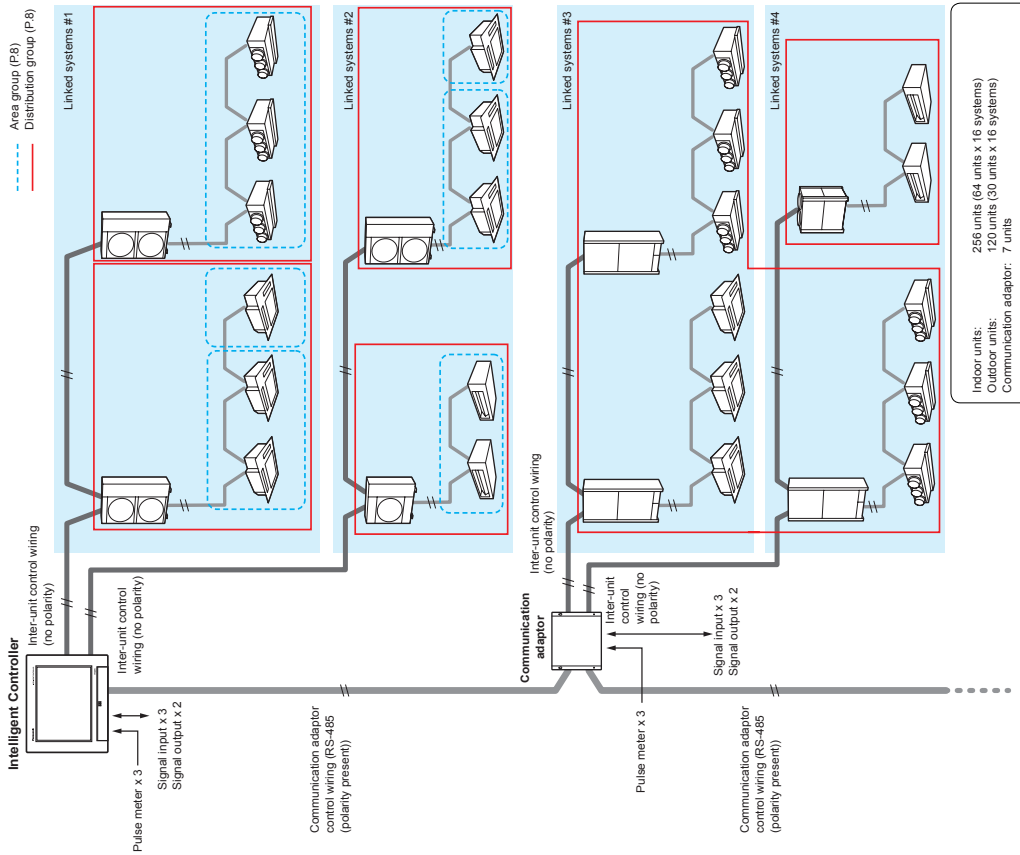

Operating precautions

- Do not use in the following locations
 - Where flammable gases, etc. may leak
 - Near the ocean or other areas with a lot of salt
 - In areas where sulphurous gases occur such as natural spa areas
 - In places where there may be airborne water or oil (including machinery lubricants, etc.) or steam
 - Where there are large fluctuations in voltage
 - Where machinery emitting electromagnetic waves are located
 - Where there may be airborne organic solvents
- Do not apply strong shocks (This may cause malfunction)
- Do not use heaters near the controller (This may cause deformation or discolouration)
- Do not use hard or pointy objects (This may cause scratches or malfunction)
- Do not hit the touch panel or push on it too strongly (This may cause malfunction)

Installation precautions

- Do not install in locations with high humidity, lots of oil, vibrations, where direct sunlight can reach the unit, or near sources of heating (This may cause malfunction)
- Do not install in noisy locations (This may cause incorrect operation)
- Install at least 1 m away from TV, radio, PC, etc. (To prevent fuzzy images or noise)

Information for Users on Collection and Disposal of Old Equipment and Used Batteries

These symbols on the products, packaging, and/or accompanying documents mean that used electrical and electronic products and batteries should not be mixed with general household waste. For proper treatment, recovery and recycling of old products and used batteries, please take them to applicable collection points, in accordance with your national legislation and the Directives 2002/96/EC and 2006/66/EC. By disposing of these products and batteries correctly, you will help to save valuable resources and prevent any potential negative effects on human health and the environment which could otherwise arise from inappropriate waste handling.

For more information about collection and recycling of old products and batteries, please contact your local municipality, your waste disposal service or the point of sale where you purchased the items.

Penalties may be applicable for incorrect disposal of this waste, in accordance with national legislation.

For business users in the European Union

If you wish to discard electrical and electronic equipment, please contact your dealer or supplier for further information.

[Information on Disposal in other Countries outside the European Union]

These symbols are only valid in the European Union. If you wish to discard these items, please contact your local authorities or dealer and ask for the correct method of disposal.

Note for the battery symbol (bottom two symbol examples):

This symbol might be used in combination with a chemical symbol. In this case it complies with the requirement set by the Directive for the chemical involved.

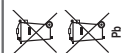

Explanation of terms

This section explains the terms used in this document.

Term	Explanation
Adaptor address	The address allocated to a single communication adaptor (sold separately). If the pulse meter is connected to a communication adaptor, use the address of the adaptor. Setting No. 0: This unit (setting complete) No. 1 to 7: Settings with the communication adaptor
Linked systems address	This is a grouping of indoor units and/or outdoor units connected to the same inter-unit control wiring. Setting 2-lined systems can be connected to this unit or a communication adaptor (sold separately). No. 1 and 2: (fixed)
Outdoor unit systems address	An outdoor unit and the grouping of indoor units connected by the coolant piping. Setting A single linked system can consist of a maximum of 30 outdoor unit systems. No. 1 to 30: Set on the outdoor unit for each linked system
Indoor unit address	In an indoor unit system, this is a fixed number allocated to an indoor unit. This is also allocated to each indoor unit for group control. Setting No. 1 to 64: Set on the indoor unit for each outdoor unit system
Central address	This is a fixed value within the linked system and is shared with other centralised controllers (system controllers, etc.). In group control, all indoor units belonging to a group have the same address. In this document and on the unit, this is described as the 'CNTR addr.' Setting No. 1 to 64: Set on this unit and other central controllers for each linked system
Unit name	In group control, this will be the same name. This is the minimum unit used for operation, monitoring, and scheduling. Setting Set on this unit
Distribution group	A distribution group consists of multiple (or single) areas and matches with the measuring range of a pulse meter, with the distribution ratio of the grouping totalling to 100%. A maximum of 8 groups can be created across the whole system. With time distributing, it is not possible to mix PAC and GHP in a single distribution group. You can have PAC and GHP in the same group if you are using load distributing. Setting No. 1 to 8: Set on this unit
Area group	An area group is one grouping used for calculating distributions (or for operating or monitoring) and consists of multiple (or single) indoor units. A maximum of 256 groups can be created across the whole system. Setting No. 1 to 256: Set on this unit
Control groups	Control groups consist of multiple (or single) indoor units or outdoor units controlled the same in cyclic control settings. A maximum of 10 groups can be set for indoor units and a maximum of 5 groups can be set for outdoor units.

The Energy Saving function

This reduces waste in air conditioning so that you can save energy without replacing the air conditioning units.

e-CUT function

Set temperature auto return

When you want to return to the set temperature after a certain time even if the temperature is changed. (P.77)

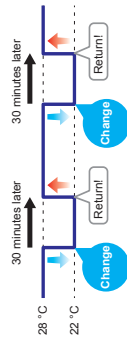

Unattended auto shutoff

When you want to operate outside of a schedule but to monitor and stop automatically. (P.80)

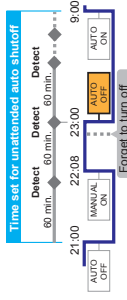

Set temperature range limit

When you want to limit the temperatures that can be set. (P.83)

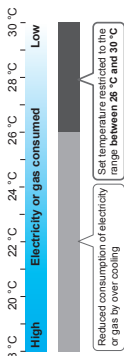

Energy saving timer/Efficient operation setting*1

Specify time slots when you want operation capacity reduced. (P.85)

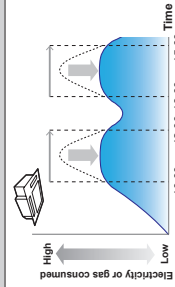

The Demand function

Demand settings (indoor unit/outdoor unit)

When you want to suppress the maximum demand for electricity or maximum gas consumption. (P.89, P.92)

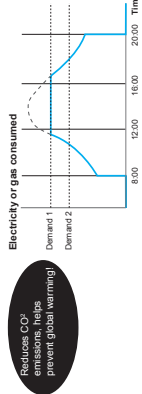

Indoor/outdoor unit cyclic

When you want operation capacity of the outdoor units reduced during certain repeated intervals. (P.97, P.101)

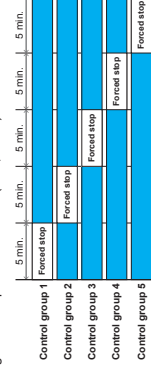

Note
• Some models may not support these functions.

*1 The 'Efficient operation setting' is the name of setting when using gas heat pump air conditioners.
*2 The 'Peak cut settings' is the name of setting when using gas heat pump air conditioners.

Energy navigation function

Indoor units will run in energy saving modes according to the amount of human activity detected by ECONAVI sensors (sold separately).

When there are no people



- **In cooling or drying mode**
Operates at the set temperature.
- **In heating mode**
The temperature is set lower than when there are people in the room.

When there is a lot of human activity



- **In cooling or drying mode**
Operates at the set temperature.
- **In heating mode**
The air conditioners run at a temperature lower than the set temperature.

When there is not a lot of human activity



- **In cooling or drying mode**
The air conditioners run at a temperature higher than the set temperature.
- **In heating mode**
Operates at the set temperature.

Warning



Do not use the ECONAVI feature in rooms where only disabled people or infants are present.
(It may cause damage to their condition or worsen their health)
If there is not much movement for a long time, the ECONAVI sensor may determine that the room is unoccupied and stop the air conditioning unit.

Note

- You can turn on or off the ECONAVI feature on this unit.
- You will need a separate remote controller with ECONAVI functionality in order to make advanced settings for the ECONAVI feature. Refer to the operating instructions for the remote controller with ECONAVI functionality for details on how to configure the feature.
- Even if the target temperature is changed by ECONAVI, the set temperature displayed on the unit will not change.
- Even if the mode is switched to fan due to the absence of people (standby mode), the mode displayed on the unit will not change.
- When running multiple indoor units, the energy reduction effect may be reduced depending on the conditions in the room.

The Energy Saving function

Demand control

"Demand" indicates the "electricity demand" (average electricity over 30 minutes). The basic charges for electricity are determined by the maximum value of demand (the maximum electricity demand). This maximum demand for electricity occurs during summer and winter when the air conditioning burden is the greatest. One way of reducing electric power costs is to suppress the maximum electricity demand during these periods. (Your actual situation depends on your contract with your electricity provider) Furthermore, by suppressing the maximum demand for electricity, you can assist in the reduction of carbon dioxide emissions and help reduce global warming.

Demand control means that the air conditioning units are monitored so that their electricity consumption does not exceed a contracted amount, and by setting a level as shown in the following diagram (demand 1, 2, or 3), the performance of the air conditioning units can be controlled so that energy usage is reduced. This unit suppresses the maximum demand for electricity through automated control of air conditioning units by demand control output (demand output) signals emitted by external equipments.

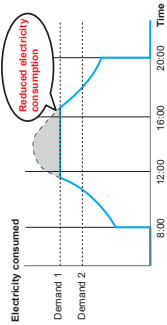

Demand control (with indoor unit demand settings)

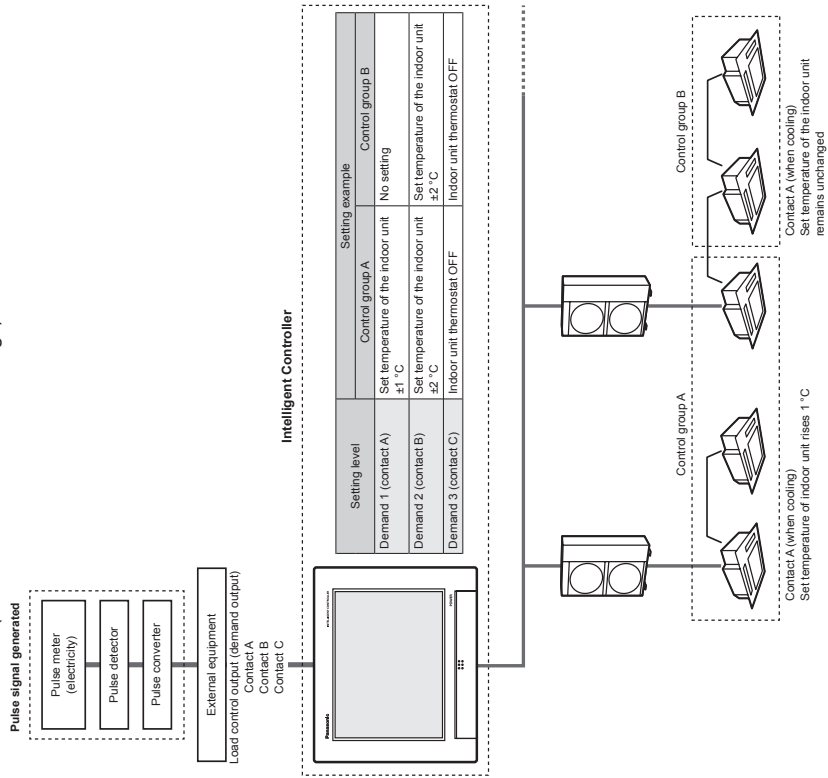

Part names

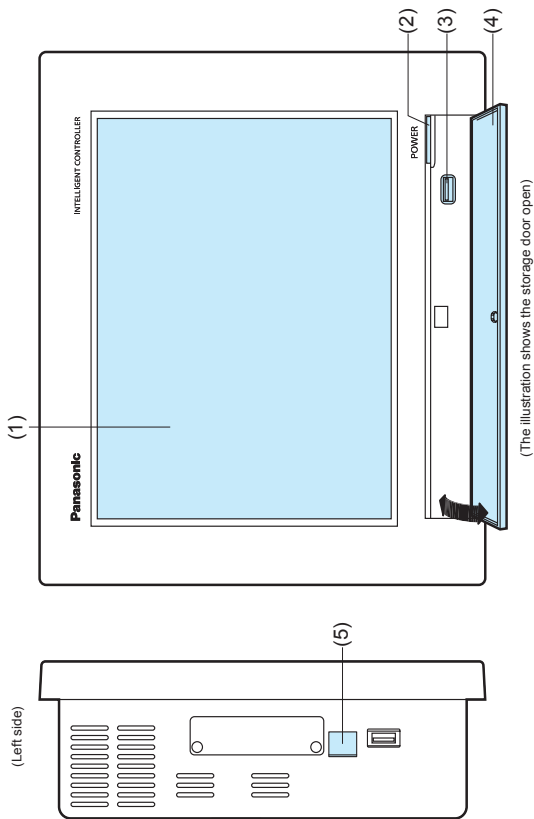

Name	Explanation
(1) Colour LCD with touch panel	You can operate the unit by touching the screen with your fingers.
(2) Power indicator	This lights when the power is on.
(3) USB terminal	Connect a USB memory device here to backup data from this unit (settings, accumulation/distribution).
(4) Storage door	Open this cover to connect a USB memory device to the USB terminal. To open, gently push on the storage door and then allow to drop down. To close, lift the storage door and gently press closed.
(5) LAN terminal	Connect to a network with wiring.

Preparation Preparations before changing settings

Preparations before changing settings

This chapter describes the part names of the unit and their functions and also explains some basic operations.

Operations on this unit

Operations on this unit are performed by following menus. The screens used for operations all follow a common pattern, with the screens being easy to read and easy to use.

Basic operation of the touch panel

This section describes the basic operations on the touch panel.

Touch
This is a light touch with a finger on the buttons or text boxes displayed on the touch panel.

Picker
This is an up and down movement of the finger touching the screen, used to pick settings in elements such as spin boxes.

Swipe
This is an operation where the finger is slid in a direction (up or down) on the touch panel. This is used to scroll slowly.

Flick
This is an operation where the finger on the touch panel is flicked in a direction (up or down). This is used to scroll quickly.

Preparation

Operations on this unit

Buttons and boxes

There are varieties of buttons and boxes on the screen that you use to perform operations and settings on the touch panel.

Buttons

These are used to switch screens, save settings, switch settings on or off, select items, and similar operations.

Display example	Status	Explanation
	Setting is off	In this state the setting is off.
	Setting is on	In this state the setting is on.
	Setting unavailable	This indicates that the setting is currently unavailable due to other conditions.

Display example	Status	Explanation
	Selected	The highlighted item is the one that is currently selected.
	Selection disabled	This indicates that the selection is currently unavailable due to other conditions.

Check boxes

These are mainly used to switch on or off item selection and functions.

Display example	Status	Explanation
	Unselected	In this state the item is not selected.
	Selected	In this state the item is selected. (In this example, the automatic stop feature will operate.) A check mark appears when you touch it. The check mark disappears when you touch it again.

Spin boxes

These are used to switch the display of items and to set numeric items such as time.

Display example	Explanation
	<p>Takes you to the next item. ◀ takes you to the previous item. Items may cycle around in the following way: Gr.1 ↔ Gr.2 ↔ ... ↔ Gr.5 ↔ Gr.1</p>
	<p>Increases the numeric figure. ▲ decreases the numeric figure. The numeric figure does not continuously increase if you continue to touch the button. The numbers cycle around in the following way: For example: When the number is an "hour" "09" ↔ "10" ↔ "11" ↔ ... ↔ "23" ↔ "00" ↔ "01" ↔ ... ↔ "23"</p>

Preparation

Preparations before changing settings

Operations on this unit

Buttons and boxes (continued)

Text boxes

These are used when you need to edit some text.

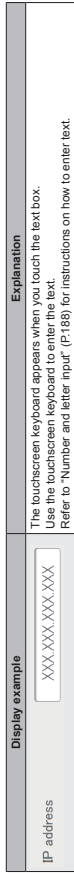

Dialogues

These are elements that appear on the screen and are mainly used for settings. They close automatically once you have registered the settings. Touch to close the dialogue without changing the setting. (There may also be cases where you touch at the top right of the screen to register the setting.)

Dialogues

These are elements that appear on the screen and are mainly used for settings. They close automatically once you have registered the settings. Touch to close the dialogue without changing the setting. (There may also be cases where you touch at the top right of the screen to register the setting.)



Preparation

Preparations before changing settings

Operations on this unit

How to read the screens

There are some items and icons common to the operations and settings screens. The follow explains the items and icons.



Name	Explanation
A. Submenu name	This displays the submenu name.
B. Operations/Settings screen name	This displays the operations/settings screen name.
C. Date and time	The current date and time is displayed.
D. "Home" icon	Touch this to display the Top menu (P.18).
E. Scroll buttons	Touch on the right side of the screen to scroll to the right. Touch to scroll to the left. (The display changes according to the direction you can scroll.)
F. "Back" icon	Touch this to go back to the previous menu.
G. "Warning" icon	The "Alarm list" screen is displayed when you touch this. (→ "Checking on current alarms" (P.25))

- In this document and on the unit, indoor units are described as the "I/D".
- In this document and on the unit, outdoor units are described as the "O/D".

Notations in this document

Menu names, screen names, etc., are shown as follows in this document.

Type	Notation	Example
Top menus	"xxx"	"Oper./Status"
Screen names	"I/D unit list" screen	"I/D unit list" screen
Screen display items	"Select" column, "ON/OFF"	"Select" column, "ON/OFF"
Submenu names	[xxx]	[Operation/Status]
Screen menu names	[I/D unit list]	[I/D unit list]
Button names	[Operation]	[Operation]

Menu list

1 Select the top menu.

- Touch one of the "EnergySaving", "Oper./Status", or "Settings" tabs.

2 Select the submenu.

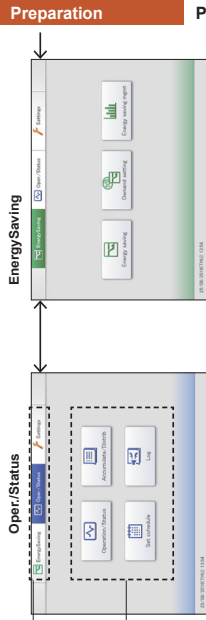

Preparations before changing settings

Oper./Status (Check on the status of connected units)

Submenu	Screen menu	Overview	Page
Oper./Status	ID unit list	Check the operational status of the indoor units in a list.	24
	ID unit information	Check the details about the indoor units (number of operation cycles, etc.) in a list.	28
	O/D unit information	Check the details about the outdoor units (outdoor temperatures, etc.) in a list.	32
	Alarm list	You can view a list of units with current alarms, where you can check the unit, the alarm type, and the date of the alarm.	35
	Schedule/results	You can see the schedules set up for the future and how they performed in the past in a list.	53
Log	Calendar	You can allocate a single day's schedule to a calendar.	49
	Schedule setting	You can register the schedule for a single day.	43
	Update schedule	You can modify a schedule that you have registered (only from the day of the change up to 4 days later, or a total of 5 days).	55
	Alarm log	Check the log of alarms that have occurred in the system in a list.	58
Accumulate/Dispb	Operation/Status change log	Check the log of operation/status changes of the indoor units in a list.	61
	ID unit acc.	Check the accumulated data for the indoor units in a list.	65
	O/D unit acc.	Check the accumulated data for the outdoor units in a list.	67
Backup/CSV Output	Pulse acc.	Check the accumulated data for the pulse meters in a list.	69
	Distribution data	Check the details about distribution calculations in a list.	72

EnergySaving (Perform energy saving settings)

Submenu	Screen menu	Overview	Page	
Energy saving	Set temp. auto return	Even if the temperature initially set is changed, the temperature automatically returns to the set one after a certain amount of time.	77	
	Unattended auto shutoff	The temperature set time is set time but then is started again, this setting automatically stops the unit again repeatedly at set intervals.	80	
	Set temperature range limit	Restrict the temperatures that can be set by setting upper and lower limits on temperatures.	83	
	Energy saving timer/Efficient operation setting*	You can specify time slots when you want operation capacity reduced.	85	
	O/D unit silent setting	Set a time for the outdoor unit to operate at a lower level at night compared to the day.	87	
Demand setting	ID unit demand settings	You can automatically control indoor units to cut the maximum demand for electricity or maximum gas consumption.	89	
	O/D unit demand settings	You can automatically control outdoor units to cut the maximum demand for electricity or maximum gas consumption.	92	
	Demand/peak shaving settings/Peak cut settings*	Limit the electricity or gas consumed by outdoor units during the set time slot.	94	
	O/D unit cyclic	At specified 10 minute intervals, the thermostats of outdoor units in control groups are turned off and restored repeatedly in order.	101	
	ID unit cyclic	At specified intervals (3, 4, or 5 minutes), the thermostats of indoor units in control groups are turned off and restored repeatedly in order.	97	
	Register demand point	Register the contacts between the external equipments and the main unit (Contact A, Contact B, Contact C).	104	
	Energy saving mgmt	Bar chart	Quantities of energy usage (electricity, gas), etc. are shown in bar charts.	109
		Line graph	Temperature changes, etc. are shown in line graphs.	113

* When using gas heat pump air conditioners

Menu list

Preparation

Preparations before changing settings

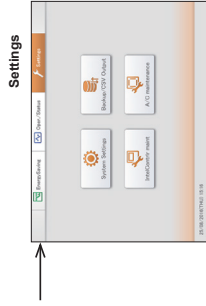

Settings (Perform other miscellaneous settings)

Submenu	Screen menu	Overview	Page
System Settings	Calendar strings for distr calc	Set specified days, cut-off days, cut-off days, particular time slots (regular hour ranges) and days of the week for calculating distributions.	148
	ID unit settings	Change settings on indoor units, such as indoor unit addresses, groups belonged to, etc.	141
	O/D unit settings	Change settings on outdoor units (addresses, etc.)	145
	Schedule group name settings	Edit the name of the schedule group.	151
	Area group name settings	Edit the name of the area group.	153
	Distribution group settings	Edit the name of the distribution group.	155
	Pulse meter settings	Make allocations between pulse meters and distribution groups.	158
	Distribution mode settings	Set the mode used for distributing when calculating charges.	160
	Distribution Ratio settings	Set the units for calculating electricity and gas usage charges.	161
	Event control	Perform linked control by setting input and output conditions for devices.	162
	Network settings	Make settings to enable remote control over a network.	123
	Email settings	Configure the outgoing mail server.	168
	Web user settings	Register users that will access the unit over a network.	125
Communication adaptor setting	Register the communication adaptor connected to this unit.	170	
Check configuration*	Modify the registered configuration when there have been changes to the configuration of the system.	200	
Backup/CSV Output	Backup	Save data settings, accumulation/distribution, logs to USB memory devices.	130
	Restore	Restore data that has been stored in the unit or saved to a USB memory device.	132
	CSV Output	Export (output) the settings for this unit in CSV format.	134
	CSV Input	Import (input) the settings for this unit in CSV format.	136
	Auto-save CSV file	Saves the CSV files (distributions, logs) automatically generated in this unit.	138
Intelligent Controller	Display/Volume settings*	Adjust the brightness of the unit's screen and the sound of the buzzer.	173
	Intelligent Controller info	Register the contacts for servicing (telephone numbers) for this unit.	174
	Software update*	Update the software for this unit.	175
	Initialize*	Initialise the settings for this unit. All data will be lost when you initialise. Do not initialise under any circumstances.	176
A/C maintenance	Language&TimeZone strings	Set the language to be used when setting and operating this unit.	179
	Date settings	Manually set the date and time.	178
	Open license	The licenses for the firmware is displayed.	—
A/C maintenance	Test run	Perform a test operation of the indoor unit after installing this unit.	181
	AVC communication settings	Make settings such as the communications protocol between this unit and the air conditioning units.	184
	Maintenance information	Register the units that will require maintenance.	186

* These settings are not available for setting or operation over the network.

Menus marked with ★ require you to enter the admin number (password) when you select them.

★ menus require entry of the level 1 or higher admin number, while ☆ requires the level 2 admin number. Refer to "Input of the admin number (password) (P.22)" for details.

Initial settings

The initial settings are those items that require setting after the unit is installed so that the system operates normally. The unit will operate normally if you make settings according to the following flow for the type of operation intended.

O: Settings required. Δ: Settings may be required. x: Settings not required.

Step	Category step	Setting	Screen menu names	Reference page	Air conditioning operations only	Operation		Quantity used, charges display
						Distribution rate display only	Load	
1	Date settings	Setting the current date and time	Date settings	178	O	O	O	O
2	Composition loading	Confirming the connection configuration	Check configuration	—	O	O	O	O
		Central address**	ID unit settings	141	O	O	O	O
		Name of the indoor units	ID unit settings	141	O	O	O	O
		Distribution group	ID unit settings	141	x	O	O	O
3	Unit related	Area group	ID unit settings	141	Δ	Δ	Δ	Δ
		Control group	ID unit settings	141	Δ	Δ	Δ	Δ
		Not batch, not managed	ID unit settings	141	Δ	Δ	Δ	Δ
		Name of the outdoor units	OID unit settings	145	Δ	Δ	Δ	Δ
		Local remote controller prohibition setting	A/C communication settings	184	Δ	Δ	Δ	Δ
		Name of the area group	Area group name settings	153	Δ	Δ	Δ	Δ
4	Group related	Name of the distribution group	Distribution group settings	155	x	O	O	O
		Name of the schedule group	Schedule group name settings	151	Δ	Δ	Δ	Δ
5	Pulse meter related	Association with the distribution group	Pulse meter settings	158	x	x	O	O
		Type of pulse meter (electricity/gas) multiplying factor (number of pulse units)	Pulse meter settings	158	x	x	O	O
		Name of the pulse meter	Pulse meter settings	158	x	x	Δ	Δ
		Distribution modes (time/load)	Distribution mode settings	160	x	O	O	O
6	Distribution related	Power distribution calculation target ¹⁾	Distribution mode settings	160	x	O	O	O
		Energy saving distribution setting	Distribution mode settings	160	x	Δ ⁴⁾	x	Δ ⁴⁾
		Distribution of gas for power generation	Distribution mode settings	160	x	x	x	Δ ⁴⁾
		Setting the monthly cut-off days	Distribution mode settings	160	x	x	x	Δ ⁴⁾
		Setting the regular hour range	Calendar strings for distr calc	148	Δ ⁴⁾	O	O	O
		Setting specified days	Calendar strings for distr calc	148	x	Δ	Δ	Δ
		Currency for electricity or gas charges ⁷⁾	Distribution Ratio settings	148	x	Δ	Δ	Δ
		Setting the capacity of the indoor units ⁸⁾	ID unit settings	161	x	x	x	Δ
		Setting the capacity of the electric heater	ID unit settings	141	x	Δ	x	Δ
		Schedule for a single day	ID unit settings	141	x	Δ	x	Δ
7	Scheduling related	Allocating a schedule to a calendar	Schedule setting	43	Δ	Δ	Δ	Δ
		Schedule group	Calendar	49	Δ	Δ	Δ	Δ
8	Event control	Input point (names and conditions) ⁹⁾	ID unit settings	141	Δ	Δ	Δ	Δ
		Output point (names and operation) ¹¹⁾	Event control	162	Δ	Δ	Δ	Δ

Initial settings

Preparation

Preparations before changing settings

Step	Category step	Setting	Screen menu names	Reference page	Air conditioning operations only		Operation		Quantity used, charges display
					Distribution rate display only	Load	Distribution rate display only	Load	
9	Network related ¹⁾	IP address, net mask, DHCP, etc.	Network settings	123	Δ	Δ	Δ	Δ	Δ
		Setting to send alarm mails	Email settings	168	Δ	Δ	Δ	Δ	Δ
		User ID, password, privileges	Web user settings	125	Δ	Δ	Δ	Δ	Δ
		Buzzer volume	Display/Volume settings	173	Δ	Δ	Δ	Δ	Δ
10	Intelligent controller related	Brightness of the back light	Display/Volume settings	173	Δ	Δ	Δ	Δ	Δ
		Auto logout time	Display/Volume settings	173	Δ	Δ	Δ	Δ	Δ
		Identification number	Initialize	176	Δ	Δ	Δ	Δ	Δ
		Initialise the days accumulated data ¹³⁾	Initialize	176	O	O	O	O	O

- ¹⁾ Attention needs to be paid to administration divisions when devices such as systems controllers are to be used in conjunction with this unit.
- ²⁾ Settings required when area administration is to be performed.
- ³⁾ Select the object of calculations for electricity distributing from the following:
 - Operating hours
 - Thermostat on times
 Select when consideration is to be paid to the electricity for the indoor units. The electricity for outdoor units and indoor units are both loaded into this unit and distributed.
- ⁴⁾ If the air conditioning units included in the system are multi-function types supporting simultaneous heating and cooling or ice thermal storage models, settings are required.
- ⁵⁾ Settings are required only when units are GHP with generators.
- ⁶⁾ Settings are required only when the outdoor operating time is to be managed.
- ⁷⁾ This must be set if you want to display charges.
- ⁸⁾ This only needs to be set for interface adaptors. (→ Interface adaptors (sold separately) (P.198))
- ⁹⁾ This is used when calculating load distributing.
- ¹⁰⁾ Set items such as batch startup and stopping from external input.
- ¹¹⁾ Set items such as batch alarm output to external devices.
- ¹²⁾ Required when logging in through a network device to operate and monitor.
- ¹³⁾ Clears the data calculated from test operation of the air conditioning units before hand over.

Input of the admin number (password)

When using this unit

Items marked with ★ or ☆ in the "Menu list" (P-18 and P-19) require you to enter an admin number before use to maintain security.

1. The admin number input screen is displayed when you touch a menu on the screen.



2. Enter the admin number

- Depending on the level of admin number you have, you may not be able to enter the menu.

When using a browser

Depending on your user level, some menus may not be displayed. Refer to "Control remotely" (P-128) for information on how to access the menus. You may need to enter the admin number again after gaining access, depending on the menu. See "When using this unit" above for information on how to enter the admin number.

Operation/Status

Check the status of air conditioning units

Check the status of air conditioning units



This chapter explains how to check the setting status of air conditioning units (indoor units and outdoor units). This unit allows you to confirm and change settings for indoor units, and confirm the operational status of indoor units and outdoor units. You can also check alarms that have occurred in the system in a list.

Screen menu	Overview	Page
I/D unit list	Check the operational status of the indoor units in a list.	24
O/D unit information	Check the details about the indoor units (number of operation cycles, etc.) in a list.	28
O/D unit information	Check the details about the outdoor units (outdoor temperatures, etc.) in a list.	32
Alarm list	You can view a list of units with current alarms, where you can check the unit, the alarm type, and the date of the alarm.	35

Preparation

Preparations before changing settings

Checking the settings on the indoor unit

Operation/Status

Check the status of air conditioning units

Checking the settings on the indoor unit

You can check the setting status of all indoor units connected to this unit in a list. You can also change the display to show by area.

1 Touch [Operation/Status] in "Oper./Status".

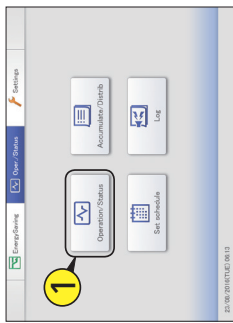

Select the area to display

1

Touch [Area].

- The "Select Area" dialogue is displayed.



2

Select the area to display.

- If 9 or more area groups have been registered (P.153), you can scroll up or down by swiping or flicking the screen.
- The "Select Area" dialogue is closed and the settings of the selected area are displayed in the list.



"I/D unit list" screen

- A: [Select all]/[Clear all] buttons
- Select all indoor units.
 - Cancel selection of all indoor units.

- B: Change list order.
- The display follows the order set in "I/D unit settings" (P.141).
 - The display follows the address order set in "I/D unit settings" (P.141).

- C: Select the area to display in the list.
- The area changes each time you touch and . Touch [Area] to display the "Select Area" dialogue. (→ "Select the area to display" (P.24))
 - "All area" → "Area1" → "Area2" → ... → "AreaXXX" → "All area"
 - *"XXX" stands for the number of the last of the registered areas.

- D: The settings of the indoor units are displayed in a list.
- You can scroll up or down by swiping or flicking the screen.
 - Each time you touch the item name, the order switches between ascending (▲) and descending (▼).
 - Some items are not displayed for some models.

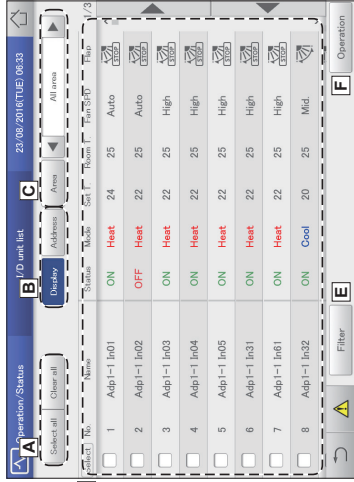

Item	Explanation
[Select]	Select the indoor units you want to operate.
Name	The names of the indoor units are displayed. When an alarm is displayed to the right of the name, this indicates that some situation has occurred. (Alarm display) ☹: The indoor unit filters need cleaning ⚠: An alarm has occurred
Status	This indicates the current operating status (ON/OFF). (P.26)
Mode	The current operating mode (Heat, Dry, Cool, Fan, Auto) is displayed. (P.26)
Set T.	The current temperature setting is displayed. (P.27)
Room T.	The current room temperature is displayed.
Fan SPD	The current fan speed (High, Mid., Low, Auto) is displayed. (P.27)
Flap	This indicates the remate controller operation "Accept" or "Prhibit". (P.27)
Prhibit	This indicates the setting status of this schedule (Yes --, OFF). Yes: This indicates that a schedule is set. --: This indicates that a schedule is not set.
Sche.	OFF: This indicates that a schedule is set, but that the schedule has not started because indoor units are off or similar.
Eco	● is displayed when the energy saving setting is running. (P.27)
ECONAVI	● is displayed when the ECONAVI setting is running. (Only for models with ECONAVI) (P.27)
e-CUT	● is displayed when the e-CUT function is running.

- E: After cleaning the filters, touch to clear the filter icon from the display.
- F: The "Settings" dialogue of the indoor unit selected at D is displayed. You can change the settings for the selected indoor unit in the "Settings" dialogue. (→ "Changing the settings on the indoor unit" (P.26))
- There may be differences in the items you can set depending on the model of the indoor unit.
 - When you have selected multiple units, setting items in common are displayed in the "Settings" dialogue.

1

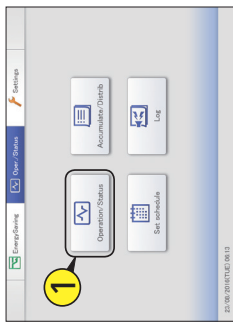

2

Touch [I/D unit list].

- The "I/D unit list" screen is displayed.

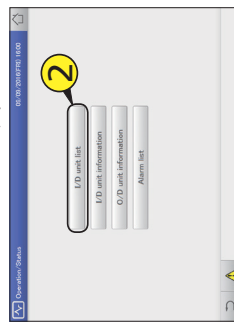

3 Checking the status of settings. (P.25)



Note

- You can select indoor units to change their settings. (→ "Changing the settings on the indoor unit" (P.26))

Changing the settings on the indoor unit

You can select indoor units to change settings, for example, start or stop them, or change their set temperature, etc.. Change settings in the "Settings" dialogue. You can also select multiple indoor units and operate them using the same settings.

1 Touch [Operation/Status] in "Oper./Status".

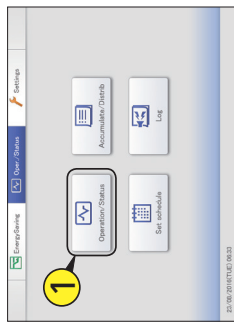

2 Touch [ID unit list].

- The "ID unit list" screen is displayed.

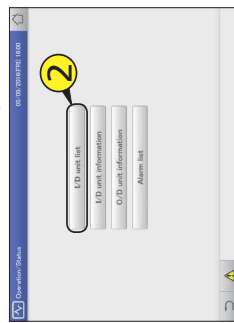

3 Put a check mark in the "Select" column.

- Select the indoor units whose settings you want to change.
- You can touch [Select all] to change the settings in a batch.

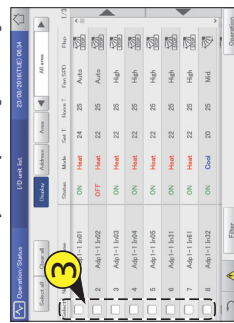

4 Touch [Operation].

- The "Settings" dialogue is displayed.



- There may be differences in the items you can set in the "Settings" dialogue, depending on the model of the indoor unit.
- When you have selected multiple units, setting items in common are displayed in the "Settings" dialogue.

5 Change the settings of the items.

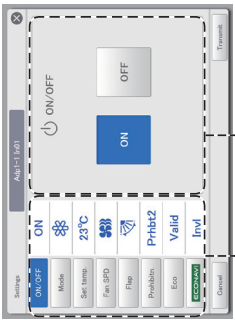

Common display area
Operation display area

Item	Explanation
ON/OFF	Set whether to start or stop operation. 1) Touch [ON/OFF]. 2) Select "ON" or "OFF".
Mode	Set the operating mode. 1) Touch [Mode]. 2) Select the operating mode (heating, (cooling), (fan), (automatic)).

Continued on next page

Changing the settings on the indoor unit

6 Touch [Transmit].

- The settings are registered and the "Settings" dialogue closes.
- To cancel the settings, touch [Cancel].



- Note
Touch [] (or []) at the upper value (or lower value) of the set temperature and the set value becomes a blank (no setting). Make the setting blank when you want no setting. Furthermore, touch [] (or []) and the upper value (or lower value) is displayed. For example: If upper value 30 °C and lower value 18 °C (when cooling)
 - 19 °C
 - 18 °C (lower limit value)
 - (blank)
 - 30 °C (upper limit value)
 - 29 °C

Operation/Status

Check the status of air conditioning units

Item	Explanation
Set temp.	Set the temperature. 1) Touch [Set temp]. 2) Set the temperature with [] and [] (± in 1 °C steps) Setting range for cooling mode: Between 18 °C and 30 °C • In heating mode: Between 16 °C and 30 °C*1 • Automatic: Between 17 °C and 27 °C *1 The upper limit for gas heat pump air conditioners is 26 °C.
Fan SPD	Set the strength of the fan. 1) Touch [Fan SPD]. 2) Select the fan speed (high), (mid), (low), (automatic).
Flap	1) Touch [Flap]. 2) Set the flap to the desired position (Swing), (F5), (F4), (F3), (F2), (F1) during the swing to stop the flap at the desired position. • Heating, fan, and automatic (heating) can be adjusted in 5 steps and cooling and dry can be adjusted in 3 steps. • You can set either () or () if the mode does not support airflow direction settings.
Prohibit**	Set whether to allow or prohibit use of the local remote controller. 1) Touch [Prohibit]. 2) Use [] to select from "Accept", "Prohibit", "Prohibit", or "Prohibit". Accept: Allows operations with the remote controller. Prohibit: Operations on the remote controller are restricted. You can change the restricted operations. (—P.185) Enable or disable energy saving operation. 1) Touch [Eco]. 2) Select "Valid" or "Invf".
Eco	1) Touch [Eco]. 2) Select "Valid" or "Invf".

*2 Example of prohibiting or enabling remote controller use (factory setting)

ON/OFF	Mode	Set temp.	Fan SPD	Flap	Eco
Accept	○	○	○	○	○
Prohibit	×	○	○	○	○
Prohibit	×	×	×	○	○
Prohibit	○	×	×	○	○
Prohibit	○	×	○	○	○

○: Operation and setting with the remote controller is possible
×: Operation and setting with the remote controller is not possible

Checking the operational status of indoor units

Check the operational status of indoor units (remaining filter time, number of operation cycles, etc.) in a list. You can also change the ventilation system and demand control settings (ON or OFF only).

1 Touch [Operation/Status] in "Oper./Status".

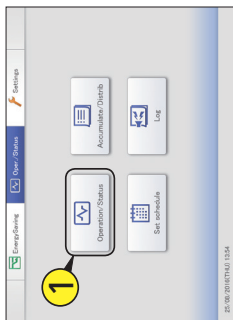

2

Touch [I/D unit information].

- The "I/D unit information" screen is displayed.

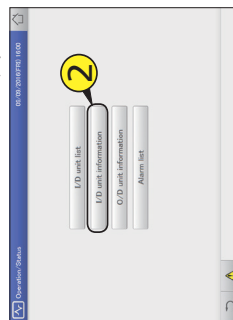

3

Check the setting details. (P.29)



Note

- You can select indoor units to change their ventilation output settings. (→ "Changing the settings for ventilation output" (P.30))
- You can select indoor units to change their demand control settings. (→ "Changing the demand control settings" (P.31))

Checking the operational status of indoor units

Operation/Status

Check the status of air conditioning units

"I/D unit information" screen

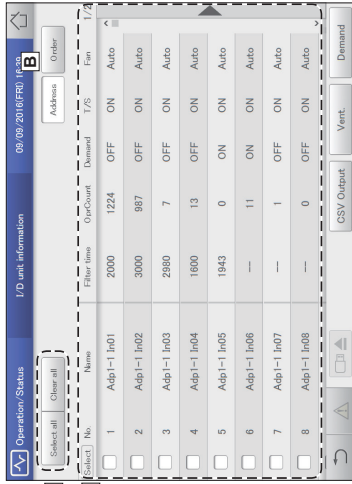

- A:** [Select all]/[Clear all] buttons
 [Select all] Select all indoor units.
 [Clear all] Cancel selection of all indoor units.
- B:** Change list order. The list order changes each time you touch it.
 The display follows the address order set in "I/D unit settings" (P.141).
 The display follows the order set in "I/D unit settings" (P.141).
 The display follows the address order of the outdoor unit systems.
- C:** Indoor unit details are displayed in a list. You can scroll up or down by swiping or flicking the screen.

Item	Explanation
[Select]	Select the units you want to make ventilation settings or demand settings for.
Name	The names of the indoor units are displayed. You can change the names. (→ "I/D unit settings" (P.141))
Filter time	This displays the approximate time remaining before is displayed.
OprCount	The number of operation cycles for the day is displayed.
Demand	Demand control setting status is displayed. "ON" is displayed when demand control is set. (→ "Demand settings on the indoor unit" (P.89))
T/S	This displays the operational status of the thermostat. "ON" is displayed when the thermostat is working.
Fan	The fan strength (High/Mid/Low/Size/OFF) is displayed.
SuchgTmp	The current inlet temperature is displayed.
DaschgTmp	The current outlet temperature is displayed.
VentOpen	The ventilation output setting (ON or OFF) is displayed.

- D:** Change the settings for ventilation output
 The "Vent." dialogue is displayed when you touch this. (→ "Changing the settings for ventilation output" (P.30))
 ON Operation of the ventilation output starts.
 OFF Operation of the ventilation output stops.
- E:** Change the demand control settings.
 The "Demand setting" dialogue is displayed when you touch this. (→ "Changing the demand control settings" (P.31))
 ON Demand control is set.
 Cancel Demand control is cancelled.
- F:** The contents currently displayed are output to the USB memory device as a CSV file.

Operation/Status

Check the status of air conditioning units

Checking the operational status of indoor units

Changing the settings for ventilation output

- Put a check mark in the "Select" column.
 - Select the indoor units whose settings you want to change.
 - You can select multiple indoor units.



- Change the settings.
 - The settings are registered and the "Vent." dialogue closes.



- Touch [Vent.].
 - The "Vent." dialogue is displayed.

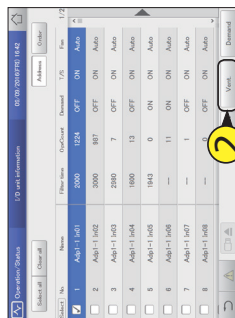

Checking the operational status of indoor units

Changing the demand control settings

Switch between setting and cancelling demand control. Refer to "Demand settings on the indoor unit" (P.89) for information about demand control.

- Put a check mark in the "Select" column.
 - Select the indoor units whose settings you want to change.
 - You can select multiple indoor units.



- Change the settings.
 - A confirmation message appears.

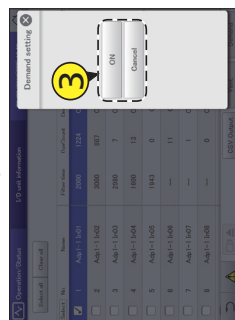

- Note**
- This setting is linked with "1/D unit demand settings." (→ "Demand settings on the indoor unit" (P.89))

- Touch [Demand].
 - The "Demand setting" dialogue is displayed.



- Touch [Yes].
 - The setting is registered.

Operation/Status

Check the status of air conditioning units

Operation/Status

Check the status of air conditioning units

Checking the operational status of the outdoor unit

Check the details about the outdoor units (outdoor temperatures, demand setting status, etc.) in a list. You can also select outdoor units to change their demand control settings (ON or OFF only).

1 Touch [Operation/Status] in "Oper./Status".

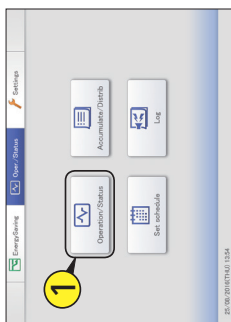

2 Touch [O/D unit information].

- The "O/D unit information" screen is displayed.

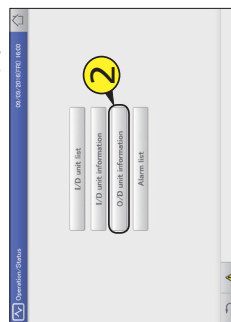

3 Check the setting details. (P.33)



Note
 • You can select outdoor units to change their demand control settings. (→ "Changing the demand control settings" (P.34))

Checking the operational status of the outdoor unit

Operation/Status

Check the status of air conditioning units

"O/D unit information" screen



A: [Select all]/[Clear all] buttons
 [Select all]
 [Clear all]
 Select all outdoor units.
 Cancel selection of all outdoor units.

B: Outdoor unit details are displayed in a list. You can scroll up or down by swiping or flicking the screen.

Item	Explanation
[Select]	Select the units you want to set demand control for.
Name	The names of the outdoor units are displayed. You can change the names. (→ "Basic settings on the outdoor unit" (P.145))
OutdrTemp	The temperature outside is displayed.
Demand	Demand control setting status is displayed (→ "Demand settings on the outdoor unit" (P.92))
Current oil change time	The number of operating hours after the last oil change is displayed.
Engine oil check sign	This displays the check sign for engine oil. (Available only when using a gas heat pump)
Inverter instant.(kW)	This displays the current value for the inverter generator instantaneous value of the ECO G HIGH POWER.
Solar instant.(kW)	This displays the current value for the solar generator instantaneous value of the ECO G HIGH POWER.

C: Change silent mode. The "Demand" dialogue is displayed when you touch this. (→ "Changing the demand control settings" (P.34))

Operation/Status

Check the status of air conditioning units

Checking the operational status of the outdoor unit

Changing the demand control settings

- Put a check mark in the "Select" column.
 - Select the outdoor units whose settings you want to change.
 - You can select multiple outdoor units.



- Touch [DmndStng].
 - The "Demand" dialog is displayed.

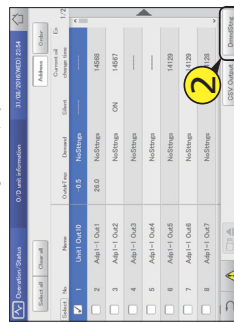

- Set the demand operating range.

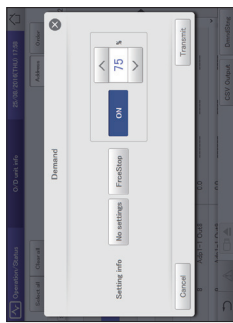

[No settings]
[FreeStop]
[ON XXX%]
[Demand (value)]

The demand operation setting is cancelled.
 Demand operation is forcibly stopped.

Use and to select an available demand value for the selected outdoor unit.

- If multiple outdoor units are selected, the demand values common between them are displayed.

- Touch [Transmit].
 - The settings are changed and the "Demand" dialogue is closed.
 - To cancel the settings, touch [Cancel].

Checking on current alarms

You can check the indoor unit names, alarm codes, and dates and times of occurrence and recovery for alarms that have occurred in the air conditioning system in a list. You can also do things such as output the alarm list in CSV format and check the alarm log.

- Touch [Operation/Status] in "Oper./Status".

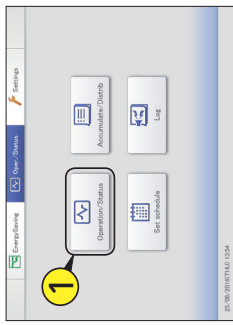

- Touch [Alarm list].
 - The "Alarm list" screen is displayed.

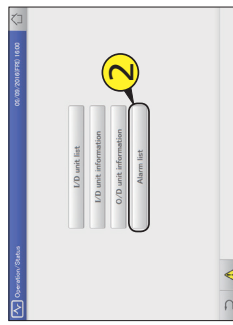

- Checking on current alarms. (P.36)



Operation/Status

Check the status of air conditioning units

Operation/Status

Check the status of air conditioning units

Checking on current alarms

Searching alarms

- 1 Touch [Search].
 - The "Search" screen is displayed.
- 3 Touch [OK].
 - Alarms matching the conditions are displayed in a list.
 - To cancel the search, touch [Cancel].

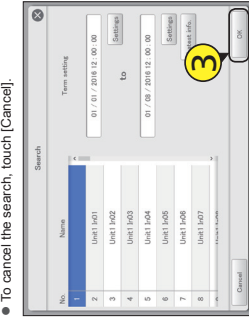

- 2 Setting the conditions.
 - The "Term setting" dialog box is displayed.
 - The "Date settings" dialog box is displayed.



Item	Explanation
Name	Select the name of the unit for which you want to find the information from the list.
Term setting	Set the start and finish for the period you want to search. The time at the top is the start of the period and the time at the bottom is the end. <ul style="list-style-type: none"> 1. For the "Date settings" dialog box is displayed. 2. Set the date and time <ul style="list-style-type: none"> • Use [] to set the "Day", "Month", "Year", "Hours", "Minutes", and "Seconds".
[Latest info.]	3. Touch [OK]. <ul style="list-style-type: none"> • The settings are registered and the "Date setting" dialogue closes. • To cancel the settings, touch [Cancel]. Touch to clear the period you have set and show the most recent 100 alarms.

Operation/Status

Check the status of air conditioning units

Checking on current alarms

"Alarm list" screen

A: Stop the alarm notification buzzer.
 B: Set conditions (unit names, periods) to search alarms. (→ "Searching alarms" (P.37))
 C: Display a list of current alarms. You can scroll up or down by swiping or flicking the screen.

Item	Explanation
Name	The names of units where alarms are occurring are displayed.
Alarm code	The alarm detail of current alarms is displayed.
Alarm date	This displays the date and time the alarm occurred.

D: You can output (save) the displayed list of alarms in CSV format. (→ "Outputting (saving) the list of alarms in CSV format" (P.38))
 E: The "Alarm log" screen is displayed when you touch this. (→ "Checking the alarm logs" (P.36))

Setting a schedule



This chapter explains how to set schedules.

You can register a single day's schedule as a pattern and then allocate to a date on the calendar. Indoor units can be registered in groups or individually.

Screen menu	Overview	Page
Schedule/results	You can see the schedules set up for the future and how they performed in the past in a list.	53
Calendar	You can allocate a single day's schedule to a calendar.	49
Schedule setting	You can register the schedule for a single day.	43
Update schedule	You can modify a schedule that you have registered (only from the day of the change up to 4 days later, or a total of 5 days).	55

Outputting (saving) the list of alarms in CSV format

1 Open the storage door and connect a USB memory device to the USB terminal.

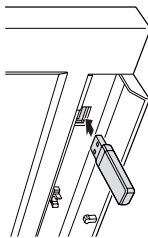

4 Touch [OK] when you want to disconnect the USB memory device. The message "USB memory can now be safely removed" is displayed. Touch [OK] and then remove the USB memory device.

- Close the storage door after removing the USB memory device.

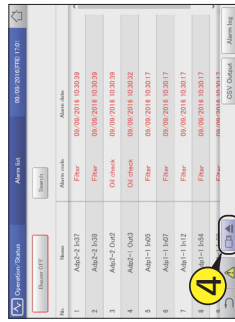

2 Touch [CSV Output].

- A confirmation screen is displayed.



3 Touch [OK].

- The list of alarms currently displayed is output (saved) to the USB memory device as a CSV file.
- When saving is complete, a message confirming that saving is complete is displayed.
- The CSV file is saved to the "fcl/csv/almist" folder. (Example file name for the output file) al_18052016.csv

Schedule setting flow

This system allows you to set schedules for each indoor unit so that they run automatically. You can set schedules by month for up to 2 years in the future. Furthermore, you can put indoor units that will run on the same schedule into "Schedule group".

Schedules are set according to the following flow.

1 Setting a schedule

- "Setting a schedule" (P.43)
- Register the schedule for indoor units.
- Decide a "daily running mode" to set when registering the schedule. You can register up to 50 types of daily running mode.

What is the "daily running mode"?

Scheduling patterns for indoor units (individually or as part of a schedule group) are called "daily running mode". Daily operating modes are registered as different patterns for schedules to match different days of the week, holidays, and seasons.

Example of daily running mode settings

- Daily running mode for a working day (Monday to Friday) ("Mode1")
- Daily running mode for Saturday ("Mode2")
- Daily running mode for Sunday ("Mode3")

* Schedule group: indoor units that run on the same schedule registered in groups. To register into schedule groups, see "Basic settings on the indoor unit" (P.141).

Schedule setting flow

What is a "setting cell"?

To set a schedule, you need to register operations in "setting cells". The "setting cell" is the smallest unit of operations used to configure a schedule. You set "Time", "ON/OFF", "OpernMode", "Temperature", "Fan SPD", "Flap", and "EnerSavStg" in a "setting cell". Each time you change an operation (for example from "ON" to "OFF"), you register a different "setting cell". A schedule consists of a collection of these "setting cells" lined up.

The following is an example schedule set for an indoor unit.

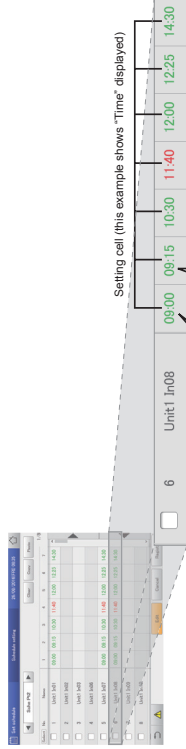

1 block equates to a setting cell, so here there are 6 settings.

Example

- In the "09:00" setting cell
- "Time": 09:00
 - "ON/OFF": ON
 - "OpernMode": Cool
 - "Temperature": 28 °C
 - "Fan SPD": Low
 - "Flap": Swing

Example

- In the "09:15" setting cell
- "Time": 09:15
 - "ON/OFF": ON (no change to the setting)
 - "OpernMode": Dry
 - "Temperature": 28 °C (no change to the setting)
 - "Fan SPD": Low (no change to the setting)
 - "Flap": Swing (no change to the setting)

The following summarises the flow followed when setting a schedule.

- (1) Select the daily running mode to register for a schedule.
- (2) Select an indoor unit or schedule group.
- (3) Set the schedule.
- (4) Register the setting.

Operation/Status

Setting a schedule

Operation/Status

Setting a schedule

Schedule setting flow

2 Allocating a schedule to a date on the calendar

- "Allocating a schedule to a calendar" (P.49)

SUN	MON	TUE	WED	THU	FRI	SAT
1	2	3	4	5	6	
7	8	9	10	11	12	13
14	15	16	17	18	19	20
21	22	23	24	25	26	27
28	29	30				

This day is a Sunday, so allocate "Mode3"

This day is a Saturday, so allocate "Mode2"

This day is a work day, so allocate "Mode1"

Operation/Status Setting a schedule

Setting a schedule

Register the schedules for an indoor unit or a schedule group in the "daily running mode".

1 Touch [Set schedule] in "Oper./Status".

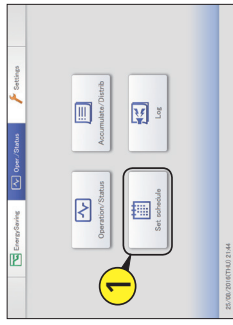

2 Touch [Schedule setting].

- The "Schedule setting" screen is displayed.

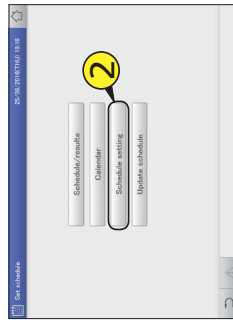

4 Put a check mark in the "Select" column.

- Select the indoor unit or schedule group you want to set.

Unit No.	0900	0915	10:00	11:40	12:00	12:25	14:00
Unit 1/401	<input type="checkbox"/>	<input type="checkbox"/>	<input type="checkbox"/>	<input type="checkbox"/>	<input type="checkbox"/>	<input type="checkbox"/>	<input type="checkbox"/>
Unit 1/402	<input type="checkbox"/>	<input type="checkbox"/>	<input type="checkbox"/>	<input type="checkbox"/>	<input type="checkbox"/>	<input type="checkbox"/>	<input type="checkbox"/>
Unit 1/403	<input type="checkbox"/>	<input type="checkbox"/>	<input type="checkbox"/>	<input type="checkbox"/>	<input type="checkbox"/>	<input type="checkbox"/>	<input type="checkbox"/>
Unit 1/406	<input type="checkbox"/>	<input type="checkbox"/>	<input type="checkbox"/>	<input type="checkbox"/>	<input type="checkbox"/>	<input type="checkbox"/>	<input type="checkbox"/>
Unit 1/407	<input type="checkbox"/>	<input type="checkbox"/>	<input type="checkbox"/>	<input type="checkbox"/>	<input type="checkbox"/>	<input type="checkbox"/>	<input type="checkbox"/>
Unit 1/408	<input type="checkbox"/>	<input type="checkbox"/>	<input type="checkbox"/>	<input type="checkbox"/>	<input type="checkbox"/>	<input type="checkbox"/>	<input type="checkbox"/>
Unit 1/409	<input type="checkbox"/>	<input type="checkbox"/>	<input type="checkbox"/>	<input type="checkbox"/>	<input type="checkbox"/>	<input type="checkbox"/>	<input type="checkbox"/>
Unit 1/110	<input type="checkbox"/>	<input type="checkbox"/>	<input type="checkbox"/>	<input type="checkbox"/>	<input type="checkbox"/>	<input type="checkbox"/>	<input type="checkbox"/>

5 Touch [Edit].

- The "Detail setting" screen is displayed.

Unit No.	0900	0915	10:00	11:40	12:00	12:25	14:00
Unit 1/401	<input type="checkbox"/>	<input type="checkbox"/>	<input type="checkbox"/>	<input type="checkbox"/>	<input type="checkbox"/>	<input type="checkbox"/>	<input type="checkbox"/>
Unit 1/402	<input type="checkbox"/>	<input type="checkbox"/>	<input type="checkbox"/>	<input type="checkbox"/>	<input type="checkbox"/>	<input type="checkbox"/>	<input type="checkbox"/>
Unit 1/403	<input type="checkbox"/>	<input type="checkbox"/>	<input type="checkbox"/>	<input type="checkbox"/>	<input type="checkbox"/>	<input type="checkbox"/>	<input type="checkbox"/>
Unit 1/406	<input type="checkbox"/>	<input type="checkbox"/>	<input type="checkbox"/>	<input type="checkbox"/>	<input type="checkbox"/>	<input type="checkbox"/>	<input type="checkbox"/>
Unit 1/407	<input type="checkbox"/>	<input type="checkbox"/>	<input type="checkbox"/>	<input type="checkbox"/>	<input type="checkbox"/>	<input type="checkbox"/>	<input type="checkbox"/>
Unit 1/408	<input type="checkbox"/>	<input type="checkbox"/>	<input type="checkbox"/>	<input type="checkbox"/>	<input type="checkbox"/>	<input type="checkbox"/>	<input type="checkbox"/>
Unit 1/409	<input type="checkbox"/>	<input type="checkbox"/>	<input type="checkbox"/>	<input type="checkbox"/>	<input type="checkbox"/>	<input type="checkbox"/>	<input type="checkbox"/>
Unit 1/110	<input type="checkbox"/>	<input type="checkbox"/>	<input type="checkbox"/>	<input type="checkbox"/>	<input type="checkbox"/>	<input type="checkbox"/>	<input type="checkbox"/>

3 Press [Daily running mode] to select the daily running mode.

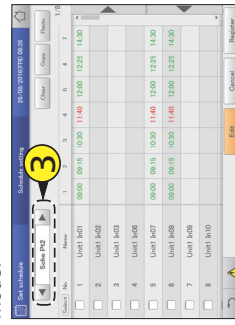

Continued on next page

Setting a schedule

6 Register setting cells.

- Repeat the following (1) to (3) to register setting cells.
- (1) Touch [New data].**
 - The "Stig" dialogue is displayed.
 - In the "Stig" dialogue, set "Time", "ON/OFF", "OpernMode", "Temperature", "Fan SPD", "Flap", "Phbt", and "EnerSavStg".

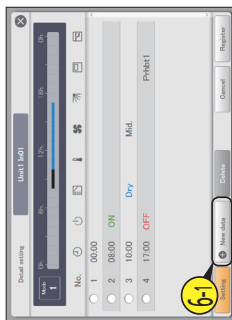

(2) Change the settings.

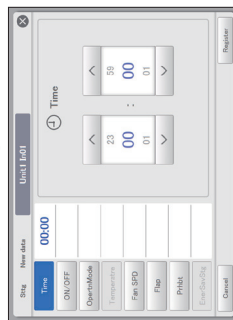

Item	Explanation
Time	Set the time for the operation. 1) Touch [Time]. 2) Use [↑] [↓] to set the "hour" and "minute".
ON/OFF	Set whether to start or stop operation. 1) Touch [ON/OFF]. 2) Select "ON" or "OFF".
OpernMode	Set the operating mode. 1) Touch [OpernMode]. 2) Select the operating mode (heating), (drying), (cooling), (fan), (automatic).

Setting a schedule

Item	Explanation
Temperature	Set the temperature. 1) Touch [Temperature]. 2) Set the temperature with [↑] and [↓] (in 1°C steps). Setting ranges • Heating mode: Between 18 °C and 30 °C • In heating mode: Between 16 °C and 30 °C* *1 The upper limit for gas heat pump air conditioners is 28 °C.
Fan SPD	Set the strength of the fan. 1) Touch [Fan SPD]. 2) Select the fan speed (High, (mid), (low), (automatic)).
Flap	1) Touch [Flap]. 2) Set the flap to the desired position (F1), (F2), (F3), (F4), (F5), (F6). • Heating, fan, and automatic (heating) can be adjusted in 5 steps and cooling and dry can be adjusted in 3 steps. • You can set either (F1) or (F6), if the model does not support airflow direction settings.
Phbt	Set whether to allow or prohibit use of the local remote controller. 1) Touch [Phbt]. 2) Use [↑] [↓] to select from "Accept", "Phbt1", "Phbt2", "Phbt3", or "Phbt4". Accept: Allows operations with the remote controller. Phbt1 to Phbt4: Operations on the remote controller are restricted. You can change the restricted operations. (P.185)
EnerSavStg	Enable or disable energy saving operation. 1) Touch [EnerSavStg]. 2) Select "Valid" or "Invl".

Note

- You do not have to set all items, but "Time" must be set.
- You can register up to 50 setting cells per day for a single indoor unit or single schedule group.
- When setting schedule groups, you can only set those items that are common to the indoor units that make up the group.

Continued on next page

Operation/Status

Setting a schedule

9

Touch [Register].

- A confirmation message appears.
- To cancel the settings, touch [Cancel].

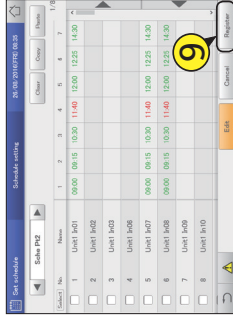

7

Touch [Register].

- The "Detail setting" dialogue closes.
- To cancel the settings, touch [Cancel].

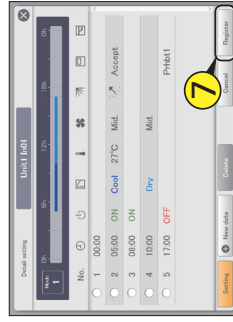

10

Touch [OK].

- The setting is registered.
- The confirmation message "Change sched. for the next day to 4 days later?" may be displayed.
- To overwrite the setting touch [OK]. To change, touch [Cancel].

Note

- Indoor units or schedule groups whose setting cells are all blank will not run at all.

8

Repeat steps 4 to 7 to register other indoor units.

- Repeat steps 3 to 7 if you want to register in other daily running modes.
- The confirmation message "Change sched. for the next day to 4 days later?" may be displayed.
- To overwrite the setting touch [OK]. To change, touch [Cancel].

Setting a schedule

Operation/Status

Setting a schedule

2 Touch [Copy].

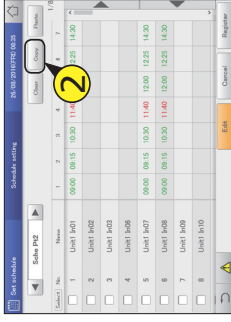

Deleting a schedule

1 Select the schedule to delete.

- The highlighted indoor unit or schedule group is the one to be deleted.
- You cannot delete multiple indoor units or schedule groups.

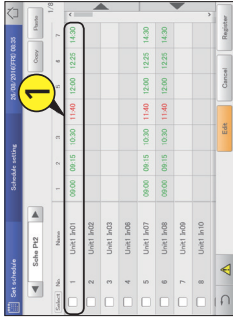

2 Touch [Clear].

- The selected schedule is deleted.
- The schedule is restored if you touch [Cancel].

Copy a schedule for setting

This is convenient when setting the same kind of schedule.

1 Select the schedule to copy.

- The highlighted indoor unit or schedule group is the one to be copied.

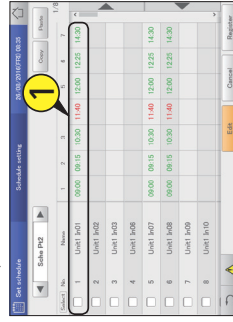

3 Select the indoor unit or schedule group you want to paste.

- You cannot simultaneously paste multiple indoor units or schedule groups.

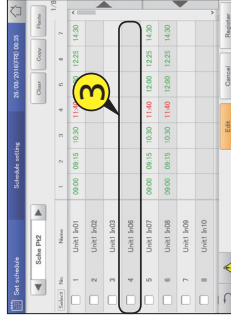

4 Touch [Paste].

- The selected schedule is pasted.

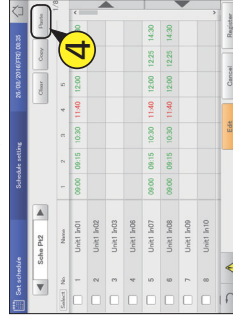

Setting a schedule

Operation/Status

Setting a schedule

The "Schedule setting" screen

A: Select the daily running mode to register. You can select daily running modes from the following types.

- Register as a normal pattern. (Modes 1 to 50)
- Use [Mode] to select the daily running mode. The display order is as follows. "Mode1" ⇄ "Mode2" ⇄ ... ⇄ "Mode50"

B: You can delete the selected schedule either by indoor unit or by schedule group.

C: You can copy the selected schedule either by indoor unit or by schedule group.

D: You can paste the schedule specified at C to an indoor unit or schedule group.

E: You can view the schedule for a single day in a list.

F: You can scroll up or down by swiping or flicking the screen.

Note

- Before setting an operating schedule, the setting cell on the right is blank.
- When at least one check mark has been put in the "Valid" column in the "Set schedule group name" screen (refer to "Changing the name of the schedule group" (P.157)), the schedule group name is displayed first, then the indoor unit names that do not belong to schedule groups are displayed.
- The "Detail setting" dialogue is displayed when you touch this, and you can make advanced settings for the schedule.

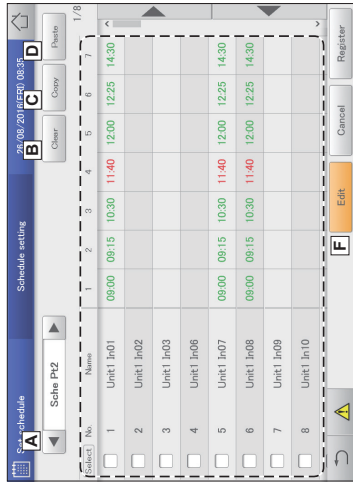

The "Detail setting" dialogue

A: The name of the selected indoor unit or schedule group is displayed.

B: The daily running mode is displayed.

C: Set schedules are displayed in a timetable. View a list of registered setting cells. Each line is one setting cell.

D: You can scroll up or down by swiping or flicking the screen.

E: Modify the registered content of setting cells. (→ "Changing the settings in setting cells" (P.48))

F: The "Stg" dialogue is displayed when you touch this and you can add setting cells.

G: Delete the registered content of setting cells. (→ "Deleting the settings in setting cells" (P.48))

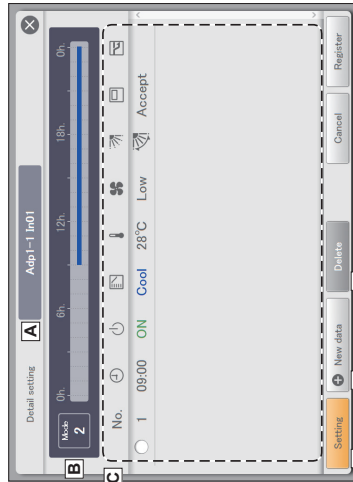

Setting a schedule

Allocating a schedule to a calendar

Allocate daily running modes to a calendar. Calendars can be set starting with the current month and up to 2 years in the future.

Deleting the settings in setting cells

Changing the settings in setting cells

1 Select the setting cell to be deleted in the "Detail setting" dialogue.

1 Select the setting cell to be changed (1-1) in the "Detail setting" dialogue and touch [Setting] (1-2).

- The "Stig" dialogue is displayed.

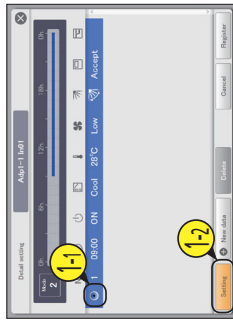

2 Touch [Delete].

- The selected setting cell is deleted.



2 Change the settings.

- Refer to step 6 on P.44 for the settings.

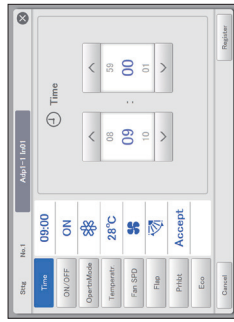

3 Touch [Register].

- The settings are registered and the "Stig" dialogue closes.
- To cancel the settings, touch [Cancel].

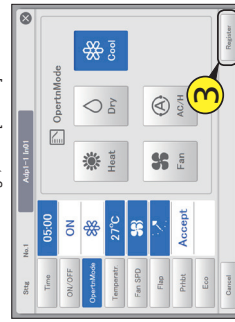

Operation/Status

Setting a schedule

1 Touch [Set schedule] in "Oper./Status".



4 Select the daily running mode.

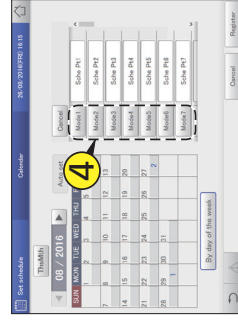

2 Touch [Calendar].

- The "Calendar" screen is displayed.

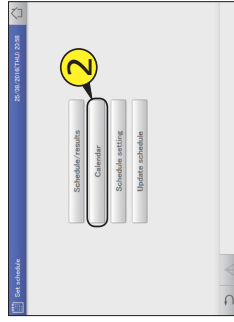

5 Touch the date.

- The daily running mode is allocated to the selected date.
- While a daily running mode is selected, you can allocate it to other dates.
- Repeat steps 4 and 5 to allocated daily running modes to other dates.

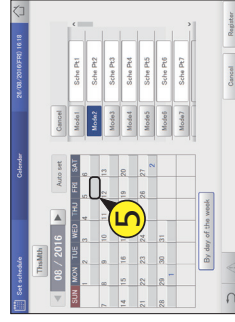

3 Use [Left Arrow] [Right Arrow] to select the year and month.

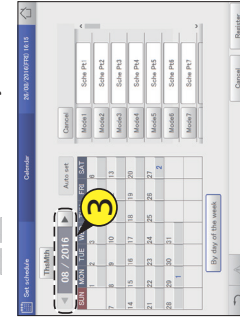

6 Touch [Register].

- The setting is registered.
- To cancel the settings, touch [Cancel].

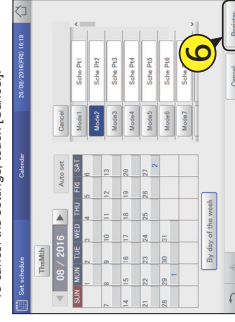

Operation/Status

Setting a schedule

Allocating a schedule to a calendar

- Note**
- You cannot allocate daily running modes to dates in the past.

The "Calendar" screen

- A: Returns the calendar display to the current month.
- B: The calendar for the specified year and month is displayed.
- C: Automatic update is executed.
- D: Delete the daily running mode allocated to a calendar. (→ "Deleting allocated daily running modes" (P.51))
- E: A list of daily running modes allocated to the calendar is displayed. You can put comments in the text boxes on the right. (→ "Adding comments to daily running modes" (P.51))
- F: Allocate modes by day of the week. (→ "Allocating by day of the week" (P.52))

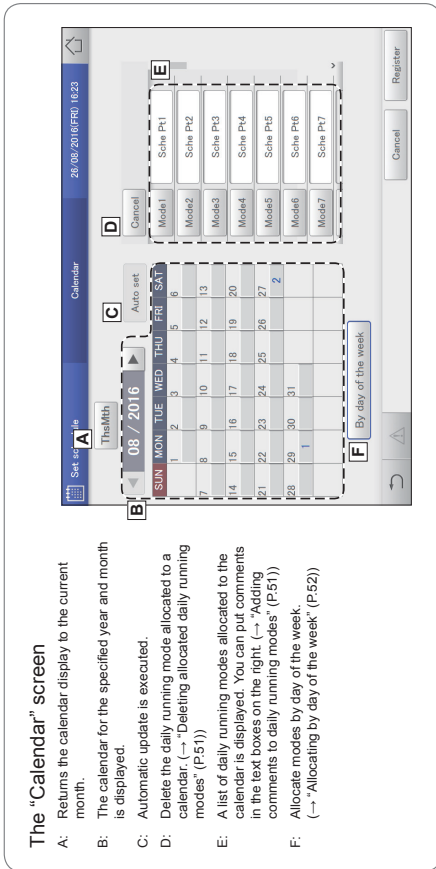

Operation/Status

Setting a schedule

Allocating a schedule to a calendar

Deleting allocated daily running modes

- 1 Touch [Cancel].



- 2 Touch the date of the daily running mode to be deleted.



Adding comments to daily running modes

It can be helpful to add a comment to the daily running mode to describe how it is used, for example. The comment can be up to 16 characters long using letters and numbers.

- 1 Touch the text box on the right of the daily running mode.

- The touchscreen keyboard is displayed.

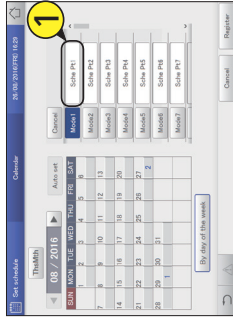

- 2 Enter the text.

- 3 Touch [Register].

- The setting is registered.
- To cancel the settings, touch [Cancel].

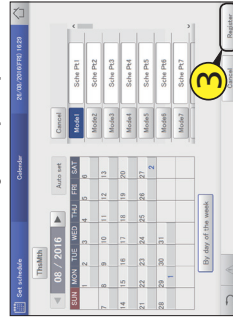

Operation/Status

Setting a schedule

Operation/Status

Setting a schedule

Allocating a schedule to a calendar

Allocating by day of the week

Allocate daily running modes by day of the week.

1 Touch [By day of the week].

- The "By day of the week" screen is displayed.

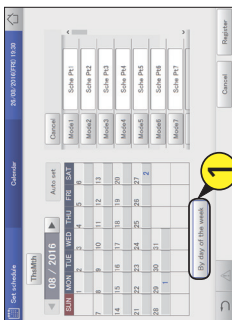

3 Use to allocate the daily running modes to days of the week.



2 Set the period.

(1) Touch (2-1).

- The "Calendar" dialogue is displayed.
- The period at the left is the start and the period at the right is the end.

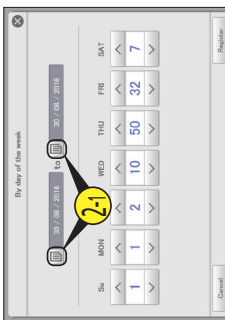

(2) Use to select the month to be set (2-2), then select the day to be set (2-3).

- The settings are registered and the "Calendar" dialogue closes.

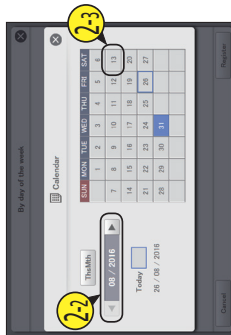

- Note**
- You cannot allocate daily running modes by day of the week to the current day, the next day, or the day after the next day.
 - You do not need to set daily running modes in every day of the week.
 - You do not need to touch [Register] or [Cancel] in the "Calendar" screen.
 - If daily running modes have already been registered in the calendar, then when you set at the day of the week level, the daily running modes are overwritten.

Checking the future schedule and past performance

You can see the registered schedules in a list.
You can also see how operations performed in the past.

1 Touch [Set schedule] in "Oper./Status".

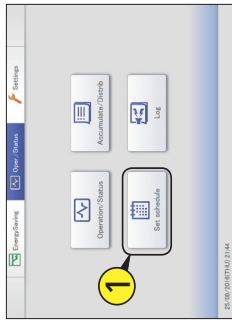

(2) Use to select the month to be set (3-2), then select the date (3-3).

- The settings are registered and the "Calendar" dialogue closes.



2 Touch [Schedule/results].

- The "Schedule/results" screen for that day is displayed.

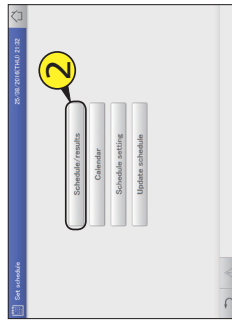

4 Touch the "Select" column (4-1), then touch [DetailScd] (4-2).

- The "Detailed scheduler" dialogue (P.54) is displayed.

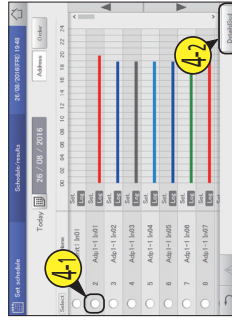

3 Set the day you want to check.

(1) Touch (3-1).

- The "Calendar" dialogue is displayed.

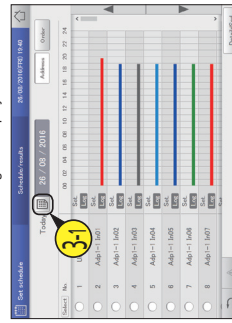

Operation/Status

Setting a schedule

Operation/Status

Setting a schedule

Checking the future schedule and past performance

“Scheduler/results” screen

- A: Select the year, month, and day to display. The calendar screen is displayed when you touch and you can select the date.
- B: Change list order. The list order changes each time you touch it.

Display	The display follows the order set in “ID unit settings” (P.44).
ID unit	The display follows the address order of the outdoor unit systems.
Address	The display follows the order of the central addresses.

- C: The day's schedule and past operating performance is displayed in a list for each indoor unit. The schedules are displayed in the 24-hour format with the passage of time indicated with a horizontal line. The upper part of the row shows the planned schedule and the lower part of the row shows the past performance.

The colour key is as follows:

- Blue: Cooling
- Red: Warming
- Green: Automatic
- Light blue: Dry
- Grey: Fan

Note

- Past performance is not displayed in the following cases:
 - When a date after the next day is specified in setting A.
 - When the power of the indoor unit has been turned off so that the schedule could not be executed
- The “Detailed schedule” dialogue is displayed when you touch this. Details about the schedules for indoor units with a check mark in the “Select” column are displayed.

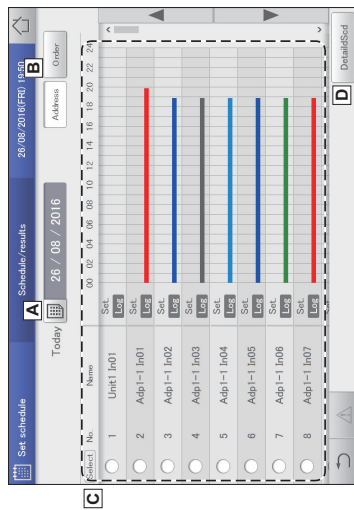

The “Detailed schedule” dialogue

- A: The name of the selected indoor unit or schedule group is displayed.
- B: The daily running mode is displayed. The time line for a set schedule for one day is displayed.
- C: Details of B are displayed in a list.

Note

- You can check the future schedule in this screen. Settings cannot be changed.

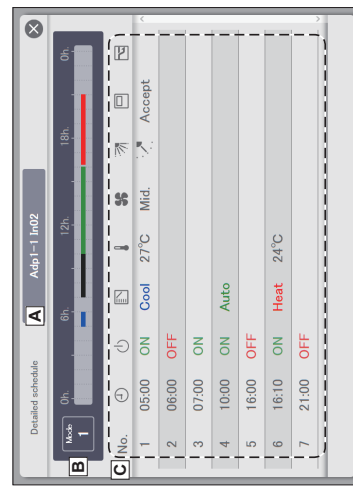

Temporarily modifying or adding a schedule

You can temporarily change the schedule for five days starting with the current day and up to 4 days into the future. You cannot change the settings in the “Schedule setting” screen.

1 Touch [Set schedule] in “Oper./Status”.

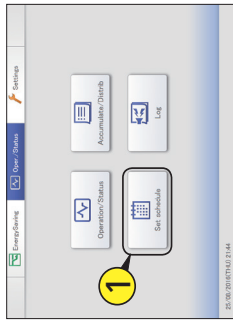

4

- Put a check mark in the “Select” column.
- Select the indoor unit or schedule group whose settings you want to change.

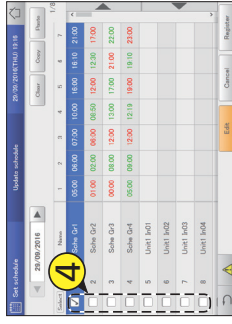

2

Touch [Update schedule].

- The “Update schedule” screen is displayed.

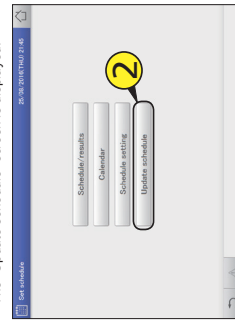

5

Touch [Edit].

- The “Detail setting” dialogue is displayed.



Use and to select the year, month, and day.

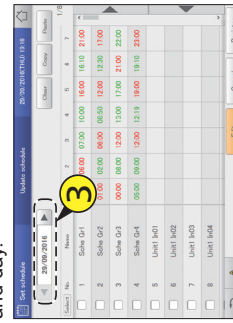

6

Change and add settings.

- Refer to “Changing the settings in setting cells” (P.48) to change the settings.
- Refer to step 6 in “Setting a schedule” (P.44) to add settings.
- Refer to step 6 in “Setting a schedule” (P.44) for the setting items.

Continued on next page

Operation/Status

Setting a schedule

Operation/Status

Setting a schedule

Checking the alarm logs and operation/status change logs



This chapter explains how to check alarm logs and operation/status change logs.

You can check the logs for alarms that have occurred in the system and the logs of operation/status changes in lists on this unit.
You can also output the log lists in a CSV format file.

Screen menu	Overview	Page
Alarm log	Check the log of alarms that have occurred in the system in a list.	58
Operation/Status change log	Check the log of operation/status changes of the indoor units in a list.	61

Temporarily modifying or adding a schedule

8

Touch [Register].

- The setting is registered.
- To cancel the settings, touch [Cancel].

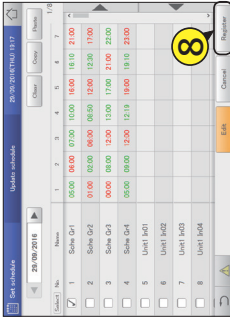

7

Touch [Register].

- The settings are registered and the "Detail setting" dialogue closes.
- To cancel the settings, touch [Cancel].

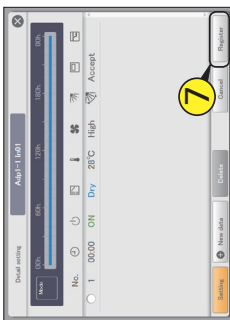

Note

- Even if you change the schedule in this screen, the daily running mode settings in the "Schedule setting" screen are not changed.

The "Update schedule" screen

A: Select the year, month, and day to change.

- Only the current day and 4 days into the future are shown in the date.

B: You can delete the selected schedule either by indoor unit or by schedule group.
(→ "Deleting a schedule" (P.47))

C: You can copy the selected schedule either by indoor unit or by schedule group. (→ "Copy a schedule for setting" (P.47))

D: Paste the schedule specified at C to an indoor unit or schedule group.
(→ "Copy a schedule for setting" (P.47))

E: View the operating schedule for a single day in a list.

F: When you touch this, the "Detail setting" dialogue is displayed for indoor units or schedule groups with a check mark in the "Select" column.

Checking the alarm logs

You can display up to 100 of the most recent alarms that have occurred or that have been restored.

1 Touch [Log] in "Oper./Status".

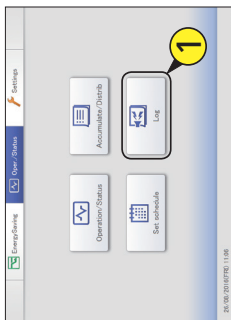

2 Touch [Alarm log].

- The "Alarm log" screen is displayed.
- Alarms are in red letters immediately after occurring. They change to green letters after they are restored.

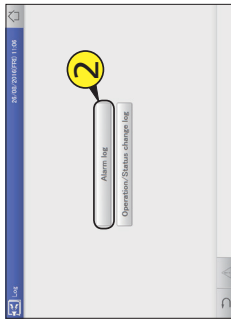

Operation/Status

Checking the alarm logs and operation/status change logs

The "Alarm log" screen

No.	Name	Alarm code	Date/Time of Alarm ON/OFF	Alarm	Check
1	Adp-1-1a09	E06	25.08/2018 14:07:39	ON	<input type="checkbox"/>
2	Adp-1-1a04	E02	25.08/2018 14:07:39	ON	<input type="checkbox"/>
3	Adp-1-1a03	E01	25.08/2018 14:07:39	ON	<input type="checkbox"/>
4	PostConfigChange	Config. change	06/07/2018 14:05:08	OFF	<input checked="" type="checkbox"/>
5	PostConfigChange	Config. change	06/07/2018 14:02:59	ON	<input type="checkbox"/>
6	PostConfigChange	Config. change	13.05/2018 14:17:25	OFF	<input type="checkbox"/>
7	PostConfigChange	Config. change	13.05/2018 11:09:39	ON	<input type="checkbox"/>
8	PostConfigChange	Config. change	13.05/2018 10:43:22	ON	<input type="checkbox"/>

- A: The "Search" dialogue is displayed when you touch this. You can find the log information you need from amongst the logs for alarms that have occurred. You can search by either the device name or the display period. (→ "Searching alarm logs" (P:59))
- B: A check mark appears in all of the "Check" columns when you touch this.
- C: The alarm log is displayed in a list. You can scroll up or down by swiping or flicking the screen.

Item	Explanation
Name	The names of units where alarms are occurring are displayed.
Alarm code	The type of alarm is displayed.
Date/Time of Alarm ON/OFF	This displays the date and time the alarm occurred. When a problem in the system has been restored, this shows the date and time it was restored.
Alarm	Immediately after an alarm has occurred, this shows "ON", and after it is restored it shows "OFF".
Check	Select the alarms you want to check.

- D: You can output (save) the displayed list of alarm logs in CSV format. (→ "Outputting (saving) logs as a CSV file" (P:60))
- E: The "Alarm list" screen is displayed when you touch this. (P:35)

Searching alarm logs

1 Touch [Search].

- The "Search" dialogue is displayed.



3 Touch [OK].

- Alarms matching the conditions are displayed in a list.
- If you specify name, the latest 200 alarms are displayed. If you do not specify, the latest 100 alarms for all units are displayed.
- If you specify period, the latest 200 alarms are displayed.
- You can save the search results in a file in the CSV format. (→ "Outputting (saving) logs as a CSV file" (P:60))
- To cancel display conditions, touch [Cancel].

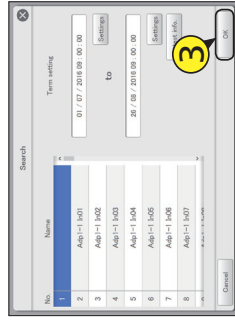

2 Set the search conditions.



Item	Explanation
Name	Select the name of the unit for which you want to find the information from the list.
Term setting	Set the start and finish for the period you want to search. The time at the top is the start of the period and the time at the bottom is the end. 1) The "Date setting" dialogue is displayed. • The "Date setting" dialogue is displayed. • Use \uparrow \downarrow to set the "Day", "Month", "Year", "Hours", "Minutes", and "Seconds". 2) Set the date and time. • Use \uparrow \downarrow to set the "Day", "Month", "Year", "Hours", "Minutes", and "Seconds".
[Latest info.]	3) Touch [OK]. • The settings are registered and the "Date setting" dialogue closes. • To cancel the settings, touch [Cancel]. Touch to clear the period you have set and show the most recent 100 alarms.

Checking the alarm logs

Outputting (saving) logs as a CSV file

1 Open the storage door and connect a USB memory device to the USB terminal.

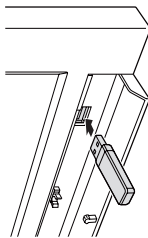

2 Touch [CSV Output].

- A confirmation screen is displayed.

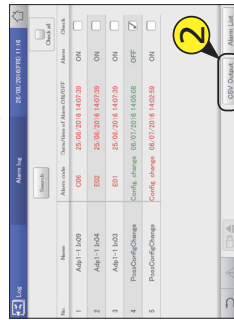

3 Touch [OK].

- The alarm log currently displayed is saved to the USB memory device in CSV format.
- When saving is complete, a message confirming that saving is complete is displayed.

4 Touch [] when you want to disconnect the USB memory device.

- The message "USB memory can now be safely removed" is displayed. Touch [OK] and then remove the USB memory device.
- Close the storage door after removing the USB memory device.

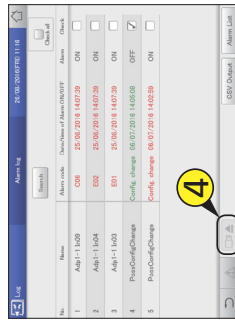

Operation/Status

Checking the alarm logs and operation/status change logs

Checking the operation/status change log in a list

You can display a list showing operations for indoor units that logs when and how changes were made.

1 Touch [Log] in "Oper./Status".

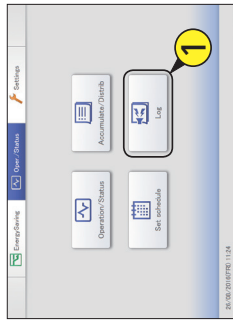

2 Touch [Operation/Status change log].

- The "Operation/Status change log" screen is displayed.

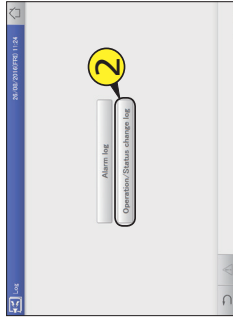

The "Operation/Status change log" screen

No.	Name	Operation	Status	Mode
1	Adp1-1 In37	Status change	OFF	A/Cool
2	Adp1-1 In38	Status change	OFF	A/Cool
3	Adp1-1 In39	Status change	OFF	A/Cool
4	Adp1-1 In40	Status change	OFF	A/Cool
5	Adp1-1 In41	Status change	OFF	A/Cool
6	Adp1-1 In42	Status change	OFF	A/Cool
7	Adp1-1 In43	Status change	OFF	A/Cool
8	Adp1-1 In44	Status change	OFF	A/Cool

- A: The operation log is displayed. This is usually displayed. Touch to hide.
- B: The status change log is displayed. This is usually displayed. Touch to hide.
- C: The "Search" dialogue is displayed when you touch this. You can find the log information you need from amongst the operation/status change logs.
- D: You can search by either the device name or the display period. (→ "Searching operation/status change logs" (P.62))
- E: The operation/status change logs are displayed in a list.

Item	Explanation
Name	The names of the units are displayed.
Operation	This shows whether the operation occurred as schedule or if the operation was changed.
Status	This indicates the operating status (ON or OFF).
Mode	The operating mode (Heat, Dry, Cool, Fan, A/Heat, A/Cool) is displayed.
Set T.	The temperature setting is displayed.
Fan	The fan speed (High, Mid, Low, Auto) is displayed.
Flap	The airflow direction is displayed.
Prnbt	This indicates the remote controller operation "Accept", or "Prnbt" to "Prnbt4".
Date	The date and time of the change to operational status is displayed.

- E: You can output (save) the displayed list of operation/status change logs in CSV format. (→ "Outputting (saving) logs as a CSV file" (P.63))

Checking the operation/status change log in a list

Searching operation/status change logs

1 Touch [Search].

- The "Search" dialogue is displayed.



2 Set the search conditions.



Item	Explanation
Name	Select the name of the unit for which you want to find the information from the list.
Term setting	Set the start and finish for the period you want to search. The time at the top is the start of the period and the time at the bottom is the end. 1) Touch [Settings]. • The "Date setting" dialogue is displayed. 2) Set the date and time. Use \leftarrow \rightarrow to set the "Day", "Month", "Year", "Hours", "Minutes", and "Seconds". 3) Touch [OK]. • The settings are registered and the "Date setting" dialogue closes. • To cancel the settings, touch [Cancel].
[Latest info.]	Touch to clear the period you have set and show the most recent 100 alarms.

3 Touch [OK].

- Operation/status change logs matching the conditions are displayed in a list.
- If you specify device, the latest 200 operation logs are displayed. If you do not specify the device, the latest 100 operation logs for all devices are displayed.
- If you specify period, the latest 200 operation logs are displayed.
- You can save the search results in a file in the CSV format. (→ "Outputting (saving)" logs as a CSV file" (P.63))
- To cancel the search, touch [Cancel].

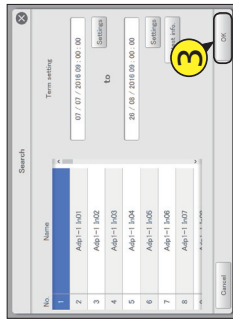

Checking the operation/status change log in a list

Outputting (saving) logs as a CSV file

1

Open the storage door and connect a USB memory device to the USB terminal.

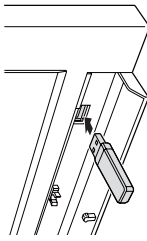

2

Touch [CSV Output].

- A confirmation screen is displayed.

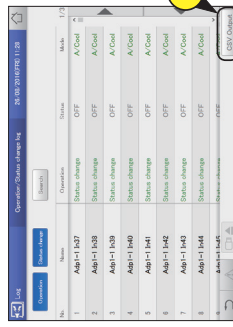

3

Touch [OK].

- The log currently displayed is saved to the USB memory device in CSV format.
- When saving is complete, a message confirming that saving is complete is displayed.

Operation/Status

Checking the alarm logs and operation/status change logs

Operation/Status

Checking the alarm logs and operation/status change logs

4

Touch \leftarrow when you want to disconnect the USB memory device.

- The message "USB memory can now be safely removed" is displayed. Touch [OK] and then remove the USB memory device.
- Close the storage door after removing the USB memory device.

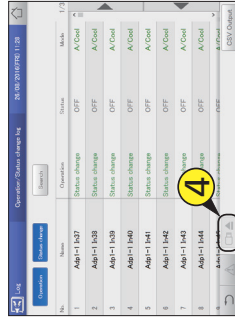

Checking the list of accumulated values on the indoor unit

The accumulated values for indoor units (thermostat ON operating times, etc.) are displayed in a list.

1 Touch [Accumulate/Distrib] in "Oper./Status".

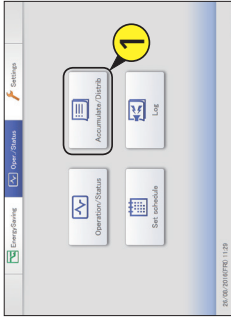

(1) Touch [Calendar] (3-1).
 • The "Calendar" dialogue is displayed showing the current date.



(2) Touch the date (3-2).
 • Use ← and → to select the month you want to check. The current month is displayed if you touch [First/Left].
 • The settings are registered and the "Calendar" dialogue closes.



2 Touch [I/D unit acc.].

• The "I/D unit acc." screen is displayed.

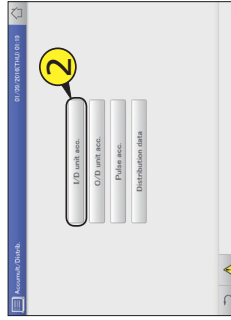

3 Set the period to be displayed.

- Set the start and end of the period to be displayed.
- The time at the left is the start of the period and the time at the right is the end.
- If you set "Data" to "Adaptor value", you cannot select the period to be displayed.

4 Set the time slots to display.

- (1) Touch [Time] (4-1).
 • The "Specify time" dialogue is displayed.
 • If you set "Data" to "Adaptor value", you cannot select the time slots to be displayed.



Operation/Status

Check accumulated values

Check accumulated values



This chapter explains how to check the accumulated values for the devices.
 You can check accumulated values for indoor units, outdoor units, and pulse meters in a list on this unit.
 The display for indoor units can be viewed by area or individual unit, and outdoor units and pulse meters can be viewed by different values (adaptor value or total value for a period).

Screen menu	Page
I/D unit acc.	65
O/D unit acc.	67
Pulse acc.	69

Continued on next page

Checking the list of accumulated values on the indoor unit

(2) Touch the time slot to accumulate (4-2).

- The settings are registered and the "Specify time" dialogue is displayed when you touch this.
- Refer to "Rgr/HourRng" in "Calendar stps for distr cal" (P-148) for information about "Rgr hour" to "Rgr hour8".

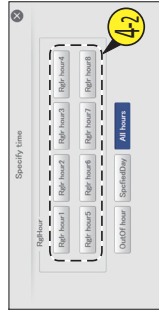

5

Check accumulated values.

No.	Name	Area	ON/High	OFF/Low	CSV	Total T/S OFF
1	Unit1 In02	0	315.89	25.72	341.62	
2	Unit1 In03	0	43.88	0.00	43.88	
3	Unit1 In04	0	43.70	0.00	43.70	
4	Unit1 In05	0	43.38	0.00	43.38	
5	Unit1 In06	0	410.02	0.00	410.02	
6	Unit1 In07	0	0.00	0.00	0.00	
7	Unit1 In08	0	0.00	0.00	0.00	
8	Unit1 In09	0	0.00	0.00	0.00	

The "/D unit acc." screen

No.	Name	Area	ON/High	OFF/Low	Total T/S OFF
1	Unit1 In02	0	315.89	25.72	341.62
2	Unit1 In03	0	43.88	0.00	43.88
3	Unit1 In04	0	43.70	0.00	43.70
4	Unit1 In05	0	43.38	0.00	43.38
5	Unit1 In06	0	410.02	0.00	410.02
6	Unit1 In07	0	0.00	0.00	0.00
7	Unit1 In08	0	0.00	0.00	0.00
8	Unit1 In09	0	0.00	0.00	0.00

- A: Set the order of display.
 - [Area] Display indoor units by area.
 - [/D unit] Display indoor units in display order.
- B: Set the displayed values: The "Data type" dialogue is displayed when you touch this. Select from "Adaptor value", "Balance total", or "WeightFactBinocTH".
- C: Set the periods to be displayed. The "Calendar dialogue" is displayed when you touch this.
- D: Set the time slots to be displayed. The "Specify time" dialogue is displayed when you touch this.
- E: The accumulated values for indoor units are displayed in a list. You can scroll up or down by swiping or flicking the screen.

Item	Explanation
Name	The names of the indoor units are displayed.
Area	The area number that the indoor unit belongs to is displayed.
ON/High	Displays the accumulated operating hours when the thermostat is "ON" and the fan is set to "High".
ON/Mid	Displays the accumulated operating hours when the thermostat is "ON" and the fan is set to "Mid".
ON/Low	Displays the accumulated operating hours when the thermostat is "ON" and the fan is set to "Low".
Total T/S ON	Displays the accumulated operating hours when the thermostat is "ON" and when "ON/High", "ON/Mid", and "ON/Low" (touched).
OFF/High	Displays the accumulated hours when the thermostat is "OFF" and the fan is set to "High". (When [T/S OFF details] is touched)
OFF/Mid	Displays the accumulated hours when the thermostat is "OFF" and the fan is set to "Mid". (When [T/S OFF details] is touched)
OFF/Low	Displays the accumulated hours when the thermostat is "OFF" and the fan is set to "Low". (When [T/S OFF details] is touched)
Total T/S OFF	Displays the accumulated hours when the thermostat is "OFF".
Elec Htr ON	Displays the accumulated hours when the heater is "ON". (When [T/S OFF details] is touched)
T/S ON + T/S OFF	Displays all the accumulated operating hours.

- F: The "OFF/High", "OFF/Mid", "OFF/Low", and "Elec Htr ON" items are added to the display when you touch this. Touch again to return to the items displayed previously.

Checking the list of accumulated values on the outdoor unit

The accumulated values for outdoor units (engine operating times, engine operation cycles, etc.) are displayed in a list.

1 Touch [Accumulate/Distrib] in "Oper./Status".

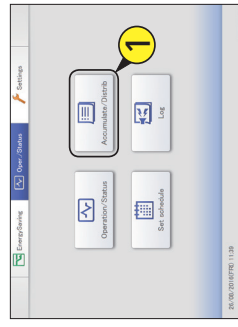

(1) Touch [Calendar] (3-1).

- The "Calendar" dialogue is displayed showing the current date.

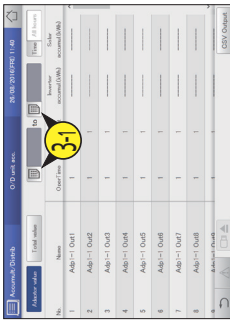

2 Touch [O/D unit acc.].

- The "O/D unit acc." screen is displayed.

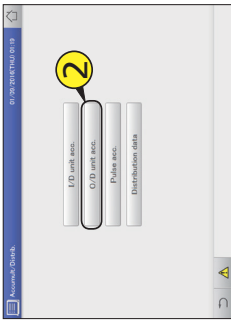

(2) Touch the date (3-2).

- Use [Left Arrow] to select the month you want to check. The current month is displayed if you touch [Right Arrow].
- The settings are registered and the "Calendar" dialogue closes.

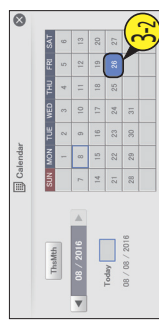

3 Set the period to be displayed.

- Set the start and end of the period to be displayed.
- The time at the left is the start of the period and the time at the right is the end.
- If you set the "Adaptor value", you cannot select the period to be displayed.

4 Set the time slots to display.

- (1) Touch [Time] (4-1).
- The "Specify time" dialogue is displayed.
- If you set the "Adaptor value", you cannot select the time slots to be displayed.

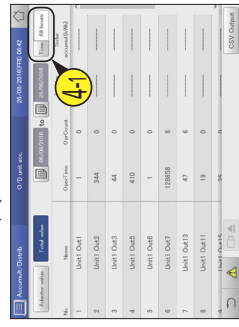

Operation/Status

Check accumulated values

Operation/Status

Check accumulated values

Continued on next page

Checking the list of accumulated values on a pulse meter

The accumulated pulse count values for the pulse meter are displayed in a list. (When a pulse meter is set)

1 Touch [Accumulate/Distrib] in "Oper./Status".

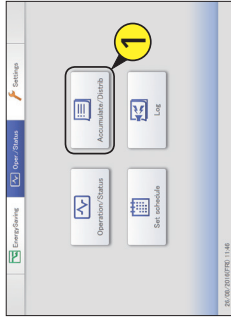

- (1) Touch [Accumulate/Distrib] in "Oper./Status".
- The "Calendar" dialogue is displayed showing the current date.

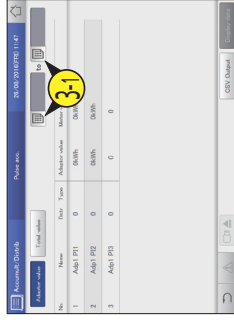

2 Touch [Pulse acc.].

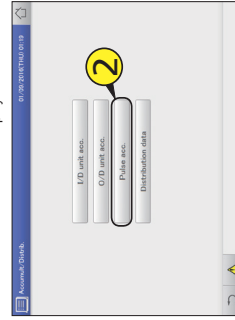

- (2) Touch the date (3-2).
- Use [Left Arrow] to select the month you want to check. The current month is displayed if you touch [Enter/Tab].
- The settings are registered and the "Calendar" dialogue closes.

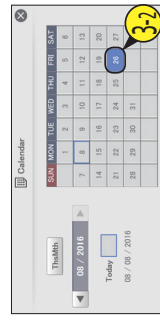

3 Set the period to be displayed.

- Set the start and end of the period to be displayed.
- The time at the left is the start of the period and the time at the right is the end.
- If you set the "Adaptor value", you cannot select the period to be displayed.

4 Select the display item.

- (1) Touch [Display data] (4-1).
- The "Display data" dialogue is displayed.

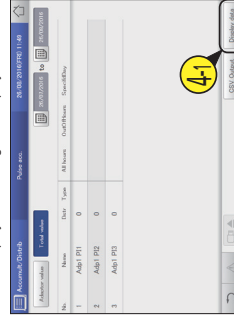

Continued on next page

Checking the list of accumulated values on the outdoor unit

5 Check accumulated values.

Check accumulated values.

- (2) Touch the time slot to accumulate (4-2).
- The settings are registered and the "Specify time" dialogue closes.
- Refer to "Rgr/HourRgr" in "Calendar stas for distr call" (P.148) for information about "Rgr hour" to "Rgr hour8".

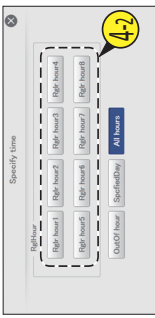

No.	Name	Unit	Oper. time	Oper. Count	accumul. (kWh)
1	Unit1 Out1	1	0	0	0
2	Unit1 Out2	344	0	344	0
3	Unit1 Out3	44	0	44	0
4	Unit1 Out4	410	0	410	0
5	Unit1 Out5	1	0	1	0
6	Unit1 Out6	12858	8	12858	8
7	Unit1 Out7	47	6	47	6
8	Unit1 Out8	19	0	19	0
Inverter accum. (kWh)		96	0	96	0

Operation/Status

Check accumulated values

The "O/D unit acc." screen

No.	Name	Unit	Oper. time	Oper. Count	accumul. (kWh)
1	Unit1 Out1	1	0	0	0
2	Unit1 Out2	344	0	344	0
3	Unit1 Out3	44	0	44	0
4	Unit1 Out4	410	0	410	0
5	Unit1 Out5	1	0	1	0
6	Unit1 Out6	12858	8	12858	8
7	Unit1 Out7	47	6	47	6
8	Unit1 Out8	19	0	19	0
Inverter accum. (kWh)		96	0	96	0

- A: Set the values to be displayed. Touch to select either "Adaptor value" or "Total value".
- B: Set the periods to be displayed. The "Calendar" dialogue is displayed when you touch this.
 - When "Total value" is set, totals matching the time slot set in "Time" ("RgrHour", "OutOH" hour, etc.) are displayed. If "All hours" is set in "Time", all totals are displayed.
- C: Set the time slots to be displayed. The "Specify time" dialogue is displayed when you touch this.
- D: The accumulated values for outdoor units are displayed in a list. You can scroll up or down by swiping or flicking the screen.

Item	Explanation
Name	The names of the outdoor units are displayed.
Oper time	The number of operation hours for the outdoor units are displayed.
OperCount	The number of operation cycles for the outdoor units are displayed.
Inverter accumul. (kWh)	The accumulated values if inverter generation is being used are displayed.
Solar accumul. (kWh)	The accumulated values if solar generation is being used are displayed.

Checking distribution data



Accumulate./Distrib

This chapter explains how to check distribution data. You can check distribution data in a list by unit and by area on this unit. You can check the distribution ratio, usage, and charges for both electricity and gas.

Screen menu
Distribution data

Overview
Check the details about distribution calculations in a list.

Page
72

Checking the list of accumulated values on a pulse meter

(2) Select the items to be displayed (4-2).

- You can select multiple items.
- Refer to "RgrHourRogr" in "Calendar stgs for distr calc" (P:148) for information about "RgrHours1" to "RgrHours8".



5 Check accumulated values.

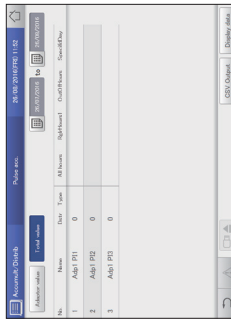

(3) Touch X.

- The settings are registered and the "Display data" dialogue closes.

The "Pulse acc." screen

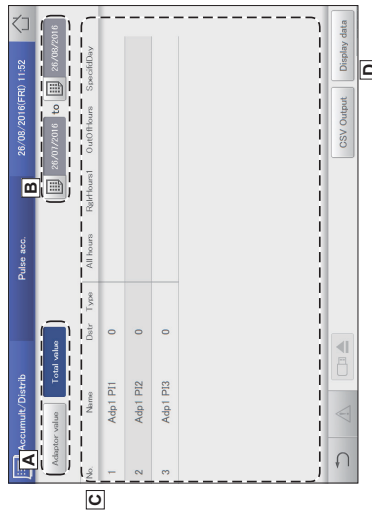

- A: Set the values to be displayed. Touch to select either "Adaptor value" or "Total value".
- If you set "Adaptor value", the displayed value changes at 10-second intervals.
- B: Set the periods to be displayed. The "Calendar" dialogue is displayed when you touch this.
- When "Total value" is set, totals matching the time slot set in "Time" ("RgrHours", "OutOfHours", etc.) are displayed.
- C: The accumulated values for pulse meters are displayed in a list. You can scroll up or down by swiping or flicking the screen.

Item	Explanation
Name	The names of all units (indoor units and outdoor units) are displayed.
Dist	The distribution group number is displayed.
Type	The type of meter is displayed.
Adaptor value (when "Adaptor value" is selected)	The accumulated value of the communication adaptor is displayed.
Meter value (when "Adaptor value" is selected)	The accumulated value for pulse meter is displayed.
Time (when "Total value" is selected)	The accumulated pulse count values for the adaptor or specified period are displayed. ("All hours", "OutOfHours", "SpecifiedDay")
	Display items ("RgrHours1" to "RgrHours8") can also be added.

- D: The "Display data" dialogue is displayed when you touch this, and you can select the items to add to the display.
- If you set the "Adaptor value", you cannot select the items to be displayed.

Checking distribution data in a list

Checking distribution data in a list

Details about distribution data (distribution ratios, usage, and charges) are displayed in a list. For indoor units used in tenanted buildings, it can be difficult to know how much electricity or gas is used in each area because the same air conditioning system may be used across multiple areas. By putting the indoor units in each area into "Distribution group", rates can be calculated based on the data acquired from the air conditioning units (indoor units and outdoor units) in a "Distribution group", and this can help you know how much electricity or gas is used in each area. The rate calculated by this is called the "Distribution ratio".

You need to make the following settings before you can check distribution data.

- Distribution mode settings (P.160)
- Distribution group settings (P.155)
- Area group name settings (P.155)
- Calendar settings for distribution calculation (P.148)
- Distribution ratio settings (P.161)

1 Touch [Accumulate/Distrib] in "Oper./Status".



2 Touch [Distribution data].

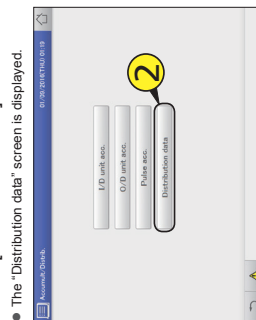

- The "Distribution data" screen is displayed.

3 Set the period to be displayed.

- Set the start and end of the period to be displayed.
- The time at the left is the start of the period and the time at the right is the end.

(1) Touch [Calendar].

- The "Calendar" dialogue is displayed showing the current date.

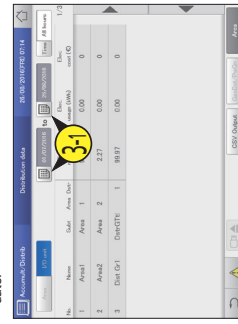

(2) Touch the date (3-2).

- Use the left and right arrow keys to select the month you want to check. The current month is displayed if you touch [ThisMth].
- The settings are registered and the "Calendar" dialogue closes.

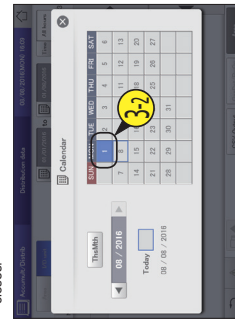

Continued on next page

Operation/Status

Checking distribution data

5 Checking distribution data.

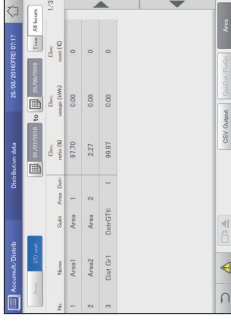

4 Set the time slots to display.

(1) Touch [Time] (4-1).

- The "Specify time" dialogue is displayed.

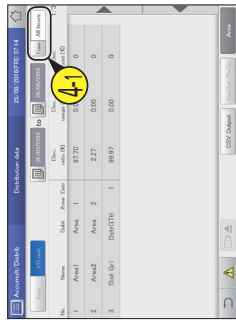

(2) Touch the time slot to accumulate (4-2).

- Refer to "RgrHrRnge" in "Calendar stgs for distr calc" (P.148) for information about "RgrHr" to "RgrHr8".
- The settings are registered and the "Specify time" dialogue closes.

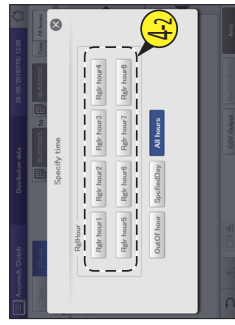

Note

- The calculations for distribution made by this unit do not accord with the relevant laws and statutes, so they cannot be used for official transactions.
- The operating time data accumulated on the indoor units is acquired via a communication adaptor. When this unit sends a request for the data to the communication adaptor, the communication adaptor makes inquiries to the indoor units about their operating hours, and when collection is complete it transfers the results to this unit. This may result in a difference in counts when moving from one time slot to the next.
- Stopping of indoor units by scheduling is subject to some delays due to communications, so make sure it is not set at the same time as the "RgrHrRnge stgs" (P.150) time slot is changed over. If the schedule stops operation prior to the change over of a time slot, avoid setting it inside 10 minutes (this may change depending on the state of communications) of the change over of the time slot.
- When there is a problem with the communications between the main unit and the indoor units (or the communication adaptor), it may not be possible to accumulate by time slot normally. The accumulated values received by this unit are counted in the time slot when they are received.
- The usage in [All hours] in the "Specify time" dialogue is calculated from the distribution ratio distributed overall according to the total operating data from all time slots. This means that the usages in [RgrHour], [OutOfHour], and [SpofiedDay] will not match.
- If you remove an air conditioning unit after accumulating distribution data, all accumulated values for that air conditioning unit are deleted, so it will not be possible to view distribution data that includes that air conditioning unit after it is removed.

Before removing the unit, output (save) the distribution data as a CSV file to a USB memory device.
The output method for CSV files is the same as for outputting logs. (→ "Outputting (saving) logs as a CSV file" (P.60))

Checking distribution data in a list

Changing the units of display

- 1 Make sure that [Area] is off.
- 2 Select the unit of display.
 - Switch the display between 'Area' and 'ID unit'.



Checking distribution data in a list

The "Distribution data" screen

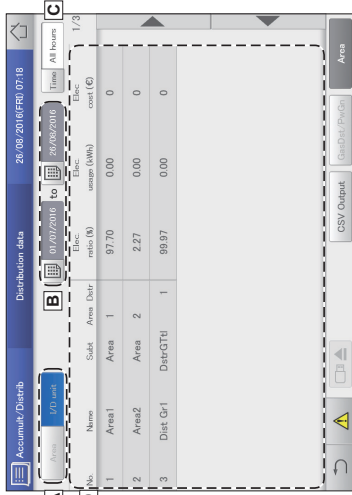

- A: Set the units of display.
- [Area] Display indoor units by area.
 - [ID unit] Display indoor units in display order.
- B: Set the periods to be displayed. The "Calendar" dialogue is displayed when you touch this.
- C: Set the time slots to be displayed. The "Spreddy time" dialogue is displayed when you touch this.
- D: Indoor unit distribution data is displayed in a list.

Item	Explanation
Name	The names of the indoor units are displayed.
Subst	This is the subtotal of the specified unit.
Area	The area number that the indoor unit belongs to is displayed.
Distr	The distribution group number is displayed.
Elec. ratio (%)	This is the distribution ratio of electricity supplied from outdoor units.
Elec. usage (kWh)	This is the usage of electricity supplied from outdoor units.
O/D Gas ratio(%)	This is the distribution ratio of gas supplied from GHP.
O/D Gas usage(m3)	This is the quantity of gas supplied from GHP.
O/D Gas cost	This is the charges calculated based on the gas usage.
Pwr/GnGas ratio(%)	This is the distribution ratio of gas used to generate power.
Pwr/GnGas usage(m3)	This is the volume of gas used to generate power.
Pwr/GnGas cost	This is the charges calculated based on the volume of gas used to generate power.
Total cost	This is the total of "Elec. cost", "O/D Gas cost", and "Pwr/GnGas cost".

- E: The "Pwr/GnGas ratio", "Pwr/GnGas usage", and "Pwr/GnGas cost" items are added to the display when you touch this. This is not possible if time distribution is set, however.
- F: When this is cancelled, it is possible to display by area or by indoor unit. (→ "Changing the units of display" (P74))

Operation/Status

Checking distribution data

Operation/Status

Checking distribution data

Automatically return to set temperatures [set temp. auto return]

Even if the set temperature is changed, the temperature automatically returns to the set temperature ("Return temperature") at certain times ("Return time"). This feature prevents over cooling or heating.

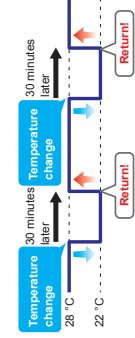

- When you want to keep the set temperature at 28 °C during the summer months
Make the return temperature 28 °C in the temperature auto return setting and the return time 30 minutes later, and it will not matter how many times the temperature is changed, the set temperature will return to 28 °C every 30 minutes after it is changed.
However, when the return temperature is set to 27 °C, if the set temperature is changed to 28 °C, the temperature will not return to the return temperature even after the return time has elapsed. (When "Eco dirct. only" is set)

1 Touch [Energy saving] in "EnergySaving".

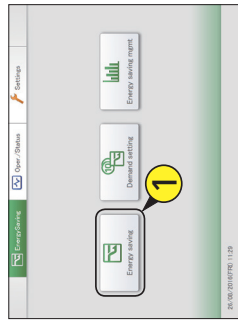

3 Put a check mark in the "Select" column (3-1), and touch [Set] (3-2).

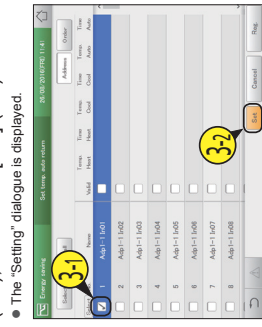

- The "Setting" dialogue is displayed.

2 Touch [Set temp. auto return].

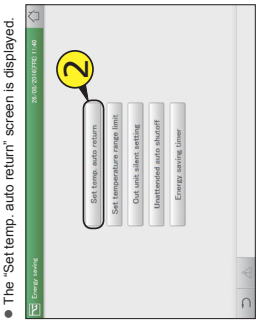

- The "Set temp. auto return" screen is displayed.

Energy saving

Settings for energy saving

Settings for energy saving

This chapter explains how to make energy saving settings.

This unit is equipped with the e-CUT functions (temperature auto return, unattended auto shutdown, temperature range limit, energy saving timer/efficient operation*). The e-CUT functions reduce waste when air conditioning so that you can even save energy using existing air conditioning units.



Screen menu	Overview	Page
Set temp. auto return	Even if the temperature initially set is changed, the temperature automatically returns to the set one after a certain amount of time.	77
Unattended auto shutdown	If the air conditioning unit automatically stops at the set time but then it is started again, this setting automatically stops the unit again repeatedly at set intervals.	80
Set temperature range limit	Restrict the temperatures that can be set by setting upper and lower limits on temperatures.	83
Energy saving timer/efficient operation setting*	You can specify time slots when you want operation capacity reduced.	85
Out unit silent setting	Set a time for the outdoor unit to operate at a lower level at night compared to the day.	87



Screen menu	Overview	Page
I/D unit demand settings	You can automatically control indoor units by setting particular levels to cut the maximum demand for electricity or maximum gas consumption.	89
O/D unit demand settings	You can automatically control outdoor units by setting particular levels to cut the maximum demand for electricity or maximum gas consumption.	92
Demand/peak shaving settings/Peak cut settings*	Limit the electricity or gas consumed by outdoor units during the set time slot.	94
O/D unit cyclic	At specified 10 minute intervals, the thermostats of outdoor units in control groups are turned off and restored repeatedly in order.	101
I/D unit cyclic	At specified intervals (3, 4, or 5 minutes), the thermostats of indoor units in control groups are turned off and restored repeatedly in order.	97
Register demand point	Register the demand point input.	104

* When using gas heat pump air conditioners

Energy saving

Settings for energy saving

4 Change the settings.



Continued on next page

Automatically return to set temperatures [Set temp. auto return]

Item	Explanation
Return temperature Return time	Set the return temperatures for "Heat", "Cool", and "Auto" and the return time. Use \uparrow \downarrow \leftarrow \rightarrow to set the temperature or time. The setting ranges are as follows. <ul style="list-style-type: none"> Return temperature for heating: 16 to 30 °C* (1 °C intervals) *1 The upper limit for gas heat pumps is 26 °C. Return temperature for cooling (dry): 6 to 30 °C (1 °C intervals) Return temperature for heating: 17 to 27 °C (1 °C intervals) Return time (shared): 0 to 240 minutes (5 minute intervals)
Auto return	The auto return function is enabled for the selected indoor unit if you put a check mark here.
The following items are settings common to all indoor units.	
<ul style="list-style-type: none"> Eco dir. only Always return Allow auto C/H Fan switching 	<p>Select the conditions for return. When you select "Eco dir. only", the return to the set temperature only occurs automatically if it saves energy.</p> <p>When you select "Allow auto C/H", temperature auto return control also occurs in the automatic mode.</p> <p>When you select "Fan switching", when the running mode of the indoor units is switched to "Auto Cool/Heat" the mode switches from automatic mode to fan mode.</p>

6 Set other indoor units.

- Repeat steps 3 to 5.

7 Touch [Reg.].

- To cancel the settings, touch [Cancel].

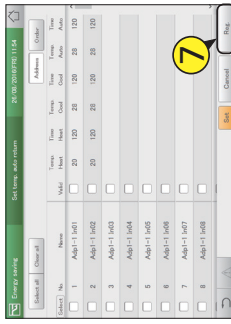

5 Touch [Register].

- The "Setting" dialogue closes.
- To cancel the settings, touch [Cancel].

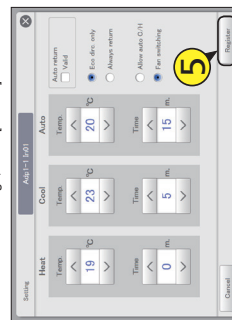

Automatically return to set temperatures [Set temp. auto return]

The "Set temp. auto return" screen

A: [Select all]/[Clear all] buttons
 [Select all] [Clear all] [Cancel selection of all indoor units]

B: Change list order. The list order changes each time you touch it.
 [Select all] [Clear all] [Cancel selection of all indoor units]

C: The display follows the order set in "ID unit settings" (P.141).
 The display follows the address order of the outdoor unit systems.
 The display follows the address order set in "ID unit settings" (P.141).

D: The indoor units with a check mark next to them will be the subject of the changes to the settings.

E: The temperature auto return setting is enabled for the selected indoor unit if you put a check mark here. This is linked with the "Auto return" ("Setting" dialogue) (P.78) setting.

F: The "Setting" dialogue is displayed when you touch this.

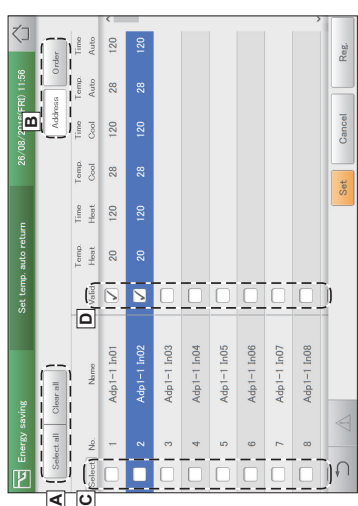

Energy saving

Settings for energy saving

Energy saving

Settings for energy saving

Automatically stopping restarts [Unattended auto shutoff]

If air conditioning automatically stops at the time set on the timer, but then is started again, this setting automatically stops the unit again repeatedly at set intervals, so it helps prevent people from forgetting to turn the air conditioning off.

- When the settings are for closed between 21:00 and 09:00, and the stop monitoring during closed hours is set to 60-minute intervals
- The "auto shutoff" feature works as many times as necessary during the closed hours (21:00 to 9:00 the next morning in the example).

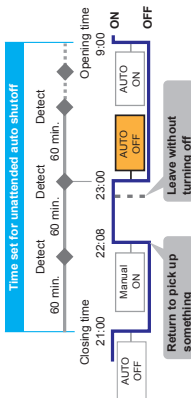

1 Touch [Energy saving] in "EnergySaving".

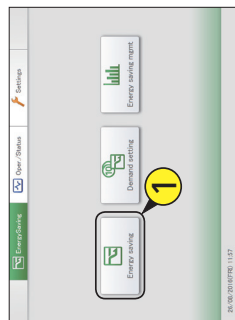

3 Put a check mark in the "Select" column (3-1), and touch [Set.] (3-2).

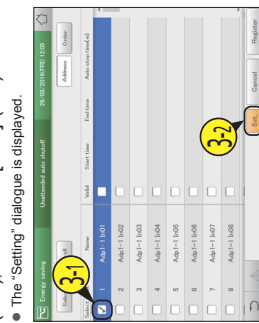

- The "Setting" dialogue is displayed.

2 Touch [Unattended auto shutoff].

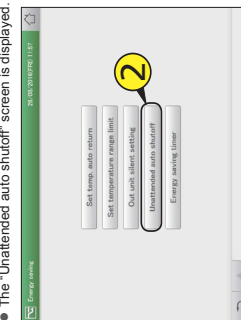

4 Change the settings.

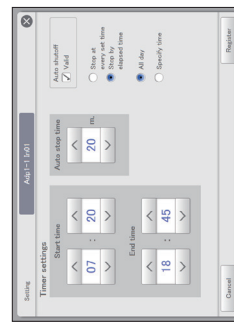

Item	Explanation
Timer settings (Start time, End time)	Set the time slots to automatically stop. Use [] to set the time. Note • You can make the settings extend over different dates. For example: 22:00 to 08:00

Continued on next page

Automatically stopping restarts [Unattended auto shutoff]

Item	Explanation
Auto stop time	Set the time to automatically stop after operation is started. Use [] to set the time. You can set between 0 and 180 minutes (5 minute intervals).
Auto shutoff	The auto shutoff function is enabled for the selected indoor unit if you put a check mark here. Select the stop conditions. • "Stop at every set time" Even after automatically stopping at the "Start time", the unit continues to automatically stop repeatedly at the "Auto stop time" interval. • "Stop by elapsed time" After automatically stopping at "Start time" automatic stopping only happens after the "Auto stop time" has elapsed if the indoor unit is running. Select the time conditions. • "All day" Automatic stopping at "Auto stop time" continues repeatedly throughout the day. ("Timer settings" is ignored) • "Specify time" Auto shutoff is repeated between the "Start time" and the "End time".



7 Touch [Register].

- To cancel the settings, touch [Cancel].

Energy saving

Settings for energy saving



5 Touch [Register].

- The "Setting" dialogue closes.
- To cancel the settings, touch [Cancel].

6 Set other indoor units.

- Repeat steps 3 to 5.

Energy saving

Settings for energy saving

Restricting the range of set temperatures [set temperature range limit]

Restrict the range of temperatures that can be set by setting upper and lower limits on temperatures.

- 1 Touch [Energy saving] in "EnergySaving".
- 2 Touch [Set temperature range limit].
- 3 Put a check mark in the "Select" column (3-1), and touch [Set.] (3-2).
- 4 Change the settings.

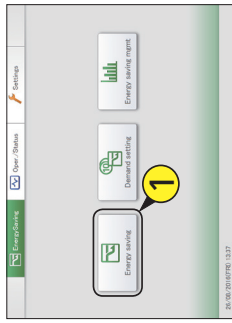

Item	Explanation
High limit Low limit	Set the upper temperature and lower temperature for "Heat", "Cool", and "Auto". Set the temperature with \uparrow and \downarrow . The setting ranges are as follows. <ul style="list-style-type: none"> In heating mode: <ul style="list-style-type: none"> High limit: 16 to 30 °C (1 °C intervals) Low limit: 16 to 26 °C (1 °C intervals) In cooling (drying) mode: <ul style="list-style-type: none"> High limit: 18 to 30 °C (1 °C intervals) Low limit: 17 to 27 °C (1 °C intervals) <p>Note</p> <ul style="list-style-type: none"> The temperature range you can set depends on the model. The temperature range limit function is enabled for the selected indoor unit. If you put a check mark here.
Temp range limit	

- 2 Touch [Set temperature range limit].

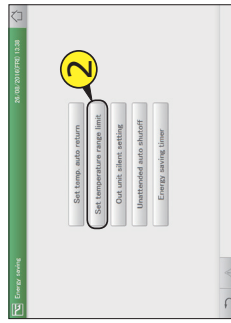

- 3 Put a check mark in the "Select" column (3-1), and touch [Set.] (3-2).

The "Setting" dialogue is displayed.

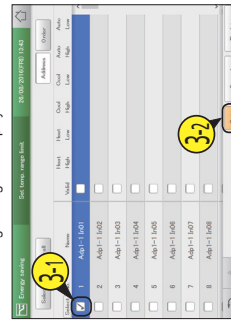

Continued on next page

Automatically stopping restarts [Unattended auto shutoff]

The "Unattended auto shutoff" screen

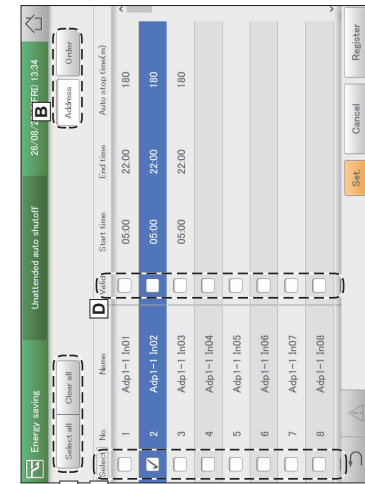

- A: [Select all]/[Clear all] buttons
[Select all] Select all indoor units.
[Clear all] Cancel selection of all indoor units.
- B: Change list order. The list order changes each time you touch it.
Display The display follows the order set in "I/D unit settings" (P-141).
O/D unit The display follows the address order of the outdoor unit systems.
Address The display follows the address order set in "I/D unit settings" (P-141).
- C: The indoor units with a check mark next to them will be the subject of the changes to the settings.
- D: The unattended auto shutoff is enabled for the selected indoor unit. If you put a check mark here. This is linked with the "Auto shutoff" ("Setting" dialogue) (P-81) setting.
- E: The "Setting" dialogue is displayed when you touch this.

Energy saving

Settings for energy saving

Energy saving

Restricting the range of set temperatures [Set temperature range limit]

5

Touch [Register].

- The "Setting" dialogue closes.
- To cancel the settings, touch [Cancel].

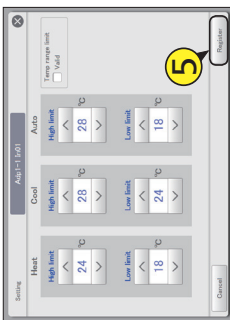

7

Touch [Register].

- To cancel the settings, touch [Cancel].

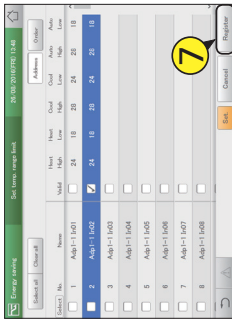

6

Set other indoor units.

- Repeat steps 3 to 5.

The "Set temp. range limit" screen

- A: [Select all] [Clear all] buttons
Select all indoor units.
Cancel selection of all indoor units.
- B: Change list order. The list order changes each time you touch it.
Display The display follows the order set for the selected indoor unit in "ID unit settings" (P.141).
OID unit The display follows the address order of the outdoor unit systems.
Address The display follows the address order set in "ID unit settings" (P.141).
- C: The indoor units with a check mark next to them will be the subject of the changes to the settings.
- D: The temperature range limit setting is enabled for the selected indoor unit if you put a check mark here. This is linked with the "Temp range limit" ("Setting" dialogue) (P.83) setting.
- E: The "Setting" dialogue is displayed when you touch this.

Restricting operating capacity according to the time slot [Energy saving timer]/[Efficient operation setting*]

* When using gas heat pump air conditioners

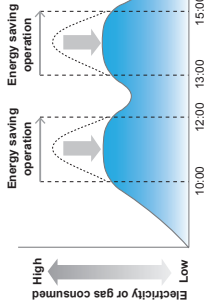

3

Put a check mark in the "Select" column (3-1), and touch [Set.] (3-2).

- The "Setting" dialogue is displayed.

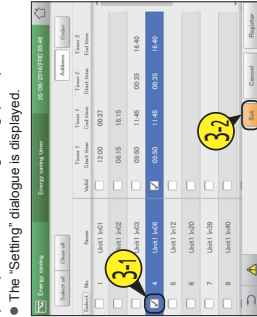

4

Change the settings.

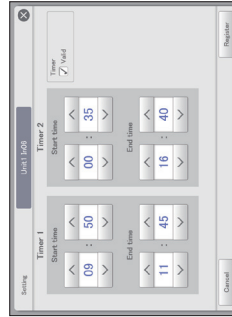

Item	Explanation
Start time	Set the start and end times for "Timer 1" and "Timer 2".
End time	Use \uparrow \downarrow to set the time. The setting ranges are as follows. <ul style="list-style-type: none"> • Hours: 00 to 23 (1 hour intervals) • Minutes: 00 to 59 (1 minute intervals)
Note	<ul style="list-style-type: none"> • You can make the settings extend over different dates. • For example: 22:00 to 08:00

Continued on next page

Energy saving

Settings for energy saving

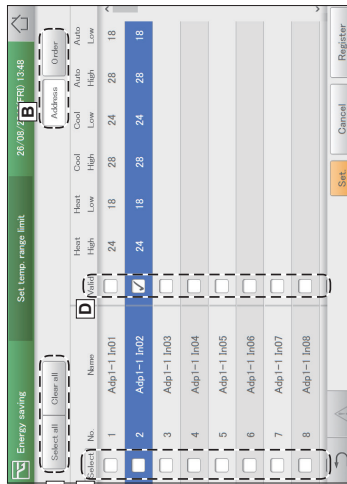

Restricting the range of set temperatures [Set temperature range limit]

Restricting operating capacity according to the time slot [Energy saving timer]/[Efficient operation setting]

Item	Explanation
Timer	The energy saving timer function is enabled for the selected indoor unit if you put a check mark here.

6 Set other indoor units.

- Repeat steps 3 to 5.

7 Touch [Register].

- To cancel the settings, touch [Cancel].

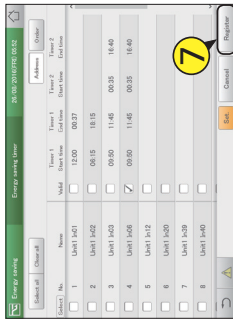

5 Touch [Register].

- The "Setting" dialogue closes.
- To cancel the settings, touch [Cancel].

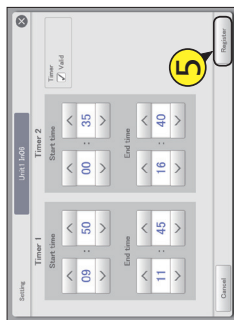

Note

- The settings for efficient operation (when using gas heat pump air conditioners) are made in the same way as energy saving timer.

The "Energy saving timer" screen

- A: [Select all]/[Clear all] buttons
- B: Change list order. The list order changes each time you touch it.
- C: Display
- D: The display follows the order set in "ID unit settings" (P.141).
- E: The display follows the address order of the outdoor unit systems.
- F: The display follows the address order set in "ID unit settings" (P.141).
- G: The indoor units with a check mark next to them will be the subject of the changes to the settings.
- H: The energy saving timer setting is enabled for the selected indoor unit if you put a check mark here. This is linked with the "Timer" ("Setting" dialogue) setting.
- I: The "Setting" dialogue is displayed when you touch this.

Reducing the noise of outdoor units [out unit silent setting]

Set a time for the outdoor unit to operate more quietly at night compared to the day.

1 Touch [Energy saving] in "EnergySaving".

4 Change the settings.

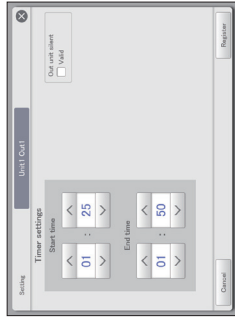

2 Touch [Out unit silent setting].

- The "Out unit silent setting" screen is displayed.

Item	Explanation
Start time	Set the start and end times for the silent mode. The setting ranges are as follows.
End time	Set the start and end times for the silent mode. The setting ranges are as follows.
Out unit silent	The silent operating mode is enabled if you put a check mark here.

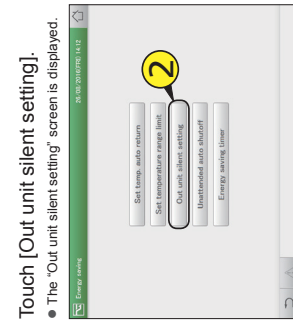

5 Touch [Register].

- The "Setting" dialogue closes.
- To cancel the settings, touch [Cancel].

5 Touch [Register].

- The "Setting" dialogue closes.
- To cancel the settings, touch [Cancel].

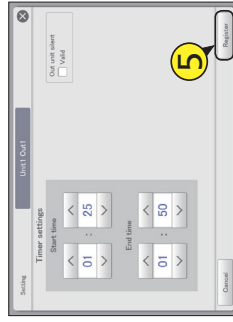

3 Put a check mark in the "Select" column (3-1), and touch [Set]. (3-2).

- The "Setting" dialogue is displayed.

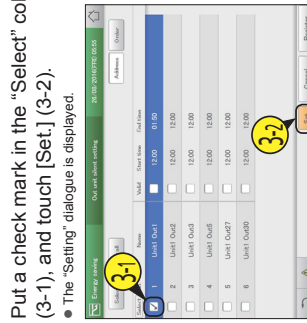

6 Set other indoor units.

- Repeat steps 3 to 5.

Continued on next page

Energy saving

Settings for energy saving

Energy saving

Settings for energy saving

Reducing the noise of outdoor units [Out unit silent setting]

7

Touch [Register].

- To cancel the settings, touch [Cancel].

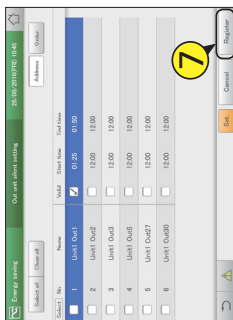

The "Out unit silent setting" screen

- A: [Select all]/[Clear all] buttons
[Select all] Select all outdoor units.
[Clear all] Cancel selection of all outdoor units.
- B: Change list order. The list order changes each time you touch it.
Display The display follows the order set in "I/D unit settings" (P.141).
Address The display follows the address order set in "I/D unit settings" (P.141).
- C: The outdoor units with a check mark next to them will be the subject of the changes to the settings.
- D: The out unit silent setting is enabled for the selected out unit silent if you put a check mark here. This is linked with the "Out unit silent" ("Setting" dialogue) (P.87) setting.
- E: The "Setting" dialogue is displayed when you touch this.

Demand settings on the indoor unit [I/D unit demand settings]

You can automatically control indoor units by setting indoor unit demand control levels to cut the maximum demand for electricity or maximum gas consumption. Set an operation when the setting levels for the demand point inputs come on. Refer to P.104 for information on how to register demand point inputs.

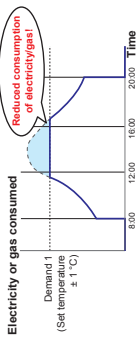

- When "±1°C" is set in the setting level "Demand 1" during cooling
When the demand signal is received from the external equipment, the demand 1 contact comes on and the set temperature is raised by 1°C.

1

Touch [Demand setting] in "EnergySaving".



3

Put a check mark in the "Select" column (3-1), and touch [Set.] (3-2).

- The "Setting" dialogue is displayed.

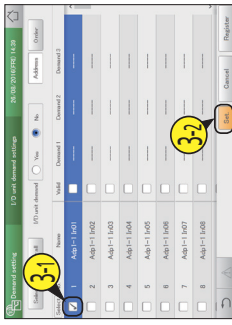

2

Touch [I/D unit demand settings].

- The "I/D unit demand settings" screen is displayed.

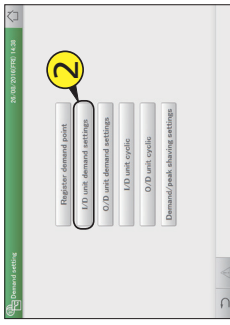

4

Change the settings.

- Set the "Settings" for "Demand 1", "Demand 2", and "Demand 3" in "Level".



Item	Explanation
Level	Select a setting level.
Settings	Select an operation. No operation is caused if you select [—].
I/D unit demand	The demand setting is enabled for the selected indoor unit if you put a check mark here.
Valid	

Continued on next page

Energy saving

Settings for energy saving

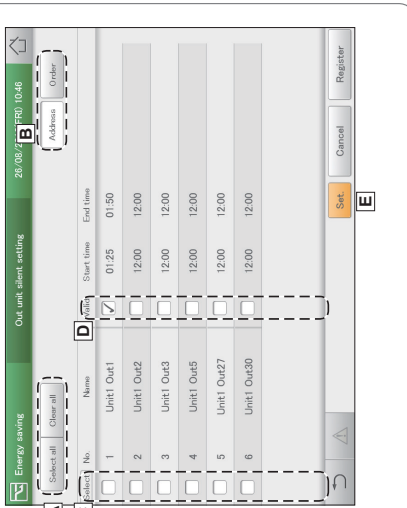

Demand settings on the indoor unit [I/D unit demand settings]

5 Touch [Register].

- The "Setting" dialogue closes.
- To cancel the settings, touch [Cancel].



6 Set other indoor units.

- Repeat steps 3 to 5.

7 Select "Yes" for "I/D unit demand".



Demand settings on the indoor unit [I/D unit demand settings]

The "I/D unit demand settings" screen

A: [Select all]/[Clear all] buttons

- Select all indoor units.
- Cancel selection of all indoor units.

B: Set whether to enable indoor unit demand control across the whole system or not.

Note

- If you select "Yes", make sure that you set "No" for outdoor unit demand settings.
- Change list order. The list order changes each time you touch it.

C:

Display	The display follows the order set in 'I/D unit settings' (P.141).
O/D unit	The display follows the address order of the outdoor unit systems.
Address	The display follows the address order set in 'I/D unit settings' (P.141).

D: The indoor units with a check mark next to them will be the subject of the changes to the settings.

E: The I/D unit demand setting is enabled for the selected indoor unit if you put a check mark here. This is linked with the "I/D unit demand Valid" ("Setting" dialogue) (P.89) setting.

F: The "Setting" dialogue is displayed when you touch this.

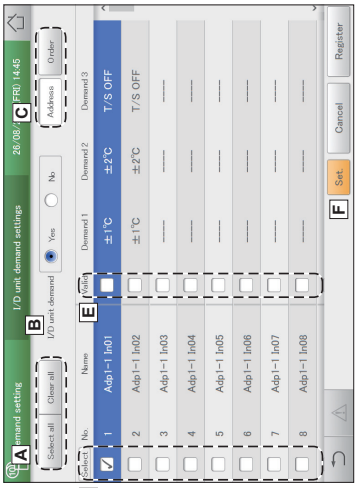

Energy saving

Settings for energy saving

Energy saving

Settings for energy saving

Demand settings on the outdoor unit [O/D unit demand settings]

You can automatically control outdoor units by setting outdoor unit demand control levels to cut the maximum demand for electricity or maximum gas consumption. Set an operation when the setting levels for the demand point inputs come on. Refer to P.104 for information on how to register demand point inputs.

- When "Ope. 50%" is set in the setting level "Demand 1" during warming. When the demand signal is received from the external equipment, the demand 1 contact comes on and the operation of the outdoor unit is restricted by 50%.

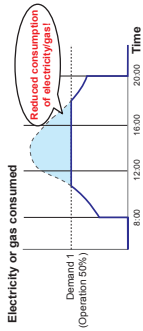

- Put a check mark in the "Select" column (3-1), and touch [Set.] (3-2).

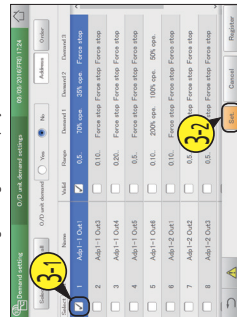

- The "Setting" dialogue is displayed.

- Touch [O/D unit demand settings].

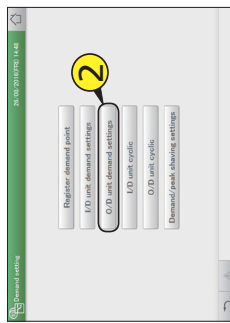

- Change the settings.
- Set the "Demand" for "Demand 1", "Demand 2", and "Demand 3" in "Level".



Item	Explanation
Level	Select a setting level.
Demand	Select an operation. No operation is caused if you select [—]. When you have selected [Ope.] in "Demand", set the control rate with [▲/▼]. The values shown are those values that can be set for the outdoor unit selected.
OD unit demand Valid	The demand setting is enabled for the selected outdoor unit if you put a check mark here.

Continued on next page

Demand settings on the outdoor unit [O/D unit demand settings]

- Touch [Register].
- The "Setting" dialogue closes.
 - To cancel the settings, touch [Cancel].

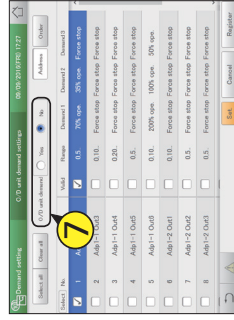

- Set other outdoor units.
- Repeat steps 3 to 5.

- Touch [Register].
- To cancel the settings, touch [Cancel].

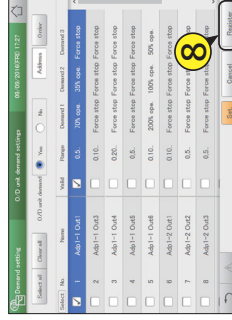

Energy saving

Energy saving

Settings for energy saving

Settings for energy saving

The "O/D unit demand settings" screen

- [Select all]/[Clear all] buttons

- Set whether to enable outdoor unit demand control or not.

- Note**
- If you select "Yes", make sure that you set "No" for indoor unit demand settings.

- This switches between "Display" and "Address" each time you touch it.

- The outdoor units with a check mark next to them will be the subject of the changes to the settings.

- The O/D unit demand setting is enabled for the selected outdoor unit if you put a check mark here. This is linked with the "O/D unit demand Valid" ("Setting" dialogue) (P.92)

- The "Setting" dialogue is displayed when you touch this.



Suppressing the consumption of electricity/gas [Demand/peak shaving settings]/[Peak cut settings]

* When using gas heat pump air conditioners

You can limit the electricity or gas consumed by outdoor units during the set time slot.

When set to the 10:00 to 12:00 and 13:00 to 15:00 time slots, the consumption of electricity/gas by the outdoor units is reduced during those time periods.

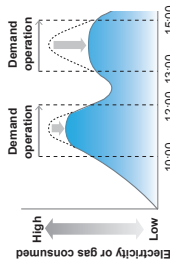

1 Touch [Demand setting] in "EnergySaving".



3 Put a check mark in the "Select" column (3-1), and touch [Set.] (3-2).

- The "Setting" dialogue is displayed.

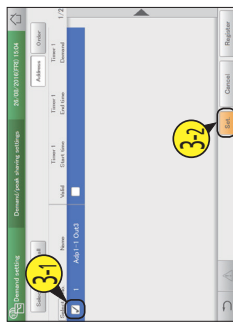

2 Touch [Demand/peak shaving settings].

- The "Demand/peak shaving settings" screen is displayed.

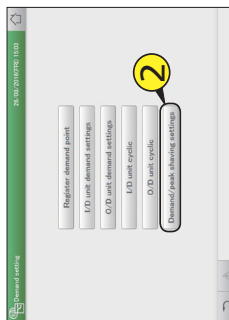

4 Change the settings.



Item	Explanation
Timer 1 Timer 2	First select either "Timer 1" or "Timer 2", then set the "Start time", "End time", and "Demand" for each of them.

Continued on next page

Suppressing the consumption of electricity/gas [Demand/peak shaving settings]/[Peak cut settings]

6 Set other indoor units.

- Repeat steps 3 to 5.

7 Touch [Register].

- To cancel the settings, touch [Cancel].

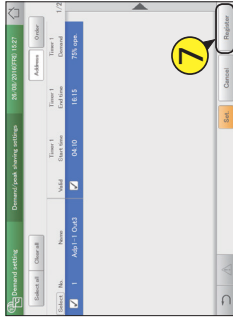

Item	Explanation
Start time End time	Set the start and end times for "Timer 1" and "Timer 2". Use [▲] [▼] to set the time. The setting ranges are as follows. • Hours: 00 to 23 (1 hour intervals) • Minutes: 00 to 59 (1 minute intervals) Note • You can make the settings extend over different dates. For example: 22:00 to 09:00. Selected an operation. No operation is caused if you select [---]. When you have selected [On] in "Demand", set the control rate with [▲] [▼]. The values shown are those values that can be set for the outdoor unit selected. The outdoor unit time slot demand control setting is enabled for the selected outdoor unit if you put a check mark here.
Demand	
Demand/peak shaving Valid	

5 Touch [Register].

- The "Setting" dialogue closes.
- To cancel the settings, touch [Cancel].



Energy saving

Settings for energy saving

Note

- The settings for peak cut (when using gas heat pump air conditioners) are made in the same way as outdoor time slot demand settings.

Energy saving

Settings for energy saving

Suppressing the consumption of electricity/gas [Demand/peak shaving settings]/[Peak cut settings]

The "Demand/peak shaving settings" screen

A: [Select all]/[Clear all] buttons
[Clear all] [Select all]
Cancel selection of all outdoor units.

B: This switches between "Display" and "Address" each time you touch it.

C: The outdoor units with a check mark next to them will be the subject of the changes to the settings.

D: The outdoor time slot demand setting is enabled for the selected outdoor unit if you put a check mark here. This is linked with the "Demand/peak shaving Valid" ("Setting" dialogue) (P-95) setting.

E: The "Setting" dialogue is displayed when you touch this.

Control operation at regular intervals [I/D unit cyclic]

This type of control rotates through the set times slots at the specified intervals (3 minutes, 4 minutes, 5 minutes), evenly operating the indoor units in the control groups using the settings (OFF, thermostat, mode, set temperature) and recovering.

- When using cycling control at 5 minute intervals on the indoor units in control groups 1 to 5
Control groups 1 to 3 are "T/S OFF" and control groups 4 and 5 are "Fan", and if the interval is "5 min.", the cycling control happens at 5 minute intervals.

	5 min.	5 min.	5 min.	5 min.	5 min.
Control group 1	Thermostat beyond OFF	Normal operation	Normal operation	Normal operation	Normal operation
Control group 2	Thermostat beyond OFF	Normal operation	Normal operation	Normal operation	Normal operation
Control group 3	Thermostat beyond OFF	Normal operation	Normal operation	Normal operation	Normal operation
Control group 4	Normal operation	Normal operation	Normal operation	Fan	Normal operation
Control group 5	Normal operation	Normal operation	Normal operation	Fan	Fan

- Touch [Demand setting] in "EnergySaving".



3

- Put a check mark in the "Select" column (3-1), and touch [Set.] (3-2).

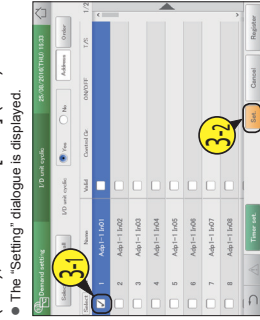

2

- Touch [I/D unit cyclic].

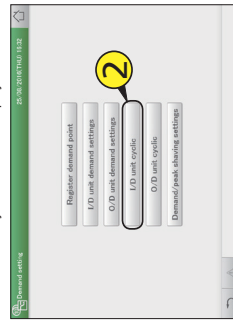

4

- Change the settings.



Energy saving

Energy saving

Settings for energy saving

Settings for energy saving

Item	Explanation
Control Gr. 1-10	Press [▶] to set the control group that the indoor unit is to be allocated to. (Up to 10 groups) Set from "Gr.1" to "Gr.10".
Op.e.	Operation of the indoor units is stopped. Set either [OFF] or [---].
T/S	The thermostat is set to off forcibly. Select between [T/S OFF] and [---].

Continued on next page

Control operation at regular intervals [I/D unit cyclic]

Item	Explanation
Mode	Set the operating mode to fan. Set either [Fan] or [—].
Set T.	Set the temperature with \uparrow and \downarrow . Set "s1" or "4.2", at 1 °C steps between 16 °C and 28 °C.
Fan	Use \uparrow and \downarrow to set the fan speed. Set "Auto", "High", "Mid", or "Low".
I/D unit cyclic Valid	The indoor unit cycling control function is enabled for the selected indoor unit if you put a check mark here.

* When left blank, that item does not cause any operation.

5 Touch [Register].

- The "Setting" dialogue closes.
- To cancel the settings, touch [Cancel].



6 Set other indoor units.

- Repeat steps 3 to 5.

7 Touch [Timer set].

- The "Term setting" dialogue is displayed.



Control operation at regular intervals [I/D unit cyclic]

8 Touch the number.

- You can set 4 different time slots.

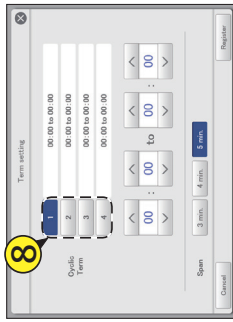

9 Set the times.

- The time on the left is the control start time. The time on the right is the control end time.
- Use \uparrow and \downarrow to set the time. Hours can be set in the range 0 to 23, and minutes may be either "00" or "30".

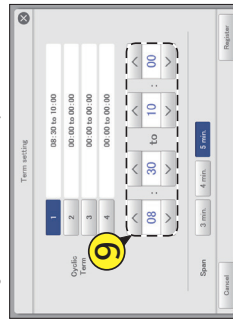

10 Set the control interval.

- Select "3 min.", "4 min.", or "5 min."
- Repeat steps 7 to 9 to set for numbers [1] to [4].

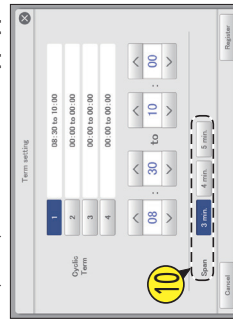

Continued on next page

Control operation at regular intervals [I/D unit cyclic]

14 Touch [Register].

- To cancel the settings, touch [Cancel].

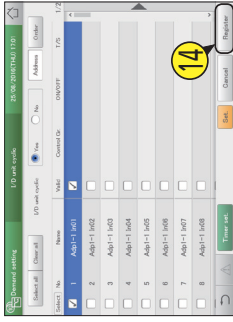

Note

- Up to 10 control groups can be created.
- Control groups that have not been set will not be the object of cyclic control.

12 Put a check mark in the "Valid" column.



13 Select "Yes" for "I/D unit cyclic".

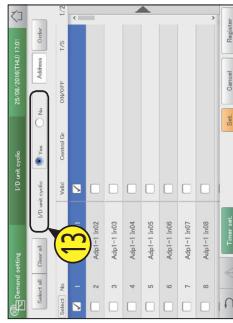

Energy saving

Energy saving

Settings for energy saving

Settings for energy saving

Control operation at regular intervals [I/D unit cyclic]

The "I/D unit cyclic" screen

A: [Select all]/[Clear all] buttons
 [Select all] [Clear all]
 [Clear all] [Select all]

B: Set whether to enable indoor unit cycling control across the whole system or not.

Note

- If you select "Yes", make sure that you set "No" for outdoor unit cycling control settings.

C: Change list order. The list order changes each time you touch it.

Display
 The display follows the order set in "I/D unit settings" (P.141).

O/D unit
 The display follows the address order of the outdoor unit systems.

Address
 The display follows the address order set in "I/D unit settings" (P.141).

D: The indoor units with a check mark next to them will be the subject of the changes to the settings.

E: The I/D unit cyclic is enabled for the selected indoor unit if you put a check mark here. This is linked with the "I/D unit cyclic Valid" ("Setting" dialogue) (P.88) setting.

F: The "Term setting" dialogue is displayed when you touch this.

G: The "Setting" dialogue is displayed when you touch this.

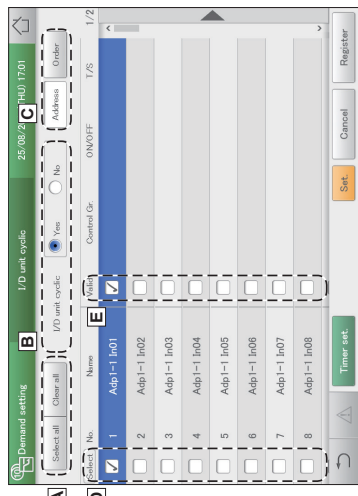

Energy saving

Settings for energy saving

Control operation at regular intervals [O/D unit cyclic]

This type of control rotates through at 10 minute intervals, evenly operating the outdoor units in the control groups either operating (or stopping) and recovering.

- When using cycling control at 10 minute intervals on the outdoor units in control groups 1 to 5 control groups 1 and 3 are Force stop, and control groups 2, 4 and 5 are 50% operation, and the cycling control happens at 10 minute intervals.

Control group 1	Force stop	10 min.	10 min.	10 min.	10 min.	Normal operation
Control group 2	Normal operation	50% control	Normal operation	Normal operation	Normal operation	Normal operation
Control group 3	Force stop	Normal operation	Force stop	Normal operation	Normal operation	Normal operation
Control group 4	Normal operation	50% control	Normal operation	Normal operation	Normal operation	Normal operation
Control group 5	Force stop	Normal operation	Force stop	Normal operation	Normal operation	Normal operation

- Put a check mark in the "Select" column (3-1), and touch [Set.] (3-2).
- The "Setting" dialogue is displayed.



- Touch [O/D unit cyclic].
- The "O/D unit cyclic" screen is displayed.

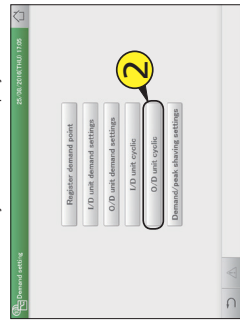

Energy saving

Settings for energy saving

Continued on next page

- Put a check mark in the "Select" column (3-1), and touch [Set.] (3-2).
- The "Setting" dialogue is displayed.

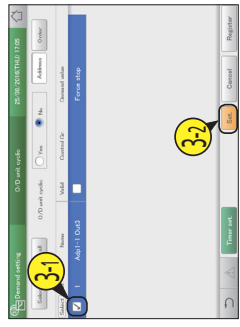

- Change the settings.



Item	Explanation
Control Gr. 1-5	Press [▶] to set the control group that the indoor unit is to be allocated to. Set from "Gr.1" to "Gr.5".
Demand	Select an operation. No operation is caused if you select [—]. When you have selected [Ope.], set the control rate with [▲] [▼]. The values shown are those values that can be set for the outdoor unit selected.

Control operation at regular intervals [O/D unit cyclic]

Item	Explanation
O/D unit cyclic Valid	The O/D unit cyclic function is enabled for the selected outdoor unit if you put a check mark here.

5 Touch [Register].

- The "Setting" dialogue closes.
- To cancel the settings, touch [Cancel].



9 Set the times.

- The time on the left is the control start time. The time on the right is the control end time.
- Use the up/down arrows to set the time. Hours can be set in the range 0 to 23, and minutes may be either "00" or "30".

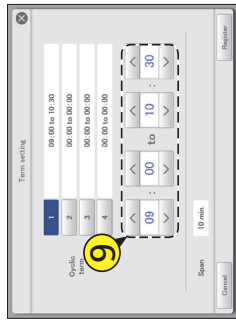

10 Touch [Register].

- The "Term setting" dialogue closes.
- To cancel the settings, touch [Cancel].

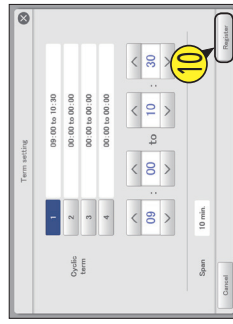

11 Put a check mark in the "Valid" column.

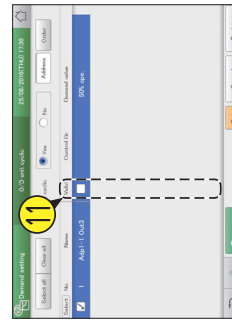

Continued on next page

Control operation at regular intervals [O/D unit cyclic]

12 Select "Yes" for "O/D unit cyclic".

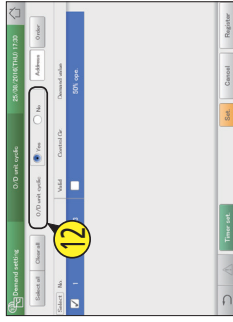

13 Touch [Register].

- To cancel the settings, touch [Cancel].

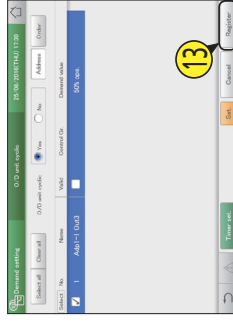

Note

- Up to 5 control groups can be created.
- Control groups that have not been set will not be the object of cyclic control.

The "O/D unit cyclic" screen

- A:** [Select all]/[Clear all] buttons
 [Select all] Select all outdoor units.
 [Clear all] Cancel selection of all outdoor units.
- B:** Set whether to enable outdoor unit cycling control across the whole system or not.
 Note
 • If you select "Yes", make sure that you set "No" for indoor unit cycling control settings.
 • Change list order. The list order changes each time you touch it.
- C:** Display
 The display follows the order set in "ID unit settings" (P.141).
 O/D unit
 The display follows the address order of the outdoor unit systems.
 Address
 The display follows the address order of the outdoor unit systems (P.141).
- D:** The outdoor units with a check mark next to them will be the subject of the changes to the settings.
- E:** The O/D unit cyclic is enabled for the selected outdoor unit if you put a check mark here. This is linked with the "O/D unit cyclic Valid" ("Setting" dialogue) (P.102) setting.
- F:** The "Term setting" dialogue is displayed when you touch this.
- G:** The "Setting" dialogue is displayed when you touch this.

Energy saving

Settings for energy saving

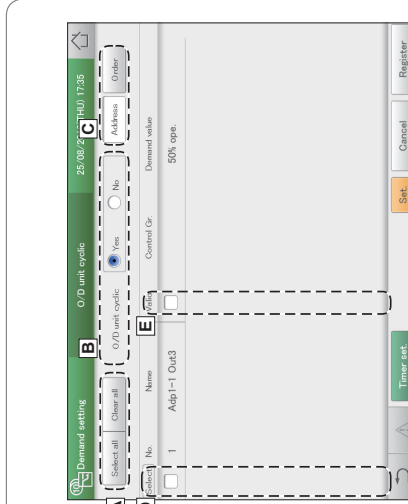

The "O/D unit cyclic" screen

- A:** [Select all]/[Clear all] buttons
 [Select all] Select all outdoor units.
 [Clear all] Cancel selection of all outdoor units.
- B:** Set whether to enable outdoor unit cycling control across the whole system or not.
 Note
 • If you select "Yes", make sure that you set "No" for indoor unit cycling control settings.
 • Change list order. The list order changes each time you touch it.
- C:** Display
 The display follows the order set in "ID unit settings" (P.141).
 O/D unit
 The display follows the address order of the outdoor unit systems.
 Address
 The display follows the address order of the outdoor unit systems (P.141).
- D:** The outdoor units with a check mark next to them will be the subject of the changes to the settings.
- E:** The O/D unit cyclic is enabled for the selected outdoor unit if you put a check mark here. This is linked with the "O/D unit cyclic Valid" ("Setting" dialogue) (P.102) setting.
- F:** The "Term setting" dialogue is displayed when you touch this.
- G:** The "Setting" dialogue is displayed when you touch this.

Energy saving

Settings for energy saving

Control operation at regular intervals [O/D unit cyclic]

5

- The "Setting" dialogue closes.
- To cancel the settings, touch [Cancel].



6 Set other indoor units.

- Repeat steps 3 to 5.

7 Touch [Timer set].

- The "Term setting" dialogue is displayed.



8 Touch the number.

- You can set 4 different time slots.

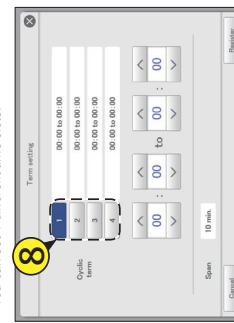

Energy saving

Displaying data in graphs

Registering demand point input [Register demand point]

Register the DI terminal of the main unit or the communication adaptor that inputs the demand point when an external equipment is connected.

1 Touch [Demand setting] in "EnergySaving".

3 Select the communication adaptor from the list at right (3-1) and touch [Settings] (3-2).

- Set the demand points ("Demand 1", "Demand 2", and "Demand 3").
- You can change the name of the adaptor displayed for the demand points. Touch the text box and change with the touchscreen keyboard. (Enter a name up to 10 alphanumeric characters)

4

Touch [Register].

- To cancel the settings, touch [Cancel].

2 Touch [Register demand point].

- The "Register demand point" screen is displayed.

Displaying data in graphs



This chapter explains how to display graphs.

This unit is equipped with the functionality to collect the data accumulated in the devices and to turn this into graphs. Making the data visible makes it possible to objectively manage energy saving.

Screen menu	Overview	Page
Bar chart	Quantities of energy usage (electricity, gas), etc., are shown in bar charts.	109
Line graph	Temperature changes, etc., are shown in line graphs.	113

Energy saving

Settings for energy saving

Graph display function

This unit is equipped with a "graph display" function as part of the energy saving functionality. Collect data from devices such as the indoor units, outdoor units, and pulse meters, set the display period (daily, monthly, or yearly) and display the graphs.

Types of graph

There are 2 types of graph that you can display on this unit.

Display example	Bar charts	Line graphs
		
Main uses	Comparing accumulated data (thermostat ON operating times, etc.)	Comparing temperature changes, etc.

Graph settings

The following settings are necessary to display graphs.

(○ are items that can be set)

● Display period

Display period	Bar	Line	Explanation
days	○	○	The transition of daily data is displayed in hourly units (1 hour).
Mths	○	○	The transition of monthly data is displayed in daily units (1 day).
Yrs.	○	○	The transition of yearly data is displayed in monthly units (1 month).

● Display method

Display method	Bar	Line	Explanation
Ranking	○	○	Display the 10 top best or worst units based on collected values for the item.
By unit	○	○	Data by item is displayed for units. (Items are fixed)
UnitCmpar	○	○	Display the data for items by unit (you can select up to 4 devices).
ChngPdy	○	○	The three days' worth of data for items and units from the day before the previous day, and the same day is displayed.
UserSct	○	○	You can select items freely.

● Unit

Unit	Bar	Line	Explanation
I/D	○	○	Set indoor unit as the display target.
O/D	○	○	Set outdoor unit as the display target.
Pulse	○	○	Set accumulator (pulse meter) as the display target.
Ar.	○	○	Set area group as the display target.

Energy saving

Displaying data in graphs

● Graph type/Data type

Type	Bar	Line	Explanation
Graph	P1gr ^{*1}	○	Selected units or data are lined up horizontally, with one unit on the X axis.
	Cumulative ^{*2}	○	Data for selected units are stacked, with one unit on the X axis.
	SeqUnit ^{*3}	○	The X axis displays the units (10 units in ascending order of display).
Data	Max ^{*4}	○	The highest value of the selected item is used as the data.
	Min ^{*4}	○	The lowest value of the selected item is used as the data.
	Avg ^{*4}	○	The average value of the selected item is used as the data.
	SpctTime	○	The value of the selected item from the specified time is used as the data.

*1 Display example (Parallel)



*2 Display example (Stack)



*3 Display example (Unit)

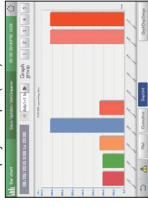

*4 These can be set when "Mths" is selected as the display period.

● Item

The items you can set depend on the unit selected.

● Bar charts

Unit	days	Mths	Yrs.
I/D	Tti opr time (minutes) T/S ON op. time (minutes)	Tti opr time (minutes) Elec. usage (kWh) PowerGenrtn gas usage (m³) A/C gas cost	T/S ON op. time (minutes) A/C gas usage (m³) ElectricCost PwrGrnGasCost
O/D	O/D Unit opern count (times) Invert cuml power genrtn (kWh)	Engine operating time (minutes) PV cumulative pwr genrtn (kWh)	
Pulse	Incr. amount		
Ar.	Tti opr time (minutes) T/S ON op. time (minutes)	Tti opr time (minutes) Elec. usage (kWh) PowerGenrtn gas usage (m³) A/C gas cost	T/S ON op. time (minutes) A/C gas usage (m³) ElectricCost PwrGrnGasCost

● Line graphs

Unit	days	Mths
I/D un	Set T. (°C) Room temp. (°C)	Discharge temp (°C) Suction temp (°C)
O/D un	Outdoor temp (°C) PV InstPwrGen (kW)	Invert inst power genrtn (kW)

Note

- If you selected [By unit] as the display method, all items are displayed for the relevant units. (You cannot select the items)

Energy saving

Displaying data in graphs

[UserSict]

- "Setting items freely" (P.116)

When you select [UserSict] for both bar charts and line graphs, you can display graphs where you can freely select the units and items. By registering the settings in "Graph group" to suit their use, you can easily display them without having to select the items every time. (You still need to set the display period and other items.) Up to 5 graph groups can be registered.

Example

The monthly transitions of total operating hours, interstitial ON operating times, and electricity usage for the outdoor unit are registered in graph group 1.

Example

The daily transition of operation cycles and engine operating times for 2 outdoor units is registered in graph group 2.

Graphing operating times and energy usage

Specify the display period (daily, monthly, yearly), and display mainly accumulated data, such as energy usage (electricity, gas), total operating hours, and charges (electricity, gas), in bar charts. You can put target values in graphs (these are displayed as red lines on the graphs). Putting target values in the graphs will help raise awareness about saving energy.

1 Touch [Energy saving mgmt] in "Energy Saving".

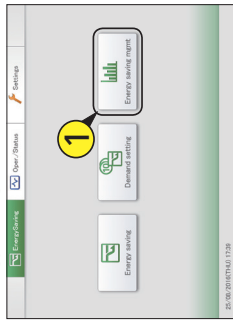

4 Set the display range.

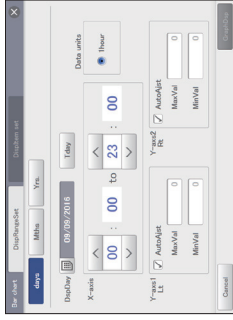

(The screen shown is if "days" is selected.)

Energy saving

2 Touch [Bar chart].

- The main screen is displayed.

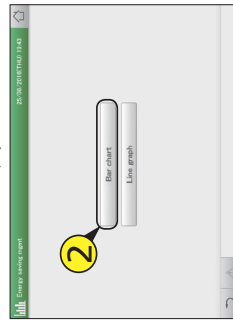

Energy saving

Item	Explanation
Display period (days/Mths/Yrs.)	Refer to P.106 for information about display periods.
Day	Set the dates to be displayed.
Day/Mth	1) Touch when "days" is selected.
Year	2) Select the date to display in the "Calendar" dialogue. The current date is displayed if you touch [Today].
	• When "Mths" or "Yrs." is selected
	1) Select the month or year to display with .
	▶ The current month or year is displayed if you touch [CuMo] or [CuYr].
X-axis	Use to set the first and last time or period.
	• When "days", 00:00 to 24:00 in 1-hour steps
	• When "Mths", 1st to 31st in 1-day steps
Data units	Indicates the units for one tick mark on the X axis.
	days: Fixed at 1 hour
	Mths: Fixed at 1 day
	Yrs.: Fixed at 1 month
Y-axis L1 Y-axis R1	Set the range of values for the axis. If you put a check mark in "Auto/Asst" the values will be set automatically to the maximum value and the minimum value. If you want set the maximum and minimum values manually, remove the check mark and enter the values in the text box.

Continued on next page

3 Touch [GrphDspSetgs].

- The display settings screen is displayed.

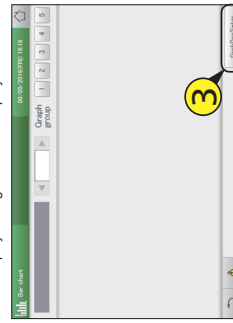

Energy saving

Displaying data in graphs

Graphing operating times and energy usage

5 Touch [DisplayItem set].

- The "DisplayItem set" screen is displayed.



6 Select how to display.

- Refer to P.106 for information about how to display.

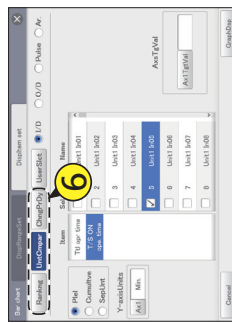

(The following explains using examples as if "UnitCmpar" was selected)

7 Select the unit.

- Refer to P.106 for information about units.



Graphing operating times and energy usage

8 Select the type of graph.

- Refer to P.106 for information about types of graphs.
- If you have selected [Ranking] as the display method, select either "Worst" or "Best".



9 Set the display units for the Y axis.

- (1) Touch [Ax1].

- The "Unit setting" dialogue is displayed.
- Select the display units for the Y axis.



- (2) Touch the unit to display.

- The settings are registered and the "Unit setting" dialogue closes.

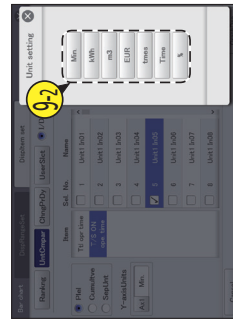

Continued on next page

Graphing operating times and energy usage

12 Set the goal values for the axis.

- Touch [Ax1Goal] and enter the numbers with the touchscreen numeric keypad.
- A red line is inserted to indicate the goal values for the graph.
- You can set any goal.
- This cannot be set if you have selected "Ranking" as the display method.



13 Touch [GraphDsp].

- The graph is displayed in the main screen.
- To cancel the settings, touch [Cancel].



Energy saving

Displaying data in graphs

Energy saving

Displaying data in graphs

Note

- The number of units you can select depends on the settings for display method and graph type.

Display method	Graph type	
	Piel	Cumulative
UnitCmpar	Up to 4	Up to 4
ChngPrDy	1 only	1 only

Graphing temperature changes

Specify the display period (daily, monthly), and display variable data such as set temperatures and indoor temperatures in line graphs.

4 Set the display range.

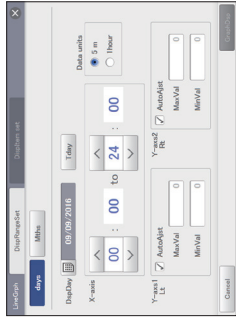

(The screen shown is if "Mths" is selected)

Item	Explanation
Display period (days/Mths)	Refer to P.106 for information about display periods.
DspDay DspMth	Set the dates to be displayed. • When "days" is selected 1) Touch [Day]. 2) Select the date to display in the "Calendar" dialogue. The current date is displayed if you touch [Today]. • When "Mths" is selected 1) Select the month to display with [Month]. The current month is displayed if you touch [Today].
X-axis	Use [AutoAdj] to set the first and last time or period. • When "days", 00:00 to 24:00 in 1-hour steps • When "Mths", 1st to 31st in 1-day steps Indicates the units for one tick mark on the X axis. days: Select either "5 m" or "1hour". Mths: Fixed at "1 day".
Data units	Set the range of values for the axis. If you put a check mark in "AutoAdj" the values will be set automatically to the maximum value and the minimum value. If you want set the maximum and minimum values manually, remove the check mark and enter the values in the text box.
Y-axis1 Lt Y-axis2 Rt	

Continued on next page

Graphing operating times and energy usage

Specify the display period (daily, monthly), and display variable data such as set temperatures and indoor temperatures in line graphs.

1 Touch [Energy saving mgmt] in "EnergySaving".

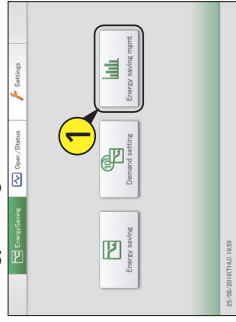

2 Touch [Line graph].

- The main screen is displayed.

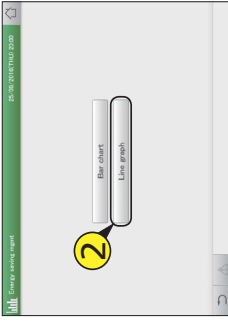

3 Touch [GrphDspSetgs].

- The display settings screen is displayed.

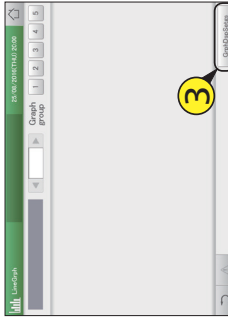

Energy saving

Displaying data in graphs

Type	Ranking	Display method UnitCompar	ChngPrdy
Worst/Best			
PleI			
Cumulative			
SepUnit			

*1 Touch [Worst] or [Best] to switch between rankings.
 *2 Touch [PleI], [Cumulative], or [SepUnit] to switch between the type of graph.
 *3 You can touch [Unit] to change the units displayed (10 units before or after).

Note

- Touch [GrphDspSetgs] to change the display range and displayed items.

Graphing temperature changes

5 Touch [Displtem set].

- The "Displtem set" screen is displayed.

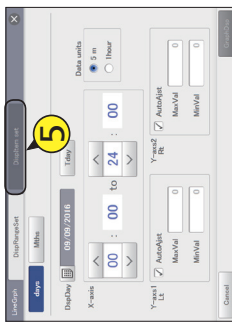

8 Select the type of data.

- Refer to P.107 for information about types of data.
- If you have selected [days] for the display period, this is not set.

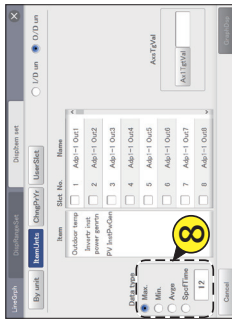

6 Select how to display.

- Refer to P.106 for information about how to display.

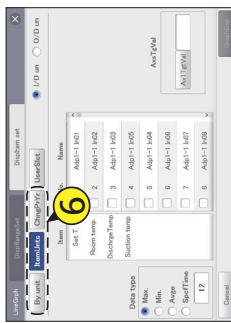

(The following explains using examples as if "ItemUnits" was selected)

7 Select the unit.

- Refer to P.106 for information about units.

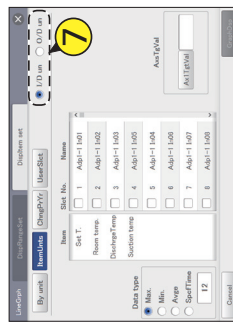

Graphing temperature changes

11 Set the goal values for the axis.

- Touch [Ax1TgVall] and enter the numbers with the touch screen numeric keypad.
- A red line is inserted to indicate the goal values for the graph.
- You can set any goal.

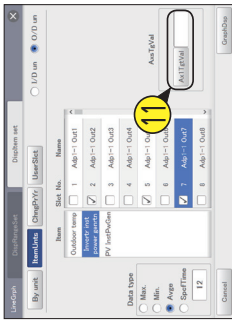

12 Touch [GraphDsp].

- The graph is displayed in the main screen.
- To cancel the settings, touch [Cancel].



Energy saving

Displaying data in graphs

Line graph example

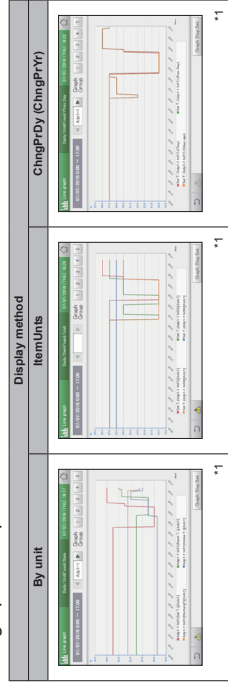

*1 You can touch [] to change the units displayed (10 units before or after).

Note

- Touch [Graph Disp. Set.] to change the display range and displayed items.

Continued on next page

Setting items freely

When you select [UserSct], you can display graphs where you can freely select the units and items. For example, the following combinations are possible.

- The monthly transitions of total operating hours, thermostat ON operating times, and electricity usage for indoor unit 01 is displayed in a bar chart.
- The daily transitions of set temperatures and indoor temperatures for indoor units 03 and 06 are displayed in a line graph.

Making the settings

1 Touch [Energy saving mgmt] in "EnergySaving".

- For details, refer to step 4 in "Graphing operating times and energy usage" (P.109) for bar charts, or step 4 in "Graphing temperature changes" (P.113) for line graphs.



2 Select the type of graph.

- The "Displtem set" screen is displayed.

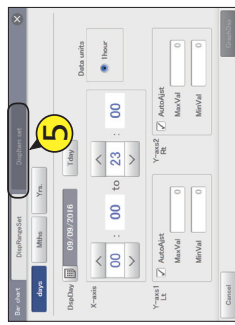

3 Touch [GrphDspSets].

- The display settings screen is displayed.

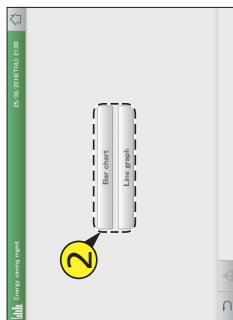

Continued on next page

Setting items freely

7 Select the unit.

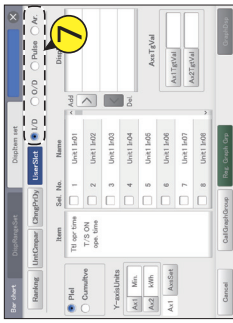

10 Touch [AxsSet] to select the axis to display.

- Select the axis to display the data item.
- The axis switches between "Ax1" and "Ax2" each time you touch it.



8 Select the type of graph.

- This setting can be selected only for "Bar chart".
- Refer to P.106 for information about types of graphs.

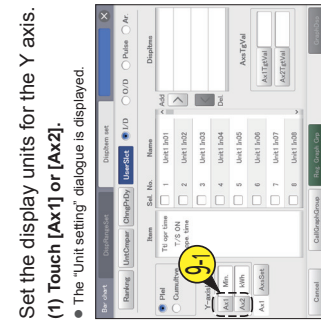

9 Set the display units for the Y axis.

- The "Unit setting" dialogue is displayed.

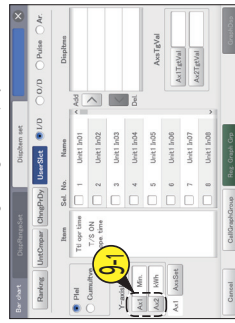

12 Select the unit of display.

- The settings are registered and the "Unit setting" dialogue closes.

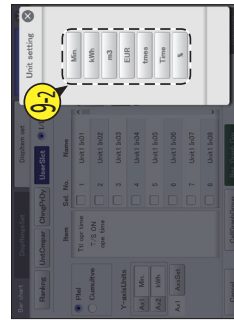

Continued on next page

Energy saving

Displaying data in graphs

Energy saving

Displaying data in graphs

11 Select the item.

- Refer to P.107 for the items you can set.
- You can select one item only.
- If you have selected [Unit] as the display method, the items are fixed so there is no need for you to set them.



12 Select the device name.

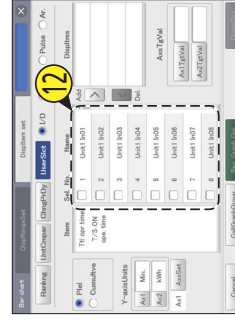

Setting items freely

13 Touch  to add to the display item list.

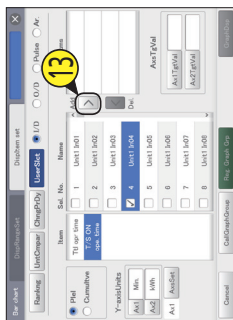

14 Repeat steps 11 to 13 to select the display items.

- You can add up to 4 display items.
- To delete from the display item list, select the display item and touch .

15 Set the goal values for the axis.

- Touch [Ax1TgtVall] or [Ax2TgtVall] and enter the numbers with the touchscreen numeric keypad.
- A red line is inserted to indicate the goal values for the graph.
- You can set any goal.



Registering as a graph group

1 Touch [EnergySaving] in "EnergySaving".

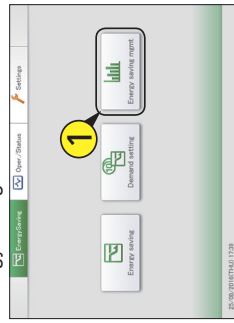

2 Select the type of graph.

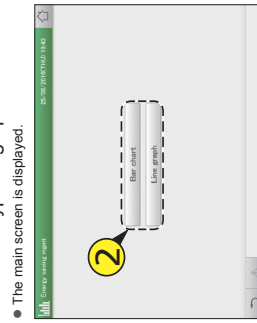

3 Select the graph group (3-1) and touch [GrpDspSetgs] (3-2).

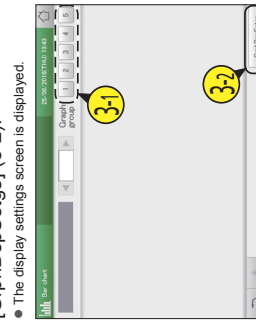

4 Make the graph display settings.

- Follow steps 4 to 14 in "Making the settings" (P.116 to 118) to make the graph display settings.

5 Touch [Reg. Graph Grp].

- The message "OK to overwrite [GraphGroupXX]?" (XX is the setting number of the selected graph group) is displayed.



6 Touch [Register].

- The setting is registered.
- To cancel registration, touch [Cancel].

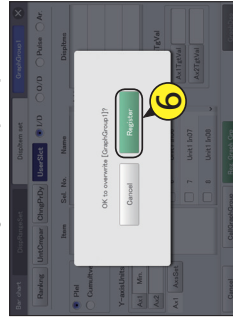

Energy saving

Displaying data in graphs

Setting items freely

16 Touch [GraphDsp].

- The graph is displayed in the main screen.
- To cancel the settings, touch [Cancel].



Energy saving

Displaying data in graphs

Displaying a registered graph

1 In the main screen, touch the number of the "Graph group" to be displayed.

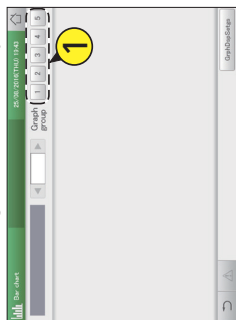

Modifying a registered graph

1 Touch the number of the "Graph group" to be displayed.

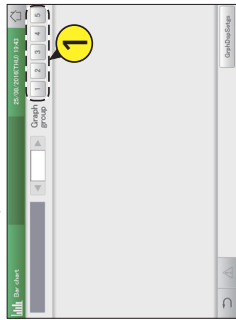

2 Touch [GrphDspSetgs].

- The display settings screen is displayed.

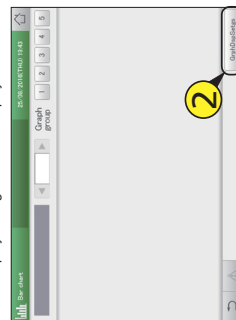

2 Touch [GrphDspSetgs].

- The display settings screen is displayed.



3 Set the display range.

- For details, refer to step 4 in "Graphing operating times and energy usage" (P-109) for bar charts, or step 4 in "Graphing temperature changes" (P-113) for line graphs.

4 Touch [GraphDsp].

- The graph is displayed in the main screen.
- To cancel the settings, touch [Cancel].

Note
• By touching the graph group numbers displayed in the graphs, you can display other registered graphs.

Continued on next page

Energy saving

Displaying data in graphs

4 Touch [Reg. Graph Grp] in the "Displtem set" screen.

- The message "OK to overwrite [GraphGroupXX]?" (XX is the setting number of the selected graph group) is displayed.

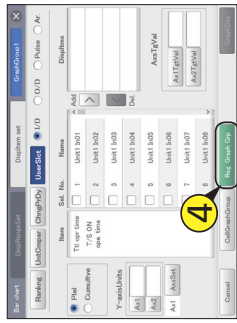

5 Touch [Register].

- The setting is registered.
- To cancel registration, touch [Cancel].

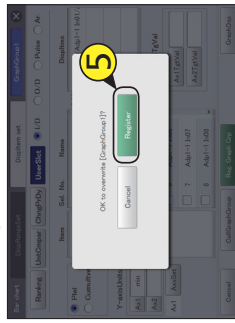

Note
• Touch [CallGraphGroup] and you can also modify the display item settings for other graph groups.



Energy saving

Displaying data in graphs

Setting the network

To control remotely over a network, you first need to set up the network. Consult your network administrator beforehand for the network settings.

- 1 Touch [System Settings] in "Settings".
 - The "System settings" screen is displayed.



- 2 Touch [Network settings].
 - The "Network settings" screen is displayed.



- 3 Change the settings.

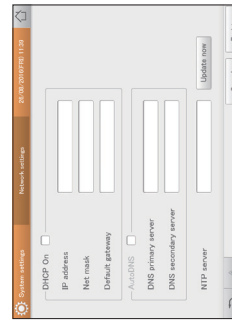

Perform remote operation of the unit over a network

Setting

Perform remote operation of the unit over a network

This chapter describes the settings and operation screen displays required to remotely control this unit over a network.

You can remotely control this unit from external devices over a network. Remote control is performed using a browser from a PC, smart phone, or tablet. Only users registered in this unit can operate. You can also limit the operations that can be performed on the unit using privileges.



Screen menu	Overview	Page
Network settings	Make settings to enable remote control over a network.	123
Web user settings	Register users that will access the unit over a network.	125

Setting

Item	Explanation
DHCP On	If you want to use a DHCP server, put a check mark here. If you enable this, you will be unable to set "IP address", "Net mask", or "Default gateway".
IP address	Set the IP address of this unit. Touch the text box and enter with the touchscreen keyboard. • You cannot set "0.0.0.0" or "255.255.255.255".
Net mask	Set the net mask of this unit. Touch the text box and enter with the touchscreen keyboard. • You cannot set "0.0.0.0".
Default gateway	Set the default gateway of this unit if necessary. Touch the text box and enter with the touchscreen keyboard. • You cannot set "0.0.0.0".
AutoDNS	If you want the IP address of the DNS server acquired automatically, put a check mark here. The "DNS primary server" and "DNS secondary server" will not be able to set if you choose to acquire automatically.
DNS primary server	Set the IP address of DNS primary server. Touch the text box and enter with the touchscreen keyboard. • You cannot set "0.0.0.0".
DNS secondary server	Set the IP address of DNS secondary server. Touch the text box and enter with the touchscreen keyboard. • You cannot set "0.0.0.0".
NTP server	Set the IP address of the NTP server if the clock is to be synchronised with an NTP server. Touch the text box and enter with the touchscreen keyboard. After setting, touch [Update now] to start synchronising the clock. • You cannot set "0.0.0.0".

Continued on next page

4 Touch [Register].

- To cancel the settings, touch [Cancel].

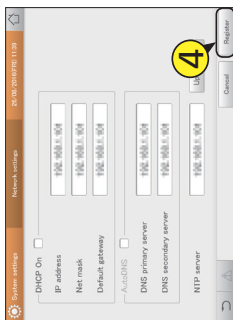

Perform remote operation of the unit over a network

Setting

Setting the users

Register users that will access the unit over a network. You can register up to 64 users. You can restrict operations with privileges (admin, operator, general user).

1 Touch [System Settings] in "Settings".

- The "System settings" screen is displayed.

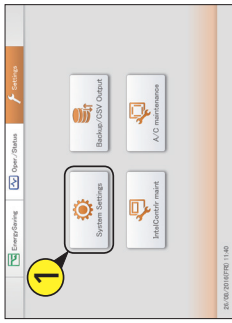

4 Touch [Sttng].

- The "Edit user strings" dialogue is displayed.



2 Touch [Web user settings].

- The "Web user settings" screen is displayed.



5 Enter a password.

- The touchscreen keyboard appears when you touch the text box. Refer to "Number and letter input" (P.188) for instructions on how to enter text.
- Enter a password of at least 8 numbers (alphameric only).

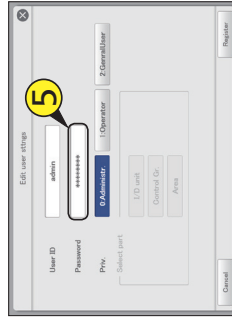

3 Put a check mark in the "Select" column of the user ID to be registered.

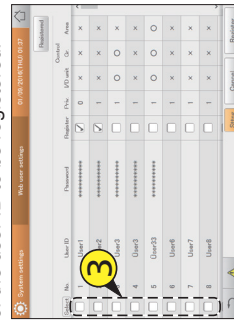

Continued on next page

12 Put a check mark in the "Register" column.

- Select the users that can operate over the network.

13 Touch [Register].

- The setting is registered.
- To cancel the settings, touch [Cancel].

The "Web user settings" screen
Users with a check mark next to them will be the subject of the changes to the user settings.

A: The users with the check marks next to them will be allowed to perform operations over the network.

Priv.	This shows the privileges of the user.		
0	Administrator	1	Operator
1	Operator	2	General user
2	General user	Users can use the categories with a "-".	

I/D unit

Control Gr.

Area

C: The "Edit user settings" dialogue is displayed when you touch this.

9 Touch [Register].

- The settings are registered and the "Select part" dialogue closes.
- To cancel registration, touch [Cancel].

10 Touch [Register].

- The settings are registered and the "Edit user strings" dialogue closes.

Continued on next page

11 Register other users.

- Repeat steps 3 to 10.

6 Select the privileges.

- Select "0:Administrator", "1:Operator", or "2:GeneralUser".
- Only one person can have the "0:Administrator" setting.

7 Select what is to be operated.

- The "Select part" dialogues are displayed when you touch "Area".
- Select what is to be operated ("I/D unit", "Control Gr.", "Area").
- When the privileges are set to "0:Administrator", all operations are available so it is not possible to select what to operate.

8 Select the devices to be operated (8-1) and touch > (8-2).

- The devices to be operated move to the list on the right (Web Supported Unit). Select the devices to be operated and touch < (to restore) to restore.
- Multiple devices can be selected to be operated.

Control remotely

You can remotely control this unit from the browser on a PC or similar device. The example here uses a PC to explain.

1 Start the browser.

2 Enter the IP address.

- Enter the "IP address" set in network settings.
- The login screen is displayed.

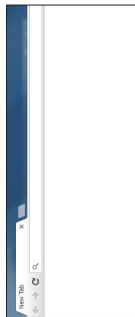

3 Enter the "User ID" and "Password".

- Enter the personal user ID and password set in user settings (P.125).
- The operation screen is displayed.
- The operations are the same as the operations on this unit.

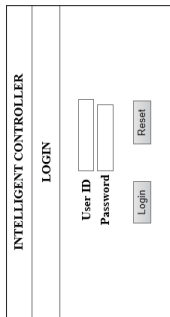

Backing up/restoring data



This chapter explains how to back up and restore data.

This unit has functionality to save the setting data, accumulated/distribution data, and log data to a USB memory device. (Back up function)
It also has the functionality to reload the saved data back into the unit. (Restore function)
By regularly saving data to USB memory devices, you can restore the data in the main unit if it is ever corrupted by power outages caused by lightning strikes, etc.

Screen menu	Overview	Page
Backup	Save data (settings, accumulation/distribution, logs) to USB memory devices.	130
Restore	Restore data that has been stored in the unit or saved to a USB memory device.	132
CSV Output	Export (output) the settings for this unit as a CSV file.	134
CSV Input	Import (input) the settings for this unit from a CSV file.	136
Auto-save CSV file	Saves the CSV files (distributions, logs) automatically generated in this unit.	138

Backing up data

Backing up data

You can save the setting data, accumulated/distribution data, and log data to a USB memory device. You can also backup over a network.

- 1 Open the storage door and connect a USB memory device to the USB terminal.
 - This step is not necessary if you are backing up over a network.

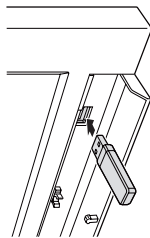

- 2 Touch [Backup/CSV Output] in "Settings".

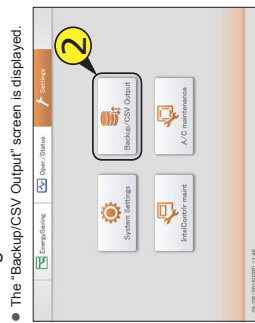

- 3 Touch [Backup].

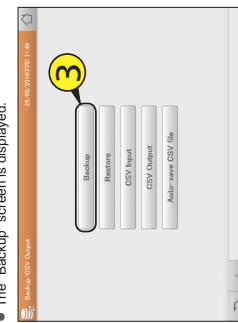

- 4 up. Touch [Save] for the items to be backed up.

- Saving starts. When saving is complete, a message is displayed.
- When backing up over a network, specify the location to save to.
- To backup other items, repeat the same procedure.

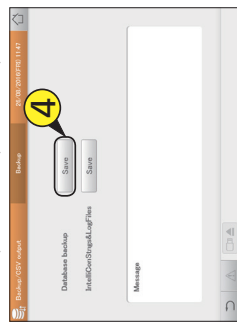

- 5 Touch [Close] when you want to disconnect the USB memory device.

- Remove your USB memory device after the message "USB memory can now be safely removed" is displayed.
- Close the storage door after removing the USB memory device.

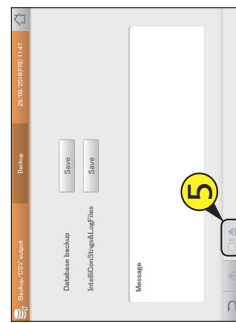

- Note**
- Backup files are generated once per day and saved within this unit. This procedure saves the backup files saved in this unit to a USB memory device.
 - The items you can back up are as follows:

Database backup	Save accumulated/distribution data.
Main unit Set.	Save schedule settings and group settings.
Log	Save alarm logs and operation/status change logs.

- The time required for backup depends on the volume of data.
- The 4 types of backup file are icsysset.zip, icsyslog.zip, icsyslogset.zip, and icsyslogplog.zip.
- When backing up over a network, this operation is not possible if backing up from another terminal.

Backing up/restoring data

Setting

Backing up/restoring data

Setting

Restoring data

You can restore data that has been backed up in the unit (saved) or to a USB memory device.

- 1 Open the storage door and connect a USB memory device to the USB terminal.

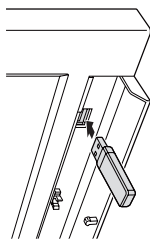

- 2 Touch [Backup/CSV Output] in "Settings".



- The "Backup/CSV Output" screen is displayed.

- 3 Touch [Restore].

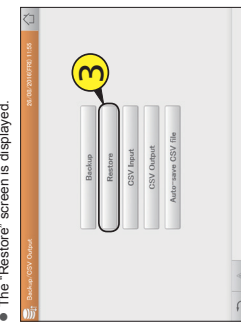

- The "Restore" screen is displayed.

- 4 Select the restore location and restore setting.

- The restore location can be either "InCo" or "USBmemory".
- The restore setting can be either "Application settings" or "Sys. Settings".

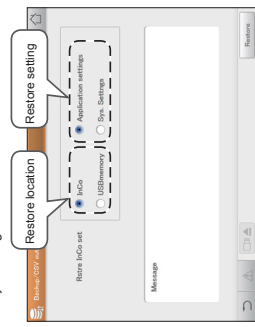

- 5 Touch [Restore].

- Restoring starts. When restoring is complete, the message "Restart" is displayed.
- Restart the unit. The data you restore becomes effective after restart.

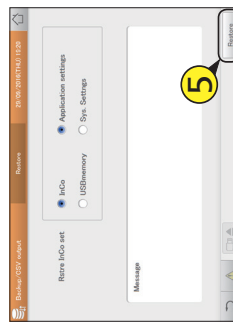

Continued on next page

- 6 Touch when you want to disconnect the USB memory device.

- Remove your USB memory device after the message "USB memory can now be safely removed" is displayed.
- Close the storage door after removing the USB memory device.

Note

- The items you can restore are as follows:
 [Restore main unit Set.] [Restore schedule settings and group settings].
- The time required for restoring depends on the volume of data.
- The data restored is that which was backed up.
- "InitCom..." may be displayed for a long time (up to 1 hour and 30 minutes) when restarting immediately after restoring backed up data. Under no circumstances turn the unit off at this stage. You may corrupt files in the unit and render it unable to start. If you are unable to start the unit, the data in the unit will need to be repaired, so contact the place of purchase or your servicing agent to ask them to restore the data.

Outputting settings as a CSV file

Outputting settings as a CSV file

Export (output) the settings for this unit as a CSV file.

The settings that are exported are as follows:

- Indoor unit settings
- Schedule group settings
- Area settings
- Outdoor unit settings
- Pulse meter settings
- Schedule
- Distribution group settings
- Communication adaptor settings
- Events

1 Open the storage door and connect a USB memory device to the USB terminal.

- This step is not necessary if you are backing up over a network.

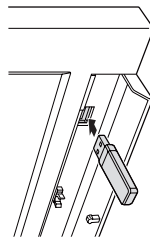

2 Touch [Backup/CSV Output] in "Settings".

- The "Backup/CSV Output" screen is displayed.



3 Touch [CSV Output].

- The "CSV Output" screen is displayed.

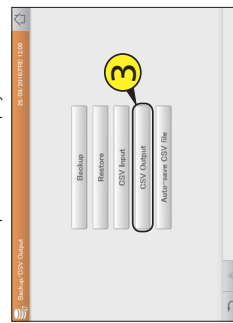

6 Touch [Export].

- Exporting starts. The message "Exporting of XXX CSV file was successful." is displayed when the export finishes.
- To export other settings, repeat steps 4 to 6.
- To cancel the export, touch [Cancel].

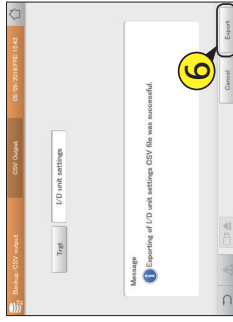

7 Touch [Disconnect] when you want to disconnect the USB memory device.

- Remove your USB memory device after the message "USB memory can now be safely removed" is displayed.
- Close the storage door after removing the USB memory device.

Note

- The time required for export depends on the volume of data.

Backing up/restoring data

Setting

Backing up/restoring data

Setting

4 Touch [Trgt].

- The "Output target" dialogue is displayed.

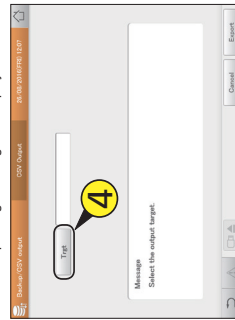

5 Touch setting name to be exported.

- The settings are registered and the "Output target" dialogue closes.

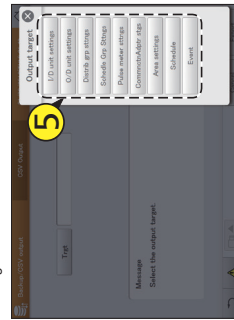

Continued on next page

Inputting settings as a CSV file

Import (input) the settings for this unit in CSV format.

The settings that are imported are as follows:

- Indoor unit settings
- Outdoor unit settings
- Area settings
- Distribution group settings
- Communication adaptor settings

1 Open the storage door and connect a USB memory device to the USB terminal.

- This step is not necessary if you are importing over a network.

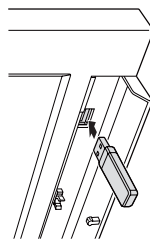

2 Touch [Backup/CSV Output] in "Settings".

- The "Backup/CSV Output" screen is displayed.



3 Touch [CSV Input].

- The "CSV Input" screen is displayed.

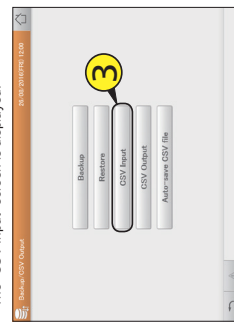

Inputting settings as a CSV file

6 Touch [File select].

- The file selection screen is displayed.
- If you are selecting across a network, the file selection dialogue is displayed.

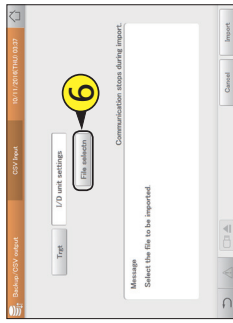

8 Touch [Import].

- Importing starts.
- To cancel the import, touch [Cancel].

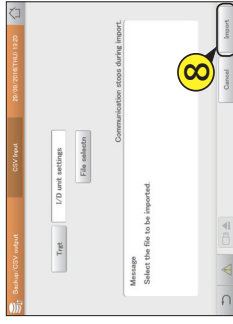

7 Select the file to import and touch [Select].

- The file selection screen is closed.
- To cancel file selection, touch [Cancel].
- If you are selecting across a network, select the file in the file selection dialogue and click [Select].

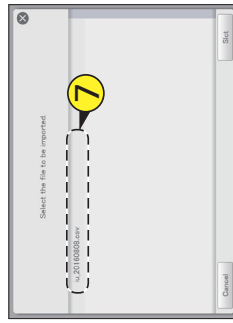

9 Touch [Disconnect] when you want to disconnect the USB memory device.

- Remove your USB memory device after the message "USB memory can now be safely removed" is displayed.
- Close the storage door after removing the USB memory device.

Backing up/restoring data

Setting

5 Touch setting name to be imported.

- The settings are registered and the "input" dialogue closes.

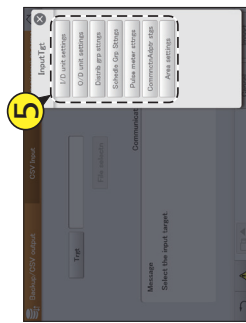

Continued on next page

Backing up/restoring data

Setting

- Note**
- The time required for import depends on the volume of data.

Saving automatically generated files

Saving automatically generated files

Save the CSV files (distributions, logs) automatically generated in this unit as ZIP format to a USB memory device.

- 1 Open the storage door and connect a USB memory device to the USB terminal.
 - This step is not necessary if you are downloading over a network.

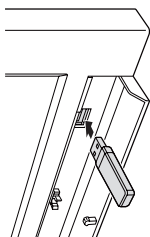

- 2 Touch [Backup/CSV Output] in "Settings".



- 3 Touch [Auto-save CSV file].

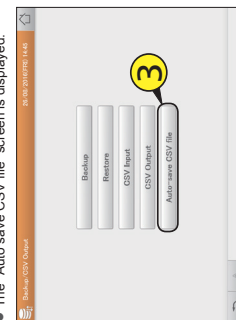

- 7 Touch [Save].
 - A confirmation message appears.
 - Specify the location to save to when doing so over a network.
 - To cancel saving the file, touch [Cancel].

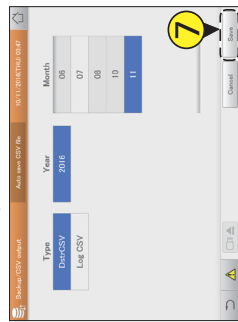

- 5 Select the "Year" to save.

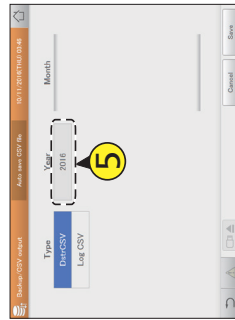

- 6 Select the "Month" to save.
 - You can select multiple "Month".
 - Touch \uparrow to scroll the "Month" display up or down.

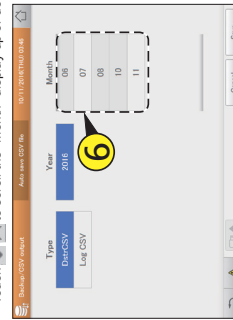

Continued on next page

Backing up/restoring data

Setting

- 8 Touch [OK].
 - Saving starts. When saving is complete, a completion message is displayed.

- 9 Touch \square when you want to disconnect the USB memory device.
 - Remove your USB memory device after the message "USB memory can now be safely removed" is displayed.
 - Close the storage door after removing the USB memory device.

Note

- Distribution data and log data is automatically saved in the unit as CSV files once per day. CSV files are automatically generated every month.
- This procedure saves the CSV files specified by year and month to a USB memory device. You can also download over a network.

Backing up/restoring data

Setting

Basic settings on the indoor unit

Display details about indoor units (indoor unit addresses, groups belonged to, etc.). Settings can also be changed.

1 Touch [System Settings] in "Settings".

- The "System settings" screen is displayed.



4 Put a check mark in the "Register" column.

- Select the indoor units you want to manage.
- This procedure is not necessary if central addresses have been automatically set. (→ "Automatically setting central addresses" (P.144))



2 Touch [I/D unit settings].

- The "I/D unit settings" screen is displayed.

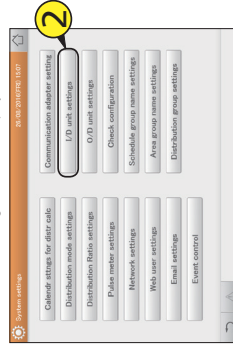

5 Touch [Register].

- To cancel the settings, touch [Cancel].



3 Check the setting details (P.142).



Configuring the system



This chapter describes how to make settings required to run the system.

- The main settings are as follows:
 - Group settings (schedule, area, distribution)
 - Pulse meter settings, distribution mode settings, distribution ratio settings
 - Email settings

Screen menu	Page
Calendar strings for distr calc	148
I/D unit settings	141
Schedule group name settings	151
Area group name settings	153
Pulse meter settings	158
Distribution mode settings	160
Distribution Ratio settings	161
Event control	162
Email settings	168
O/D unit settings	145
Distribution group settings	155
Communication adapter setting	170

Configuring the system

Setting

Configuring the system

Setting

Editing settings

- Put a check mark in the "Select" column.
 - You can select more than one.

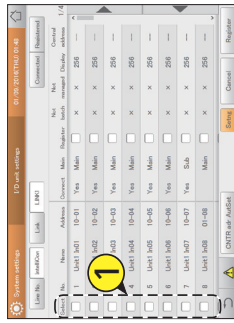

2

Touch [Setng].

- The "Edit unit settings" dialogue is displayed.



3

Change the settings.

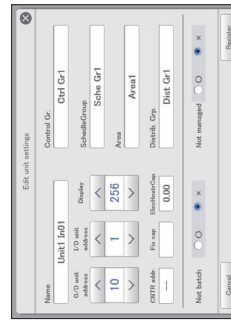

Continued on next page

The "I/D unit settings" screen

- Select the adaptor (this unit, communication adaptor) that the indoor unit is connected to.
- Select the linked system that the indoor unit is connected to.
- A list of indoor units with "Yes" in the "Connect" column is displayed when you touch this (turn the setting on). Touch again and all indoor units are displayed in a list (turn the setting off).
- A list of indoor units with a check mark in the "Register" column is displayed when you touch this (turn the setting on). Touch again and all indoor units are displayed in a list (turn the setting off).

E: Details about indoor units are displayed in a list.

Item	Explanation
[Select]	Select the indoor units whose settings you want to change.
Name	The names of the indoor units are displayed.
Address	The addresses of the indoor units are displayed.
Connect	If connected to this unit, "Yes" is displayed.
Main	If the parent device, "Main" is displayed.
Register	If you want it to be managed by this unit, put a check mark here.
Not batch	"O" is displayed if the device is not subject to batch operations, and "X" is displayed if it is subject to batch operations.
Not managed	"O" is displayed if the device is not subject to management, and "X" is displayed if it is subject to management.
Display	This indicates the display order.
Central address	This shows the central address.
Control Gr.	This shows the control group name it belongs to.
ScheduleGroup	This shows the schedule group name it belongs to.
Area	This shows the area group name it belongs to.
Distrib. Grp.*	This shows the distribution group name it belongs to.
Cap	This shows the operational capacity values for the indoor unit.
Fix cap	The fixed capacity values of the indoor unit.
I/D type	This shows the model name of the indoor unit.
PrdctTyp	This shows the product type (PAC or GHP).
ElecHeat	This shows the capacity values of the electric heater.

* If the distribution mode (P.160) is set to "Time", do not allocate PAC and GHP to the same distribution groups. Central addresses are automatically set for indoor units with a check mark in the "Register" column. (→ "Automatically setting central addresses" (P.144))

G: When you touch this, the "Edit unit settings" dialogue is displayed for indoor units with a check mark in the "Select" column.

- Put a check mark in the "Select" column.
 - You can select more than one.

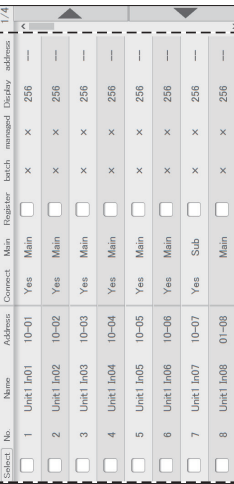

2

Touch [Setng].

- The "Edit unit settings" dialogue is displayed.

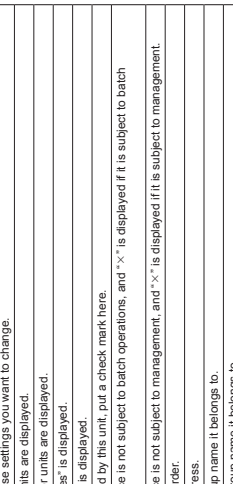

3

Change the settings.

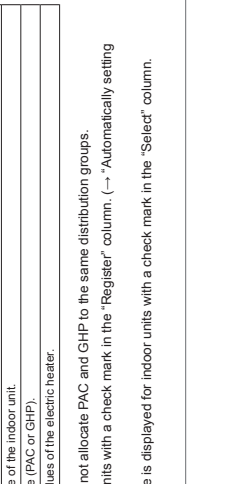

Continued on next page

Item	Explanation
Name	Change the name of the indoor unit. Touch the text box and enter with the touchscreen keyboard. You can enter up to 16 letters or numbers.

Basic settings on the outdoor unit

Display details about outdoor units (outdoor unit addresses, etc.). Settings such as the names can also be changed.

1 Touch [System Settings] in "Settings".

- The "System settings" screen is displayed.



2 Touch [O/D unit settings].

- The "O/D unit settings" screen is displayed.

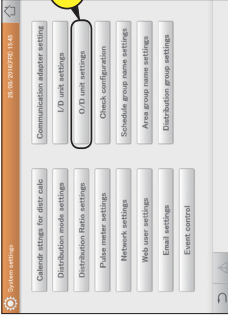

3 Check the setting details (P.146).



Configuring the system

Setting

Basic settings on the indoor unit

Automatically setting central addresses

1 Put a check mark in the "Register" column.

- Select the indoor units you want to manage.



2 Touch [CNTR adr AutSet].



Note

- The central address is shared with other centralised controllers (system controllers, etc.). Do not change unless necessary.
- After setting the central address in the "Edit unit settings" dialogue, and then enable [CNTR adr AutSet], the central addresses will be overwritten.

4 Touch [Register].

- To cancel the settings, touch [Cancel].

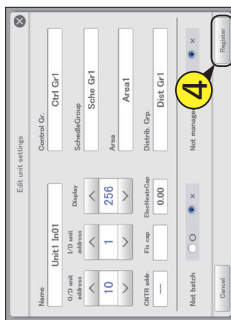

5 Touch [Register].

- To cancel the settings, touch [Cancel].



Note

- Do not allocate PAC and GHP to the same area or distribution groups when using time distribution.

Configuring the system

Setting

2 Touch [O/D unit settings].

- The "O/D unit settings" screen is displayed.

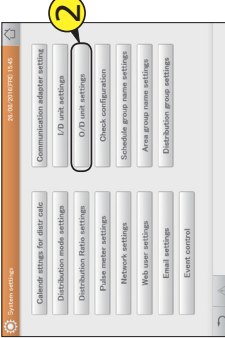

3 Check the setting details (P.146).



5

Touch [Register].

- To cancel the settings, touch [Cancel].

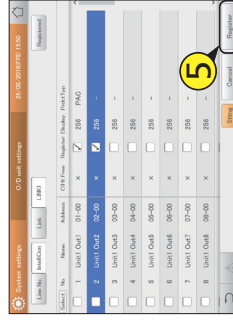

Basic settings on the outdoor unit

The "O/D unit settings" screen

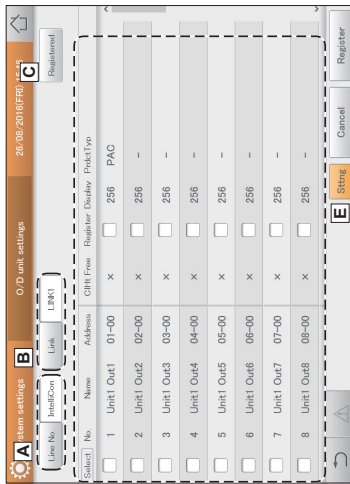

- A: Select the adaptor (this unit, communication adaptor) that the outdoor unit is connected to.
- B: Select the linked system that the outdoor unit is connected to.
- C: A list of outdoor units with a check mark in the "Register" column is displayed when you touch this (turn the setting on). Touch again and all outdoor units are displayed in a list. (turn the setting off)
- D: Details about outdoor units are displayed in a list.

Item	Explanation
[Select] No.	Select the outdoor units whose settings you want to change. The serial number is displayed.
Name	The names of the outdoor units are displayed.
Address	The addresses of the outdoor units are displayed.
CHt, Free	"C" is displayed if the outdoor unit is the type that can both cool and heat. "X" is displayed if it is the specialised type.
Register	If you want it to be managed by this unit, put a check mark here.
Display	This indicates the display order.
Product Type	This shows the product type (PAC or GHP).

- E: When you touch this, the "Edit O/D unit settings" dialogue is displayed for outdoor units with a check mark in the "Select" column.

Basic settings on the outdoor unit

Editing settings

1 Put a check mark in the "Select" column.

- You can select more than one.



2 Touch [Stng].

- The "Edit O/D unit settings" dialogue is displayed.



3 Change the settings.

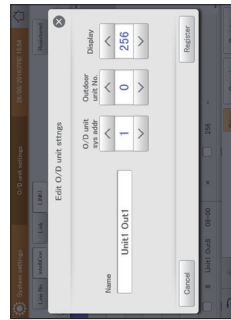

Item	Explanation
Name	Change the name of the outdoor unit. You can enter up to 16 letters or numbers.
O/D unit sys addr	Use \uparrow \downarrow to set the system addresses of the outdoor units (1 to 30).

Configuring the system

Setting

Configuring the system

Setting

4

Touch [Register].

- To cancel the settings, touch [Cancel].

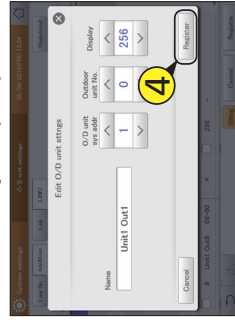

5

Touch [Register].

- To cancel the settings, touch [Cancel].



Basic settings for distribution calculation

Set specified days, cut-off days, particular time slots (regular hour ranges) and days of the week for calculating distributions.

1 Touch [System Settings] in "Settings".

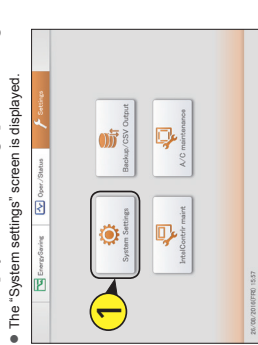

- The "System settings" screen is displayed.

2 Touch [Calendar stings for distr calc].



- The "Calendar stings for distr calc" screen is displayed.

3 Change the settings.



Item	Explanation
SpecifyDay-Calendar	Set specified days (days where the whole day will have a special distribution setting, such as holidays, when the time slot doesn't matter). These can be set starting with the current month and up to 2 years in the future. (→ "Registering specified days" (P.149))
CutoffDay	Set the monthly cut-off days ("1" to "28", "End"). (→ "Registering cut-off days" (P.149))
RightHourRange	Set the distribution time slots for each day of the week. Regular hour range settings possible if you put a check mark in "Valid". The "Regular hour range settings" dialogue is displayed when you touch [RightHourRange sngs]. (→ "Set the target time slots for distribution calculation" (P.150))

4 Touch [Register].

- To cancel the settings, touch [Cancel].

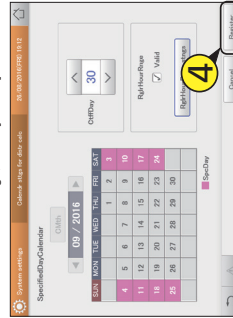

Basic settings for distribution calculation

Registering specified days

1 Touch the date for the specified day.

- Use ←, →, ▲, ▼ to select the registered month. Touch [C(Mth)] to return to the current month.
- The colour of the date column changes when you touch this. Touch again to return to the original. You cannot set a date in the past, however.
- Touch the day of the week column to set the specified day by day of the week.

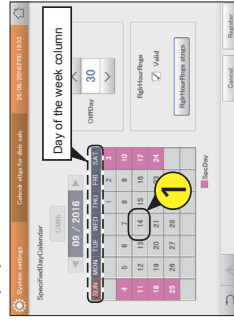

Registering cut-off days

1 Touch ▲, ▼ to move the days forward, touch ▼, ▲ to move the days back.

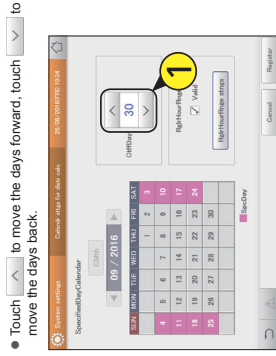

Changing the name of the schedule group

Edit the name of the operating schedule group.

- 1** Touch [System Settings] in "Settings".

 - The "System settings" screen is displayed.
- 2** Touch [Schedule group name settings].

 - The "Set schedule group name" screen is displayed.
- 3** Put a check mark in the "Select" column.

 - Select the schedule group name to be edited.
- 4** Touch [Setting].

 - The "Edit schedule group settings" dialogue is displayed.
- 5** Change the settings.
- 6** Put a check mark in the "Select" column.

 - Select the schedule group name to be edited.

Configuring the system

Setting

Continued on next page

Item	Explanation
Name	Edit the name of the schedule group. You can enter up to 16 letters or numbers.
Display	Use \uparrow \downarrow to set the order when displayed in a list.

Basic settings for distribution calculation

Set the target time slots for distribution calculation

- 1** Touch [RgIrHourRange stings].

 - The "Regular hour range settings" dialogue is displayed.
- 2** Touch the cell to be entered.

 - You can select all of the time slots for a day of the week by touching the day of the week column.
- 3** Set the start and end times.

 - Use \uparrow \downarrow to set "Hours" and "Minutes".
- 4** Touch [Set].

 - The set time is displayed in the cell.
 - To delete the set time slot, select the time slot to delete and touch [Clear].
 - To copy the set time slot, select the time slot to copy and touch [Copy]. Next select the place you want to paste to and touch [Paste].
- 5** Touch [Register].

 - The "Regular hour range settings" dialogue closes.
 - To cancel the settings, touch [Cancel].
- 6** Put a check mark next to "Valid".

Configuring the system

Setting

Changing the name of the schedule group

- 6** Touch [Register].
- The "Edit schedule group settings" dialogue closes.
 - To cancel the settings, touch [Cancel].

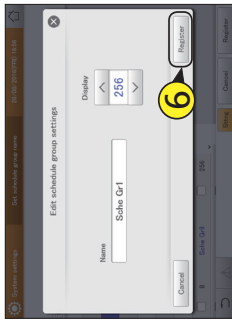

- 8** Touch [Register].
- To cancel the settings, touch [Cancel].

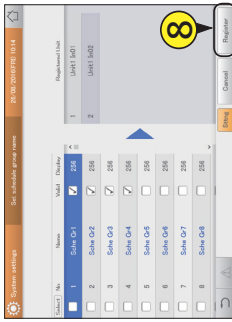

- 7** Put a check mark in the "Valid" column.
- Put a check mark in the schedule group to be used for the operating schedule.

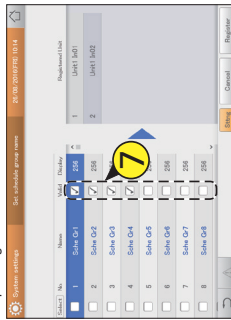

The "Set schedule group name" screen

- A: Put a check mark in the group to be edited.
- B: Put a check mark here if schedule group is to be used.
- C: The indoor units belonging to the selected schedule group are displayed.
- D: The "Edit schedule group settings" dialogue is displayed when you touch this.

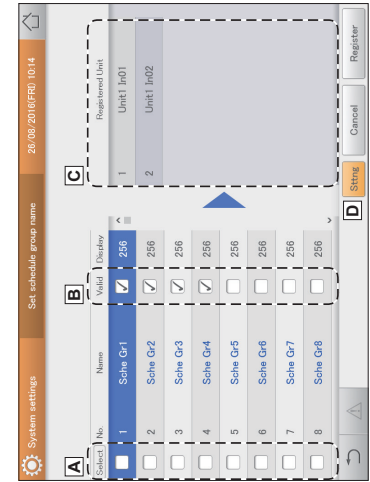

Changing the name of the area group

Edit the name of the area group.

- 1** Touch [System Settings] in "Settings".
- The "System settings" screen is displayed.

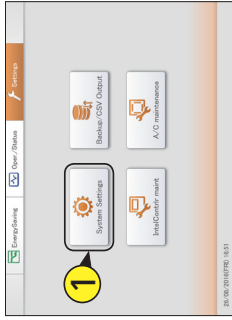

- 4** Touch [Setting].
- The "Edit area group settings" dialogue is displayed.



- 2** Touch [Area group name settings].
- The "Area group name settings" screen is displayed.

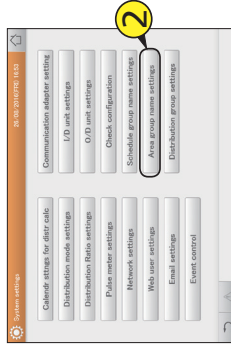

- 5** Change the settings.

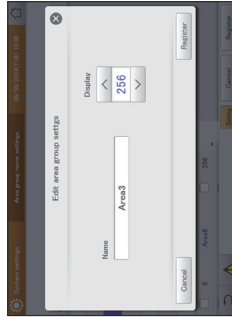

Item	Explanation
Name	Change the name of the area group. You can enter up to 16 letters or numbers.
Display	Use <input type="text"/> to set the order when displayed in a list.

Continued on next page

Configuring the system

Setting

Configuring the system

Setting

- 3** Put a check mark in the "Select" column.
- Select the area group name to be edited.

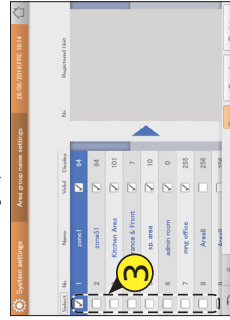

Changing the name of the area group

6 Touch [Register].

- The "Edit area group settings" dialogue closes.
- To cancel the settings, touch [Cancel].

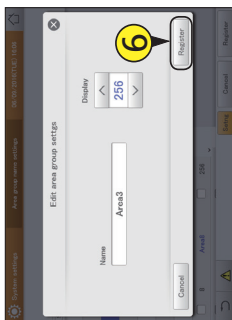

8 Touch [Register].

- To cancel the settings, touch [Cancel].

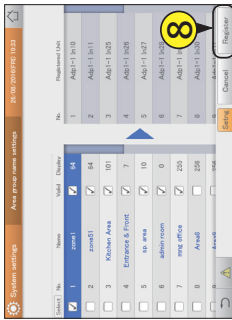

7 Put a check mark in the "Valid" column.

- Put a check mark in the area group to use.



The "Area group name settings" screen

- A: Put a check mark in the group to be edited.
- B: Put a check mark in the group name use the area group.
- C: The names of the indoor units belonging to the selected area group are displayed.
- D: The "Edit area group settings" dialogue is displayed when you touch this.

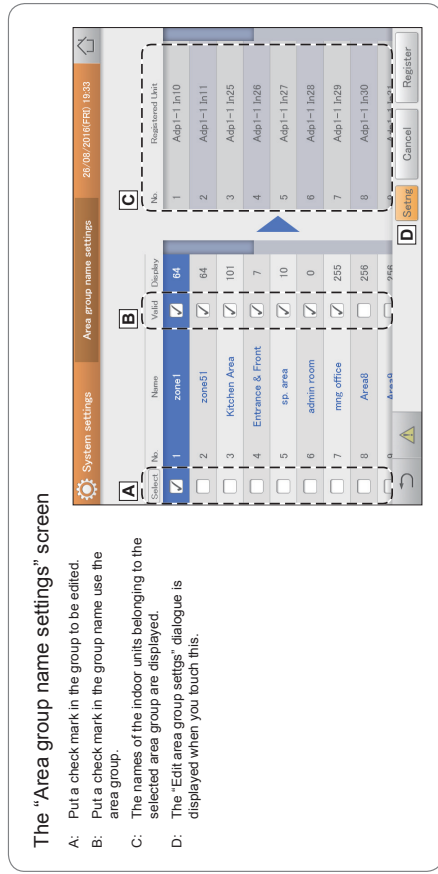

Changing the name of the distribution group

Edit the name of the distribution group.

1

Touch [System Settings] in "Settings".

- The "System settings" screen is displayed.

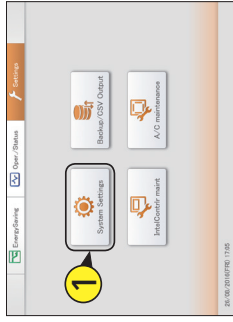

4

Touch [Setng].

- The "Edit distribution group settings" dialogue is displayed.



2

Touch [Distribution group settings].

- The "Distribution group settings" screen is displayed.

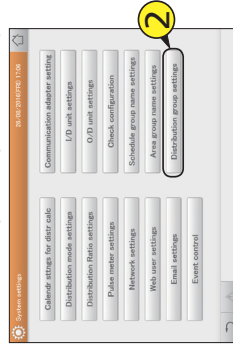

5

Change the settings.



3

Put a check mark in the "Select" column.

- Select the distribution group name to be edited.



Configuring the system

Setting

Configuring the system

Setting

Item	Explanation
Name	Change the name of the distribution group. You can enter up to 16 letters or numbers.
Display	Use to set the order when displayed in a list.

Continued on next page

Changing the name of the distribution group

- 6** Touch [Register].
- The "Edit distribution group settings" dialogue closes.
 - To cancel the settings, touch [Cancel].

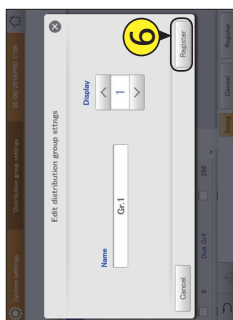

- 7** Put a check mark in the "Valid" column.
- Put a check mark in the distribution group to use in distribution calculations.



Changing the name of the distribution group

- 8** Touch [Register].
- To cancel the settings, touch [Cancel].



The "Distribution group settings" screen

- A: Put a check mark in the group to be edited.
- B: Put a check mark here if distribution group is to be used.
- C: The indoor units belonging to the selected distribution group are displayed.
- D: The "Edit distribution group settings" dialogue is displayed when you touch this.

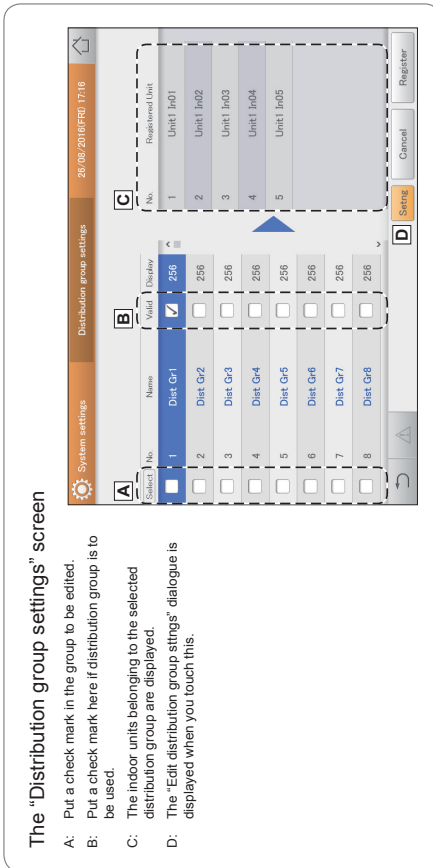

Note

- Do not put both "PAC" and "GHP" in a single distribution group with time distribution. Put each of them in separate groups.

Basic settings for the pulse meter

Make allocations between pulse meters and distribution groups.

- 1 Touch [System Settings] in "Settings".

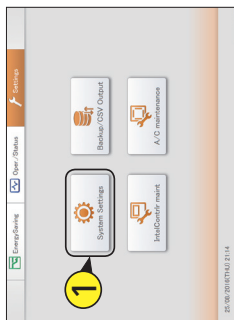

- 4 Touch [Setng].

- The "Edit pulse meter stigs" dialogue is displayed.



- 2 Touch [Pulse meter settings].

- The "Pulse meter settings" screen is displayed.



- 5 Change the settings.

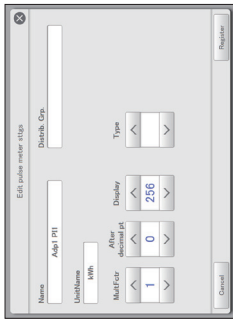

- 3 Put a check mark in the "Select" column.

- Select the pulse meter to be edited.

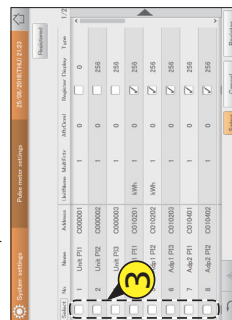

Basic settings for the pulse meter

- 7 Put a check mark in the "Register" column.

- Put a check mark next to the pulse meters you want to enable.



- 8 Touch [Register].

- To cancel the settings, touch [Cancel].

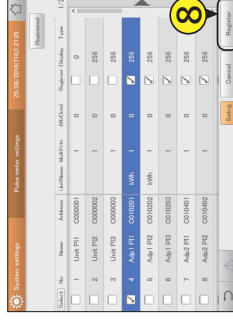

The "Pulse meter settings" screen

- A: A list of pulse meters with a check mark in the "Register" column is displayed.
- B: Put a check mark next to the pulse meters you want to edit.
- C: Put a check mark next to the pulse meters you want to enable.
- D: The "Edit pulse meter stigs" dialogue is displayed when you touch this.

Configuring the system

Setting

Make allocations between pulse meters and distribution groups.

- 1 Touch [System Settings] in "Settings".

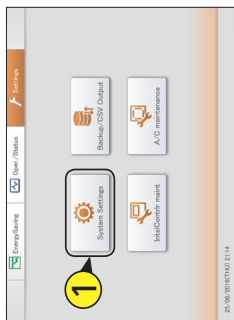

- 4 Touch [Setng].

- The "Edit pulse meter stigs" dialogue is displayed.



- 2 Touch [Pulse meter settings].

- The "Pulse meter settings" screen is displayed.



- 5 Change the settings.

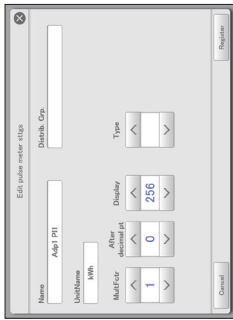

- 3 Put a check mark in the "Select" column.

- Select the pulse meter to be edited.

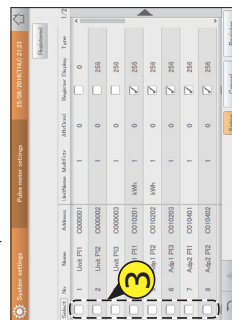

Item	Explanation
Name	Change the pulse meter name. You can enter up to 16 letters or numbers.
UnitName	Enter the units to be displayed for the pulse meter.
MultiFctr	Use [▲] [▼] to set the multiplying factor to be displayed for the pulse meter.
After decimal pt	Use [▲] [▼] to set the number of decimal places to be displayed for the pulse meter. (0 to 3)
Display	Use [▲] [▼] to set the order when displayed in a list.
Type	Use [▲] [▼] to set the pulse meter type. Select from "Elec", "Gas", "PWGr", "TOWr", and "Iea".

Continued on next page

Set the distribution mode

Set the mode used for distributing when calculating charges. There are two methods for distribution.
Time distribution: This method calculates distribution ratios based on the operating times of the indoor units (thermostat ON cumulative time and thermostat OFF cumulative time).
Load distribution: This method calculates distribution ratios based on the electricity/gas usage (including standby power) of the indoor units and outdoor units.

- 1 Touch [System Settings] in "Settings".
 - The "System settings" screen is displayed.

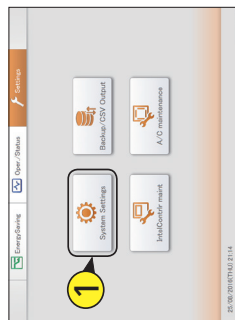

- 2 Touch [Distribution mode settings].
 - The "Distribution mode settings" screen is displayed.



- 3 Change the settings.



- 4 Touch [Register].
 - To cancel the settings, touch [Cancel].

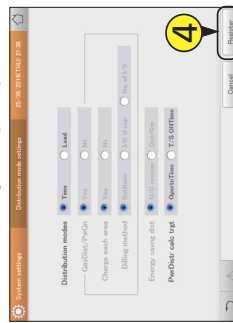

Set the units for electricity/gas charges

Set the units for electricity and gas charges.

- 1 Touch [System Settings] in "Settings".
 - The "System settings" screen is displayed.

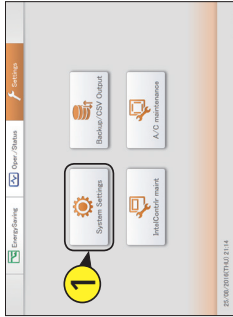

- 2 Touch [Distribution Ratio settings].
 - The "Distribution Ratio settings" screen is displayed.



- 4

- 4 Touch [Register].
 - To cancel the settings, touch [Cancel].

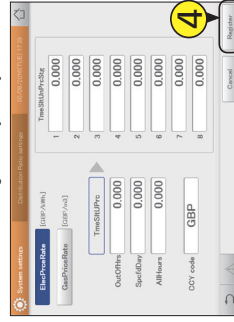

- 3 Change the settings.
 - The touchscreen numeric keypad appears when you touch the text box.

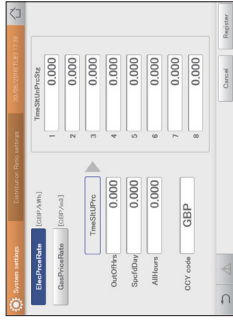

Item	Explanation
ElectricRate GasPriceRate	The screen switches to the one for setting the prices for electricity or gas charges. The highlighted item after touching is the one that will be set.
TimeSIUPrc	Set the regular hour range 1 to 8 price. • The time slot for the regular hour range is the one set in "Regular hour range settings" in "Calendar stgs for dist. calc." (p. 150).
OutOfHrs SpodDay	Set the out of hours price. Set the specified days price. • The specified day is the one set in "Specify day Calendar" in "Calendar stgs for dist. calc." (P.149).
AllHours	Set prices for times that are not covered by regular hour ranges, out of hours, or specified days.
CCY code	Enter the currency unit.

Configuring the system

Setting

Item	Explanation
Distribution modes	Set the distribution mode (time distribution or load distribution).
GasDistPwGn	Select whether to calculate distributions when using gas for power generation. • When set to "No", you cannot set charge each area and billing method.
Charge each area	Select whether to use charge each area for gas power generation. • When set to "No", you cannot set billing method.
Billing method	Set the billing method for gas power generation.
Energy saving dist	Set the range of energy savings effects for multi-timers and conditions for distribution, (when load distribution only) • With "CID system", only the air conditioning distribution of the area of the outdoor system is reflected. • With "DistGap", the air conditioning distribution of all areas in the entire distribution group is reflected.
PwrDistr calc trig	Set the target of electricity distribution calculation. • "OpenTime" is distributed between the electricity for both outdoor units and indoor units. • "T/S ONTime" is distributed to the electricity for only outdoor units.

- 4

- 4 Touch [Register].
 - To cancel the settings, touch [Cancel].

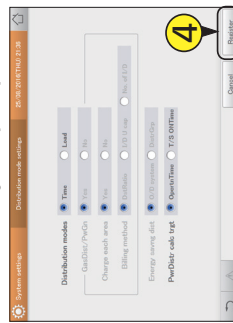

Linked control of air conditioning units

By setting conditions for input points and output points, you can perform linked control of air conditioning units (indoor units and outdoor units). For example, you can make a setting so that all indoor units stop operating at the same time (output point) in response to a fire alarm going off (input point).

1 Touch [System Settings] in "Settings".

- The "System settings" screen is displayed.

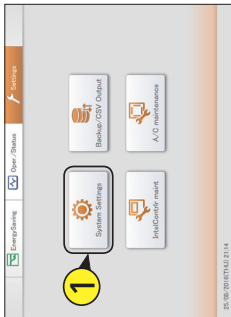

2 Touch [Event control].

- The "Event control" screen is displayed.



3 Select an event name.

- Use \leftarrow to select the name to register the event.
- You can change the event names. (\rightarrow Changing an event name (P.167))

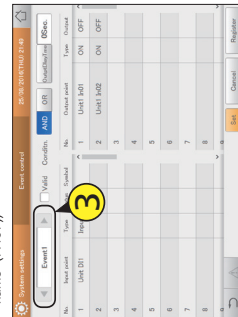

4 Select the input point border (4-1) and touch [Set] (4-2).

- The "Input point settings" dialogue is displayed.

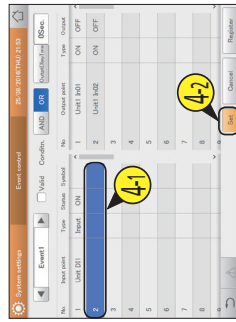

5 Select the input target from the list.

- Input targets include air conditioner alarms, digital input/output devices, indoor units (individual and control groups).

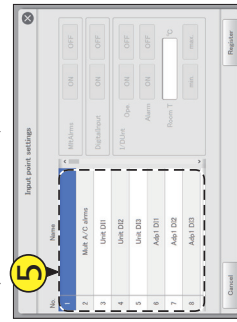

Continued on next page

Linked control of air conditioning units

7

Touch [Register].

- The "Input point settings" dialogue closes.
- To cancel the settings, touch [Cancel].

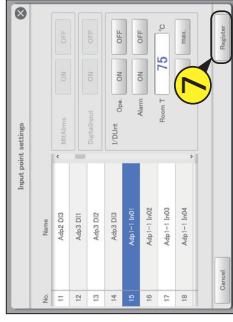

8 Select the output point border (8-1) and touch [Set] (8-2).

- The "Output point settings" dialogue is displayed.

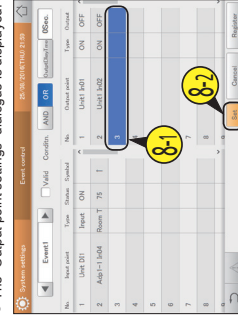

9

Select the output target from the list.

- Output targets include digital input/output devices, indoor units (all at once, individual, and control groups).

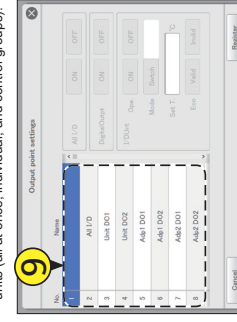

Continued on next page

6

Setting the input conditions.

- The items you can set depend on the input target selected.

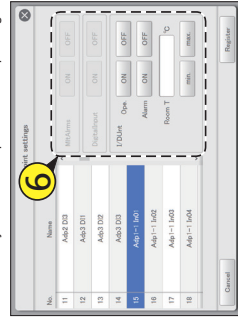

- When air conditioning unit alarm batch is selected

Item	Explanation
MilAlarms	Select either "ON" or "OFF". • "ON" indicates that an error alarm has been transmitted. • "OFF" indicates that a unit has recovered from an error.

- When a digital input/output device is selected

Digitalinput	Select either "ON" or "OFF". • "ON" is displayed when digital input signals are on. • "OFF" is displayed when digital input signals are off.
--------------	--

- When an indoor unit has been selected

INDUIT* Ops	Select either "ON" or "OFF". • "ON" is displayed when in operation of the indoor unit has been started. • "OFF" is displayed when operation of the indoor units is stopped.
Alarm	Select either "ON" or "OFF". • "ON" indicates that an error alarm has been transmitted. • "OFF" indicates that a unit has recovered from an error.
Room T	Set the room temperature. The touchscreen number-keypad appears when you touch the text "min." or "max.". • "min." indicates when the temperature is above the set temperature. • "max." indicates when the temperature is below the set temperature.

* Set one of the condition items on the right.

Continued on next page

Linked control of air conditioning units

10 Setting the output conditions.

- The items you can set depend on the output target selected.

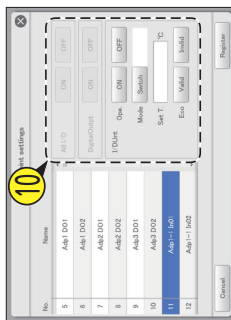

11 Touch [Register].

- The "Output point settings" dialogue closes.
- To cancel the settings, touch [Cancel].



- When indoor units all at once is selected

Item	Explanation
All I/O	Select either "ON" or "OFF". <ul style="list-style-type: none"> "ON" indicates that all indoor units start operation. "OFF" indicates that all indoor units stop operation.

- When a digital input/output device is selected

DigitalOutput	Select either "ON" or "OFF". <ul style="list-style-type: none"> "ON" indicates that the digital output signal is on. "OFF" indicates that the digital output signal is off.
---------------	--

- When an indoor unit has been selected

I/OUnit	Ope. Select either "ON" or "OFF": <ul style="list-style-type: none"> "ON" indicates that the indoor unit starts operation. "OFF" indicates that indoor unit stops operation.
Mode	Select the operation mode to switch to. (→ Setting the operation mode (P.167))
Set T.	Set the temperature.
Eco	Select either "Valid" or "Invalid".

- Set one of the items on the right as the output.

Linked control of air conditioning units

14 Put a check mark next to "Valid".

- The set event control works if you put a check mark here.

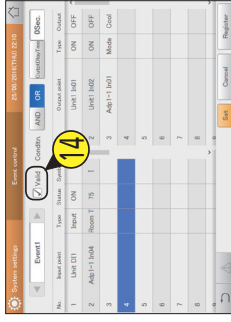

13 Set the output delay time.

(1) Touch [OutputDelayTime].

- The "OutputDelayTime" settings dialogue is displayed.

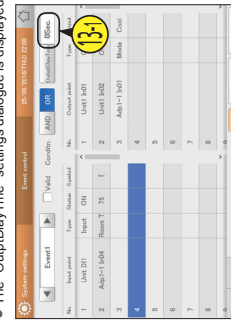

(2) Select the output delay time.

- Set the initiating time for the output point when the input point conditions have been met.

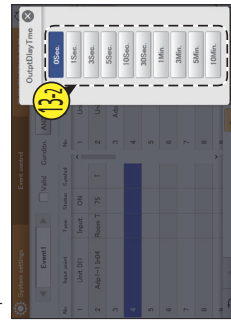

15 Touch [Register].

- To cancel the settings, touch [Cancel].

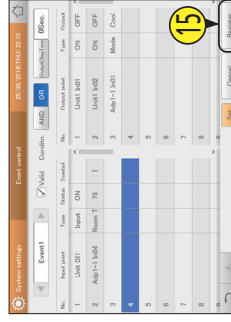

Note

- You can register a maximum of 50 event controls.
- You can register a maximum of 32 conditions each for input points and output points for each individual event.

Configuring the system

Setting

Configuring the system

Setting

Continued on next page

Deleting the settings for input/output points

- 1 Select the input/output point to delete (1-1) and touch [Set] (1-2).

- The settings dialogue is displayed.

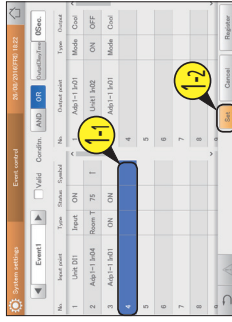

- 2 Touch the highlighted input/output target.

- The setting is deleted.

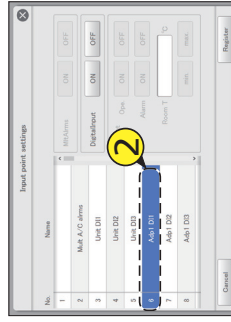

- 3 Touch [Register].

- The setting dialogue closes, and the selected input/output point is deleted from the list.

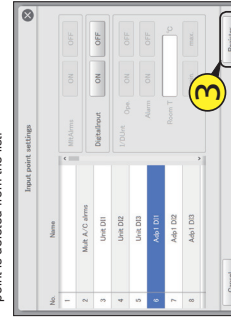

Changing an event name

- 1 Touch the text box.

- The touchscreen keyboard is displayed.



- 2 Enter the text.

Setting the operation mode

- 1 Touch [Switch] in the "Output point settings" dialogue.

- The "OperationMode" dialogue is displayed.

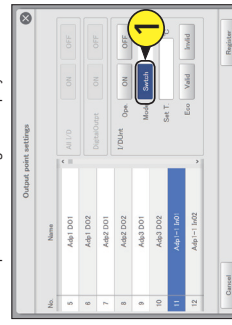

- 2 Select the mode to switch.

- The settings are registered and the "OperationMode" dialogue closes.



Configuring the system

Setting

The "Event control" screen

A: Set the event name with . You can change the event names. (→ "Changing an event name" (p.167))

B: The settings for the selected event name are enabled if you put a check mark here.

C: Select the conditions.

AND	The event at the output point is executed when the conditions set for the input point are all met.
OR	The event at the output point is executed when at least one of the conditions set for the input point are met.

D: Set the output point event execution timing (time).

The "OutputPlayTime" setting dialogue is displayed when you touch this. Setting values are "0Sec.", "1Sec.", "3Sec.", "5Sec.", "10Sec.", "30Sec.", "1Min.", "3Min.", "5Min.", and "10Min."

E: The list of input points that are set is displayed.

Input point	This displays the input targets for which conditions are set.
Type	The input target type is displayed.
Status	The input target status is displayed.
Symbol	A symbol is displayed when temperature is set as a condition for indoor units. The symbols displayed are as follows: : When the temperature is set to "min." : When the temperature is set to "max."

F: The list of output points that are set is displayed.

Output point	This displays the output targets for which conditions are set.
Type	The output target type is displayed.
Output	The output target status is displayed.

G: When an input point border or output point border is selected and you touch it, the dialogue for setting each of them is displayed.

Configuring outgoing mail

When an alarm occurs, this unit can automatically send alarm mails. Set the outgoing mail server and the mail destination.

- 1 Touch [System Settings] in "Settings".
 - The "System settings" screen is displayed.

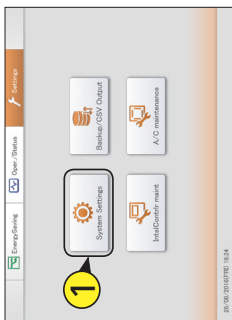

- 2 Touch [Email settings].
 - The "Email settings" screen is displayed.



Setting the destination

Set the destination in the "Email Alarm recipient settings" dialogue.

- 1 Change the settings.



Item	Explanation
Mail address	Set the mail address to send alarms emails. The touchscreen keyboard appears when you touch this and you can change the mail address.
Valid	Users with a check mark in this column will be sent alarm mails.
Adapter CommuErr	Users with a check mark in this column will be sent alarm mails when there is a communications error with the communication adaptor.
I/D unit/Disc.	Users with a check mark in this column will be sent alarm mails when there is a disconnected alarm with an indoor unit.
Send last mail	A test mail is sent to the set mail address. "Test" mails are not sent if there is a check mark in "Valid", "Adapter CommuErr", or "I/D unit/Disc.", however.

- 2 Touch [Register].
 - To cancel the settings, touch [Cancel].

Configuring the system

Setting

- 3 Change the settings.

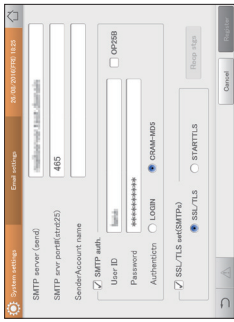

Item	Explanation
SMTP server (send)	Set the IP address or host name of the SMTP server.
SMTP server port(strd25)	Set the port number (0 to 65535) for the SMTP server. (Factory setting: 25)
Sender/Account name	Set the mail address to be put in the sender section of the outgoing mail.
SMTP auth.*	User ID SMTP authentication..
OP25B	The SMTP server port setting is automatically set to "30" if you put a check mark here.
Password	Set the password to use for SMTP authentication.
Authentic	Select either "LOGIN" or "CRAM-MD5" as the authentication method.
SSL/TLS	Select either "SSL/TLS" or "STARTTLS" as the encryption method.
Recp stigs	The "Email Alarm recipient settings" dialogue is displayed when you touch this. (→ "Setting the destination" (P.169))

*1 The settings at the left are enabled if you put a check mark here.
 *2 The SMTP server port setting is automatically set to "465" if you put a check mark here.

- Note**
- The SMTP server port number automatically changes if "OP25B" and "SSL/TLS set(SMTPs)" are set. The priority of setting is "OP25B">"SSL/TLS set(SMTPs)".
 - The SMTP server port number cannot be changed if you make the above settings. When the settings are cancelled, the SMTP port number returns to the factory setting (25), and you can enter any value again.

Registering a communication adaptor

Register communication adaptors connected to this unit to enable communications with the air conditioning units.

1 Touch [System Settings] in "Settings".

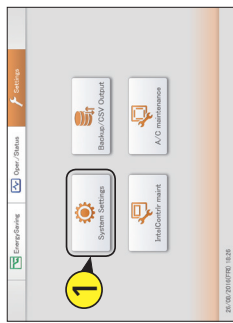

4 Touch [Setting].

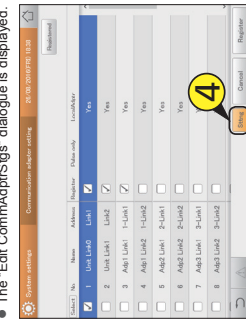

The "Edit CommAdptrStgs" dialogue is displayed.

2 Touch [Communication adaptor setting].

The "Communication adaptor setting" screen is displayed.

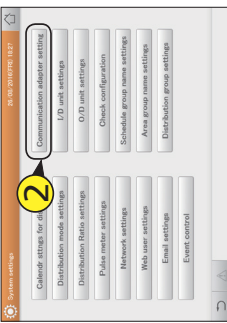

5 Change the settings.

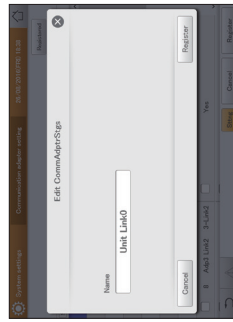

Item	Explanation
Name	Change the name of the communication adaptor. You can enter up to 10 letters or numbers.

3 Put a check mark in the "Select" column.

Select the communication adaptor to be edited.



6 Touch [Register].

The "Edit CommAdptrStgs" dialogue closes.

To cancel the settings, touch [Cancel].

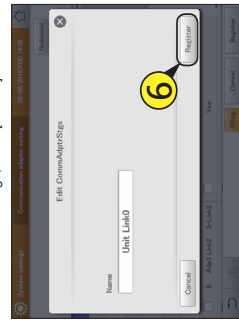

Continued on next page

Registering a communication adaptor

7 Repeat steps 3 to 6 to edit other communication adaptors.

8 Put a check mark in the "Register" column.

Put a check mark next to the communication adaptors you want to enable.



9 Touch [Register].

To cancel the settings, touch [Cancel].



Configuring the system

Setting

The "Communication adaptor setting" screen

- A:** A list of communication adaptors with a check mark in the "Register" column is displayed when you touch this. Touch again to return to the previous display.
- B:** Put a check mark next to the communication adaptor you want to edit.
- C:** Put a check mark next to the communication adaptors you want to enable.
- D:** The "Edit CommAdptrStgs" dialogue is displayed when you touch this.

Note

- In the "Address" column, "Link1" and "Link2" are in this unit, and addresses such as "1-Link1" and "1-Link2" are the addresses of added communication adaptors.



Configuring the system

Setting

Setting the screen display and volume for this unit

You can adjust the brightness of the screen or adjust the buzzer sound.

- 1 Touch [IntelContr maint] in "Settings".
 - The "IntelContr maint" screen is displayed.

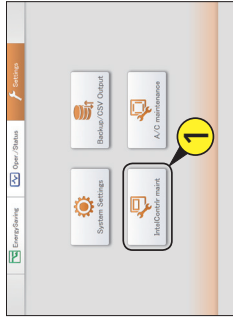

- 3 Change the settings.



- 2 Touch [Display/Volume settings].
 - The "Display/Volume settings" screen is displayed.

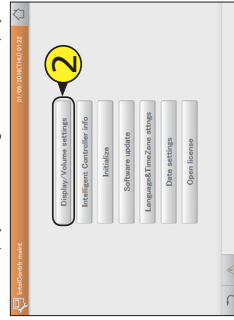

Item	Explanation
Brightness	Adjust the brightness of the back light in 5 steps (1 to 5).
Off time	The back light automatically turns off after the specified time, if the unit is not operated. The back light does not turn off if you touch [Invalid]. - The actual time can differ by about a minute.
Cleaning/Idle	All operations are disabled on the liquid crystal display when you touch this [Start] so that you can clean it. This is cancelled when you touch [END].
Auto logout time	Log out automatically after the specified time. ("30 m.", "1 hour", or "12 hrs")
Buzzer vol.	You can adjust the volume of the buzzer. No sound is output if you touch [Quiet].

- 4 Touch [Register].
 - To cancel the settings, touch [Cancel].



Maintenance settings

Setting

Maintenance settings

This chapter explains how to set the date and time, and other adjustments such as the volume and the brightness of the screen.



Screen menu	Overview	Page
Display/Volume settings	Adjust the brightness of the unit's screen and the sound of the buzzer.	173
Intelligent Controller info	Register the contacts for servicing (telephone numbers) for this unit.	174
Software update	Update the software for this unit.	175
Initialize	Initialise the settings for this unit.	176
Language& TimeZone strings	The user not initialise under any circumstances.	179
Date settings	Set the language to be used when setting and operating this unit. Manually set the date and time.	176



Screen menu	Overview	Page
Test run	Perform a test operation of the indoor unit after installing this unit.	181
A/C communication settings	Make settings such as the communications protocol between this unit and the air conditioning units.	184
Maintenance information	Register the units that will require maintenance.	186

Register the contacts for servicing for this unit

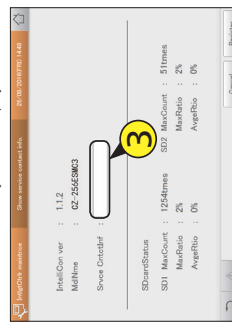
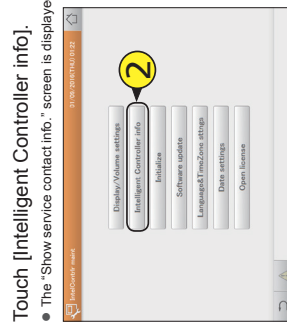
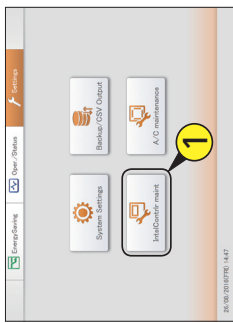

Register the contacts for servicing (telephone numbers) for this unit.

- 1 Touch [IntelContrr maint] in "Settings".
 - The "IntelContrr maint" screen is displayed.
- 2 Touch [Show service contact info.].
 - The "Show service contact info." screen is displayed.
- 3 Touch the text box.
 - The touchscreen keyboard is displayed.
- 4 Enter the telephone number.
- 5 Touch [Register].
 - To cancel the settings, touch [Cancel].

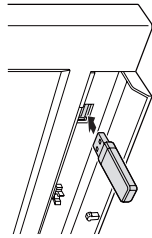

Update the software

Update the software for this unit from a USB memory device. A service person should perform this operation.

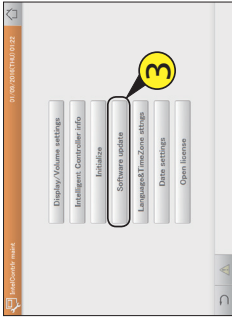
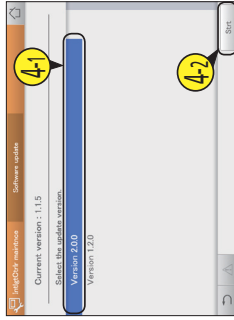
- 1 Open the storage door and connect a USB memory device to the USB terminal.
 
- 2 Touch [IntelContrr maint] in "Settings".
 
- 3 Touch [Software update].
 - The "Software update" screen is displayed.
- 4 Select the version to update (4-1) and touch [Strt] (4-2).
 - The software update confirmation message is displayed.
- 5 Touch [Strt].
 - A confirmation message appears again.
 - To cancel the update, touch [Cancel].
- 6 Touch [Update].
 - The update starts. The progress of the update is shown as a percentage.
 - The unit automatically restarts when updating is complete.

Maintenance settings

Setting

Maintenance settings

Setting

Initialising the unit and setting log levels

Initialise the unit and set and admin number (password) and log output levels.

- 1 **All data is deleted when you initialise.**
Unless you are the administrator, do not initialise under any circumstances.
- 1 Touch [IntelContr maint] in "Settings".
The "IntelContr maint" screen is displayed.

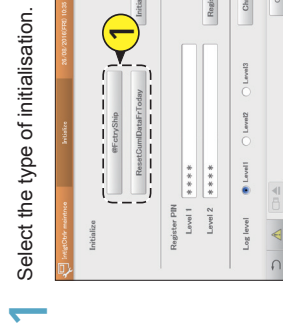
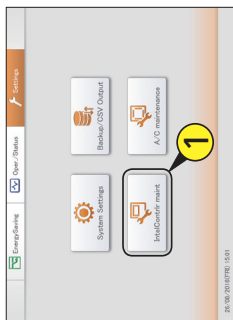

- 1 Select the type of initialisation.

- 2 Touch [Initialize].

- The "Initialize" screen is displayed.

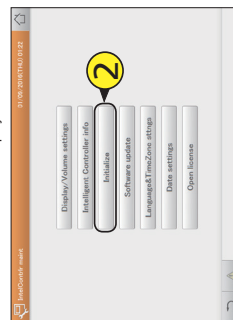

- 2 Touch [Initialize].

- Several confirmation messages will be displayed, so touch [Yes] each time.
- Initialisation starts.
- When initialising is complete, the message "Settings were reset. IntelContr is restarting..." is displayed.



Initialising the unit and setting log levels

Setting admin numbers

Some menus require you to enter an admin number (password) to perform settings and operations. There are two levels of admin number (level 1 and level 2).

- 1 Enter an identification number for each level.

- The touchscreen keyboard appears when you touch the text box.
- Use an identification number of at least 8 numbers (alphanumeric only).

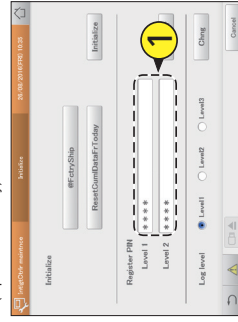

- 2 Touch [Register].

- The setting is registered.

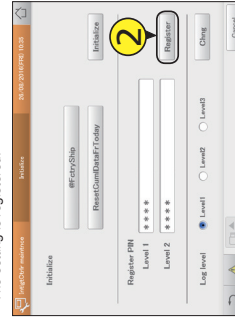

Set the log output level

Set a level for outputting the log data recorded in this unit. The content of the log data output differs according to the log level that is set.

- 1 Select the log level.

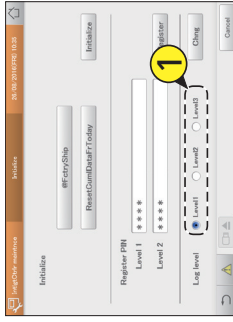

- 2 Touch [Chng].

- The setting is registered.

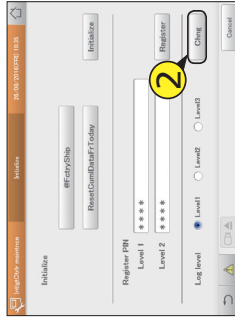

Maintenance settings

Setting

Maintenance settings

Setting

Setting the date and time

Manually set the date and time. This setting is not necessary if you are using the NTP server (P-123).

- 1 Touch [IntelContrr maint] in "Settings".

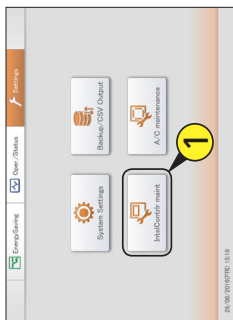

- 3 Setting the date and time.



Item	Explanation
Day	Set the date.
Month	Use [▲] [▼] to set "Day", "Month", and "Year".
Year	
Hours	Set the time.
Minutes	Use [▲] [▼] to set "Hours", "Minutes", and "Seconds".
Seconds	

- 2 Touch [Date settings].

The "Date setting" screen is displayed.

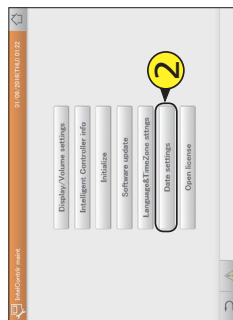

- 4 Touch [Register].

To cancel the settings, touch [Cancel].



Setting the language and time zone

Set the language to be used when setting and operating this unit. The languages available on this unit are English (US), English (UK), German, Italian, French, Spanish, and Portuguese. Set the time zone to suit the language to be used.

- 1 Touch [IntelContrr maint] in "Settings".

The "IntelContrr maint" screen is displayed.

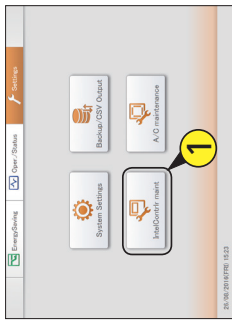

- 4 Select the language to display.

- You can set [English (US)], [English (UK)], [German], [Italian], [French], [Spanish], and [Portuguese].
- The settings are registered and the "SictLang" dialogue closes.

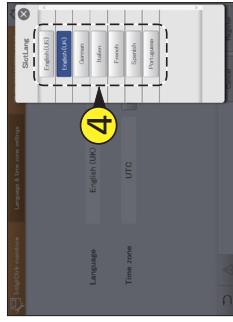

- 2 Touch [Language & TimeZone stngs].

The "Language & time zone settings" screen is displayed.

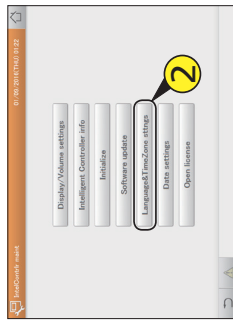

- 5 Touch [Select time zone].

The "Select time zone" dialogue is displayed.

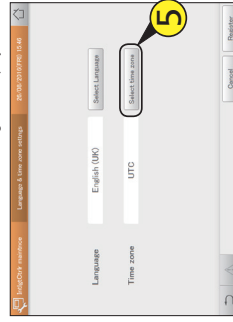

- 3 Touch [Select Language].

The "SictLang" dialogue is displayed.

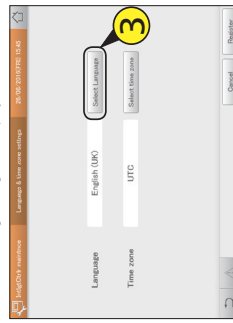

Continued on next page

Running a test operation

You can run test operations for indoor units for each outdoor unit system address.

- 6** Select the time zone to display.
- You can select [UTC-12] to [UTC+1], [UTC], and [UTC+1] to [UTC+14]. Find the difference between the time in the installation location of the intelligent controller and Coordinated Universal Time (UTC). If the former is 1 hour ahead of the latter, for example, select [UTC+1].
 - The settings are registered and the "Select time zone" dialogue closes.

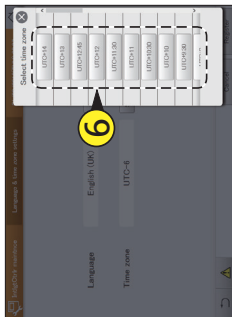

- 7** Touch [Register].
- The settings are registered and the unit automatically restarts.
 - To cancel the settings, touch [Cancel].

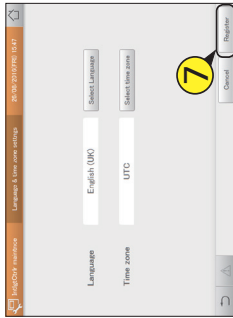

Setting the language and time zone

- 1** Touch [A/C maintenance] in "Settings".
- The "A/C maintenance" screen is displayed.

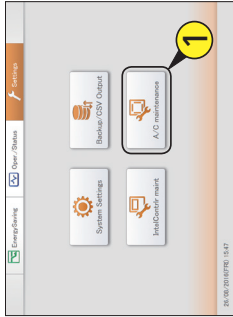

- (2)** Select the line number.
- The settings are registered and the "Line No." dialogue closes.

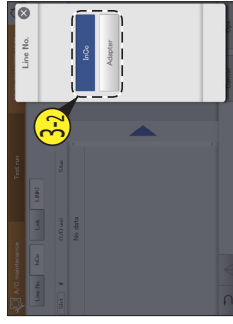

- 2** Touch [Test run].
- The "Test run" screen is displayed.

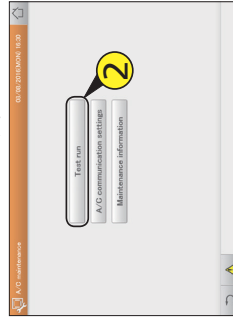

- 4** Select the link.

- (1)** Touch [Link].
- The "Link" dialogue is displayed.



- 3** Select the line number.

- (1)** Touch [Line No.].
- The "Line No." dialogue is displayed.



- (2)** Select the linked system you want to run the test operation for.

- The settings are registered and the "Link" dialogue closes.
- The outdoor units in the selected linked system are displayed in a list.

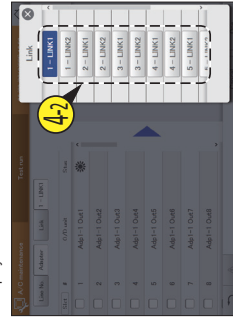

Maintenance settings

Setting

Continued on next page

Running a test operation

The "Test run" screen

A: Select the line numbers of the outdoor units you want to run a test operation for. The "Line No." dialogue is displayed when you touch this.

B: Set the link system of the outdoor units you want to run a test operation for. The "Link" dialogue is displayed when you touch this.

C: Outdoor units are displayed in a list.

Item	Explanation
Slot	Select the outdoor units you want to run a test operation for.
O/D unit	The outdoor units in the linked system selected at B are displayed.
Stus	The operation mode while testing operation is displayed.

D: The indoor units that are connected to outdoor units with a check mark in C are displayed.

E: Test operation is performed. The operation dialogue is displayed when you touch this.

Maintenance settings

Setting

Running a test operation

5 Put a check mark in the "Select" column.

- Select the outdoor units you want to run a test operation for.
- You can select multiple outdoor units.

8 Check the "Stus" column.

- During the test operation, the operation mode is shown in the "Stus" column (Cooling and Heating).

9 To stop the test operation, touch [Oprm], then touch [OFF] in the operation dialogue.

Maintenance settings

Setting

6

Touch [Oprm].

- The operation dialogue is displayed.



7

Select the operation mode ([Cool] or [Heat]) (7-1) and touch [ON] (7-2).

- The settings are registered and the operation dialogue closes.
- The test operation starts.

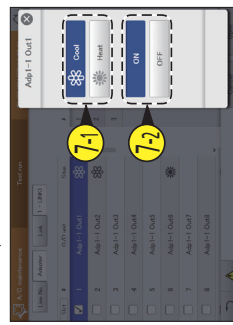

Setting communications with air conditioning units

Make settings such as the communications protocol between this unit and the air conditioning units. There are three stages to these settings.

1 Touch [A/C maintenance] in "Settings".

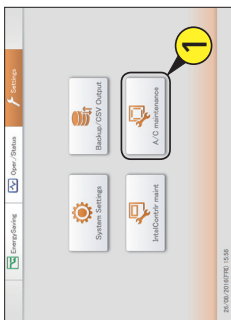

2 Touch [A/C communication settings].

- The "Settings for communication w A/C(1)" screen is displayed.

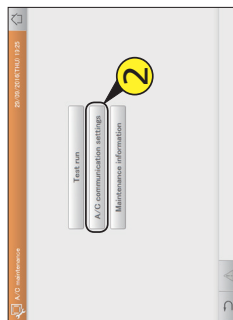

3 Change the settings.

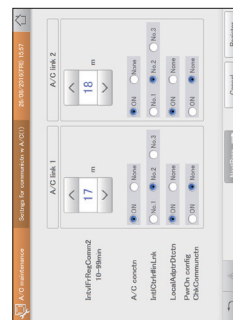

Item InVIFRegComm2	Explanation Set the communications interval between this unit and the air conditioning units (10 to 99). Use \uparrow \downarrow to set a value for each linked system.
A/C condtn	Set whether air conditioning units are connected for each linked system.

Item Chattering cancel time (msec)	Explanation Set the time until canceling when chattering occurs.
--	--

6 Touch [NextPage →].

- The "Settings for communication w A/C(3)" screen is displayed.
- To return to the "Settings for communication w A/C(1)" screen, touch [← PrevPage].
- If you touch [Cancel], all the settings up to that point are cancelled and you return to the "Settings for communication w A/C(1)" screen.

7 Change the settings.

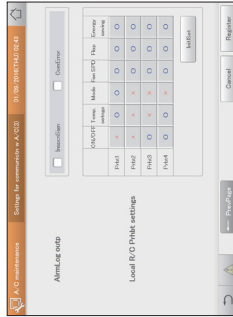

Item AimLog outp	Explanation Select whether to output alarm logs. Alarm mails are not sent if the check mark is removed. You can select only the following checks and alarms. Others are executed irrespective of the setting. <ul style="list-style-type: none"> InpActSign: Expire oil check Remote controller display check ComError: C17 alarm (communication error between the unit and the air conditioning unit) C06 alarm (communication error between the unit and the communication adaptor)
Local R/C Pribbi settings	Set "Pbnt" to "Pribbi" for each item ("ON/OFF", "Temp. saving", "Mode", "Fan SPD", "Flag", or "Energy saving") to set whether to permit or prohibit operations and settings with the local remote controller. Each time you touch either "O" or "X" is displayed. <ul style="list-style-type: none"> "O": Operation and setting with the local remote controller is enabled "X": Operation and setting with the local remote controller is prohibited Touch [InitSet] to restore the default factory settings.

Setting communications with air conditioning units

Make settings such as the communications protocol between this unit and the air conditioning units. There are three stages to these settings.

1 Touch [A/C maintenance] in "Settings".

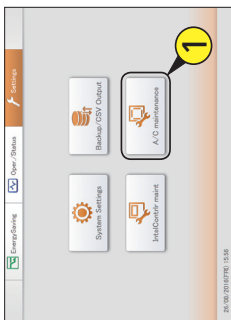

2 Touch [A/C communication settings].

- The "Settings for communication w A/C(1)" screen is displayed.

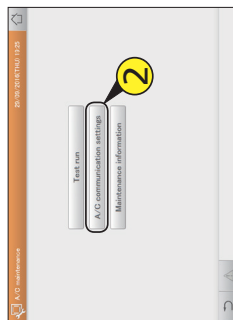

3 Change the settings.

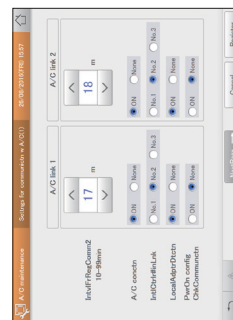

Item InVIFRegComm2	Explanation Set the communications interval between this unit and the air conditioning units (10 to 99). Use \uparrow \downarrow to set a value for each linked system.
A/C condtn	Set whether air conditioning units are connected for each linked system.

Maintenance settings

Setting

Item Chattering cancel time (msec)	Explanation Set the time until canceling when chattering occurs.
--	--

6 Touch [NextPage →].

- The "Settings for communication w A/C(3)" screen is displayed.
- To return to the "Settings for communication w A/C(1)" screen, touch [← PrevPage].
- If you touch [Cancel], all the settings up to that point are cancelled and you return to the "Settings for communication w A/C(1)" screen.

7 Change the settings.

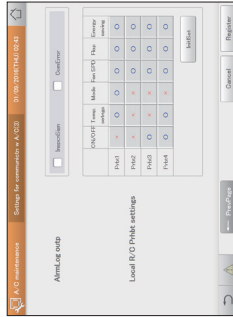

Item AimLog outp	Explanation Select whether to output alarm logs. Alarm mails are not sent if the check mark is removed. You can select only the following checks and alarms. Others are executed irrespective of the setting. <ul style="list-style-type: none"> InpActSign: Expire oil check Remote controller display check ComError: C17 alarm (communication error between the unit and the air conditioning unit) C06 alarm (communication error between the unit and the communication adaptor)
Local R/C Pribbi settings	Set "Pbnt" to "Pribbi" for each item ("ON/OFF", "Temp. saving", "Mode", "Fan SPD", "Flag", or "Energy saving") to set whether to permit or prohibit operations and settings with the local remote controller. Each time you touch either "O" or "X" is displayed. <ul style="list-style-type: none"> "O": Operation and setting with the local remote controller is enabled "X": Operation and setting with the local remote controller is prohibited Touch [InitSet] to restore the default factory settings.

Ignoring alarms from the units

Register the units that will require maintenance. By registering them, this unit will ignore the alarms, etc., transmitted by the units.

- 1 Touch [A/C maintenance] in "Settings".
 - The "A/C maintenance" screen is displayed.

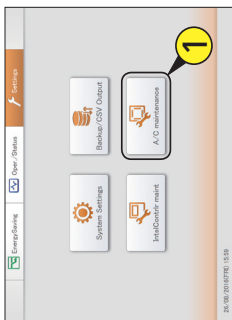

- 3 Put a check mark in the "Register" column of the target unit.



- 2 Touch [Maintenance information].
 - The "Register maintenance information" screen is displayed.

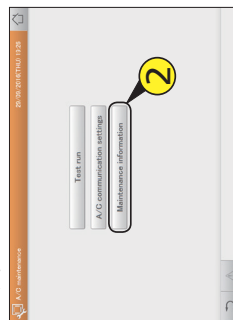

- 4 Touch [Register].
 - To cancel the settings, touch [Cancel].



Appendix

This chapter provides information you will require to use the unit (input of numbers and letters, terminology, etc.) and maintenance information.

Maintenance settings

Setting

Number and letter input

This section explains the keyboard that is displayed on the screen when entering numbers and text. A touchscreen numeric keypad is displayed for number input and a touchscreen keyboard is displayed for text input.

Number input

Use the touchscreen numeric keypad that is displayed on the screen when entering numbers such as times and temperatures. A touchscreen numeric keypad such as the following appears on the screen when you touch the text box.

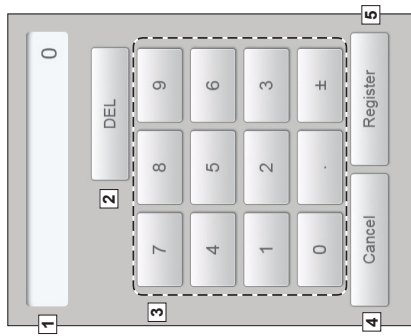

Name	Explanation
1 Input field	The number you touch appears.
2 [DEL] key	This deletes all of the numbers displayed in the input field.
3 Numbered keys (0 to 9)	Touch the number. The number you touch is displayed in the input field and are added to the right. Each time you touch the [0] key, a "0" (minus sign) is displayed or cleared.
4 [Cancel] key	The touchscreen numeric keypad closes when you touch this.
5 [Register] key	The numbers displayed in the input field are displayed as the setting values in the text box.

Character input

Use the touchscreen keyboard that is displayed on the screen when entering text such as when changing names and passwords. A touchscreen keyboard such as the following appears on the screen when you touch the text box.

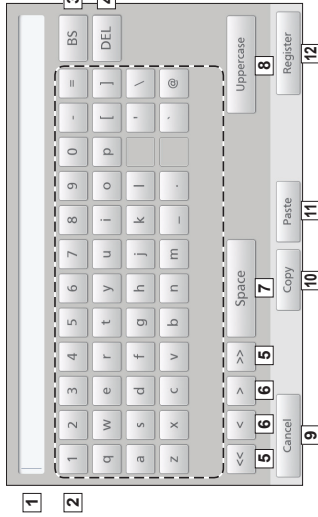

Name	Explanation
1 Input field	The letter you touch appears.
2 Letter keys	Touch the letter. The letter you touch is displayed in the input field and is added to the right.
3 [BS] key	Each time you touch it, the characters displayed are deleted one at a time from the left of the cursor.
4 [DEL] key	Each time you touch it, the characters displayed are deleted one at a time from the right of the cursor.
5 [← →] keys	Touch [←] to move the cursor to the beginning of the text. Touch [→] to move the cursor to the end of the text.
6 [↵] (move cursor) keys	Each time you touch one of these, the cursor in the input field moves one character left or right.
7 [Space] key	Each time to touch this key, 1 space is added to the input field.
8 [Uppercase] key	The keyboard layout is changed to capitals.
9 [Cancel] key	The touchscreen keyboard closes when you touch this.
10 [Copy] key	Copy the text in the input field you selected by dragging.
11 [Paste] key	Paste the text you copied with the [Copy] key in the cursor position in the input field.
12 [Register] key	The text displayed in the input field is displayed as the setting text in the text box.

Connections with external signals

You can measure the gas and electricity consumed by the unit and control all of the units by input or outputting signals to and from external equipments.
Refer to the installation instructions for details about the electronics for external signals.

Pulse meter input

You can measure the gas and electricity consumed by connecting a pulse meter (gas and/or fuel flow meter, electricity meter).

Operation

A count is made for each pulse.
You will need to set the consumption units (m³, kWh, or litres) per pulse in "Pulse meter settings" (P.158).

Batch stop input

You can automatically stop all connected units with an external signal (a fire alarm, for example). (Excluding those indoor units set to be excluded from the operation.)

Operation

When input is ON, the stop signal is sent to all indoor units.

Note

- If batch stop input and batch startup input are ON simultaneously, on the batch stop input is valid.

Batch startup input

You can automatically startup all units with an external signal. (Excluding those indoor units set to be excluded from the operation.)

Operation

When the input signal switches from OFF to ON, the startup signal is sent to all indoor units.

Batch alarm output

When an alarm or error occurs on any of the connected units, this unit sends a signal externally. This signal can be used by an alarm monitor or similar device.

Operation

When an alarm or error occurs on any of the connected units, the intelligent controller signal to the external device is shorted. When the system is restored, the intelligent controller signal is opened.

Batch startup output

When any of the connected units are running, this unit sends a signal externally.

Operation

When any of the connected units (including interface adaptors) are running, the intelligent controller signal to the external device is shorted. When all connected units are stopped, the intelligent controller signal is opened. (Including when alarms or errors are occurring)

Methodology for calculating distributions

This unit is able to make simplified calculations of air conditioning distribution and energy (electricity and gas) usage with the cumulative operating time (thermostat ON/thermostat OFF) of indoor units and the performance values of indoor units.

Calculations for time distribution

Calculate the electricity/gas consumption index for indoor units individually or as a part of a distribution group, and calculate the electricity/gas consumption distribution ratios for indoor units individually or as a part of an area group.

Types of parameters used to calculate distributions

The following parameters are used for calculating time distributing.

Parameter	Explanation
RtHHi	The cumulative operating time of indoor unit No. i (high)
RtHi	The cumulative operating time of indoor unit No. i (mid)
RtLi	The cumulative operating time of indoor unit No. i (low)
SHHi	The cumulative thermostat on time of indoor unit No. i (high)
SHi	The cumulative thermostat on time of indoor unit No. i (mid)
SLi	The cumulative thermostat on time of indoor unit No. i (low)
PI	The performance of indoor unit No. i (a value equivalent to kW)
k	Weighting coefficient for electricity when the thermostat is ON and when it is OFF
qHHi	Weighting coefficient for fan speed when the speed is high
qHi	Weighting coefficient for fan speed when the speed is mid
qLi	Weighting coefficient for fan speed when the speed is low

* Cumulative operating time is equal to thermostat ON cumulative time PLUS thermostat OFF cumulative time
If the distribution modes (P.160) is set to "Time", do not allocate PAC and GHP to the same distribution groups.

Methodology for calculating distributions

Methodology for calculating electricity/gas consumption index for indoor unit No. i
 TEI is the electricity consumption index for indoor unit No. i. TGI is the gas consumption index for indoor unit No. i. TOI is the fuel consumption index for indoor unit No. i.

• **When the object of electricity distribution calculations is "thermostat ON time" and "thermostat OFF time" (regular time distribution)**

The electricity consumption index is calculated with "cumulative operating time" and "thermostat ON cumulative time".
 The gas consumption index and fuel consumption index are calculated with "thermostat ON cumulative time".

Electricity	TEI = (RHHkqHH+RHkqH+RLkqL) x PI
Gas	TGI = (SHHkqHH+SHkqH+SLkqL) x PI
Electricity	TEI = ((RHHkqHH+RHkqH+RLkqL) x k) + (SHHkqHH+SHkqH+SLkqL) x PI
Gas	TGI = 0

• **When the object of electricity distribution calculations is "thermostat ON time" (thermostat ON time distribution)**
 The electricity consumption index, gas consumption index and fuel consumption index are calculated with "thermostat ON cumulative time".

Electricity	TEI = (SHHkqHH+SHkqH+SLkqL) x PI
Gas	TGI = (SHHkqHH+SHkqH+SLkqL) x PI
Electricity	TEI = (SHHkqHH+SHkqH+SLkqL) x PI
Gas	TGI = 0

Methodology for calculating electricity/gas consumption index across the whole distribution

group

The electricity/gas consumption index for the distribution group as a whole is the total electricity/gas consumption index for all indoor units included in the relevant distribution group.

TOTALe is the electricity consumption index for the distribution group as a whole. **TOTALg** is the gas consumption index for the distribution group as a whole. **m** is the number of indoor units included in the relevant group.

Electricity consumption index	TOTALe = TE1 + TE2 + ... + TE _m
Gas consumption index	TOTALg = TGI + TG2 + ... + TG _m

Methodology for calculating electricity/gas consumption distribution for indoor unit No. i

REI is the electricity consumption distribution ratio. RGI is the gas consumption distribution ratio.

Distribution ratio of electricity consumed	REI (%) = TEI / TOTALe x 100
Distribution ratio of gas consumed	RGI (%) = TGI / TOTALg x 100

Methodology for calculating electricity/gas consumption distribution for area j

The electricity/gas consumption distribution ratio for the area as a whole is the total of electricity/gas consumption distribution ratio for all indoor units included in the relevant area.

NEJ is the electricity consumption distribution ratio in Area j. **NGJ** is the gas consumption distribution ratio in Area j. **n** is the number of indoor units included in the relevant area.

Distribution ratio of electricity consumed	NEJ = RE1 + RE2 + ... + RE _n
Distribution ratio of gas consumed	NGJ = RG1 + RG2 + ... + RG _n

Note

- For models whose only setting for fan speed is "High", or for models whose only settings are "High" or "Low", you cannot give weighting for each speed.
- Distribution ratios are rounded to two decimal places for display.

Methodology for calculating distributions

Calculating the air conditioning usage volume

You can calculate either the electricity/gas consumed by a distribution group as a whole or for individual indoor units.

Methodology for calculating electricity/gas usage across the whole distribution group

The formula for calculating the electricity usage or gas usage for a distribution group is as follows.

Quantity of electricity used	Pulse meter (electricity meter) count value x pulse unit quantity (kWh)
Quantity of gas used	Pulse meter (gas flow meter) count value x pulse unit quantity (m ³)

Methodology for calculating electricity/gas consumption usage for each indoor unit

The formula for calculating the electricity usage or gas usage for an individual indoor unit is as follows.

Quantity of electricity used	Electricity usage of the distribution group x the distribution ratio of electricity consumed by indoor units
Quantity of gas used	Gas usage of the distribution group x the distribution ratio of gas consumed by indoor units

For the methodology for calculating the distribution ratio of electricity/gas consumed by indoor units, refer to "Methodology for calculating electricity/gas consumption distribution for indoor unit No. i" (P.192).

Note

- Usages are rounded to two decimal places for display.

Miscellaneous

Indemnity

This company shall not compensate in the following cases.

- If the password is found out by a third party and problems result
- If a USB memory device malfunctions and backed up data (accumulated data, distribution data) is lost

Where large errors can occur in calculation

Some models (semi-centralised models, floor mounted models, etc.) and old models with electric heaters for example, may show large differences in calculations of air conditioning distribution ratios. Furthermore, if you use large pan type humidifiers that use a lot of power, the operating times of the humidifiers will not be reflected in the calculation of the distributions, leading to a large difference. Contact the place of purchase or your servicing agent for details.

Remote control-less systems

In a system without remote controllers where only one centralised device has been installed, if that device breaks down, then you may be faced with the problem of not being able to run the air conditioning units. It is our recommendation to install multiple centralised devices for safety purposes.

The identification number

You should take a note of the identification number and keep it in your records. You should also take care not to reveal the number to a third party.

Contact the place of purchase or your servicing agent if you forget the number.

Screen disruptions

There may be some disruption to the screen when it is refreshing, but this is not indicative of a malfunction.

Settings related

Limitations on changes to settings

There may be limitations on the changes you can make to settings depending on the model of air conditioning unit.

- For example:
- You cannot make changes to "Heat" when the unit is a specialised cooling machine
 - With the exception of some models, floor mounted units do not allow you to change the fan speed from "High".
 - You will not be able to change the airflow direction on ceiling embedded types, if they don't have flaps
- So please use this unit with consideration for the peculiarities of each of the units. Contact the place of purchase or your servicing agent for details.

Standby power (with time distribution)

This unit calculates distribution based on the operating times of the indoor units. The electricity and gas consumed while stopped (standby power) is not distributed. For example, if no air conditioners operate for a month, the standby power is not distributed to any distribution group. If an indoor unit operates for even a minute, however, all of the standby power is distributed to the distribution group to which the indoor unit belongs. With load distribution the standby power is included in the distribution.

The display on the screen when making changes

When you have made changes to the settings for indoor units on this unit, you may see the display returning temporarily (especially when performing batch operations). This is just a delay caused by communication and is not indicative of a malfunction.

Air conditioning distribution ratios and air conditioning usage

The methodology adopted on this unit for calculating air conditioning distribution ratios and air conditioning usage is only a simplified one. There will be differences from the usage volumes billed by the electricity and gas providers. Depending on operating conditions, there will be differences from the actual air conditioning volumes and the distribution ratios. Due to the rounding of fractions when calculating distribution ratios, you will observe differences arising between the following pairs of data.

- "Distribution rates of areas within a distribution group" and "100.00%"
- "Total of the distribution rate breakdown" and "distribution rate of the entire area"
- "Total of usage in each area" and "total usage according to the pulse meter"
- "Total of usages for in hours, out of hours, and out-off days" and "usage for the whole time"

As this unit calculates distributions (proportional allocation) through a comparison of load estimated for each indoor unit rather than measuring energy directly, please use the calculations only as a guide.

The current time and date settings

The unit's clock is accurate to ±30 seconds per month (at a normal temperature of 25 °C), regularly adjust the time and date against a reliable source.

About distribution data

If you remove an air conditioning unit after accumulating distribution data, all accumulated values for that air conditioning unit are deleted, so it will not be possible to view distribution data that includes that air conditioning unit after it is removed.

Before removing the unit, output (save) the distribution data as a CSV file to a USB memory device.

The output method for CSV files is the same as for outputting histories. (→ "Outputting (saving) logs as a CSV file" (P.60))

Interface adaptors (sold separately)

Interface adaptors include those used to convert transmissions and those used for on and off control. This unit is a centralised controller designed for use with electronic package air conditioners (PAC) and gas heat pump air conditioners (GHP) later than type G, but you can also connect it with older models by using interface adaptors to convert communications. There are the following limitations you should be aware of, however. Contact the place of purchase or your servicing agent for details.

Models you can connect	E series and F series GHP
Alarm display	"C12" (interface adaptor batch alarm) is displayed, but no details are displayed.
Maintenance information	The following information is not displayed for GHP outdoor units. <ul style="list-style-type: none"> • Engine operation hours • Oil replacement timing • Outdoor unit operating hours
Air conditioning distributing	Indoor unit fan speed data Cumulative operating hours ON hours for electric heater Indoor unit performance fixed values Distribution modes
Items that cannot be operated	The following operations are not possible: <ul style="list-style-type: none"> • Resetting the filter sign • Airflow direction settings • Test operation For old models, install remote controllers before use.
Test operation	When testing operation with remote controllers on old model indoor units, if you perform setting operations on this unit to the old model unit, test operations are automatically cancelled.
Demand operations	Demand operations to outdoor units are not possible.
Remote controller prohibition	You cannot change the prohibited items in the remote controller prohibition modes ("Pb1T" to "Pb1M"). Even if you make settings in "Local R/C Pb1st" settings in the "Settings for communication WAC(C)" screen (P.185), the settings will be invalid.

Interface adaptors for on/off control

Using interface adaptors for on/off control enables you to connect devices (ventilation fans, room air conditioners, etc.) to turn on or off. There are the following limitations you should be aware of, however. Contact the place of purchase or your servicing agent for details.

Items that can be centrally controlled	Centralised control is possible only with the following items: <ul style="list-style-type: none"> • ON/OFF • Remote controller prohibition (only prohibiting "ON/OFF") You can also make timer settings, but settings other than "ON/OFF" and "remote controller prohibition" will be invalid. "Remote controller prohibition" is only for when local prohibition signal output is connected from the interface adaptor to the device. "C12" (interface adaptor batch alarm) is displayed, but no details are displayed. (However, only when the alarm signal input is connected to the interface adaptor)
Alarm display	"C12" (interface adaptor batch alarm) is displayed, but no details are displayed. (However, only when the alarm signal input is connected to the interface adaptor)
Air conditioning distributing	Indoor unit fan speed data The cumulative operating hours by fan speed will be fixed to "Mid." Even when the thermostat ON signal input is connected to the interface adaptor, the cumulative operating hours will be counted as fixed to "Mid."
	ON hours for electric heater As these are not identified automatically, set the performance fixed capacity values in the "Edit unit settings" screen (P.143).
	Indoor unit performance fixed values Only time distribution is supported.
	Distribution modes

Note

- If a device meets the contact specifications as a interface adaptor for on/off control, you can control this unit from any device, but as this entails dangers to life, property, etc., it is strongly advised that you do not.
- After starting distribution operation, if you change the address of an indoor unit or switch the address of an indoor unit with another, for example, distribution calculations will be inaccurate, and other problems may occur so care should be taken.

Troubleshooting

Check the following before requesting repairs. Due to the dangers involved, do not perform repairs yourself.

Symptom	Cause and measures
Scheduling isn't working properly	<ul style="list-style-type: none"> Have you set the calendar and time? Scheduling cannot operate if you set the calendar and time but neglect to register the schedule. Are the current settings for the date and time correct? If the current time is not set properly, the schedule may be starting at another time.
The distribution ratio always becomes 100%	<ul style="list-style-type: none"> Check the distribution group and area group settings. If you put only one area group in a single distribution group or only one indoor unit in a single area group, the distribution ratio will always be 100%, and the calculations are meaningless.
The power turns off unexpectedly	<ul style="list-style-type: none"> Has the screen turn off automatically? The power is still on, so try touching the screen. Is the screen off for a long time? If the screen is off for a long time, the screen may turn off at start up. Is the screen off during operation? Depending on the communication status of the connected air conditioning units, it may take some time. The screen will update if you wait a moment.
Screen of the colour liquid crystal display	<ul style="list-style-type: none"> There may be some dots on the screen that do not light or stay lit constantly, but this is not indicative of a malfunction. Furthermore, it is characteristic for colour liquid crystal displays to show some discoloration due to changes in temperature, etc., but this is not indicative of a malfunction.
No operation even after touching buttons	<ul style="list-style-type: none"> After long term use, there may be a shift in the positioning of the operating positions on the touch panel compared to the screen's position. Contact the place of purchase or your servicing agent.
This unit suffers a malfunction while you have prohibited operations on local remote controllers and you are unable to change settings on air conditioning units, such as starting or stopping operation	<ul style="list-style-type: none"> As a stop gap measure until service personnel can visit, turn off this unit and the communication adaptor, then turn off the indoor units and turn them back on. You will not be able to use the local remote controllers. You will be unable to operate systems that do not have remote controllers.
There is a power outage and the devices do not automatically restore themselves after the power has been restored	<ul style="list-style-type: none"> This unit does not restore itself automatically after power has been restored. When a scheduled time is reached, the unit will switch to the scheduled setting.
Not even one indoor unit is loaded	<ul style="list-style-type: none"> Conduct a confirmation of the configuration.
The following message appears on the screen	 <ul style="list-style-type: none"> If there are changes to the system of air conditioning units, this message is displayed when you touch [Check configuration]. If this message is displayed, contact the place of purchase or your servicing agent.

Cautions when cleaning and maintaining

Take care of the following when cleaning and maintaining the unit.

Unplug the power cord when cleaning

The power connections of the unit include parts with very high voltage which can be extremely dangerous, so take care when cleaning. Before cleaning make sure you stop the system and unplug the power plug from the power outlet.

Use a neutral detergent

When removing dirt from the main unit and the surface of the touch panel, use a soft cloth dampened with warm water or a neutral detergent solution, then wipe well before wiping. Avoid using volatile chemicals, such as benzene or thinners, abrasive powders, or liquid pest sprays, as these can damage the unit's finish and the touch panel.

Do not let water get on the unit directly

Take care not to get water directly on the unit. Electric insulation may worsen leading to possible malfunction and electric shock.

Do not disassemble

Do not disassemble this unit. This may cause malfunctions which may lead to extremely dangerous electrocution.

Checking the fixtures

You should check the fixtures for rust and corrosion a few times a year to ensure the control panel is still firmly attached.

Specifications

Model No.	CZ-256ESMC3	
Dimensions [H x W x D]	240 x 280 x (20 + 65) mm	
Weight	2.7 kg	
Temperature/Humidity range	0 °C to 40 °C / 20% to 80% (no condensation) Indoor use only.	
Rated voltage/Rated frequency	Single phase 100-240 V ~ 50/60 Hz	
Power consumption	Max. 20 W	
Clock	Precision	± 30 seconds/month (at normal temperature 25 °C) • Adjust periodically
	Holding time	100 days (at normal temperature 25 °C with full charge) • Approx. 8 hours are required for full charge.
Number of connectable units per link^{*1}	Indoor unit - Up to 64 units ^{*2} Outdoor unit - Up to 30 units	
PC environment for remote control	Browsers	Internet Explorer 11 or later or Google Chrome
	Screen resolution	1280x1024 (recommended)
USB memory devices that can be used	Standard type (USB2.0) Capacity: 4 GB or more Cautions before use • Proper operation is not guaranteed even if you use a computer that meets the above specifications. • Encryption (with security software) etc., cannot be used. • Panasonic accepts no responsibility for any loss of data.	

*1: The maximum number of connectable units is shown below.
• When using only this unit: 128 indoor units and 60 outdoor units

*2: The number of indoor units includes the Communication Adaptor: 256 indoor units and 120 outdoor units

*3: The number of indoor units includes the Interface Adaptor.

Trademark and indemnity

- Microsoft and Windows are the registered trademarks of Microsoft Corporation in the United States and other countries. Google Chrome is either a trademark or registered trademark of Google Inc. Other products mentioned are the trademarks or registered trademarks of the respective corporations.
- Other products are the intellectual property of the respective corporations.
- It is prohibited by copyright law to reproduce fully or in part the software and operating instructions included with this unit, or to lend out the software, without the permission of the rights holder.
- This company accepts no responsibility for damages, losses, or requests for payment incurred as a result of using this unit or the software included with this unit. If any problems with calculations, etc., of proportions and usage volumes occur due to issue with the device or software, we will not be responsible for any compensation.
- The software included with this unit should not be used with any other devices.
- This unit and the software included with it may be modified to improve performance without prior notice. The content of this document may also be changed without notice.
- Infringements of third party patent rights or other rights as a result of using the items described in this document shall not be the responsibility of this company.
- Refer to the DVD included with the intelligent controller for the open source licenses.

● Intelligent Controller (CZ-256ESMC3)

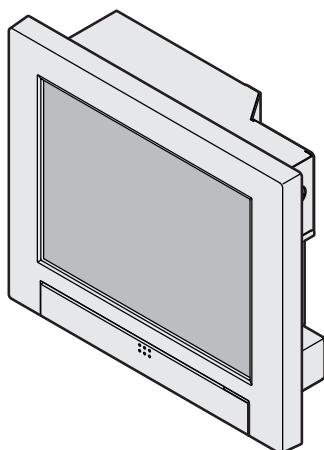
Panasonic[®]

Installation Instructions
Intelligent Controller

Model No. **CZ-256ESMC3**

English

Read through the Installation Instructions before you proceed with the installation. In particular, you will need to read under the “Safety Precautions” on page 2.

Contents

● Safety Precautions	2
● Specifications	2
Supplied accessories	3
● Dimensions (Part Names)	3
● Caution for Network Connection	3
● Installation Precautions	3
Installation Location.....	3
General Precautions on Wiring	3
● Mounting	3
Design Control Box	3
Mounting Position.....	3
How to Mount (Control Box).....	3
● Preparations for Wiring	4
Power Supply Wiring	4
Inter-Unit Control Wiring.....	4
Communication Adaptor Control Wiring ...	4
External I/O Wiring	4
LAN Cable	4
● Wiring	4
● Connecting to External Equipment	5
● Setting and Test Operation	5





Panasonic Corporation
1006 Kadoma, Kadoma City, Osaka, Japan

Safety Precautions

Please Read Before Starting

This controller must be installed by the sales dealer or installer. These instructions are all you need for most installation sites and maintenance conditions. If you require help for a special problem, contact our sales/service outlet or your certified dealer for additional instructions.

 **WARNING** This symbol refers to a hazard or unsafe practice which can result in severe personal injury or death.

 **CAUTION** This symbol refers to a hazard or unsafe practice which can result in personal injury or product or property damage.

- We assume no responsibility for accidents or damages resulting from methods other than those described in the installation instructions or methods without using specified parts. Malfunctions that occurred due to the unauthorised installation methods are not covered by the product warranty.
- This controller shall be installed in accordance with National Wiring Regulations.
- After the installation is complete, perform test operation to confirm that no abnormality is present.
- Read the installation instructions of devices to be connected as well.
- When relocating or repairing this controller, provide the Installation Instructions to the servicing personnel.

WARNING

 **ELECTRICAL SHOCK CAN CAUSE SEVERE PERSONAL INJURY OR DEATH. ONLY A QUALIFIED, EXPERIENCED ELECTRICIAN SHOULD ATTEMPT TO WIRE THIS SYSTEM.**

- Highly dangerous electrical voltages are used in this system. Carefully refer to the wiring diagram and these instructions when wiring. Improper connections and inadequate grounding can cause **accidental injury or death**.
- This controller is strongly recommended to be installed with Earth Leakage Circuit Breaker (ELCB) or Residual Current Device (RCD). Otherwise, it may cause electrical shock and fire in case of equipment breakdown or insulation breakdown. Earth Leakage Circuit Breaker (ELCB) must be incorporated in the fixed wiring in accordance with the wiring regulations. The Earth Leakage Circuit Breaker (ELCB) must be an approved

10 A, having a contact separation by 3 mm in all poles.

- Provide a power outlet to be used exclusively for this controller.
- Turn off the circuit breaker of the controllers before installation.
- Do not supply power to the controller until all wiring is completed or reconnected and checked.
- Fix the power supply wiring securely with the clammer so that the power supply terminal board is free of tension (external force) when pulled. Loose connection of the terminal board may cause fire.
- To prevent possible hazards from insulation failure, the controller must be grounded. 
- Select an installation location which is rigid and strong enough to support or hold the controller, and select a location for easy maintenance.
- This product must not be modified or disassembled under any circumstances. Modified or disassembled controller may cause fire, electric shock or injury.
- Do not clean inside the controller by users. Engage authorized dealer or specialist for cleaning.
- Do not operate with wet hands.

CAUTION

- Ground yourself to discharge static electricity before performing any wiring.
- Do not use the controller at the following locations.
 - Areas where leakage of flammable gas may be expected
 - Places where large amounts of oil mist exist
 - Locations where external air may enter the room directly (This may cause "condensation")
 - Locations where high-frequency emissions are generated
 - Locations where voltage fluctuation frequently occurs
- Do not wash with water.

NOTICE

The English text is the original instructions. Other languages are translation of the original instructions.





Specifications

Model No.	CZ-256ESMC3	Clock	Precision	± 30 seconds/month (at normal temperature 25 °C) *Adjust periodically.	
Dimensions [H × W × D]	240 × 280 × (20 + 65) mm		Holding time	100 days (at normal temperature 25 °C with full charge) *Approx. 8 hours are required for full charge.	
Weight	2.7 kg		Number of connectable units per link ^{*1}	Up to 100 units of the combined total of the following	
Temperature/Humidity range	0 °C to 40 °C / 20 % to 80 % (no condensation) Indoor use only.	<ul style="list-style-type: none"> • Indoor unit - Up to 64 units^{*2} • Outdoor unit - Up to 30 units • Central control device - Up to 10 units 			
Rated voltage/ Rated frequency	Single phase 100-240 V ~ 50/60 Hz				
Power consumption	Max. 20 W				

*1: The maximum number of connectable units is shown below.

- When using only this unit: 128 indoor units and 60 outdoor units
- When connecting a Communication Adaptor: 256 indoor units and 120 outdoor units

*2: The number of indoor units includes the Interface Adaptor.

Supplied accessories		< >: Number of pieces	
Screw <4> (M4×10)		Washer <4>	
Nut <4> (M4)		Clamper <4>	
Instructions and License List (DVD), Quick Reference, Installation Instructions			

* Wiring are not included (field supplied item).

Dimensions (Part Names)

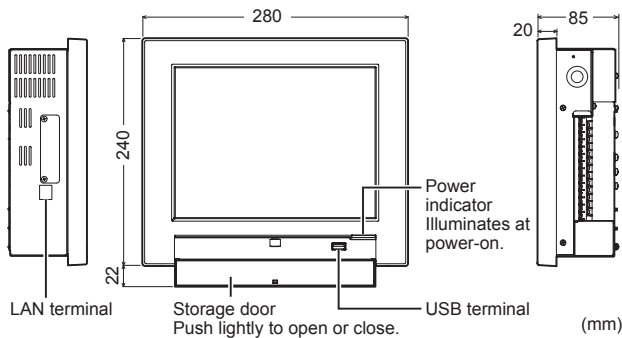

Symbols on the controller

 This symbol refers to "Protective earth".

Caution for Network Connection

- Connecting to Internet will enable you to operate the unit and check the status using a PC from a remote location.
- When connecting to Internet, implement security measures against illegal access from outside. For detailed connection and setup method, consult the network administrator.

Installation Precautions

Installation Location

- Avoid the following locations for installation.
 - Under direct sunlight
 - Location near heat source
 - Location where the controller will be splashed with water or affected by dampness or humidity
 - Uneven surface
 - Location that is subject to excessive vibration or physical impacts. (Fixing screws may come off, and the controller may drop.)
- Install the controller vertically to the floor.
- Install the controller at a location with suitable temperature and humidity for using.
- Do not install controller at the locations with the equipment (medical equipment, etc.) which generates the high-frequency emissions. (It may interfere with the equipment and may cause accidents due to malfunction.)
- Install at least 1 m away from TV, radio, PC, etc. (To prevent fuzzy images or noise)

General Precautions on Wiring

- Regulations on wire diameters differ from locality to locality. For field wiring rules, please refer to your LOCAL ELECTRICAL CODES before beginning. You must ensure that installation complies with all relevant rules and regulations.
- Use the field supplied wiring with at least 1 mm in thickness of insulation part including the sheath.
- Connect all wiring tightly to prevent the terminal board from loosening when the wiring connection part is pulled by an external force. (Otherwise, fire or overheating may occur.)
- Using putty (field supplied item), etc., fill the hole of the control box through which the wiring passes.
- Do not pass the power supply wiring and other wirings through the same conduit. Keep as long a distance as possible between them to alleviate the influence of noise.
- Do not run the power supply wiring and other wiring in the same conduit or bundle them together. (An operational error from noise may occur.)
- Do not bury the wiring in the ground.

Mounting

Design Control Box

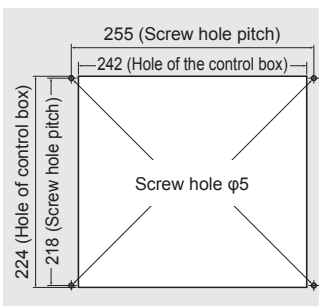

Mounting Position

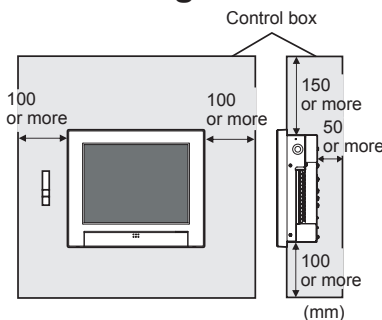

How to Mount (Control Box)

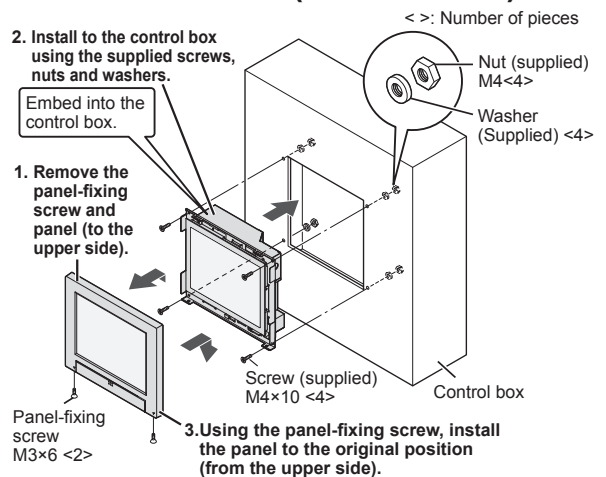

To ensure proper airflow (for heat dissipation) inside the control box, provide vents (slits, etc.) both on the upper part and lower part (or bottom side) of the right and left sides.

- Do not allow the temperature inside the control box to exceed 40 °C.
- Be careful not to block the above vents.

Preparations for Wiring

■ Power Supply Wiring

- Be sure to use a dedicated line for power source.
- Be sure to earth this controller.
- Do not connect the earth wiring to those of gas pipe, water pipe, lighting rod, telephone, etc.

● Type of wiring

- Use a flexible wiring of 2 mm² (Recommended).
- Use the standard power supply wiring for Europe (such as H05RN-F or H07RN-F which conform to CENELEC (HAR) rating specifications) or use the wiring based on IEC standard (60245 IEC57, 60245 IEC66).

● Total Wire Length : 30 m or less

■ Inter-Unit Control Wiring

● Type of wiring

- Use a flexible shield wiring of 0.5 to 2 mm².
- No polarity

● Total Wire Length : 1000 m or less

● Number of connectable units and devices : (→ P.2 “Specifications”)

■ Communication Adaptor Control Wiring

(When connecting a Communication Adaptor)

- Polarity (+/-) present
- Number of connectable Communication Adaptor: up to 7 units
- For the type of wiring and total wiring length, see “Installation Instructions” supplied with the Communication Adaptor.

■ External I/O Wiring

(When connecting external equipment)

- Type of wiring
 - Use a flexible wiring of 0.5 to 2 mm².
- Wire Length : 20 m or less

Attention

- When using the controller at a location susceptible to noise, use a shield wiring.

■ LAN Cable (When connecting to a network)

- Type of wiring
 - Category 5 or above straight cable
- Wire Length : 100 m or less

Attention

- Ground the shield on both sides of shield wiring, otherwise an operation error from noise may occur.

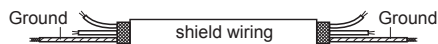

Wiring

Basic Wiring Diagram

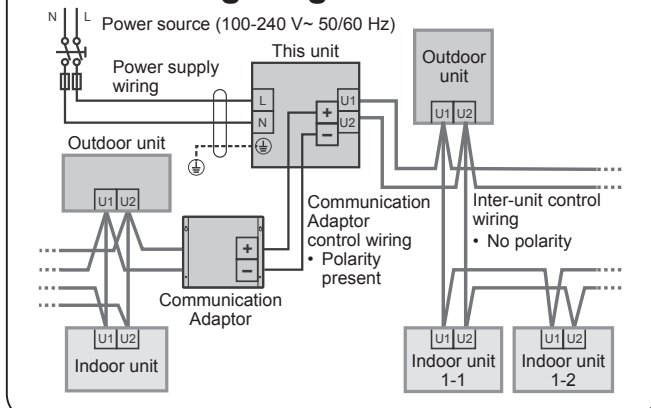

1. Turn the circuit breaker off before connecting the wiring

2. How to Attach the Ring Pressure Terminal

● For power supply wiring

Process the end of each wiring, and attach the ring pressure terminal (field supplied item).

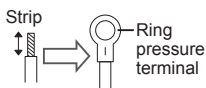

● For shield wiring

Process the end of the each wiring and attach the ring pressure terminal (field supplied item).

① Remove wiring coat.

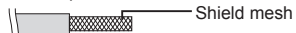

② Cover with the tape.



③ Attach ring pressure terminal.

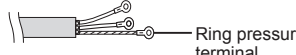

3. Remove the power switch cover

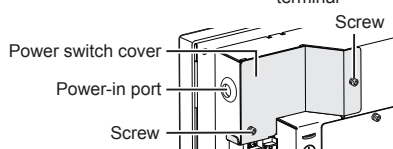

4. Wiring

① Connect the power supply wiring.

- Connect the power supply wiring and the earth wiring to the power supply terminal board and the earth terminal board^{*3} (on the sheet metal case) respectively.
- *3: Use earth terminal board as protective earth
- Do not over-tighten. (The screw may be damaged.)

② Connect the inter-unit control wiring.

- Connect the shield part of the shield wiring to No. 0 (FG^{*4}) of the signal terminal board (TB2).
- *4: Functional Ground
- Do not over-tighten. (The screw may be damaged.)
- There is no polarity.

③ Connect the Communication Adaptor control wiring.

- Make sure the polarities (+/-) are correct.

Attention

- Read the “Installation Instructions” supplied with the Communication Adaptor.

④ Connecting external equipment.

Attention

- See “Connecting to External Equipment” (P.5).

⑤ Fix the power supply wiring and other communication wirings with the clumper (supplied) securely.

(Do not apply tensile force on the terminal connection part.)

⑥ Connect the LAN cable.

⑦ After all wiring arrangements are complete, turn the circuit breaker on.

- Before power on, measure the voltage of the power supply terminal board, and check it for the specified voltage. Turning the power on with a voltage other than the specified one may blow the fuse. If this occurs, no power is supplied, and this unit may need to be replaced.

Wiring (continued)

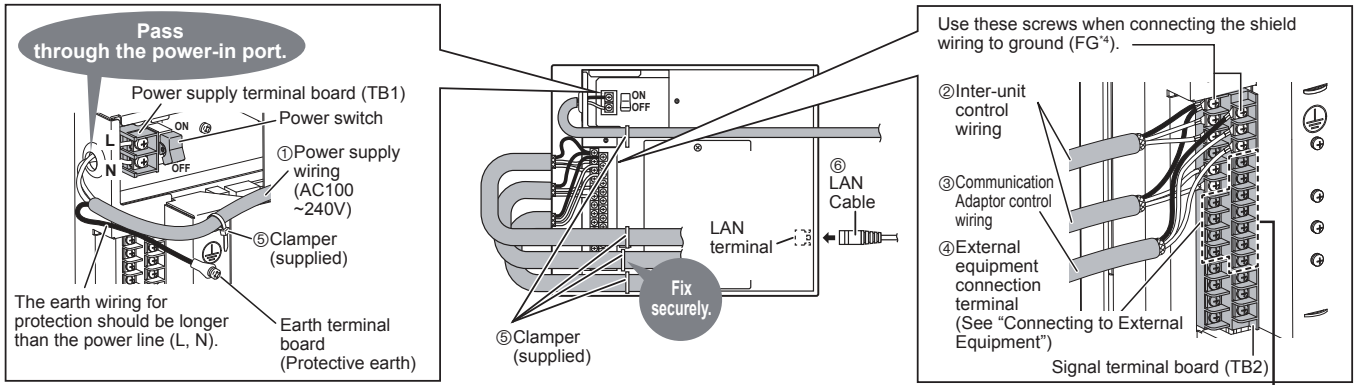

- If the power supply wiring is mistakenly connected to a terminal board other than the power supply terminal board, the devices connected to this controller or this controller will malfunction.

Signal terminal board (TB2) connection

Connect the shield wiring for the inter-unit control wiring to ground. (FG*4)	FG*4	0			
Connect to inter-unit control wiring (LINK1)	U1	1		14	FG*4
	U2	2		15	+
		3		16	-
Connect to inter-unit control wiring (LINK2)	U1	4		17	
	U2	5		18	
				19	

Connect the Communication Adaptor control wiring. (ADAPT +, -, FG*4)

Connecting to External Equipment

- Non-voltage contact "a"
- Keep the external I/O wiring lengths of 20 meters or less. If a longer length is needed, use a Communication Adaptor or relay.
- A voltage of DC5 V (approx. 10 mA) is applied to the contact to detect the input signal.
- Do not apply an external voltage to the input terminal.
- The contact allowable voltage and current for the output signal terminal are max. DC30 V and 0.5 A respectively.

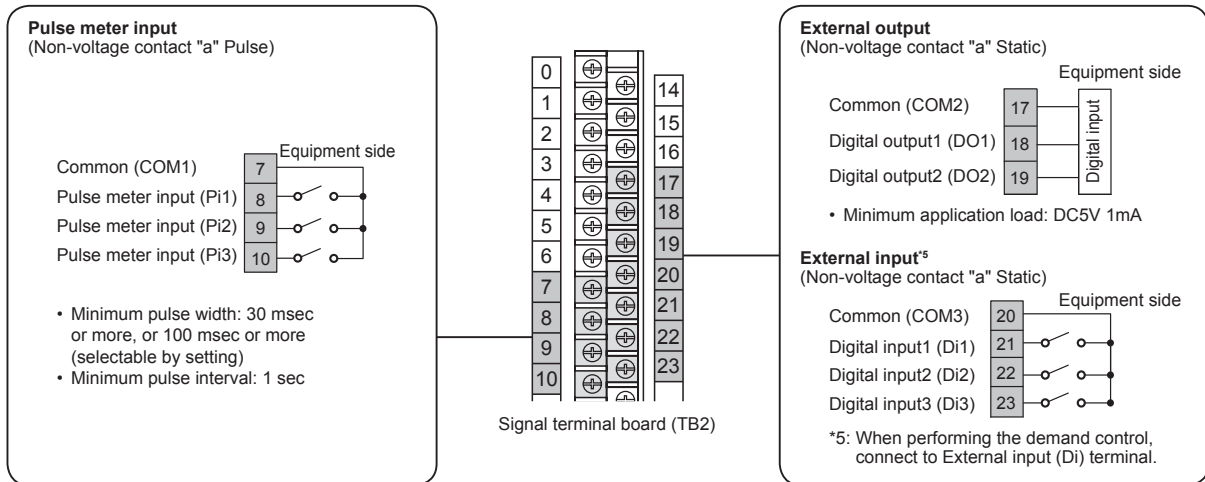

Setting and Test Operation

- ① Turn on all of the indoor units and the outdoor units.
- ② Turn on the Communication Adaptor (only when connected), and make the necessary settings. (See "Installation Instructions" supplied with the Communication Adaptor.)
- ③ Turn on this unit.
- ④ Attach the power switch cover to the original position.
 - Do not allow the wirings to be caught.
- ⑤ Refer to "Quick Reference" and check the following.
 - Check if the clock setting and the number of connected units are correctly displayed.
- ⑥ Refer to one of "Service Manual", "Test Run Service Manual" and "Technical Data", and check the following.
 - Set the central address.
 - Make other necessary settings (unit name, area setting, distribution setting, etc.).
 - Check if the indoor unit, etc. can be operated properly using this unit, and correct statuses are displayed.
 - Make the communication setting with the air conditioner.
 - Check and confirm the connection configuration.

● Communication adaptor (CZ-CFUNC2)



Instructions for the Electrical Installer (CZ-CFUNC2)

For your safety

- Read the following instructions carefully, and carry out secure installation and electrical work.
- The precautions given in this manual consist of specific "Warnings" and "Cautions". They provide important safety-related information. Be sure to strictly observe all safety procedures. The labels and their meanings are as described below.

Warning	This symbol refers to a hazard or unsafe procedure or practice that can result in severe personal injury or death.
Caution	This symbol refers to a hazard or unsafe procedure or practice that can result in personal injury or product or property damage.

* After installation is completed, perform a test run to check for operating trouble. Explain operating procedures to the customer following the central control device Operation Manual and then request the customer to store this Instructions for the Electrical Installer together with the central control device Operation Manual.

Warning

- Be sure to arrange installation by the dealer where the system was purchased or by a professional installer. Electric shock or fire may result if an inexperienced person performs any installation or wiring procedures incorrectly.
- Be sure that this unit is securely installed in accordance with this Instructions for the Electrical Installer. Electric shock or fire may result if any installation or wiring procedures are incorrectly performed.
- Only a qualified electrician should attempt to connect this system, in accordance with the instructions in this manual. Insufficient electrical circuit capacity or incorrect installation may cause electric shock and fire.
- Use the specified cables for the electrical connections, and connect the cables securely. Run and fasten the cables securely so that external forces or pressure placed on the cables will not be transmitted to the connection terminals. Overheating or fire may result if connections or attachments are not secure.
- Depending on the installation conditions and location, an earth leakage breaker may be required. If an earth-leakage breaker is not installed, there is a danger of electric shock or fire.
- The installation location requires the use of a circuit breaker. Failure to use a circuit breaker may result in electric shock or fire.
- Circuit breaker must be incorporated in the fixed wiring in accordance with the wiring regulations. The circuit breaker must be an approved 10-16 A, having a contact separation in all poles.

Caution

- Ground yourself to discharge static electricity before performing any wiring.

1 Installing

Note

- Do not run the indoor/outdoor communication lines, input/output lines, and power cables through the same conduit, or twist those cables together, or place the cables near one another. It can cause malfunction.
- Install the main unit away from any sources of electrical noise.
- Avoid installing in any locations where the unit may come into contact with water, or in any extremely humid locations.
- Avoid installing in any location that is subject to excessive vibration or physical impacts.

- (1) After determining the attachment position, secure the installation hardware as shown in the dimensions diagram. If the included screws will not work for the installation, prepare appropriate screws (such as metric ones) for use at the site.
- (2) Attach the main unit and fasten the installation hardware as illustrated.
- (3) If the installation hardware is loose or appears like it will fall out, remove the upper case on the unit and secure with screws in the failsafe screw holes.

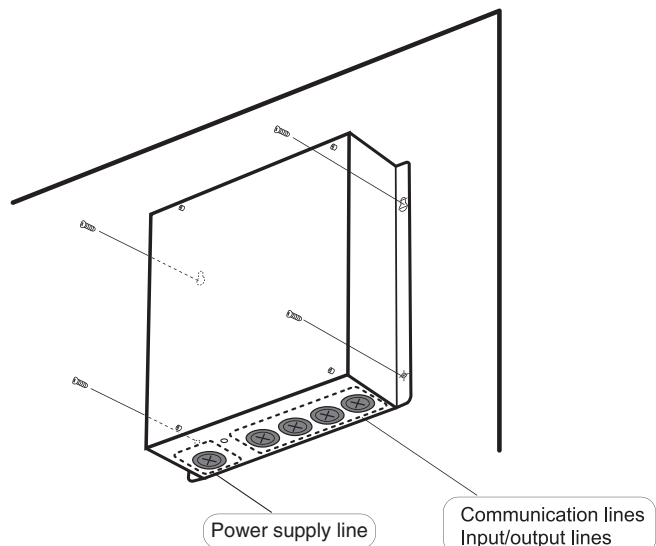

2 Wiring

Always shut off the power supply (breaker) before installing or uninstalling the Communication Adaptor.
Remove the two screws at the front of the unit and remove the upper case.

Arrangement of the terminal board and switches

Detailed board illustration

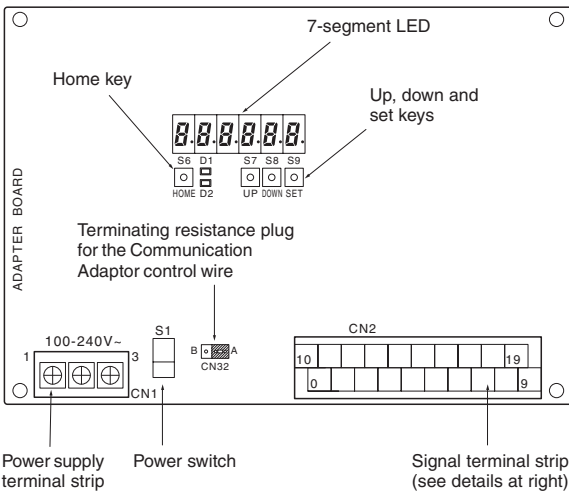

Detailed terminal assembly illustration

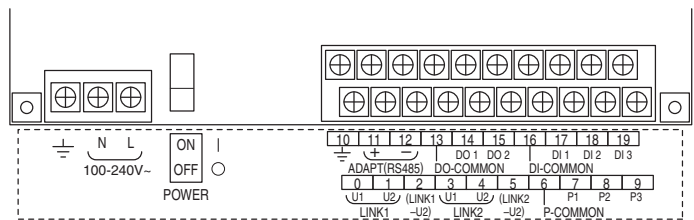

- ADAPT +/- : Communication Adaptor control wire (RS-485)
 - LINK 1/2: Inter-unit control wiring (HBS)
 - P1: Pulse meter inputs (gas flow meter and fuel flow meter) (*)
 - P2 and P3: Pulse meter input (power flow meter) (*)
 - DI1: All stop input (*)
 - DI2: All operation input (*)
 - DI3: Reserved
 - DO1: All alarm output (*)
 - DO2: All operation output (*)
- (*) Input/output function when connecting to the Intelligent Controller

(1) Connecting the power supply

The unit can use AC power sources between 100 and 240 V.
Connect the power supply to terminals 2 (N) and 3 (L) on the power terminal strip CN1. (Connect the AC neutral end to N.)
Connect the ground line securely.

(2) Connecting the communication line

- For the Communication Adaptor control wires, use only two-conductor **shielded wire** with a cross-section between 0.5 and 2.0 mm² (MVVS or CPEVS).
- Be sure to ground only one end of the shielding.
- The overall length of each line should be 1 km or less.
- Do not run the communication line through the same conduit as the power supply, use the same cable as the power supply, or run close to the power supply line (maintain at least 30 cm separation).
- Do not run the LINK1 and LINK2 signal lines through the same conduit, use the same cable for wiring, or run them close together.
- Use different communication and power cables so they can be differentiated visually.

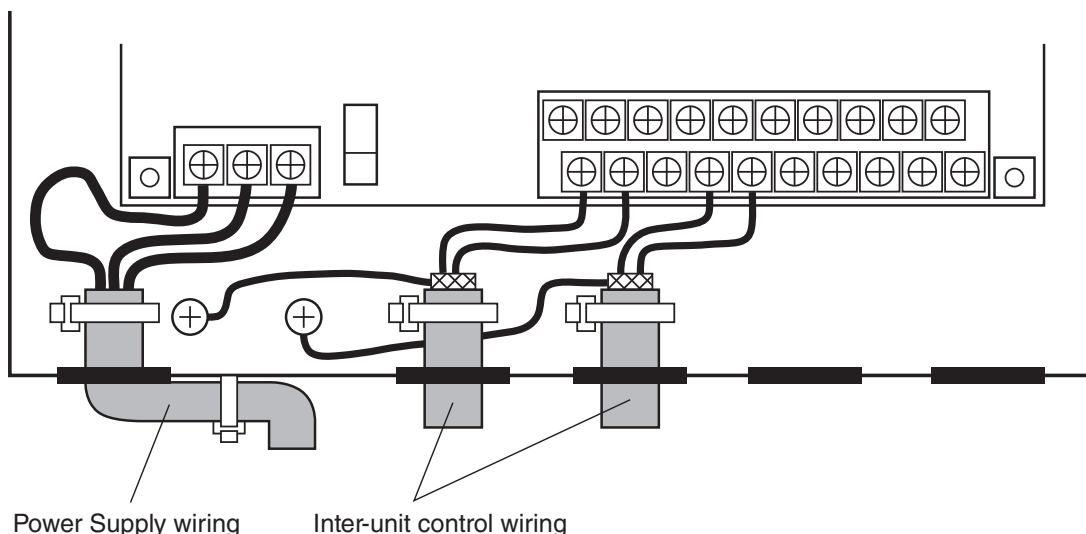

Basic wiring diagram (Example using an Intelligent Controller)

Wire up the Communication Adaptor control wire and Inter-unit control wiring as shown in the figure below.

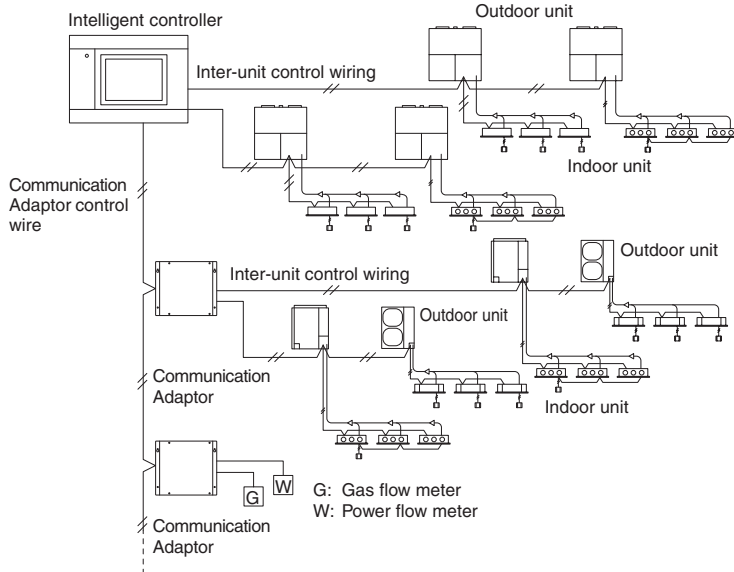

Wiring procedure

- **Inter-unit control wiring**
Use the shielded wire for inter-unit control wiring. Connect terminals 0 and 1 (LINK1) on the Communication Adaptor signal terminal strip CN2 to the inter-unit control wiring terminals of the indoor or outdoor unit. There is no polarity. If connecting two inter-unit control wiring systems, connect terminals 3 and 4 (LINK2) on CN2 in the same manner.
- **Communication Adaptor control wire**
Connect terminals 11 and 12 (ADAPT + and -) on the Communication Adaptor signal line terminal strip CN2 with the same terminals on the other Communication Adaptor. **The terminals have polarity.** Connect so the positive and negative elements are correct. When connecting, **be sure to use crossover wiring, not a branching configuration.**

3 Precautions for the Communication Adaptor control wire

(Some items are duplicated in other sections.)

- (1) The overall length should be 1 km or less.
- (2) The communication wire has polarity. Connect so the positive and negative elements are correct.
- (3) Use only shielded wire. Be sure to ground only one end of the shielding.

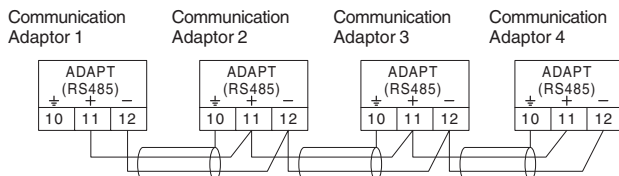

- (4) Be sure to use crossover wiring, not a branching configuration.
 - * Connect the Intelligent Controller to the end of the crossover configuration.

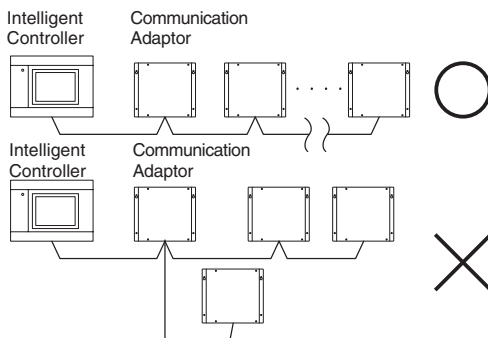

- (5) Change the terminating resistance plug CN32 to the "B" side (with terminal resistance) on the board for the Communication Adaptors at the terminal end of the configuration.

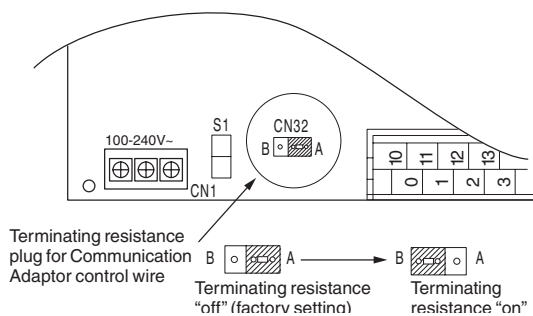

- (6) Do not hook more than 16 units up to the Communication Adaptor. The system you are using (such as an Intelligent Controller) may have further restrictions. Consult the installation manual for your system.
 - * The Intelligent Controller has a maximum restriction of seven units.
- (7) Make sure that high voltage (ex. 230 V) AC lines are not connected to the Communication Adaptor control wire or the inter-unit control wiring terminals.
 - * If high voltage AC is accidentally applied to the inter-unit control wiring terminals, a fuse will blow to protect the controller board. If this happens, disconnect the AC line, and connect the U2 terminal wire of the inter-unit control wiring to the spare terminal. (Do not change the U1 terminal wire.) Spare terminals are located right next to U2.

Change terminal number 1 LINK1-U2
→ to terminal number 2 (LINK1-U2)
Change terminal number 4 LINK2-U2
→ to terminal number 5 (LINK2-U2)

4 Setting the Communication Adaptor board

The switches on the board control the adaptor numbers, turn the inter-unit control wiring connection on and off, and control other settings.

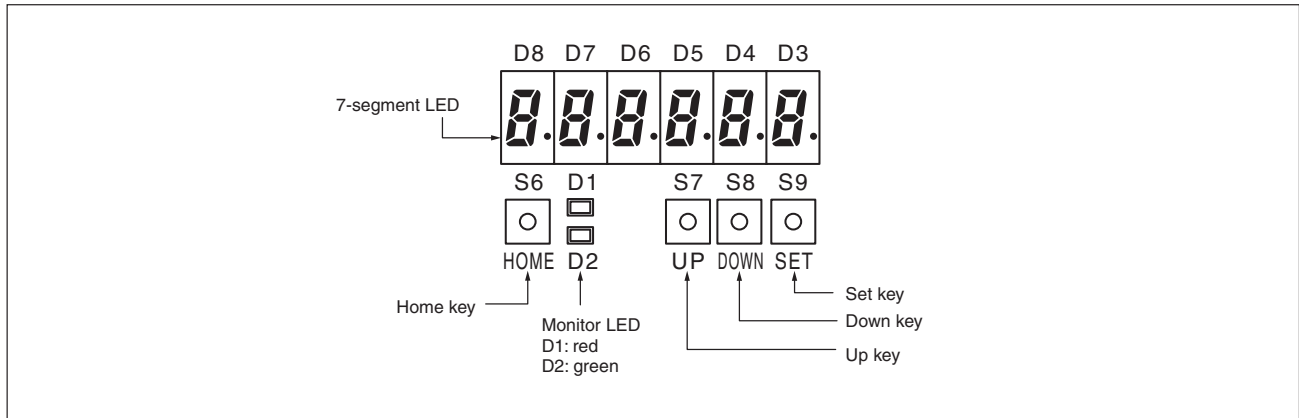

(1) Switch operation overview

Turn on the Power switch(S1) on the board.

① Item selection

Use the and keys to find the desired item, then press the key to select.

② Changing the settings

Use the and keys to change the setting, then press the key to confirm.

Hold down the key for at least two seconds to reset to the default setting (Any settings in progress will be lost.)



(Any settings in progress will be lost.)

(2) Adaptor number setting procedure

① Hold down the key for at least two seconds so the initial display shows as follows:



After 2 seconds



② Press the key five times so the following display appears:



This automatically switches to the below display after 2 more seconds. (Operation is not necessary.)



③ Press the key so the below display appears. (Only the green monitor LED is on.)



④ Hold down the key for at least 1 second so the "00" part blinks, indicating that the setting can be changed. (The green and red monitor LEDs are both on.)

Use the and keys to set the adaptor number.

For example, to set number 3, press the key three times. The following will display:



⑤ Press the key for at least 1 second to confirm. (Only the green monitor LED is on.)

(3) Setting the inter-unit control wiring connection on/off

① Repeat steps ① to ③ in section (2) "Adaptor number setting procedure" above. The following will display:

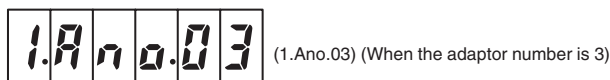

② Press the key once so the following display appears:



③ Hold down the key for at least 1 second so the "0" part blinks, indicating that the setting can be changed. (The green and red monitor LEDs are both on.)

Use the and keys to turn the inter-unit control wiring connection on or off as shown in the table below.

Setting value	Inter-unit control wiring connection
0	LINK1: On, LINK2: On (factory setting)
1	LINK1: On, LINK2: Off
2	LINK1: Off, LINK2: On
3	LINK1: Off, LINK2: Off

For example, to connect the inter-unit control wiring only to LINK1, press the key once. The following display will result:



④ Press the key for at least 1 second to confirm. (Only the green monitor LED is on.)

(4) Other settings

With the display status showing as in number ③ in section (2) "Adaptor number setting procedure", press the and keys to select the setting items shown in the table below. Set as needed.







The setting procedure is the same as above.

(Press the key for at least 1 second, press the and keys to change, then press the key at least one second to confirm.)

Note

- ① When configuring, do not set the same adaptor number more than once.
* Use numbers between 1 and 7 for connecting to an Intelligent Controller.
- ② Turn the inter-unit control wiring connection on/off as appropriate.
(Set to "Off" for LINKs with no connection.)
- ③ For connecting the inter-unit control wiring to only one link, use the "LINK1" side.

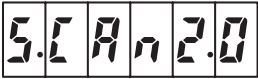
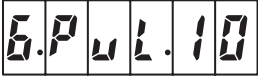
Table 1 Communication Adaptor setting items

	Display	Setting item (grayed in areas indicate factory setting)
	 <p>(1.Ano.xx)</p>	<p>[1] Adaptor number setting xx = 00 to 15: adaptor number Sets the Communication Adaptor number. Set 1 to 7 for the Intelligent Controller, making sure the same number is not used twice. When actually communicating from a master system, the link system address LINK1 is 2n and LINK2 is 2n + 1, where n is the Communication Adaptor number. Thus, when the adaptor number is 2, the LINK1 address is 4 and the LINK2 address is 5.</p>
	 <p>(2.AdYu.x)</p>	<p>[2] Inter-unit control wiring connection settings x = 0: LINK1 on, LINK2 on x = 1: LINK1 on, LINK2 off x = 2: LINK1 off, LINK2 on x = 3: LINK1 off, LINK2 off Set so any LINK (inter-unit control wiring) connected to the air conditioner is "on", and any LINK not connected is "off". * For solo installation (pulse meter dedicated), use x = 3: LINK1 and 2 both set to off.</p>
	 <p>(3.Cont.x)</p>	<p>[3] Base unit settings Always use 0 (the initial value).</p>
<p style="text-align: center;">↑ DOWN UP ↓</p>	 <p>(4.CAn1.x)</p>	<p>[4] Settings for the number of Communication Adaptor units in one link, part 1 x = 0 to 7 x = 0: First Communication Adaptor in the LINK1 link x = 1: Second Communication Adaptor in the LINK1 link x = 7: Eighth Communication Adaptor in the LINK1 link</p>
	 <p>(5.CAn2.x)</p>	<p>[5] Settings for the number of Communication Adaptor units in one link, part 2 x = 0 to 7 x = 0: First Communication Adaptor in the LINK2 link x = 1: Second Communication Adaptor in the LINK2 link x = 7: Eighth Communication Adaptor in the LINK2 link Set the Communication Adaptor unit number for each LINK system when connecting multiple Communication Adaptors to one inter-unit control wiring.</p>
	 <p>(6.PUL.xx)</p>	<p>[6] Minimum pulse input detection time setting x = 03: 30 msec x = 10: 100 msec If connecting a pulse meter with a pulse width between 30 and 100 msec, set to 30 msec.</p>
	 <p>(7.LoCA.x)</p>	<p>[7] Interface Adaptor connection settings x = 0: LINK 1 on, LINK2 on x = 1: LINK 1 off, LINK2 on x = 2: LINK 1 on, LINK2 off x = 3: LINK 1 off, LINK2 off Set whether there is a Interface Adaptor (for turning off and on) for each LINK system. If the setting is "off", startup will be faster as no Interface Adaptor detection is run. Use the setting "x=0" for devices other than the Intelligent Controller.</p>
	 <p>(8.SCAAn.x)</p>	<p>[8] Initial communication setting Always use 0 (the initial value).</p>

5 Connecting to external equipment

(1) External all input (No-voltage a-contact static)

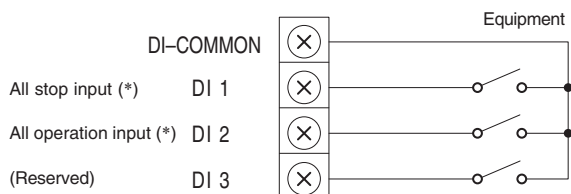

(2) External all output (No-voltage a-contact static)

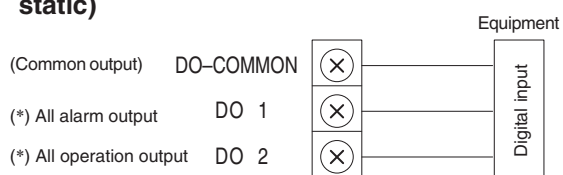

(3) Pulse meter input (No-voltage a-contact pulse)

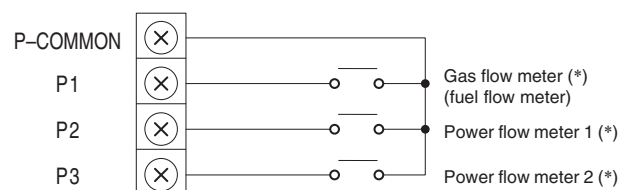

- Minimum pulse width: 100 msec
- Minimum pulse interval: 1 sec

(*) Input/output function when connecting to the Intelligent Controller

- Keep the signal input line lengths to 20 meters or less. For distances greater than this, install a standalone Communication Adaptor or use a relay.
- For use in areas that may be susceptible to electrical noise, use a two-conductor shielded cable (with one line grounded), with a cross-section at least 0.5 mm².
- Do not apply external voltages to the input terminals.
- About 10 mA of 5 V DC voltage is applied to the contact point for input terminal detection.
- The output terminal allowable contact voltage and current are 30 V DC and 0.5 A.

6 Outer dimensions

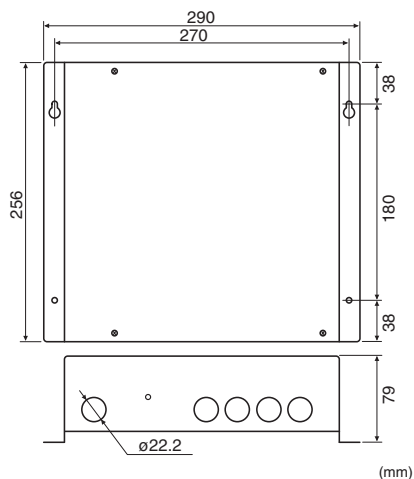

7 Specifications

Rated voltage	Single phase 100-240V~
Rated frequency	50/60 Hz
Power consumption	5.6 W max
Operating temperature	-10 to +50°C
Operating humidity	20 to 80% (no condensation)

Appendix A. Connecting to an Intelligent Controller

Before making the initial settings for the Communication Adaptor, check to ensure the below operations are complete.

- (1) Is the air conditioner test operation complete?
 (2) Is the wiring for the air conditioner and the Communication Adaptor complete?

To set, follow steps 1 to 5 below in sequence.

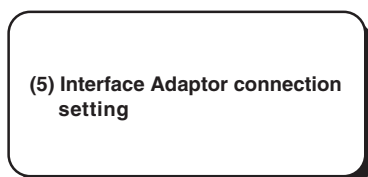
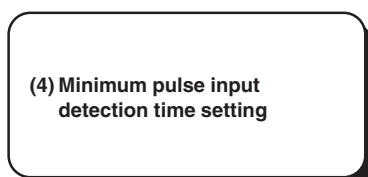
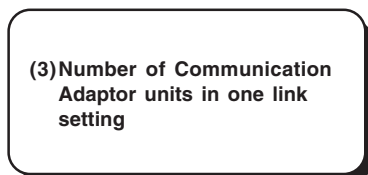
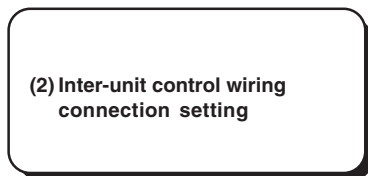
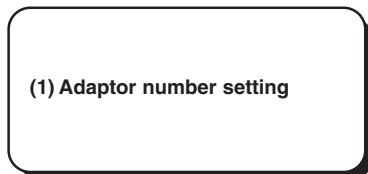

Complete!

- **This is a required setting.**
- Set the address for the Communication Adaptor control wire.
 For the Intelligent Controller internal board, the address is 0. Set a value between 1 and 7 for the external adaptor, ensuring no value is used twice.
 Refer to the number (2) "Adaptor number setting procedure" in section [4] "Setting the Communication Adaptor board".
 * Refer to Table 1 [1].

- **This setting is required for two or more Communication Adaptors.**
- Two links can be connected to a Communication Adaptor.
 For links without an air conditioner or other such connection, set the LINK to "off".
- The Intelligent Controller can be connected to only four links that are set to be active.
 Refer to the number (3) "Setting the inter-unit control wiring connection on/off" in section [4] "Setting the Communication Adaptor board".
 * Refer to Table 1 [2].

- **This setting is required only for using an Intelligent Controller in conjunction with a AMY Software.**
- When adding another Communication Adaptor to the inter-unit control wiring, the adaptor address for the added unit needs to be changed.
 * Refer to Table 1 [4] and [5].

- **This setting is not required if pulse input (P1, P2, P3) is not used.**
- Use a pulse meter whose minimum pulse width is normally at least 100 msec.
 If and only if a pulse meter 30 msec or higher must be used, use this setting.
 * Refer to Table 1 [6].

- By not using a Interface Adaptor, the configuration confirmation time can be shortened.
- **Not using this setting will not affect operation of the device.**
 * Refer to Table 1 [7].

Intelligent Controller web settings — Advance check sheet

Dear Client

Thank you for choosing the Intelligent Controller.

This system is fundamentally designed to be connected to an existing intranet or LAN. Before setting up, there are details to confirm in advance about the client's PC (network) environment.

Please check the “□” of the applicable items below, and fill in the required items.

Thank you

■ Request

- ① Do not connect to the network until the following settings are completed.
- ② Use at least Category 5 (*) for the LAN cable.
- ③ In order to protect the network against unauthorized external access, take security measures such as using a firewall.

* Communication cable standard established by the American Telecommunications Industry Association (TIA) and the American Electronic Industries Alliance (EIA)

1. In order to connect with the Intelligent Controller from the web browser of the client's PC and operate the air conditioner, the following environment is required. Please check the corresponding “□”.

- Supported browsers: Internet Explorer 11 or later, or Google Chrome
- Screen resolution: 1280 × 1024 or higher recommended
- Communication protocol: IPV4 (IPV6 not supported)
- Do not use DHCP. (In the case of DHCP, it is only possible to use the NTP server time setting and the alarm mail function. Please fill in ⑧ (⑨) of 2, and 3)

If everything is checked OK, go to the next step.

2. Confirm network connection environment

- ① Do you want to connect the web-ready Intelligent Controller and the PC 1-to-1?

[1-to-1]

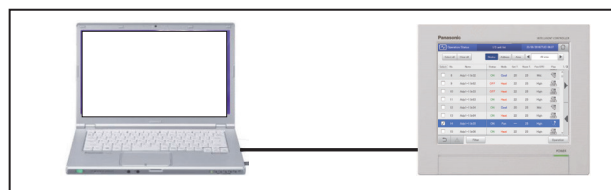

- Yes ⇒ There are no items to fill in in advance.
Our staff will perform setup during the test run. Thank you very much.
- No ⇒ Go to ②

- ② Is the network you want to connect to an existing one?

- Yes ⇒ Go to ③
- No ⇒ Go to ⑥

- ③ Are you using a DHCP server?

- Yes ⇒ Go to ④
- No ⇒ Go to ⑤

④ When using a DHCP server

[Use DHCP server]

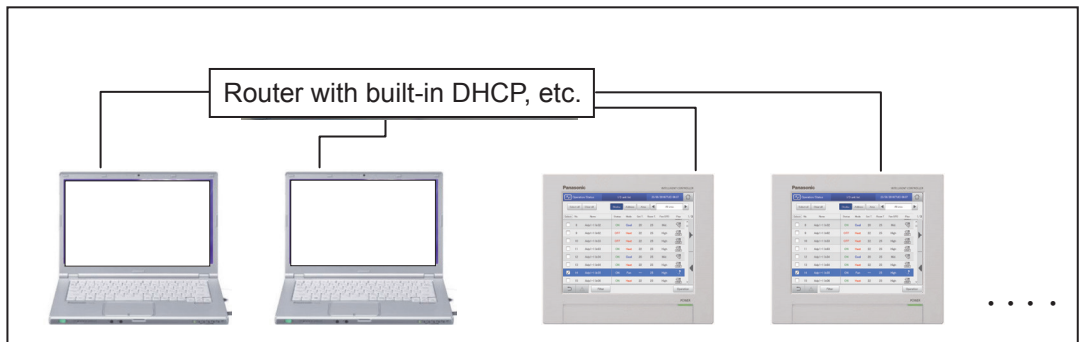

⇒ Go to ⑦

⑤ When using a fixed IP address

[Use fixed IP address]

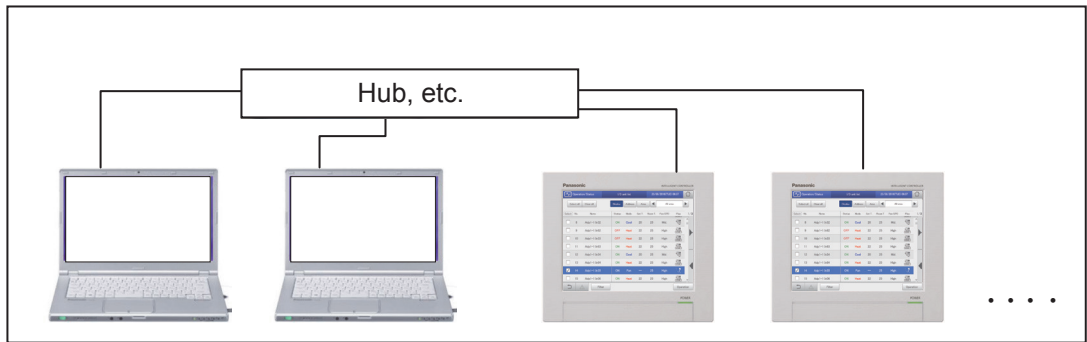

* Please input the IP address to be set for the Intelligent Controller.

IP address for Intelligent Controller

[. . .]

When there are multiple Intelligent Controllers to be connected

[. . .]

[. . .]

Net mask for Intelligent Controller

[. . .]

[. . .]

Default gateway

[. . .]

⇒ Go to ⑦

⑥ Is the construction of the network complete? (Client to carry out)

Yes ⇒ Go to ③

No ⇒ Have client build the network. When construction is completed, go to ③

⑦ Would you like to use the function to send an email when an alarm occurs?

- Yes ⇒ Go to ③
- No ⇒ Go to ⑧

⑧ Do you want the NTP server to automatically adjust the current time?

- Yes ⇒ Go to ⑨
- No ⇒ End of advance check sheet Thank you very much for your cooperation.

⑨ Please fill in the following details.

NTP server address

[. . .]

End of advance check sheet Thank you very much for your cooperation.

3. Confirm email sending function

The Intelligent Controller also has an email sending function when generating/cancelling an alarm, but in order to use this function, the following environment is required.

- Email transmission protocol: SMTP (Exchange Server not supported)
- If checked OK, go to ①.

① Have you signed the contract for the e-mail server connection?

- Yes ⇒ Please fill in the following details.

Outgoing server address for email (SMTP)

[. . .]

SenderAccount name

[]

Destination account name 1

[]

Destination account name 2

[]

Destination account name 3

[]

Destination account name 4

[]

Destination account name 5

[]

Destination account name 6

[]

Destination account name 7

[]

Destination account name 8

[]

END

Thank you very much.

[Explanation of terms]

◎ Intranet

An intra-company (in-house) network constructed using Internet standard technology including TCP/IP communication protocol.

◎ LAN

A LAN (Local Area Network) refers to a local area network, a network that connects computers and printers in the same building and exchanges data using twisted pair wires, coaxial cables, optical fibres, etc.

◎ Internet

The Internet refers to a network constructed by an interconnecting network based on Internet protocols among computer networks interconnected using Internet protocol technology.

◎ Google Chrome

One browser application

◎ WAN

WAN is an abbreviation of Wide Area Network. Often used as a term to compare with LAN. LAN is for users to build, manage and operate networks themselves.

◎ Communication protocol

A set of mutually determined conventions used when computers communicate with each other via a network.

Sometimes called a communication procedure, communication code or the like.

◎ DHCP

A protocol that automatically assigns necessary information such as the IP address to a computer temporarily connected to the Internet. In the DHCP server, the IP address of the gateway server and DNS server, net mask, IP address range which may be assigned to the client, and the like are set and this information is provided to computers that have accessed via a method such as dial-up. When the client finishes communicating, the address is automatically collected and assigned to another computer. With DHCP, even users who are not familiar with network settings can easily connect to the Internet, and network administrators can easily manage many clients in one centralised way.

◎ Hub

Hub (network device) - A device that relays when connecting multiple network devices with each other by a cable for Ethernet (10BASE-T, 100BASE-TX, etc.) USB, IEEE 1394 or the like.

◎ Router

A router (common pronunciation in U.S.: "rauter") is a communication device that relays and connects between different networks in computer networks. Became popular since TCP/IP started being used as a communication protocol.

◎ IP address

The IP address is a number for identifying a device that transmits and receives packets. It is defined by the IP. Originally used in the narrow sense of the Internet, it came to be used with LAN also with the spread of the Internet.

Ⓒ Net mask

A net mask is a numerical value for identifying network addresses and a host addresses among IP addresses.

Ⓒ SMTP (Simple Mail Transfer Protocol)

Protocol for sending emails. Protocol specifications are defined in RFC821 and others.

Ⓒ Exchange Server

An email server released by Microsoft

Ⓒ Account

An account in computer terminology is a right for a user to log in to a specific area (network, computer, etc.). A user means a user of a computer system. The account assigned to the user is also called the user account. For example, there are accounts for logging in to the network and accounts for sending and receiving emails. A password is always associated with the account (ID), and the user can log in to a network or a computer they are permitted to log in to by inputting the password together with the account. Sometimes the right (ID) and password together are called accounts.

● Web setting of Intelligent Controller

[1] 1-to-1 connection

About connection

Connect the Intelligent Controller and the PC 1-to-1.



Required items: LAN cable (Local procurement)

About settings for the Intelligent Controller

Select [System Settings] under [Settings], and display [Network Settings].

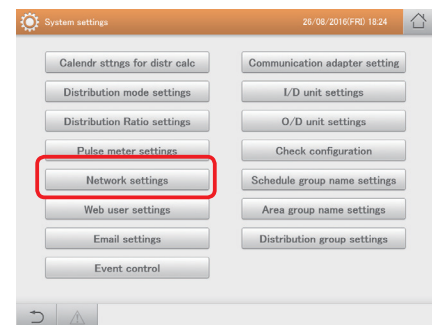
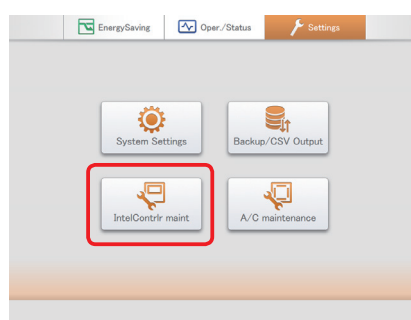
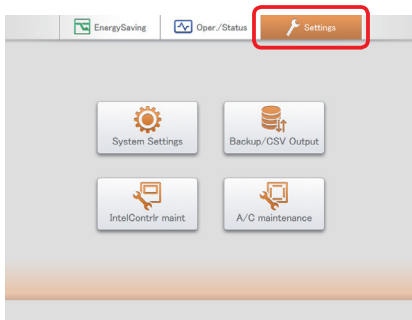

[Network settings] screen

The screenshot shows the 'Network settings' screen with the following configuration:

- DHCP On:** (unchecked)
- IP address:** 192.168.1 .2
- Net mask:** 255.255.255.0
- Default gateway:** (empty field)
- AutoDNS:** (unchecked)
- DNS primary server:** (empty field)
- DNS secondary server:** (empty field)
- NTP server:** (empty field)
- Buttons:** Update now, Cancel, Register

Numbered callouts:

- ① Points to the DHCP On checkbox.
- ② Points to the IP address input field.
- ③ Points to the Net mask input field.
- ④ Points to the Register button.

- ① DHCP is set to Off.
 of DHCP On is left blank (unchecked)
- ② Set the IP address for the Intelligent Controller.
 192. 168. 1. 2
- ③ Set the net mask for the Intelligent Controller.
 255. 255. 255. 0
- ④ After setting, select the [Register] button.

PC settings

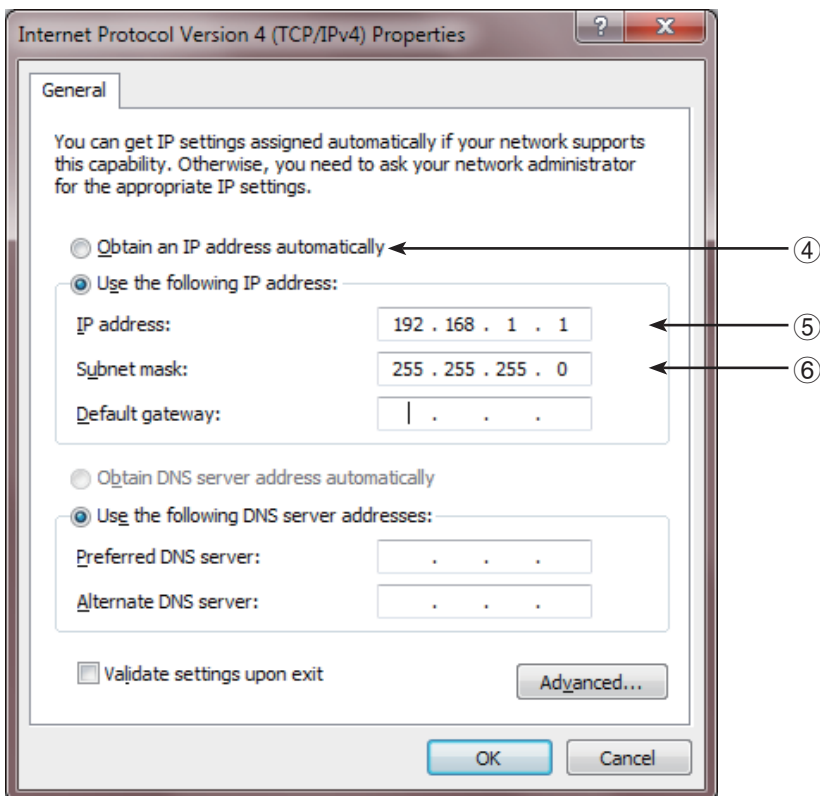

- ④ Do not automatically obtain IP address.
Uncheck the check box for “○ Obtain an IP address automatically”.
- ⑤ Set the IP address of the PC.
192. 168. 1. 1
- ⑥ Set the net mask of the PC.
255. 255. 255. 0

After setting up the network, confirm the network connection referring to “[4] Checking connection to the Web”.

[2] Connecting to an existing network using a fixed IP address (without using a DHCP server)

About connection

- Connect the Intelligent Controller to the existing network.

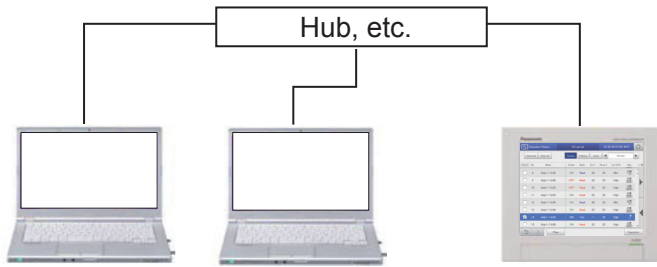

Required items: □ LAN cable (arrange locally)

Please obtain the following information from the client (network administrator, etc.).

- ① Does the client use a DHCP server for its network environment?
 - Yes ⇒ Go to [2] Connecting to an existing network (2)
 - No ⇒ Go to ②
- ② Obtain the IP address to be set for the Intelligent Controller.
IP address obtained for Intelligent Controller
- ③ Obtain the net mask value to be set for the Intelligent Controller.
Subnet mask obtained for Intelligent Controller

About settings for the Intelligent Controller

Select [System Settings] under [Settings], and display [Network Settings].

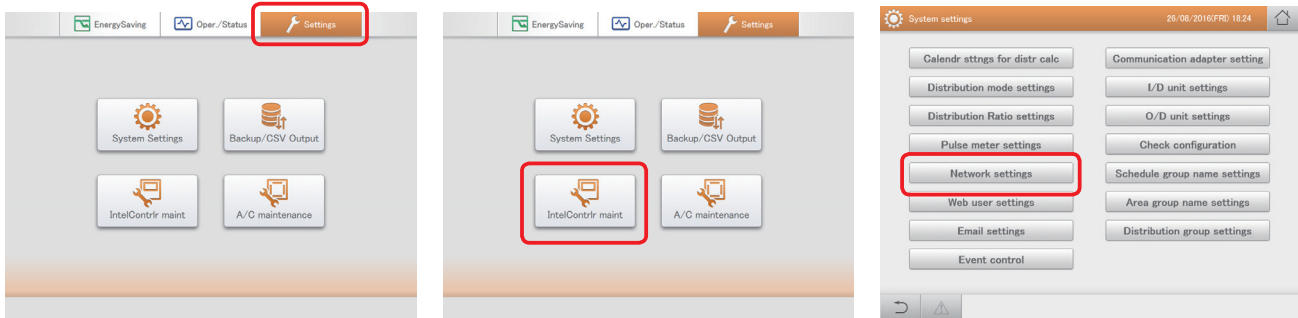

[Network settings] screen

System settings | Network settings | 26/08/2016(FRI) 11:39

DHCP On ①

IP address ②

Net mask ③

Default gateway

AutoDNS

DNS primary server

DNS secondary server

NTP server Update now

Cancel Register

- ① DHCP is set to Off.
 - of DHCP On is left blank (unchecked)
 - ② Set the following IP address for the Intelligent Controller.
 - IP address obtained for Intelligent Controller**
 - ③ Set the following net mask for the Intelligent Controller.
 - Subnet mask obtained for Intelligent Controller**
 - ④ After setting, select the [Register] button.
- Setting the PC is unnecessary.

After setting up the network, confirm the network connection referring to “[4] Checking connection to the Web”.

[3] Connecting to an existing network using a DHCP server (setting the IP address automatically)

About connection

Connect the Intelligent Controller to the existing network.

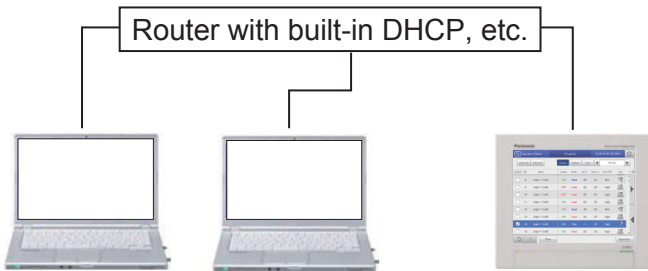

Required items: LAN cable (Field procurement)

About settings for the Intelligent Controller

Select [System Settings] under [Settings], and display [Network Settings].

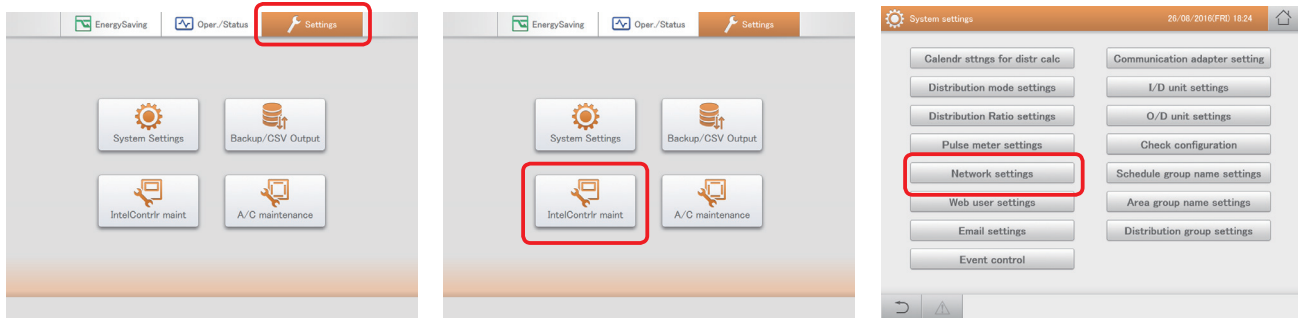

[Network settings] screen

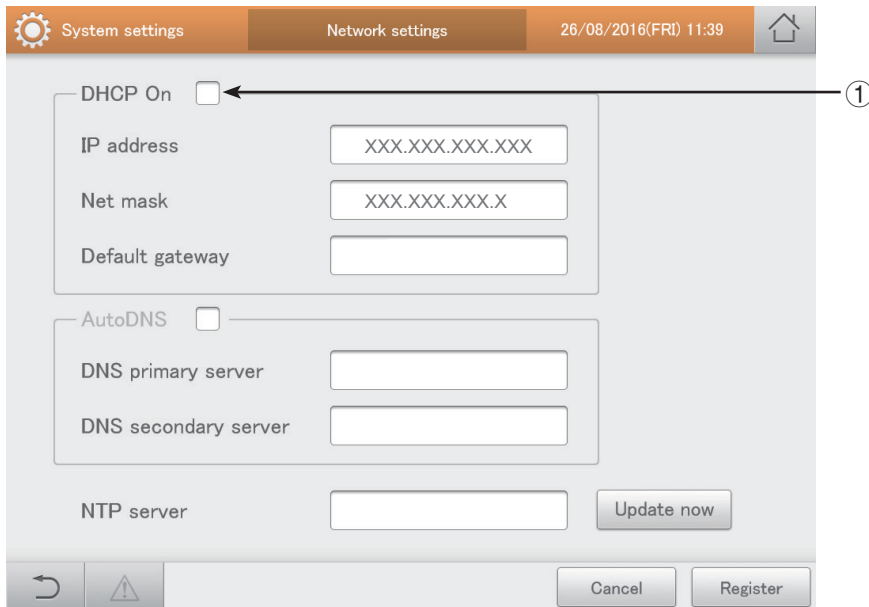

- ① Set DHCP to On.
Check the of DHCP On
- ② After setting, select the [Register] button.
Setting the PC is unnecessary.

After setting up the network, confirm the network connection referring to "[4] Checking connection to the Web".

[4] Checking connection to the Web

On your PC, start Internet Explorer 11 or later, or Google Chrome.

Input “https:// IP address obtained for Intelligent Controller /intelicon/index.php” in the address field.

- * The “IP address obtained for Intelligent Controller” in this address is the same as the “IP address” set for the Intelligent Controller.

If there is no problem, the following screen will be displayed.

- If connection is not successful

Check the setting with “[1] 1-to-1 connection”.

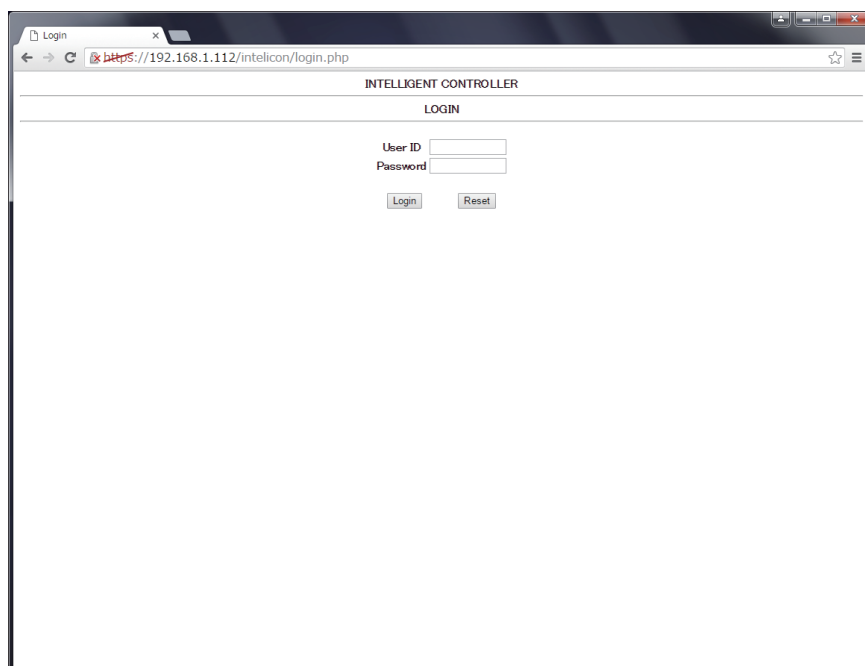

Since the network connection was confirmed by screen display, connection settings are completed.

● Configuring outgoing email

When an alarm occurs, this unit can automatically send alarm emails. Set the outgoing e-mail server and the email destination.

1. Touch [System Settings] in “Settings”.

● The [System settings] screen is displayed.

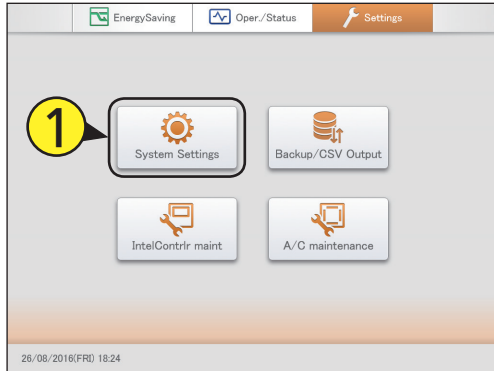

2. Touch [Email settings].

● The [Email settings] screen is displayed.

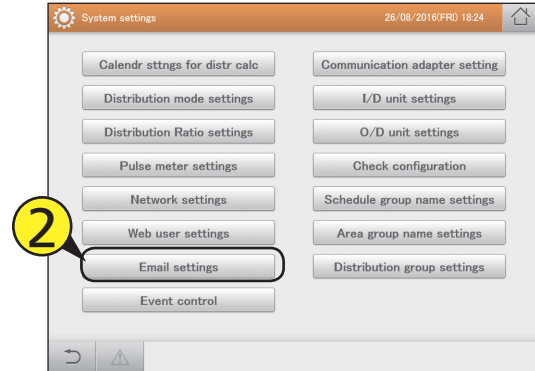

3. Change the settings.

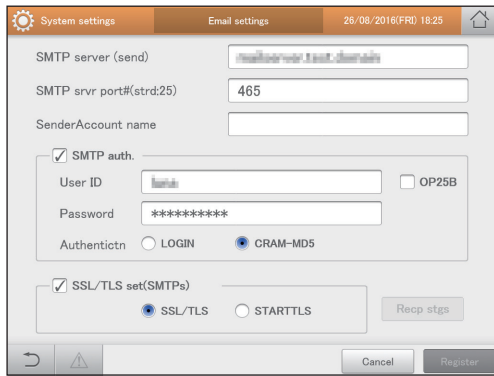

Item	Explanation	
SMTP server (send)	Set the IP address or host name of the SMTP server.	
SMTP srvr port#	Set the port number (1 to 65534) for the SMTP server. (Factory setting: 25)	
SenderAccount name	Set the email address to be put in the sender section of the outgoing email.	
SMTP auth. ^{*1}	User ID	Set the user ID to use for SMTP authentication.
	OP25B	The SMTP server port setting is automatically set to “587” if you put a check mark here.
	Password	Set the password to use for SMTP authentication.
	Authenticn	Select either [LOGIN] or [CRAM-MD5] as the authentication method.
SSL/TLS set(SMTPs) ^{*2}	Select either [SSL/TLS] or [STARTTLS] as the encryption method.	
Recp stgs	The [Email Alarm recipient settings] dialogue is displayed when you touch this. (→ “Setting the destination” (P.169))	

*1 The settings at the left are enabled if you put a check mark here.

*2 The SMTP server port number is automatically set to “465” if you put a check mark here.

Note

- The SMTP server port number automatically changes if [OP25B] and [SSL/TLS set (SMTPs)] are set. The priority of setting is [OP25B]>[SSL/TLS set (SMTPs)].
- The SMTP server port number cannot be changed if you make the above settings. When the settings are cancelled, the SMTP server port number returns to the factory number (25), and you can enter any value again.

4.Touch [Register].

- Set the recipient

Set the destination in the “Email Alarm recipient settings” dialogue.

1. Change the settings.

No.	Mail address	Valid	Adaptor CommuErr	I/D unit Disc.
1	user01@ipema.com	<input checked="" type="checkbox"/>	<input checked="" type="checkbox"/>	<input checked="" type="checkbox"/>
2	user02@ipema.com	<input checked="" type="checkbox"/>	<input checked="" type="checkbox"/>	<input checked="" type="checkbox"/>
3	user03@ipema.com	<input checked="" type="checkbox"/>	<input checked="" type="checkbox"/>	<input type="checkbox"/>
4	user04@ipema.com	<input checked="" type="checkbox"/>	<input checked="" type="checkbox"/>	<input checked="" type="checkbox"/>
5	user05@ipema.com	<input checked="" type="checkbox"/>	<input type="checkbox"/>	<input checked="" type="checkbox"/>
6		<input type="checkbox"/>	<input type="checkbox"/>	<input type="checkbox"/>
7		<input type="checkbox"/>	<input type="checkbox"/>	<input type="checkbox"/>
8		<input type="checkbox"/>	<input type="checkbox"/>	<input type="checkbox"/>

Buttons: Cancel, Send test mail, Register

Item	Explanation
Mail address	Set the email address to send alarms emails. The touchscreen keyboard appears when you touch this and you can change the email address.
Valid	Users with a check mark in this column will be sent alarm emails.
Adaptor CommuErr	Users with a check mark in this column will be sent alarm emails when there is a communications error with the communication adaptor.
I/D unit Disc.	Users with a check mark in this column will be sent alarm emails when an alarm is issued for a disconnected alarm.
Send test email	A test email is sent to the set e-mail address. However, a test email is not sent if the setting for [Valid], [Adaptor CommuErr], or [I/D unit Disc.] has been changed but the change has not been registered, or if there is not a valid email address.

2. Touch [Register].

- To cancel the settings, touch [Cancel].

Input of the admin number (password)

● About input of the admin number (password)

On screen menus marked ★☆, for security reasons, it is necessary to input the admin number for use.

1. Touch the screen menu to display the admin number entry screen.

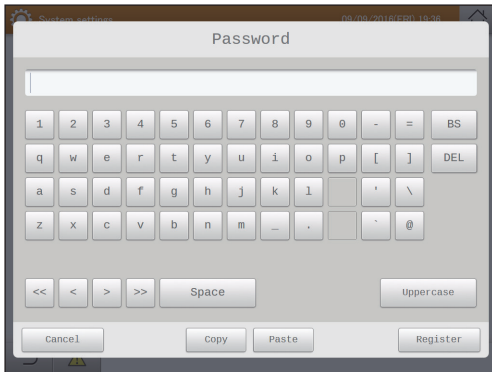

2. Input the admin number (password).

- Depending on the level of the admin number (password) that you own, you may not be able to enter the screen menu.

3. Initial passwords

- ★ : Level 1 is "int1".
- ☆ : Level 2 is "int2".



● Menu list showing the level of the admin number (password)

1. Select the top menu
 - Touch the “EnergySaving” “Oper./ Status” “Settings” tab.

2. Select the sub menu







EnergySaving (Settings related to energy saving)

Sub menu	Screen menu	Overview	Operating Instructions page
 Energy saving	★ Set temp. auto return	Even if the temperature initially set is changed, the temperature automatically returns to the set one after a certain amount of time.	77 (84)
	★ Unattended auto shutoff	If the indoor unit automatically stops at the set time but then is started again, this setting automatically stops the unit again repeatedly at set intervals.	80 (86)
	★ Set temperature range limit	Restrict the temperatures that can be set by setting upper and lower limits on temperatures.	83 (87)
	★ Energy saving timer/ Efficient operation setting	You can specify time slots when you want operation capacity reduced.	85 (88)
	★ Out unit silent setting	Set a time for the outdoor unit to operate at a lower noise level at night compared to the day.	87 (89)
 Demand setting	★ I/D unit demand settings	You can automatically control indoor units to cut the maximum demand for electricity or maximum gas consumption.	89 (90)
	★ O/D unit demand settings	You can automatically control outdoor units to cut the maximum demand for electricity or maximum gas consumption.	92 (92)
	★ Demand/peak shaving settings	Limit the electricity or gas consumed by outdoor units during the set time slot.	94 (93)
	★ O/D unit cyclic	At 10 minute intervals, the thermostats of outdoor units in control groups are turned off and restored repeatedly in order.	101 (96)
	★ I/D unit cyclic	At specified intervals (3, 4, or 5 minutes), the thermostats of indoor units in control groups are turned off and restored repeatedly in order.	97 (94)
	★ Register demand point	Register contact points (A contact, B contact, C contact) between the demand controller and the main unit.	104 (98)
 Energy saving mgmt	Bar chart	Quantities of energy usage (electricity, gas), etc. are shown in bar charts.	109 (100)
	Line graph	Temperature changes, etc. are shown in line graphs.	113 (102)

* When using gas heat pump air conditioners

* The numbers in parentheses indicate page number of this Technical Data.

Settings (Other miscellaneous settings)

Sub menu	Screen menu	Overview	Operating Instructions page
 System Settings	★ Calendr sttgs for distr calc	Set specified days, cutoff days, and target time slots (regular hour ranges) of each day of the week for distribution calculation.	148 (120)
	☆ I/D unit settings	Set I/D unit address, affiliated group, and so on.	141 (116)
	☆ O/D unit settings	Set O/D unit (address, etc.).	145 (118)
	★ Schedule group name settings	Edit the name of the schedule group.	151 (121)
	★ Area group name settings	Edit the name of the area group.	153 (124)
	★ Distribution group settings	Edit the name of the distribution group.	155 (123)
	☆ Pulse meter settings	Make allocations between pulse meters and distribution groups.	158 (125)
	★ Distribution mode settings	Set the mode used for distributing when calculating Distribution Ratio.	160 (126)
	★ Distribution Ratio settings	Set the electricity cost and gas price rates.	161 (126)
	★ Event control	Perform linked control by setting input and output conditions for devices.	162 (127)
	☆ Network settings	Make settings to enable remote controller over a network.	123 (107)
	☆ Email settings	Configure the outgoing email server.	168 (130)
	☆ User settings	Register users that can access the unit over a network.	125 (108)
	☆ Communication adaptor setting	Register the communication adaptor connected to this unit.	170 (131)
☆ Check configuration*	Modify the registered configuration when there have been changes to the configuration of the system.	200 (146)	
 Backup/CSV Output	★ Backup	Save data (settings, accumulation/distribution, logs) to USB memory devices.	130 (111)
	★ Restore	Restore data that has been backed up in the unit or to a USB memory device.	132 (112)
	★ CSV Output	Export (output) the settings for this unit in CSV format.	134 (113)
	★ CSV Input	Import (input) the settings for this unit in CSV format.	136 (114)
	★ Auto-save CSV file	Saves the CSV files (distributions, logs) automatically generated in this unit.	138 (115)
 IntelContrlr maint	★ Display/Volume settings*	Adjust the brightness of the unit's screen and the sound of the buzzer.	173 (132)
	★ Show service contact info.	Register the contacts for servicing (telephone numbers) for this unit.	174 (133)
	★ Software update*	Update the software for this unit.	175 (133)
	☆ Initialize*	Initialise the settings for this unit.  All data will be lost when you initialise. Do not initialise under any circumstances.	176 (134)
	★ Date setting	Manually set the date and time.	178 (135)
	Open source license	The licences for the free software is displayed.	—
 A/C maintenance	☆ Test run	Perform a test operation of the indoor unit after installing this unit.	181 (136)
	☆ A/C communication settings	Make settings such as the communications protocol between this unit and the air conditioning units.	184 (138)
	★ Maintenance information	Register the units that will require maintenance.	186 (139)

Screen menus marked with ★☆ require you to enter the admin number (password) when you select them.

* These settings are not available for setting or operation over the network.

* The numbers in parentheses indicate page number of this Technical Data.